

HARCO DUCTILE IRON IPS GASKETED FITTINGS

DESIGN DATA

Applicable Standards:

Ductile Iron: ASTM A536, Grade 65 - 45 - 12, 80 - 55 - 06
 Joints: ASTM D-3139; AWWA C153
 Gaskets: ASTM F477; SBR Std, EPDM & Nitrile avail
 Pressure Rating: 350psi per AWWA C153
 Coatings: Bituminous, AWWA C153, Standard
 Cement Lining, AWWA C153
 Coal Tar Epoxy, AWWA C210
 Fusion Bond Epoxy, AWWA C116
 Protecto 401

BELL SPECIFICATIONS

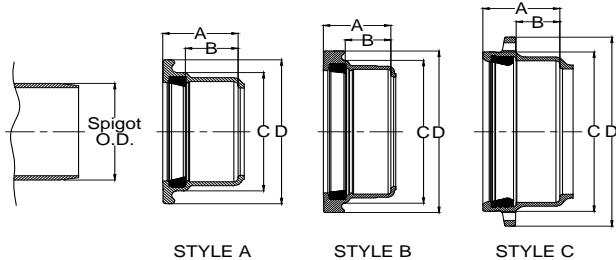

SIZE	A	B	C	D	Spigot O.D.	STYLE
1½	2.6	1.7	2.9	4.6	1.9	A
2	2.8	1.7	3.4	5.2	2.4	A
2½	2.8	1.7	4.0	5.7	2.9	A
3	3.0	1.7	4.8	6.5	3.5	A
4	3.9	2.8	5.8	7.5	4.5	A
5	4.2	3.0	6.8	8.6	5.6	A
6	4.4	3.1	8.1	9.9	6.6	A
8	5.0	3.5	10.3	12.0	8.6	A
10	5.8	4.1	12.7	14.8	10.8	B
12	6.1	4.1	14.9	17.0	12.8	B
14	7.3	4.1	17.6	20.9	15.3	C
16	7.8	4.6	19.7	23.3	17.4	C

REPAIR COUPLING (Knock-On)

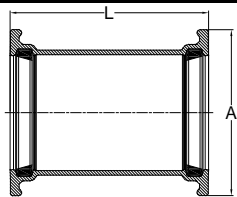

SIZE	PART #	A	L	WT (approx)
1½	80040	4.6	8.0	5.0
2	80140	5.2	8.0	5.2
2½	80240	5.7	8.5	6.3
3	80340	6.5	9.0	8.8
4	80440	7.5	9.0	11.3
5	80540	8.6	11.0	16.3
6	80640	9.8	12.0	22.0

REPAIR COUPLING (Knock-On) (continued)

SIZE	PART #	A	L	WT (approx)
8	80840	12.0	13.0	32.4
10	81040	14.8	15.0	56.7
12	81240	17.0	15.0	70.9
14	81440MJ	20.9	15.0	110
16	81640MJ	23.3	15.0	123
18	81840MJ			

TEE (G x G x G)

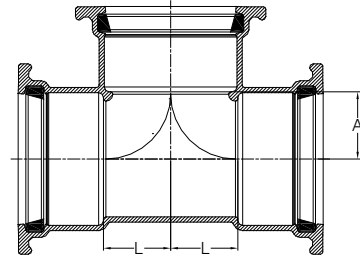

SIZE	PART #	A	L	WT (approx)
1½ x 1½ x 1½	8000000	1.1	1.1	6.4
2 x 2 x 2	8010101	1.4	1.4	8.4
2 x 2 x 2½	8010102	1.4	1.6	8.9
2 x 2 x 3	8010103	1.5	1.8	10.2
2½ x 2½ x 2	8020201	1.6	1.4	9.1
2½ x 2½ x 2½	8020202	1.6	1.6	10.0
2½ x 2½ x 3	8020203	1.6	2.1	11.6
3 x 2½ x 2½	8030202	1.6	2.0	11.1
3 x 3 x 2	8030301	2.0	1.4	11.7
3 x 3 x 2½	8030302	2.0	1.6	12.2
3 x 3 x 3	8030303	2.0	2.0	13.8
4 x 4 x 2	8040401	2.5	1.4	16.3
4 x 4 x 2½	8040402	2.5	1.6	16.7
4 x 4 x 3	8040403	2.5	2.0	18.4
4 x 4 x 4	8040404	2.5	2.5	21.5
6 x 6 x 2	8060601	3.5	1.3	24.6
6 x 6 x 2½	8060602	3.5	1.6	25.5
6 x 6 x 3	8060603	3.5	2.0	27.6
6 x 6 x 4	8060604	3.5	2.5	30.8
6 x 6 x 6	8060606	3.5	3.5	37.2
8 x 8 x 3	8080803	4.6	2.0	39.1
8 x 8 x 4	8080804	4.6	2.5	43.7
8 x 8 x 6	8080806	4.5	3.5	49.8
8 x 8 x 8	8080808	4.5	4.5	59.3
10 x 10 x 4	8101004	5.7	2.5	67.6
10 x 10 x 6	8101006	5.6	3.5	76.4
10 x 10 x 8	8101008	5.6	4.6	86.4
10 x 10 x 10	8101010	5.6	5.6	105.4
12 x 12 x 6	8121206	6.7	3.5	96.0
12 x 12 x 8	8121208	6.7	4.6	107.4
12 x 12 x 12	8121212	6.7	6.7	141.3
14 x 14 x 14	8141414	7.8	7.8	286.4
16 x 16 x 16	8161616	9.1	9.1	335.3
18 x 18 x 18	8181818MJ	from	SIGMA	435.0

Notes:

- All lay lengths & weights are approximate and subject to change without notice
- Fabricated fitting configurations may vary

Bell & Spigot Specification Note:

- 1½" - 12": Bells and Spigots are IPS size
- 14" - 18": Bells and Spigots are Ductile Iron Pipe Size (DIPS) for AWWA C905 PVC Pipe or Ductile Iron Pipe

Call For Other Sizes, Configurations & Gasket Materials



THE HARRINGTON CORPORATION

P.O. BOX 10335 • LYNCHBURG, VIRGINIA 24506 • 3721 COHEN PLACE • LYNCHBURG, VIRGINIA 24501
 PHONE: (434) 845-7094 • FAX: (434) 845-8562 • E-MAIL: sales@harcofittings.com • WEB: www.harcofittings.com
 D120180411

HARCO DUCTILE IRON IPS GASKETED FITTINGS

DESIGN DATA

REDUCER – S.E.B. (Small End Bell)

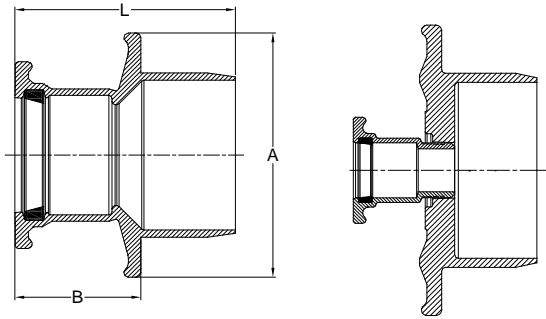

SIZE	PART #	A	B	L	WT (approx)
2½ x 2	80230	5.7	3.1	5.6	4.4
3 x 2	80332	6.5	3.4	6.2	5.3
3 x 2½	80330	6.5	3.4	6.2	5.5
4 x 2	80434	7.5	3.8	6.9	6.8
4 x 2½	80432	7.5	3.6	6.7	6.9
4 x 3	80430	7.5	3.6	6.7	7.7
6 x 3	80634	9.9	4.7	8.5	12.0
6 x 4	80632	9.9	5.1	8.9	13.8
6 x 5	80628	9.9	4.8	8.6	14.0
8 x 4	80834	12.1	6.1	10.3	18.9
8 x 6	80832	12.0	5.8	9.9	22.2
10 x 6	81032	14.8	7.5	12.4	39.3
10 x 8	81030	14.8	7.1	12.0	40.2
12 x 6	81234	17.0	8.5	13.7	49.2
12 x 8	81232	17.0	8.1	13.3	52.0
12 x 10	81230	17.0	8.3	13.5	61.0
14 x 6	81434	20.9	3.6	7.4	80.7
14 x 10	81432	20.9	9.1	14.3	87.3
14 x 12	81430	20.9	8.4	13.7	89.2
16 x 6	81635	23.3	3.6	7.4	96.0
16 x 10	81633	23.3	10.4	17.6	119.2
16 x 12	81632	23.3	9.7	16.9	120.7
16 x 14	81630	23.3	9.9	15.1	141.2
18 x 12	81834MJ				130
18 x 14	81832MJ				175
18 x 16	81830MJ				170

REDUCER (Bell x Bell)

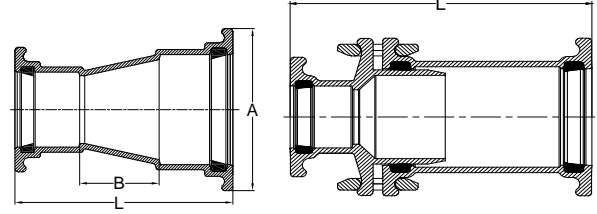

SIZE	PART #	A	B	L	STYLE	WT (approx)
2 x 1½	80130BB	-	-	12.6	B	14.0
2½ x 1½	80232BB	-	-	13.1	B	15.8
3 x 2	80332	-	-	12.9	B	17.1
3 x 2½	80330	-	-	12.9	B	17.3
4 x 2	80434	-	-	13.2	B	20.3
4 x 2½	80432	-	-	13.1	B	20.4
4 x 3	80430	-	-	13.1	B	21.2
6 x 2	80638BB	-	-	16.2	B	42.4
6 x 2½	80636BB	-	-	16.8	B	43.5
6 x 3	80634BB	-	-	17.2	B	37.0
6 x 4	80630	9.9	5.0	13.4	A	40
8 x 2½	80838BB	-	-	17.7	B	59.9
8 x 3	80836BB	-	-	17.9	B	61.1
8 x 4	80834	-	-	19.6	B	54.3
8 x 6	80830	12.1	7.0	16.9	A	58.0
10 x 6	81032	-	-	23.1	B	103.2
10 x 8	81030	-	-	22.3	B	104.1
12 x 6	81234	-	-	24.1	B	127.3
12 x 8	81232	-	-	23.7	B	130.7
12 x 10	81230	-	-	23.8	B	139.1
14 x 12	81430BB	-	-	23.9	B	250.0
16 x 12	81632BB	-	-	25.5	B	314.0
16 x 14	81630BB	25.3	1.97	17.0	A	137.0
18 x 14	81832BB					217
18 x 16	81830BB					202

REDUCER – L.E.B. (Large End Bell)

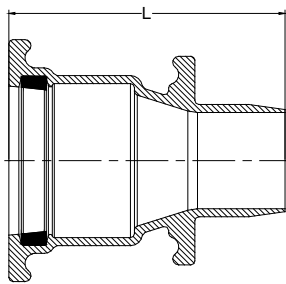

SIZE	PART #	L	WT (approx)
3 x 4	80431	8.6	10.1

Notes:

- All lay lengths & weights are approximate and subject to change without notice
- Fabricated fitting configurations may vary

Bell & Spigot Specification Note:

- 1½" – 12": Bells and Spigots are IPS size
- 14" – 18": **Bells and Spigots are Ductile Iron Pipe Size (DIPS) for AWWA C905 PVC Pipe or Ductile Iron Pipe**

Call For Other Sizes, Configurations & Gasket Materials



THE HARRINGTON CORPORATION

P.O. BOX 10335 • LYNCHBURG, VIRGINIA 24506 • 3721 COHEN PLACE • LYNCHBURG, VIRGINIA 24501
 PHONE: (434) 845-7094 • FAX: (434) 845-8562 • E-MAIL: sales@harcofittings.com • WEB: www.harcofittings.com

HARCO DUCTILE IRON IPS GASKETED FITTINGS

DESIGN DATA

CROSSOVER RING

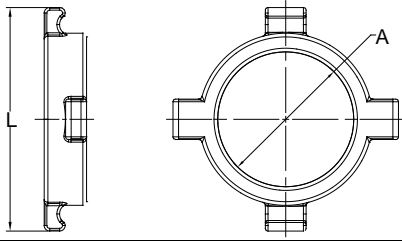

SIZE	PART #	A	L	WT (approx)
3	82103	3.6	6.6	3.1
4	82104	4.6	7.7	4.6
6	82106	6.7	10.0	7.5

CROSS (G x G x G x G)

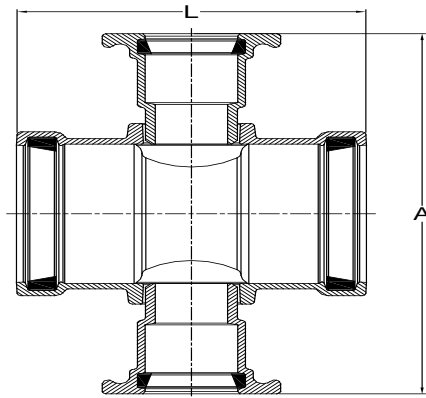

SIZE	PART #	A	L	WT (approx)
2½ x 2½ x 1½ x 1½	802150303	14.2	6.5	16
2½ x 2½ x 2 x 2	802150404	13.3	6.5	17
3 x 3 x 2 x 2	803150404	12.6	8.5	21
3 x 3 x 2½ x 2½	803150505	14.6	9.0	24
4 x 4 x 2 x 2	804150404	14.3	10.9	21.7
4 x 4 x 2½ x 2½	804150505	15.7	10.9	22.4
4 x 4 x 3 x 3	804150606	16.2	10.9	22.3
6 x 6 x 2 x 2	806150404	15.7	10.2	40
6 x 6 x 2½ x 2½	806150505	17.7	10.2	41
6 x 6 x 3 x 3	806150606	18.3	11.8	44
8 x 8 x 2 x 2	808150404	18.7	12.0	51
8 x 8 x 2½ x 2½	808150505	19.8	12.0	54
8 x 8 x 3 x 3	808150606	20.4	12.0	57
10 x 10 x 2 x 2	810150404	20.8	12.6	71
10 x 10 x 2½ x 2½	810150505	21.9	12.6	73
10 x 10 x 3 x 3	810150606	22.6	12.6	76
12 x 12 x 2 x 2	812150404	22.0	13.2	79
12 x 12 x 2½ x 2½	812150505	24.0	13.2	82
12 x 12 x 3 x 3	812150606	24.6	13.2	85

90° BEND (G x G) (¼ Bend)

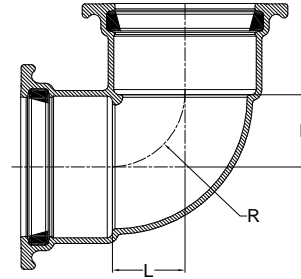

SIZE	PART #	L	R	WT (approx)
1½	80020	1.1	1.1	4.4
2	80120	1.4	1.4	5.9
2½	80220	1.6	1.6	7.1
3	80320	2.0	2.0	10.2
4	80420	2.5	2.5	15.1
6	80620	3.5	3.5	26.7
8	80820	v4.5	4.5	42.0
10	81020	5.6	5.6	67.0
12	81220	6.7	6.7	99.0
14	81420	7.8	7.8	164.7
16	81620	9.0	9.0	203.2
18	81820			482.0

45° BEND (G x G) (⅛ Bend)

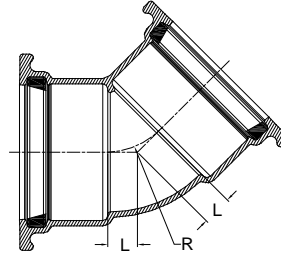

SIZE	PART #	L	R	WT (approx)
1½	80022	1.9	1.9	7.5
2	80122	0.6	1.5	5.4
2½	80222	0.7	1.7	6.6
3	80322	0.9	2.2	8.6
4	80422	1.1	2.7	13.3
6	80622	1.5	3.6	22.6
8	80822	1.9	4.7	35.1
10	81022	2.2	5.4	55.4
12	81222	2.6	6.4	73.1
14	81422	3.3	8.1	161.4
16	81622	3.8	9.0	203.8
18	81822			209.0

Notes:

- All lay lengths & weights are approximate and subject to change without notice
- Fabricated fitting configurations may vary

Call For Other Sizes, Configurations & Gasket Materials

Bell & Spigot Specification Note:

- 1½" – 12": Bells and Spigots are IPS size
- 14" – 18": **Bells and Spigots are Ductile Iron Pipe Size (DIPS) for AWWA C905 PVC Pipe or Ductile Iron Pipe**



THE HARRINGTON CORPORATION

P.O. BOX 10335 • LYNCHBURG, VIRGINIA 24506 • 3721 COHEN PLACE • LYNCHBURG, VIRGINIA 24501
 PHONE: (434) 845-7094 • FAX: (434) 845-8562 • E-MAIL: sales@harcofittings.com • WEB: www.harcofittings.com

HARCO DUCTILE IRON IPS GASKETED FITTINGS

DESIGN DATA

22½° BEND (G x G) (1/16 Bend)

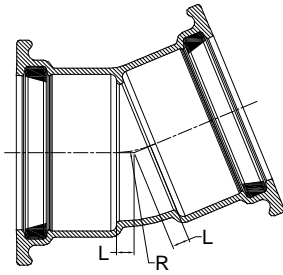

SIZE	PART #	L	R	WT (approx)
2½	80224	0.4	2.1	5.9
3	80324	0.5	2.5	8.2
4	80424	0.6	3.0	12.4
6	80624	0.8	3.9	20.7
8	80824	1.0	5.0	32.1
10	81024	1.1	5.4	49.9
12	81224	1.4	7.2	73.8
14	81424	1.7	8.4	127.0
16	81624	1.9	9.5	151.2
18	81824			209.0

11¼° BEND (G x G) (1/32 Bend)

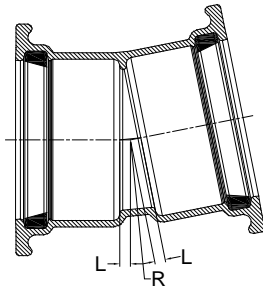

SIZE	PART #	L	R	WT (approx)
4	80426	0.4	3.6	11.2
6	80626	0.5	4.6	20.7
8	80826	0.6	5.7	33.5
10	81026	0.7	6.9	53.9
12	81226	0.8	8.0	70.1
14	81426	0.9	9.2	120.4
16	81626	1.0	10.4	142.9

TAPPED TEE (Service Tee)

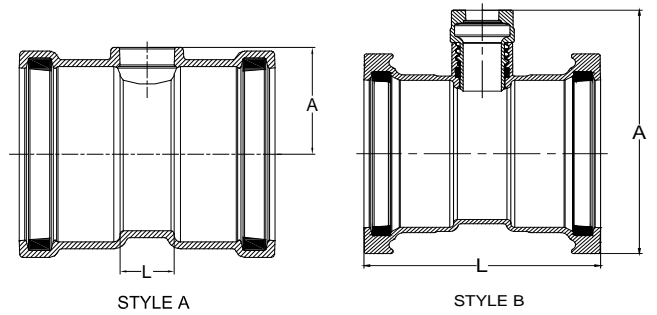

SIZE	PART #	A	L	STYLE	WT (approx)
1½ x 1	800502	4.9	4.5	A	8
2 x 1½	801503	4.9	12	A	6
2½ x 1½	802503	9.9	9.1	B	15.1
3 x 2½	803505	10.6	9.5	B	16.9
4 x 2½	804505	11.6	11.3	B	22.9
6 x 3	806506	4.5	3.2	A	16
8 x 3	808506	5.5	3.7	A	32
10 x 2½	810505	18.0	15.4	B	66
12 x 2½	812505	20.2	15.9	B	84
14 x 2½	814505	21.8	18.6	B	158
16 x 2½	816505	23.9	19.8	B	194

ACME SERVICE TEE

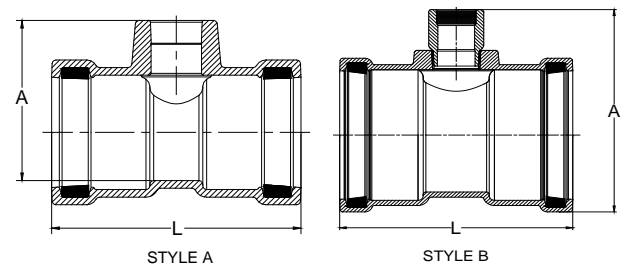

SIZE	PART #	A	L	STYLE	WT (approx)
2 x 1	8015302	4.4	6.4	A	5.7
2 x 1¼	80153025	4.4	6.4	A	5.3
2 x 1½	8015303	4.4	6.4	A	5.2
2½ x 1	8025302	4.9	6.4	A	5.5
2½ x 1¼	80253025	4.9	6.4	A	5.2
2½ x 1½	8025303	4.9	6.4	A	5.0
3 x 1	8035302	7.6	9.0	B	11
3 x 1¼	80353025	7.6	9.0	B	11
3 x 1½	8035303	7.6	9.0	B	11
4 x 1	8045302	8.6	8.8	B	14
4 x 1¼	80453025	8.6	8.8	B	14
4 x 1½	8045303	8.6	8.8	B	13
6 x 1	8065302	10.8	10.2	B	20
6 x 1¼	80653025	10.8	10.2	B	20
6 x 1½	8065303	10.8	10.2	B	19
8 x 1	8085302	12.9	12.0	B	34
8 x 1¼	80853025	12.9	12.0	B	34
8 x 1½	8085303	12.9	12.0	B	33

Notes:

- All lay lengths & weights are approximate and subject to change without notice
- Fabricated fitting configurations may vary

Bell & Spigot Specification Note:

- 1½" – 12": Bells and Spigots are IPS size
- 14" – 18": Bells and Spigots are Ductile Iron Pipe Size (DIPS) for AWWA C905 PVC Pipe or Ductile Iron Pipe

Call For Other Sizes, Configurations & Gasket Materials



THE HARRINGTON CORPORATION

P.O. BOX 10335 • LYNCHBURG, VIRGINIA 24506 • 3721 COHEN PLACE • LYNCHBURG, VIRGINIA 24501
 PHONE: (434) 845-7094 • FAX: (434) 845-8562 • E-MAIL: sales@harcofittings.com • WEB: www.harcofittings.com

D120180411

HARCO DUCTILE IRON IPS GASKETED FITTINGS

DESIGN DATA

SIDE OUTLET TAPPED CAP

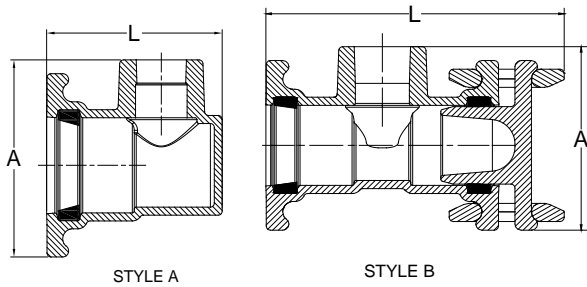

SIZE	PART #	A	L	STYLE	WT (approx)
2 x 1½	80168	5.6	9.1	B	10.4
2½ x 1½	80268	6.1	5.6	A	6.3

TAPPED PLUG (Female NPT)

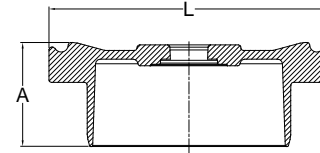

SIZE	PART #	A	L	MAX TAP	WT (approx)
2	80156xx	2.8	5.2	1 1/2	3.0
2½	80256xx	3.3	5.7	2	4
3	80356xx	3.8	6.6	2 1/2	5.1
4	80456xx	4.1	6.7	3	8.6
6	80656xx	4.0	9.9	3	15
8	80856xx	4.3	12.1	3	20.4
10	81056xx	5.5	14.8	3	31.1
12	81256xx	5.7	17.0	3	46.4

PLUG

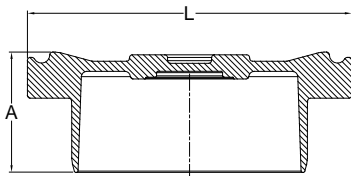

SIZE	PART #	A	L	WT (approx)
2	80155	2.8	5.2	3.0
2½	80255	3.0	5.6	4.0
3	80355	3.3	6.8	4.2
4	80455	4.1	7.6	8.8
6	80655	3.6	9.6	12.3
8	80855	4.0	12.0	20.9
10	81055	5.5	14.8	31.1
12	81255	5.7	17.0	45.4
16	81655	5.5	23.3	95.5

CAP

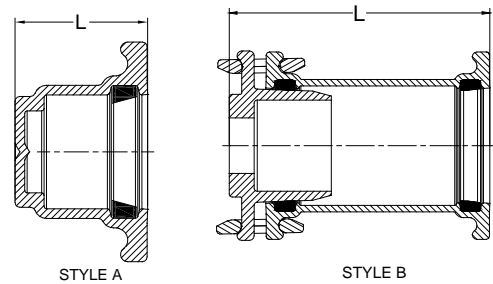

SIZE	PART #	L	STYLE	WT (approx)
1½	80066	4.9	A	4
2	80166	5.0	B	8
2½	80266	3.4	A	4
3	80366	4.4	B	17
4	80466	4.2	B	25
6	80666	4.7	B	40
8	80866	5.3	B	55
10	81066	6.0	B	97
12	81266	6.3	B	127
14	81466MJ		A	66
16	81666		A	92

TAPPED CAP

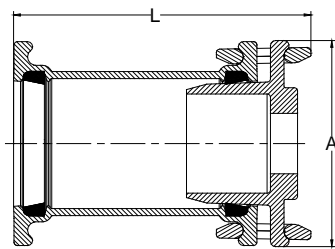

SIZE	PART #	A	L	WT (approx)
2	80167xx	5.2	5.0	3
2½	80267xx	5.7	3.5	4
3	80367xx	6.5	4.0	6
4	80467xx	7.6	4.2	8
6	80667xx	9.9	13.3	25
8	80867xx	12.1	15.0	56
10	81067xx	14.8	19.3	64
12	81267xx	17.0	19.3	78

Notes:

- All lay lengths & weights are approximate and subject to change without notice
- Fabricated fitting configurations may vary

Call For Other Sizes, Configurations & Gasket Materials

Bell & Spigot Specification Note:

- 1½" – 12": Bells and Spigots are IPS size
- 14" – 18": **Bells and Spigots are Ductile Iron Pipe Size (DIPS) for AWWA C905 PVC Pipe or Ductile Iron Pipe**



THE HARRINGTON CORPORATION

P.O. BOX 10335 • LYNCHBURG, VIRGINIA 24506 • 3721 COHEN PLACE • LYNCHBURG, VIRGINIA 24501
 PHONE: (434) 845-7094 • FAX: (434) 845-8562 • E-MAIL: sales@harcofittings.com • WEB: www.harcofittings.com

D120180411

HARCO DUCTILE IRON IPS GASKETED FITTINGS

DESIGN DATA

ADAPTER (MIPT x Female ACME)

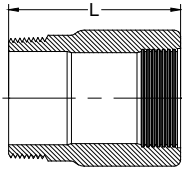

SIZE	PART #	L	WT (approx)
2 x 1	872-204	3	3
2 x 1½	872-205	3	3
2 x 1½	872-206	3	2

MALE ADAPTER (Bell x MNPT)

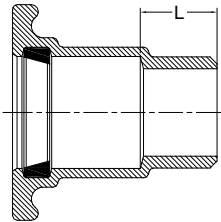

SIZE	PART #	L	WT (approx)
1½ x 1½	80070	1.6	2.8
2 x 1½	80172	1.6	3
2 x 2	80170	1.7	3.5
2½ x 2	80272	1.7	3
2½ x 2½	80270	2.0	4.8
3 x 3	80370	2.0	6.3
4 x 4	80470	1.7	7.5

FLANGE SPECS

SIZE	# HOLES	DIAMETER BOLTS	BOLT CIRCLE
3	4	5/8	6
4	8	5/8	7-1/2
6	8	3/4	9-1/2
8	8	3/4	11-3/4
10	12	7/8	14-1/4
12	12	7/8	17

SPIGOT x FLANGE ADAPTER

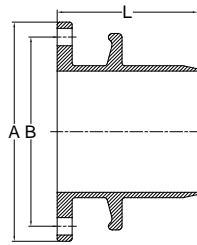

SIZE	PART #	A	B	L	WT (approx)
3	80360	7.5	6.0	5.4	10.9
4	80460	9.0	7.5	6.4	15.1
6	80660	11.0	9.5	7.1	21.8

SPIGOT x FLANGE ADAPTER (continued)

SIZE	PART #	A	B	L	WT (approx)
8	80860	13.5	11.8	7.5	30.9
10	81060	16.0	14.3	12.1	64.3
12	81260	19.0	17.0	12.4	87.1

FLANGE x BELL ADAPTER

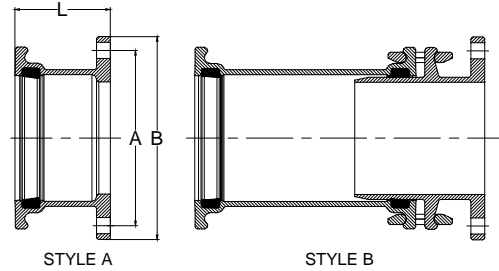

SIZE	PART #	A	B	L	STYLE	WT (approx)
3 x 3	80360FB	6.0	7.5	3.8	B	10.3
3 x 4	80360-04	6.0	7.5	7.9	B	15.2
4 x 4	80460FB	7.5	9.0	4.7	B	14.5
4 x 6	80460-06	7.5	9.0	8.9	B	23.8
6 x 6	80660FB	9.5	11.0	5.2	B	21.1
6 x 8	80660-08	9.5	11.0	10.0	B	33.4
8 x 8	80860FB	11.8	13.5	5.7	B	32.7
8 x 10	80860-10	11.8	13.5	10.8	B	57.5
10 x 10	81060FB	14.3	16.0	7.9	A	54.6
10 x 12	81060-12	14.3	16.0	11.7	B	76.0
12 x 12	81260FB	17.0	19.0	8.0	A	74.2
14 x 14	81460	18.8	21.0	10.6	A	139.7
16 x 16	81660	21.3	23.5	11.3	A	159.8
18 x 18	81860MJ					240

FLANGE x OUTLET TEE (B x B x Flange)

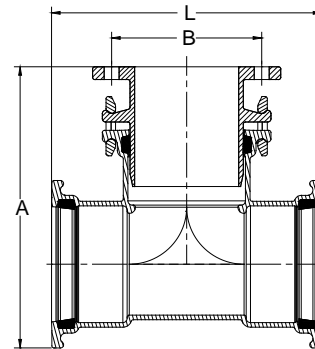

SIZE	PART #	A	B	L	WT (approx)
3 x 3	80300F	11.4	6.9	10.0	17.9
4 x 4	80400F	13.9	7.5	12.8	38.7
6 x 4	80601F	15.6	7.5	13.8	47.2
6 x 6	80600F	16.6	9.5	15.8	61.2
8 x 6	80801F	18.7	9.5	16.9	73.9
8 x 8	80800F	19.0	11.8	19.0	92.3
10 x 6	81002F	21.1	9.5	18.6	100.4
10 x 8	81001F	20.7	11.8	21.8	119.4

Notes:

- All lay lengths & weights are approximate and subject to change without notice
- Fabricated fitting configurations may vary

Call For Other Sizes, Configurations & Gasket Materials

Bell & Spigot Specification Note:

- 1½" – 12": Bells and Spigots are IPS size
- 14" – 18": **Bells and Spigots are Ductile Iron Pipe Size (DIPS) for AWWA C905 PVC Pipe or Ductile Iron Pipe**



THE HARRINGTON CORPORATION

P.O. BOX 10335 • LYNCHBURG, VIRGINIA 24506 • 3721 COHEN PLACE • LYNCHBURG, VIRGINIA 24501
 PHONE: (434) 845-7094 • FAX: (434) 845-8562 • E-MAIL: sales@harcofittings.com • WEB: www.harcofittings.com

D120180411

HARCO DUCTILE IRON IPS GASKETED FITTINGS

DESIGN DATA

FLANGE x OUTLET TEE (B x B x Flange) (continued)

SIZE	PART #	A	B	L	WT (approx)
10 x 10	81000F	26.6	14.3	22.9	176.9
12 x 6	81203F	23.3	9.5	19.2	120.0
12 x 8	81202F	23.8	11.8	21.3	140.5
12 x 12	81200F	29.1	17.0	25.5	235.0

NPT SADDLE

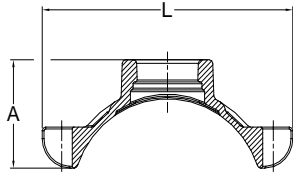

SIZE	PART #	A	L	WT (approx)
3	80380x	2.5	6.0	2.8
4	80480x	3.1	6.9	3.2
6	80680x	3.7	8.9	3.5
8	80880x	4.6	11.0	4.0
10	81080x	5.4	13.4	4.5
12	81280x	5.9	15.4	5.1

SWIVEL TEE

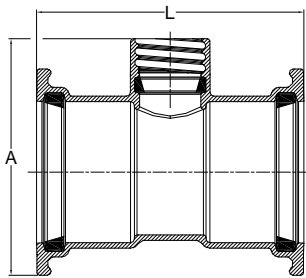

SIZE	PART #	A	L	WT (approx)
2	8015405	6.8	7.8	7.1
2½	8025405	7.5	9.1	9.8
3	8035405	8.2	9.5	11.6
4	8045405	9.2	11.3	15.9
6	8065405	11.3	12.9	25.5
8	8085405	13.3	13.4	34.8
10	8105405	15.6	15.4	59.6
12	8125405	17.7	15.9	75.2
14	8145405	19.4	18.6	153.1
16	8165405	21.5	19.8	188.6

SADDLE (Gasketed)

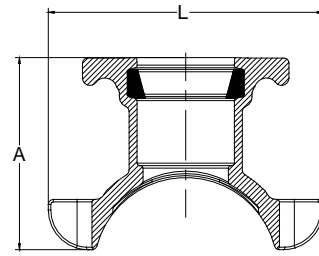

SIZE	PART #	A	L	WT (approx)
3 x 2	80382	4.4	6.0	4.0
4 x 2	80482	4.8	6.9	3.9
6 x 2	80682	5.4	8.9	4.3
8 x 2	80882	6.4	11.0	4.8
10 x 2	81082	7.1	13.4	5.5
12 x 2	81282	7.7	15.4	6.1

SWIVEL SADDLE

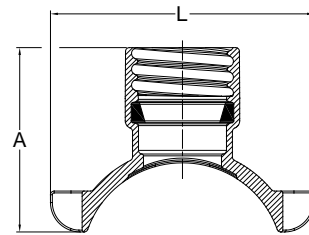

SIZE	PART #	A	L	WT (approx)
3	80381	5.3	6.0	4.3
4	80481	5.7	6.9	4.5
6	80681	6.3	8.9	4.9
8	80881	7.2	11.0	5.4
10	81081	8.0	13.4	6.1
12	81281	8.6	15.4	6.7

LATERAL 90° (MIPT x MSWL)

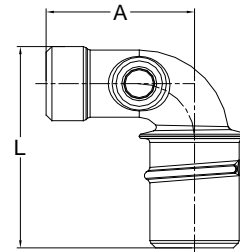

SIZE	PART #	A	L	WT (approx)
1½ x 6	80086	4.8	6.4	4.3
2 x 6	80186	4.8	6.6	4.8
2 x 12	8018612	4.8	12.6	6.8
2½ x 6	80286	4.8	7.0	5.2
3 x 7	80386	4.8	7.7	6.4

Notes:

- All lay lengths & weights are approximate and subject to change without notice
- Fabricated fitting configurations may vary

Call For Other Sizes, Configurations & Gasket Materials

Bell & Spigot Specification Note:

- 1½" – 12": Bells and Spigots are IPS size
- 14" – 18": **Bells and Spigots are Ductile Iron Pipe Size (DIPS) for AWWA C905 PVC Pipe or Ductile Iron Pipe**



THE HARRINGTON CORPORATION

P.O. BOX 10335 • LYNCHBURG, VIRGINIA 24506 • 3721 COHEN PLACE • LYNCHBURG, VIRGINIA 24501
 PHONE: (434) 845-7094 • FAX: (434) 845-8562 • E-MAIL: sales@harcofittings.com • WEB: www.harcofittings.com

D120180411

HARCO DUCTILE IRON IPS GASKETED FITTINGS

DESIGN DATA

LATERAL 90° (FIPT x MSWL)

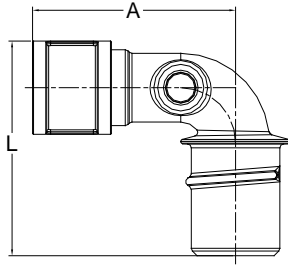

SIZE	PART #	A	L	WT (approx)
1½ x 6	80084	6.1	6.9	5
1½ x 12	8008412	6.0	15.9	11
2 x 6	80184	6.2	6.9	6
2 x 12	8018412	6.1	12.9	12
2½ x 6	80284	6.1	7.0	8
3 x 7	80384	6.9	7.7	9

LATERAL 90° (Spigot x MSWL)

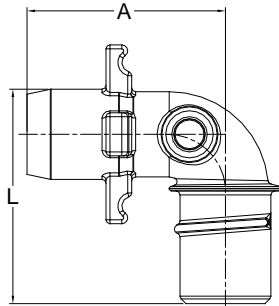

SIZE	PART #	A	L	WT (approx)
2 x 6	8018506	6.7	6.6	6.8
2 x 12	8018512	6.0	12.6	7.9
2½ x 6	8028506	6.3	6.9	7.2
3 x 7	8038507	6.6	7.7	8.6

LATERAL NIPPLE (MIPT x MSWL)

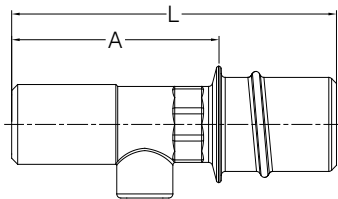

SIZE	PART #	A	L	WT (approx)
2 x 8	8720808	3.0	6.6	3.8
2 x 12	8721208	6.5	10.1	5.7
2 x 14	8721408	9.0	12.6	6.3
2 x 18	8721808	12.5	16.1	8.4
2½ x 8	8720810	3.6	7.2	4.5
3 x 10	8721012	4.3	8.0	5.5

LATERAL NIPPLE (Spigot x MSWL)

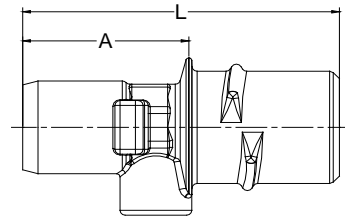

SIZE	PART #	A	L	WT (approx)
2 x 10	8731008	4.1	7.7	4.7
2 x 12	8731208	5.8	9.5	5.4
2 x 18	8731808	11.8	15.5	7.4

LATERAL 90° (MSWL x Bell)

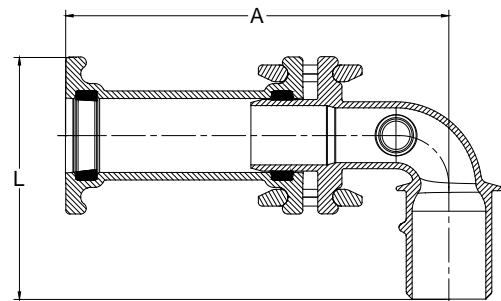

SIZE	PART #	A	L	WT (approx)
2 x 6	8018306	12.9	8.0	14.0
2½ x 6	8028306	12.8	8.3	16.5
3 x 7	8038307	13.3	9.2	20.4

ADAPTER (Female x SWL)

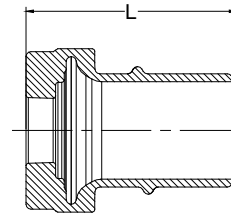

SIZE	PART #	L	WT (approx)
1½	875-025-00	6.0	6.0
2	875-025-00	6.0	5.7
2½	875-025-00	6.0	5.3
3	875-025-00	6.0	4.5

Notes:

- All lay lengths & weights are approximate and subject to change without notice
- Fabricated fitting configurations may vary

Call For Other Sizes, Configurations & Gasket Materials

Bell & Spigot Specification Note:

- 1½" – 12": Bells and Spigots are IPS size
- 14" – 18": **Bells and Spigots are Ductile Iron Pipe Size (DIPS) for AWWA C905 PVC Pipe or Ductile Iron Pipe**



THE HARRINGTON CORPORATION

P.O. BOX 10335 • LYNCHBURG, VIRGINIA 24506 • 3721 COHEN PLACE • LYNCHBURG, VIRGINIA 24501
 PHONE: (434) 845-7094 • FAX: (434) 845-8562 • E-MAIL: sales@harcofittings.com • WEB: www.harcofittings.com

DI20180411

HARCO DUCTILE IRON IPS GASKETED FITTINGS

DESIGN DATA

ADAPTER (FSWL x MIPT)

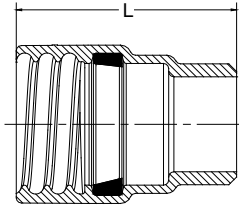

SIZE	PART #	L	WT (approx)
1½	873-006	5.0	2.3
2	873-008	5.3	3.7
2½	873-010	5.3	3.9

SWIVEL EXTENSION (MSWL x FSWL)

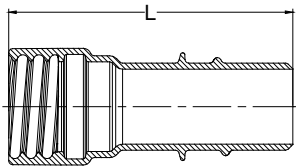

SIZE	PART #	L	WT (approx)
6	87106	9.5	5.6
12	87112	15.5	8.3
24	87124		22.0

LATERAL 90° (MIPT x MIPT)

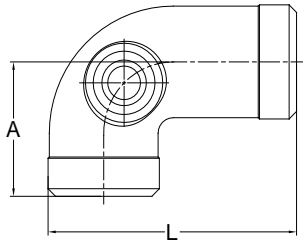

SIZE	PART #	A	L	WT (approx)
1½	80088	4.9	8.0	5.5
2	80188	4.7	8.0	6.8
2½	80288	4.5	8.0	7.6
3	80388	4.2	8.0	9.0

SPIGOT x THREAD ADAPTER

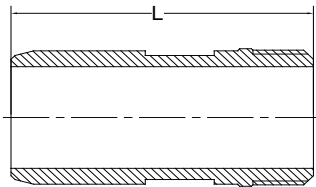

SIZE	PART #	L	WT (approx)
2 x 1½	874030806	6.6	3.0
2 x 2	874030808	6.1	3.0
2 x 2½	874030810	7.0	3.7

DI NIPPLE

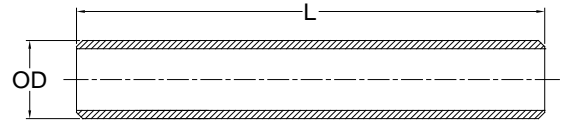

SIZE	PART #	OD	L	WT (approx)
1	87010	1.4	14.0	3
1¼	87012	1.8	14.0	4
1½	87015	2.0	14.0	6.4
2	87020	2.4	14.0	8.1
2½	87025	2.9	14.0	10.0
3	87030	3.6	14.0	12.5

KNUCKLE RESTRAINT

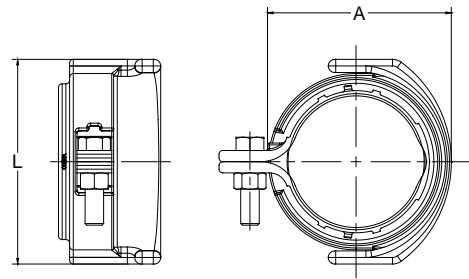

SIZE	PART #	A	L	WT (approx)
1½	60-100-01	3.3	4.0	1.5
2	60-100-02	3.8	4.5	1.8
2½	60-100-25	4.5	5.2	2.4
3	60-100-03	5.2	5.8	3.5
4	60-100-04	6.2	6.9	4.4
6	60-100-06	8.8	11.0	9.2
8	60-100-08	10.9	13.2	11.0

LATERAL 90° (FNPT x MNPT)

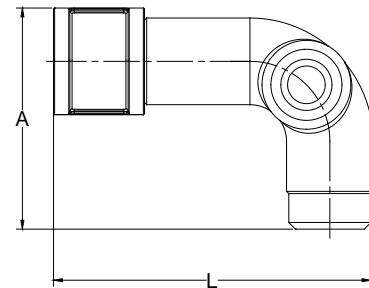

SIZE	PART #	A	L	WT (approx)
1½	80087	6.4	9.8	7
2	80187	6.2	9.8	9
2½	80287	6.0	9.8	11
3	80387	5.8	9.8	12

Notes:

- All lay lengths & weights are approximate and subject to change without notice
- Fabricated fitting configurations may vary

Call For Other Sizes, Configurations & Gasket Materials

Bell & Spigot Specification Note:

- 1½" – 12": Bells and Spigots are IPS size
- 14" – 18": **Bells and Spigots are Ductile Iron Pipe Size (DIPS) for AWWA C905 PVC Pipe or Ductile Iron Pipe**



THE HARRINGTON CORPORATION

P.O. BOX 10335 • LYNCHBURG, VIRGINIA 24506 • 3721 COHEN PLACE • LYNCHBURG, VIRGINIA 24501
 PHONE: (434) 845-7094 • FAX: (434) 845-8562 • E-MAIL: sales@harcofittings.com • WEB: www.harcofittings.com
 D120180411

HARCO DUCTILE IRON IPS GASKETED FITTINGS

DESIGN DATA

FITTING to PIPE RESTRAINT

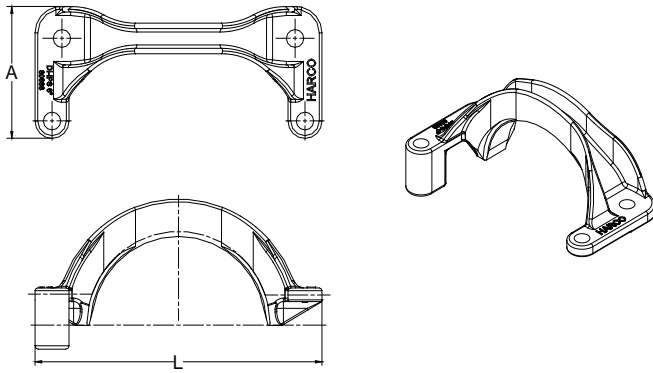

WT. (approx.) - A

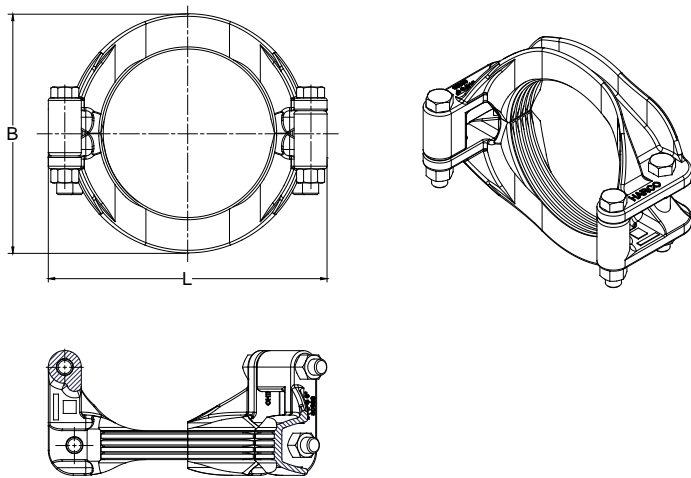

WT. (approx.) - B

SIZE	PART #	A	B	L	WT (approx) - A	WT (approx) - B
6	820610	4.8	9.3	10.8	5.5	12.8
8	820810	5.7	11.4	13.2	7.0	16.5
10	821010	7.3	13.9	16.1	13.4	31.0
12	821210	7.9	16.1	18.3	17.0	38.1

WYE

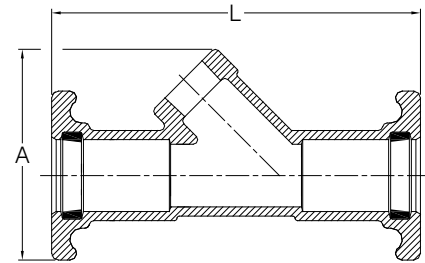

SIZE	PART #	A	L	Max Tap	WT (approx)
1½	80010	5.8	10.2	1 1/2	7
2	80110	6.5	10.7	2	8
3	80310	8.8	14.2	3	18

VALVE to FITTING RESTRAINT

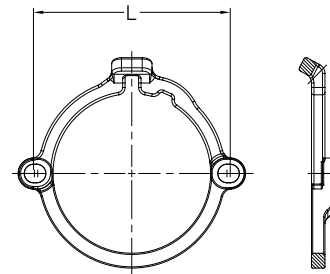

SIZE	PART #	L	WT (approx)
3	820320	6.4	2.8
4	820420	9.3	3.8
6	820620	11.6	4.8
8	820820	13.8	7.2

VALVE to PIPE RESTRAINT

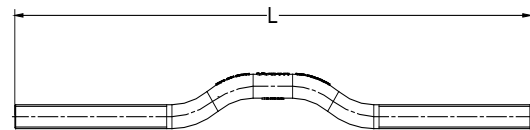

SIZE	PART #	L	WT (approx)
2	820125	17.3	1.4
2½	820225	17.3	1.4
3	820325	17.3	1.4
4	820425	19.7	2.4
6	820625	22.8	3.2
8	820825	25.5	4.3
10	821025	33.2	6.1
12	821225	33.2	6.1

Notes:

- All lay lengths & weights are approximate and subject to change without notice
- Fabricated fitting configurations may vary

Call For Other Sizes, Configurations & Gasket Materials

Bell & Spigot Specification Note:

- 1½" – 12": Bells and Spigots are IPS size
- 14" – 18": **Bells and Spigots are Ductile Iron Pipe Size (DIPS) for AWWA C905 PVC Pipe or Ductile Iron Pipe**



THE HARRINGTON CORPORATION

P.O. BOX 10335 • LYNCHBURG, VIRGINIA 24506 • 3721 COHEN PLACE • LYNCHBURG, VIRGINIA 24501
 PHONE: (434) 845-7094 • FAX: (434) 845-8562 • E-MAIL: sales@harcofittings.com • WEB: www.harcofittings.com
 D120180411

HARCO DUCTILE IRON IPS GASKETED FITTINGS

DESIGN DATA

PIPE to PIPE RESTRAINT

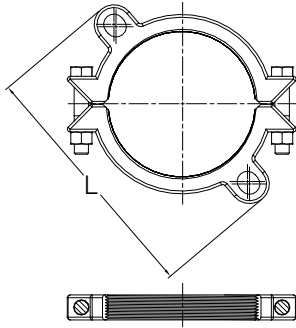

SIZE	PART #	L	WT (approx)
2	820115	6.3	2.5
2½	820215	6.8	2.7
3	820315	7.6	3.4
4	820415	9.4	4.6
6	820615	11.5	6.3
8	820815	13.4	8.9
10	821015	16.7	17.6
12	821215	19.3	20.6
14	821415	21.3	44.0
16	821615		

CONNECTING LINKS and EYE BOLTS

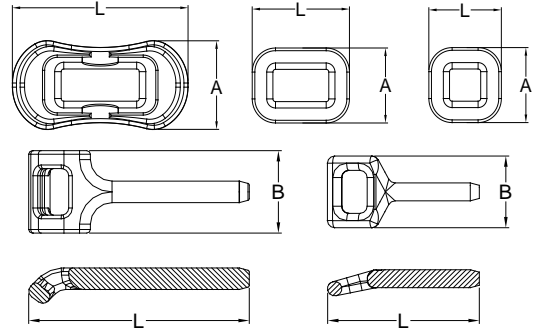

SIZE	PART #	A	B	L	WT (approx)
Small Link (1½ - 8)	82000	3.5	-	3.5	1.1
Transition Link (10-12)	82004	3.5	-	4.7	1.3
Heavy Duty Link (10-12)	82003	4.1	-	8.5	3.6
5/8 x 3 Bolt	82001	-	2.5	5.3	0.7
5/8 x 12 Bolt	82001-12	-	2.5	14.8	1.7
3/4 x 3 Bolt	82002-3	-	-	-	-
3/4 x 4 Bolt	82002	-	2.9	7.6	1.6

FITTING to VALVE to PIPE RESTRAINT

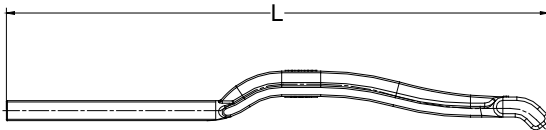

SIZE	PART #	L	WT (approx)
2	820121	14.8	1.7
2½	820221	14.8	1.7
3	820321	14.8	1.7
4	820421	17.8	2.8
6	820621	20.9	3.9
8	820821	22.7	5.2
10	821021	20.2	12.1
12	821221	24.4	16.6

Notes:

- All lay lengths & weights are approximate and subject to change without notice
- Fabricated fitting configurations may vary

Call For Other Sizes, Configurations & Gasket Materials

Bell & Spigot Specification Note:

- 1½" – 12": Bells and Spigots are IPS size
- 14" – 18": **Bells and Spigots are Ductile Iron Pipe Size (DIPS) for AWWA C905 PVC Pipe or Ductile Iron Pipe**



THE HARRINGTON CORPORATION

P.O. BOX 10335 • LYNCHBURG, VIRGINIA 24506 • 3721 COHEN PLACE • LYNCHBURG, VIRGINIA 24501
 PHONE: (434) 845-7094 • FAX: (434) 845-8562 • E-MAIL: sales@harcofittings.com • WEB: www.harcofittings.com