

# ADS

P R O D U C T  
C A T A L O G



**ADS**



THE MOST  
**ADVANCED**  
NAME IN  
DRAINAGE  
SYSTEMS®

# ore ord

This manual has been prepared to assist in identifying ADS products and product numbers. It is intended to be a fast and easy reference guide to our valued customers.

Information is provided on all products ADS manufactures or sells including:

- Single Wall Pipe
- N-12® Pipe
- StormTech® Chambers
- Series 35 Pipe
- ADS 3000 Triple Wall
- AdvanEDGE® Flat Pipe
- Water Quality Units
- Molded Fittings
- Fabricated Fittings
- Leaching Chambers
- Drain Basins
- Geosynthetics
- Grates
- Tapping Tees
- Horizontal Drain Boxes
- Miscellaneous Products



	<b>PAGE</b>
Foreword .....	I
Table of Contents .....	III – IV
ADS Package Quantities .....	V – VII
Truckload Package Quantities .....	VIII

**S**

**DRAINAGE PIPE**

Pictures—Maxi, Small Coils, Bundles, Pallets, Dual Wall / N-12, Single Wall Corrugated, Grain Aire Pipe, SB2 Pipe, Tripple Wall ...	2
Configurations of Perforations .....	3
Single Wall Pipe .....	3-5
N-12 Standard (4" - 60") .....	6-7
N-12 ST / IB .....	8
N-12 WT / IB .....	8
ADS 3000 Triple Wall Pipe .....	9
ADS 3000 Triple Wall Pipe Fittings .....	9

**S**

**Series 35 Pipe**

Series 35 Pipe .....	10
Lubricant .....	10

**S**

**AdvanEDGE Pipe & Fittings**

AdvanEDGE Pipe .....	11
AdvanEDGE Fittings .....	11
AdvanEDGE Tees .....	12
AdvanEDGE Wyes .....	13

**S**

**Drainage Quality Fittings for Single Wall & N-12 Pipe**

Split N-12 Couplers .....	14
Couplers .....	14
Tees Single Wall .....	15
End Caps Single Wall & N-12 .....	15

Fittings Single Wall .....	16
Adapters Single Wall .....	16
Septic Tees & Ells .....	17
Plastic End Sections .....	17
“ST” Injection Molded Fittings .....	17
“WT” Injection Molded Fittings .....	18
Reducing Fittings .....	19

**S**

**Sewer Quality Fittings/Nyloplast**

Couplings & Adapters .....	20
Nyloplast Fittings Clean Out Plugs .....	20
Tees .....	21
Wyes .....	21
Tee-Wyes .....	22
Increasesers .....	22
Elbows .....	22
End Caps .....	22
Sanded Manhole Adapters .....	22

**S**

**Fabricated Fittings/N-12 Pipe**

Bends .....	23
Specialty Fittings .....	24
Reducers .....	24
Wyes .....	25
Tees .....	26
Coupler .....	27
Adapters .....	27
Mitered End Section .....	27
End Caps .....	28
Manifolds .....	28-29
Catch Basin .....	29
Risers .....	29



**S**

**Bio-Diffuser (Leaching Chambers)**

Bio-Diffuser Truckload Quantities . . . . . 30  
 Leaching Chambers . . . . . 30  
 Multi-Pipe . . . . . 31

**S**

**Storm Drainage Structures/Nyloplast**

Road & Highway Structures . . . . . 32  
 Curb Inlet Structures . . . . . 32  
 Drain Basins . . . . . 32  
 Inline Drains . . . . . 33  
 Grate Options for Nyloplast . . . . . 33  
 Round Grates - Steel . . . . . 34  
 Round Grates - Cast Iron . . . . . 34  
 Drop-in Grates . . . . . 34

**S**

**Geosynthetics**

Standard Geotextiles . . . . . 35-36  
 Erosion Control Fabrics . . . . . 36  
 Grain-Aire Screen™ . . . . . 36  
 Sock / Drain Guard® . . . . . 36

**S**

**Tapping Tees**

Inserta Tees . . . . . 37  
 Uni-T . . . . . 37

**S**

**Miscellaneous Products**

Animal Guards . . . . . 38  
 Bar Guards . . . . . 38  
 End Section Trash Guards . . . . . 38  
 Flap Gates . . . . . 38  
 Lubricant . . . . . 38  
 PVC Diverter Valve . . . . . 38

Tape . . . . . 38  
 Hickenbottoms . . . . . 39  
 Field Repair Couplers . . . . . 39  
 Internal Joint Seals . . . . . 39  
 Duraslot Products . . . . . 40-41  
 Horizontal Drain Boxes . . . . . 41  
 Waterstop Gaskets . . . . . 41

**S**

**StormTech Stormwater Chambers**

StormTech Chambers & End Caps . . . . . 42  
 StormTech End Caps with Stubs . . . . . 43  
 StormTech Manifolds . . . . . 43-44  
 StormTech Reducing Manifolds . . . . . 44-46

**S**

**Water Quality Units**

Water Quality Units . . . . . 47

**S**

**Storm-Pure**

Complete Units . . . . . 48  
 Replacement Parts . . . . . 48



# ADS ac a e antities

S L	L	Product #	Size	Pkg.	Pieces
		0311AA	3"	bag	36
		0411AA	4"	bag	24
		0511AA	5"	bag	24
		0611AA	6"	bag	14
		0665AA	6"	bag	14
		0811AA	8"	bag	8
		1011AA	10"	bag	12
		1265AA	12"	skid	200
		1565AA	15"	skid	150
		1865AA	18"	skid	150
		2411AA	24"	skid	100
		2465AA	24"	skid	100
		3065AA	30"	skid	50
		3661AA	36"	skid	50
		4265AA	42"	skid	50
		4865AA	48"	skid	50
		6065AA	60"	skid	25

L S	Product #	Size	Pkg.	Pieces
	1266AA	12"	skid	200
	1566AA	15"	skid	150
	1866AA	18"	skid	150
	2412AA	24"	skid	100
	2466AA	24"	skid	100
	3066AA	30"	skid	50
	3662AA	36"	skid	50
	4266AA	42"	skid	50
	4866AA	48"	skid	50
	6066AA	60"	skid	25

\*XX69AA Series Fab use only

D L D	L S	Product #	Size	Pkg.	Pieces
		0669AA	6"	bag	6
		0869AA	8"	bag	4
		1069AA	10"	each	
		1269AA	12"	each	
		1569AA	15"	each	
		1869AA	18"	each	
		2469AA	24"	each	
		3069AA	30"	each	
		3669AA	36"	each	

\*XX69AA Series Fab use only

AL L S	Product #	Size	Pkg.	Pieces
	0312AA	3"	bag	24
	0412AA	4"	bag	24
	0512AA	5"	bag	24
	0612AA	6"	bag	8
	0812AA	8"	bag	6
	1012AA	10"	bag	3

LL LL L	Product #	Size	Pkg.	Pieces
	0613AA	6"	bag	8
	0813AA	8"	bag	4
	1013AA	10"	bag	3

LL LL	Product #	Size	Pkg.	Pieces
	1213AA	12"	skid	144
	1513AA	15"	skid	90
	1813AA	18"	skid	60
	2413AA	24"	skid	36

S L A D	Product #	Size	Pkg.	Pieces
	1214AA	12"	skid	144
	1514AA	15"	skid	90
	1814AA	18"	skid	60
	2414AA	24"	skid	36

S	ID D	LLS	Product #	Size	Pieces
			0468AA	4"	
			0668AA	6"	
			0868AA	8"	
			1068AA	10"	

Order Through Columbus Purchasing

AL L S	Product #	Size	Pkg.	Pieces
	0415AA LONG 4"	bag	12	
	0417AA	4"	bag	16
	0515AA	5"	bag	12
	0615AA	6"	bag	9
	0815AA	8"	bag	4
	1015AA	10"	bag	4

AL D	L S	Product #	Size	Pkg.	Pieces
		0425AA	4" x 5"	bag	16
		0526AA	5" x 6"	bag	9

S A	Product #	Size	Pkg.	Pieces
	0321AA	3"	bag	12
	0421AA	4"	bag	8
	0525AA	5"	bag	4
	0626AA	6"	bag	3

D	Product #	Size	Pkg.	Pieces
	0523AA	5" x 3"	bag	4
	0524AA	5" x 4"	bag	4
	0624AA	6" x 4"	bag	3
	0625AA	6" x 5"	bag	3
	0644AA	6" x 5" x 4" x 3"	bag	3
	0841AA	8" x 6" x 5" x 4"	each	1
	0844AA	8" x 6" x 5" x 4"	each	1
	0845AA	8" x 6" x 5" x 4"	each	1
	1041AA	10 x 8" (with 6" scribe)	each	1
	1044AA	10 x 8" (with 6" scribe)	each	1
	1045AA	10 x 8" (with 6" scribe)	each	1

S L S	Product #	Size	Pkg.	Pieces
	1247AA	12" x 10" x 8" x 6"	each	1
	1547AA	15" x 12" x 10"	each	1
	1847AA	18" x 15" x 12"	each	1

L D	ne nd	Product #	Size	Pkg.	Pieces
		0341AA	3"	bag	12
		0441AA	4"	bag	8
		0541AA	5"	bag	4
		0641AA	6"	bag	3
		0841AA	8"	each	1
		1041AA	10"	each	1

L D L	lind ot nds	Product #	Size	Pkg.	Pieces
		0845AA	8" x 6" x 5" x 4"	each	1
		1045AA	10 x 8" (with 6" scribe)	each	1

SS	Product #	Size	Pkg.	Pieces
	0654AA	6" x 5" x 4"	bag	3

A	Product #	Size	Pkg.	Pieces
	0350AA	3"	bag	24
	0450AA (6", 8" pipe)	4"	bag	24
	0410AA (10", 12" pipe)	4"	bag	24

V

# ADS accessories quantities

VI

## SADDL S

Product #	Size	Pkg.	Pieces
0443AA	4" x 4"	bag	10
0543AA	5" x 3"	bag	6
0545AA	5" x 4"	bag	6
0547AA	5" x 4"	bag	6
0643AA	6" x 4"	bag	6
0646AA	6" x 6"	bag	6

## D L

Product #	Size	Pkg.	Pieces
0314AA	3" x 4"	bag	24
0514AA	5" x 4"	bag	20
0614AA	6" x 4"	bag	9
0516AA	6" x 5"	bag	9
0816AA	8" x 6"	bag	9
1018AA	10" x 8"	bag	6

## L

Product #	Size	Pkg.	Pieces
0390AA	3"	bag	12
0490AA	4"	bag	10

## L

Product #	Size	Pkg.	Pieces
0445AA	4"	bag	15

Product #	Size	Pkg.	Pieces
0322AA	3"	bag	7
0422AA	4"	bag	5
0522AA	5"	bag	4
0622AA	6"	bag	2
0822AA	8"	bag	1

## D S ADA

Product #	Size	Pkg.	Pieces
0364AA	3"	bag	24
0464AA	4"	bag	24
0465AA	4"	bag	20
0466AA	4"	bag	24
0664AA	6"	bag	8

## LA ADA

Product #	Size	Pkg.	Pieces
0362AA	3"	bag	24
0462AA	4"	bag	24
0562AA	5"	bag	24
0662AA	6"	bag	11
0862AA	8"	bag	9

## S S ADA

Product #	Size	Pkg.	Pieces
0839AA	8"	bag	6
0840AA	8"	bag	6
1039AA	10"	bag	6
1040AA	10"	bag	6

## AS

Product #
0940AA

## S A ADA

Product #	Size	Pkg.	Pieces
0463AA	4"	bag	24

## D L S

Product #	Size	Pkg.	Pieces
0333AA	3"	bag	100
0433AA	4"	bag	100
0434AA	4"	bag	100
0533AA	5"	bag	100
0633AA	6"	bag	50

Perf.

## A L D L

Product #	Size	Pkg.	Pieces
0833AA	8"	each	1
1033AA	10"	each	1
1233AA	12"	each	1
1533AA	15"	each	1
1833AA	18"	each	1
2433AA	24"	each	1
3033AA	30"	each	1
3633AA	36"	each	1
4233AA	42"	each	1
4833AA	48"	each	1
6033AA	60"	each	1

## S L D A

Product #	Size	Pkg.	Pieces	
0331AA	3"	bag	32	
0431AA	4"	bag	34	
0531AA	5"	bag	24	
0631AA	6"	bag	12	
0831AA	8"	bag	6	
1267AA	N-12 or SW	12"	bag	4
1567AA	N-12 or SW	15"	each	1
1867AA	N-12 or SW	18"	each	1
2467AA	N-12 or SW	24"	each	1

## S A D A

Product #	Size	Pkg.	Pieces	
0332AA	3"	bag	30	
0432AA	4"	bag	40	
0667AA	N-12	6"	bag	6
0832AA	S / W	8"	bag	6
0867AA	N-12	8"	bag	3
1032AA	S / W	10"	bag	6
1067AA	N-12	10"	bag	3

## AL D A

Product #	Size	Pkg.	Pieces	
0332AAIN	S / W	3"	bag	30

## S L S

Product #	Size	Pkg.	Pieces	
1524AD	SHORT	15" x 24"	each	1
1530AD	TALL	15" x 30"	each	1
COLORADO (only)				
1530AC		15" x 30"	each	1

## S L DS

Product #	Size	Pkg.	Pieces	
1536AD	STD.	15"	bag	10
1537AD	HV. DUTY	15"	bag	5
1537ADN	HD NOTCHED SUMP	15"	bag	5
COLORADO (only)				
1536AC		15"	bag	10

## D S

Product #	Size	Pkg.	Pieces
1369AB	REGULAR	each	1
1379AB	REG PLUG		
1370AB	HILL SIDE	each	1
1380AB	H/S PLUG		

## S D A S oot S r ace

Product #	Size	Pkg.	Pieces	
0467AA	N-12 ADAPTER	4"	bag	24

## L LAS S S L S

Product #	Size	Pkg.	Pieces
0471AG	4"	skid	500
0671AG	6"	skid	204
0871AG	8"	skid	80
1071AG	10"	skid	48
1271AG	12"	skid	
1571AG	15"	skid	
1871AG	18"	skid	
2471AG	24"	skid	

# ADS accessories quantities

Advanced S L	Product #	Size	Pkg.	Pieces
	1471AA	12"	bag	4
	1671AA	18"	bag	4

Advanced D L	Product #	Size	Pkg.	Pieces
	1472AA	12"	bag	6
	1672AA	18"	bag	6

Advanced D A	Product #	Size	Pkg.	Pieces
	1432AA	12"	bag	12
	1632AA	18"	bag	12

Advanced D L S	Product #	Size	Pkg.	Pieces
	1411AA	12"	bag	12
	1611AA	18"	bag	12
	PINS*			
	0840-MB		box	200

\* 2 pieces - 0840-MB Fastening. Pins should be ordered along with each coupling.

Advanced D S	Product #	Size	Pkg.	Pieces
	1480AA	12"		1

ADS S S LLS	Product #	Size	Pkg.	Pieces
	0493AA SMOOTH W /NOTCH		bag	4
	0497AA VENT ELL		bag	4
	0497AAFL SEPTIC ELL		bag	4

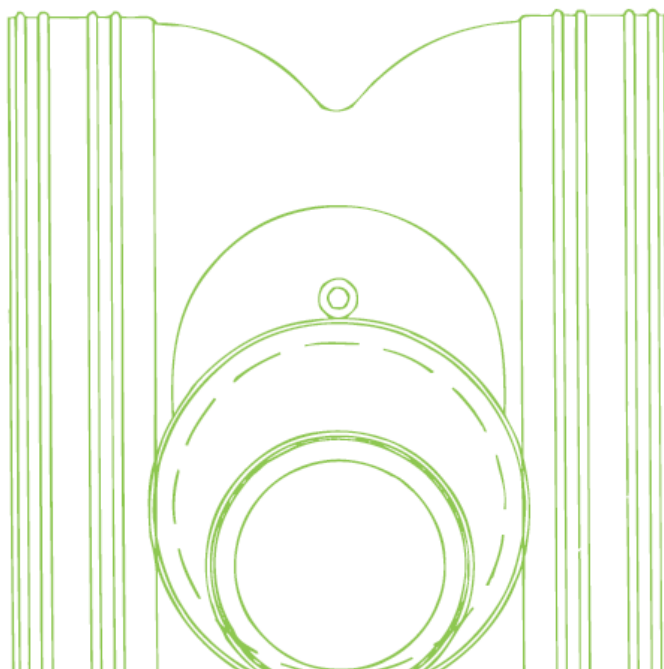

ADS D S S	Product #	Size	Pkg.	Pieces
	1210NP	12" & 15"		30
	1810NP	18"		30
	2410NP	24"		30
	3010NP	30" & 36"		25
	Order size on line note			
	0940NP	Rod		12 -18 - 24
	0941NP	Spacer		2pc per Rod
	0942NP	Nut		2pc per Rod





# Approximate quantities

VIII

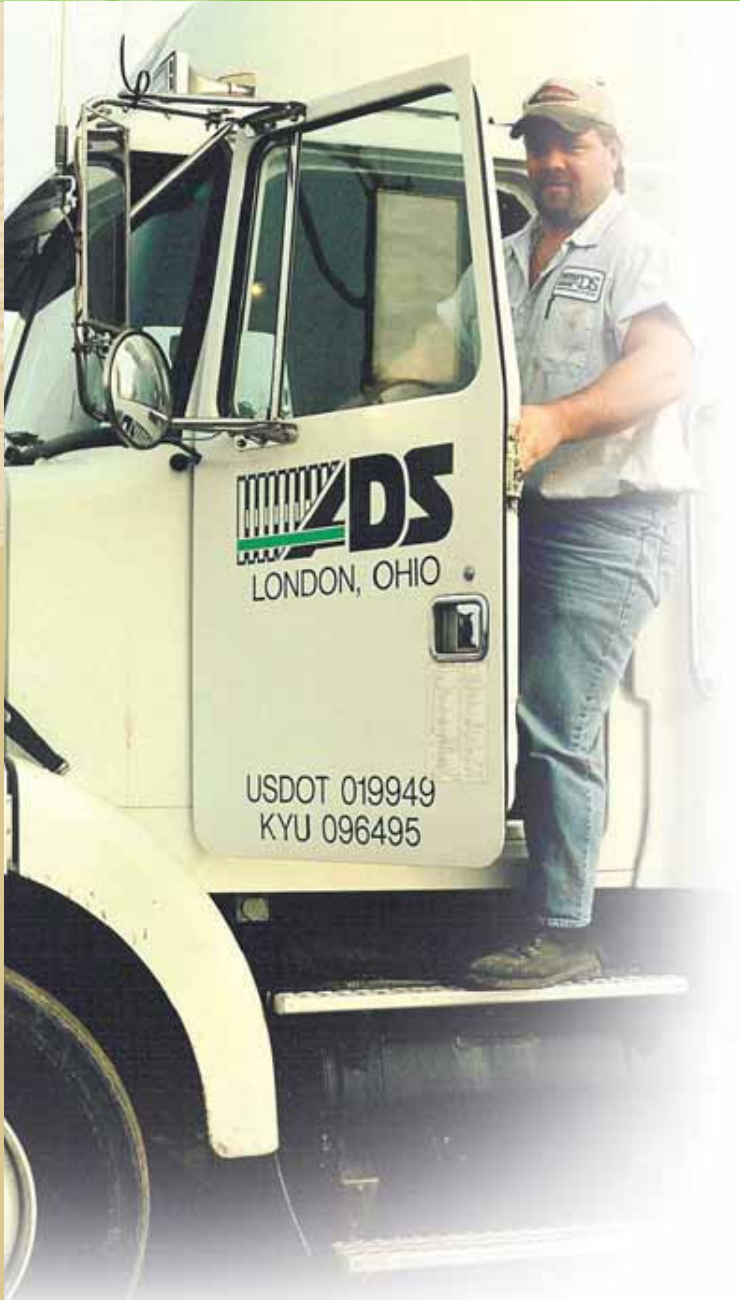

## Pipe Products

## Bundles, Coils, Sticks

3" 100'	180
3" 300'	61
4" Bundles	190
4" 100'	120
4" 250'	61
5" 165'	61
6" 100'	61
8" 20'	240
10" 20'	160
12" 20'	120
15" 20'	80
18" 20'	48
24" 20'	30
30" 20'	18
36" 20'	12
42" 20'	8 ( <i>varies w/equipment</i> )
48" 20'	6
60" 20'	4
ADS 3000	24 Pallets - 48' T/L
(Triple Wall)	30 Pallets - 53' T/L







THE MOST  
**ADVANCED**  
NAME IN  
DRAINAGE  
SYSTEMS®

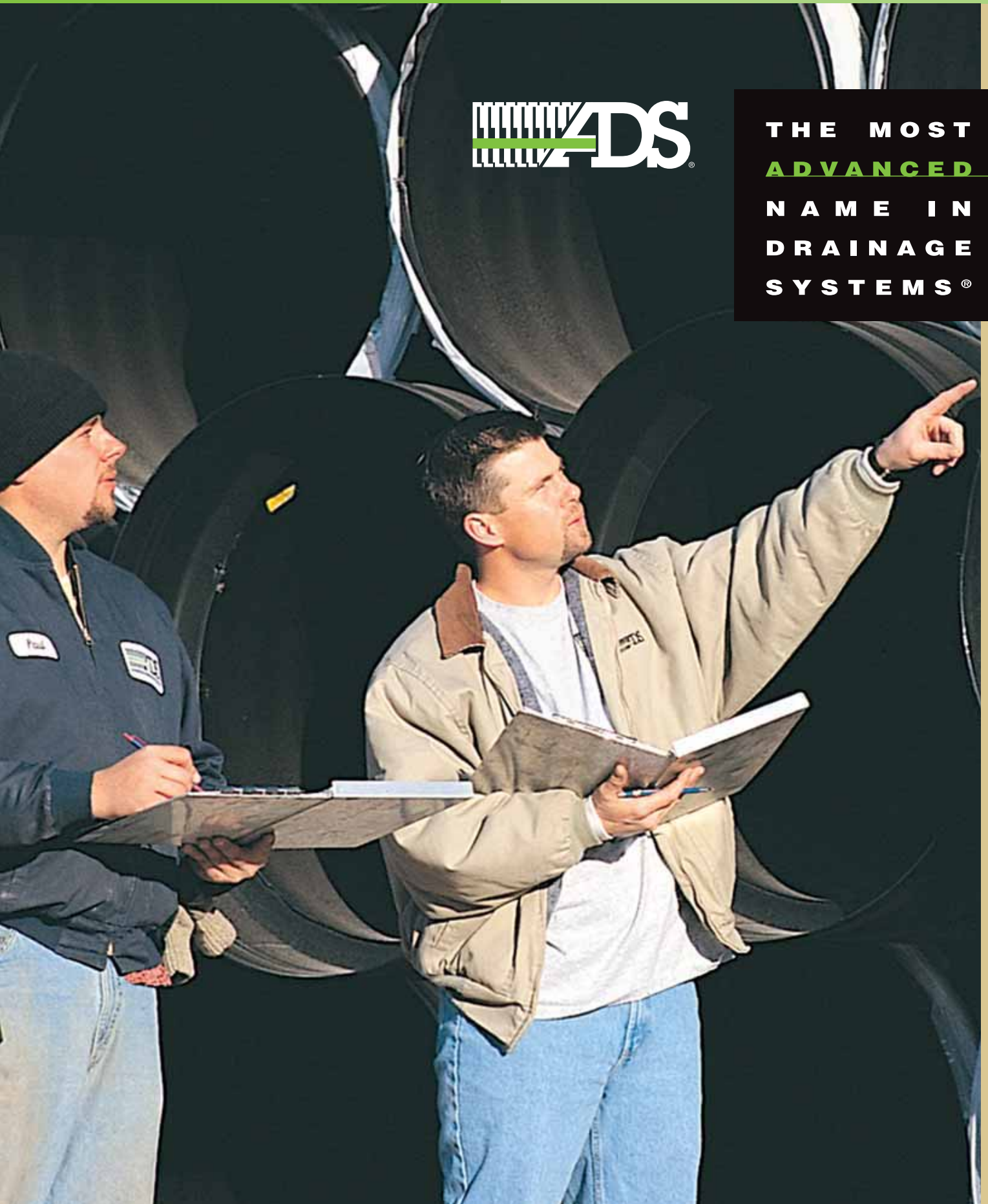

**MAXI**  
(3" - 15")



**SMALL COILS**  
(3" - 6")



**BUNDLES**  
(3" - 4")



**PALLETS**



**DUAL WALL / N-12**  
SMOOTH  
INNER SURFACE  
(4" - 60")



**SINGLE WALL CORRUGATED**  
(3" - 24")



**GRAIN AIRE PIPE** (12" - 24")  
1284 - 0020'  
1584 - 0020'  
1884 - 0020'  
1884 - 0020' SW  
2484 - 0020'



**SB2 PIPE** (8", 10")  
0871 - 0020'  
1071 - 0020'



**TRIPLE WALL** (3", 4")



on i rations  
o  
i e er orations



Sin le  
all i e  
Ann lar

**402 LEACH BED**  
(3 HOLES)

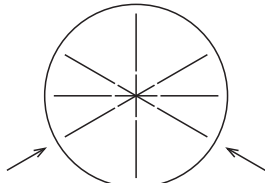

**406 MUCK**  
(3 HOLES AT 120 DEG.)

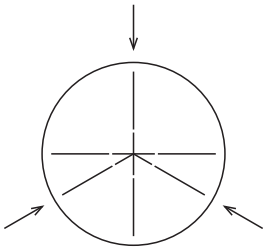

**401 PERFORATED**  
(SLOTS)



**404 BUNDLES**  
(BELL-END)  
(SLOTS)

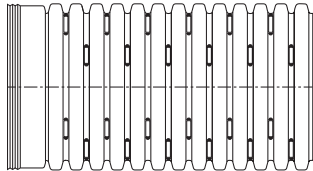

Sin le all i e Ann lar

**ADS D**  
**AS**

STAMP ON PIPE

Perforated		Solid
0301 - 0010'	BUNDLE	0351 - 0010'
0301 - 0100'	COIL	0351 - 0100'
0301 - 0300'	COIL	0351 - 0300'
0301 - 5000'	COIL	_____
0309 - 5000'	3" FINE SLOT W/BLACK FABRIC	_____
0372 - 0300'	COIL W/CEREX (0314-HA)	_____
0373 - 0100'	COIL W/SOCK (0324-HA)	_____
0373 - 0300'	COIL W/SOCK (0324-HA)	_____
0381 - 0300'	COIL	0380 - 0300'
0381 - 5000'	COIL	0380 - 5000'
0383 - 0300'	COIL W/SOCK (0324HA)	_____
0383 - 5000'	MAXI W/SOCK (0324HA)	_____

**ADS D**  
**AS**

STAMP ON PIPE

Perforated		Solid
0401 - 0050'	COIL	0451 - 0050'
0401 - 0100'	COIL	0451 - 0100'
0401 - 0250'	COIL	0451 - 0250'
0401 - 3000'	MAXI	0451 - 3000'
0402 - 0100'	COIL (LEACH BED)	_____
0402 - 0250'	COIL (LEACH BED)	_____
0402 - 0100' OS	4" LEACH BED PERF NEW STYLE	_____
0402 - 0250' OS	4" LEACH BED PERF NEW STYLE	_____
0402 - 0010' OS	4" LEACH BED BUNDLES NEW STYLE	_____
0405 - 0100'	COIL (WHITE)	0455 - 0100'
0405 - 0250'	COIL (WHITE)	0455 - 0250'
0405 - 3000'	COIL (WHITE)	_____
0406 - 0100'	COIL (Muck)	_____
0406 - 0250'	COIL (Muck)	_____
0409 - 0100'	4" FINE SLOT PERF	_____
0409 - 0250'	4" FINE SLOT PERF	_____
0409 - 3000'	4" FINE SLOT PERF	_____
0472 - 0100'	COIL W/CEREX (0414HA)	_____
0472 - 0250'	COIL W/CEREX (0414HA)	_____
0473 - 0100'	COIL W/SOCK (0424HA)	_____
0473 - 0250'	COIL W/SOCK (0424HA)	_____
0473 - 3000'	MAXI W/SOCK (0424HA)	_____
0476 - 3000'	COIL (MUCK) W/CEREX	_____
0477 - 3000'	COIL (MUCK) W/SOCK	_____

**DL S**  
**c ndle**

Perforated		Solid
0402 - 0010'	BUNDLE	0454 - 0010'
0402 - 0010' FL	BUNDLE (LEACH BED)	_____
0402 - 0010' IN	4" LEACH 2 HOLE FLORIDA	_____
0404 - 0010'	4" LEACH INDIANA	_____
0406 - 0010'	BUNDLE (SLOTS)	_____
	BUNDLE (Muck)	_____





# Single Line

## ADS D AS

STAMP ON PIPE

**Perforated**

0481 - 0100'	
0481 - 0250'	COIL
0481 - 3000'	MAXI
0482 - 0250'	COIL W/CEREX (0414HA)
0483 - 0250'	COIL W/SOCK (0424HA)
0483 - 3000'	MAXI W/SOCK (0424HA)

**Solid**

0480 - 0100'
0480 - 0250'
0480 - 3000'

## ADS D AAS

STAMP ON PIPE

**Perforated**

0441 - 0100'	
0441 - 0250'	COIL
0441 - 3000'	MAXI
0442 - 0100'	COIL W/CEREX (0414HA)
0442 - 0250'	COIL W/CEREX (0414HA)
0443 - 0100'	COIL W/SOCK (0425HA)
0443 - 0250'	COIL W/SOCK (0425HA)
0443 - 3000'	MAXI W/SOCK (0425HA)

**Solid**

0440 - 0100'
0440 - 0250'
0440 - 3000'

## ADS D AS

STAMP ON PIPE

**Perforated**

0501 - 0165'	COIL
0501 - 1900'	MAXI
0501 - 0165'	COIL (WHITE)
0509 - 0165'	5" FINE SLOT PERF
0509 - 1900'	5" FINE SLOT PERF
0572 - 0165'	COIL W/CEREX (0514-HA)
0573 - 0165'	COIL W/SOCK (0524-HA)
0573 - 1900'	MAXI W/SOCK (0524-HA)
0581 - 0165'	5" PERF HD COIL
0581 - 1900'	5" PERF HD MAXI

**Solid**

0551 - 0165'
0551 - 1900'
0555 - 0165'
0580 - 0165'
0580 - 1900'

## ADS D AS

STAMP ON PIPE

**Perforated**

0601 - 0010'	STICK
0601 - 0020'	STICK
0601 - 0100'	COIL
0601 - 1400'	MAXI
0605 - 0100'	COIL (WHITE)
0609 - 0100'	6" FINE SLOT PERF
0609 - 1400'	6" FINE SLOT PERF
0672 - 0100'	COIL W/CEREX (0614HA)
0673 - 0100'	COIL W/SOCK (0624HA)
0673 - 1400'	MAXI W/SOCK (0624HA)
0681 - 0020'	STICK
0681 - 0100'	COIL
0681 - 1350'	MAXI
0681 - 1400'	MAXI
0681 - 1450'	MAXI
0682 - 0100'	COIL W/CEREX (0614HA)
0683 - 0100'	COIL W/SOCK (0624HA)
0683 - 1400'	MAXI W/SOCK (0624HA)

**Solid**

0651 - 0010'
0651 - 0020'
0651 - 0100'
0651 - 1500'
0655 - 0100'
0680 - 0020'
0680 - 0100'
0680 - 1350'
0680 - 1400'
0680 - 1450'

## ADS D AAS

STAMP ON PIPE

**Perforated**

0641 - 0020'	STICK
0641 - 0100'	COIL
0641 - 1400'	MAXI
0642 - 0100'	COIL W/CEREX (0614HA)
0643 - 0100'	COIL W/SOCK (0625HA)
0643 - 1400'	MAXI W/SOCK (0625HA)

**Solid**

0640 - 0020'
0640 - 0100'
0640 - 1400'

## ADS D AS

STAMP ON PIPE

**Perforated**

0801 - 0020'	STICK
0801 - 0820'	MAXI
0870 - 0020'	(SB2) STICK / NO CEREX
0871 - 0020'	(SB2) STICK W/CEREX (0835HA)
0872 - 0020'	STICK W/CEREX (0835HA)
0873 - 0020'	STICK W/SOCK (0824HA)
0873 - 0820'	MAXI W/SOCK (0824HA)

**Solid**

0851 - 0020'
0851 - 0820'



# Single Line

**ADS D**  
**AAS**

STAMP ON PIPE

**Perforated**

0841 - 0020'	STICK	0840 - 0020'
0841 - 0820'	MAXI	0840 - 0820'
0842 - 0020'	STICK W/CEREX (0835HA)	_____
0843 - 0020'	STICK W/SOCK (0824HA)	_____
0843 - 0820'	MAXI W/SOCK (0824HA)	_____

NOTE: State approved stock lots may add a two letter code to the end of the product number. (Example: XXXXOH=Ohio, GA=Georgia, etc.)

**ADS D**  
**AS**

STAMP ON PIPE

**Perforated**

1001 - 0020'	STICK	1051 - 0020'
1001 - 0520'	MAXI	1051 - 0520'
1070 - 0020'	(SB2) STICK / NO CEREX	_____
1071 - 0020'	(SB2) STICK W/CEREX (1014HA)	_____
1073 - 0020'	STICK W/SOCK (1024HA)	_____

**ADS D**  
**AS**  
**AAS**

STAMP ON PIPE

**Perforated**

1201 - 0020'	STICK	1251 - 0020'
1201 - 0330'	MAXI	1251 - 0330'
1284 - 0020'	(GRAIN-AIRE) W/SCREEN	_____

**ADS D**  
**AS**  
**AAS**

STAMP ON PIPE

**Perforated**

1501 - 0020'	STICK	1551 - 0020'
1501 - 0165'	MAXI	_____
1573 - 0020'	STICK W/SOCK (1524HA)	_____
1584 - 0020'	(GRAIN-AIRE) W/SCREEN	_____

**ADS D**  
**AS**  
**AAS**

STAMP ON PIPE

**Perforated**

1801 - 0020'	STICK	1851 - 0020'
1873 - 0020'	STICK W/SOCK (1824HA)	_____
1884 - 0020' SW	(GRAIN-AIRE) W/SCREEN	_____

**ADS D**  
**AS**  
**AAS**

STAMP ON PIPE

**Perforated**

2401 - 0020'	STICK	2451 - 0020'
2473 - 0020'	STICK W/SOCK (2424HA)	_____



# N-12<sup>®</sup> Pipe

NOTE: 4" - 10" sticks have a 412-AA coupling

<b>N-12 Pipe Size</b>	<b># Sticks /Pallet</b>
4"	68
6"	36
8"	18
10"	11
12"	6
15"	4
18"	4
24"	3
30"	9
36"	6
42"	8
48"	3
60"	

**ADS 4" N-12  
ASTM F 405  
AASHTO M 252**

*STAMP ON PIPE*

**Perforated**

- 0411 - 0010'
- 0411 - 0020'
- 0412 - 0010'    2 HOLE PIPE
- 0413 - 0010'    3 HOLE PIPE
- 0423 - 0010'    W/SOCK (0424HA)
- 0423 - 0020'    W/SOCK (0424HA)

**Solid**

- 0415 - 0010'
- 0415 - 0020'
- \_\_\_\_\_
- \_\_\_\_\_
- \_\_\_\_\_
- \_\_\_\_\_

**ADS  
AS  
AAS**

*STAMP ON PIPE*

**Perforated**

- 0611 - 0010'
- 0611 - 0013'
- 0611 - 0020'
- 0623 - 0020'    STICK W/SOCK (0624HA)

**Solid**

- 0615 - 0010'
- 0615 - 0013'
- 0615 - 0020'
- \_\_\_\_\_







i e Used with split couplings – (XX65-AA)

**ADS  
AS  
AAS**

STAMP ON PIPE

**Perforated**

0811 - 0013'  
0811 - 0020'  
0823 - 0020'

STICK W/SOCK (0824HA)

**Solid**

0815 - 0013'  
0815 - 0020'

**ADS  
AS  
AAS**

STAMP ON PIPE

**Perforated**

2491 - 0020'  
2493 - 0020'  
2484 - 0020'

STICK W/SOCK (2424HA)  
N-12 W/GRAIN-AIRE

**Solid**

2495 - 0010'  
2495 - 0020'

**ADS  
AS  
AAS**

STAMP ON PIPE

**Perforated**

1011 - 0013'  
1011 - 0020'  
1023 - 0020'

STICK W/SOCK (1024HA)

**Solid**

1015 - 0013'  
1015 - 0020'

**ADS  
AS  
AAS**

STAMP ON PIPE

**Perforated**

3091 - 0020'

**Solid**

3095 - 0010'  
3095 - 0020'

**ADS  
AS  
AAS**

STAMP ON PIPE

**Perforated**

1291 - 0020'  
  
1293 - 0020'

STICK W/SOCK (1224HA)

**Solid**

1295 - 0010'  
1295 - 0013'  
1295 - 0020'

**ADS  
AS  
AAS**

STAMP ON PIPE

**Perforated**

3691 - 0020'

**Solid**

3695 - 0010'  
3695 - 0020'

**ADS  
AS  
AAS**

STAMP ON PIPE

**Perforated**

1591 - 0020'  
  
1593 - 0020'

STICK W/SOCK (1524HA)

**Solid**

1595 - 0010'  
1595 - 0013'  
1595 - 0020'

**ADS  
AS  
AAS**

STAMP ON PIPE

**Perforated**

4291 - 0020'

**Solid**

4295 - 0010'  
4295 - 0020'

**ADS  
AS  
AAS**

STAMP ON PIPE

**Perforated**

1891 - 0020'  
1893 - 0020'  
1884 - 0020'

STICK W/SOCK (1824HA)  
N-12 W/GRAIN-AIRE

**Solid**

1895 - 0010'  
1895 - 0013'  
1895 - 0020'

**ADS  
AS  
AAS**

STAMP ON PIPE

**Perforated**

6091 - 0020'

**Solid**

6095 - 0010'  
6095 - 0020'

S

(Used with XX88MG Gasket)



i e

(Used with XX13-AA Coupler & XX59-AG Gasket 2/Stick)

**Perforated\***

- 0411 - 0020' IB
- 0611 - 0020' IB
- 0811 - 0020' IB
- 1011 - 0020' IB

**Solid\***

- 0415 - 0020' IB
- 0615 - 0020' IB
- 0815 - 0020' IB
- 1015 - 0020' IB

\*4" - 10" Limited Geographically

**Perforated**

- 1281 - 0020' IB
- 1283 - 0020' IB STICK W/SOCK (1224HA)

**Solid**

- 1285 - 0020' IB

**Perforated**

- 1581 - 0020' IB
- 1583 - 0020' IB STICK W/SOCK (1524HA)

**Solid**

- 1585 - 0020' IB

**Perforated**

- 1881 - 0020' IB
- 1883 - 0020' IB STICK W/SOCK (1824HA)

**Solid**

- 1885 - 0020' IB

**Perforated**

- 2481 - 0020' IB
- 2483 - 0020' IB STICK W/SOCK (2424HA)

**Solid**

- 2485 - 0020' IB

**Perforated**

- 3081 - 0020' IB

**Solid**

- 3085 - 0020' IB

**Perforated**

- 3681 - 0020' IB

**Solid**

- 3685 - 0020' IB

**Perforated**

- 4281 - 0020' IB

**Solid**

- 4285 - 0020' IB

**Perforated**

- 4881 - 0020' IB

**Solid**

- 4885 - 0020' IB

**Perforated**

- 6081 - 0020' IB

**Solid**

- 6085 - 0020' IB

† Patented

S in elded i e

**Perforated\***

- 0461 - 0020' SP
- 0661 - 0020' SP
- 0861 - 0020' SP
- 1061 - 0020' SP

**Solid\***

- 0465 - 0020' SP
- 0665 - 0020' SP
- 0865 - 0020' SP
- 1065 - 0020' SP

\*Limited Geographically

i e

**Perforated**

- 0461 - 0020' IB
- 0661 - 0020' IB
- 0861 - 0020' IB
- 1061 - 0020' IB

**Solid**

- 0465 - 0020' IB\*
- 0665 - 0020' IB\*
- 0865 - 0020' IB\*
- 1065 - 0020' IB\*
- 1265 - 0020' IB
- 1565 - 0020' IB
- 1865 - 0020' IB
- 2465 - 0020' IB
- 3065 - 0020' IB
- 3665 - 0020' IB
- 4265 - 0020' IB
- 4865 - 0020' IB
- 6065 - 0020' IB

\* Limited Geographically

i e  
(Water Tight with Coupler)

**Perforated**

- 0461 - 0020' WC
- 0661 - 0020' WC
- 0861 - 0020' WC

**Solid**

- 0465 - 0020' WC
- 0665 - 0020' WC
- 0865 - 0020' WC

# TripleWall® Pipe



# TripleWall® Fittings

## 3" I.D. ADS 3000 HDPE ASTM F 810

STAMP ON PIPE

### Perforated

0352 - 0010'

2 HOLE\*

0353 - 0010'

3 HOLE\*

\* With 0318AA Bell Coupler (130 Pieces/Lift)

### Solid

0355 - 0010'

## D ADS D AS

STAMP ON PIPE

### Perforated

0452 - 0010'

2 HOLE\*

0453 - 0010'

3 HOLE\*

\* With 0418AA Bell Coupler (90 Pieces/Lift)

### Solid

0455 - 0010'

### Product #

0471TW

0492TW

0494TW

0499TW

0460TW

0433TW

0432TW

0482TW

0480TW

### Description

4" Coupling

4" 22.5 Degree Bend

4" 45 Degree Elbow

4" 90 Degree Elbow

4" Tee

4" Drain Gate

4" Cap

4" Downspout Adapter

4" Wye

### QTY

40/Pkg.

30/Pkg.

50/Pkg.

30/Pkg.

25/Pkg.

40/Pkg.

80/Pkg.

60/Pkg.

22/Pkg.





# ADS Series

## ADS Series Pipe

## Lubricant

<u>Solid</u>	<u>Size</u>	<u>Perforated</u>
0435 - 0020'	4"	0431 - 0020'
0635 - 0020'	6"	0631 - 0020'
0835 - 0020'	8"	0831 - 0020'
1035 - 0020'	10"	1031 - 0020'
1235 - 0020'	12"	1231 - 0020'
1535 - 0020'	15"	
1835 - 0020'	18"	
2435 - 0020'	24"	

\*Note: Series 35 Pipe is available in 13 ft. Sticks

Lubricant is required on all pipe gaskets.  
Below is an estimate based on the number of coupling joints.

<u>Pipe Diameter</u>	<u>Joints/2# 0200LU</u>	<u>Joints/8# 0800LU</u>
4"	89	356
6"	61	244
8"	43	172
10"	33	132
12"	25	100
15"	20	80
18"	16	64
24"	10	40

<u>Product #</u>	<u>Description</u>
0200LU	2# Tub
0800LU	8# Tub Lube
0459AG	4" gasket
0659AG	6" gasket
0859AG	8" gasket
1065MG	10" gasket





**PRODUCT No.**

<b>12 inch</b>	<b>18 inch</b>
0490 - 0100'	0690 - 0100'
0490 - 0300' No Fabric	0690 - 0300' No Fabric
0490 - 2400'	0690 - 1600'
0491 - 0100'	0693 - 0100'
0491 - 0300' 4 oz. fabric	0693 - 0300' Typar Fabric
0491 - 2400' (Needlepunched)	0693 - 1600'
0493 - 0100' Typar Fabric	
0493 - 2400'	
0494 - 0100' Knitted Polyester Sock	
0495 - 0100' 4 oz. Amoco Fabric (Grey)	
0495 - 2400' (Needlepunched)	
0497 - 0100' 4 oz. Phillips Fabric (Black)	
0497 - 1500' (Needlepunched)	
0497 - 2400'	



**END CAP**

<b>Part #</b>
1432-AA
1632-AA

<b>Pipe Size</b>
12"
18"

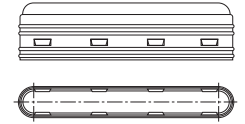

**COUPLING**

<b>Part #</b>
1411-AA
1611-AA

<b>Pipe Size</b>
12"
18"

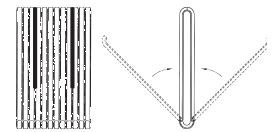

**WYES**

<b>Part #</b>
1480-AA

<b>Pipe Size</b>
12"

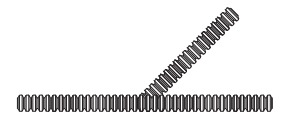

**COUPLING PIN**

<b>Part #</b>
0840-MB

<b>Pipe Size</b>
12" and 18"

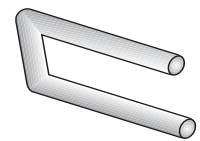

**END OUTLET**

<b>Part #</b>
1472-AA
1672-AA

<b>Pipe Size</b>
12"
18"

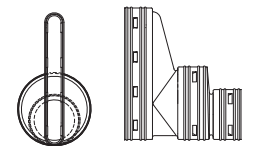

**SIDEOUT**

<b>Part #</b>
1471-AA
1671-AA

<b>Pipe Size</b>
12"
18"

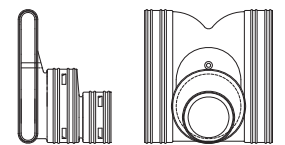

**12" FLAT OUTLET**

<b>Part #</b>
1432-AN

<b>Pipe Size</b>
4"

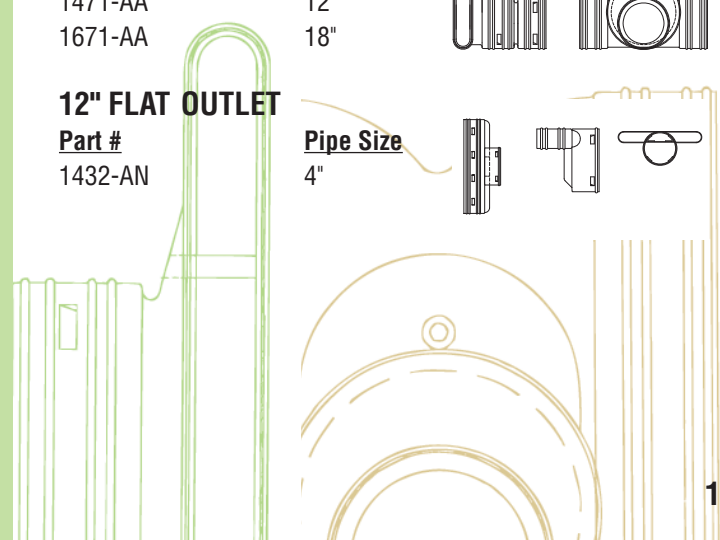



# ADS Advan D<sup>®</sup> Tees

## AdvanEDGE Fabricated Tees

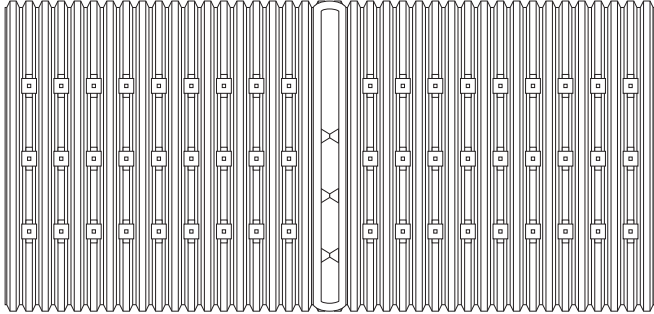

Part #	Pipe Size
1460AN	12"
1660AN	18"

## AdvanEDGE Fabricated Tees (Horizontal)

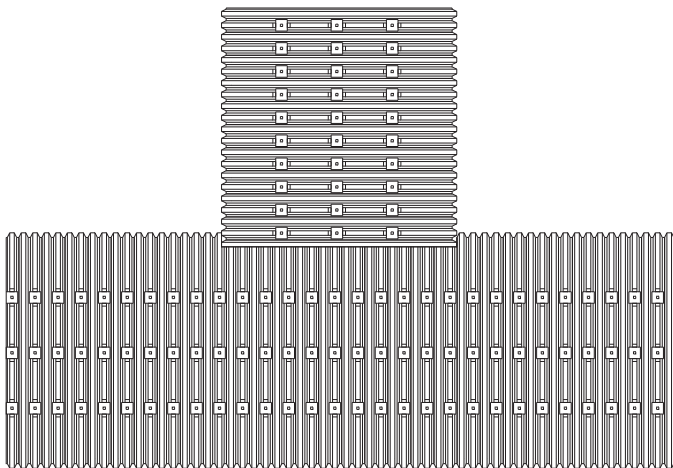

Part #	Pipe Size
1460ANH	12"
1660ANH	18"

## AdvanEDGE Fabricated Tees with Side Outlet

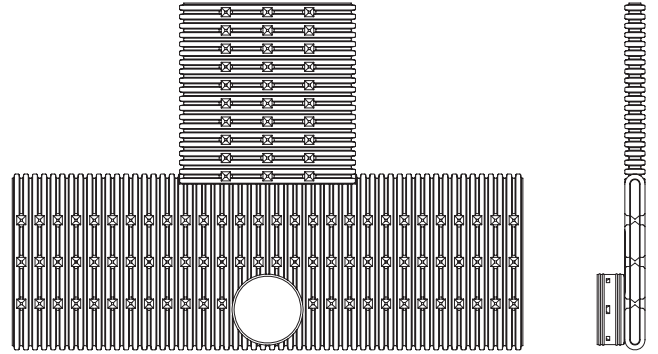

Part #	Pipe Size
1464ANH	12"
1664ANH81 Perf	12"

## AdvanEDGE Fabricated Cross Tees

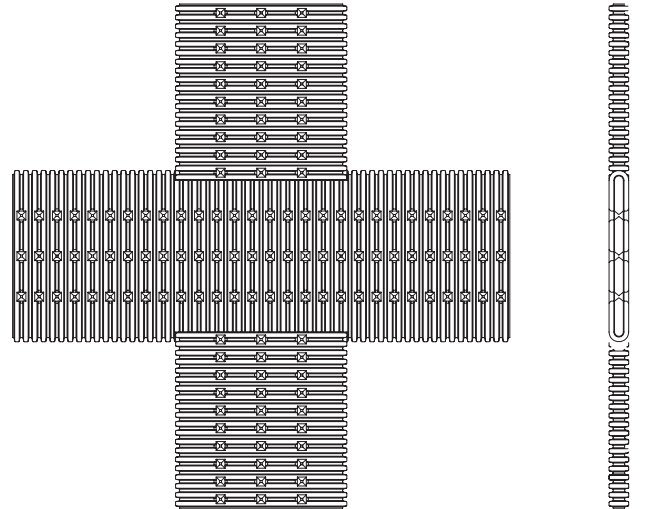

Part #	Pipe Size
1436ANH	12"





# ADS Advan D es

## AdvanEDGE Fabricated Wyes

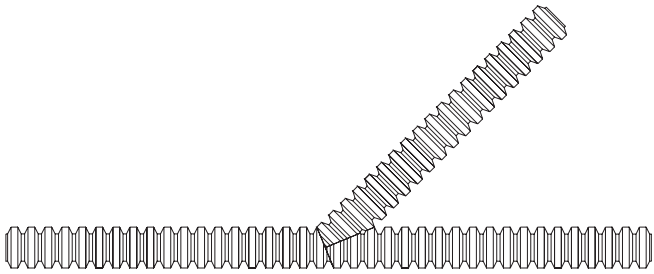
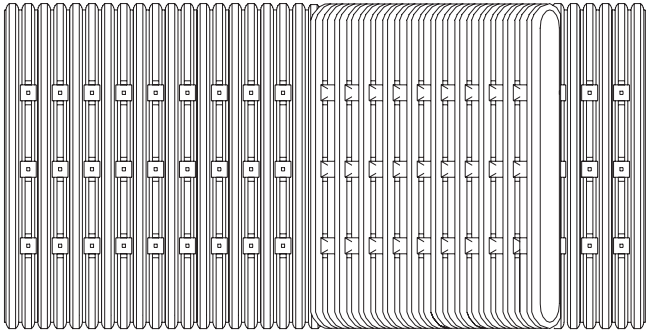

<b>Part #</b>	<b>Pipe Size</b>
1480AN	12"
1680AN	18"

## AdvanEDGE Fabricated Wyes (Horizontal)

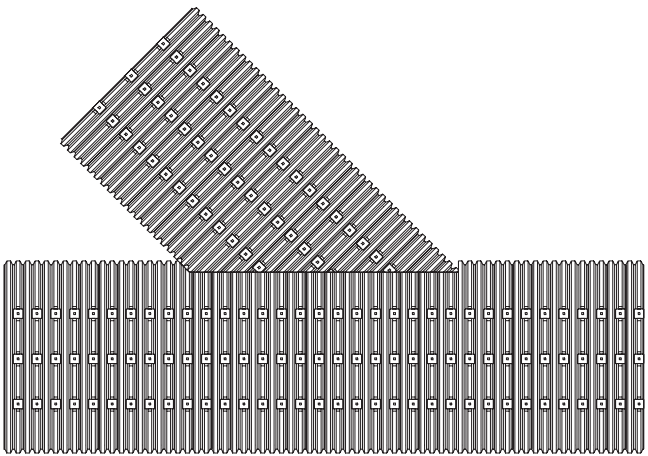

<b>Part #</b>	<b>Pipe Size</b>
1480ANH	12"
1680ANH	18"

## AdvanEDGE Fabricated Cross Wyes

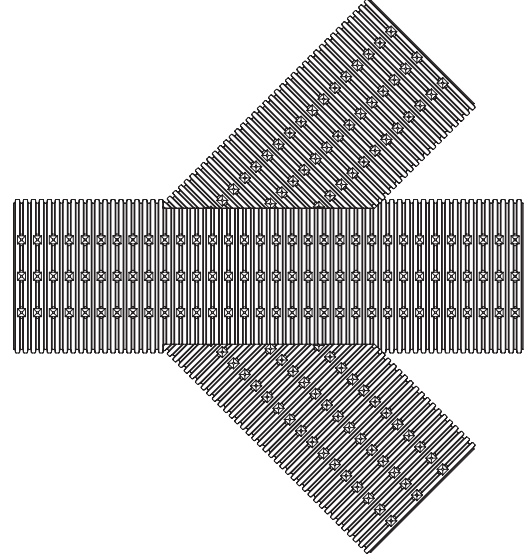

<b>Part #</b>	<b>Pipe Size</b>
1438ANH	12"

NOTE: # of cable ties must  
match # of holes on coupler



**N-12 Annular**

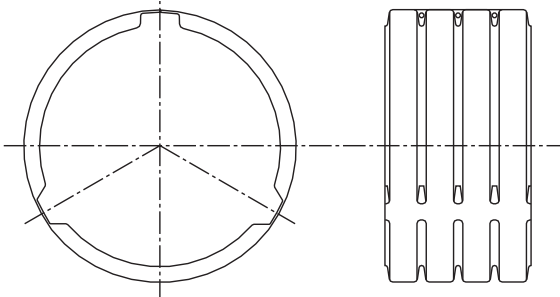

Part #	Size	
0665AA	6"	
1265AA	12"	
(used for 12" SW only in some regions)		
1266AA	12"	Premium coupling
1565AA	15"	
1566AA	15"	Premium coupling
1865AA	18"	
1866AA	18"	Premium coupling
2465AA	24"	
2466AA	24"	Premium coupling
2411AA	24"	Drossbach
2412AA	24"	Dros. Premium coupling
3065AA	30"	
3066AA	30"	Premium coupling
3661AA	36"	
3662AA	36"	Premium coupling
4265AA	42"	
4266AA	42"	Premium coupling
4865AA	48"	
4866AA	48"	Premium coupling
6065AA	60"	
6066AA	60"	Premium coupling

### INTERNAL COUPLER

Part #	Size
0315AA	3"
0415AA	4"
0417AA	4"
0515AA	5"
0615AA	6"
0815AA	8"
1015AA	10"



### EXTERNAL COUPLER SW\*

Part #	Size
0312AA	3"
0412AA*	4"
0512AA	5"
0612AA	6"
0812AA	8"
1012AA	10"

\* Fits N-12  
pipe



### N-12 BELL COUPLER

Part #	Size
0613AA	6"
0813AA	8"
1013AA	10"



### N-12 BELL COUPLER "ST"

for use with odd length pipe

Part #	Size
1214AA	12"
1514AA	15"
1814AA	18"
2414AA	24"



### N-12 BELL COUPLER "WT"

Part #	Size
1213AA	12"
1513AA	15"
1813AA	18"
2413AA	24"



### SPLIT COUPLER S/W

Part #	Size
0311AA	3"
0411AA	4"
0511AA	5"
0611AA	6"
0811AA	8"
1011AA	10"



### INTERNAL REDUCING COUPLER

Part #	Size
0425AA	5" x 4"
0526AA	6" x 5"



### REDUCING COUPLER S/W

Part #	Size
0314AA	4" x 3"
0514AA	5" x 4"
0516AA	6" x 5"
0614AA	6" x 4"
0816AA	8" x 6"
1018AA	10" x 8"



**BLIND TEE (ONE END)**

Part #	Size
0341AA	3"
0441AA	4"
0541AA	5"
0641AA	6"
0841AA	8"
1041AA	10"



**MULTIPLE CROSS TEE**

Part #	Size
0654AA	6" - 4,5,6"



**MULTIPLE TEE**

Part #	Size
0644AA	6" - 3,4,5,6"
0844AA	8" - 4,5,6,8"
1044AA	10" - 6,8,10"



**BLIND MULTIPLE TEE (BOTH ENDS)**

Part #	Size
0845AA	8" - 4,5,6,8"
1045AA	10" - 6,8,10"
1247AA	12" - 8,10,12"
1547AA	15" - 15,12,10"
1847AA	18" - 18,15,12"



**TAP TEE**

Part #	Size
0350AA	3"
0450AA	4"
0410AA	4" Long Tap



**INTERNAL SNAP TEE**

Part #	Size
0321AAIN	3"



**SNAP TEE**

Part #	Size
0321AA	3"
0421AA	4"
0525AA	5"
0626AA	6"



**REDUCING TEE**

Part #	Size
0523AA	5" x 3"
0524AA	5" x 4"
0624AA	6" x 4"
0625AA	6" x 5"



**SNAP END CAP**

Part #	Size
0332AA	3"
0432AA	4"
0832AA	8"
1032AA	10"



**INTERNAL END CAP**

Part #	Size
0332AAIN	3"



**SPLIT END CAP**

Part #	Size
0331AA	3"
0431AA	4"
0531AA	5"
0631AA	6"
0831AA	8"
1267AA	12"
1567AA	15"
1867AA	18"
2467AA	24"



SW or N-12  
SW or N-12  
SW or N-12  
SW or N-12

**N-12 SNAP END CAP**

Part #	Size
0667AA	6"
0867AA	8"
1067AA	10"



**END PLUGS "S/W"**

Part #	Size
0333AA	3"
0433AA	4"
0434AA	4" Perforated
0533AA	5"
0633AA	6"



**TAYLOR END PLUGS**

Part #	Size
0833AA	8"
1033AA	10"
1233AA	12"
1533AA	15"
1833AA	18"
2433AA	24"
3033AA	30"
3633AA	36"
4233AA	42"
4833AA	48"
6033AA	60"



**ELBOWS**

Part #	Size
0390AA	3" - 90°
0445AA	4" - 45°
0490AA	4" - 90°



**INTERNAL SNAP WYES**

Part #	Size
0322AAIN	3"



**WYES**

Part #	Size
0322AA	3"
0422AA	4"
0522AA	5"
0622AA	6"
0822AA	8"



**SUMP LINER**

Part #	Size
1524AD	24" high
1530AD	30" high



1524

1530

**SUMP LID**

Part #	Description
1536AD	Standard
1537AD	Heavy Duty
1537ADL	Locking Sump
1537ADNL	Notched Locking



1536

1537ADL

**DISTRIBUTION BOX**

Part #	Description
1369AB	Regular
1370AB	Hillside
1379AB	Regular
1380AB	Hillside Dist. Plug



1370

1369

**SEPTIC TEES**

Part #
0493AA



Part #
0497AA



Part #
0497AAFL



**OFFSET ADAPTER (SB2)**

Part #	Size
0839AA	8" without gasket
0840AA	8" with gasket
0940AA	Gasket
1039AA	10" without gasket
1040AA	10" with gasket



**SEPTIC TANK ADAPTER**

Part #	Size
0463AA	4"

**CLAY ADAPTER**

Part #	Size
0362AA	3"
0462AA	4"
0562AA	5"
0662AA	6"
0862AA	8"



**DOWNSPOUT ADAPTER**

Part #	Tube Size	Downspout
0364AA	3"	3.25 x 2.5
0464AA	4"	3.25 x 2.5
0465AA	4"	4.25 x 3
0466AA	4"	2.56 x 2.56 Raingo
0664AA	6"	4 x 6



**SEWER & DRAIN FITTINGS (SMOOTH SURFACE)**

Part #	Size
0467AA	4" N-12 Adapter



**ADS Plastic End Sections**

Part #	Pipe Diameter
1210NP	12" and 15"
1810NP	18"
2410NP	24"
3012NP	30"
3612NP	36"







## SOIL-TIGHT FITTINGS (Cleated Bells)

### TEE, BELL/BELL

<u>Part #</u>	<u>Size</u>	<u>Replaces</u>
0460ST	4"	0460AN
0660ST*	6" x 4"	—
0661ST	6"	0661AN
0860ST*	8" x 4"	—
0861ST*	8" x 6"	—
0862ST	8"	0862AN
1060ST*	10" x 4"	1060AN
1061ST*	10" x 6"	1061AN
1062ST	10" x 8"	1062AN
1063ST	10"	1063AN
1262ST	12" x 8"	1262AN
1263ST**	12" x 10"	—
1264ST	12"	1264AN



### WYE, BELL/BELL

<u>Part #</u>	<u>Size</u>	<u>Replaces</u>
0480ST	4"	0480AN
0680ST*	6" x 4"	—
0681ST	6"	0681AN
0880ST*	8" x 4"	—
0881ST*	8" x 6"	—
0882ST	8"	0882AN
1082ST	10" x 8"	1082AN
1083ST	10"	1083AN
1282ST	12" x 8"	1282AN
1283ST**	12" x 10"	—
1284ST	12"	1284AN



### 45° ELBOW, BELL/BELL

<u>Part #</u>	<u>Size</u>	<u>Replaces</u>
0494ST	4"	0494AN
0694ST	6"	0694AN
0894ST	8"	0894AN
1094ST	10"	1094AN
1294ST	12"	1297AN



### 90° ELBOW, BELL/BELL

<u>Part #</u>	<u>Size</u>	<u>Replaces</u>
0499ST	4"	0499AN
0699ST	6"	0699AN
0899ST	8"	0899AN
1099ST	10"	1099AN
1299ST	12"	1298AN



\*Shipped as two injection molded fittings.

\*\*12" x 10" Tees and Wyes require about 15" of 12" N-12 pipe to join the injection molded fittings.



# Injection Molded Fittings

Water-Tight Fittings include F477 gaskets for attachment on pipe end

## COUPLER, BELL/BELL

Part #	Size	Replaces
0413WT	4"	S35 10.8
0613WT	6"	S35 10.8
0813WT	8"	S35 10.8



## REDUCING COUPLER, BELL/BELL

Part #	Size	Replaces
0614WT	6" x 4"	0670AN
0814WT	8" x 4"	0870AN
0816WT	8" x 6"	0871AN
1074WT*	10" x 4"	-
1076WT*	10" x 6"	-
1018WT	10" x 8"	1072AN
1274WT*	12" x 4"	-
1276WT*	12" x 6"	-
1218WT	12" x 8"	1272AN
1210WT	12" x 10"	1273AN



## REDUCING COUPLER, SPIGOT/BELL

Part #	Size	Replaces
0674WT	6" x 4"	-
0874WT	8" x 4"	-
0876WT	8" x 6"	-



## TEE, BELL/BELL

Part #	Size	Replaces
0460WT	4"	0460AN
0660WT*	6" x 4"	-
0661WT	6"	0661AN
0860WT*	8" x 4"	-
0861WT*	8" x 6"	-
0862WT	8"	0862AN
1060WT*	10" x 4"	1060AN
1061WT*	10" x 6"	1061AN
1062WT	10" x 8"	1062AN
1063WT	10"	1063AN
1260WT*	12" x 4"	1260AN
1261WT*	12" x 6"	1261AN
1262WT	12" x 8"	1262AN
1263WT**	12" x 10"	-
1264WT	12"	1264AN



## WYE, BELL/BELL

Part #	Size	Replaces
0480WT	4"	0480AN
0680WT*	6" x 4"	-
0681WT	6"	0681AN
0880WT*	8" x 4"	-
0881WT*	8" x 6"	-
0882WT	8"	0882AN
1080WT*	10" x 4"	1080AN
1081WT*	10" x 6"	1081AN
1082WT	10" x 8"	1082AN
1083WT	10"	1083AN
1280WT*	12" x 4"	1280AN
1281WT*	12" x 6"	1281AN
1282WT	12" x 8"	1282AN
1283WT**	12" x 10"	-
1284WT	12"	1284AN



## TEE-WYE, BELL/BELL

Part #	Size	Replaces
0836WT	8" x 6"	0836DAN



## 45° ELBOW, BELL/BELL

Part #	Size	Replaces
0494WT	4"	0490AN
0694WT	6"	0694AN
0894WT	8"	0894AN
1094WT	10"	1094AN
1294WT	12"	1297AN



## 90° ELBOW, BELL/BELL

Part #	Size	Replaces
0499WT	4"	0499AN
0699WT	6"	0699AN
0899WT	8"	0899AN
1099WT	10"	1099AN
1299WT	12"	1298AN



\*Shipped as two injection molded fittings.

\*\*12" x 10" Tees and Wyes require about 15" of 12" N-12 pipe to join the injection molded fittings.



# ed cin ittin s

## SOIL-TIGHT — TEE (BELL / BELL)

Part #	Size	Consists of	
		Tee	Reducer
0660ST	6" x 4"	0661ST 6"	+ 0674WT 6" x 4"
0860ST	8" x 4"	0862ST 8"	+ 0874WT 8" x 4"
0861ST	8" x 6"	0862ST 8"	+ 0876WT 8" x 6"
1060ST	10" x 4"	1062ST 10 x 8	+ 0874WT 8" x 4"
1061ST	10" x 6"	1062ST 10 x 8	+ 0876WT 8" x 6"
1263ST <sup>1,2</sup>	12" x 10"	1264ST 12"	+ 1210WT 12" x 10"

## SOIL-TIGHT — WYE (BELL / BELL)

Part #	Size	Consists of	
		Wye	Reducer
0680ST	6" x 4"	0681ST 6"	+ 0674WT 6" x 4"
0880ST	8" x 4"	0882ST 8"	+ 0874WT 8" x 4"
0881ST	8" x 6"	0882ST 8"	+ 0876WT 8" x 6"
1283ST <sup>3</sup>	12" x 10"	1284ST 12"	+ 1210WT 12" x 10"

Some of the injection molded Reducers, Tees and Wyes require field assembly of two parts.

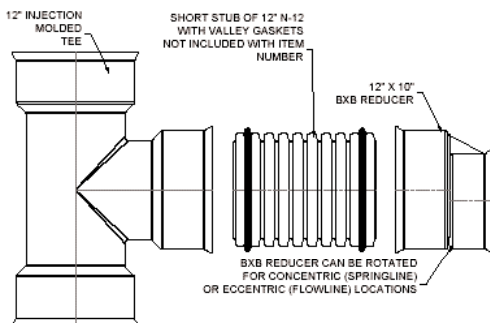
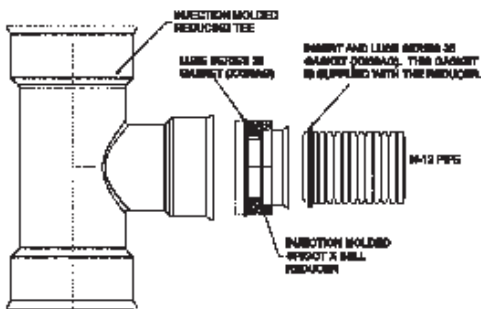
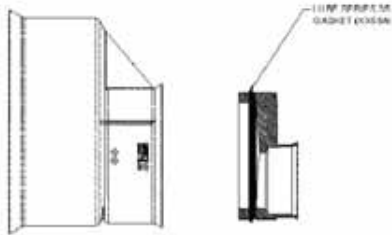

## WATER-TIGHT — REDUCER (BELL / BELL)

Part #	Size	Consists of	
		Reducer	Reducer
1074WT	10" x 4"	1018WT 10 x 8	+ 0874WT 8 x 4
1076WT	10" x 6"	1018WT 10 x 8	+ 0876WT 8 x 6
1274WT	12" x 4"	1218WT 12 x 8	+ 0874WT 8 x 4
1276WT	12" x 6"	1218WT 12 x 8	+ 0876WT 8 x 6

## WATER-TIGHT — TEE (BELL / BELL)

Part #	Size	Consists of	
		Tee	Reducer
0660WT	6" x 4"	0661WT 6"	+ 0674WT 6" x 4"
0860WT	8" x 4"	0862WT 8"	+ 0874WT 8" x 4"
0861WT	8" x 6"	0862WT 8"	+ 0876WT 8" x 6"
1060WT	10" x 4"	1062WT 10" x 8"	+ 0874WT 8" x 4"
1061WT	10" x 6"	1062WT 10" x 8"	+ 0876WT 8" x 6"
1260WT	12" x 4"	1262WT 12" x 8"	+ 0874WT 8" x 4"
1261WT	12" x 6"	1262WT 12" x 8"	+ 0876WT 8" x 6"
1263WT <sup>1,2</sup>	12" x 10"	1264WT 12"	+ 1210WT 12" x 10"

## WATER-TIGHT — WYE (BELL / BELL)

Part #	Size	Consists of	
		Wye	Reducer
0680WT	6" x 4"	0681WT 6"	+ 0674WT 6" x 4"
0880WT	8" x 4"	0882WT 8"	+ 0874WT 8" x 4"
0881WT	8" x 6"	0882WT 8"	+ 0876WT 8" x 6"
1080WT	10" x 4"	1082WT 10" x 8"	+ 0874WT 8" x 4"
1081WT	10" x 6"	1082WT 10" x 8"	+ 0876WT 8" x 6"
1280WT	12" x 4"	1282WT 12" x 8"	+ 0874WT 8" x 4"
1281WT	12" x 6"	1282WT 12" x 8"	+ 0876WT 8" x 6"
1283WT <sup>3</sup>	12" x 10"	1284WT 12"	+ 1210WT 12" x 10"

<sup>1</sup> Additional pipe stub not shipped with item number, order this pipe separately

<sup>2</sup> **12" x 10" Tee:** order 1264 (WT or ST) 12" x 12" Tee, 1210WT 12" x 10" Bell/Bell Reducer, and approximately 15' of 12" diameter N-12 pipe to make the connection between the two bell ends.

<sup>3</sup> **12" x 10" Wye:** order 1284 (WT or ST) 12" x 12" Wye, 1210WT 12" x 10" Bell/Bell Reducer, and approximately 15' of 12" diameter N-12 pipe to make the connection between the two bell ends.

# to last o lin s Ada ters

(Green Fittings) NOTE: Gasket not required for SDR35 portion of fitting

## Se er alit ittin s

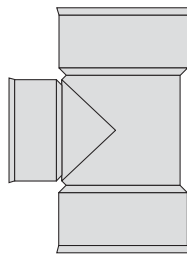
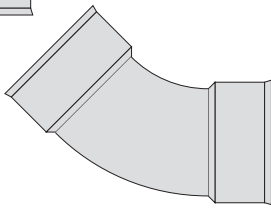
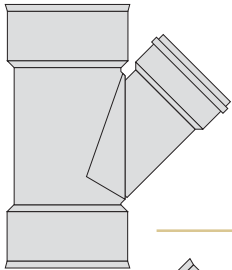

### N-12 COUPLING

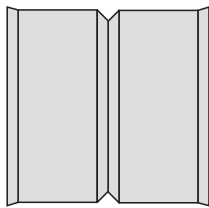

Size	ADS code
10"	1071 AG
12"	1271 AG
15"	1571 AG
18"	1871 AG
24"	2471 AG

### SLIP COUPLING for repairing lines

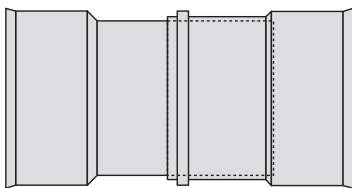

Size	ADS code
4"	0475 AG
6"	0675 AG
8"	0875 AG
10"	1075 AG
12"	1275 AG
15"	1575 AG
18"	1875 AG
24"	2475 AG

### N-12 ADAPTER with SDR 35 bell

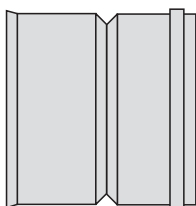

Size	ADS code
4"	0469 AG
6"	0669 AG
8"	0869 AG
10"	1069 AG
12"	1269 AG
15"	1569 AG
18"	1869 AG
24"	2469 AG

Many Nyloplast (Sewer Quality) Fittings are not stocked at ADS plants and Distribution Centers. Significant lead times of up to 10 days could be required to allow product sourcing and delivery.

# to last o lin s Ada ters

(Green Fittings) NOTE: Gasket not required for SDR35 or SCH40 portion of fitting

### N-12 ADAPTER with Schedule 40 bell

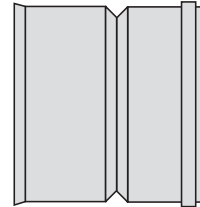

Size	ADS code
4"	0479 AG
6"	0679 AG
8"	0879 AG
10"	1079 AG
12"	1279 AG
15"	1579 AG
18"	1879 AG
24"	2479 AG

### N-12 ADAPTER with SDR 35 spigot

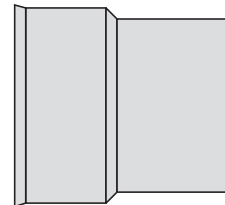

Size	ADS code
4"	0468 AG
6"	0668 AG
8"	0868 AG
10"	1068 AG
12"	1268 AG
15"	1568 AG
18"	1868 AG
24"	2468 AG

### N-12 ADAPTER with Schedule 40 spigot

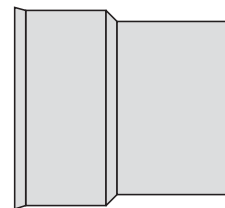

Size	ADS code
4"	0478 AG
6"	0678 AG
8"	0878 AG
10"	1078 AG
12"	1278 AG
15"	1578 AG
18"	1878 AG
24"	2478 AG

### CLEAN OUT PLUGS

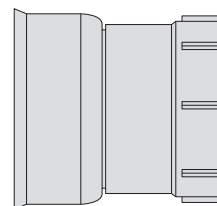

Size	ADS code
4"	0474 AG
6"	0674 AG
8"	0874 AG

Many Nyloplast (Sewer Quality) Fittings are not stocked at ADS plants and Distribution Centers. Significant lead times of up to 10 days could be required to allow product sourcing and delivery.



# lo last ees

(Green Fittings)



# lo last es

(Green Fittings)

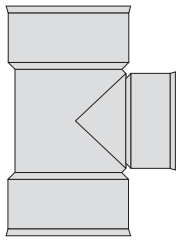

## N-12 Tee with N-12 branch

Many Nyloplast (Sewer Quality) Fittings are not stocked at ADS plants and Distribution Centers. Significant lead times of up to 10 days could be required to allow product sourcing and delivery.

Size	ADS code
10" x 4"	1081 AG
10" x 6"	1082 AG
10" x 8"	1083 AG
10" x 10"	1084 AG
12" x 4"	1281 AG
12" x 6"	1282 AG
12" x 8"	1283 AG
12" x 10"	1284 AG
12" x 12"	1285 AG
15" x 4"	1581 AG
15" x 6"	1582 AG
15" x 8"	1583 AG
15" x 10"	1584 AG
15" x 12"	1585 AG
15" x 15"	1586 AG

Size	ADS code
18" x 4"	1881 AG
18" x 6"	1882 AG
18" x 8"	1883 AG
18" x 10"	1884 AG
18" x 12"	1885 AG
18" x 15"	1886 AG
18" x 18"	1887 AG
24" x 4"	2481 AG
24" x 6"	2482 AG
24" x 8"	2483 AG
24" x 10"	2484 AG
24" x 12"	2485 AG
24" x 15"	2486 AG
24" x 18"	2487 AG
24" x 24"	2488 AG

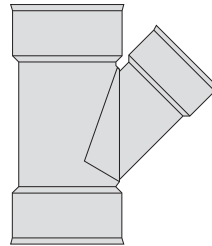

## N-12 Wye with N-12 branch

Many Nyloplast (Sewer Quality) Fittings are not stocked at ADS plants and Distribution Centers. Significant lead times of up to 10 days could be required to allow product sourcing and delivery.

Size	ADS code
10" x 4"	1091 AG
10" x 6"	1092 AG
10" x 8"	1093 AG
10" x 10"	1094 AG
12" x 4"	1291 AG
12" x 6"	1292 AG
12" x 8"	1293 AG
12" x 10"	1294 AG
12" x 12"	1295 AG
15" x 4"	1591 AG
15" x 6"	1592 AG
15" x 8"	1593 AG
15" x 10"	1594 AG
15" x 12"	1595 AG
15" x 15"	1596 AG

Size	ADS code
18" x 4"	1891 AG
18" x 6"	1892 AG
18" x 8"	1893 AG
18" x 10"	1894 AG
18" x 12"	1895 AG
18" x 15"	1896 AG
18" x 18"	1897 AG
24" x 4"	2491 AG
24" x 6"	2492 AG
24" x 8"	2493 AG
24" x 10"	2494 AG
24" x 12"	2495 AG
24" x 15"	2496 AG
24" x 18"	2497 AG
24" x 24"	2498 AG

# lo last ees

(Green Fittings) Note: Gasket not required for SDR35 portion of fitting

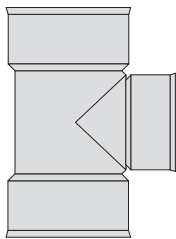

## N-12 Tee with SDR 35 branch

Many Nyloplast (Sewer Quality) Fittings are not stocked at ADS plants and Distribution Centers. Significant lead times of up to 10 days could be required to allow product sourcing and delivery.

Size	ADS code
10" x 4"	1061 AG
10" x 6"	1062 AG
10" x 8"	1063 AG
10" x 10"	1064 AG
12" x 4"	1261 AG
12" x 6"	1262 AG
12" x 8"	1263 AG
12" x 10"	1264 AG
12" x 12"	1265 AG
15" x 4"	1561 AG
15" x 6"	1562 AG
15" x 8"	1563 AG
15" x 10"	1564 AG
15" x 12"	1565 AG
15" x 15"	1566 AG

Size	ADS code
18" x 4"	1861 AG
18" x 6"	1862 AG
18" x 8"	1863 AG
18" x 10"	1864 AG
18" x 12"	1865 AG
18" x 15"	1866 AG
18" x 18"	1867 AG
24" x 4"	2461 AG
24" x 6"	2462 AG
24" x 8"	2463 AG
24" x 10"	2464 AG
24" x 12"	2465 AG
24" x 15"	2466 AG
24" x 18"	2467 AG

# lo last es

(Green Fittings) Note: Gasket not required for SDR35 portion of fitting

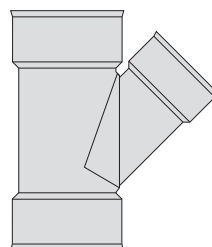

## N-12 Wye with SDR 35 branch

Many Nyloplast (Sewer Quality) Fittings are not stocked at ADS plants and Distribution Centers. Significant lead times of up to 10 days could be required to allow product sourcing and delivery.

Size	ADS code
4" x 4"	0401 AG
6" x 4"	0601 AG
6" x 6"	0602 AG
8" x 4"	0801 AG
8" x 6"	0802 AG
8" x 8"	0803 AG
10" x 4"	1001 AG
10" x 6"	1002 AG
10" x 8"	1003 AG
10" x 10"	1004 AG
12" x 4"	1201 AG
12" x 6"	1202 AG
12" x 8"	1203 AG
12" x 10"	1204 AG
12" x 12"	1205 AG

Size	ADS code
15" x 4"	1501 AG
15" x 6"	1502 AG
15" x 8"	1503 AG
15" x 10"	1504 AG
15" x 12"	1505 AG
15" x 15"	1506 AG
18" x 4"	1801 AG
18" x 6"	1802 AG
18" x 8"	1803 AG
18" x 10"	1804 AG
18" x 12"	1805 AG
18" x 15"	1806 AG
18" x 18"	1807 AG
24" x 4"	2401 AG
24" x 6"	2402 AG
24" x 8"	2403 AG
24" x 10"	2404 AG
24" x 12"	2405 AG
24" x 15"	2406 AG
24" x 18"	2407 AG
24" x 24"	2408 AG

## lo last ee es (Green Fittings)



## lo last los (Green Fittings)

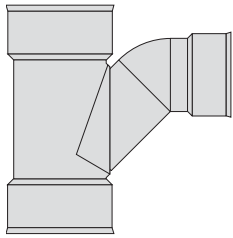

### Tee-Wye with N-12 branch

Many Nyloplast (Sewer Quality) Fittings are not stocked at ADS plants and Distribution Centers. Significant lead times of up to 10 days could be required to allow product sourcing and delivery.

Size	ADS code
4" x 4"	0435 AG
6" x 4"	0635 AG
6" x 6"	0636 AG
8" x 4"	0835 AG
8" x 6"	0836 AG
8" x 8"	0837 AG
10" x 4"	1035 AG
10" x 6"	1036 AG
10" x 8"	1037 AG
12" x 4"	1235 AG
12" x 6"	1236 AG
12" x 8"	1237 AG

Size	ADS code
15" x 4"	1535 AG
15" x 6"	1536 AG
15" x 8"	1537 AG
18" x 4"	1835 AG
18" x 6"	1836 AG
18" x 8"	1837 AG
24" x 4"	2435 AG
24" x 6"	2436 AG
24" x 8"	2437 AG

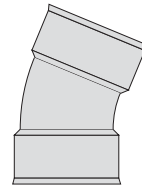

### N-12 ELBOW — 22.5°

Size	ADS code
4"	0422 AG
6"	0622 AG
8"	0822 AG
10"	1022 AG
12"	1222 AG
15"	1522 AG
18"	1822 AG
24"	2422 AG

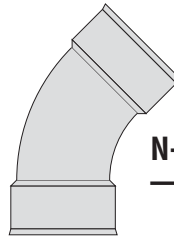

### N-12 ELBOW — 45°

Size	ADS code
10"	1045 AG
12"	1245 AG
15"	1545 AG
18"	1845 AG
24"	2445 AG

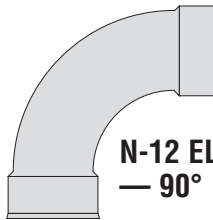

### N-12 ELBOW — 90°

Size	ADS code
10"	1090 AG
12"	1290 AG
15"	1590 AG
18"	1890 AG
24"	2490 AG

## lo last increasers (Green Fittings)

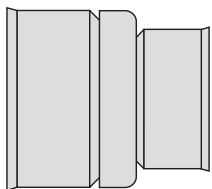

### Concentric Increaser

Many Nyloplast (Sewer Quality) Fittings are not stocked at ADS plants and Distribution Centers. Significant lead times of up to 10 days could be required to allow product sourcing and delivery.

Size	ADS code
6" x 4"	0611 AG
8" x 4"	0811 AG
8" x 6"	0812 AG
10" x 4"	1011 AG
10" x 6"	1012 AG
10" x 8"	1013 AG
12" x 4"	1211 AG
12" x 6"	1212 AG
12" x 8"	1213 AG
12" x 10"	1214 AG
15" x 4"	1511 AG
15" x 6"	1512 AG
15" x 8"	1513 AG
15" x 10"	1514 AG
15" x 12"	1515 AG

Size	ADS code
18" x 4"	1811 AG
18" x 6"	1812 AG
18" x 8"	1813 AG
18" x 10"	1814 AG
18" x 12"	1815 AG
18" x 15"	1816 AG
24" x 4"	2411 AG
24" x 6"	2412 AG
24" x 8"	2413 AG
24" x 10"	2414 AG
24" x 12"	2415 AG
24" x 15"	2416 AG
24" x 18"	2417 AG

## lo last nd a s (Green Fittings)

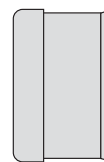

### N-12 END CAP

Size	ADS code
4"	0432 AG
6"	0632 AG
8"	0832 AG
10"	1032 AG
12"	1232 AG
15"	1532 AG
18"	1832 AG
24"	2432 AG

## Sanded an ole Ada ter (Green Fittings)

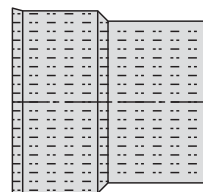

Size	ADS code
4"	0477 AG
6"	0677 AG
8"	0877 AG
10"	1077 AG
12"	1277 AG
15"	1577 AG
18"	1877 AG
24"	2477 AG

Many Nyloplast (Sewer Quality) Fittings are not stocked at ADS plants and Distribution Centers. Significant lead times of up to 10 days could be required to allow product sourcing and delivery.



# ADS fabricated ends

These fabricated fittings are also available "plain end" as shown, "bell/spigot end" and "bell/bell end".

## N-12 Fabricated 11.25° Bends

Part #	Pipe Size
0491AN	4"
0691AN	6"
0891AN	8"
1091AN	10"
1291AN	12"
1591AN	15"
1891AN	18"
2491AN	24"
3091AN	30"
3691AN	36"
4291AN	42"
4891AN	48"
6091AN	60"

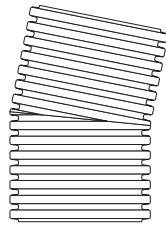

## N-12 Fabricated 22.5° Bends

Part #	Pipe Size
0492AN	4"
0692AN	6"
0892AN	8"
1092AN	10"
1292AN	12"
1592AN	15"
1892AN	18"
2492AN	24"
3092AN	30"
3692AN	36"
4292AN	42"
4892AN	48"
6092AN	60"

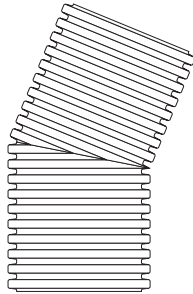

## N-12 Fabricated 30° Bends

Part #	Pipe Size
0495AN	4"
0695AN	6"
0895AN	8"
1095AN	10"
1295AN	12"
1595AN	15"
1895AN	18"
2495AN	24"
3095AN	30"
3695AN	36"

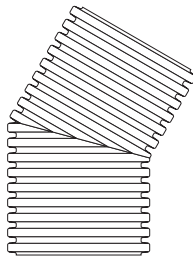

## N-12 Fabricated 30° Bends (Two-Miter)

Part #	Pipe Size
4295AN	42"
4895AN	48"
6095AN	60"

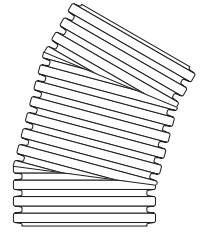

## N-12 Fabricated 45° Bends (Two-Miter)

Part #	Pipe Size
1294AN	12"
1594AN	15"
1894AN	18"
2494AN	24"
3094AN	30"
3694AN	36"
4294AN	42"
4894AN	48"
6094AN	60"

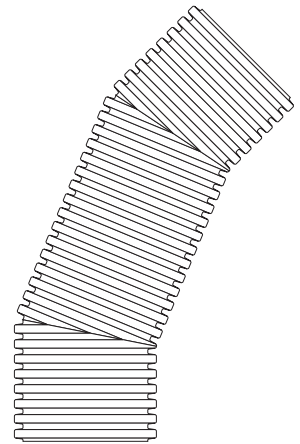

## N-12 Fabricated 90° Bends (Three-Miter)

Part #	Pipe Size
1299AN	12"
1599AN	15"
1899AN	18"

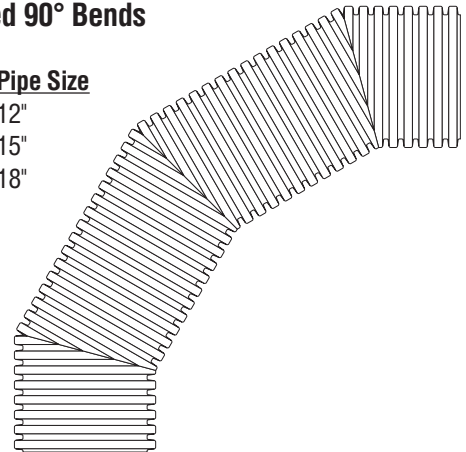

**Yarmouth Tee & Bend**

Part #	Size
1206ANY	12" Tee
1506ANY	15" Tee
1806ANY	18" Tee
1200ANY	12" Bend
1500ANY	15" Bend
1800ANY	18" Bend

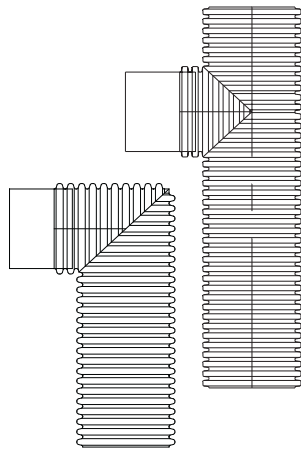

**NHDOT PE Catch Basin Liner**

Part #	Description
2012AN	Catch Basin Liner

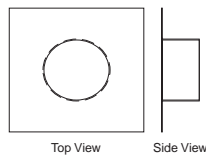

**Standard Fabricated Stubs**

Part #	Pipe Size
0406AN	4"
0606AN	6"
0806AN	8"
1006AN	10"
1206AN	12"
1506AN	15"
1806AN	18"
2406AN	24"

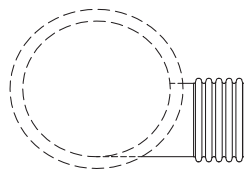

**N-12 IB Joint Pusher**

Part #	Pipe Size
1208AN	12"
1508AN	15"
1808AN	18"
2408AN	24"
3008AN	30"
3608AN	36"
4208AN	42"
4808AN	48"
6008AN	60"

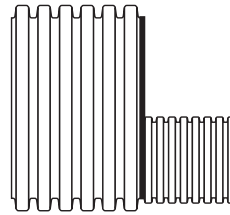
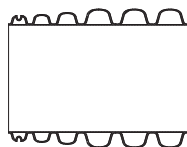

**N-12 FABRICATED REDUCERS**

Part #	Pipe Size
1570AN	15" x 4"
1571AN	15" x 6"
1572AN	15" x 8"
1573AN	15" x 10"
1574AN	15" x 12"

Part #	Pipe Size
1870AN	18" x 4"
1871AN	18" x 6"
1872AN	18" x 8"
1873AN	18" x 10"
1874AN	18" x 12"
1875AN	18" x 15"

Part #	Pipe Size
2470AN	24" x 4"
2471AN	24" x 6"
2472AN	24" x 8"
2473AN	24" x 10"
2474AN	24" x 12"
2475AN	24" x 15"
2476AN	24" x 18"

Part #	Pipe Size
3070AN	30" x 4"
3071AN	30" x 6"
3072AN	30" x 8"
3073AN	30" x 10"
3074AN	30" x 12"
3075AN	30" x 15"
3076AN	30" x 18"
3077AN	30" x 24"

Part #	Pipe Size
3670AN	36" x 4"
3671AN	36" x 6"
3672AN	36" x 8"
3673AN	36" x 10"
3674AN	36" x 12"
3675AN	36" x 15"
3676AN	36" x 18"
3677AN	36" x 24"
3678AN	36" x 30"

Part #	Pipe Size
4270AN	42" x 4"
4271AN	42" x 6"
4272AN	42" x 8"
4273AN	42" x 10"
4274AN	42" x 12"
4275AN	42" x 15"
4276AN	42" x 18"
4277AN	42" x 24"
4278AN	42" x 30"
4279AN	42" x 36"

Part #	Pipe Size
4870AN	48" x 4"
4871AN	48" x 6"
4872AN	48" x 8"
4873AN	48" x 10"
4874AN	48" x 12"
4875AN	48" x 15"
4876AN	48" x 18"
4877AN	48" x 24"
4878AN	48" x 30"
4879AN	48" x 36"
4842AN	48" x 42"

Part #	Pipe Size
6070AN	60" x 4"
6071AN	60" x 6"
6072AN	60" x 8"
6073AN	60" x 10"
6074AN	60" x 12"
6075AN	60" x 15"
6076AN	60" x 18"
6077AN	60" x 24"
6078AN	60" x 30"
6079AN	60" x 36"
6042AN	60" x 42"
6042AN	60" x 42"
6048AN	60" x 48"





# ADS a ricated es

These fabricated fittings are also available "plain end" as shown, "bell/spigot end" and "bell/bell end".

## N-12 FABRICATED 45° WYES

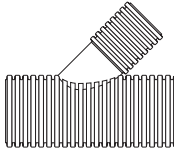

Part #	Pipe Size
1283AN	12" x 10"

Part #	Pipe Size
1580AN	15" x 4"
1581AN	15" x 6"
1582AN	15" x 8"
1583AN	15" x 10"
1584AN	15" x 12"
1585AN	15" x 15"

Part #	Pipe Size
1880AN	18" x 4"
1881AN	18" x 6"
1882AN	18" x 8"
1883AN	18" x 10"
1884AN	18" x 12"
1885AN	18" x 15"
1886AN	18" x 18"

Part #	Pipe Size
2480AN	24" x 4"
2481AN	24" x 6"
2483AN	24" x 10"
2484AN	24" x 12"

Part #	Pipe Size
3080AN	30" x 4"
3081AN	30" x 6"
3082AN	30" x 8"
3083AN	30" x 10"
3084AN	30" x 12"
3085AN	30" x 15"

Part #	Pipe Size
3680AN	36" x 4"
3681AN	36" x 6"
3682AN	36" x 8"
3683AN	36" x 10"
3684AN	36" x 12"
3685AN	36" x 15"
3686AN	36" x 18"

Part #	Pipe Size
4280AN	42" x 4"
4281AN	42" x 6"
4282AN	42" x 8"
4283AN	42" x 10"
4284AN	42" x 12"
4285AN	42" x 15"
4286AN	42" x 18"

Part #	Pipe Size
4880AN	48" x 4"
4881AN	48" x 6"
4882AN	48" x 8"
4883AN	48" x 10"
4884AN	48" x 12"
4885AN	48" x 15"
4886AN	48" x 18"
4887AN	48" x 24"

Part #	Pipe Size
6080AN	60" x 4"
6081AN	60" x 6"
6082AN	60" x 8"
6083AN	60" x 10"
6084AN	60" x 12"
6085AN	60" x 15"
6086AN	60" x 18"
6087AN	60" x 24"

These fabricated fittings are also available "plain end" as shown, "bell/spigot end" and "bell/bell end".

## N-12 FABRICATED 60° WYES

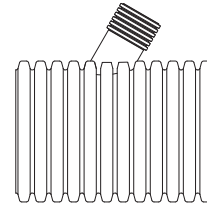

Part #	Pipe Size
1880AN60	18" x 4"
1881AN60	18" x 6"
1882AN60	18" x 8"
1883AN60	18" x 10"
1884AN60	18" x 12"
1885AN60	18" x 15"
1886AN60	18" x 18"

Part #	Pipe Size
2480AN60	24" x 4"
2481AN60	24" x 6"
2482AN60	24" x 8"
2483AN60	24" x 10"
2484AN60	24" x 12"
2485AN60	24" x 15"
2486AN60	24" x 18"
2487AN60	24" x 24"

Part #	Pipe Size
3080AN60	30" x 4"
3081AN60	30" x 6"
3082AN60	30" x 8"
3083AN60	30" x 10"
3084AN60	30" x 12"
3085AN60	30" x 15"
3086AN60	30" x 18"
3087AN60	30" x 24"

Part #	Pipe Size
3680AN60	36" x 4"
3681AN60	36" x 6"
3682AN60	36" x 8"
3683AN60	36" x 10"
3684AN60	36" x 12"
3685AN60	36" x 15"
3686AN60	36" x 18"
3687AN60	36" x 24"

Part #	Pipe Size
4280AN60	42" x 4"
4281AN60	42" x 6"
4282AN60	42" x 8"
4283AN60	42" x 10"
4284AN60	42" x 12"
4285AN60	42" x 15"
4286AN60	42" x 18"
4287AN60	42" x 24"

Part #	Pipe Size
4880AN60	48" x 4"
4881AN60	48" x 6"
4882AN60	48" x 8"
4883AN60	48" x 10"
4884AN60	48" x 12"
4885AN60	48" x 15"
4886AN60	48" x 18"
4887AN60	48" x 24"

Part #	Pipe Size
6080AN60	60" x 4"
6081AN60	60" x 6"
6082AN60	60" x 8"
6083AN60	60" x 10"
6084AN60	60" x 12"
6085AN60	60" x 15"
6086AN60	60" x 18"
6087AN60	60" x 24"

## N-12 FABRICATED TEES

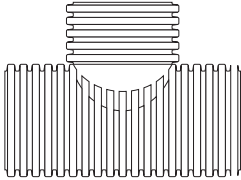

Part #	Pipe Size
1560AN	15" x 4"
1561AN	15" x 6"
1562AN	15" x 8"
1563AN	15" x 10"
1564AN	15" x 12"
1565AN	15" x 15"

Part #	Pipe Size
1860AN	18" x 4"
1861AN	18" x 6"
1862AN	18" x 8"
1863AN	18" x 10"
1864AN	18" x 12"
1865AN	18" x 15"
1866AN	18" x 18"

Part #	Pipe Size
2460AN	24" x 4"
2461AN	24" x 6"
2462AN	24" x 8"
2463AN	24" x 10"
2464AN	24" x 12"
2465AN	24" x 15"
2466AN	24" x 18"
2467AN	24" x 24"

Part #	Pipe Size
3060AN	30" x 4"
3061AN	30" x 6"
3062AN	30" x 8"
3063AN	30" x 10"
3064AN	30" x 12"
3065AN	30" x 15"
3066AN	30" x 18"
3067AN	30" x 24"
3068AN	30" x 30"

Part #	Pipe Size
3660AN	36" x 4"
3661AN	36" x 6"
3662AN	36" x 8"
3663AN	36" x 10"
3664AN	36" x 12"
3665AN	36" x 15"
3666AN	36" x 18"
3667AN	36" x 24"
3668AN	36" x 30"
3669AN	36" x 36"

Part #	Pipe Size
4260AN	42" x 4"
4261AN	42" x 6"
4262AN	42" x 8"
4263AN	42" x 10"
4264AN	42" x 12"
4265AN	42" x 15"
4266AN	42" x 18"
4267AN	42" x 24"
4268AN	42" x 30"
4269AN	42" x 36"

Part #	Pipe Size
4860AN	48" x 4"
4861AN	48" x 6"
4862AN	48" x 8"
4863AN	48" x 10"
4864AN	48" x 12"
4865AN	48" x 15"
4866AN	48" x 18"
4867AN	48" x 24"
4868AN	48" x 30"
4869AN	48" x 36"
4840AN	48" x 42"

Part #	Pipe Size
6060AN	60" x 4"
6061AN	60" x 6"
6062AN	60" x 8"
6063AN	60" x 10"
6064AN	60" x 12"
6065AN	60" x 15"
6066AN	60" x 18"
6067AN	60" x 24"
6068AN	60" x 30"
6069AN	60" x 36"
6040AN	60" x 42"
6041AN	60" x 48"
6051AN	60" x 60"

## N-12 FABRICATED SADDLE TEES

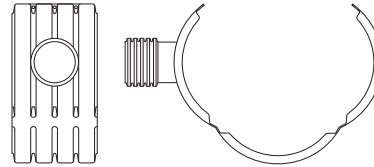

Part #	Pipe Size
0840AN	8" x 4"
0841AN	8" x 6"

Part #	Pipe Size
1040AN	10" x 4"
1041AN	10" x 6"
1042AN	10" x 8"

Part #	Pipe Size
1240AN	12" x 4"
1241AN	12" x 6"
1242AN	12" x 8"
1243AN	12" x 10"

Part #	Pipe Size
1540AN	15" x 4"
1541AN	15" x 6"
1542AN	15" x 8"
1543AN	15" x 10"
1544AN	15" x 12"

Part #	Pipe Size
1840AN	18" x 4"
1841AN	18" x 6"
1842AN	18" x 8"
1843AN	18" x 10"
1844AN	18" x 12"
1845AN	18" x 15"

Part #	Pipe Size
2440AN	24" x 4"
2441AN	24" x 6"
2442AN	24" x 8"
2443AN	24" x 10"
2444AN	24" x 12"
2445AN	24" x 15"
2446AN	24" x 18"

Part #	Pipe Size
3040AN	30" x 4"
3041AN	30" x 6"
3042AN	30" x 8"
3043AN	30" x 10"
3044AN	30" x 12"
3045AN	30" x 15"
3046AN	30" x 18"
3047AN	30" x 24"

Part #	Pipe Size
3640AN	36" x 4"
3641AN	36" x 6"
3642AN	36" x 8"
3643AN	36" x 10"
3644AN	36" x 12"
3645AN	36" x 15"
3646AN	36" x 18"
3647AN	36" x 24"
3648AN	36" x 30"

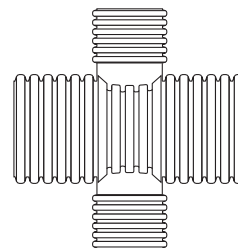

Part #	Pipe Size
0430AN	4" x 4"

Part #	Pipe Size
0630AN	6" x 4"
0631AN	6" x 6"

Part #	Pipe Size
0830AN	8" x 4"
0831AN	8" x 6"
0832AN	8" x 8"

## N-12 FABRICATED CROSS TEES

Part #	Pipe Size
1030AN	10" x 4"
1031AN	10" x 6"
1032AN	10" x 8"
1033AN	10" x 10"

Part #	Pipe Size
1230AN	12" x 4"
1231AN	12" x 6"
1232AN	12" x 8"
1233AN	12" x 10"
1234AN	12" x 12"

**Double Bell Field Coupler**

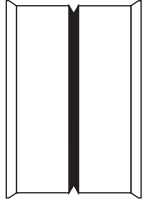

Part #	Pipe Size
3013AN	30"
3613AN	36"
4213AN	42"
4813AN	48"
6013AN	60"

**Mitered Bell/Bell Couplers  
(3 degree and 5 degree)**

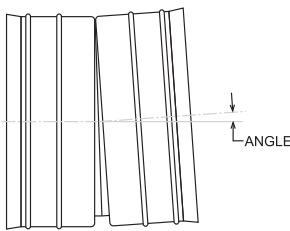

Part #	Pipe Size	Description
1213ANMC03	12"	12" – 3° Mitered Coupler
1213ANMC05	12"	12" – 5° Mitered Coupler
1513ANMC03	15"	15" – 3° Mitered Coupler
1513ANMC05	15"	15" – 5° Mitered Coupler
1813ANMC03	18"	18" – 3° Mitered Coupler
1813ANMC05	18"	18" – 5° Mitered Coupler
2413ANMC03	24"	24" – 3° Mitered Coupler
2413ANMC05	24"	24" – 5° Mitered Coupler
3013ANMC03	30"	30" – 3° Mitered Coupler
3013ANMC05	30"	30" – 5° Mitered Coupler
3613ANMC03	36"	36" – 3° Mitered Coupler
3613ANMC05	36"	36" – 5° Mitered Coupler
4213AN65MC03	42"	42" – 3° Mitered Coupler
4213AN65MC05	42"	42" – 5° Mitered Coupler
4813AN65MC03	48"	48" – 3° Mitered Coupler
4813AN65MC05	48"	48" – 5° Mitered Coupler
6013AN65MC03	60"	60" – 3° Mitered Coupler
6013AN65MC05	60"	60" – 5° Mitered Coupler

**N-12 Concrete Adapter Fitting**

Part #	Pipe Size
1221AN	12"
1521AN	15"
1821AN	18"
2421AN	24"
3021AN	30"
3621AN	36"
4221AN	42"
4821AN	48"

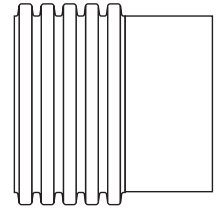

**N-12 to RCP Manhold Adapter**

Part #	Pipe Size	Description
1222AN	12"	12" Adapter with Gasket
1522AN	15"	15" Adapter with Gasket
1822AN	18"	18" Adapter with Gasket
2422AN	24"	24" Adapter with Gasket
3022AN	30"	30" Adapter with Gasket
3622AN	36"	36" Adapter with Gasket
4222AN	42"	42" Adapter with Gasket
4822AN	48"	48" Adapter with Gasket
6022AN	60"	60" Adapter with Gasket

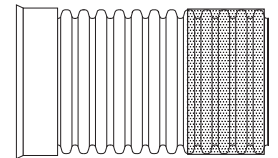

Part #	Pipe Size	Description
1222ANB	12"	12" Adapter with Bell
1522ANB	15"	15" Adapter with Bell
1822ANB	18"	18" Adapter with Bell
2422ANB	24"	24" Adapter with Bell
3022ANB	30"	30" Adapter with Bell
3622ANB	36"	36" Adapter with Bell
4222ANB	42"	42" Adapter with Bell
4822ANB	48"	48" Adapter with Bell
6022ANB	60"	60" Adapter with Bell

**Mitered and Sections**

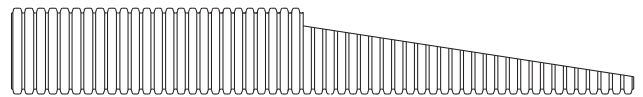

Part #	Pipe Size	Length (varies)
1270NM	12"	3' - 6'
1570NM	15"	6' - 9'
1870NM	18"	6' - 11'
2470NM	24"	7' - 13'

**N-12 Fabricated End Caps**

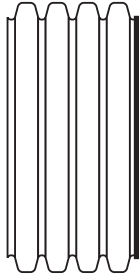

AN

Part #	Pipe Size
1201AN	12"
1501AN	15"
1801AN	18"
2401AN	24"
3001AN	30"
3601AN	36"
4201AN	42"
4801AN	48"
6001AN	60"

**N-12 Fabricated End Caps**



AN65G

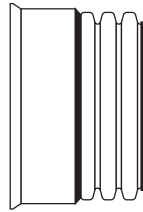

AN65B

Part #	Pipe Size
1201AN65G	12"
1501AN65G	15"
1801AN65G	18"
2401AN65G	24"
3001AN65G	30"
3601AN65G	36"
1201AN65B	12"
1501AN65B	15"
1801AN65B	18"
2401AN65B	24"
3001AN65B	30"
3601AN65B	36"
4201AN65B	42"
4801AN65B	48"
6001AN65B	60"

**N-12 Manifold 45° Bends**

Part #	Pipe Size
1297AN	12"
1597AN	15"
1897AN	18"
2497AN	24"
3097AN	30"
3697AN	36"
4297AN	42"
4897AN	48"
6097AN	60"

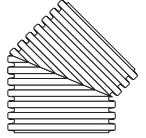

**N-12 Manifold 90° Bends**

Part #	Pipe Size
1298AN	12"
1598AN	15"
1898AN	18"
2498AN	24"
3098AN	30"
3698AN	36"
4298AN	42"
4898AN	48"
6098AN	60"

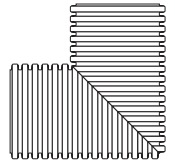

**N-12 Manifold Tees**

Part #	Pipe Size
1251AN	12"
1551AN	15"
1851AN	18"
2451AN	24"
3051AN	30"
3651AN	36"
4251AN	42"
4851AN	48"
6051AN	60"

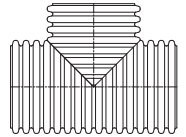

**N-12 Manifold Components (Double)**

Part #	Pipe Size
1252AN	12"
1552AN	15"
1852AN	18"
2452AN	24"
3052AN	30"
3652AN	36"
4252AN	42"
4852AN	48"
6052AN	60"

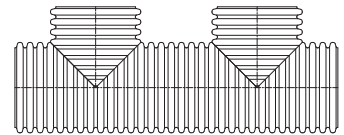

**N-12 Manifold Components (Triple)**

Part #	Pipe Size
1253AN	12"
1553AN	15"
1853AN	18"
2453AN	24"
3053AN	30"
3653AN	36"

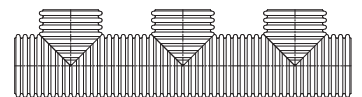



**Manifold Subcomponents – Manifold Cleanouts**

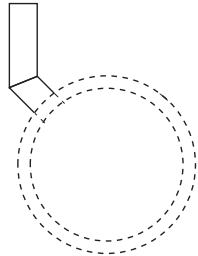

<u>Part #</u>	<u>Pipe Size</u>
0402AN	4"
0602AN	6"
0802AN	8"

**Manifold Subcomponents – Manifold Inlet Riser**

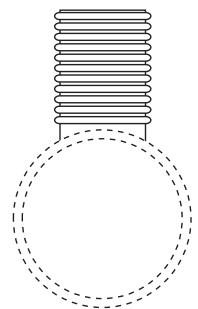

<u>Part #</u>	<u>Pipe Size (D)</u>
2403AN	24"

Drawing Required when ordering subcomponents.  
Cannot be sold separately.

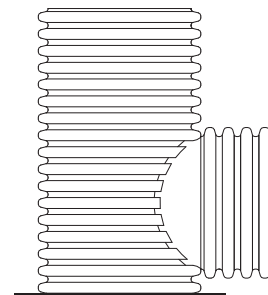

<u>Part #</u>	<u>Pipe Size</u>	<u>Riser</u>	<u>Part #</u>	<u>Pipe Size</u>	<u>End Stub</u>
1204AN	12"	4' Riser	0805AN	8"	Plain
1207AN	12"	7' Riser	0805ANG	8"	Gasket
1210AN	12"	10' Riser	0805ANB	8"	Bell
1504AN	15"	4' Riser	1005AN	10"	Plain
1507AN	15"	7' Riser	1005ANG	10"	Gasket
1510AN	15"	10' Riser	1005ANB	10"	Bell
1804AN	18"	4' Riser	1205AN	12"	Plain
1807AN	18"	7' Riser	1205ANG	12"	Gasket
1810AN	18"	10' Riser	1205ANB	12"	Bell
2404AN	24"	4' Riser	1505AN	15"	Plain
2407AN	24"	7' Riser	1505ANG	15"	Gasket
2410AN	24"	10' Riser	1505ANB	15"	Bell
3004AN	30"	4' Riser	1805AN	18"	Plain
3007AN	30"	7' Riser	1805ANG	18"	Gasket
3010AN	30"	10' Riser	1805ANB	18"	Bell
3604AN	36"	4' Riser	2405AN	24"	Plain
3607AN	36"	7' Riser	2405ANG	24"	Gasket
3610AN	36"	10' Riser	2405ANB	24"	Bell
4204AN	42"	4' Riser	3005AN	30"	Plain
4207AN	42"	7' Riser	3005ANG	30"	Gasket
4210AN	42"	10' Riser	3005ANB	30"	Bell
4804AN	48"	4' Riser	3605AN	36"	Plain
4807AN	48"	7' Riser	3605ANG	36"	Gasket
4810AN	48"	10' Riser	3605ANB	36"	Bell
		<u>End Stub</u>			<u>Bottom Plate</u>
0405AN	4"	Plain	1211AN	12"	12"
0405ANG	4"	Gasket	1511AN	15"	15"
0405ANB	4"	Bell	1811AN	18"	18"
0605AN	6"	Plain	2411AN	24"	24"
0605ANG	6"	Gasket	3011AN	30"	30"
0605ANB	6"	Bell	3611AN	36"	36"
			4211AN	42"	42"
			4811AN	48"	48"

atc asin

**N-12 Rear Yard Catch Basin with two 4" tap tee connections**

<u>Part #</u>	<u>Pipe Size</u>
1202AN04	12"

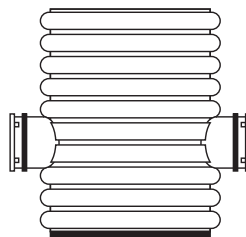

io Di ser  
r c load  
antities



io Di sers  
Leac in  
a ers

<u>Bio-Diffuser Chamber Size</u>	<u>Pallet Quantity</u>	<u>Truckload Quantity</u>
11"	27	39 Pallets with End Caps
11"		39 Pallets without End Caps
13" ARC36™	60	25 Pallets with End Caps on Van
13" ARC36™		22 Pallets with End Caps on Flat Bed
14"	38	19 Pallets with End Caps
14"		21 Pallets without End Caps
15"	90	12 Pallets with End Caps
15"		14 Pallets without End Caps
16"	45	19 Pallets with End Caps
16"		21 Pallets without End Caps
22"	70	12 Pallets with End Caps
22"		14 Pallets without End Caps



<u>Part #</u>	<u>Size</u>	<u>Description</u>	<u>Pallet Quantity</u>
3613BD	13"	ARC36™ Chamber	60
3603BD	13"	ARC36™ End Cap	75/Box 25/Bag
1100BD	11"	Bio-Diffuser Chamber	27
1101BD	11"	Bio-Diffuser End Cap	175/Box
1122BD	11"	Bio-Diffuser Angle Section	54/Box
1400BD	14"	Bio-Diffuser Chamber	38
1401BD	14"	Bio-Diffuser End Cap	100/Box
1600BD	16"	Bio-Diffuser Chamber	45
1601BD	16"	Bio-Diffuser End Cap	75/Box
1622BD	16"	Bio-Diffuser Angle Section	45/Box
1500BD	15"	Bio-Diffuser Chamber	90
1501BD	15"-22"	Bio-Diffuser End Cap	175/Box
1522BD	15"	Bio-Diffuser Angle Section	45/Box
2200BD	22"	Bio-Diffuser Chamber	70
1501BD	15"-22"	Bio-Diffuser End Cap	175/Box
0068BD	6" x 8"	Splash Plate	
0491AA		Septic Pipe Filter w/Pipe Adapter	10/Box
0492AA		Septic Pipe Filter w/Flush Adapter	10/Box

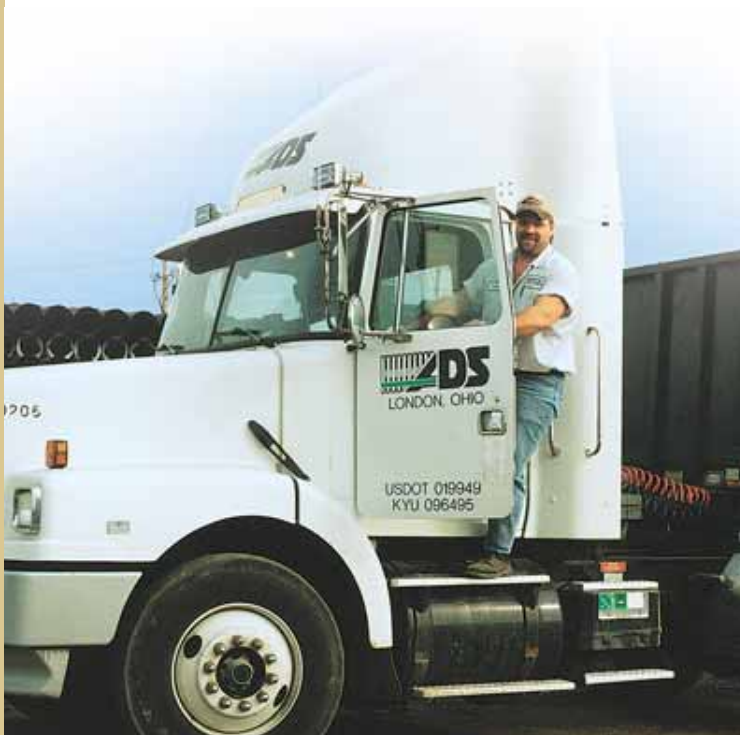



# Lite Series and Applications



### MPS9

2 Bundles of 04700030  
to  
1 Bundle of 04710030

### Bundle Configuration

3 Sticks of 04700010  
2 Sticks of 04700010  
1 Stick of 04710010

Note: The 04700030 is Void Pipe and 04710010 is the distribution pipe

### MPS11

2 Bundles of 04700050  
to  
1 Stick of 04710030

### Bundle Configuration

5 Sticks of 04700010  
1 Stick of 04710010

Note: The 04700050 is Void Pipe and 04710010 is the distribution pipe

### MPS13

2 Bundles of 04700050  
to  
1 Bundle of 04710030

### Bundle Configuration

5 Sticks of 04700010  
2 Sticks of 04700010  
1 Stick of 04710010

Note: The 04700050 is Void Pipe and the 04710030 is the distribution pipe

\* Limited Geographically





oad  
Str ct res



lo last ADS  
r nlet  
Str ct res



## Stor Drainage Str ct res

oad i a Str ct res  
r nlet Str ct res  
Drain asins nline Drains  
Dro n rates rate tions

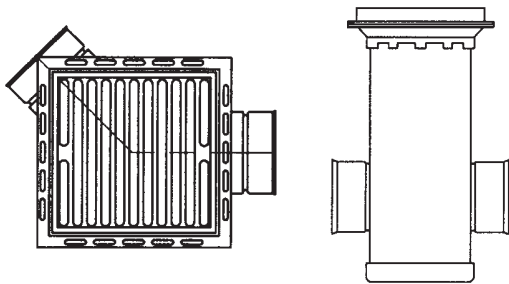
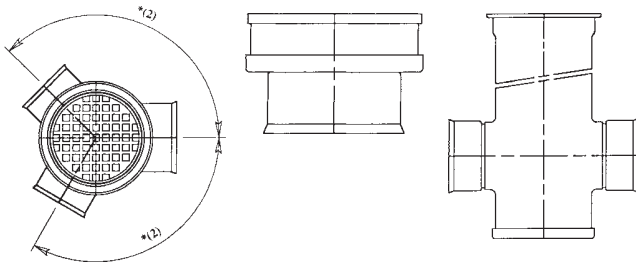

Part #	Structure	Grate Dimensions
3212AGS	12"	2' x 2'
3215AGS	15"	2' x 2'
3218AGS	18"	2' x 2'
3218AGS	18"	2' x 3'
3224AGS	24"	2' x 2'
3224AGS	24"	2' x 3'
3230AGS	30"	2' x 2'
3230AGS	30"	2' x 3'

Road & Highway Structures are not stocked.  
5-10 day lead times are required for product delivery.

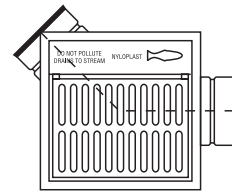

### Grate Options

#### 2' x 2' Grate Options



Standard  
H-25



Diagonal  
H-25

#### 2' x 3' Grate Options



Diagonal  
H-25



High Flow  
Vane  
H-25

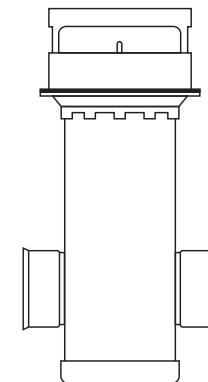

Part #	Structure	Grate Dimensions
3012AGS	12"	2' x 2'
3015AGS	15"	2' x 2'
3018AGS	18"	2' x 2'
3018AGR	18"	2' x 3'
3024AGS	24"	2' x 2'
3024AGR	24"	2' x 3'
3030AGS	30"	2' x 2'
3030AGR	30"	2' x 3'

Curb Inlet Structures are not stocked.  
5-10 day lead times are required for product delivery.

## lo last ADS Drain asins

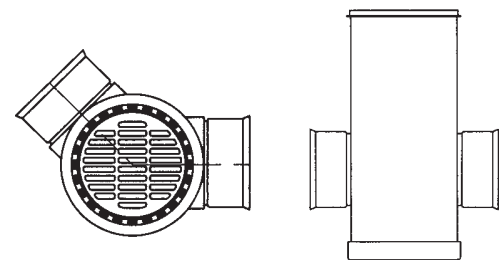

Part #	Structure	Stub Dimensions*
2808AG	8"	4" thru 8"
2810AG	10"	4" thru 10"
2812AG	12"	4" thru 12"
2815AG	15"	4" thru 15"
2818AG	18"	4" thru 18"
2824AG	24"	4" thru 24"
2830AG	30"	4" thru 30"

Drain Basin Structures are not stocked.  
5-10 day lead times are required for product delivery.

\*Stub dimensions may be effected by stub angles



# ADS Line Drains



# ADS Line Drains

(Locking option is available for all grates)

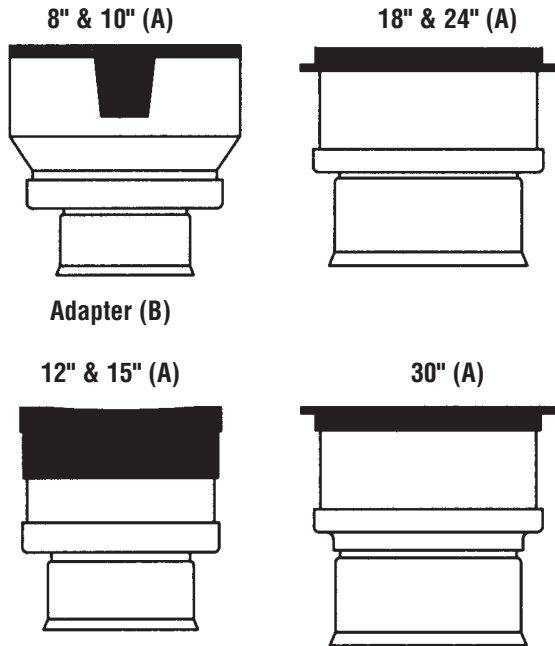

Part #	Drain Basin	Adapts to Pipe Dia.
2708AG	8"	4", 6"
2710AG	10"	4", 6", 8"
2712AG	12"	4", 6", 8", 10", 12"
2715AG	15"	4", 6", 8", 10", 12", 15"
2718AG	18"	4", 6", 8", 10", 12", 15", 18"
2724AG	24"	4", 6", 8", 10", 12", 15", 18", 24"
2730AG	30"	4", 6", 8", 10", 12", 15", 18", 24", 30"

3-7 day lead times are required for product delivery.



**Dome Light-Duty**  
8" - 0899CGD  
10" - 1099CGD



**Standard H-25**  
18" - 1899CGS



**Standard Light-Duty**  
8" - 0899CGS  
10" - 1099CGS  
**Light-Duty Bronze**  
8" - 0899CGB  
10" - 1099CGB



**Solid H-25**  
18" - 1899CGS  
25" - 2499CGS



**Solid Light-Duty**  
8" - 0899CGC  
10" - 1099CGC



**Pedestrian H-10**  
18" - 1899CGP



**Standard H-25**  
12" - 1299CGS  
15" - 1599CGS  
Hinged Design



**Standard H-25**  
24" - 2499CGS



**Pedestrian H-10**  
12" - 1299CGP  
15" - 1599CGP  
Hinged Design



**Pedestrian H-10**  
24" - 2499CGP



**Bronze Pedestrian Light-Duty**  
12" - 1299CGPB  
15" - 1599CGPB



**Standard H-25**  
30" - 3099CGS

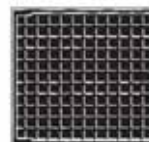

**Solid H-25**  
12" - 1299CGC  
15" - 1599CGC  
Hinged Design



**Solid H-25**  
30" - 3099CGC

rates  
to it ADS i e



rates  
to it ADS i e

**Round Grates - Steel (Black or Green) Non-Traffic**

Part #	Size
0401SG	4"
0601SG	6"
0801SG	8"
1001SG	10"
1201SG	12"
1501SG	15"
1801SG	18"
2401SG	24"
3001SG	30"
3601SG	36"
4201SG	42"
4801SG	48"

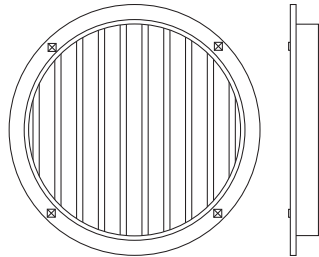

**Round Grates - Cast Iron Non-Traffic**

Part #	Size
0601CG	6"
0801CG	8"
1001CG	10"
1201CG	12"
1501CG	15"
1801CG	18"
2401CG	24"
3001CG	30"



**Nyloplast-ADS Drop-in Grates**

(Fits inside ADS N-12 pipe, SDR 35 pipe and IPS SCH 40 pipe) Light-Duty

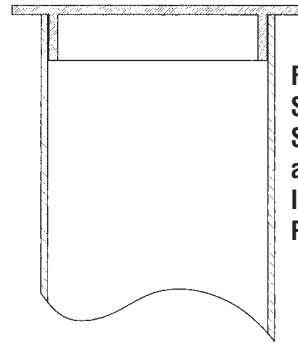

Fits Inside  
Sewer  
SDR 35 Pipe  
and  
IPS SCH 40  
Pipe

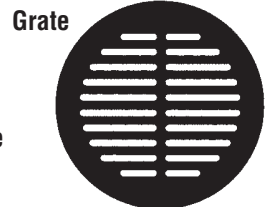

Fits Inside  
ADS N-12 Pipe

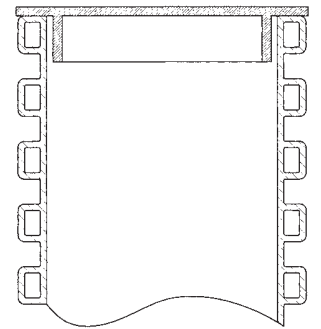

Part #	Drop-In Grate
0601DI	6"
0801DI	8"
1001DI	10"
1201DI	12"
1501DI	15"
1801DI	18"
2401DI	24"



**THE MOST  
ADVANCED  
NAME IN  
DRAINAGE  
SYSTEMS®**





# ADS Standard geotextile tiles

## Geotextile Applications



### ADS Geosynthetics Lightweight Nonwoven

Product #	Weight	W x L	SY/Roll
0311TG	3 oz.	150" x 360'	500
0311TS	3 oz.	180" x 360'	600
0351TC	3.5 oz.	24" x 360'	80
0351TA	3.5 oz.	36" x 360'	120
0351TB	3.5 oz.	48" x 360'	160
0351TT	3.5 oz.	90" x 360'	300
0351TG	3.5 oz.	150" x 360'	500
0351TS	3.5 oz.	180" x 360'	600
0401TT	4.0 oz.	90" x 360'	300
0401TG	4.0 oz.	150" x 360'	500
0401TS	4.0 oz.	180" x 360'	600
0451TG	4.5 oz.	150" x 360'	500
0451TS	4.5 oz.	180" x 360'	600

### Medium Weight Nonwoven

Product #	Weight	W x L	SY/Roll
0601TG	6 oz.	150" x 360'	500
0601TS	6 oz.	180" x 300'	500
0701TE	7 oz.	72" x 360'	240
0701TG	7 oz.	150" x 360'	500
0701TS	7 oz.	180" x 300'	500
0801TG	8 oz.	150" x 360'	500
0801TS	8 oz.	180" x 300'	500

### Heavy Weight Nonwoven

Product #	Weight	W x L	SY/Roll
1001TS	10 oz.	180" x 300'	500
1201TS	12 oz.	180" x 300'	500
1601TS	16 oz.	180" x 300'	500

### Typar® (Nonwoven - Spunbonded)

**SYR** Note: Fabric has a Smooth Surface and Slick Appearance

Product #	Weight	W x L	SY/Roll
3151TA	1.5 oz	36" x 300'	100
3151TB	1.5 oz	48" x 300'	133
3151TE	1.5 oz	75" x 300'	208
3151TG	1.5 oz	151" x 300'	420
3201TE	2.0 oz	6.5" x 300'	208
3201TA	2.0 oz	36" x 300'	100
3201TB	2.0 oz	48" x 300'	133
3201TG	2.0 oz	151" x 300'	420
3341TG	3.5 oz	151" x 300'	420
3401TG	4.0 oz	151" x 300'	420
3401TH	4.0 oz	187" x 300'	520
3601TG	6.0 oz	151" x 300'	420
3601TH	6.0 oz	187" x 300'	520

### SEPTIC FABRIC

Product #	Weight	W x L
2624RB	0.5 oz	24" x 300'
2636RB	0.5 oz	36" x 300'
2724RB	0.5 oz	24" x 1500'
2736RB	0.5 oz	36" x 1500'
2748RB	0.5 oz	48" x 1500'
2760RB	0.5 oz	60" x 1500'
2772RB	0.5 oz	72" x 1500'

### SEPTIC FABRIC (TX)

Product #	Weight	W x L
2824RB	0.7 oz	24" x 300'
2836RB	0.7 oz	36" x 300'
2924RB	0.7 oz	24" x 1500'
2936RB	0.7 oz	36" x 1500'
2948RB	0.7 oz	48" x 1500'
2972RB	0.7 oz	72" x 1500'



ADS Standard  
note tiles



rosion control  
a rics

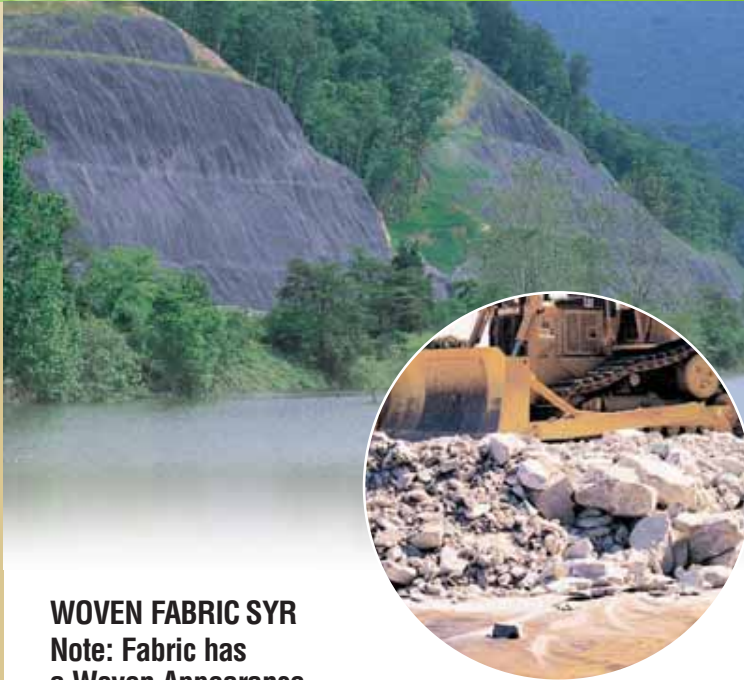

**WOVEN FABRIC SYR**  
Note: Fabric has  
a Woven Appearance  
Stabilization - Woven

Product #	Grab Tensile	W x L	SY/Roll
135WTK	135	150" x 432'	600
200WTK	200	150" x 432'	600
200WTS	200	180" x 360'	600
200WTM	200	210" x 309'	600
315WTK	315	150" x 360'	500
315WTM	315	210" x 257'	500

**Monofilament - Woven**

Product #	W x L	SY/Roll
104FTE	72" x 300'	200
104FTK	144" x 300'	400

**Medium Strength - Woven**

Product #	W x L	SY/Roll
02x2TK	180" x 300'	500
04x4TK	180" x 300'	500

**GEOGRID**

Product #	W x L	SY/Roll
2020GG	187" x 328'	568

**SILT FENCE**

Product #	Description
3301WE	24" x 100' rolls with 13 hardwood stakes per roll
3302WE	36" x 100' rolls with 13 hardwood stakes per roll
3302WP	Premium Silt Fence - AASHTO 36" x 100'

**FABRIC PINS**

Product #	Size	
3206TP	6"	1000/box
3212TP	12"	100/box

**Erosion Control Blankets (ECB) - Biodegradable**

Product #	W x L	SY/Roll
00S1TT	7.5' x 120'	100
00S2TT	7.5' x 120'	100
0CS2TT	7.5' x 120'	100
00C2TT	7.5' x 120'	100

**Turf Reinforcement Mat (TRM) - Permanent**

Product #	Size	SY/Roll
435GTR	6.5' x 138.5'	100
450GTR	6.5' x 138.5'	100
1060GTR	6.5' x 138.5'	100

**rain Aire Screen**

**GRAIN-AIRE SCREEN**

Product #	Pipe Size
1284HA	12"
1584HA	15"
1884HA	18"
2484HA	24"

To order Grain-Aire pipe w/Screen, see page 2.



**ADS Soc Drain ard**

**SOCK**

3" - 24" sizes available



**DRAIN GUARD®**

XX35AA Pipe Series\*

\* Limited geographically



inserta ee  
ittin s  
ADS into



inserta ee  
ittin s  
SD into

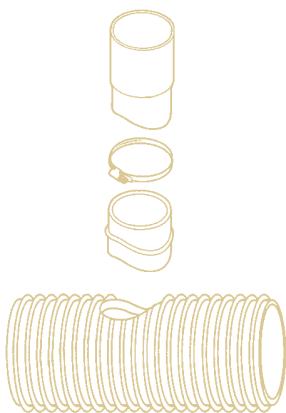

Part #	Description
0840AG	4" N-12 into 8" N-12
1040AG	4" N-12 into 10" N-12
1240AG	4" N-12 into 12" N-12
1540AG	4" N-12 into 15" N-12
1840AG	4" N-12 into 18" N-12
2440AG	4" N-12 into 24" N-12
3040AG	4" N-12 into 30" N-12
3640AG	4" N-12 into 36" N-12
4240AG	4" N-12 into 42" N-12
4840AG	4" N-12 into 48" N-12
6040AG	4" N-12 into 60" N-12

Part #	Description
1041AG	6" N-12 into 10" N-12
1241AG	6" N-12 into 12" N-12
1541AG	6" N-12 into 15" N-12
1841AG	6" N-12 into 18" N-12
2441AG	6" N-12 into 24" N-12
3041AG	6" N-12 into 30" N-12
3641AG	6" N-12 into 36" N-12
4241AG	6" N-12 into 42" N-12
4841AG	6" N-12 into 48" N-12
6041AG	6" N-12 into 60" N-12

Part #	Description
1242AG	8" N-12 into 12" N-12
1542AG	8" N-12 into 15" N-12
1842AG	8" N-12 into 18" N-12
2442AG	8" N-12 into 24" N-12
3042AG	8" N-12 into 30" N-12
3642AG	8" N-12 into 36" N-12
4242AG	8" N-12 into 42" N-12

4842AG	8" N-12 into 48" N-12
6042AG	8" N-12 into 60" N-12

Part #	Description
1543AG	10" N-12 into 15" N-12
1843AG	10" N-12 into 18" N-12
2443AG	10" N-12 into 24" N-12
3043AG	10" N-12 into 30" N-12
3643AG	10" N-12 into 36" N-12
4243AG	10" N-12 into 42" N-12
4843AG	10" N-12 into 48" N-12
6043AG	10" N-12 into 60" N-12

Part #	Description
1844AG	12" N-12 into 18" N-12
2444AG	12" N-12 into 24" N-12
3044AG	12" N-12 into 30" N-12
3644AG	12" N-12 into 36" N-12
4244AG	12" N-12 into 42" N-12
4844AG	12" N-12 into 48" N-12
6044AG	12" N-12 into 60" N-12

Part #	Description
2446AG	15" N-12 into 24" N-12
3046AG	15" N-12 into 30" N-12
3646AG	15" N-12 into 36" N-12
4246AG	15" N-12 into 42" N-12
4846AG	15" N-12 into 48" N-12
6046AG	15" N-12 into 60" N-12

Part #	Description	Part #	Description
1051AG	6" SDR35 into 10" N-12	1553AG	10" SDR35 into 15" N-12
1251AG	6" SDR35 into 12" N-12	1853AG	10" SDR35 into 18" N-12
1551AG	6" SDR35 into 15" N-12	2453AG	10" SDR35 into 24" N-12
1851AG	6" SDR35 into 18" N-12	3053AG	10" SDR35 into 30" N-12
2451AG	6" SDR35 into 24" N-12	3653AG	10" SDR35 into 36" N-12
3051AG	6" SDR35 into 30" N-12	4253AG	10" SDR35 into 42" N-12
3651AG	6" SDR35 into 36" N-12	4853AG	10" SDR35 into 48" N-12
4251AG	6" SDR35 into 42" N-12	6053AG	10" SDR35 into 60" N-12
4851AG	6" SDR35 into 48" N-12		
6051AG	6" SDR35 into 60" N-12		

Part #	Description	Part #	Description
1252AG	8" SDR35 into 12" N-12	1854AG	12" SDR35 into 18" N-12
1552AG	8" SDR35 into 15" N-12	2454AG	12" SDR35 into 24" N-12
1852AG	8" SDR35 into 18" N-12	3054AG	12" SDR35 into 30" N-12
2452AG	8" SDR35 into 24" N-12	3654AG	12" SDR35 into 36" N-12
3052AG	8" SDR35 into 30" N-12	4254AG	12" SDR35 into 42" N-12
3652AG	8" SDR35 into 36" N-12	4854AG	12" SDR35 into 48" N-12
4252AG	8" SDR35 into 42" N-12	6054AG	12" SDR35 into 60" N-12
4852AG	8" SDR35 into 48" N-12		
6052AG	8" SDR35 into 60" N-12		

Part #	Description
2455AG	15" SDR35 into 24" N-12
3055AG	15" SDR35 into 30" N-12
3655AG	15" SDR35 into 36" N-12
4255AG	15" SDR35 into 42" N-12
4855AG	15" SDR35 into 48" N-12
6055AG	15" SDR35 into 60" N-12

ni

Part #	Description	Units Per Case
04CPUT*	4" Uni-T x 12" - 60" CPE	10
06CPUT*	6" Uni-T x 12" - 60" CPE	10
08CPUT*	8" Uni-T x 12" - 60" CPE	10

\* Add Nyloplast Bell Spigot Adapter when tapping N-12 Pipe Service Line into N-12 Main Line.

0468AG	4" Adapt w/SDR35 Spigot	1
0668AG	6" Adapt w/SDR35 Spigot	1
0868AG	8" Adapt w/SDR35 Spigot	1

inserta ee  
ittin s  
SD into

Part #	Description	Part #	Description
0850AG	4" SDR35 into 8" N-12	2450AG	4" SDR35 into 24" N-12
1050AG	4" SDR35 into 10" N-12	3050AG	4" SDR35 into 30" N-12
1250AG	4" SDR35 into 12" N-12	3650AG	4" SDR35 into 36" N-12
1550AG	4" SDR35 into 15" N-12	4250AG	4" SDR35 into 42" N-12
1850AG	4" SDR35 into 18" N-12	4850AG	4" SDR35 into 48" N-12
		6050AG	4" SDR35 into 60" N-12



SECTION 10



# ADS miscellaneous rod cuts

## ANIMAL GUARDS (Finger Style)

Part #	Size
0470DA	4"
0670DA	6"
0870DA	8"
1070DA	10"
1270DA	12"
1570DA	15"
1870DA	18"
2470DA	24"
3070DA	30"
3670DA	36"
4270DA	42"



## ANIMAL GUARDS (Solid-Style)

Part #	Size
0471DA	4"
0671DA	6"
0871DA	8"
1071DA	10"

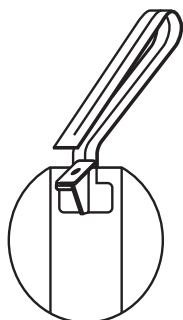

## BAR GUARDS

Part #	Size
0420DA	4"
0620DA	6"
0820DA	8"
1020DA	10"
1220DA	12"
1520DA	15"
1820DA	18"
2420DA	24"
3020DA	30"
3620DA	36"

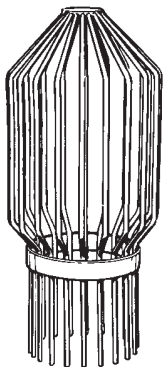

## END SECTION TRASH GUARDS

Part #	Size
1290DA	12"
1590DA	15"
1890DA	18"
2490DA	24"
3090DA	30"
3690DA	36"

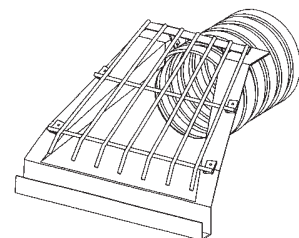

## FLAP GATES

Part #	Size
0440DA	4"
0640DA	6"
0840DA	8"
1040DA	10"
1240DA	12"
1540DA	15"
1840DA	18"
2440DA	24"
3040DA	30"
3640DA	36"



## LUBRICANT Refer to page 10 for Estimating Guide

Part #	Size
0200LU	2# Tub
0800LU	8# Tub

## PVC DIVERter VALVE (Bull Run Valve)

Part #
4182FG



## TAPE

Part #	Size	Description	Packaging
1137KA	1/2" x 100'	Black-Filament	24 Rolls per case 1400 Rolls per Skid
1147KA	2" x 100'	Black	24 Rolls per case 1400 Rolls per Skid

**FIELD REPAIR COUPLERS**

<u>Part #</u>	<u>Size</u>
0867RC	8"
1067RC	10"
1267RC	12"
1567RC	15"
1867RC	18"
2467RC	24"
3067RC	30"
3667RC	36"
4267RC	42"
4867RC	48"
6067RC	60"

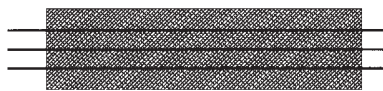

**INTERNAL JOINT SEALS**

<u>Part #</u>	<u>Description</u>
1891NS	18" x 7.5" NPC Internal Seal
2491NS	24" x 7.5" NPC Internal Seal
3091NS	30" x 7.5" NPC Internal Seal
3691NS	36" x 7.5" NPC Internal Seal
4291NS	42" x 7.5" NPC Internal Seal
4891NS	48" x 7.5" NPC Internal Seal
6091NS	60" x 7.5" NPC Internal Seal
1892NS	18" x 10.5" NPC Internal Seal
2492NS	24" x 10.5" NPC Internal Seal
3092NS	30" x 10.5" NPC Internal Seal
3692NS	36" x 10.5" NPC Internal Seal
4292NS	42" x 10.5" NPC Internal Seal
4892NS	48" x 10.5" NPC Internal Seal
6092NS	60" x 10.5" NPC Internal Seal

**Slotted Holes End Cap**



<u>Part #</u>	<u>Size</u>
6073GC	6"
0873GC	8"
1073GC	10"
1273GC	12"

**1" Holes Orange End Cap**



<u>Part #</u>	<u>Size</u>
6023GC	6"
0823GC	8"
1023GC	10"
1223GC	12"

**5/16" Holes Orange Extension**



<u>Part #</u>	<u>Size</u>
6033GC	6"
0833GC	8"
1033GC	10"
1233GC	12"

**No Holes Orange Extension**



<u>Part #</u>	<u>Size</u>
6053GC	6"
0853GC	8"
1053GC	10"

**RESTRICTOR**

<u>Part #</u>	<u>Size</u>
6063GC	6"
0863GC	8"



**BLACK RISER TEE**

<u>Part #</u>	<u>Size</u>
6043GC	6"
0843GC	8"
1043GC	10"
1243GC	12"





# Duraslot® Surface Drains

## DURASLOT® Surface Drains



**Part #**      **Description**

0420DS	4" Pipe, 2.5" Slot Height, 10' long	1220DS	12" Pipe, 2.5" Slot Height, 10' long
0421DS	4" Coupler for 0420DS	1221DS	12" Coupler for 1220DS
0433DS	4" DURASLOT End Cap	1260DS	12" Pipe, 6" Slot Height, 10' long
0462DS	4" DURASLOT Adapter	1226DS	12" Coupler for 1260DS
0490DS	4" Pipe, variable slot height, 10' long	1233DS	12" DURASLOT End Cap
0491DS	4" Coupler for 0490DS	1262DS	12" DURASLOT Adapter
0493DS	4" End Cap, variable height	1290DS	12" Pipe, variable slot height, 10' long
0496DS	4" Adapter, variable height	1291DS	12" Coupler for 1290DS
0620DS	6" Pipe, 2.5" Slot Height, 10' long	1293DS	12" End Cap, variable height
0621DS	6" Coupler for 0620DS	1296DS	12" Adapter, variable height
0660DS	6" Pipe, 6" Slot Height, 10' long	1560DS	15" Pipe, 6" Slot Height, 10' long
0626DS	6" Coupler for 0660DS	1526DS	15" Coupler for 1560DS
0633DS	6" DURASLOT End Cap	1533DS	15" DURASLOT End Cap
0662DS	6" DURASLOT Adapter	1562DS	15" DURASLOT Adapter
0690DS	6" Pipe, variable slot height, 10' long	1590DS	15" Pipe, variable slot height, 10' long
0691DS	6" Coupler for 0690DS	1591DS	15" Coupler for 1590DS
0693DS	6" End Cap, variable height	1593DS	15" End Cap, variable height
0696DS	6" Adapter, variable height	1596DS	15" Adapter, variable height
0820DS	8" Pipe, 2.5" Slot Height, 10' long	1860DS	18" Pipe, 6" Slot Height, 10' long
0821DS	8" Coupler for 0820DS	1826DS	18" Coupler for 1860DS
0860DS	8" Pipe, 6" Slot Height, 10' long	1833DS	18" DURASLOT End Cap
0826DS	8" Coupler for 0860DS	1862DS	18" DURASLOT Adapter
0833DS	8" DURASLOT End Cap	1890DS	18" Pipe, variable slot height, 10' long
0862DS	8" DURASLOT Adapter	1891DS	18" Coupler for 1890DS
0890DS	8" Pipe, variable slot height, 10' long	1893DS	18" End Cap, variable height
0891DS	8" Coupler for 0890DS	1896DS	18" Adapter, variable height
0893DS	8" End Cap, variable height	2460DS	24" Pipe, 6" Slot Height, 10' long
0896DS	8" Adapter, variable height	2426DS	24" Coupler for 2460DS
		2433DS	24" DURASLOT End Cap
		2462DS	24" DURASLOT Adapter
		2490DS	24" Pipe, variable slot height, 10' long
		2491DS	24" Coupler for 2490DS
		2493DS	24" End Cap, variable height
		2496DS	24" Adapter, variable height



# Duraslot Surface Drains



# ADS WaterStop Gaskets

- 3060DS 30" Pipe, 6" Slot Height, 10' long
- 3026DS 30" Coupler for 3060DS
- 3033DS 30" DURASLOT End Cap
- 3062DS 30" DURASLOT Adapter
- 3090DS 30" Pipe, variable slot height, 10' long
- 3091DS 30" Coupler for 3090DS
- 3093DS 30" End Cap, variable height
- 3096DS 30" Adapter, variable height

- 3660DS 36" Pipe, 6" Slot Height, 10' long
- 3626DS 36" Coupler for 3660DS
- 3633DS 36" DURASLOT End Cap
- 3662DS 36" DURASLOT Adapter
- 3690DS 36" Pipe, variable slot height, 10' long
- 3691DS 36" Coupler for 3690DS
- 3693DS 36" End Cap, variable height
- 3696DS 36" Adapter, variable height

- 4260DS 42" Pipe, 6" Slot Height, 10' long
- 4226DS 42" Coupler for 4260DS
- 4233DS 42" DURASLOT End Cap
- 4262DS 42" DURASLOT Adapter
- 4290DS 42" Pipe, variable slot height, 10' long
- 4291DS 42" Coupler for 4290DS
- 4293DS 42" End Cap, variable height
- 4296DS 42" Adapter, variable height



## ADS WaterStop Gaskets

N-12 Pipe Size	Recommended Minimum Hole Diameter	Min. Distance, Pipe Invert to Structure Invert
12"	19.50"	3.7"
15"	23.00"	4.0"
18"	26.50"	4.2"
24"	33.25"	4.5"
30"	40.50"	5.2"
36"	47.00"	5.5"
42"	53.00"	5.75"
48"	59.00"	5.75"
60"	72.00"	6.4"

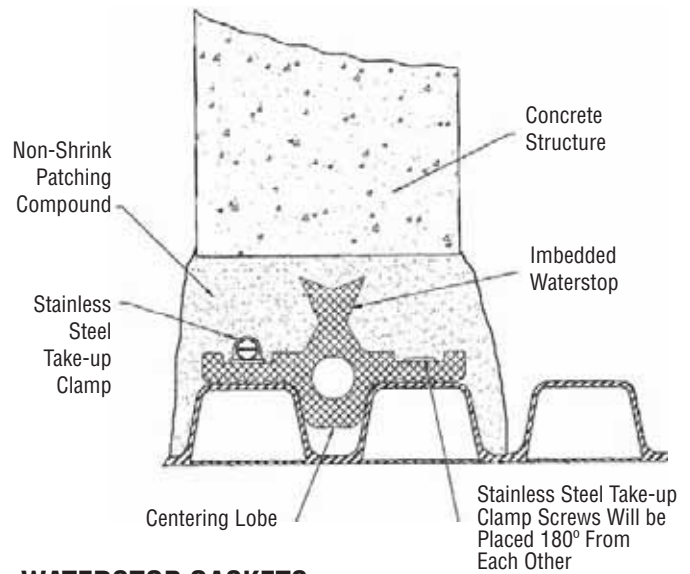

## WATERSTOP GASKETS

Part #	Description
1201PS	12" Waterstop Gasket
1501PS	15" Waterstop Gasket
1801PS	18" Waterstop Gasket
2401PS	24" Waterstop Gasket
3001PS	30" Waterstop Gasket
3601PS	36" Waterstop Gasket
4201PS	42" Waterstop Gasket
4801PS	48" Waterstop Gasket
6001PS	60" Waterstop Gasket

## Horizontal Drain Boxes

1/2" x 16" x 48" Fiberglass Grate with 1 1/2" square grids. Designed for containment of sand and screen.

Silt control mesh designed to allow maximum drainage of water.

1/2" x 16" x 48" Fiberglass Grate with 1 1/2" square grids. Designed for support of sand and screen.

12" x 16" x 48" Drainage receptacle to collect and drain large volumes of water.

## HORIZONTAL DRAIN BOXES

Product #  
1248DB

**STORMTECH  
UNITS**

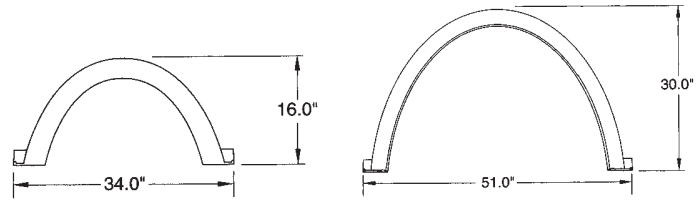

Product #	Description
SC310	Chamber with 31.0 ft <sup>3</sup> minimum storage capacity
SC740	Chamber with 74.9 ft <sup>3</sup> minimum storage capacity

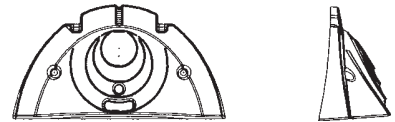

**SC-310 end cap**

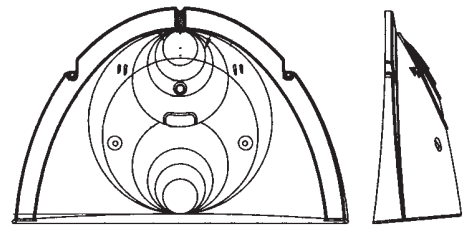

**SC-740 end cap**

Product #	Description	Pieces/ Pallet	Pallets/ TL
SC310E	End cap for SC310	41	18
SC740E	End cap for SC740	30	12



# StormTech® Chamber End Caps with Stubs



# StormTech® Manifolds

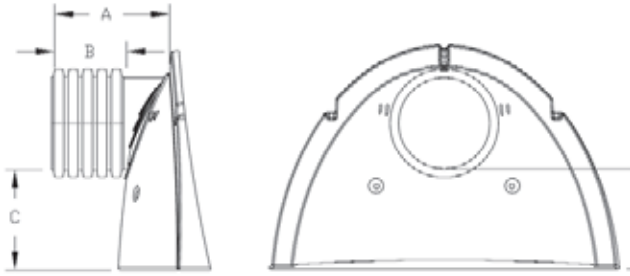

STUB AT TOP OF END CAP FOR PART NUMBERS ENDING WITH "T"

### FABRICATED END CAP

Product #	Description
SC310EPE06T	with 6" diameter pipe stub (top)
SC310EPE08T	with 8" diameter pipe stub (top)
SC310EPE10T	with 10" diameter pipe stub (top)
SC310EPE06B	with 6" diameter pipe stub (bottom)
SC310EPE08B	with 8" diameter pipe stub (bottom)
SC310EPE10B	with 10" diameter pipe stub (bottom)
SC310EPE12B	with 12" diameter pipe stub (bottom)
SC740EPE06T	with 6" diameter pipe stub (top)
SC740EPE08T	with 8" diameter pipe stub (top)
SC740EPE10T	with 10" diameter pipe stub (top)
SC740EPE12T	with 12" diameter pipe stub (top)
SC740EPE15T	with 15" diameter pipe stub (top)
SC740EPE18T	with 18" diameter pipe stub (top)
SC740EPE06B	with 6" diameter pipe stub (bottom)
SC740EPE08B	with 8" diameter pipe stub (bottom)
SC740EPE10B	with 10" diameter pipe stub (bottom)
SC740EPE12B	with 12" diameter pipe stub (bottom)
SC740EPE15B	with 15" diameter pipe stub (bottom)
SC740EPE18B	with 18" diameter pipe stub (bottom)
SC740EPE24B	with 24" diameter pipe stub (bottom)

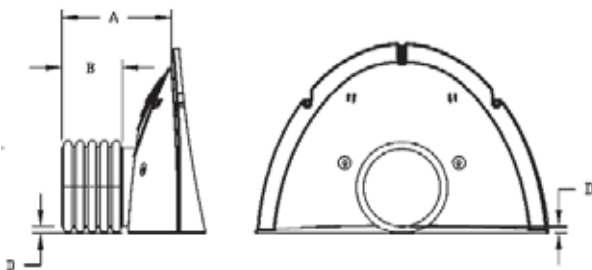

STUB AT Bottom OF END CAP FOR PART NUMBERS ENDING WITH "B"



### STORMTECH® SINGLE MANIFOLD

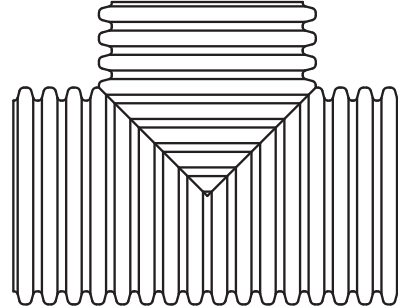

Product #	Pipe Size	Chamber Size
0651AN7406	6"	SC-740
0851AN7408	8"	SC-740
1051AN7410	10"	SC-740
1251AN7412	12"	SC-740
1551AN7415	15"	SC-740
1851AN7418	18"	SC-740
2451AN7424	24"	SC-740
0651AN3106	6"	SC-310
0851AN3108	8"	SC-310
1051AN3110	10"	SC-310
1251AN3112	12"	SC-310

### STORMTECH® DOUBLE MANIFOLD

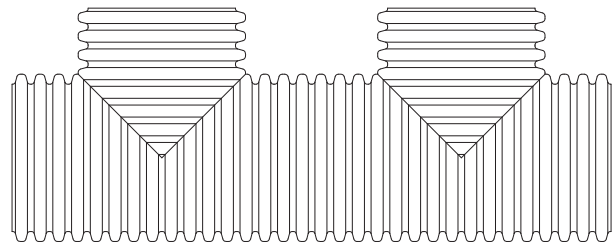

Product #	Pipe Size	Chamber Size
0652AN7406	6"	SC-740
0852AN7408	8"	SC-740
1052AN7410	10"	SC-740
1252AN7412	12"	SC-740
1552AN7415	15"	SC-740
1852AN7418	18"	SC-740
2452AN7424	24"	SC-740
0652AN3106	6"	SC-310
0852AN3108	8"	SC-310
1052AN3110	10"	SC-310
1252AN3112	12"	SC-310

**STORMTECH® TRIPLE MANIFOLD**

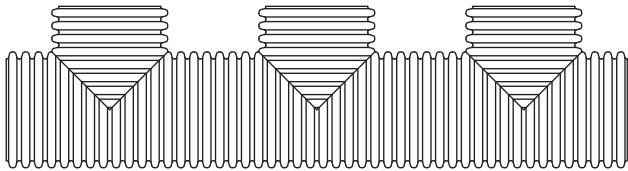

<b>Product #</b>	<b>Pipe Size</b>	<b>Chamber Size</b>
0653AN706	6"	SC-740
0853AN7408	8"	SC-740
1053AN7410	10"	SC-740
1253AN7412	12"	SC-740
1553AN7415	15"	SC-740
2453AN7424	24"	SC-740
0653AN3106	6"	SC-310
0853AN3108	8"	SC-310
1053AN3110	10"	SC-310
1253AN3112	12"	SC-310

**STORMTECH® 90° MANIFOLD**

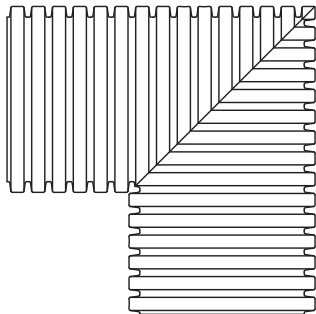

<b>Product #</b>	<b>Pipe Size</b>	<b>Chamber Size</b>
0898AN74	8"	SC-740
1098AN74	10"	SC-740
1298AN74	12"	SC-740
1598AN74	15"	SC-740
1898AN74	18"	SC-740
2498AN74	24"	SC-740
0698AN31	6"	SC-310
0898AN31	8"	SC-310
1098AN31	10"	SC-310
1298AN31	12"	SC-310

**STORMTECH® SINGLE REDUCING MANIFOLD**

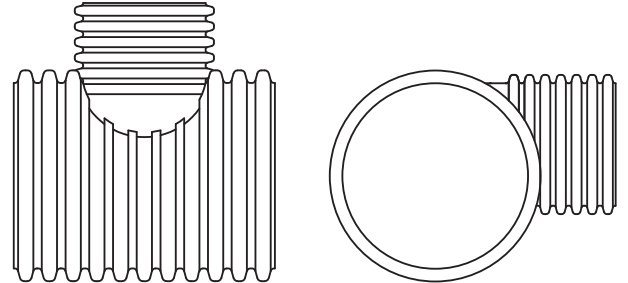

<b>Product #</b>	<b>Pipe Size</b>	<b>Chamber Size</b>
0851AN7406	8" x 6"	SC-740
1051AN7406	10" x 6"	SC-740
1051AN7408	10" x 8"	SC-740
1251AN7406	12" x 6"	SC-740
1251AN7408	12" x 8"	SC-740
1251AN7412	12" x 10"	SC-740
1551AN7406	15" x 6"	SC-740
1551AN7408	15" x 8"	SC-740
1551AN7410	15" x 10"	SC-740
1551AN7412	15" x 12"	SC-740
1851AN7406	18" x 6"	SC-740
1851AN7408	18" x 8"	SC-740
1851AN7410	18" x 10"	SC-740
1851AN7412	18" x 12"	SC-740
1851AN7415	18" x 15"	SC-740
2451AN7406	24" x 6"	SC-740
2451AN7408	24" x 8"	SC-740
2451AN7410	24" x 10"	SC-740
2451AN7412	24" x 12"	SC-740
2451AN7415	24" x 15"	SC-740
2451AN7418	24" x 18"	SC-740
3051AN7406	30" x 6"	SC-740
3051AN7412	30" x 12"	SC-740
3051AN7415	30" x 15"	SC-740
3051AN7418	30" x 18"	SC-740
3051AN7424	30" x 24"	SC-740



3651AN7412	36" x 12"	SC-740
3651AN7415	36" x 15"	SC-740
3651AN7418	36" x 18"	SC-740
3651AN7424	36" x 24"	SC-740
4251AN7412	42" x 12"	SC-740
4251AN7415	42" x 15"	SC-740
4251AN7418	42" x 18"	SC-740
4251AN7424	42" x 24"	SC-740
4851AN7412	48" x 12"	SC-740
4851AN7415	48" x 15"	SC-740
4851AN7418	48" x 18"	SC-740
4851AN7424	48" x 24"	SC-740
0851AN3106	8" x 6"	SC-310
1051AN3106	10" x 6"	SC-310
1051AN3108	10" x 8"	SC-310
1251AN3106	12" x 6"	SC-310
1251AN3108	12" x 8"	SC-310
1251AN3110	12" x 10"	SC-310
1851AN3106	18" x 6"	SC-310
1851AN3108	18" x 8"	SC-310
1851AN3110	18" x 10"	SC-310
1851AN3112	18" x 12"	SC-310
2451AN3106	24" x 6"	SC-310
2451AN3108	24" x 8"	SC-310
2451AN3110	24" x 10"	SC-310
2451AN3112	24" x 12"	SC-310

**STORMTECH® DOUBLE REDUCING MANIFOLD**

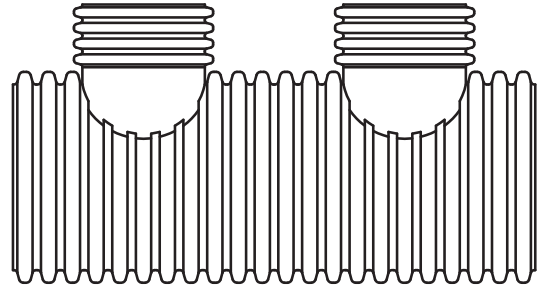

<u>Product #</u>	<u>Pipe Size</u>	<u>Chamber Size</u>
0852AN7406	8" x 6"	SC-740
1052AN7406	10" x 6"	SC-740
1052AN7408	10" x 8"	SC-740
1252AN7406	12" x 6"	SC-740
1252AN7408	12" x 8"	SC-740
1252AN7412	12" x 10"	SC-740
1552AN7406	15" x 6"	SC-740
1552AN7408	15" x 8"	SC-740
1552AN7410	15" x 10"	SC-740
1552AN7412	15" x 12"	SC-740
2452AN7408	24" x 8"	SC-740
2452AN7410	24" x 10"	SC-740
2452AN7412	24" x 12"	SC-740
2452AN7415	24" x 15"	SC-740
2452AN7418	24" x 18"	SC-740
4252AN7412	42" x 12"	SC-740
4252AN7415	42" x 15"	SC-740
4252AN7418	42" x 18"	SC-740
4252AN7424	42" x 24"	SC-740

**StormTech®**  
Reducing  
Manifolds



**StormTech®**  
Reducing  
Manifolds

0852AN3106	8" x 6"	SC-310
1052AN3106	10" x 6"	SC-310
1052AN3108	10" x 8"	SC-310
1252AN3106	12" x 6"	SC-310
1252AN3108	12" x 8"	SC-310
1252AN3110	12" x 10"	SC-310
1552AN3106	15" x 6"	SC-310
1552AN3108	15" x 8"	SC-310
1552AN3110	15" x 10"	SC-310
1552AN3112	15" x 12"	SC-310
1852AN3106	18" x 6"	SC-310
1852AN3108	18" x 8"	SC-310
1852AN3110	18" x 10"	SC-310
1852AN3112	18" x 12"	SC-310

1853AN7406	18" x 6"	SC-740
1853AN7408	18" x 8"	SC-740
1853AN7410	18" x 10"	SC-740
1853AN7412	18" X 12"	SC-740
1853AN7415	18" X 15"	SC-740
2453AN7406	24" x 6"	SC-740
2453AN7408	24" x 8"	SC-740
2453AN7410	24" x 10"	SC-740
2453AN7412	24" x 12"	SC-740
2453AN7415	24" x 15"	SC-740
2453AN7418	24" x 18"	SC-740
4253AN7412	42" x 12"	SC-740
4253AN7415	42" x 15"	SC-740
4253AN7418	42" x 18"	SC-740
4253AN7424	42" x 24"	SC-740

**STORMTECH® TRIPLE REDUCING MANIFOLD**

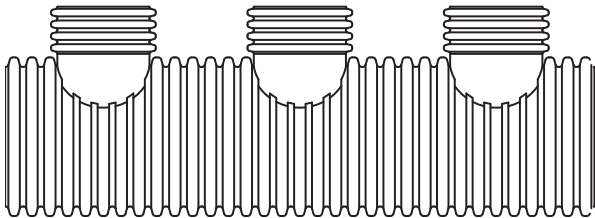

<b>Product #</b>	<b>Pipe Size</b>	<b>Chamber Size</b>
0853AN7406	8" x 6"	SC-740
1053AN7406	10" x 6"	SC-740
1053AN7408	10" x 8"	SC-740
1253AN7406	12" x 6"	SC-740
1253AN7408	12" x 8"	SC-740
1253AN7410	12" x 10"	SC-740
1553AN7406	15" x 6"	SC-740
1553AN7408	15" x 8"	SC-740
1553AN7410	15" x 10"	SC-740
1553AN7412	15" x 12"	SC-740

0853AN3106	8" x 6"	SC-310
1053AN3106	10" x 6"	SC-310
1053AN3108	10" x 8"	SC-310
1253AN3106	12" x 6"	SC-310
1253AN3108	12" x 8"	SC-310
1253AN3110	12" x 10"	SC-310
1553AN3106	15" x 6"	SC-310
1553AN3108	15" x 8"	SC-310
1553AN3110	15" x 10"	SC-310
1553AN3112	15" x 12"	SC-310
1853AN3106	18" x 6"	SC-310
1853AN3108	18" x 8"	SC-310
1853AN3110	18" x 10"	SC-310
1853AN3112	18" x 12"	SC-310



# Water Quality Units†

## WATER QUALITY UNITS†

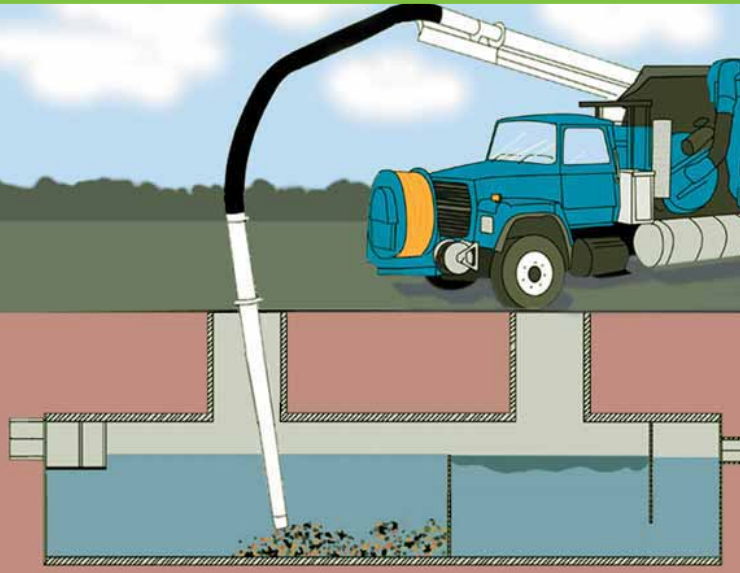

**Water Quality Unit Product Numbers**

Product Number	Diameter inches (mm)		Length feet (meters)		Inlet Size inches (mm)		Outlet Size with Bypass inches (mm)		Treated Flow Rate cfs (L/s)		Sed. Vol. ft <sup>3</sup> (m <sup>3</sup> )		Oil Vol. ft <sup>3</sup> (m <sup>3</sup> )		Sieve Size
3620WQA	36	(900)	20	(6)	10	(250)	10	(250)	1.5	(42)	65	(1.8)	30	(0.8)	140
3640WQA	36	(900)	40	(12)	10	(250)	10	(250)	3.2	(91)	137	(3.9)	63	(1.8)	140
3620WQB	36	(900)	20	(6)	10	(250)	10	(250)	0.7	(20)	65	(1.8)	30	(0.8)	200
3640WQB	36	(900)	40	(12)	10	(250)	10	(250)	1.6	(45)	137	(3.9)	63	(1.8)	200
4220WQA	42	(1050)	20	(6)	12	(300)	12	(300)	1.73	(49)	83	(2.3)	38	(1.1)	140
4240WQA	42	(1050)	40	(12)	12	(300)	12	(300)	3.66	(104)	175	(5.0)	81	(2.3)	140
4220WQB	42	(1050)	20	(6)	12	(300)	12	(300)	0.86	(24)	83	(2.3)	38	(1.1)	200
4240WQB	42	(1050)	40	(12)	12	(300)	12	(300)	1.83	(52)	175	(5.0)	81	(2.3)	200
4820WQA	48	(1200)	20	(6)	12	(300)	12	(300)	2.26	(64)	116	(3.3)	55	(1.6)	140
4840WQA	48	(1200)	40	(12)	12	(300)	12	(300)	4.78	(135)	245	(6.9)	115	(3.3)	140
4820WQB	48	(1200)	20	(6)	12	(300)	12	(300)	1.13	(32)	116	(3.3)	55	(1.6)	200
4840WQB	48	(1200)	40	(12)	12	(300)	12	(300)	2.39	(68)	245	(6.9)	115	(3.3)	200
6020WQA	60	(1500)	20	(6)	15	(375)	15	(375)	2.95	(84)	183	(5.2)	87	(2.5)	140
6040WQA	60	(1500)	40	(12)	15	(375)	15	(375)	6.23	(176)	385	(10.9)	184	(5.2)	140
6020WQB	60	(1500)	20	(6)	15	(375)	15	(375)	1.47	(42)	183	(5.2)	87	(2.5)	200
6040WQB	60	(1500)	40	(12)	15	(375)	15	(375)	3.12	(88)	385	(10.9)	184	(5.2)	200

140 sieve is equal to a particle size of 0.0042 in (0.106 mm)  
 200 sieve is equal to a particle size of 0.0030 in (0.075 mm)

† Patented

**Storm**  **PURE™**

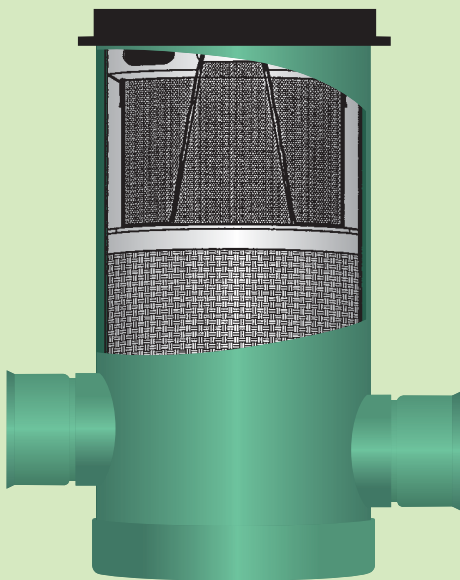

**Storm-PURE™  
Catch Basin Insert**

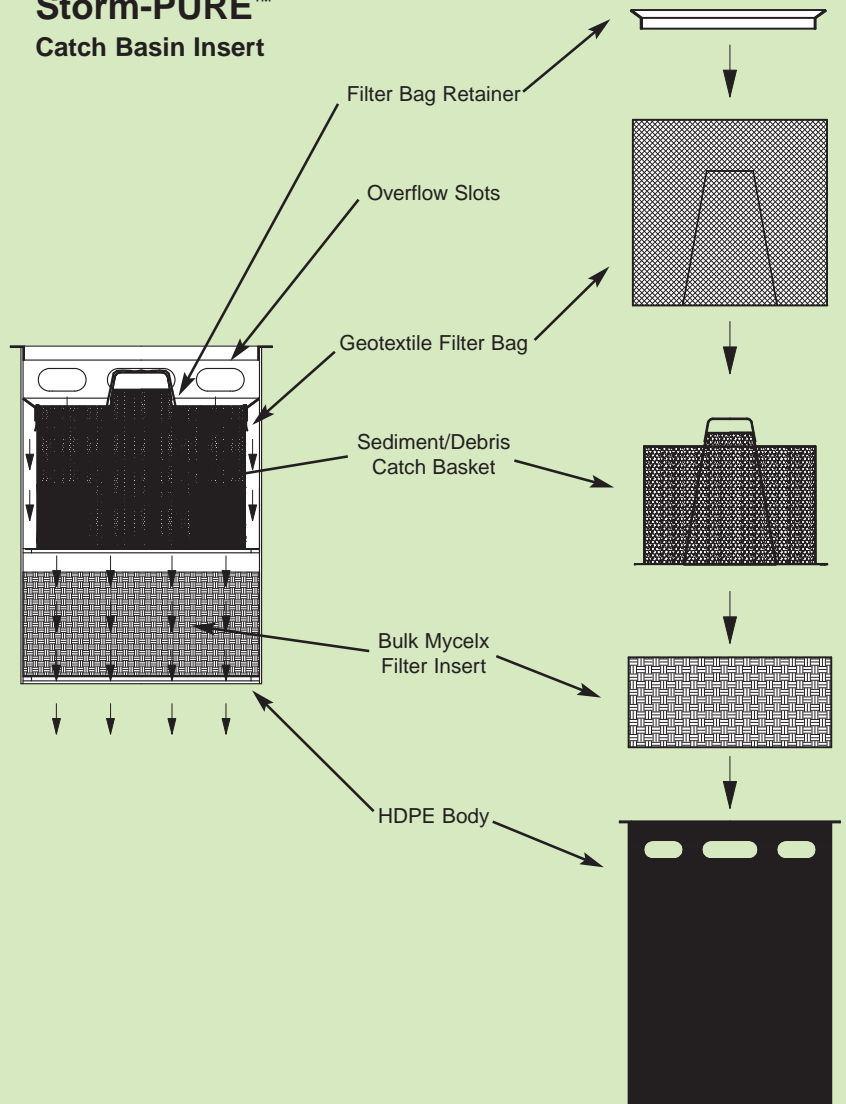

**Complete Units**

**COMPLETE UNITS**

- 5518AGL18 – 18" Storm-PURE WQI, 18" Length
- 5524AGL18 – 24" Storm-PURE WQI, 18" Length
- 5524AGL30 – 24" Storm-PURE WQI, 30" Length

**Replacement Parts**

**REPLACEMENT PARTS**

- 5518AGFILTERL18 – 18" Filter, 18" Length
- 5524AGFILTERL18 – 24" Filter, 18" Length
- 5524AGFILTERL30 – 24" Filter, 30" Length
- 5518AGMBAG – 18" Mycelx Bag
- 5524AGMBAG – 24" Mycelx Bag



# ADS Sales and Service Locations

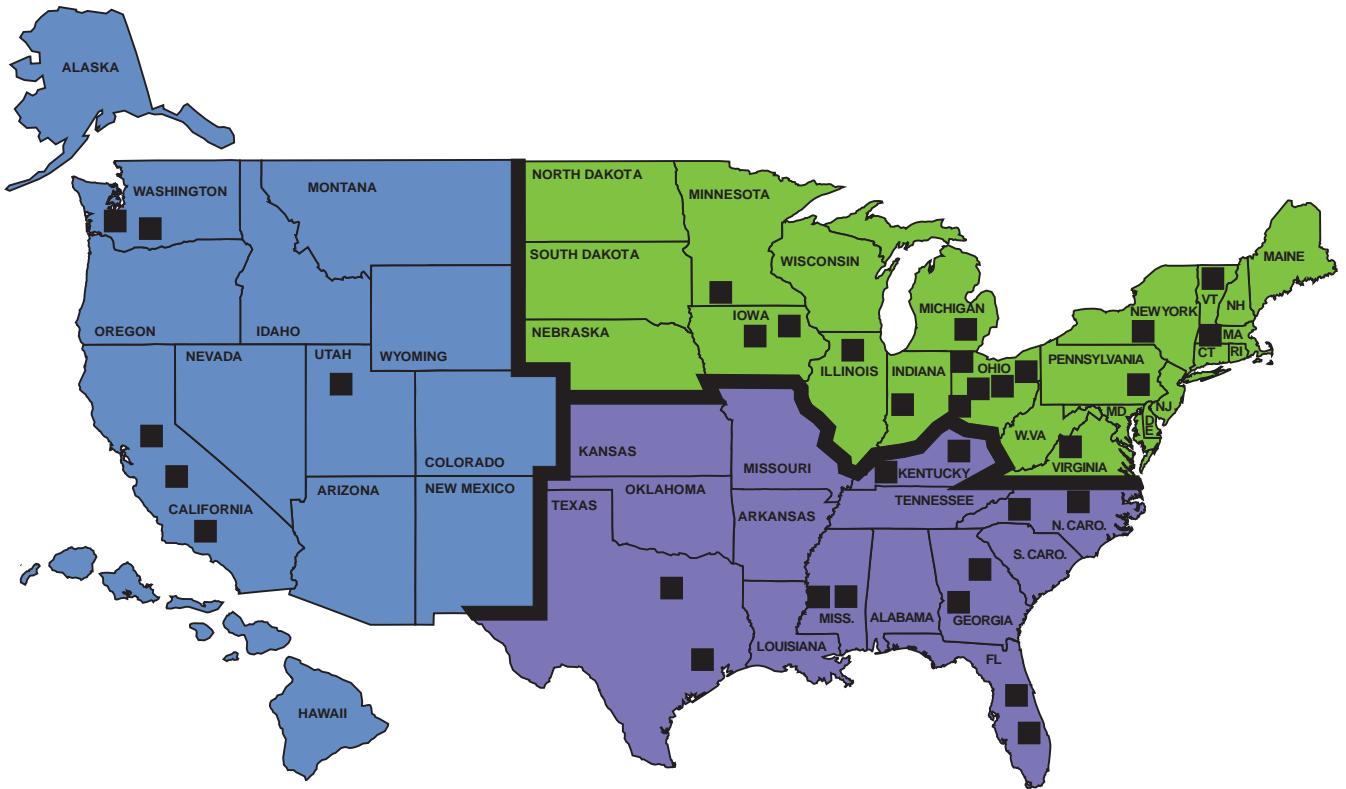

## CUSTOMER SERVICE OFFICES

- MIDWEST / NORTHEAST ZONE  
LONDON, OH 1-800-733-9554
- SOUTHERN ZONE  
FRANKLIN, TN 1-800-733-9987
- WESTERN ZONE  
WASHOUGAL, WA 1-800-733-8523

■ MANUFACTURING  
FACILITY LOCATIONS



## ADVANCED DRAINAGE SYSTEMS, INC.

4640 TRUEMAN BLVD., HILLIARD, OH 43026  
800-821-6710 [www.ads-pipe.com](http://www.ads-pipe.com)

ADS "Terms & Conditions of Sale" are available on the ADS Website.

**THE MOST  
ADVANCED  
NAME IN  
DRAINAGE  
SYSTEMS®**

Form #10524 Revised 03/06

© Copyright 2006 Advanced Drainage Systems, Inc.

Advanced Drainage Systems, the ADS logo, the green stripe, "The Most Advanced Name in Drainage Systems", TripleWall, N-12, AdvanEDGE, ARC 36, Grain-Aire, and Drain Guard are registered trademarks of Advanced Drainage Systems, Inc. Duraslot is a registered trademark of Hall Construction Products. StormTech is a registered trademark of StormTech, Inc. Inserta-Tee is a registered trademark of Inserta Fittings, Inc. Typar is a registered trademark of Reemay, Inc. Nyloplast and StormPure are registered trademarks of ADS Structures, Inc. Propex is a registered trademark of Propex Fabrics, Inc.

Printed in U.S.A.