

[Link to Master Table of Contents](#)

[Link to Section Table of Contents](#)

Permanent Hose Fittings

25 Series Fittings

26 Series Fittings

43 Series Fittings

56 Series Fittings

71 Series Fittings

77 Series Fittings

79 Series Fittings

81 Series Fittings

91N Series Fittings

93N Series Fittings

CY Series Fittings

HY Series Fittings

SF Series Fittings

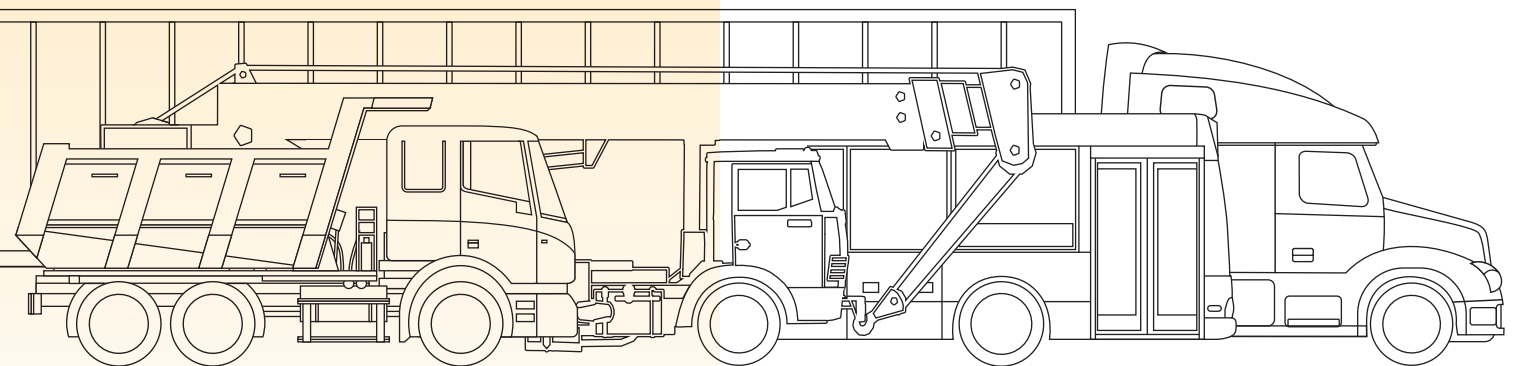

ENGINEERING YOUR SUCCESS.

Table of Contents

Visual Index	E2
25 Series Fittings.....	E14
26 Series Fittings.....	E14
43 Series Fittings.....	E19
56 Series Fittings.....	E32
71 Series Fittings.....	E40
77 Series Fittings.....	E45
79 Series Fittings.....	E52
81 Series Fittings.....	E53
91N/91 Series Fittings	E54
93N Series Fittings	E57
CY Series Fittings.....	E58
HY Series Fittings.....	E60
SF Series Fittings.....	E65
“How to Order” Information	9
Chemical Compatibility Guide.....	O10, www.parker.com

Visual Index

Permanent Hose Fittings – 25 Series

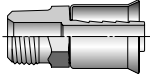
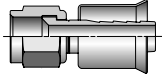
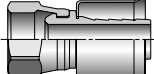
Flange	10125 Rigid Page E14	10825 Swivel Page E14	17B25 Swivel Page I17
			

Permanent Hose Fittings – 26 Series

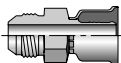
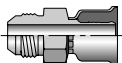
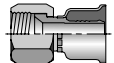
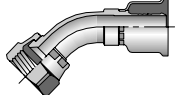
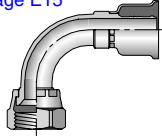
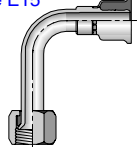
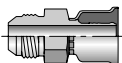
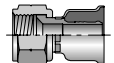
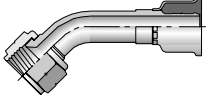
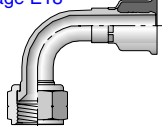
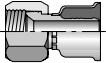
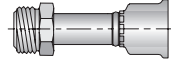
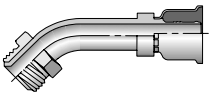
NPTF Pipe	10126 Male - Rigid Page E14	JIC 37°	10326 Male - Rigid Page E14	10626 Female - Swivel Page E14	13726 Female - Swivel 45° Elbow - Short Page E15
					
13926 Female - Swivel 90° Elbow - Short Page E15	14126 Female - Swivel 90° Elbow - Long Page E15	SAE 45°	10426 Male - Rigid Page E14	10826 Female - Swivel Page E14	17726 Female - Swivel 45° Elbow - Short Page E18
					
17926 Female - Swivel 90° Elbow Page E18	JIC 37° / SAE 45° Dual Flare	16826 Female - Swivel Page E18	Inverted Flare	12826 Male - Swivel Page E14	16726 Male - Swivel 45° Elbow Page E18
					

Permanent Hose Fittings – 26 Series (Continued)

Inverted Flare (Cont'd)

16926
Male - Swivel
90° Elbow
[Page E18](#)

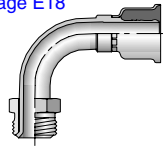

Seal-Lok™ O-Ring Face Seal

1JC26
Female - Swivel Short
[Page E19](#)

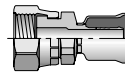

1J726
Female - Swivel
45° Elbow
[Page E18](#)

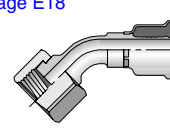

1J926
Female - Swivel 90°
Elbow - Short
[Page E18](#)

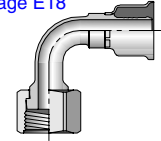

Tube-O

1S526
Male - Swivel -
Short Pilot
[Page E19](#)

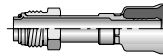

1S526-PR
Male - Swivel -
Short Pilot
[Page E19](#)

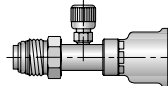

15R26
Male - Swivel
45° Elbow - Short Pilot
[Page E17](#)

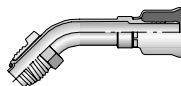

15K26
Male - Swivel
90° Elbow - Short Pilot
[Page E16](#)

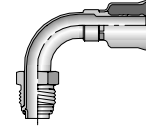

15K26-PB
Male - Swivel
90° Elbow - Short Pilot
[Page E16](#)

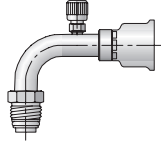

15K26-PR
Male - Swivel
90° Elbow - Short Pilot
[Page E16](#)

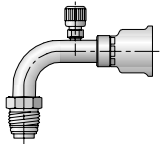

14526-PR
Male - Swivel
Long Pilot
[Page E17](#)

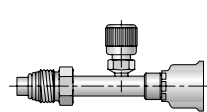

14526-PT
Male - Swivel
Long Pilot
[Page E15](#)

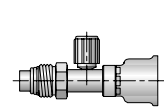

15M26-PR
Male - Swivel
90° Elbow - Long Pilot
[Page E16](#)

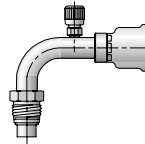

15M26-PT
Male - Swivel
90° Elbow - Long Pilot
[Page E17](#)

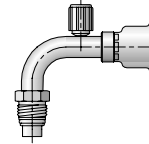

15G26
Male - Rigid
Internal - Long Pilot
[Page E15](#)

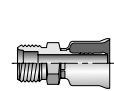

15G26-PR
Male - Rigid
Internal - Long Pilot
[Page E15](#)

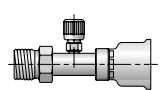

15S26
Female - Swivel
Short Pilot
[Page E17](#)

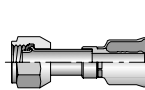

15H26
Female - Swivel 45°
Elbow - Short Pilot
[Page E16](#)

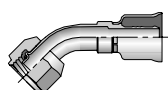

15T26
Female - Swivel
90° Elbow - Short Pilot
[Page E17](#)

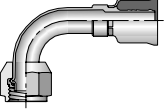

15926-PB
Female - Swivel
Long Pilot
[Page E15](#)

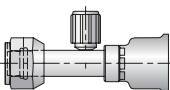

15926-PT
Female - Swivel
Long Pilot
[Page E15](#)

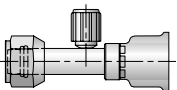

15N26-PB
Female - Swivel
45° Elbow - Long Pilot
[Page E17](#)

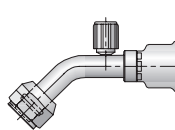

15N26-PT
Female - Swivel
45° Elbow - Long Pilot
[Page E17](#)

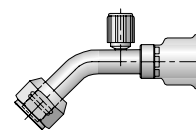

15L26
Female - Swivel
90° Elbow - Long Pilot
[Page E16](#)

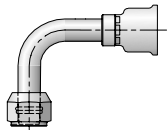

15L26-PB
Female - Swivel
90° Elbow - Long Pilot
[Page E16](#)

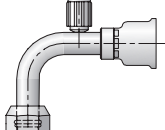

15L26-PR
Female - Swivel
90° Elbow - Long Pilot
[Page E16](#)

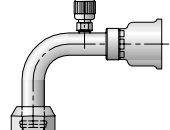

15L26-PT
Female - Swivel
90° Elbow - Long Pilot
[Page E16](#)

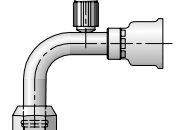

15P26-PT
Male - Swivel
45° Elbow - Long Pilot
[Page E17](#)

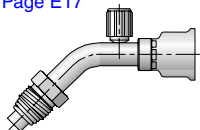

Air Brake Jounce Line

17B26
Female - Swivel
[Page E17](#)

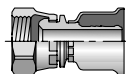

Compressor

15V26
Female - Swivel
45° Elbow
[Page E17](#)

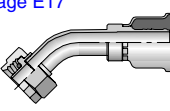

15W26
Female - Swivel
90° Elbow
[Page E17](#)

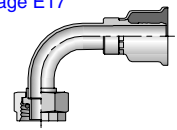

15Z26
Female - Swivel
90° Elbow - Block Type
[Page E17](#)

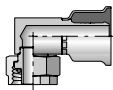

1RV26
Female - Swivel
135° Elbow
[Page E19](#)

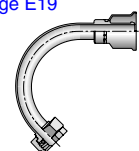

1RZ26
Female - Swivel
180° Elbow
[Page E19](#)

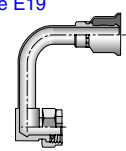

Refrigerant Tube Mender

1T126
Male (w/Nut & Ferrule)
[Page E19](#)

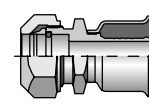

Permanent Hose Fittings – 43 Series

**NPTF/
NPTM Pipe**

10143
Male - Rigid
Page E19

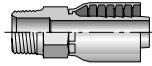

11343
Male - Swivel
Page E22

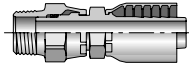

11L43
Male - Swivel
90° Elbow
Page E23

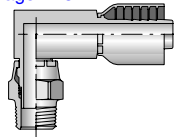

10243
Female - Rigid
Page E20

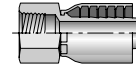

1S243
Female - Swivel
Page E32

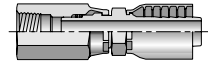

10743
Female - Swivel
Page E21

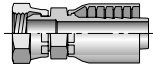

**Straight
Thread
O-Ring**

10543
Male - Rigid
Page E20

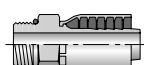

10G43
Male - Swivel
Page E21

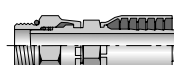

10L43
Male - Swivel
90° Elbow
Page E21

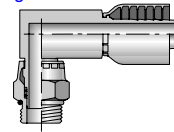

JIC 37°

10343
Male - Rigid
Page E20

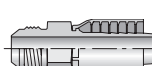

1LB43
Male - Bulkhead
Page E32

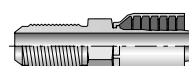

10643
Female - Swivel
Page E20

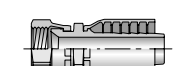

13743
Female - Swivel
45° Elbow - Short
Page E23

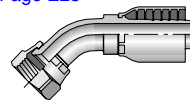

1L743
Female - Swivel
45° Elbow - Medium
Page E31

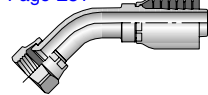

13943
Female - Swivel
90° Elbow - Short
Page E24

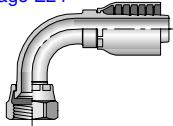

1L943
Female - Swivel
90° Elbow - Short
Page E31

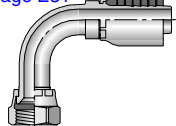

14143
Female - Swivel
150° Elbow
Page E24



14V43
Male - Swivel
Page E24

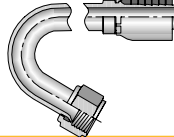

SAE 45°

10443
Male - Rigid
Page E20

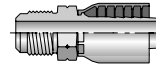

10843
Female - Swivel
Page E21

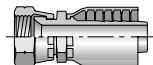

17743
Female - Swivel
45° Elbow
Page E25

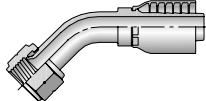

17943
Female - Swivel
90° Elbow
Page E25

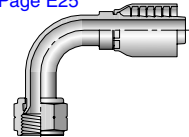

Flareless

11143
Male - Rigid
Page E21

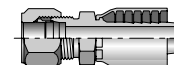

11243
Female - Swivel
Page E21

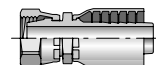

1GJ43
Female - Rigid
Page E29

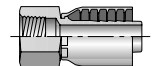

**Inverted
Flare**

12843
Male - Swivel
Page E23

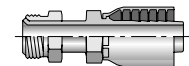

16743
Male - Swivel
45° Elbow
Page E25

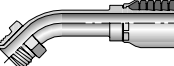

16943
Male - Swivel
45° Elbow
Page E25

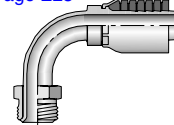

**Code 61
Flange**

11543
Flange Head
Page E22

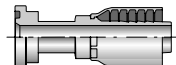

11643
22-1/2° Elbow
Page E22

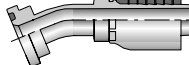

11843
67-1/2° Elbow
Page E22

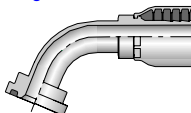

11943
90° Elbow
Page E22

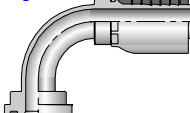

12643
30° Elbow
Page E23

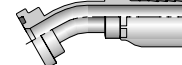

Permanent Hose Fittings – 43 Series (Continued)

11743
45° Elbow
Page E22

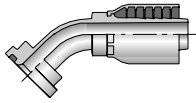

12743
60° Elbow
Page E23

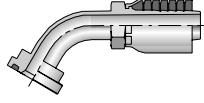

**Code 62
Flange**

16A43
Flange Head
Page E25

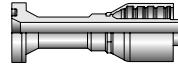

16F43
45° Elbow
Page E25

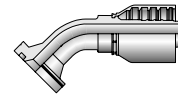

16N43
90° Elbow
Page E25

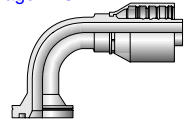

**Seal-Lok™
(O-Ring
Face Seal)**

1J043
Male - Rigid
w/O-Ring
Page E29

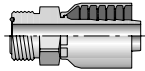

1JB43
Male - Bulkhead
w/O-Ring
Page E30

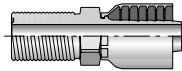

1JC43
Female - Swivel Short
Page E31

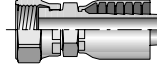

1JS43
Female - Swivel Long
Page E31

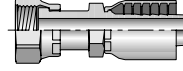

1J643
Female - Swivel
22-1/2° Elbow
Page E31

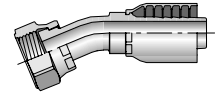

1J743
Female - Swivel
45° Elbow
Page E30

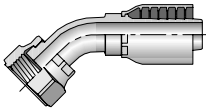

1J943
Female - Swivel
90° Elbow - Short
Page E30

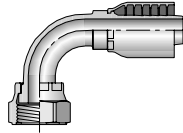

1J543
Female - Swivel
90° Elbow - Medium
Page E29

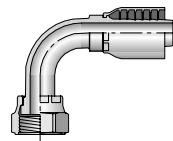

1J143
Female - Swivel
90° Elbow - Long
Page E29

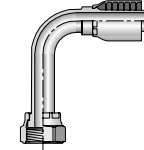

UPTC

1EN
Male
Page E28

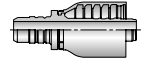

1ET43
Male - 90° Elbow
Page E28

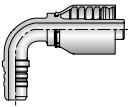

1EU43
Male - 45° Elbow
Page E28

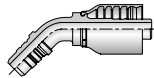

Metric

1D043
Male - Rigid
Page E28

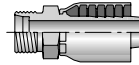

11D43
Male Standpipe - Rigid
Page E23

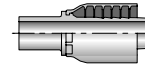

1C343
Female - Swivel
Page E26

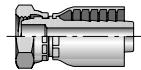

1C443
Female - Swivel
45° Elbow
Page E26

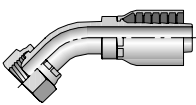

1C543
Female - Swivel
90° Elbow
Page E26

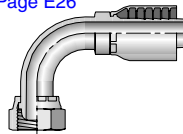

1CA43
Female - Swivel
Page E27

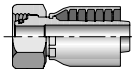

1CE43
Female - Swivel
45° Elbow
Page E27

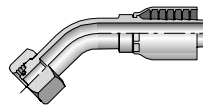

1CF43
Female - Swivel
90° Elbow
Page E27

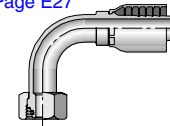

**DIN "S"
Series &
DIN "S"
w/O-Ring**

1D243
Male - Rigid
Page E28

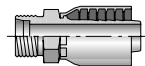

13D43
Male Standpipe - Rigid
Page E24

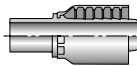

1C643
Female - Swivel
Page E27

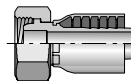

1C943
Female - Swivel
Page E27

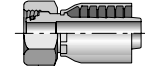

10C43
Female - Swivel
45° Elbow
Page E21

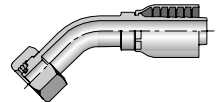

11C43
Female - Swivel
90° Elbow
Page E23

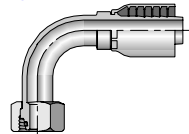

**DIN 60°
Cone**

1C043
Female - Swivel
Page E26

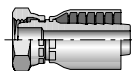

BSP

1D943
Male - Rigid
Page E28

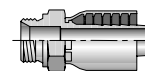

19243
Female - Swivel
Page E25

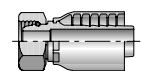

Permanent Hose Fittings – 43 Series (Continued)

1B143
Female - Swivel
45° Elbow
[Page E26](#)

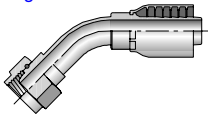

1B243
Female - Swivel
90° Elbow
[Page E26](#)

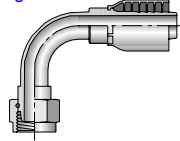

1B443
Female - Swivel
90° Elbow - Block Type
[Page E26](#)

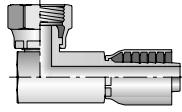

1B543
Female - Swivel
Flat Seat
[Page E26](#)

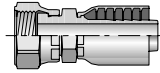

Banjo

14943
Metric Banjo
[Page E24](#)

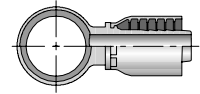

Metric 30° Flare

1MU43
Female - Swivel
[Page E32](#)

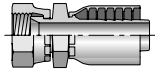

1XU43
Female - Swivel
[Page E32](#)

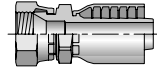

BSP

1FU43
Female - Swivel
[Page E28](#)

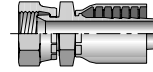

1UT43
Male - Rigid
[Page E32](#)

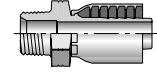

1GU43
Female - Swivel
[Page E29](#)

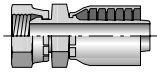

French Gaz

1F443
Female - Swivel
[Page E28](#)

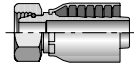

Permanent Hose Fittings – 56 Series

SAE & JIC Fittings

10356
Male (JIC)
37° Rigid
[Page E33](#)

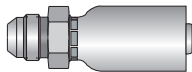

10456
Male SAE 45° Rigid
[Page E33](#)

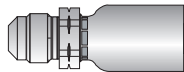

10556
Male Str. Thread O-Ring
[Page E33](#)

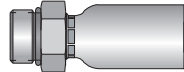

10656
SAE (JIC) 37° Swivel
[Page E33](#)

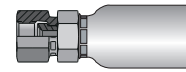

10856
Female SAE 45° Swivel
[Page E33](#)

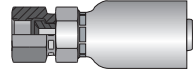

11256
SAE Flareless Swivel
[Page E34](#)

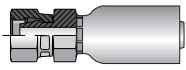

13756
FM JIC 37° Swivel -
45° Elbow
[Page E34](#)

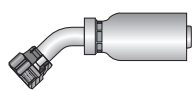

13956
FM JIC 37° Swivel 90°
Elbow Short Drop
[Page E34](#)

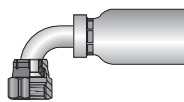

13E56
Male (JIC) 37°
Rigid Long
[Page E34](#)

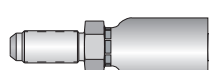

14156
Female (JIC) 37° Swivel
90° Elbow Long
[Page E35](#)

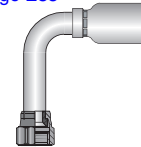

16756
SAE Male Inverted
Swivel 45° Elbow
[Page E35](#)

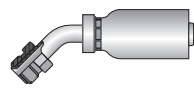

16956
SAE Male Inverted
Swivel 90° Elbow
[Page E35](#)

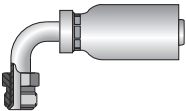

1L956
Female JIC 37° Swivel
90° Elbow - Med. Drop
[Page E39](#)

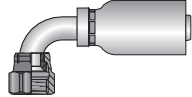

NPTF Fittings

10156
Male Taper Pipe
Rigid
[Page E32](#)

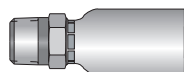

10256
Female Taper Pipe
Rigid
[Page E32](#)

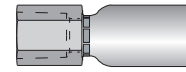

10756
Female Pipe Swivel
[Page E33](#)

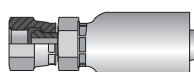

11356
Male Pipe Swivel
[Page E34](#)



ORFS (Seal-Lok™) Fittings

1J056
Male Seal-Lok™
Rigid Str. w/O-Ring
[Page E38](#)

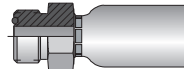

1J156
Female Seal-Lok™
90° Elbow - Long
[Page E38](#)

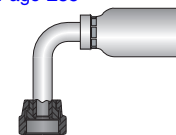

1J256
Female Seal-Lok™
30° Elbow
[Page E38](#)

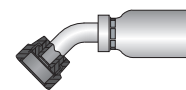

1J556
Female Seal-Lok™
90° Elbow - Med.
[Page E38](#)

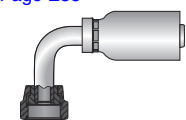



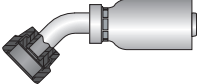
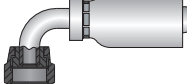
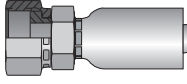
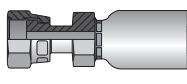
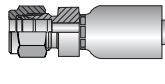
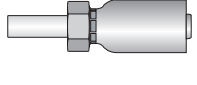
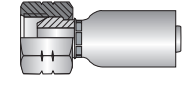
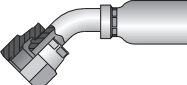
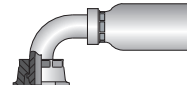
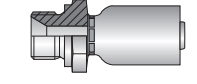
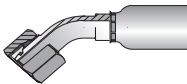
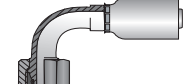
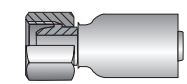
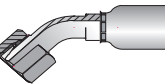
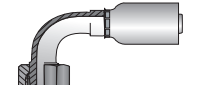
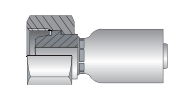
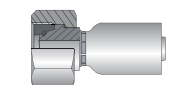
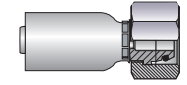
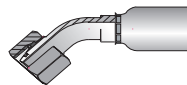
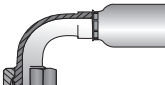
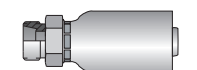
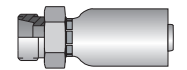



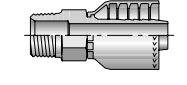
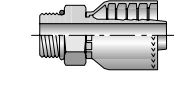
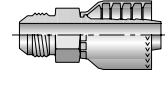
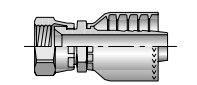
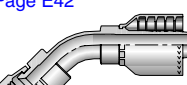
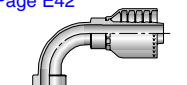
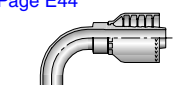
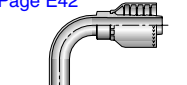



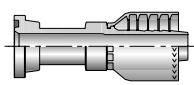
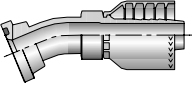
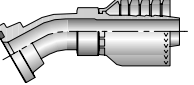
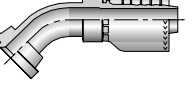
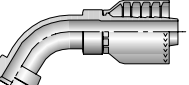
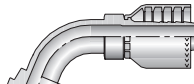
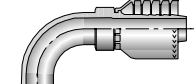
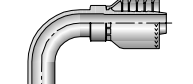
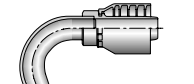
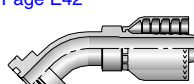
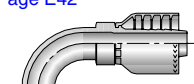

Permanent Hose Fittings – 56 Series (Continued)

<p>1J756 Female Seal-Lok™ 45° Elbow Page E38</p> 	<p>1J956 Female Seal-Lok™ 90° Elbow - Short Page E39</p> 	<p>1JC56 Female Seal-Lok™ Str. Swivel - Med. Page E39</p> 	<p>1JS56 Female Seal-Lok™ - Straight Page E39</p> 	<p>Specialty Fittings</p>	<p>1AL56 A-LOK Compression Page E35</p> 
<p>1TU56 Universal Inch Tube Stub End Page E39</p> 	<p>BSP Fittings</p>	<p>19256 FM BSP Parallel Pipe Swivel Str. Page E35</p> 	<p>1B156 Female BSP Pipe Swivel 45° Elbow (60° Cone) Page E35</p> 		<p>1B256 Female BSP Pipe Swivel 90° Elbow (60° Cone) Page E35</p> 
<p>1D956 Male BSPP - Str. (60° Cone) Page E38</p> 	<p>Metric Fittings</p>	<p>10C56 M FM Swivel 24° O-Ring 45° Elbow Lt. Page E34</p> 	<p>11C56 M FM Swivel 24° O-Ring 90° Elbow Lt. Page E34</p> 	<p>1C356 M FM Swivel Nut Light Page E36</p> 	<p>1C456 M FM Swivel 45° Elbow Light Page E36</p> 
<p>1C556 M FM Swivel 90° Elbow Light Page E36</p> 	<p>1C656 M FM Swivel DIN 20078 HW w/o O-Ring Page E36</p> 	<p>1C956 M FM Swivel DIN 20078 HW O-Ring Page E36</p> 	<p>1CA56 M FM Swivel 24° Light O-Ring Page E37</p> 	<p>1CE56 M FM Swivel 24° O-Ring 45° Elbow Page E37</p> 	<p>1CF56 M FM Swivel 24° O-Ring 90° Elbow Page E37</p> 
<p>1D056 M Male Stud DIN 20078 Light Page E37</p> 	<p>1D256 M Male Stud 24° Light Page E37</p> 				

Permanent Hose Fittings – 71 Series

<p>NPTF Pipe</p>	<p>10171 Male - Rigid Page E40</p> 	<p>SAE</p>	<p>10571 Male - Rigid Page E40</p> 	<p>JIC</p>	<p>10371 Male - Rigid Page E40</p> 
<p>10671 Female - Swivel Page E40</p> 	<p>13771 Female - Swivel 45° Elbow - Short Page E42</p> 	<p>13971 Female - Swivel 90° Elbow - Short Page E42</p> 	<p>1L971 Female - Swivel 90° Elbow - Medium Page E44</p> 	<p>14171 Female - Swivel 90° Elbow - Long Page E42</p> 	

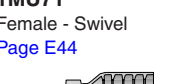
Permanent Hose Fittings – 71 Series (Continued)

Code 61 Flange	11571 Flange Page E40 	11671 22-1/2° Elbow Page E41 	12671 30° Elbow Page E41 	11771 45° Elbow Page E41 	12771 60° Elbow Page E41 
	11871 67-1/2° Elbow Page E41 	11971 90° Elbow Page E41 	18971 90° Elbow - Long Page E42 	12U71 110° Elbow Page E42 	Code 62 Flange
16F71 45° Elbow Page E42 	16N71 90° Elbow Page E42 	Seal-Lok™ (O-Ring Face Seal)	1J071 Male - Rigid Page E43 	1JC71 Female - Swivel - Short Page E44 	
1J771 Female - Swivel 45° Elbow Page E44 	1J971 Female Swivel - 90° Elbow - Short Page E44 		1J571 Female Swivel - 90° Elbow - Medium Page E43 	1J171 Female Swivel - 90° Elbow - Long Page E43 	Metric "S"
1C971 Female - Swivel Page E43 	BSP	1UT71 Male - Rigid Page E44 	1GU71 Female - Swivel Page E43 	1FU71 Female - Swivel Page E43 	
Metric		1MU71 Female - Swivel Page E44 	1XU71 Female - Swivel Page E45 		

Permanent Hose Fittings – 77 Series

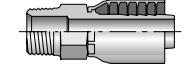
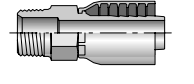
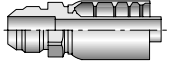
NPTF Pipe	10177 Male - Rigid Page E45 	API	1AP77 Male - Rigid Page E49 	JIC 37°	10377 Male - Rigid Page E45 

Permanent Hose Fittings – 77 Series (Continued)

10677

Female - Swivel
Straight
[Page E45](#)

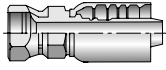

13777

Female - Swivel
45° Elbow - Short
[Page E47](#)

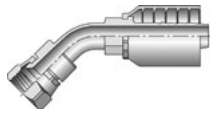

13977

Female - Swivel
90° Elbow - Short
[Page E47](#)

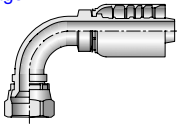

14177

Female - Swivel
90° Elbow - Long
[Page E47](#)

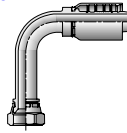

Straight Thread O-Ring

10577

Male - Rigid
[Page E45](#)

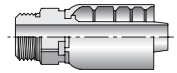

Full Flange

1X577

Full Flange - Straight
[Page E51](#)

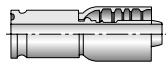

1X777

45° Elbow
[Page E51](#)

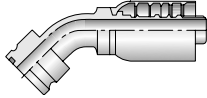

1X977

90° Elbow
[Page E51](#)

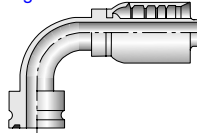

Flange Code 61

11577

Code 61 - Straight
[Page E46](#)

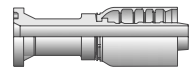

14A77

Code 61 - Straight
[Page E47](#)

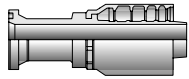

11677

Code 61
22-1/2° Elbow
[Page E46](#)

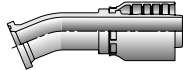

14B77

Code 61
22-1/2° Elbow
[Page E47](#)

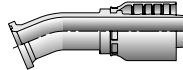

12677

Code 61 - 30° Elbow
[Page E46](#)

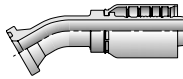

11777

Code 61 - 45° Elbow
[Page E46](#)



14F77

Code 61 - 45° Elbow
[Page E47](#)

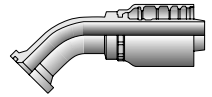

12777

Code 61 - 60° Elbow
[Page E46](#)

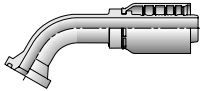

14G77

Code 61 - 60° Elbow
[Page E47](#)

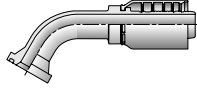

18777

Code 61 -
67-1/2° Elbow
[Page E46](#)

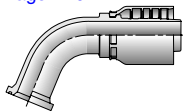

11977

Code 61 - 90° Elbow
[Page E46](#)

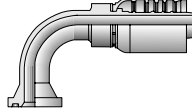

14N77

Code 61 - 90° Elbow
[Page E48](#)

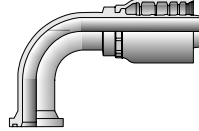

Flange Code 62

16A77

Code 62 - Straight
[Page E48](#)

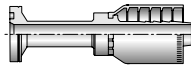

16B77

Code 62
22-1/2° Elbow
[Page E48](#)

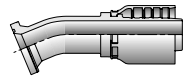

16E77

Code 62 - 30° Elbow
[Page E48](#)

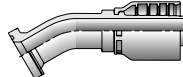

16F77

Code 61 - 45° Elbow
[Page E48](#)

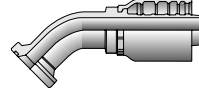

16G77

Code 62 - 60° Elbow
[Page E48](#)

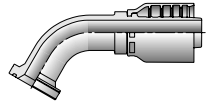

16N77

Code 62 - 90° Elbow
[Page E48](#)

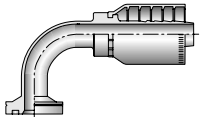

Caterpillar® Flange

1XA77

Caterpillar® - Flange
[Page E51](#)

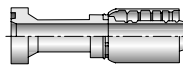

1XB77

Caterpillar® Flange
22-1/2° Elbow
[Page E51](#)

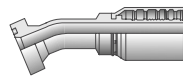

1XE77

Caterpillar® Flange
30° Elbow
[Page E51](#)

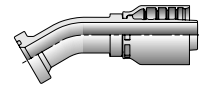

1XF77

Caterpillar® Flange
45° Elbow
[Page E51](#)

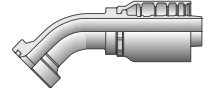

1XG77

Caterpillar® Flange
60° Elbow
[Page E52](#)

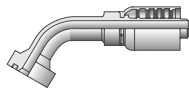

1XM77

Caterpillar® Flange
67-1/2° Elbow
[Page E52](#)

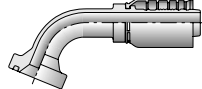

1XN77

Caterpillar® Flange
90° Elbow
[Page E52](#)

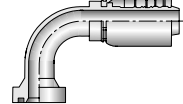

Komatsu® Flange

1K577

Komatsu® Flange
Straight
[Page E50](#)

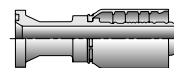

1K777

Komatsu® Flange
45° Elbow
[Page E50](#)

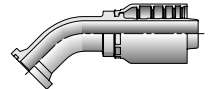

1K977

Komatsu® Flange
90° Elbow
[Page E51](#)

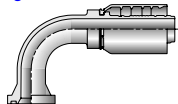

Seal-Lok™

1JC77

Female - Swivel
Straight - Short
[Page E50](#)

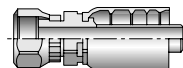

1JS77

Female - Swivel
Straight - Long
[Page E50](#)

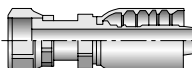

1J077

Male - Rigid
w/O-Ring
[Page E49](#)

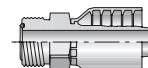

1J777

Female - Swivel
45° Elbow
[Page E50](#)

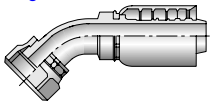

Permanent Hose Fittings – 77 Series (Continued)

1J977
Female - Swivel
90° Elbow - Short
[Page E50](#)

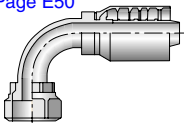

1J577
Female - Swivel
90° Elbow - Medium
[Page E50](#)

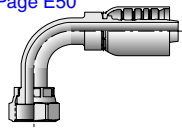

1J177
Female - Swivel
90° Elbow - Long
[Page E49](#)

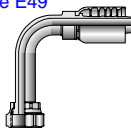

DIN "S" Series w/O-Ring

1D277
Male Metric S
Rigid - 24° Cone
[Page E49](#)

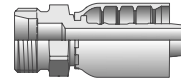

1C977
Female - Swivel
Straight
[Page E49](#)

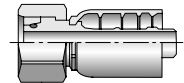

10C77
Female Metric S
Swivel - 45° Elbow
[Page E45](#)

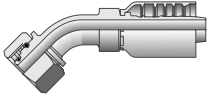

11C77
Female - Swivel
90° Elbow
[Page E46](#)

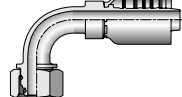

BSP

1FU77
Female - Swivel
Straight - 30° Flare
[Page E49](#)

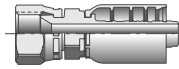

1GU77
Female - Swivel
Straight - 60° Cone
[Page E49](#)

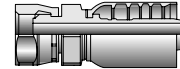

24° Cone

1ZM77
Male 24° Cone
[Page E52](#)

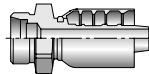

Permanent Hose Fittings – 79 Series

Code 62 Flange

16A79
Flange
[Page E52](#)

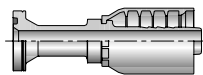

16F79
45° Elbow
[Page E52](#)

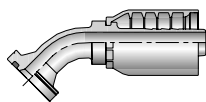

16G79
60° Elbow
[Page E52](#)

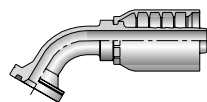

16N79
90° Elbow
[Page E52](#)

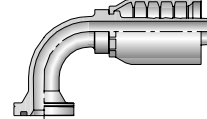

Seal-Lok™ (O-Ring Face Seal)

1JS79
Female - Swivel
Long
[Page E53](#)

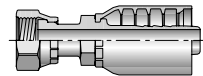

1J779
Female - Swivel
45° Elbow
[Page E53](#)

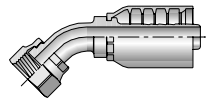

1J979
Female - Swivel
90° Elbow - Short
[Page E53](#)

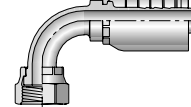

Flange Head

1XA79
Flange Head
[Page E53](#)

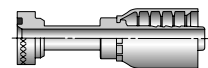

1XF79
45° Elbow
[Page E53](#)

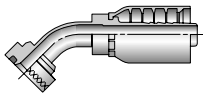

1XN79
90° Elbow
[Page E53](#)

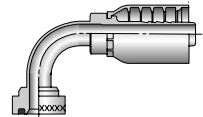

Permanent Hose Fittings – 81 Series

81 Series Crimp Shell

10081
Crimp Shell
[Page E53](#)



81 Series consists of a 10081 crimp shell and is completed by adding any 88 Series fittings. See pages D19 and D20 for Series 88 fittings.

Permanent Hose Fittings – 91N/91Series

91N/91 Series

10191/10191N
Male Taper Pipe Rigid
Page E54

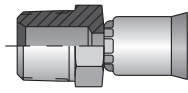

10391
Male JIC 37°
Page E54

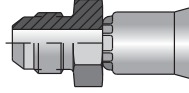

10691
JIC 37° Female Swivel
Page E54

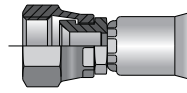

10791
Female Pipe Swivel
Page E54

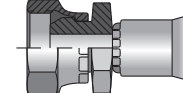

10891
Female SAE 45° Swivel
Page E54

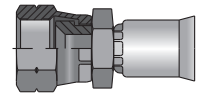

12891
Male Inverted Swivel
Straight
Page E54

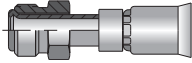

13491
Straight Tube
Page E54

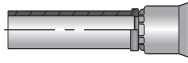

13791
Female JIC 37°
Swivel 45° Elbow
Page E55

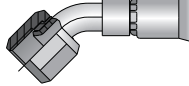

13991
Female JIC 37°
Swivel 90° Elbow
Page E55

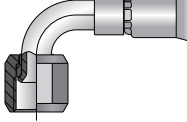

14191
Female JIC 37°
Swivel 90° Elbow Long
Page E55

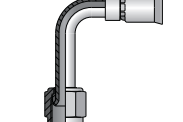

16191N
Compression Air Brake
Page I17

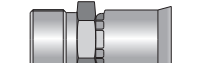

16791
SAE Male Inverted
45° Elbow
Page E55

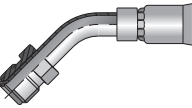

16991
SAE Male Inverted
90° Elbow
Page E55

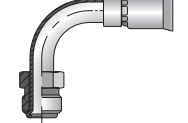

17791
SAE 45° Swivel
45° Elbow
Page E56

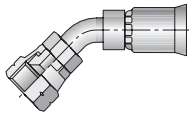

17991
Female SAE 45° Swivel
90° Elbow
Page E56

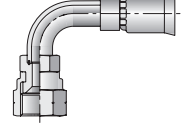

19291
Female BSP Pipe Swivel
Str. (60° Cone)
Page E56

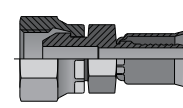

1B291
Female BSP Pipe
Swivel 45° Elbow
(60° Cone)
Page E56

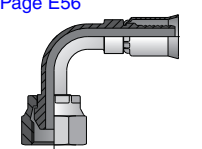

1J191
Female Seal-Lok™
90° Elbow Long
Page E56

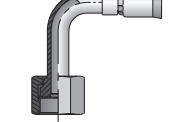

1J791
Female Seal-Lok™
45° Elbow
Page E57

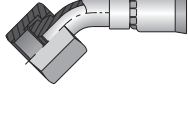

1J991
Female Seal-Lok™
90° Elbow
Page E57

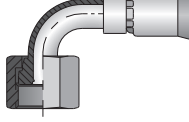

1JC91
Female Seal-Lok™
Swivel Straight Short
Page E57

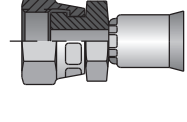

1TU91
Universal Tube Stub End
Page E57

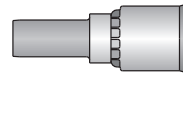

Permanent Hose Fittings – 93 Series

93N Series

10193N
Male Taper Pipe Rigid
Page E57

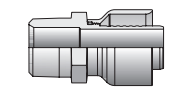

10693N
Female JIC 37° Swivel
Page E57

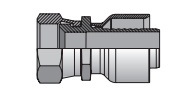

13793N
Female JIC 37°
Swivel 45° Elbow
Page E58

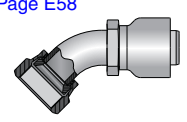

13993N
Female JIC 37°
Swivel 90° Elbow
Page E58

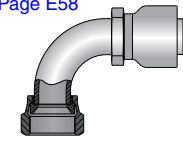

14K93N
ANSI B16.5 Flange
Page E58

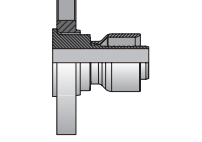

1J793N
Female Seal-Lok™
45° Elbow
Page E58

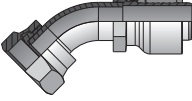

1J993N
Female Seal-Lok™
90° Elbow
Page E58



1JC93N
Female Seal-Lok™
Swivel Straight Short
Page E58

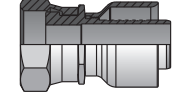

Permanent Hose Fittings – CY Series

CY Series

101CY
Male Taper Pipe Rigid
Page E58

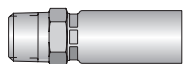

102CY
Female Pipe Thread
Page E58

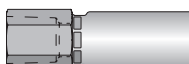

106CY
JIC 37° Female
Swivel
Page E59

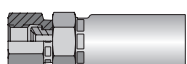

113CY
Male Pipe Swivel
Page E59

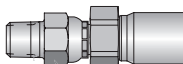

139CY
Female JIC 37°
Swivel 90° Elbow
Page 59

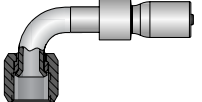

Permanent Hose Fittings – CY Series (Continued)

1GKCY

Bulkhead w/Zerk
Port Integrated
[Page E59](#)

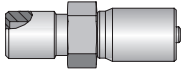

1J9CY

Female Seal-Lok™
90° Elbow
[Page E59](#)

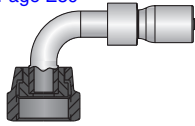

1JCCY

Female Seal-Lok™
Swivel Straight Short
[Page E59](#)

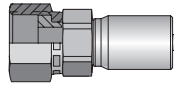

1LMCY

Male Grease
[Page E59](#)

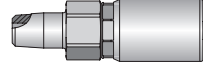

Permanent Hose Fittings – HY Series

NPTF Pipe

101HY

Male - Rigid
[Page E60](#)

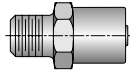

113HY

Male - Swivel
[Page E62](#)



11LHY

Male - Swivel
90° Elbow
[Page E62](#)

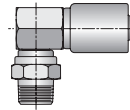

102HY

Female - Rigid
[Page E60](#)

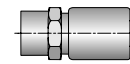

NPSM Pipe

107HY

Female - Swivel
(60° Cone)
[Page E61](#)

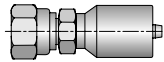

Straight Thread

105HY
Male - Rigid
[Page E60](#)

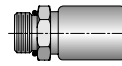

10GHY
Male - Swivel
[Page E61](#)

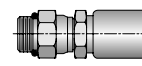

10LHY
Swivel - Swivel
90° Elbow
[Page E61](#)

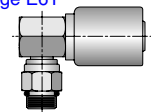

JIC 37°

103HY

Male - Rigid
[Page E60](#)

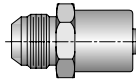

106HY

Female - Swivel
[Page E61](#)

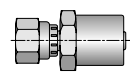

137HY

Female - Swivel
45° Elbow - Short
[Page E62](#)

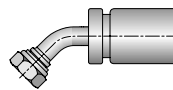

139HY

Female - Swivel
90° Elbow - Short
[Page E63](#)

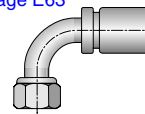

141HY

Female - Swivel
45° Elbow - Long
[Page E63](#)

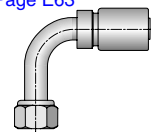

193HY

Female - Swivel
90° Elbow - Block
[Page E63](#)

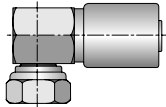

SAE 45°

108HY

Female - Swivel
[Page E61](#)

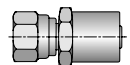

177HY

Female - Swivel
45° Elbow
[Page E63](#)

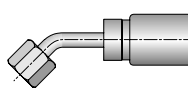

179HY

Female - Swivel
90° Elbow
[Page E63](#)

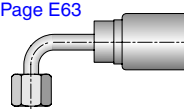

Flareless

111HY

Male - Rigid
[Page E62](#)

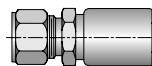

Grease Connection

1GJHY
Female - Rigid
[Page E64](#)

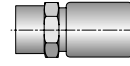

Standpipe

134HY
Male Standpipe Rigid
[Page E62](#)

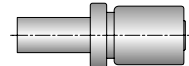

Inverted Flare

128HY

Male - Swivel
[Page E62](#)

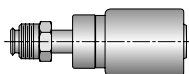

167HY

Male - Swivel
45° Elbow
[Page E63](#)

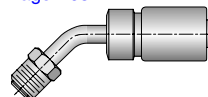

169HY

Male - Swivel
90° Elbow
[Page E63](#)

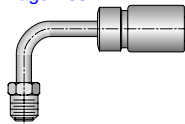

129HY

Female - Rigid
[Page E62](#)

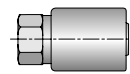

Permanent Hose Fittings – HY Series (Continued)

**Seal-Lok®
(O-Ring
Face Seal)**

1J0HY
Male - Rigid
w/O-Ring
[Page E64](#)

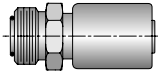

1JCHY
Female - Swivel
Short
[Page E65](#)

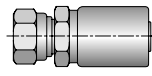

1JSHY
Female - Swivel
Long
[Page E65](#)

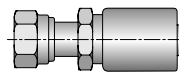

1J7HY
Female - Swivel
45° Elbow
[Page E64](#)

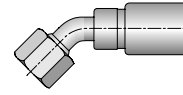

1J9HY
Female - Swivel
90° Elbow - Short
[Page E65](#)

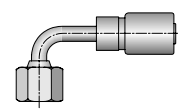

1J1HY
Female - Swivel
90° Elbow - Long
[Page E64](#)

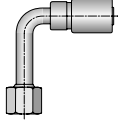

**Metric
L & S**

1D0HY
Male - Rigid
[Page E64](#)

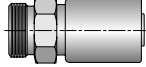

13DHY
Male Standpipe Rigid
[Page E63](#)

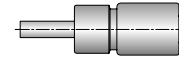

BSP

1D9HY
Male - Rigid
[Page E64](#)



1GUHY
Female - Swivel
[Page E64](#)

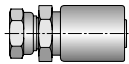

1UTHY
Male - Rigid
[Page E65](#)

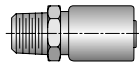

1XUHY
Female - Metric Swivel
[Page E65](#)

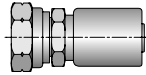

Permanent Hose Fittings – SF Series

SF Series

101SF
Male Taper Pipe Rigid
[Page E65](#)

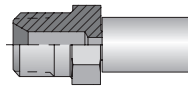

106SF
JIC 37° Swivel
[Page E65](#)

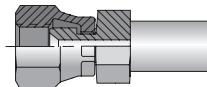

1JSSF
Female Seal-Lok™
Swivel Long
[Page E66](#)

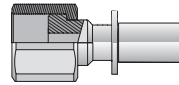

1JBSF
Male Seal-Lok™
Bulkhead w/O-Ring
[Page E65](#)

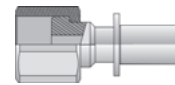

25 Series

10125

Male NPTF Pipe - Rigid

Part Number	Thread inch	Hose ID inch
10125-6-6B-VS	3/8x18	3/8
10125-6-8B-VS	3/8x18	1/2
10125-8-6B-VS	1/2x14	3/8
10125-8-8B-VS	1/2x14	1/2

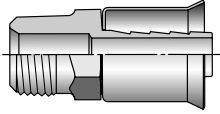

10825

Female SAE 45° - Swivel

Part Number	Thread inch	Hose ID inch
10825-6-6B	5/8x18	3/8
10825-8-6B	3/4x16	3/8
10825-8-8B	3/4x16	1/2

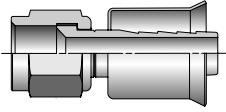

26 Series

10126

Male NPTF Pipe - Rigid

Part Number	Thread inch	Hose ID inch
10126-2-4	1/8x27	3/16
10126-4-4	1/4x18	3/16
10126-4-5	1/4x18	1/4
10126-4-6	1/4x18	5/16
10126-6-6	3/8x18	5/16
10126-6-8	3/8x18	13/32
10126-8-8	1/2x14	13/32
10126-8-10	1/2x14	1/2
10126-12-12	3/4x14	5/8
10126-16-16	1x11-1/2	7/8
10126-20-20	1-1/4x11-1/2	1-1/8
10126-24-24	1-1/2x11-1/2	1-3/8
10126-32-32	2x11-1/2	1-13/16

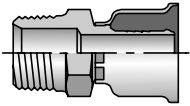

10326

Male JIC 37° - Rigid

Part Number	Thread inch	Hose ID inch
10326-4-4	1/4 7/16x20	3/16
10326-6-6	3/8 9/16x18	5/16
10326-8-8	1/2 3/4x16	13/32
10326-10-10	5/8 7/8x14	1/2
10326-16-16	1 1-5/16x12	7/8
10326-20-16	1-1/4 1-5/8x12	7/8
10326-20-20	1-1/4 1-5/8x12	1-1/8

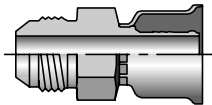

10426

Male SAE 45° - Rigid

Part Number	Thread inch	Hose ID inch
10426-4-4	1/4 7/16x20	3/16

Notch on nut signifies SAE 45° flare fitting.

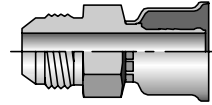

10626

Female JIC 37° - Swivel

Part Number	Thread inch	Hose ID inch
10626-6-6	3/8 9/16x18	5/16
10626-6-8	3/8 9/16x18	13/32
10626-12-12	3/4 1-1/16x12	5/8
10626-16-16	1 1-5/16x12	7/8
10626-20-20	1-1/4 1-5/8x12	1-1/8
10626-24-24	1-1/2 1-7/8x12	1-3/8
10626-32-32	2 2-1/2x12	1-13/16

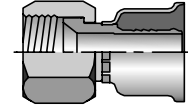

10826

Female SAE 45° - Swivel

Part Number	Thread inch	Hose ID inch
10826-6-6	3/8 5/8x18	5/16
10826-10-8	5/8 7/8x14	13/32
10826-10-10	5/8 7/8x18	1/2
10826-12-12	3/4 1-1/16x14	5/8

Notch on nut signifies SAE 45° flare fitting.

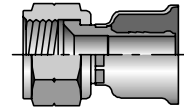

12826

Male Inverted SAE 45° - Swivel

Part Number	Thread inch	Hose ID inch
12826-4-4	1/4 7/16x24	3/16
12826-5-5	5/16 1/2x20	1/4
12826-6-6	3/8 5/8x18	5/16
12826-8-8	1/2 3/4x18	13/32
12826-10-10	5/8 7/8x18	1/2

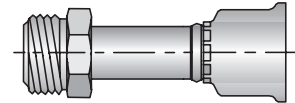

25 Series: Use with [271 hose](#).

26 Series: Use with [201](#), [206](#), [213](#), [221FR](#), [244](#), [266](#), [285](#), [293](#), [SS23CG](#) hoses.

Dimensions and pressures are for reference only and are subject to change.

13726

Female JIC 37° - Swivel - 45° Elbow - Short Drop

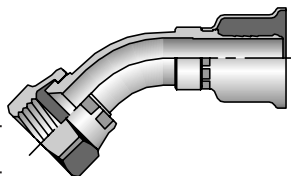

Part Number	Thread inch	Hose ID inch
13726-4-4	1/4 7/16x20	3/16
13726-6-6	3/8 9/16x18	5/16
13726-8-8	1/2 3/4x16	13/32
13726-10-10	5/8 7/8x14	1/2
13726-10-12	5/8 7/8x14	5/8
13726-12-12	3/4 1-1/16x12	5/8
13726-16-16	1 1-5/16x12	7/8
13726-20-20	1-1/4 1-5/8x12	1-1/8
13726-24-24	1-1/2 1-7/8x12	1-3/8

13926

Female JIC 37° - Swivel - 90° Elbow - Short Drop

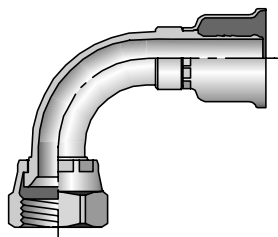

Part Number	Thread inch	Hose ID inch
13926-4-4	1/4 7/16x20	3/16
13926-6-6	3/8 9/16x18	5/16
13926-8-8	1/2 3/4x16	13/32
13926-10-10	5/8 7/8x14	1/2
13926-10-12	5/8 7/8x14	5/8
13926-12-12	3/4 1-1/16x12	5/8
13926-16-16	1 1-5/16x12	7/8
13926-20-20	1-1/4 1-5/8x12	1-1/8
13926-24-24	1-1/2 1-7/8x12	1-3/8

14126

Female JIC 37° - Swivel - 90° Elbow - Long Drop

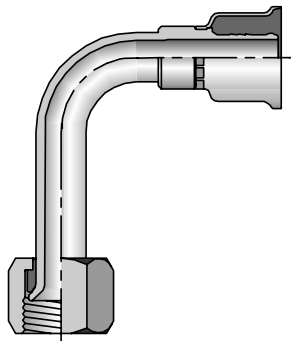

Part Number	Thread inch	Hose ID inch
14126-4-4	1/4 7/16x20	1/4
14126-6-6	3/8 9/16x18	5/16
14126-8-8	1/2 3/4x16	13/32
14126-10-10	5/8 7/8x14	1/2
14126-12-12	3/4 1-1/16x12	5/8
14126-16-16	1 1-5/16x12	7/8

Notch on nut signifies SAE 45° flare fitting.

14526-PR

Male Tube-O - Swivel - Long Pilot With Charge Port for R12

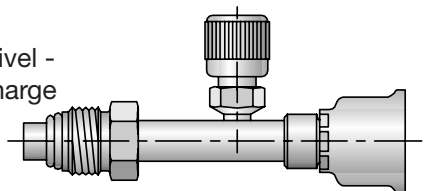

Part Number	Thread inch	Hose ID inch
14526-6-6-PR	3/8 5/8x18	5/16

14526-PT

Male Tube-O - Swivel - Long Pilot With Low Pressure Charge Port for R134a

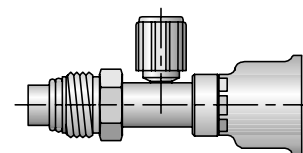

Part Number	Thread inch	Hose ID inch
14526-10-12-PT	5/8 7/8x18	5/8

15926-PB

Female Tube-O - Swivel - Long Pilot With High Pressure Charge Port for R134a

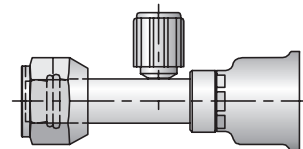

Part Number	Thread inch	Hose ID inch
15926-6-6-PB	3/8 5/8x18	5/16
15926-8-8-PB	1/2 3/4x16	13/32

15926-PT

Female Tube-O - Swivel - Long Pilot With Low Pressure Charge Port for R134a

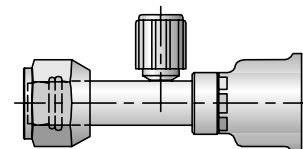

Part Number	Thread inch	Hose ID inch
15926-10-12-PT	5/8 7/8x14	5/8

15G26

Male Tube-O - Rigid - Internal Long Pilot (3-Step)

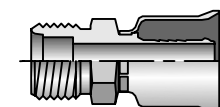

Part Number	Thread inch	Hose ID inch
15G26-6-6	3/8 5/8x18	3/8
15G26-8-8	1/2 3/4x16	13/32
15G26-10-10	5/8 7/8x14	1/2
15G26-10-12	5/8 7/8x14	5/8

15G26-PR

Male Tube-O - Rigid - Internal Long Pilot (3-Step) With Charge Port for R12

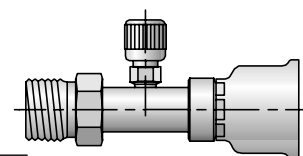

Part Number	Thread inch	Hose ID inch
15G26-10-12-PR	5/8 7/8x14	5/8

26 Series: Use with 201, 206, 213, 221FR, 244, 266, 285, 293, SS23CG hoses.
Dimensions and pressures are for reference only and are subject to change.

15H26

Female Tube-O - Swivel -
45° Elbow - Short Pilot

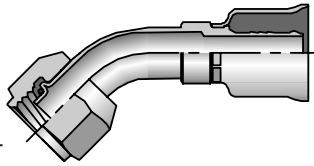

Part Number	Thread inch	Hose ID inch
15H26-6-6	3/8 5/8x18	5/16
15H26-8-8	1/2 3/4x16	13/32
15H26-10-10	5/8 7/8x14	1/2
15H26-10-12	5/8 7/8x14	3/4

15K26

Male Tube-O - Swivel -
90° Elbow - Short Pilot

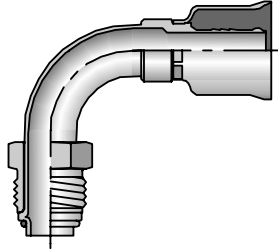

Part Number	Thread inch	Hose ID inch
15K26-6-6	3/8 5/8X18	5/16
15K26-7-6	7/16 11/16x16	5/16
15K26-8-8	1/2 3/4x18	13/32
15K26-10-10	5/8 7/8x18	1/2
15K26-10-12	5/8 7/8x18	5/8

15K26-PB

Male Tube-O - Swivel -
90° Elbow - Short Pilot
with High Pressure Charge
Port for R134a

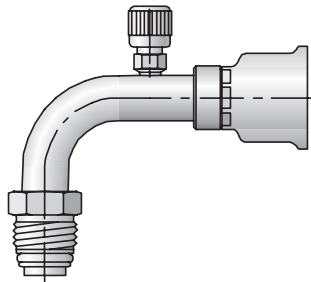

Part Number	Thread inch	Hose ID inch
15K26-8-8-PB	1/2 3/4x16	13/32

15K26-PR

Male Tube-O - Swivel -
90° Elbow - Short Pilot with
Charge Port for R12

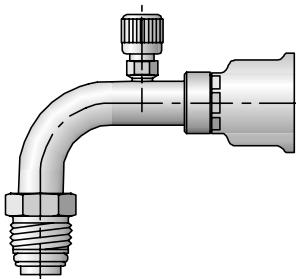

Part Number	Thread inch	Hose ID inch
15K26-10-10-PR	5/8 7/8x18	1/2
15K26-10-12-PR	5/8 7/8x18	5/8

15L26

Female Tube-O - Swivel -
90° Elbow - Long Pilot

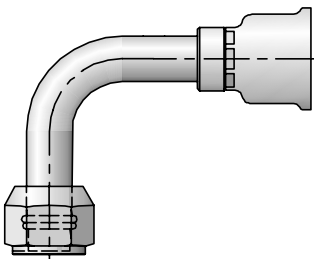

Part Number	Thread inch	Hose ID inch
15N26-10-12-PT	5/8 7/8x14	5/8

15L26-PB

Female Tube-O - Swivel -
90° Elbow - Long Pilot With
High Pressure Charge Port
for R134a

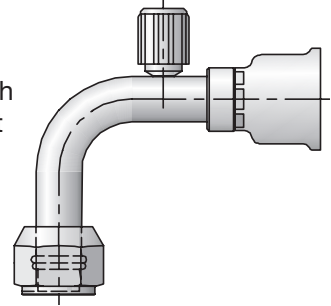

Part Number	Thread inch	Hose ID inch
15L26-6-6-PB	3/8 5/8x18	5/16
15L26-8-8-PB	1/2 3/4x16	13/32

15L26-PR

Female Tube-O - Swivel -
90° Elbow - Long Pilot With
Charge Port for R12

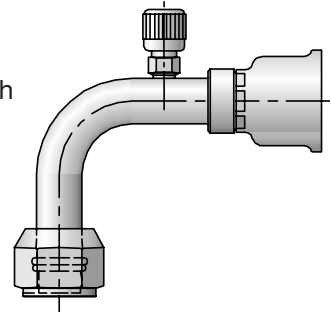

Part Number	Thread inch	Hose ID inch
15L26-8-8-PR	1/2 3/4x16	13/32
15L26-10-10-PR	5/8 7/8x14	1/2
15L26-10-12-PR	5/8 7/8x14	5/8

15L26-PT

Female Tube-O - Swivel -
90° Elbow - Long Pilot With
Low Pressure Charge Port
for R134a

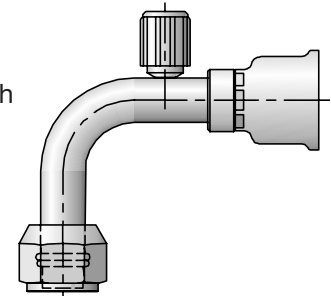

Part Number	Thread inch	Hose ID inch
15L26-10-10-PT	5/8 7/8X14	1/2
15L26-10-12-PT	5/8 7/8x14	5/8
15L26-12-12-PT	3/4 1-1/16x14	5/8

15M26-PR

Male Tube-O - Swivel -
90° Elbow - Long Pilot With
Charge Port for R12

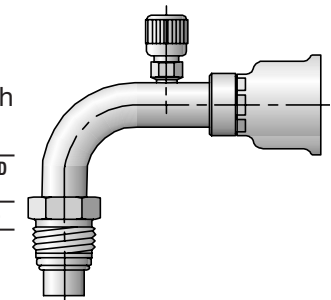

Part Number	Thread inch	Hose ID inch
15M26-6-6-PR	3/8 5/8x18	5/16

26 Series: Use with [201](#), [206](#), [213](#), [221FR](#), [244](#), [266](#), [285](#), [293](#), [SS23CG](#) hoses.
Dimensions and pressures are for reference only and are subject to change.

15M26-PT

Male Tube-O - Swivel - 90° Elbow - Long Pilot With Low Pressure Charge Port for R134a

Part Number	Thread inch	Hose ID inch
15M26-10-12-PT	5/8 7/8x18	5/8

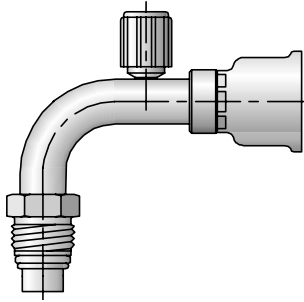

15S26

Female Tube-O - Swivel - Short Pilot

Part Number	Thread inch	Hose ID inch
15S26-6-6	3/8 5/8x18	5/16
15S26-8-8	1/2 3/4x16	13/32
15S26-10-10	5/8 7/8x14	1/2
15S26-10-12	5/8 7/8x14	5/8
15S26-12-12	3/4 1-1/16x14	5/8

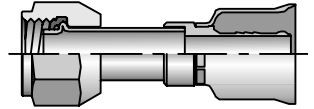

15N26-PB

Female Tube-O - Swivel - 45° Elbow - Long Pilot With High Pressure Charge Port for R134a

Part Number	Thread inch	Hose ID inch
15N26-10-12-PT	5/8 7/8x14	5/8

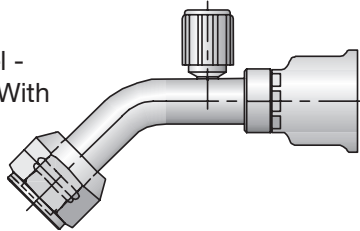

15T26

Female Tube-O - Swivel - 90° Elbow - Short Pilot

Part Number	Thread inch	Hose ID inch
15T26-6-6	3/8 5/8x18	5/16
15T26-8-8	1/2 3/4x16	13/32
15T26-10-10	5/8 7/8x14	1/2
15T26-10-12	5/8 7/8x14	5/8
15T26-12-12	3/4 1-1/16x14	5/8

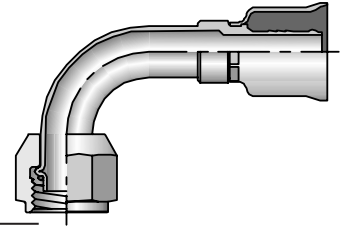

15N26-PT

Female Tube-O - Swivel - 45° Elbow - Long Pilot With Low Pressure Charge Port for R134a

Part Number	Thread inch	Hose ID inch
15N26-10-12-PT	5/8 7/8x14	5/8

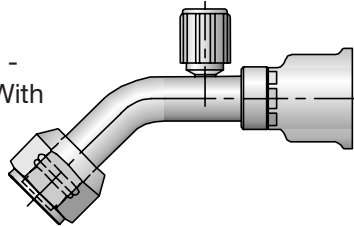

15V26

Female Compressor - Swivel - 45° Elbow

Part Number	Thread inch	Hose ID inch
15V26-12-8	1x14	13/32
15V26-12-12	1x14	5/8

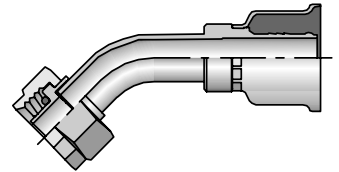

15P26-PT

Male Tube-O - Swivel - 45° Elbow - Long Pilot With Low Pressure Charge Port for R134a

Part Number	Thread inch	Hose ID inch
15P26-10-12-PT	5/8 7/8x18	5/8

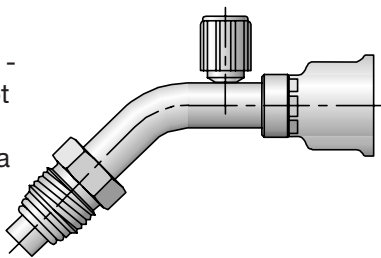

15W26

Female Compressor - Swivel - 90° Elbow

Part Number	Thread inch	Hose ID inch
15W26-12-8	1x14	13/32
15W26-12-12	1x14	5/8

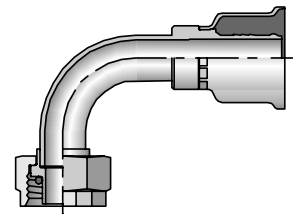

15R26

Male Tube-O - Swivel - 45° Elbow - Short Pilot

Part Number	Thread inch	Hose ID inch
15R26-6-6	3/8 5/8x18	5/16
15R26-7-6	7/16 11/16x16	5/16
15R26-8-8	1/2 3/4x18	13/32
15R26-10-10	5/8 7/8x18	1/2
15R26-10-12	5/8 7/8x18	5/8

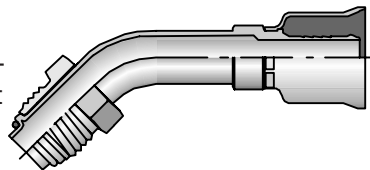

15Z26

Female Compressor - Swivel - 90° Elbow - Block Type

Part Number	Thread inch	Hose ID inch
15Z26-12-8	1X14	13/32
15Z26-12-12	1X14	5/8

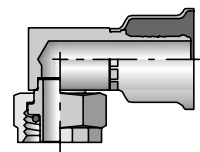

26 Series: Use with 201, 206, 213, 221FR, 244, 266, 285, 293, SS23CG hoses.
Dimensions and pressures are for reference only and are subject to change.

16726

Male Inverted SAE 45° - Swivel - 45° Elbow

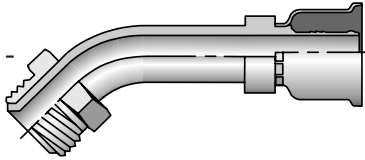

Part Number	Thread inch	Hose ID inch
16726-4-4	1/4 7/16x24	3/16
16726-5-5	5/16 1/2x20	1/4
16726-6-6	3/8 5/8x18	5/16
16726-8-8	1/2 3/4x18	13/32

16826

Female JIC 37° / SAE 45° - Dual Flare - Swivel

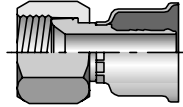

Part Number	Thread inch	Hose ID inch
16826-4-4	1/4 7/16x20	3/16
16826-4-5	1/4 7/16x20	1/4
16826-5-5	5/16 1/2x20	1/4
16826-8-6	1/2 3/4x16	5/16
16826-8-8	1/2 3/4x16	13/32
16826-8-10	1/2 3/4x16	1/2
16826-10-10	5/8 7/8x14	1/2
16826-10-12	5/8 7/8x14	5/8

16926

Male Inverted SAE 45° - Swivel - 90° Elbow

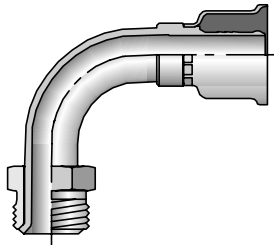

Part Number	Thread inch	Hose ID inch
16926-4-4	1/4 7/16x24	3/16
16926-5-5	5/16 1/2x20	1/4
16926-6-6	3/8 5/8x18	5/16
16926-8-8	1/2 3/4x18	13/32
16926-10-10	5/8 7/8x18	1/2

17726

Female SAE 45° - Swivel - 45° Elbow

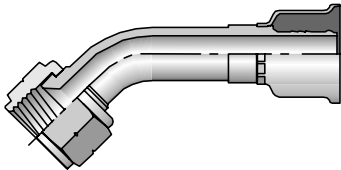

Part Number	Thread inch	Hose ID inch
17726-4-4	1/4 7/16x20	3/16
17726-6-6	3/8 5/8x18	5/16
17726-8-8	1/2 3/4x16	13/32
17726-10-10	5/8 7/8x14	1/2
17726-10-12	5/8 7/8x14	5/8
17726-12-12	3/4 1-1/16x14	5/8

Notch on nut signifies SAE 45° flare fitting.

17926

Female SAE 45° - Swivel - 90° Elbow

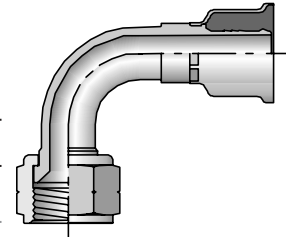

Part Number	Thread inch	Hose ID inch
17926-4-4	1/4 7/16x20	3/16
17926-6-6	3/8 5/8x18	5/16
17926-8-8	1/2 3/4x16	13/32
17926-10-10	5/8 7/8x14	1/2
17926-10-12	5/8 7/8x14	5/8
17926-12-12	3/4 1-1/16x14	5/8

Notch on nut signifies SAE 45° flare fitting.

1J726

Female Seal-Lok™ - Swivel - 45° Elbow

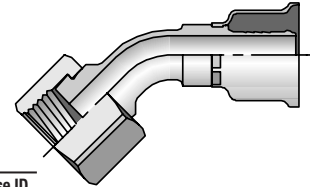

Part Number	Thread inch	Hose ID inch
1J726-4-4	1/4 9/16x18	3/16
1J726-6-6	3/8 1-1/16x16	5/16
1J726-8-8	1/2 13/16x16	13/32
1J726-10-10	5/8 1x14	1/2
1J726-12-12	3/4 1-3/16x12	5/8
1J726-16-16	1 1-7/16x12	7/8
1J726-20-20	1-1/4 1-11/16x12	1-1/8

1J926

Female Seal-Lok™ - Swivel - 90° Elbow - Short Drop

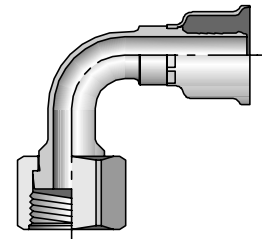

Part Number	Thread inch	Hose ID inch
1J926-4-4	1/4 9/16x18	3/16
1J926-6-6	3/8 1-1/16x16	5/16
1J926-8-8	1/2 13/16x16	13/32
1J926-10-10	5/8 1x14	1/2
1J926-12-12	3/4 1-3/16x12	5/8
1J926-16-16	1 1-7/16x12	7/8
1J926-20-20	1-1/4 1-11/16x12	1-1/8

26 Series: Use with 201, 206, 213, 221FR, 244, 266, 285, 293, SS23CG hoses.

Dimensions and pressures are for reference only and are subject to change.

1JC26

Female Seal-Lok™ - Swivel - Short

Part Number	Thread inch	Hose ID inch
1JC26-4-4	1/4 9/16x18	3/16
1JC26-6-6	3/8 11/16x16	5/16
1JC26-8-8	1/2 13/16x16	13/32
1JC26-12-12	3/4 1-3/16x12	5/8
1JC26-16-16	1 1-7/16x12	7/8
1JC26-20-20	1-1/4 1-11/16x12	1-1/8

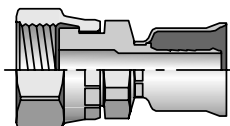

1S526-PR

Male Tube-O - Swivel - Short Pilot with Charge Port for R12

Part Number	Thread inch	Hose ID inch
1S526-10-10-PR	5/8 7/8x18	1/2
1S526-10-12-PR	5/8 7/8x18	5/8

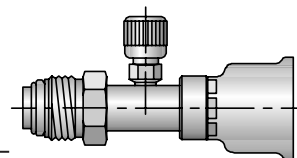

1RV26

Female Compressor - Swivel - 135° Elbow

Part Number	Hose ID inch
1RV26-12-8	13/32
1RV26-12-12	5/8

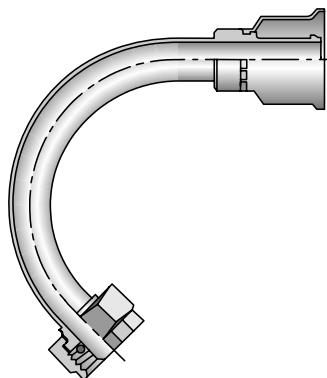

1T126

Male Refrigerant Tube Mender (with Nut and Ferrule)

Part Number	Thread inch	Hose ID inch
1T126-6-6	3/8 5/8x18	5/16
1T126-6-8	3/8 5/8x18	13/32
1T126-8-6	1/2 3/4x16	5/16
1T126-8-8	1/2 3/4x16	13/32
1T126-8-10	1/2 3/4x16	1/2
1T126-10-8	5/8 7/8x14	13/32
1T126-10-10	5/8 7/8x14	1/2
1T126-10-12	5/8 7/8x14	5/8
1T126-12-12	3/4 1-16x14	5/8

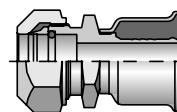

1T126 Assembly instructions are in [Section N](#).

1RZ26

Female Compressor - Swivel - 180° Elbow - Block Type RZ

Part Number	Hose ID inch
1RZ26-12-12	5/8

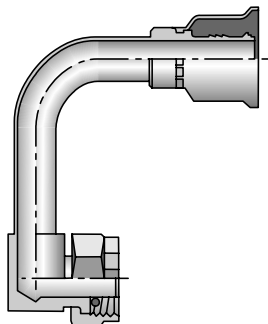

43 Series

10143

Male NPTF Pipe - Rigid

Part Number	Thread inch	Hose ID inch
10143-2-4	1/8x27	1/4
10143-4-4	1/4x18	1/4
10143-4-5	1/4x18	5/16
10143-4-6	1/4x18	3/8
10143-6-4	3/8x18	1/4
10143-6-5	3/8x18	5/16
10143-6-6	3/8x18	3/8
10143-6-8	3/8x18	1/2
10143-6-10	3/8x18	5/8
10143-8-4	1/2x14	1/4
10143-8-6	1/2x14	3/8
10143-8-8	1/2x14	1/2
10143-8-10	1/2x14	5/8
10143-8-12	1/2x14	3/4
10143-12-8	3/4x14	1/2
10143-12-10	3/4x14	5/8
10143-12-12	3/4x14	3/4
10143-12-16	3/4x14	1
10143-16-12	1x11-1/2	3/4
10143-16-16	1x11-1/2	1
10143-20-20	1-1/4x11-1/2	1-1/4
10143-24-24	1-1/2x11-1/2	1-1/2
10143-32-32	2x11-1/2	2

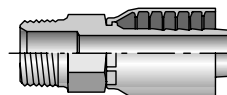

1S526

Male Tube-O - Swivel - Short Pilot

Part Number	Thread inch	Hose ID inch
1S526-6-6	3/8 5/8x18	5/16
1S526-7-6	11/16 11/16x16	5/16
1S526-8-8	1/2 3/4x18	13/32
1S526-10-10	5/8 7/8x18	1/2
1S526-10-12	5/8 7/8x18	5/8
1S526-12-12	3/4 1-1/16x16	5/8

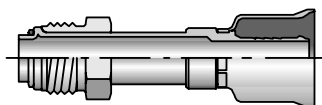

Stainless steel fittings must be assembled with [Karrykrimp 2](#), [PHastkrimp](#), [Superkrimp](#) or [Parkrimp 2](#). See www.parker.com/crimpsource for more information.

26 Series: Use with [201](#), [206](#), [213](#), [221FR](#), [244](#), [266](#), [285](#), [293](#), [SS23CG](#) hoses. Dimensions and pressures are for reference only and are subject to change.

10243

Female NPTF Pipe - Rigid

Part Number	Thread inch	Hose ID inch
10243-2-4	1/8x27	1/4
10243-4-4	1/4x18	1/4
10243-4-6	1/4x18	3/8
10243-6-4	3/8x18	1/4
10243-6-6	3/8x18	3/8
10243-8-6	1/2x14	3/8
10243-8-8	1/2x14	1/2
10243-12-12	3/4x14	3/4

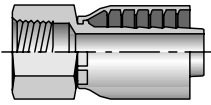

10343

Male JIC 37° - Rigid
ISO 12151-5

Part Number	Thread inch	Hose ID inch
10343-4-4	1/4	7/16x20
10343-5-4	5/16	1/2x20
10343-5-6	5/16	1/2x20
10343-6-4	3/8	9/16x18
10343-6-6	3/8	9/16x18
10343-8-6	1/2	3/4x16
10343-8-8	1/2	3/4x16
10343-8-10	1/2	3/4x16
10343-10-6	5/8	7/8x14
10343-10-8	5/8	7/8x14
10343-10-10	5/8	7/8x14
10343-12-8	3/4	1-1/16x12
10343-12-10	3/4	1-1/16x12
10343-12-12	3/4	1-1/16x12
10343-14-12	7/8	1-3/16x12
10343-16-12	1	1-5/16x12
10343-16-16	1	1-5/16x12
10343-20-20	1-1/4	1-5/8x12
10343-24-20	1-1/2	1-7/8x12

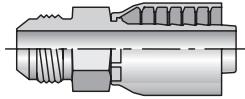

10443

Male SAE 45° - Rigid

Part Number	Thread inch	Hose ID inch
10443-6-6	3/8	5/8x18
10443-12-12	3/4	1-1/16x14

Notch on nut signifies SAE 45° flare.

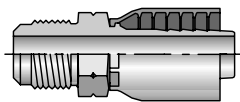

10543

Male SAE Straight Thread with O-Ring - Rigid

Part Number	Thread inch	Hose ID inch
10543-4-4	1/4	7/16x20
10543-5-4	5/16	1/2x20
10543-6-4	3/8	9/16x18
10543-6-6	3/8	9/16x18
10543-6-8	3/8	9/16x18
10543-8-6	1/2	3/4x16
10543-8-8	1/2	3/4x16
10543-10-6	5/8	7/8x14
10543-10-8	5/8	7/8x14
10543-10-10	5/8	7/8x14
10543-12-8	3/4	1-1/16x12
10543-12-10	3/4	1-1/16x12
10543-12-12	3/4	1-1/16x12
10543-16-12	1	1-5/16x12
10543-16-16	1	1-5/16x12
10543-20-20	1-1/4	1-5/8x12

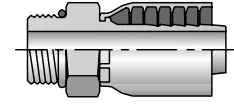

10643

Female JIC 37° - Swivel
ISO 12151-5

Part Number	Thread inch	Hose ID inch
10643-4-4	1/4	7/16x20
10643-4-6	1/4	7/16x20
10643-5-4	5/16	1/2x20
10643-5-5	5/16	1/2x20
10643-5-6	5/16	1/2x20
10643-6-4	3/8	9/16x18
10643-6-5	3/8	9/16x18
10643-6-6	3/8	9/16x18
10643-6-8	3/8	9/16x18
10643-8-6	1/2	3/4x16
10643-8-8	1/2	3/4x16
10643-8-10	1/2	3/4x16
10643-8-12	1/2	3/4x16
10643-10-6	5/8	7/8x14
10643-10-8	5/8	7/8x14
10643-10-10	5/8	7/8x14
10643-10-12	5/8	7/8x14
10643-12-8	3/4	1-1/16x12
10643-12-10	3/4	1-1/16x12
10643-12-12	3/4	1-1/16x12
10643-12-16	3/4	1-1/16x12
10643-14-12	7/8	1-3/16x12
10643-16-12	1	1-5/16x12
10643-16-16	1	1-5/16x12
10643-20-16	1-1/4	1-5/8x12
10643-20-20	1-1/4	1-5/8x12
10643-24-24	1-1/2	1-7/8x12
10643-32-32	2	2-1/2x12

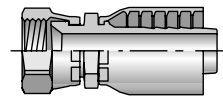

Stainless steel fittings must be assembled with [Karrykrimp 2](#), [PHastkrimp](#), [Superkrimp](#) or [Parkrimp 2](#).

See www.parker.com/crimpsource for more information.

43 Series: Use with [301LT](#), [302](#), [304](#), [351ST](#), [351TC](#), [422](#), [424](#), [426](#), [431](#), [436](#), [451TC](#), [451ST](#), [471TC](#), [471ST](#), [472TC](#), [482TC](#), [482ST](#), [722TC](#), [881](#) hoses.

Dimensions and pressures are for reference only and are subject to change.

10743

Female NPSM Pipe - Swivel - (60° Cone)

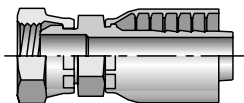

Part Number	Thread inch	Hose ID inch
10743-2-4	1/8x27	1/4
10743-4-4	1/4x18	1/4
10743-6-6	3/8x18	3/8
10743-8-8	1/2x14	1/2
10743-12-12	3/4x14	3/4
10743-16-16	1x11-1/2	1
10743-20-20	1-1/4x11-1/2	1-1/4

10843

Female SAE 45° - Swivel

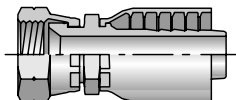

Part Number	Thread inch	Hose ID inch
10843-6-4	3/8 5/8x18	1/4
10843-6-6	3/8 5/8x18	3/8
10843-12-12	3/4 1-1/16x14	3/4

Notch on nut signifies SAE 45° flare.

10C43

Female Metric S - Swivel - 45° Elbow - (24° Cone with O-Ring) ISO 12151-2 - SWE45

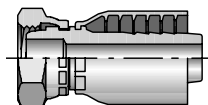

Part Number	Thread mm	Hose ID inch
10C43-8-4	8 M16x1,5	1/4
10C43-12-5	12 M20x1,5	5/16
10C43-12-6	12 M20x1,5	3/8
10C43-16-8	16 M24x1,5	1/2
10C43-20-10	20 M30x2	5/8
10C43-20-12	20 M30x2	3/4
10C43-25-12	25 M36x2	3/4
10C43-30-16	30 M42x2	1
10C43-38-20^^	38 M52x2	1-1/4

^^Must be assembled with Die Part No. 83C-A20H in a Superkrimp or Parkrimp 2.

Metric S: Mates with EO "S" Series Fittings.

10G43

Male SAE Straight Thread with O-Ring - Swivel

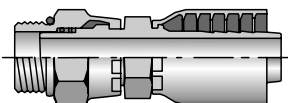

Part Number	Thread inch	Hose ID inch
10G43-5-4	5/16 1/2x20	1/4
10G43-6-4	3/8 9/16x18	1/4
10G43-6-6	3/8 9/16x18	3/8
10G43-8-6	1/2 3/4x16	3/8
10G43-8-8	1/2 3/4x16	1/2
10G43-10-6	5/8 7/8x14	3/8
10G43-10-8	5/8 7/8x14	1/2
10G43-12-12	3/4 1-1/16x12	3/4

O-Ring not compatible with Phosphate Ester fluids.

Fitting allows minor movement under pressure to relieve stress on hose but is not to be used on continuous or extensive swiveling.

10L43

Male SAE Straight Thread with O-Ring - Swivel - 90° Elbow

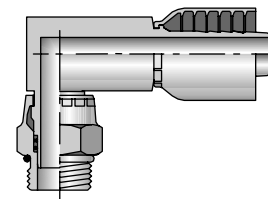

Part Number	Thread inch	Hose ID inch
10L43-6-6	3/8 9/16x18	3/8
10L43-8-6	1/2 3/4x16	3/8
10L43-8-8	1/2 3/4x16	1/2
10L43-10-8	5/8 7/8x14	1/2
10L43-12-12	3/4 1-1/16x12	3/4

O-Ring not compatible with Phosphate Ester fluids.

See Section O for pressure limitations.

Fitting allows minor movement under pressure to relieve stress on hose but is not to be used on continuous or extensive swiveling.

11143

Male Ferulok Flareless - Rigid (24° Cone with Nut and Ferrule)

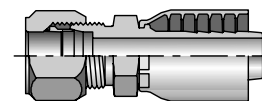

Part Number	Thread inch	Hose ID inch
11143-4-4	1/4 7/16x20	1/4
11143-4-6	1/4 7/16x20	3/8
11143-5-4	5/16 1/2x20	1/4
11143-5-6	5/16 1/2x20	3/8
11143-6-6	3/8 9/16x18	3/8
11143-8-8	1/2 3/4x16	1/2
11143-10-8	5/8 7/8x14	1/2
11143-12-12	3/4 1-1/16x12	3/4
11143-16-16	1 1-5/16x12	1

The Parker Ferrul-Fix fitting makes it possible to salvage the bent tube section from a hose assembly for quick, easy on-the-job repairs. For additional information see Ferrule-Fix installation instructions in Section N.

Notch on nut signifies SAE 45° flare.

11243

Female Ferulok Flareless - Swivel - (24° Cone)

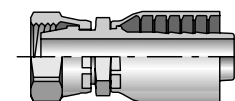

Part Number	Thread inch	Hose ID inch
11243-6-6	3/8 9/16x18	3/8
11243-8-6	1/2 3/4x16	3/8
11243-8-8	1/2 3/4x16	1/2

43 Series: Use with 301LT, 302, 304, 351ST, 351TC, 422, 424, 426, 431, 436, 451TC, 451ST, 471TC, 471ST, 472TC, 482TC, 482ST, 722TC, 881 hoses.

Dimensions and pressures are for reference only and are subject to change.

11343

Male NPTF Pipe - Swivel

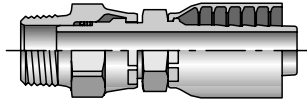

Part Number	Thread inch	Hose ID inch
11343-2-4	1/8x27	1/4
11343-4-4	1/4x18	1/4
11343-4-6	1/4x18	3/8
11343-6-4	3/8x18	1/4
11343-6-6	3/8x18	3/8
11343-6-8	3/8x18	1/2
11343-8-6	1/2x14	3/8
11343-8-8	1/2x14	1/2
11343-12-12	3/4x14	3/4
11343-16-16	1x11-1/2	1

O-Ring not compatible with Phosphate Ester fluids.

Fitting allows minor movement under pressure to relieve stress on hose but is not to be used on continuous or extensive swiveling.

11543

SAE Code 61 Flange Head
ISO 12151-3 - S - L

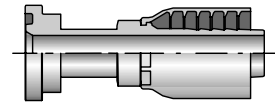

Part Number	Flange inch	Hose ID inch
11543-8-8	1/2	1/2
11543-10-10	5/8	5/8
11543-12-8	3/4	1/2
11543-12-12	3/4	3/4
11543-16-12	1	3/4
11543-16-16	1	1
11543-20-16	1-1/4	1
11543-20-20	1-1/4	1-1/4
11543-24-20	1-1/2	1-1/4
11543-24-24	1-1/2	1-1/2
11543-24-32	1-1/2	2
11543-32-20	2	1-1/4
11543-32-24	2	1-1/2
11543-32-32	2	2

11643

SAE Code 61 Flange Head - 22-1/2° Elbow
ISO 12151-3 - E22M - L

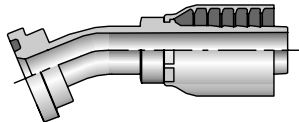

Part Number	Flange inch	Hose ID inch
11643-12-12	3/4	3/4
11643-16-12	1	3/4
11643-16-16	1	1
11643-20-16	1-1/4	1
11643-20-20	1-1/4	1-1/4
11643-24-20	1-1/2	1-1/4

11743

SAE Code 61 Flange Head - 45° Elbow
ISO 12151-3 - E45S - L
(1 Piece: ISO 12151-3 - E45M - L)

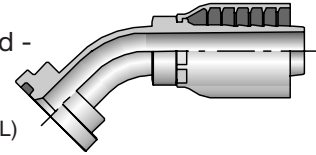

Part Number	Flange inch	Hose ID inch
11743-8-8	1/2	1/2
11743-10-10	5/8	5/8
11743-12-8	3/4	1/2
11743-12-12	3/4	3/4
11743-16-12	1	3/4
11743-16-16	1	1
11743-20-16	1-1/4	1
11743-20-20	1-1/4	1-1/4
11743-20-24	1-1/4	1-1/2
11743-24-20	1-1/2	1-1/4
11743-24-24	1-1/2	1-1/2
11743-32-24	2	1-1/2
11743-32-32	2	2

11843

SAE Code 61 Flange Head - 67-1/2° Elbow
ISO 12151-3 - E67S - L
(1 Piece: ISO 12151-3 - E67M - L)

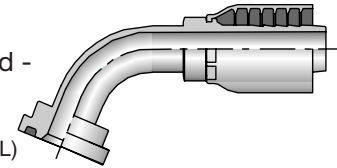

Part Number	Flange inch	Hose ID inch
11843-12-12	3/4	3/4
11843-16-16	1	1
11843-20-20	1-1/4	1-1/4

11943

SAE Code 61 Flange Head - 90° Elbow
ISO 12151-3 - E90S - L
(1 Piece: ISO 12151-3 - E90M - L)

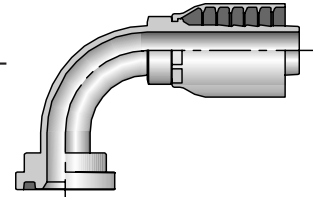

Part Number	Flange inch	Hose ID inch
11943-8-8	1/2	1/2
11943-10-10	5/8	5/8
11943-12-8	3/4	1/2
11943-12-10	3/4	5/8
11943-12-12	3/4	3/4
11943-16-8	1	1/2
11943-16-12	1	3/4
11943-16-16	1	1
11943-20-16	1-1/4	1
11943-20-20	1-1/4	1-1/4
11943-24-20	1-1/2	1-1/4
11943-20-24	1-1/4	1-1/2
11943-24-24	1-1/2	1-1/2
11943-32-24	2	1-1/2
11943-32-32	2	2

43 Series: Use with 301LT, 302, 304, 351ST, 351TC, 422, 424, 426, 431, 436, 451TC, 451ST, 471TC, 471ST, 472TC, 482TC, 482ST, 722TC, 881 hoses.

Dimensions and pressures are for reference only and are subject to change.

11C43

Female Metric S - Swivel - 90° Elbow - (24° Cone with O-Ring)
ISO 12151-2 - SWE

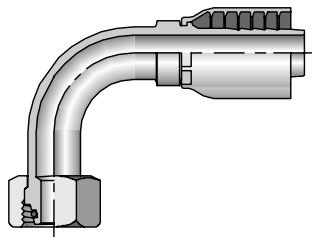

Part Number	Thread mm	Hose ID inch
11C43-8-4	M16x1,5	1/4
11C43-10-4	M18x1,5	1/4
11C43-12-5	M20x1,5	5/16
11C43-12-6	M20x1,5	3/8
11C43-14-6	M22x1,5	3/8
11C43-16-8	M24x1,5	1/2
11C43-20-10	M30x2	5/8
11C43-25-12	M36x2	3/4
11C43-30-16	M42x2	1
11C43-38-20^^	M52x2	1-1/4

^^Must be assembled with Die Part No. 83C-A20H in a Superkrimp or Parkrimp 2.

Metric S: Mates with EO "S" Series Fittings.

11D43

Male Standpipe Metric L - Rigid End Connection per ISO 8434-1-SDS

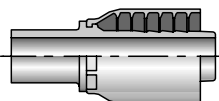

Part Number	Hose ID inch
11D43-6-4	1/4
11D43-10-5	5/16
11D43-10-6	3/8
11D43-12-4	1/4
11D43-15-8	1/2
11D43-18-10	5/8
11D43-18-12	3/4
11D43-22-12	3/4
11D43-28-16	1

Metric L: Mates with EO "L" Series Fittings.

11L43

Male NPTF Pipe - Swivel - 90° Elbow

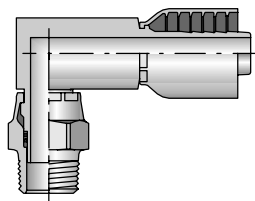

Part Number	Thread inch	Hose ID inch
11L43-4-4	1/4x18	1/4
11L43-4-6	1/4x18	3/8
11L43-6-6	3/8x18	3/8
11L43-8-6	1/2x14	3/8
11L43-8-8	1/2x14	1/2
11L43-12-12	3/4x14	3/4

O-Ring not compatible with Phosphate Ester fluids.
Fitting allows minor movement under pressure to relieve stress on hose but is not to be used on continuous or extensive swiveling.

12643

SAE Code 61 Flange Head - 30° Elbow
ISO 12151-3 - E30S - L
(1 Piece: ISO 12151-3 - E30M - L)

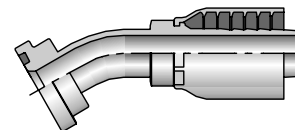

Part Number	Flange inch	Hose ID inch
12643-12-12	3/4	3/4
12643-16-16	1	1
12643-20-16	1-1/4	1
12643-20-20	1-1/4	1-1/4

12743

SAE Code 61 Flange Head - 60° Elbow
ISO 12151-3 - E60S - L
(1 Piece: ISO 12151-3 - E60M - L)

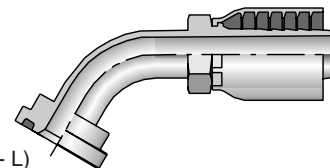

Part Number	Flange inch	Hose ID inch
12743-12-12	3/4	3/4
12743-16-12	1	3/4
12743-16-16	1	1
12743-20-20	1-1/4	1-1/4

12843

Male Inverted SAE 45° - Swivel

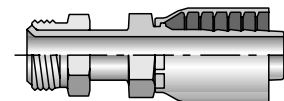

Part Number	Thread inch	Hose ID inch
12843-4-4	1/4 7/16x24	1/4
12843-4-6	1/4 7/16x24	3/8
12843-5-4	5/16 1/2x20	1/4
12843-5-6	5/16 1/2x20	3/8
12843-6-6	3/8 5/8x18	3/8
12843-7-6	7/16 11/16x18	3/8
12843-8-8	1/2 3/4x18	1/2
12843-10-10	5/8 7/8x18	5/8

13743

Female JIC 37° - Swivel - 45° Elbow - Short Drop
ISO 12151-5

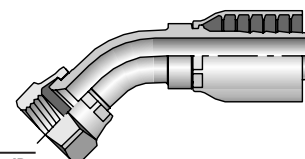

Part Number	Thread inch	Hose ID inch
13743-4-4	1/4 7/16x20	1/4
13743-5-4	5/16 1/2x20	1/4
13743-6-4	3/8 9/16x18	1/4
13743-6-6	3/8 9/16x18	3/8
13743-8-6	1/2 3/4x16	3/8
13743-8-8	1/2 3/4x16	1/2
13743-10-8	5/8 7/8x14	1/2
13743-10-10	5/8 7/8x14	5/8
13743-12-10	3/4 1-1/16x12	5/8
13743-12-12	3/4 1-1/16x12	3/4
13743-16-16	1 1-5/16x12	1
13743-20-20	1-1/4 1-5/8x12	1-1/4
13743-24-24	1-1/2 1-7/8x12	1-1/2

43 Series: Use with 301LT, 302, 304, 351ST, 351TC, 422, 424, 426, 431, 436, 451TC, 451ST, 471TC, 471ST, 472TC, 482TC, 482ST, 722TC, 881 hoses.

Dimensions and pressures are for reference only and are subject to change.

13943

Female JIC 37° - Swivel - 90° Elbow - Short Drop
ISO 12151-5

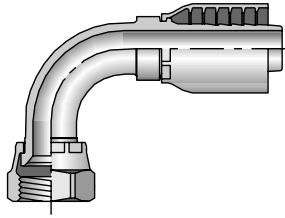

Part Number	Thread inch	Hose ID inch
13943-4-4	1/4 7/16x20	1/4
13943-4-6	1/4 7/16x20	3/8
13943-5-4	5/16 1/2x20	1/4
13943-5-5	5/16 1/2x20	5/16
13943-6-4	3/8 9/16x18	1/4
13943-6-6	3/8 9/16x18	3/8
13943-6-8	3/8 9/16x18	1/2
13943-8-6	1/2 3/4x16	3/8
13943-8-8	1/2 3/4x16	1/2
13943-10-8	5/8 7/8x14	1/2
13943-10-10	5/8 7/8x14	5/8
13943-12-8	3/4 1-1/16x12	1/2
13943-12-10	3/4 1-1/16x12	5/8
13943-12-12	3/4 1-1/16x12	3/4
13943-16-12	1 1-5/16x12	3/4
13943-16-16	1 1-5/16x12	1
13943-20-20	1-1/4 1-5/8x12	1-1/4
13943-24-24	1-1/2 1-7/8x12	1-1/2
13943-32-32	2 2-1/2x12	2

13D43

Male Standpipe Metric S - Rigid
End Connection per ISO 8434-1-SDS

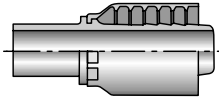

Part Number	Hose ID inch
13D43-10-4	1/4
13D43-12-5	5/16
13D43-14-6	3/8
13D43-16-8	1/2
13D43-20-10	5/8
13D43-20-12	3/4
13D43-25-12	3/4
13D43-30-16	1

Light Series 11D43-6-4, 11D43-8-4 and 11D43-12-6 are used in place of their Heavy Series equivalent size and accept the EO Heavy "S" Series ferrules and nuts.

Metric S: Mates with EO "S" Series Fittings.

14143

Female JIC 37° - Swivel - 90° Elbow - Long Drop
ISO 12151-5

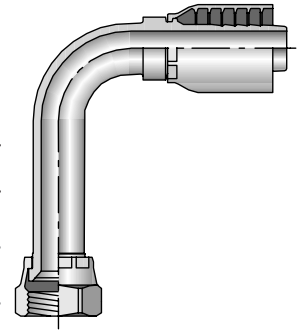

Part Number	Thread inch	Hose ID inch
14143-4-4	1/4 7/16x20	1/4
14143-5-4	5/16 1/2x20	1/4
14143-6-6	3/8 9/16x18	3/8
14143-8-6	1/2 3/4x16	3/8
14143-8-8	1/2 3/4x16	1/2
14143-10-8	5/8 7/8x14	1/2
14143-10-10	5/8 7/8x14	5/8
14143-12-12	3/4 1-1/16x12	3/4
14143-14-12	7/8 1-3/16x12	3/4
14143-16-16	1 1-5/16x12	1
14143-20-20	1-1/4 1-5/8x12	1-1/4

Notch on nut signifies SAE 45° flare.

14943

DIN Metric Banjo

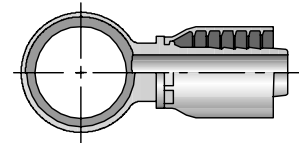

Part Number	R mm	Hose ID inch
14943-10-4	10	1/4
14943-12-4	12	1/4
14943-14-5	14	5/16
14943-16-6	16	3/8
14943-18-8	18	1/2
14943-22-10	22	5/8
14943-26-12	26	3/4

AM

Banjo Bolt with DIN Metric Thread

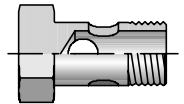

Part Number	R Thread mm
AM-03	8 M8x1
AM-04	10 M10x1
AM-06	12 M12x1.5
AM-08	14 M14x1.5
AM-10	16 M16x1.5
AM-13	18 M18x1.5
AM-16	22 M22x1.5
AM-20	26 M26x1.5
AM-30	30 M30x1.5

Two (2) copper washers per bolt must be ordered separately.

14V43

Female JIC 37° - Swivel - 150° Elbow
ISO 12151-5

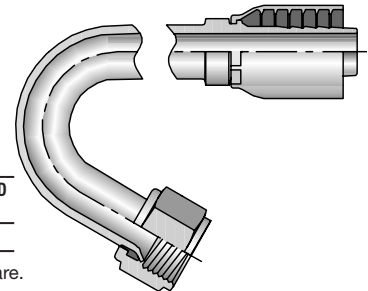

Part Number	Thread inch	Hose ID inch
14V43-6-4	3/8 9/16x18	1/4

Notch on nut signifies SAE 45° flare.

43 Series: Use with 301LT, 302, 304, 351ST, 351TC, 422, 424, 426, 431, 436, 451TC, 451ST, 471TC, 471ST, 472TC, 482TC, 482ST, 722TC, 881 hoses.

Dimensions and pressures are for reference only and are subject to change.

16743

Male Inverted SAE 45° - Swivel - 45° Elbow

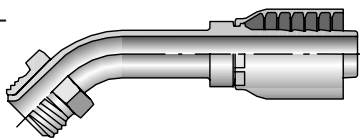

Part Number	Thread inch	Hose ID inch
16743-4-4	1/4	7/16x24
16743-4-6	1/4	7/16x24
16743-5-4	5/16	1/2x20
16743-5-6	5/16	1/2x20
16743-6-6	3/8	5/8x18
16743-8-8	1/2	3/4x18

16943

Male Inverted SAE 45° - Swivel - 90° Elbow

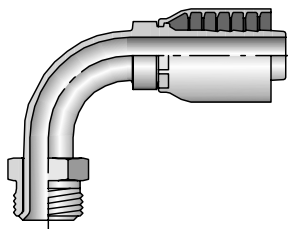

Part Number	Thread inch	Hose ID inch
16943-4-4	1/4	7/16x24
16943-4-6	1/4	7/16x24
16943-5-4	5/16	1/2x20
16943-5-6	5/16	1/2x20
16943-6-6	3/8	5/8x18
16943-7-6	7/16	11/16x18
16943-8-8	1/2	3/4x18

16A43

SAE Code 62 Flange Head ISO 12151-3 - S - S

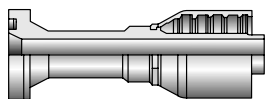

Part Number	Flange inch	Hose ID inch
16A43-12-12	3/4	3/4
16A43-16-12	1	3/4
16A43-16-16	1	1
16A43-20-16	1-1/4	1
16A43-20-20	1-1/4	1-1/4

16F43

SAE Code 62 Flange Head - 45° Elbow
ISO 12151-3 - E45S - S
(1 Piece 12151-3-E45M-S)

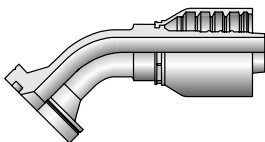

Part Number	Flange inch	Hose ID inch
16F43-12-12	3/4	3/4
16F43-16-16	1	1
16F43-20-16	1-1/4	1

16N43

SAE Code 62 Flange Head - 90° Elbow
ISO 12151-3 - E90S - S
(1 Piece 12151-3-E90M-S)

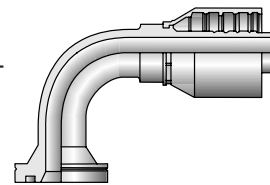

Part Number	Flange inch	Hose ID inch
16N43-12-12	3/4	3/4
16N43-16-12	1	3/4
16N43-16-16	1	1
16N43-20-16	1-1/4	1
16N43-20-20	1-1/4	1-1/4

17743

Female SAE 45° - Swivel - 45° Elbow

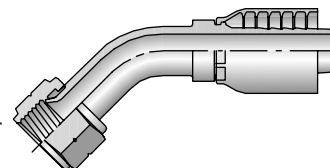

Part Number	Thread inch	Hose ID inch
17743-4-6	1/4	7/16x20

Notch on nut signifies SAE 45° flare.

17943

Female SAE 45° - Swivel - 90° Elbow

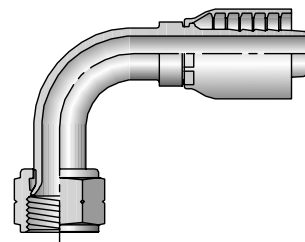

Part Number	Thread inch	Hose ID inch
17943-6-6	3/8	5/8x18

Notch on nut signifies SAE 45° flare.

19243

Female BSP Parallel Pipe - Swivel - (60° Cone)
ISO 12151-6

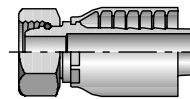

Part Number	Thread inch	Hose ID inch
19243-2-4	1/8x28	1/4
19243-4-4	1/4x19	1/4
19243-6-4	3/8x19	1/4
19243-6-6	3/8x19	3/8
19243-6-8	3/8x19	1/2
19243-8-6	1/2x14	3/8
19243-8-8	1/2x14	1/2
19243-10-8	5/8x14	1/2
19243-10-10	5/8x14	5/8
19243-12-10	3/4x14	5/8
19243-12-12	3/4x14	3/4
19243-16-16	1x11	1
19243-20-20	1-1/4x11	1-1/4

43 Series: Use with 301LT, 302, 304, 351ST, 351TC, 422, 424, 426, 431, 436, 451TC, 451ST, 471TC, 471ST, 472TC, 482TC, 482ST, 722TC, 881 hoses.

Dimensions and pressures are for reference only and are subject to change.

1B143

Female BSP Parallel Pipe -
Swivel - 45° Elbow -
(60° Cone)
ISO 12151-6

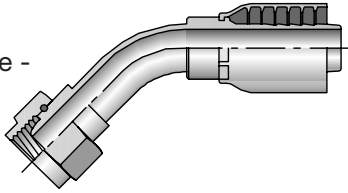

Part Number	Thread inch	Hose ID inch
1B143-4-4	1/4x19	1/4
1B143-6-6	3/8x19	3/8
1B143-8-8	1/2x14	1/2
1B143-10-10	5/8x14	5/8
1B143-12-10	3/4x14	5/8
1B143-12-12	3/4x14	3/4
1B143-16-16	1x11	1

1B243

Female BSP Parallel Pipe -
Swivel - 90° Elbow -
(60° Cone)
ISO 12151-6

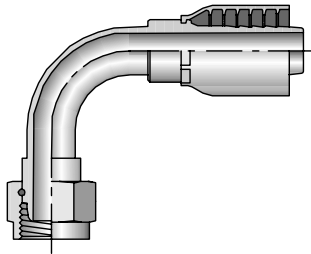

Part Number	Thread inch	Hose ID inch
1B243-2-4	1/8x28	1/4
1B243-4-4	1/4x19	1/4
1B243-6-6	3/8x19	3/8
1B243-8-6	1/2x14	3/8
1B243-8-8	1/2x14	1/2
1B243-10-8	5/8x14	1/2
1B243-10-10	5/8x14	5/8
1B243-12-10	3/4x14	5/8
1B243-12-12	3/4x14	3/4
1B243-16-16	1x11	1
1B243-20-20	1-1/4x11	1-1/4

1B443

Female BSP Parallel Pipe -
Swivel - 90° Elbow -
Block Type - (60° Cone)
ISO 228-1

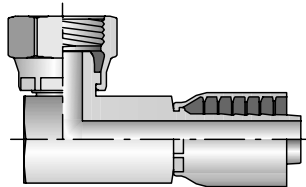

Part Number	Thread inch	Hose ID inch
1B443-4-4	1/4x19	1/4
1B443-6-6	3/8x19	3/8
1B443-8-8	1/2x14	1/2
1B443-12-12	3/4x14	3/4

1B543

Female BSP Parallel Pipe -
Swivel - (Flat Seat)
ISO 228-1

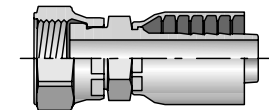

Part Number	Thread inch	Hose ID inch
1B543-6-6	3/8x19	3/8
1B543-8-6	1/2x14	3/8
1B543-8-8	1/2x14	1/2
1B543-12-12	3/4x14	3/4

1C043

Female Metric - Swivel -
(Ball Nose)

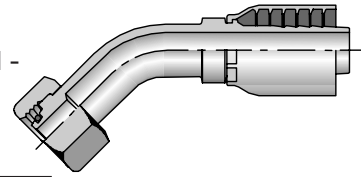

Part Number	Thread mm	Hose ID inch
1C043-20-12	20 M30x1,5	3/4
1C043-25-16	25 M38x1,5	1

1C343

Female Metric L - Swivel -
(Ball Nose)

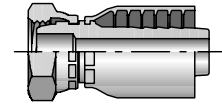

Part Number	Thread mm	Hose ID inch
1C343-6-4	6 M12x1,5	1/4
1C343-8-4	8 M14x1,5	1/4
1C343-10-5	10 M16x1,5	5/16
1C343-10-6	10 M16x1,5	3/8
1C343-12-5	12 M18x1,5	5/16
1C343-12-6	12 M18x1,5	3/8
1C343-15-6	6 M22x1,5	3/8
1C343-15-8	15 M22x1,5	1/2
1C343-18-10	18 M26x1,5	5/8
1C343-18-12	18 M26x1,5	3/4
1C343-22-12	22 M30x2	3/4
1C343-28-16	28 M36x2	1

Metric L: Mates with EO "L" Series Fittings.

1C443

Female Metric L - Swivel -
45° Elbow - (Ball Nose)

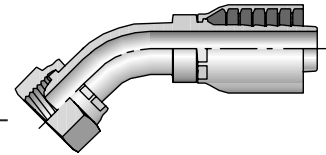

Part Number	Thread mm	Hose ID inch
1C443-8-4	8 M14x1,5	1/4
1C443-10-5	10 M16x1,5	5/16
1C443-10-6	10 M16x1,5	3/8
1C443-12-6	12 M18x1,5	3/8
1C443-15-8	15 M22x1,5	1/2
1C443-18-10	18 M26x1,5	5/8
1C443-22-12	22 M30x2	3/4
1C443-28-16	28 M36x2	1

Metric L: Mates with EO "L" Series Fittings.

1C543

Female Metric L - Swivel -
90° Elbow - (Ball Nose)

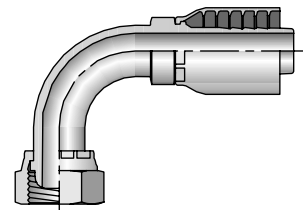

Part Number	Thread mm	Hose ID inch
1C543-8-4	8 M14x1,5	1/4
1C543-10-5	10 M16x1,5	5/16
1C543-10-6	10 M16x1,5	3/8
1C543-12-6	12 M18x1,5	3/8
1C543-15-8	15 M22x1,5	1/2
1C543-18-10	18 M26x1,5	5/8
1C543-22-12	22 M30x2	3/4
1C543-28-16	28 M36x2	1

Metric L: Mates with EO "L" Series Fittings.

43 Series: Use with 301LT, 302, 304, 351ST, 351TC, 422, 424, 426, 431, 436, 451TC, 451ST, 471TC, 471ST, 472TC, 482TC, 482ST, 722TC, 881 hoses.

Dimensions and pressures are for reference only and are subject to change.

1C643

Female Metric S - Swivel - (Ball Nose)

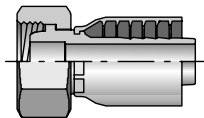

Part Number	Thread mm	Hose ID inch
1C643-8-4	8 M16x1,5	1/4
1C643-10-4	10 M18x1,5	1/4
1C643-12-5	12 M20x1,5	5/16
1C643-12-6	12 M20x1,5	3/8
1C643-12-8	12 M20x1,5	1/2
1C643-14-6	14 M22x1,5	3/8
1C643-16-8	16 M24x1,5	1/2
1C643-20-10	20 M30x2	5/8
1C643-20-12	20 M30x2	3/4
1C643-25-12	25 M36x2	3/4
1C643-30-16	30 M42x2	1

Metric S: Mates with EO "S" Series Fittings.

1C943

Female Metric S - Swivel - (24° Cone with O-Ring)
ISO 12151-2 - SWS

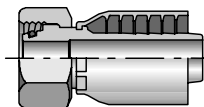

Part Number	Thread mm	Hose ID inch
1C943-6-4	6 M14x1,5	1/4
1C943-8-4	8 M16x1,5	1/4
1C943-10-4	10 M18x1,5	1/4
1C943-10-5	10 M18x1,5	5/16
1C943-10-6	10 M18x1,5	3/8
1C943-12-5	12 M20x1,5	5/16
1C943-12-6	12 M20x1,5	3/8
1C943-14-6	14 M22x1,5	3/8
1C943-16-8	16 M24x1,5	1/2
1C943-20-10	20 M30x2	5/8
1C943-20-12	20 M30x2	3/4
1C943-25-12	25 M36x2	3/4
1C943-25-16	25 M36x2	1
1C943-30-16	30 M42x2	1
1C943-38-20	38 M52x2	1-1/4

Metric S: Mates with EO "S" Series Fittings.

1CA43

Female Metric L - Swivel - (24° Cone with O-Ring)
ISO 12151-2 - SWS

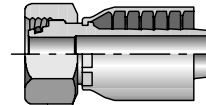

Part Number	Thread mm	Hose ID inch
1CA43-6-4	6 M12x1,5	1/4
1CA43-8-4	8 M14x1,5	1/4
1CA43-8-5	8 M14x1,5	5/16
1CA43-10-4	10 M16x1,5	1/4
1CA43-10-5	10 M16x1,5	5/16
1CA43-12-5	12 M18x1,5	5/16
1CA43-12-6	12 M18x1,5	3/8
1CA43-15-8	15 M22x1,5	1/2
1CA43-18-10	18 M26x1,5	5/8
1CA43-18-12	18 M26x1,5	3/4
1CA43-22-12	22 M30x2	3/4
1CA43-28-16	28 M36x2	1
1CA43-35-20	35 M45x2	1-1/4

Metric L: Mates with EO "L" Series Fittings.

1CE43

Female Metric L - Swivel - 45° Elbow - (24° Cone with O-Ring)
ISO 12151-2 - SWE45

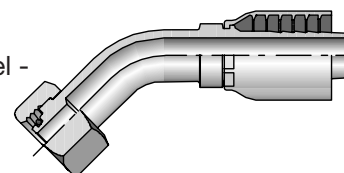

Part Number	Thread mm	Hose ID inch
1CE43-6-4	6 M12x1,5	1/4
1CE43-8-4	8 M14x1,5	1/4
1CE43-10-5	10 M16x1,5	5/16
1CE43-10-6	10 M16x1,5	3/8
1CE43-12-6	12 M18x1,5	3/8
1CE43-15-8	15 M22x1,5	1/2
1CE43-18-10	18 M26x1,5	5/8
1CE43-22-12	22 M30x2	3/4

Metric L: Mates with EO "L" Series Fittings.

1CF43

Female Metric L - Swivel - 90° Elbow - (24° Cone with O-Ring)
ISO 12151-2 - SWE

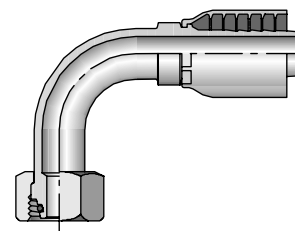

Part Number	Thread mm	Hose ID inch
1CF43-8-4	8 M14x1,5	1/4
1CF43-10-4	10 M16x1,5	1/4
1CF43-10-5	10 M16x1,5	5/16
1CF43-10-6	10 M16x1,5	3/8
1CF43-12-5	12 M18x1,5	5/16
1CF43-12-6	12 M18x1,5	3/8
1CF43-15-8	15 M22x1,5	1/2
1CF43-18-10	18 M26x1,5	5/8
1CF43-22-12	22 M30x2	3/4
1CF43-35-20	35 M45x2	1-1/4

Metric L: Mates with EO "L" Series Fittings.

43 Series: Use with 301LT, 302, 304, 351ST, 351TC, 422, 424, 426, 431, 436, 451TC, 451ST, 471TC, 471ST, 472TC, 482TC, 482ST, 722TC, 881 hoses.

Dimensions and pressures are for reference only and are subject to change.

1D043

Male Metric L - Rigid - (24° Cone)
ISO 12151-2

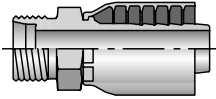

Part Number	Thread mm	Hose ID inch
1D043-6-4	6 M12x1,5	1/4
1D043-8-4	8 M14x1,5	1/4
1D043-10-5	10 M16x1,5	5/16
1D043-10-6	10 M16x1,5	3/8
1D043-12-5	12 M18x1,5	5/16
1D043-12-6	12 M18x1,5	3/8
1D043-15-6	15 M22x1,5	3/8
1D043-15-8	15 M22x1,5	1/2
1D043-18-10	18 M26x1,5	5/8
1D043-18-12	18 M26x1,5	3/4
1D043-22-12	22 M30x2	3/4
1D043-28-16	28 M36x2	1
1D043-35-20	35 M45x2	1-1/4

1D243

Male Metric S - Rigid - (24° Cone)
ISO 12151-2

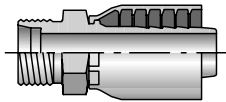

Part Number	Thread mm	Hose ID inch
1D243-8-4	8 M16x1,5	1/4
1D243-10-4	10 M18x1,5	1/4
1D243-12-5	12 M20x1,5	5/16
1D243-12-6	12 M20x1,5	3/8
1D243-14-6	14 M22x1,5	3/8
1D243-16-8	16 M24x1,5	1/2
1D243-20-10	20 M30x2	5/8
1D243-25-12	25 M36x2	3/4
1D243-30-16	30 M42x2	1

Metric S: Mates with EO "S" Series Fittings.

1D943

Male BSP Parallel Pipe - Rigid - (60° Cone)
ISO 12151-6

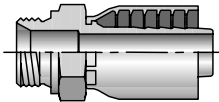

Part Number	Thread inch	Hose ID inch
1D943-4-4	1/4x19	1/4
1D943-6-5	3/8x19	5/16
1D943-6-6	3/8x19	3/8
1D943-8-6	1/2x14	3/8
1D943-8-8	1/2x14	1/2
1D943-12-12	3/4x14	3/4
1D943-16-16	1x11	1

When used in a port, a bonded seal must be used.

1EN43

UPTC Male

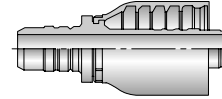

Part Number	Hose End Size inch
1EN43-8-4	1/4
1EN43-12-6	3/8
1EN43-15-8	1/2
1EN43-18-10	5/8
1EN43-22-12	3/4

1ET43

UPTC Male 90° Elbow

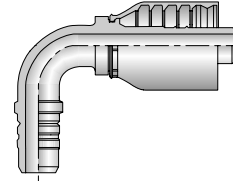

Part Number	Hose End Size inch
1ET43-8-4	1/4
1ET43-12-6	3/8
1ET43-15-8	1/2
1ET43-18-10	5/8
1ET43-22-12	3/4

1EU43

UPTC Male 45° Elbow

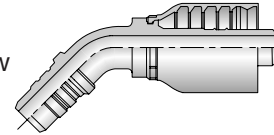

Part Number	Hose End Size inch
1EU43-8-4	1/4
1EU43-12-6	3/8
1EU43-15-8	1/2
1EU43-18-10	5/8
1EU43-22-12	3/4

1F443

Female French Gaz Series - Swivel - (Ball Nose)

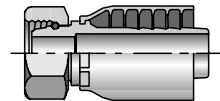

Part Number	Thread mm	Hose ID inch
1F443-27-12	27 M36x1,5	3/4

1FU43

Female BSP Parallel Pipe - Swivel - (30° Flare)
B8363 Code F

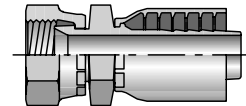

Part Number	Thread inch	Hose ID inch
1FU43-4-4	1/4x19	1/4
1FU43-6-6	3/8x19	3/8
1FU43-8-8	1/2x14	1/2
1FU43-12-12	3/4x14	3/4
1FU43-16-16	1x11	1
1FU43-20-20	1-1/4x11	1-1/4

43 Series: Use with 301LT, 302, 304, 351ST, 351TC, 422, 424, 426, 431, 436, 451TC, 451ST, 471TC, 471ST, 472TC, 482TC, 482ST, 722TC, 881 hoses.

Dimensions and pressures are for reference only and are subject to change.

1GJ43

Female Grease Connection - SPL - PTF Taper Thread
Rigid - 1/2 x 27

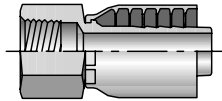

Part Number	Thread inch	Hose ID inch
1GJ43-4-4	1/2x27	1/4
1GJ43-4-6	1/2x27	3/8

1GU43

Female BSP Parallel Pipe - Swivel - (60° Cone)
B8363 Code C

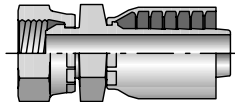

Part Number	Thread inch	Hose ID inch
1GU43-4-4	1/4x19	1/4
1GU43-6-6	3/8x19	3/8
1GU43-8-8	1/2x14	1/2
1GU43-12-12	3/4x14	3/4
1GU43-16-16	1x11	1
1GU43-20-20	1-1/4x11	1-1/4

1J043

Male Seal-Lok™ - Rigid - (with O-Ring)
ISO 12151-1 - S

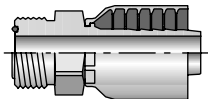

Part Number	Thread inch	Hose ID inch
1J043-4-4	1/4 9/16x18	1/4
1J043-6-6	3/8 11/16x16	3/8
1J043-8-6	1/2 13/16x16	3/8
1J043-8-8	1/2 13/16x16	1/2
1J043-10-8	5/8 1x14	1/2
1J043-10-10	5/8 1x14	5/8
1J043-12-10	3/4 1-3/16x12	5/8
1J043-12-12	3/4 1-3/16x12	3/4
1J043-16-12	1 1-7/16x12	3/4
1J043-16-16	1 1-7/16x12	1
1J043-20-20	1-1/4 1-11/16x12	1-1/4

Fittings are stocked less locknut ([part no. WLNL](#)). Locknuts are manufactured by the Parker Tube Fittings Division and must be ordered separately.

1J143

Female Seal-Lok™ - Swivel - 90° Elbow - Long Drop
ISO 12151-1 - SWEL90

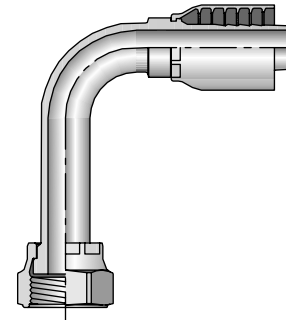

Part Number	Thread inch	Hose ID inch
1J143-4-4	1/4 9/16x18	1/4
1J143-6-4	3/8 11/16x16	1/4
1J143-6-6	3/8 11/16x16	3/8
1J143-8-6	1/2 13/16x16	3/8
1J143-8-8	1/2 13/16x16	1/2
1J143-8-8-SM	1/2 13/16x16	1/2
1J143-10-8	5/8 1x14	1/2
1J143-10-10	5/8 1x14	5/8
1J143-10-12	5/8 1x14	3/4
1J143-12-12	3/4 1-3/16x12	3/4
1J143-16-16	1 1-7/16x12	1
1J143-20-20	1-1/4 1-11/16x12	1-1/4
1J143-24-20	1-1/2 2x12	1-1/4

1J543

Female Seal-Lok™ - Swivel - 90° Elbow - Medium Drop
ISO 12151-1 - SWEM90

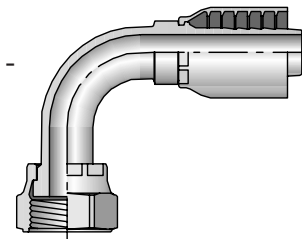

Part Number	Thread inch	Hose ID inch
1J543-4-4	1/4 9/16x18	1/4
1J543-6-4	3/8 11/16x16	1/4
1J543-6-6	3/8 11/16x16	3/8
1J543-6-6-SM	3/8 11/16x16	3/8
1J543-8-6	1/2 13/16x16	3/8
1J543-8-8	1/2 13/16x16	1/2
1J543-10-8	5/8 1x14	1/2
1J543-10-10	5/8 1x14	5/8
1J543-10-12	5/8 1x14	3/4
1J543-12-12	3/4 1-3/16x12	3/4
1J543-16-16	1 1-7/16x12	1
1J543-20-20	1-1/4 1-11/16x12	1-1/4

1J643

Female Seal-Lok™ - Swivel - 22-1/2° Elbow
End Connection per ISO 8434-3-SWE

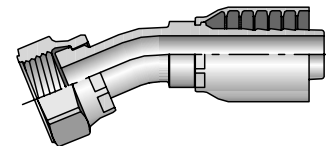

Part Number	Thread inch	Hose ID inch
1J643-8-8	1/2 13/16x16	1/2

43 Series: Use with 301LT, 302, 304, 351ST, 351TC, 422, 424, 426, 431, 436, 451TC, 451ST, 471TC, 471ST, 472TC, 482TC, 482ST, 722TC, 881 hoses.

Dimensions and pressures are for reference only and are subject to change.

1J743

Female Seal-Lok™ -
Swivel - 45° Elbow
ISO 12151-1 - SWE45

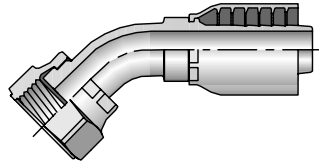

Part Number	Thread inch	Hose ID inch
1J743-4-4	1/4	9/16x18
1J743-4-4-SM	1/4	9/16x18
1J743-4-6	1/4	9/16x18
1J743-6-4	3/8	11/16x16
1J743-6-4-SM	3/8	11/16x16
1J743-6-5	3/8	11/16x16
1J743-6-6	3/8	11/16x16
1J743-6-8	3/8	11/16x16
1J743-8-4	1/2	13/16x16
1J743-8-6	1/2	13/16x16
1J743-8-6-SM	1/2	13/16x16
1J743-8-8	1/2	13/16x16
1J743-8-8-SM	1/2	13/16x16
1J743-8-10	1/2	13/16x16
1J743-10-8	5/8	1x14
1J743-10-10	5/8	1x14
1J743-10-10-SM	5/8	1x14
1J743-10-12	5/8	1x14
1J743-12-8	3/4	1-3/16x12
1J743-12-10	3/4	1-3/16x12
1J743-12-12	3/4	1-3/16x12
1J743-12-12-SM	3/4	1-3/16x12
1J743-12-16	3/4	1-3/16x12
1J743-16-12	1	1-7/16x12
1J743-16-16	1	1-7/16x12
1J743-16-20	1	1-7/16x12
1J743-20-16	1-1/4	1-11/16x12
1J743-20-20	1-1/4	1-11/16x12
1J743-24-20	1-1/2	2x12
1J743-24-24	1-1/2	2x12

1J943

Female Seal-Lok™ - Swivel -
90° Elbow - Short Drop
ISO 12151-1 - SWES90

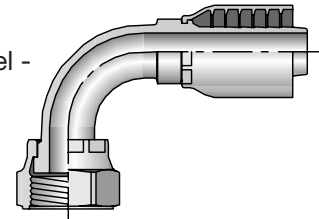

Part Number	Thread inch	Hose ID inch
1J943-4-4	1/4	9/16x18
1J943-4-6	1/4	9/16x18
1J943-6-4	3/8	11/16x16
1J943-6-5	3/8	11/16x16
1J943-6-6	3/8	11/16x16
1J943-6-8	3/8	11/16x16
1J943-8-4	1/2	13/16x16
1J943-8-6	1/2	13/16x16
1J943-8-8	1/2	13/16x16
1J943-8-8-SM	1/2	13/16x16
1J943-8-10	1/2	13/16x16
1J943-10-8	5/8	1x14
1J943-10-10	5/8	1x14
1J943-10-10-SM	5/8	1x14
1J943-10-12	5/8	1x14
1J943-12-8	3/4	1-3/16x12
1J943-12-10	3/4	1-3/16x12
1J943-12-12	3/4	1-3/16x12
1J943-12-16	3/4	1-3/16x12
1J943-16-12	1	1-7/16x12
1J943-16-16	1	1-7/16x12
1J943-16-20	1	1-7/16x12
1J943-20-16	1-1/4	1-11/16x12
1J943-20-20	1-1/4	1-11/16x12
1J943-24-20	1-1/2	2x12
1J943-24-24	1-1/2	2x12

1JB43

Male Seal-Lok™ -
Bulkhead without Locknut -
(with O-Ring)
End Connection per ISO 8434-3-BH

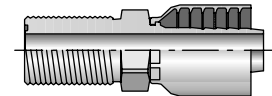

Part Number	Thread inch	Hose ID inch
1JB43-4-4	1/4	9/16x18
1JB43-6-6	3/8	11/16x16
1JB43-8-6	1/2	13/16x16
1JB43-8-8	1/2	13/16x16
1JB43-10-8	5/8	1x14
1JB43-10-10	5/8	1x14
1JB43-12-12	3/4	1-3/16x12

Fittings are stocked less locknut (part no. [WLNL](#)). Locknuts are manufactured by the Parker Tube Fittings Division and must be ordered separately.

43 Series: Use with [301LT](#), [302](#), [304](#), [351ST](#), [351TC](#), [422](#), [424](#), [426](#), [431](#), [436](#), [451TC](#), [451ST](#), [471TC](#), [471ST](#), [472TC](#), [482TC](#), [482ST](#), [722TC](#), [881](#) hoses.

Dimensions and pressures are for reference only and are subject to change.

1JC43

Female Seal-Lok™ - Swivel - Short

ISO 12151-1 - SWSA

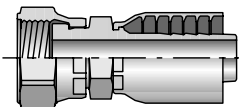

Part Number	Thread inch	Hose ID inch
1JC43-4-4	1/4 9/16x18	1/4
1JC43-4-4-SM	1/4 9/16x18	1/4
1JC43-4-6	1/4 9/16x18	3/8
1JC43-6-4	3/8 11/16x16	1/4
1JC43-6-4-SM	3/8 11/16x16	1/4
1JC43-6-5	3/8 11/16x16	5/16
1JC43-6-6	3/8 11/16x16	3/8
1JC43-6-6-SM	3/8 11/16x16	3/8
1JC43-8-6	1/2 13/16x16	3/8
1JC43-8-6-SM	1/2 13/16x16	3/8
1JC43-8-8	1/2 13/16x16	1/2
1JC43-8-8-SM	1/2 13/16x16	1/2
1JC43-10-8	5/8 1x14	1/2
1JC43-10-8-SM	5/8 1x14	1/2
1JC43-10-10	5/8 1x14	5/8
1JC43-10-10-SM	5/8 1x14	5/8
1JC43-12-8	3/4 1-3/16x12	1/2
1JC43-12-10	3/4 1-3/16x12	5/8
1JC43-12-10-SM	3/4 1-3/16x12	5/8
1JC43-12-12	3/4 1-3/16x12	3/4
1JC43-12-12-SM	3/4 1-3/16x12	3/4
1JC43-12-16	3/4 1-3/16x12	1
1JC43-16-12	1 1-7/16x12	3/4
1JC43-16-16	1 1-7/16x12	1
1JC43-20-20	1-1/4 1-11/16x12	1-1/4

Stainless steel fittings must be assembled with [Karrykrimp 2](#), [PHastkrimp](#), [Superkrimp](#) or [Parkrimp 2](#).

See www.parker.com/crimpsource for more information.

1JS43

Female Seal-Lok™ - Swivel - Long

ISO 12151-1 SWSB

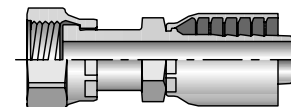

Part Number	Thread inch	Hose ID inch
1JS43-4-4	1/4 9/16x18	1/4
1JS43-4-6	1/4 9/16x18	3/8
1JS43-6-4	3/8 11/16x16	1/4
1JS43-6-6	3/8 11/16x16	3/8
1JS43-6-8	3/8 11/16x16	1/2
1JS43-8-4	1/2 13/16x16	1/4
1JS43-8-6	1/2 13/16x16	3/8
1JS43-8-8	1/2 13/16x16	1/2
1JS43-8-10	1/2 13/16x16	5/8
1JS43-10-6	5/8 1x14	3/8
1JS43-10-8	5/8 1x14	1/2
1JS43-10-10	5/8 1x14	5/8
1JS43-10-12	5/8 1x14	3/4
1JS43-12-8	3/4 1-3/16x12	1/2
1JS43-12-10	3/4 1-3/16x12	5/8
1JS43-12-12	3/4 1-3/16x12	3/4
1JS43-12-16	3/4 1-3/16x12	1
1JS43-16-12	1 1-7/16x12	3/4
1JS43-16-16	1 1-7/16x12	1
1JS43-16-20	1 1-7/16x12	1-1/4
1JS43-20-16	1-1/4 1-11/16x12	1
1JS43-20-20	1-1/4 1-11/16x12	1-1/4
1JS43-24-20	1-1/2 2x12	1-1/4
1JS43-24-24	1-1/2 2x12	1-1/2

1L743

Female JIC 37° - Swivel - 45° Elbow - Medium Drop
ISO 12151-5

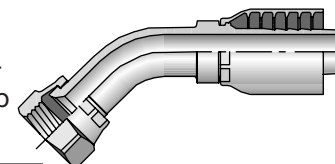

Part Number	Thread inch	Hose ID inch
1L743-6-6	3/8 9/16x18	3/8
1L743-8-8	1/2 3/4x16	1/2
1L743-12-12	3/4 1-1/16x12	3/4
1L743-16-16	1 1-5/16x12	1

1L943

Female JIC 37° - Swivel - 90° Elbow - Medium Drop
ISO 12151-5

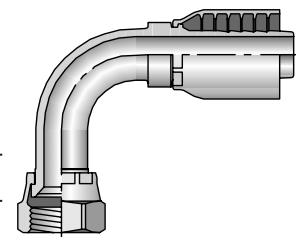

Part Number	Thread inch	Hose ID inch
1L943-4-4	1/4 7/16x20	1/4
1L943-6-4	3/8 9/16x18	1/4
1L943-6-6	3/8 9/16x18	3/8
1L943-8-6	1/2 3/4x16	3/8
1L943-8-8	1/2 3/4x16	1/2
1L943-10-8	5/8 7/8x14	1/2
1L943-12-12	3/4 1-1/16x12	3/4
1L943-16-16	1 1-5/16x12	1

43 Series: Use with [301LT](#), [302](#), [304](#), [351ST](#), [351TC](#), [422](#), [424](#), [426](#), [431](#), [436](#), [451TC](#), [451ST](#), [471TC](#), [471ST](#), [472TC](#), [482TC](#), [482ST](#), [722TC](#), [881](#) hoses.

Dimensions and pressures are for reference only and are subject to change.

[Link to Master Table of Contents](#)

[Link to Section Table of Contents](#)

1LB43

Male JIC 37° -
Bulkhead without Locknut
ISO 12151-5

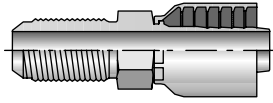

Part Number	Thread inch	Hose ID inch
1LB43-4-4	1/4 7/16x20	1/4
1LB43-6-6	3/8 9/16x18	3/8
1LB43-8-8	1/2 3/4x16	1/2
1LB43-10-10	5/8 7/8x14	5/8
1LB43-12-12	3/4 1-1/16x12	3/4

Fittings are stocked less locknut ([part no. WLN](#)).
Locknuts are manufactured by the Parker Tube Fittings Division and must be ordered separately.

1XU43

Female Metric - Swivel -
(30° Flare)

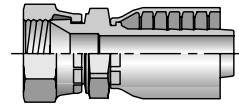

Part Number	Thread mm	Hose ID inch
1XU43-10-10	M24x1,5	5/8
1XU43-12-12	M30x1,5	3/4
1XU43-16-16	M33x1,5	1
1XU43-20-20	M36x1,5	1-1/4
1XU43-24-24	M42x1,5	1-1/2

Japanese Fittings - Female Swivel 30° Flare with Metric Threads.
All 30° flared fitting sizes are available by combining the 1MU43 fittings in sizes up to -8 with the 1XU43 fittings in sizes -10 and larger.

1MU43

Female Metric - Swivel -
(30° Flare)

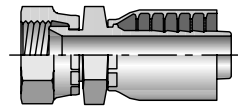

Part Number	Thread mm	Hose ID inch
1MU43-4-4	M14x1,5	1/4
1MU43-6-4	M18x1,5	1/4
1MU43-6-6	M18x1,5	3/8
1MU43-8-8	M22x1,5	1/2

Japanese Fittings - Female Swivel 30° Flare with Metric Threads. All 30° flared fitting sizes are available by combining the 1MU43 fittings in sizes up to -8 with the 1XU43 fittings in sizes -10 and larger.

56 Series

10156

Male Taper Pipe Rigid

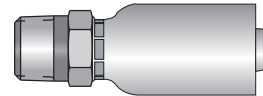

Part Number	Thread inch	Hose ID inch	mm
10156-2-3	1/8-27	3/16	5
10156-4-3	1/4-18	3/16	5
10156-4-4	1/4-18	1/4	6
10156-4-6	1/4-18	3/8	10
10156-6-6	3/8-18	3/8	10
10156-8-8	1/2-14	1/2	13
10156-12-10	3/4-14	5/8	16
10156-12-12	3/4-14	3/4	19
10156-16-16	1-11-1/2	1	25

Construction: Steel. Add "C" for Stainless Steel.
Note: Metric hex parts are available upon request.

1S243

Female NPTF Pipe -
Swivel

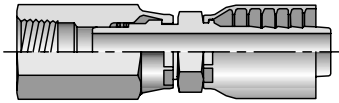

Part Number	Thread inch	Hose ID inch
1S243-4-4	1/4x18	1/4

1UT43

Male BSP Taper Pipe -
Rigid - (60° Cone)
B8363 Code R

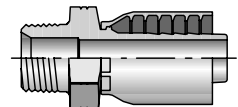

Part Number	Thread inch	Hose ID inch
1UT43-4-4	1/4x19	1/4
1UT43-6-6	3/8x19	3/8
1UT43-8-8	1/2x14	1/2
1UT43-12-12	3/4x14	3/4
1UT43-16-16	1x11	1
1UT43-20-20	1-1/4x11	1-1/4

10256

Female Taper Pipe Rigid

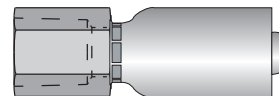

Part Number	Thread inch	Hose ID inch	mm
10256-4-4	1/4-18	1/4	6

Construction: Steel. Add "C" for Stainless Steel.

56 Series: Use with 510C, 518C, 540N, 548N, 560, 590, D6R hoses.

43 Series: Use with 301LT, 302, 304, 351ST, 351TC, 422, 424, 426, 431, 436, 451TC, 451ST, 471TC, 471ST, 472TC, 482TC, 482ST, 722TC, 881, S4 hoses.

Dimensions and pressures are for reference only and are subject to change.

10356

Male (JIC) 37° - Rigid

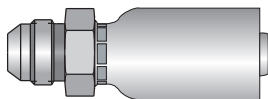

Part Number	Thread inch	Hose ID	
		inch	mm
10356-4-3	7/16-20	3/16	5
10356-4-4	7/16-20	1/4	6
10356-5-4	1/2-20	1/4	6
10356-6-4	9/16-18	1/4	6
10356-6-5	9/16-18	5/16	8
10356-5-6	1/2-20	3/8	10
10356-6-6	9/16-18	3/8	10
10356-8-6	3/4-16	3/8	10
10356-8-8	3/4-16	1/2	13
10356-10-8	7/8-14	1/2	13
10356-12-10	1-1/16-12	5/8	16
10356-12-12	1-1/16-12	3/4	19
10356-16-16	1-5/16-12	1	25

Construction: Steel. Add "C" for Stainless Steel.

Note: Metric hex parts are available upon request.

10456

Male SAE 45° - Rigid

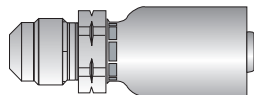

Part Number	Thread inch	Hose ID	
		inch	mm
10456-4-3	7/16-20	3/16	5
10456-5-4	1/2-20	1/4	6
10456-6-5	5/8-18	5/16	8
10456-6-6	5/8-18	1/2	13
10456-6-8	5/8-18	1/2	13
10456-8-8	3/4-16	1/2	13
10456-12-12	1-1/16-14	3/4	19

Construction: Steel. Add "C" for Stainless Steel.

10556

Male Straight Thread O-Ring (BUNA N O-Ring included)

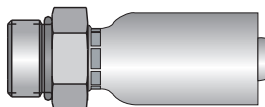

Part Number	Thread inch	Hose ID	
		inch	mm
10556-4-3	7/16-20	3/16	4
10556-6-3	9/16-18	3/16	4
10556-4-4	7/16-20	1/4	6
10556-5-4	1/2-20	1/4	6
10556-6-4	9/16-18	1/4	6
10556-4-5	7/16-20	5/16	8
10556-5-5	1/2-20	5/16	8
10556-6-6	9/16-18	3/8	10
10556-8-6	3/4-16	3/8	10
10556-8-8	3/4-16	1/2	12
10556-10-8	7/8-14	1/2	12

Construction: Steel. Add "C" for Stainless Steel.

Note: Metric hex parts are available upon request.

10656

SAE (JIC) 37° Swivel

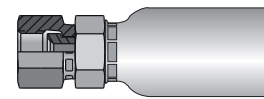

Part Number	Thread inch	Hose ID	
		inch	mm
10656-3-3	3/8-24	3/16	5
10656-4-3	7/16-20	3/16	5
10656-5-3	1/2-20	3/16	5
10656-2-4	3/8-24	1/4	6
10656-4-4	7/16-20	1/4	6
10656-5-4	1/2-20	1/4	6
10656-6-4	9/16-18	1/4	6
10656-4-5	7/16-20	5/16	8
10656-5-5	1/2-20	5/16	8
10656-6-5	9/16-18	5/16	8
10656-4-6	7/16-20	3/8	10
10656-5-6	1/2-20	3/8	10
10656-6-6	9/16-18	3/8	10
10656-8-6	3/4-16	3/8	10
10656-6-8	9/16-18	1/2	13
10656-8-8	3/4-16	1/2	13
10656-10-8	7/8-14	1/2	13
10656-8-10	3/4-16	5/8	16
10656-10-10	7/8-14	5/8	16
10656-12-10	1-1/16-12	5/8	16
10656-10-12	7/8-14	3/4	19
10656-12-12	1-1/16-12	3/4	19
10656-16-12	1-5/16-12	3/4	19
10656-16-16	1-5/16-12	1	25
10656-20-16	1-5/8-12	1	25

Construction: Steel. Add "C" for Stainless Steel.

Note: Metric hex parts are available upon request.

Sizes -4, -5, -8 and -10 incorporate a dual seat.

10756

Female Pipe Swivel

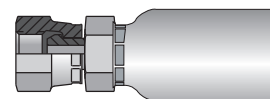

Part Number	Thread inch	Hose ID	
		inch	mm
10756-4-4	1/4-18	1/4	6
10756-4-5	1/4-18	5/16	8
10756-6-6	3/8-18	3/8	10
10756-8-8	1/2-14	1/2	13
10756-12-12	3/4-14	3/4	19
10756-16-16	1-11/12	1	25

Construction: Steel. Add "C" for Stainless Steel.

10856

Female SAE 45° Swivel

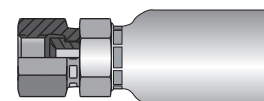

Part Number	Thread inch	Hose ID	
		inch	mm
10856-6-4	5/8-18	1/4	6
10856-6-5	5/8-18	5/16	8
10856-6-6	5/8-18	3/8	10
10856-12-12	1-1/16-14	3/4	19

Construction: Steel. Add "C" for Stainless Steel.

56 Series: Use with 510C, 518C, 540N, 548N, 560, 590, D6R hoses.
Dimensions and pressures are for reference only and are subject to change.

10C56

Metric Female Swivel 24° With O-Ring 45° Elbow
Light Series, ISO 12151-2

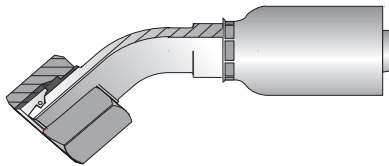

Part Number	Thread	Hose ID	
		mm	inch
10C56-6-3	M14x1.5	5	3/16
10C56-8-3	M16x1.5	5	3/16
10C56-10-4	M18x1.5	6	1/4
10C56-12-5	M20x1.5	8	5/16
10C56-12-6	M20x1.5	10	3/8
10C56-16-8	M24x1.5	13	1/2

Construction: Steel. Add "C" for Stainless Steel.

11256

SAE Flareless Swivel

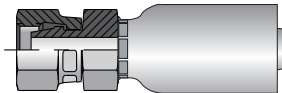

Part Number	Thread	Hose ID	
		inch	mm
11256-6-4	9/16-18	1/4	6
11256-6-6	9/16-18	3/8	10
11256-8-6	3/4-16	3/8	10

Construction: Steel. Add "C" for Stainless Steel.

11356

Male Pipe Swivel

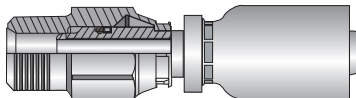

Part Number	Thread	Hose ID	
		inch	mm
11356-2-3	1/8-27	3/16	5
11356-4-3	1/4-18	3/16	5
11356-4-4	1/4-18	1/4	6
11356-4-5	1/4-18	5/16	8
11356-6-6	3/8-18	3/8	10
11356-8-6	1/2-14	3/8	10
11356-8-8	1/2-14	1/2	13
11356-12-12	3/4-14	3/4	19
11356-16-16	1-11-1/2	1	25

Construction: Steel. Add "C" for Stainless Steel.

Note: For use with petroleum based fluids.

WARNING: Fittings allow minor movement to relieve stress on hose but are not recommended for continued or extensive swiveling. Not recommended for use in CNG applications.

11C56

Metric Female Swivel 24° With O-Ring 90° Elbow
Light Series, ISO 12151-2

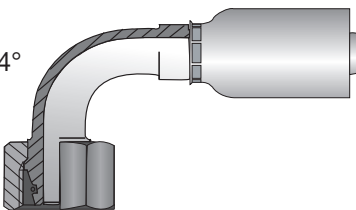

Part Number	Thread	Hose ID	
		mm	inch
11C56-8-3	M16x1.5	5	3/16
11C56-10-4	M18x1.5	6	1/4
11C56-12-5	M20x1.5	8	5/16
11C56-12-6	M20x1.5	10	3/8
11C56-16-8	M24x1.5	13	1/2

Construction: Steel. Add "C" for Stainless Steel.

13756

Female JIC 37° Swivel 45° Elbow

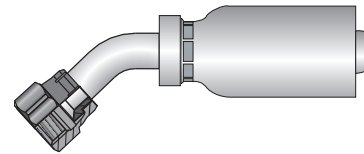

Part Number	Thread	Hose ID	
		inch	mm
13756-4-3	7/16-20	3/16	5
13756-4-4	7/16-20	1/4	6
13756-5-4	1/2-20	1/4	6
13756-6-4	9/16-18	1/4	6
13756-6-5	9/16-18	5/16	8
13756-6-6	9/16-18	3/8	10
13756-8-6	3/4-16	3/8	10
13756-8-8	3/4-16	1/2	13
13756-10-8	7/8-14	1/2	13
13756-10-10	7/8-14	5/8	16
13756-12-10	1-1/16-12	5/8	16
13756-12-12	1-1/16-12	3/4	19
13756-16-16	1-5/16-12	1	25

Construction: Steel. Add "C" for Stainless Steel.

Note: Metric hex parts are available upon request.

13956

Female JIC 37° Swivel 90° Elbow Short Drop

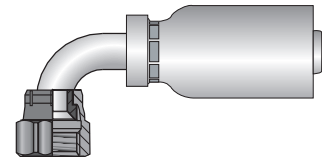

Part Number	Thread	Hose ID	
		inch	mm
13956-4-3	7/16-20	3/16	5
13956-4-4	7/16-20	1/4	6
13956-5-4	5/8-20	1/4	6
13956-6-4	9/16-18	1/4	6
13956-6-5	9/16-18	5/16	8
13956-6-6	9/16-18	3/8	10
13956-8-6	3/4-16	3/8	10
13956-8-8	3/4-16	1/2	13
13956-10-8	7/8-14	1/2	13
13956-10-10	7/8-14	5/8	16
13956-12-10	1-1/16-12	5/8	16
13956-12-12	1-1/16-12	3/4	19
13956-16-16	1-5/16-12	1	25

Construction: Steel. Add "C" for Stainless Steel.

Note: Metric hex parts are available upon request.

13E56

Male (JIC) 37° Long

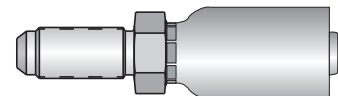

Part Number	Thread	Hose ID	
		inch	mm
13E56-4-4	7/16-20	1/4	6
13E56-6-5	9/16-18	5/16	8
13E56-6-6	9/16-18	3/8	10
13E56-8-8	3/4-16	1/2	13

Construction: Steel. Add "C" for Stainless Steel.

Note: Bulkhead Locknut sold separately. WLN Locknuts are manufactured by the Tube Fittings Division. Refer to Catalog 4300 for additional information.

56 Series: Use with 510C, 518C, 540N, 548N, 560, 590, D6R hoses.

Dimensions and pressures are for reference only and are subject to change.

14156

Female JIC 37° Swivel
90° Elbow Long Drop

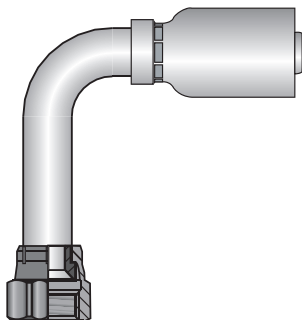

Part Number	Thread inch	Hose ID	
		inch	mm
14156-4-3	7/16-20	3/16	5
14156-4-4	7/16-20	1/4	6
14156-5-4	1/2-20	1/4	6
14156-6-4	9/16-18	1/4	6
14156-6-5	9/16-18	5/16	8
14156-6-6	9/16-18	3/8	10
14156-8-6	3/4-16	3/8	10
14156-8-8	3/4-16	1/2	13
14156-10-8	7/8-14	1/2	13
14156-12-12	1-1/16-12	3/4	19
14156-16-16	1-5/16-12	1	25

Construction: Steel. Add "C" for Stainless Steel.

16756

SAE Male Inverted Swivel
45° Elbow

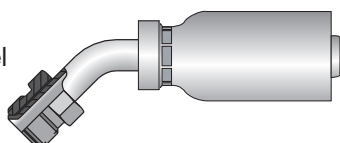

Part Number	Thread inch	Hose ID	
		inch	mm
16756-6-6	5/8-18	3/8	10

Construction: Steel. Add "C" for Stainless Steel.

16956

SAE Male Inverted Swivel
90° Elbow

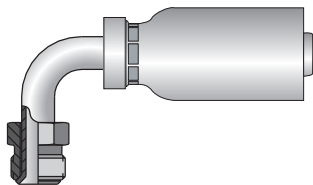

Part Number	Thread inch	Hose ID	
		inch	mm
16956-6-6	5/8-18	3/8	10

Construction: Steel. Add "C" for Stainless Steel.

19256

Female BSP Parallel Pipe
Swivel Straight (60° Cone)

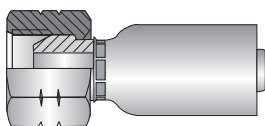

Part Number	Thread	Hose ID	
		mm	inch
19256-4-3	G 1/4	5	3/16
19256-2-4	G 1/8	6	1/4
19256-4-4	G 1/4	6	1/4
19256-6-4	G 3/8	6	1/4
19256-4-5	G 1/4	8	5/16
19256-6-5	G 3/8	8	5/16
19256-6-6	G 3/8	10	3/8
19256-8-6	G 1/2	10	3/8
19256-6-8	G 3/8	13	1/2
19256-8-8	G 1/2	13	1/2
19256-10-8	G 5/8	13	1/2
19256-12-12	G 3/4	19	3/4
19256-16-16	G 1	25	1

Construction: Steel. Add "C" for Stainless Steel.

1AL56

A-LOK® Compression
(With Nut and Ferrule)

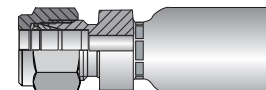

Part Number	Thread Size	Tube OD		Hose ID	
		inch	mm	inch	mm
1AL56-4-4	7/16-20	1/4	6	1/4	6
1AL56-6-6	9/16-20	3/8	10	3/8	10
1AL56-8-8	3/4-20	1/2	13	3/8	10

Construction: 316 Stainless nipple and shell.

Note: Nut part No. is XNUX or XNUX-316 for stainless steel.

Front ferrule part No. is XFFX or XFFX-316 for stainless steel.

Back ferrule part No. is XBFX or XBFX-316 for stainless steel.

X denotes dash size.

1B156

Female BSP
Parallel Pipe
Swivel 45° Elbow
(60° Cone)

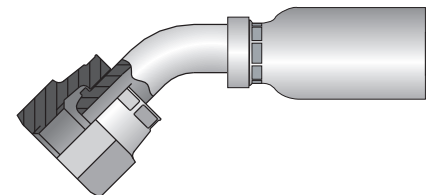

ISO 228-1

Part Number	Thread	Hose ID	
		mm	inch
1B156-4-3	G 1/4	5	3/16
1B156-4-4	G 1/4	6	1/4
1B156-6-5	G 3/8	8	5/16
1B156-6-6	G 3/8	10	3/8
1B156-8-8	G 1/2	13	1/2
1B156-12-12	G 3/4	19	3/4
1B156-16-16	G 1	25	1

Construction: Steel. Add "C" for Stainless Steel.

1B256

Female BSP Parallel
Pipe Swivel 90° Elbow
(60° Cone)

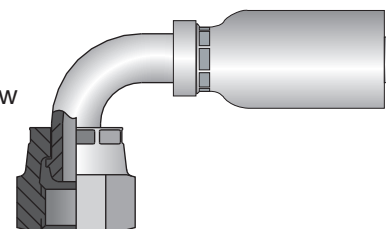

ISO 228-1

Part Number	Thread	Hose ID	
		mm	inch
1B256-4-3	G 1/4	5	3/16
1B256-4-4	G 1/4	6	1/4
1B256-4-5	G 1/4	8	5/16
1B256-6-5	G 3/8	8	5/16
1B256-6-6	G 3/8	10	3/8
1B256-8-8	G 1/2	13	1/2
1B256-12-12	G 3/4	19	3/4
1B256-16-16	G 1	25	1

Construction: Steel. Add "C" for Stainless Steel.

56 Series: Use with 510C, 518C, 540N, 548N, 560, 590, D6R hoses.

Dimensions and pressures are for reference only and are subject to change.

1B456

Female BSP Swivel
90° Elbow Block Type
(60° Cone)
ISO 228-1

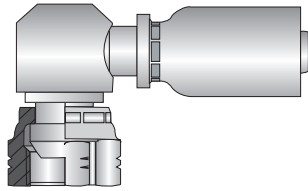

Part Number	Thread	Hose ID	
		mm	inch
1B256-4-4	G 1/4	6	1/4
1B256-6-6	G 3/8	10	3/8
1B256-8-8	G 1/2	13	1/2

Construction: Steel. Add "C" for Stainless Steel.

1C356

Metric Female Swivel Nut
Light Series, 24°/60°

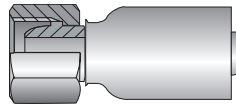

Part Number	Thread	Hose ID	
		mm	inch
1C356-6-3	M12x1.5	5	3/16
1C356-8-4	M14x1.5	6	1/4
1C356-10-4	M16x1.5	6	1/4
1C356-10-5	M16x1.5	8	5/16
1C356-12-5	M18x1.5	8	5/16
1C356-10-6	M16x1.5	10	3/8
1C356-12-6	M18x1.5	10	3/8
1C356-15-6	M22x1.5	10	3/8
1C356-15-8	M22x1.5	13	1/2
1C356-18-10	M26x1.5	16	5/8
1C356-18-12	M26x1.5	19	3/4
1C356-22-12	M30x2	19	3/4

Construction: Steel. Add "C" for Stainless Steel.

1C456

Metric Female
Swivel 45° Elbow
Light Series, 24°/60°

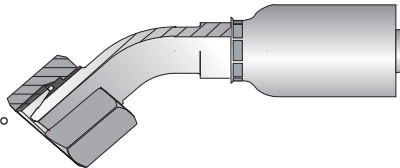

Part Number	Thread	Hose ID	
		mm	inch
1C456-6-3	M12x1.5	5	3/16
1C456-8-4	M14x1.5	6	1/4
1C456-10-5	M16x1.5	8	5/16
1C456-10-6	M16x1.5	10	3/8
1C456-12-6	M18x1.5	10	3/8
1C456-15-8	M22x1.5	13	1/2

Construction: Steel. Add "C" for Stainless Steel.

1C556

Metric Female Swivel
95° Elbow
Light Series, 24°/60°

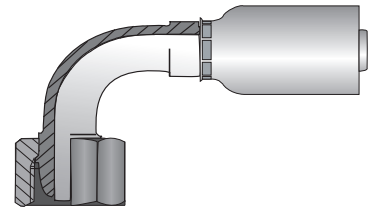

Part Number	Thread	Hose ID	
		mm	inch
1C556-6-3	M12x1.5	5	3/16
1C556-8-4	M14x1.5	6	1/4
1C556-10-4	M16x1.5	6	1/4
1C556-12-5	M18x1.5	8	5/16
1C556-10-6	M16x1.5	10	3/8
1C556-12-6	M18x1.5	10	3/8
1C556-15-8	M22x1.5	13	1/2
1C556-18-12	M26x1.5	19	3/4

Construction: Steel. Add "C" for Stainless Steel.

1C656

Female Metric Swivel DIN 20078
Heavy Series (Without O-Ring)
ISO 8434-1

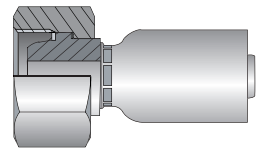

Part Number	Thread	Hose ID	
		mm	inch
1C656-8-3	M16x1.5	5	3/16
1C656-10-4	M18x1.5	6	1/4
1C656-12-5	M20x1.5	8	5/16
1C656-12-6	M20x1.5	10	3/8
1C656-14-6	M22x1.5	10	3/8
1C656-16-8	M24x1.5	10	1/2
1C656-20-12	M30x2	13	3/4

Construction: Steel. Add "C" for Stainless Steel.

1C956

Female Metric Swivel DIN 20078
Heavy Series, (With O-Ring)
ISO 12151-2-SWS

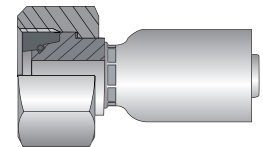

Part Number	Thread	Hose ID	
		mm	inch
1C956-8-3	M16x1.5	5	3/16
1C956-8-4	M16x1.5	6	1/4
1C956-10-4	M18x1.5	6	1/4
1C956-12-4	M20x1.5	6	1/4
1C956-10-5	M18x1.5	8	5/16
1C956-12-5	M20x1.5	8	5/16
1C956-12-6	M20x1.5	10	3/8
1C956-14-6	M22x1.5	10	3/8
1C956-16-8	M24x1.5	13	1/2
1C956-20-12	M30x2	19	3/4
1C956-25-12	M36x2	19	3/4

Construction: Steel. Add "C" for Stainless Steel.

56 Series: Use with 510C, 518C, 540N, 548N, 560, 590, D6R hoses.

Dimensions and pressures are for reference only and are subject to change.

1CA56

Metric Female Swivel 24°
With O-Ring
Light Series, ISO 12151-2

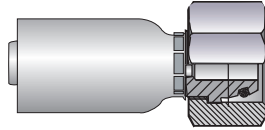

Part Number	Thread	Hose ID	
		mm	inch
1CA56-6-3	M12x1.5	5	3/16
1CA56-6-4	M12x1.5	6	1/4
1CA56-8-4	M14x1.5	6	1/4
1CA56-10-4	M16x1.5	6	1/4
1CA56-12-4	M18x1.5	6	1/4
1CA56-10-5	M16x1.5	8	5/16
1CA56-12-5	M18x1.5	8	5/16
1CA56-10-6	M16x1.5	10	3/8
1CA56-12-6	M18x1.5	10	3/8
1CA56-15-6	M22x1.5	10	3/8
1CA56-12-8	M18x1.5	13	1/2
1CA56-15-8	M22x1.5	13	1/2
1CA56-18-8	M26x1.5	13	1/2
1CA56-18-10	M26x1.5	16	5/8
1CA56-18-12	M26x1.5	19	3/4
1CA56-22-12	M30x2	19	3/4
1CA56-28-16	M36x2	25	1

Construction: Steel. Add "C" for Stainless Steel.

1CE56

Metric Female Swivel
24° With O-Ring
45° Elbow
Light Series, ISO 12151-2

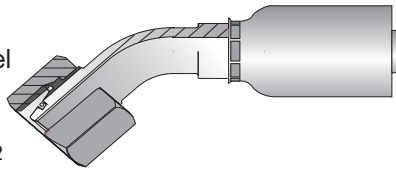

Part Number	Thread	Hose ID	
		mm	inch
1CE56-6-3	M12x1.5	5	3/16
1CE56-8-4	M14x1.5	6	1/4
1CE56-10-4	M16x1.5	6	1/4
1CE56-10-5	M16x1.5	8	5/16
1CE56-10-6	M16x1.5	10	3/8
1CE56-12-6	M18x1.5	10	3/8
1CE56-15-8	M22x1.5	13	1/2
1CE56-18-10	M26x1.5	16	5/8
1CE56-18-12	M26x1.5	19	3.4
1CE56-22-12	M30x2	19	3.4
1CE56-28-16	M36x2	25	1

Construction: Steel. Add "C" for Stainless Steel.

1CF56

Metric Female Swivel 24°
With O-Ring 90° Elbow
Light Series, ISO 12151-2

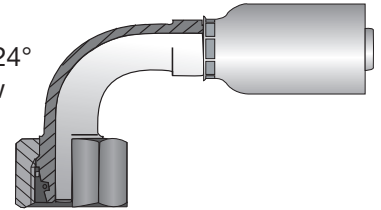

Part Number	Thread	Hose ID	
		mm	inch
1CF56-6-3	M12x1.5	5	3/16
1CF56-6-4	M12x1.5	6	1/4
1CF56-8-4	M14x1.5	6	1/4
1CF56-10-4	M16x1.5	6	1/4
1CF56-10-5	M16x1.5	8	5/16
1CF56-12-5	M18x1.5	8	5/16
1CF56-10-6	M16x1.5	10	3/8
1CF56-12-6	M18x1.5	10	3/8
1CF56-15-8	M22x1.5	13	1/2
1CF56-18-10	M26x1.5	16	5/8
1CF56-22-12	M30x2	19	3/4
1CF56-28-16	M36x2	25	1

Construction: Steel. Add "C" for Stainless Steel.

1D056

Male Stud DIN 20078
Light Series, ISO 8434-1

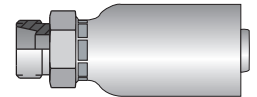

Part Number	Thread	Hose ID	
		mm	inch
1D056-6-3	M12x1.5	5	3/16
1D056-6-4	M12x1.5	6	1/4
1D056-8-4	M14x1.5	6	1/4
1D056-10-5	M16x1.5	8	5/16
1D056-12-5	M18x1.5	8	5/16
1D056-10-6	M16x1.5	10	3/8
1D056-12-6	M18x1.5	10	3/8
1D056-15-6	M22x1.5	10	3/8
1D056-15-8	M22x1.5	13	1/2
1D056-18-10	M26x1.5	16	5/8
1D056-22-12	M30x2	19	3/4
1D056-28-16	M36x2	25	1

Construction: Steel. Add "C" for Stainless Steel.

1D256

Metric Male Stud 24°
Light Series, ISO 12151-2

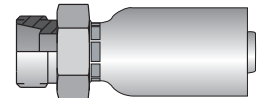

Part Number	Thread	Hose ID	
		mm	inch
1D256-8-3	M16x1.5	5	3/16
1D256-10-4	M18x1.5	6	1/4
1D256-10-5	M18x1.5	8	5/16
1D256-12-5	M20x1.5	8	5/16
1D256-12-6	M20x1.5	10	3/8
1D256-14-6	M22x1.5	10	3/8
1D256-16-6	M24x1.5	10	3/8
1D256-16-8	M24x1.5	13	1/2
1D256-20-12	M30x2	19	3/4

Construction: Steel. Add "C" for Stainless Steel.

56 Series: Use with 510C, 518C, 540N, 548N, 560, 590, D6R hoses.

Dimensions and pressures are for reference only and are subject to change.

1D956

Male BSPP - Straight (60° Cone)
ISO 228-1

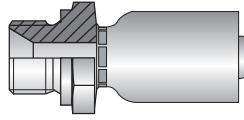

Part Number	Thread	Hose ID	
		mm	inch
1D956-4-3	G 1/4	5	3/16
1D956-4-4	G 1/4	6	1/4
1D956-6-5	G 3/8	8	5/16
1D956-6-6	G 3/8	10	3/8
1D956-8-8	G 1/2	13	1/2
1D956-12-12	G 3/4	19	3/4
1D956-16-16	G 1	25	1

Construction: Steel. Add "C" for Stainless Steel.

1J056

Male Seal-Lok™ Rigid
Straight w/O-Ring
ISO 12151-1-S

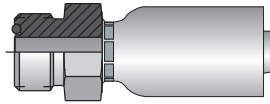

Part Number	Thread inch	Hose ID	
		inch	mm
1J056-4-4	9/16-18	1/4	6
1J056-6-4	11/16-16	1/4	6
1J056-6-6	11/16-16	3/8	10
1J056-8-6	13/16-16	1/2	13
1J056-8-8	13/16-16	1/2	13

Construction: Steel. Add "C" for Stainless Steel.

Note: Metric hex parts are available upon request.

1J156

Female Seal-Lok™ Swivel
90° Elbow Long Drop
ISO 12151-1-SWEL90

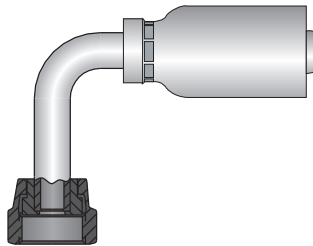

Part Number	Thread inch	Hose ID	
		inch	mm
1J156-4-3	9/16-18	3/16	5
1J156-4-4	9/16-18	1/4	6
1J156-6-4	11/16-16	1/4	6
1J156-6-6	11/16-16	3/8	10
1J156-8-6	13/16-16	3/8	10
1J156-8-8	13/16-16	1/2	10
1J156-12-12	1-3/16-12	3/4	19
1J156-16-16	1-7/16-12	1	25

Construction: Steel. Add "C" for Stainless Steel.

Note: Metric hex parts are available upon request.

1J256

Female Seal-Lok™
Swivel 30° Elbow

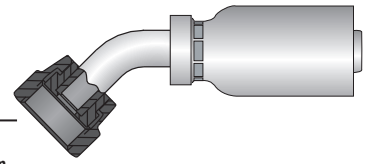

Part Number	Thread inch	Hose ID	
		inch	mm
1J256-8-8	13/16-16	1/2	13

Construction: Steel. Add "C" for Stainless Steel.

1J556

Female Seal-Lok™ Swivel
90° Elbow Medium Drop
ISO 12151-1-SWEM90

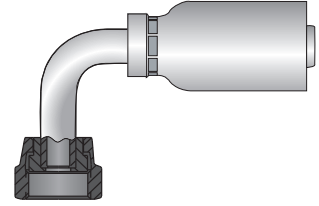

Part Number	Thread inch	Hose ID	
		inch	mm
1J556-4-3	9/16-18	3/16	5
1J556-4-4	9/16-18	1/4	6
1J556-6-4	11/16-16	1/4	6
1J556-6-5	11/16-16	5/16	8
1J556-6-6	11/16-16	3/8	10
1J556-8-6	13/16-16	3/8	10
1J556-8-8	13/16-16	1/2	13
1J556-10-8	1-14	1/2	13
1J556-10-10	1-14	5/8	16
1J556-12-12	1-3/16-12	3/4	19
1J556-16-16	1-7/16-12	1	25

Construction: Steel. Add "C" for Stainless Steel.

Note: Metric hex parts are available upon request.

1J756

Female Seal-Lok™ Swivel
45° Elbow
ISO 12151-1-SWE45

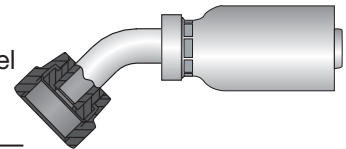

Part Number	Thread inch	Hose ID	
		inch	mm
1J756-4-3	9/16-18	3/16	5
1J756-4-4	9/16-18	1/4	6
1J756-6-4	11/16-16	1/4	6
1J756-6-5	11/16-16	5/16	8
1J756-4-6	9/16-18	3/8	10
1J756-6-6	11/16-16	3/8	10
1J756-8-6	13/16-16	3/8	10
1J756-8-8	13/16-16	1/2	13
1J756-10-10	1-14	5/8	16
1J756-12-12	1-3/16-12	3/4	19
1J756-16-16	1-7/16-12	1	25

Construction: Steel. Add "C" for Stainless Steel.

Note: Metric hex parts are available upon request.

56 Series: Use with 510C, 518C, 540N, 548N, 560, 590, D6R hoses.

Dimensions and pressures are for reference only and are subject to change.

1J956

Female Seal-Lok™ Swivel
90° Elbow Short Drop
ISO 12151-1-SWES90

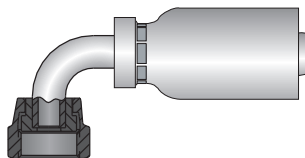

Part Number	Thread inch	Hose ID	
		inch	mm
1J956-4-3	9/16-18	3/16	5
1J956-4-4	9/16-18	1/4	6
1J956-6-4	11/16-16	1/4	6
1J956-6-5	11/16-16	5/16	8
1J956-6-6	11/16-16	3/8	10
1J956-8-6	13/16-16	3/8	10
1J956-8-8	13/16-16	1/2	13
1J956-10-8	1-14	1/2	13
1J956-10-10	1-14	5/8	16
1J956-12-12	1-3/16-12	3/4	19
1J956-16-16	1-7/16-12	1	25

Construction: Steel. Add "C" for Stainless Steel.
Note: Metric hex parts are available upon request.

1JS56

Female Seal-Lok™ Straight
ISO 12151-1-SWSB

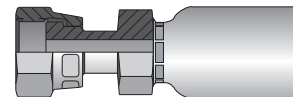

Part Number	Thread inch	Hose ID	
		inch	mm
1JS56-4-3	9/16-18	3/16	5
1JS56-4-4	9/16-18	1/4	6
1JS56-6-4	11/16-16	1/4	6
1JS56-6-5	11/16-16	5/16	8
1JS56-6-6	11/16-16	3/8	10
1JS56-8-6	13/16-16	3/8	10
1JS56-8-8	11/16-16	1/2	13
1JS56-8-8	13/16-16	1/2	13
1JS56-10-8	1-14	1/2	13
1JS56-10-10	1-14	5/8	16
1JS56-12-12	1-3/16-12	3/4	19
1JS56-16-16	1-7/16-12	1	25

Construction: Steel. Add "C" for Stainless Steel.
Note: Metric hex parts are available upon request.

1JC56

Female Seal-Lok™ Straight -
Swivel - Short
ISO 12151-1-SWSA

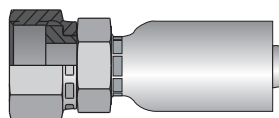

Part Number	Thread inch	Hose ID	
		inch	mm
1JC56-4-3	9/16-18	3/16	5
1JC56-4-4	9/16-18	1/4	6
1JC56-6-4	11/16-16	1/4	6
1JC56-4-5	9/16-18	5/16	8
1JC56-6-5	11/16-16	5/16	8
1JC56-4-6	9/16-18	3/8	10
1JC56-6-6	11/16-16	3/8	10
1JC56-8-6	13/16-16	3/8	10
1JC56-8-8	13/16-16	1/2	13
1JC56-10-8	1-14	1/2	13
1JC56-10-10	1-14	5/8	16
1JC56-12-10	1-3/16-12	5/8	16
1JC56-10-12	1-14	3/4	19
1JC56-12-12	1-3/16-12	3/4	19
1JC56-16-16	1-7/16-12	1	25

Construction: Steel. Add "C" for Stainless Steel.
Note: Metric hex parts are available upon request.

1L956

Female JIC 37° Swivel
90° Elbow Medium Drop

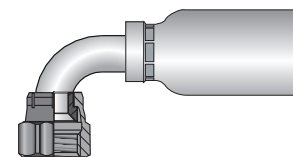

Part Number	Thread inch	Hose ID	
		inch	mm
1L956-4-3	7/16-20	3/16	5
1L956-4-4	7/16-20	1/4	6
1L956-5-4	1/2-20	1/4	6
1L956-6-5	9/16-18	5/16	8
1L956-6-6	9/16-18	3/8	10
1L956-8-6	3/4-16	3/8	10
1L956-8-8	3/4-16	1/2	13
1L956-10-8	7/8-14	1/2	13
1L956-12-12	1-1/16-12	3/4	19
1L956-16-16	1-5/16-12	1	25

Construction: Steel. Add "C" for Stainless Steel.

1TU56

Universal Inch Tube Stub End

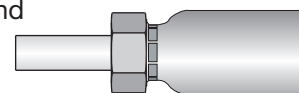

Part Number	Thread inch	Hose ID	
		inch	mm
1TU56-4-4	1/4	1/4	6
1TU56-6-4	3/8	1/4	6
1TU56-6-6	3/8	3/8	10
1TU56-8-8	1/2	1/2	13
1TU56-12-12	3/4	3/4	19
1TU56-16-16	1	1	25

Construction: Steel. Add "C" for Stainless Steel.
Note: Use with A-LOK & CPI nuts, sleeves and adapters. These components are manufactured by Parker's Instrumentation Connectors Division. Refer to catalogs 4230 & 4233 for additional information.

56 Series: Use with 510C, 518C, 540N, 548N, 560, 590, D6R hoses.
Dimensions and pressures are for reference only and are subject to change.

71 Series

10171

Male NPTF Pipe - Rigid

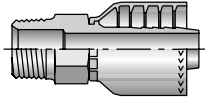

Part Number	Thread inch	Hose ID inch
10171-6-6	3/8x18	3/8
10171-8-8	1/2x14	1/2
10171-12-8	3/4x14	1/2
10171-12-12	3/4x14	3/4
10171-16-12	1x11-1/2	3/4
10171-16-16	1x11-1/2	1
10171-20-16	1-1/4x11-1/2	1
10171-20-20	1-1/4x11-1/2	1-1/4
10171-24-20	1-1/2x11-1/2	1-1/4
10171-24-24	1-1/2x11-1/2	1-1/2
10171-32-32	2x11-1/2	2

10371

Male JIC 37° - Rigid

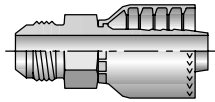

Part Number	Thread inch	Hose ID inch
10371-6-6	3/8 9/16x18	3/8
10371-8-6	1/2 3/4x16	3/8
10371-8-8	1/2 3/4x16	1/2
10371-10-8	5/8 7/8x14	1/2
10371-10-10	5/8 7/8x14	5/8
10371-12-12	3/4 1-1/16x12	3/4
10371-14-12	7/8 1-3/16x12	3/4
10371-16-12	1 1-5/16x12	3/4
10371-16-16	1 1-5/16x12	1
10371-20-16	1-1/4 1-5/8x12	1
10371-20-20	1-1/4 1-5/8x12	1-1/4

10571

Male SAE Straight Thread with O-Ring - Rigid

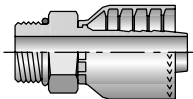

Part Number	Thread inch	Hose ID inch
10571-8-8	1/2 3/4x16	1/2
10571-12-12	3/4 1-1/16x12	3/4
10571-16-16	1 1-5/16x12	1
10571-20-20	1-1/4 1-5/8x12	1-1/4

10671

Female JIC 37° - Swivel

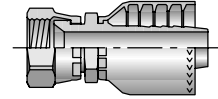

Part Number	Thread inch	Hose ID inch
10671-6-6	3/8 9/16x18	3/8
10671-8-6	1/2 3/4x16	3/8
10671-8-8	1/2 3/4x16	1/2
10671-10-8	5/8 7/8x14	1/2
10671-10-10	5/8 7/8x14	5/8
10671-10-12	5/8 7/8x14	3/4
10671-12-8	3/4 1-1/16x12	1/2
10671-12-10	3/4 1-1/16x12	5/8
10671-12-12	3/4 1-1/16x12	3/4
10671-12-16	3/4 1-1/16x12	1
10671-14-12	7/8 1-3/16x12	3/4
10671-16-12	1 1-5/16x12	3/4
10671-16-16	1 1-5/16x12	1
10671-20-16	1-1/4 1-5/8x12	1
10671-20-20	1-1/4 1-5/8x12	1-1/4
10671-24-20	1-1/2 1-7/8x12	1-1/4
10671-24-24	1-1/2 1-7/8x12	1-1/2
10671-32-32	2 2-1/2x12	2

Stainless steel fittings must be assembled with [Karrykrimp 2](#), [PHastkrimp](#), [Superkrimp](#) or [Parkrimp 2](#). See www.parker.com/crimpsource for more information.

11571

SAE Code 61 Flange Head
ISO 12151-3 - S - L

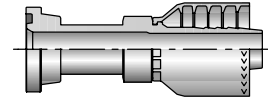

Part Number	Flange inch	Hose ID inch
11571-8-8	1/2	1/2
11571-10-10	5/8	5/8
11571-12-8	3/4	1/2
11571-12-12	3/4	3/4
11571-16-12	1	3/4
11571-16-16	1	1
11571-20-12	1-1/4	3/4
11571-20-16	1-1/4	1
11571-20-20	1-1/4	1-1/4
11571-20-24	1-1/4	1-1/2
11571-24-16	1-1/2	1
11571-24-20	1-1/2	1-1/4
11571-24-24	1-1/2	1-1/2
11571-24-32	1-1/2	2
11571-32-20	2	1-1/4
11571-32-24	2	1-1/2
11571-32-32	2	2
11571-40-32	2-1/2	2

71 Series: Use with [711](#), [721](#), [721TC](#), [721ST](#), [722TC](#), [772TC](#), [772ST](#), [774](#) hoses.
Dimensions and pressures are for reference only and are subject to change.

11671

SAE Code 61 Flange Head - 22-1/2° Elbow
ISO 12151-3 - E22M - L

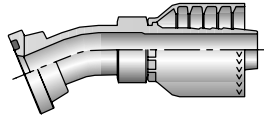

Part Number	Flange inch	Hose ID inch
11671-12-12	3/4	3/4
11671-16-12	1	3/4
11671-16-16	1	1
11671-20-16	1-1/4	1
11671-20-20	1-1/4	1-1/4
11671-24-20	1-1/2	1-1/4
11671-24-24	1-1/2	1-1/2
11671-32-32	2	2

11771

SAE Code 61 Flange Head - 45° Elbow
ISO 12151-3 - E45S - L
(1 Piece: ISO 12151-3 - E45M - L)

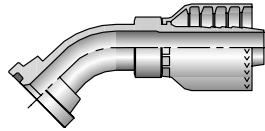

Part Number	Flange inch	Hose ID inch
11771-10-10	5/8	5/8
11771-12-8	3/4	1/2
11771-12-10	3/4	5/8
11771-12-12	3/4	3/4
11771-16-12	1	3/4
11771-16-16	1	1
11771-20-16	1-1/4	1
11771-20-20	1-1/4	1-1/4
11771-20-24	1-1/4	1-1/2
11771-24-20	1-1/2	1-1/4
11771-24-24	1-1/2	1-1/2
11771-32-24	2	1-1/2
11771-32-32	2	2
11771-40-32	2-1/2	2

11871

SAE Code 61 Flange Head - 67-1/2° Elbow
ISO 12151-3 - E67S - L
(1 Piece: ISO 12151-3 - E67M - L)

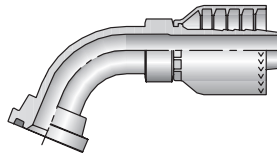

Part Number	Flange inch	Hose ID inch
11871-12-12	3/4	3/4
11871-16-12	1	3/4
11871-16-16	1	1
11871-20-20	1-1/4	1-1/4
11871-24-20	1-1/2	1-1/4
11871-24-24	1-1/2	1-1/2
11871-32-24	2	1-1/2
11871-32-32	2	2

11971

SAE Code 61 Flange Head - 90° Elbow
ISO 12151-3 - E90S - L
(1 Piece: ISO 12151-3 - E90M - L)

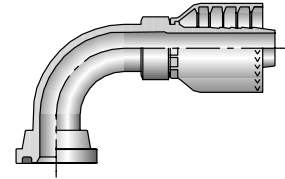

Part Number	Flange inch	Hose ID inch
11971-8-8	1/2	1/2
11971-10-10	5/8	5/8
11971-12-8	3/4	1/2
11971-12-10	3/4	5/8
11971-12-12	3/4	3/4
11971-16-12	1	3/4
11971-16-16	1	1
11971-16-20	1	1-1/4
11971-20-12	1-1/4	3/4
11971-20-16	1-1/4	1
11971-20-20	1-1/4	1-1/4
11971-20-24	1-1/4	1-1/2
11971-24-16	1-1/2	1
11971-24-20	1-1/2	1-1/4
11971-24-24	1-1/2	1-1/2
11971-32-24	2	1-1/2
11971-32-32	2	2
11971-40-32	2-1/2	2

12671

SAE Code 61 Flange Head - 30° Elbow
ISO 12151-3 - E30S - L
(1 Piece: ISO 12151-3 - E30M - L)

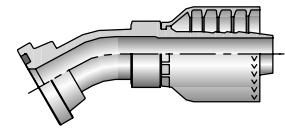

Part Number	Flange inch	Hose ID inch
12671-12-12	3/4	3/4
12671-16-16	1	1
12671-20-16	1-1/4	1
12671-20-20	1-1/4	1-1/4
12671-24-24	1-1/2	1-1/2
12671-32-24	2	1-1/2
12671-32-32	2	2

12771

SAE Code 61 Flange Head - 60° Elbow
ISO 12151-3 - E60S - L
(1 Piece: ISO 12151-3 - E60M - L)

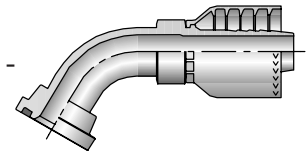

Part Number	Flange inch	Hose ID inch
12771-12-12	3/4	3/4
12771-16-12	1	3/4
12771-16-16	1	1
12771-20-20	1-1/4	1-1/4
12771-24-20	1-1/2	1-1/4
12771-24-24	1-1/2	1-1/2
12771-32-32	2	2

71 Series: Use with 711, 721, 721TC, 721ST, 722TC, 722ST, 774 hoses.
Dimensions and pressures are for reference only and are subject to change.

12U71

SAE Code 61 Flange Head - 110° Elbow

Part Number	Flange inch	Hose ID inch
12U71-16-16	1	1

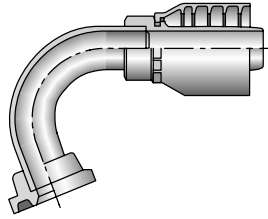

13771

Female JIC 37° - Swivel - 45° Elbow - Short Drop

Part Number	Thread inch	Hose ID inch
13771-6-6	3/8 9/16x18	3/8
13771-8-8	1/2 3/4x16	1/2
13771-10-8	5/8 7/8x14	1/2
13771-10-10	5/8 7/8x14	5/8
13771-12-12	3/4 1-1/16x12	3/4
13771-16-16	1 1-5/16x12	1
13771-20-20	1-1/4 1-5/8x12	1-1/4

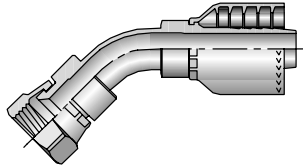

Stainless steel fittings must be assembled with [Karrykrimp 2](#), [PHastkrimp](#), [Superkrimp](#) or [Parkrimp 2](#). See www.parker.com/crimpsource for more information.

13971

Female JIC 37° - Swivel - 90° Elbow - Short Drop

Part Number	Thread inch	Hose ID inch
13971-6-6	3/8 9/16x18	3/8
13971-8-8	1/2 3/4x16	1/2
13971-10-8	5/8 7/8x14	1/2
13971-10-10	5/8 7/8x14	5/8
13971-12-10	3/4 1-1/16x12	5/8
13971-12-12	3/4 1-1/16x12	3/4
13971-16-16	1 1-5/16x12	1
13971-20-20	1-1/4 1-5/8x12	1-1/4
13971-24-24	1-1/2 1-7/8x12	1-1/2

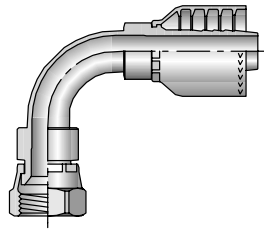

14171

Female JIC 37° - Swivel - 90° Elbow - Long Drop

Part Number	Thread inch	Hose ID inch
14171-6-6	3/8 9/16x18	3/8
14171-8-8	1/2 3/4x16	1/2
14171-12-12	3/4 1-1/16x14	3/4
14171-16-16	1 1-5/16x12	1

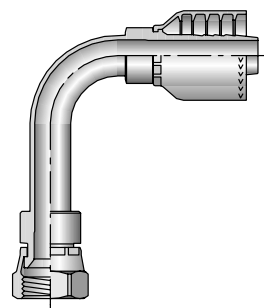

16A71

SAE Code 62 Flange Head ISO 12151-3 - S - S

Part Number	Flange inch	Hose ID inch
16A71-12-12	3/4	3/4
16A71-16-12	1	3/4
16A71-16-16	1	1
16A71-20-16	1-1/4	1
16A71-20-20	1-1/4	1-1/4
16A71-24-24	1-1/2	1-1/2
16A71-32-32	2	2

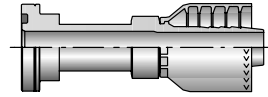

16F71

SAE Code 62 Flange Head - 45° Elbow

ISO 12151-3 - E45S - L
(1 Piece: ISO 12151-3 - E45M - S)

Part Number	Flange inch	Hose ID inch
16F71-12-12	3/4	3/4
16F71-16-16	1	1
16F71-20-16	1-1/4	1
16F71-20-20	1-1/4	1-1/4
16F71-24-24	1-1/2	1-1/2
16F71-32-32	2	2

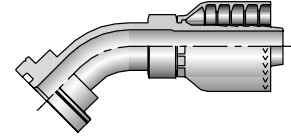

16N71

SAE Code 62 Flange Head - 90° Elbow

ISO 12151-3 - E90S - L
(1 Piece: ISO 12151-3 - E90M - S)

Part Number	Flange inch	Hose ID inch
16N71-12-12	3/4	3/4
16N71-16-12	1	3/4
16N71-16-16	1	1
16N71-20-16	1-1/4	1
16N71-20-20	1-1/4	1-1/4
16N71-24-24	1-1/2	1-1/2
16N71-32-32	2	2

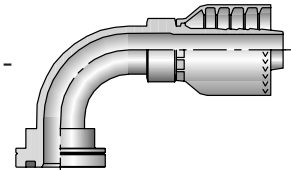

See [Section M](#) for O-Rings and Flange Kits.

⚠ Refer to [Section O](#) for Pressure Rating of Hose End Connections chart.

18971

SAE Code 61 Flange Head - 90° Elbow - Long Drop

Part Number	Flange inch	Hose ID inch
18971-12-12	3/4	3/4
18971-16-16	1	1
18971-20-16	1-1/4	1

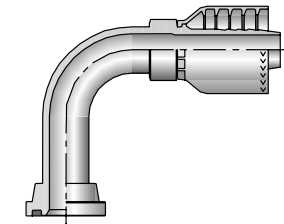

71 Series: Use with [711](#), [721](#), [721TC](#), [721ST](#), [722TC](#), [772TC](#), [772ST](#), [774](#) hoses.
Dimensions and pressures are for reference only and are subject to change.

1C971

Female Metric S - Swivel - (24° Cone with O-Ring)
ISO 12151-2 - SWS - S

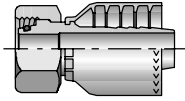

Part Number	Thread mm	Hose ID inch
1C971-12-6	12 M20x1,5	3/8
1C971-16-8	16 M24x1,5	1/2
1C971-20-10	20 M30x2	5/8
1C971-25-12	25 M36x2	3/4
1C971-30-16	30 M42x2	1
1C971-38-20	38 M52x2	1-1/4

Metric S: Mates with EO "S" Series Fittings.
^^ Must be assembled with Die Part No. 83C-D20H in a Superkrimp or Parkrimp 2.

1D271

Male Metric S - Rigid - (24° Cone)
ISO 12151-2

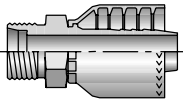

Part Number	Thread mm	Hose ID inch
1D271-25-12	25 M36x2	3/4
1D271-30-16	30 M42x2	1

Metric S: Mates with EO "S" Series Fittings.
^^ Must be assembled with Die Part No. 83C-D20H in a Superkrimp or Parkrimp 2.

1FU71

Female BSP Parallel Pipe - Swivel - (30° Flare)

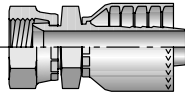

Part Number	Thread inch	Hose ID inch
1FU71-6-6	3/8x19	3/8
1FU71-8-8	1/2x14	1/2
1FU71-12-12	3/4x14	3/4
1FU71-16-16	1x11	1
1FU71-20-20	1-1/4x11	1-1/4
1FU71-24-24	1-1/2x11	1-1/2

1GU71

Female BSP Parallel Pipe - Swivel - (60° Cone)

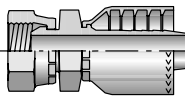

Part Number	Thread inch	Hose ID inch
1GU71-6-6	3/8 3/8x19	3/8
1GU71-8-8	1/2 1/2x14	1/2
1GU71-12-12	3/4 3/4x14	3/4
1GU71-16-16	1 1x11	1
1GU71-20-20	1-1/4 1-1/4x11	1-1/4
1GU71-24-24	1-1/2 1-1/2x11	1-1/2
1GU71-32-32	2 2x11	2

Metric S: Mates with EO "S" Series Fittings.
^^ Must be assembled with Die Part No. 83C-D20H in a Superkrimp or Parkrimp 2.

1J071

Male Seal-Lok™ - Rigid - (with O-Ring)
ISO 12151-1 - S

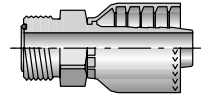

Part Number	Thread inch	Hose ID inch
1J071-8-8	1/2 13/16x16	1/2
1J071-10-8	5/8 1x14	1/2
1J071-10-10	5/8 1x14	5/8
1J071-12-10	3/4 1-3/16x12	5/8
1J071-12-12	3/4 1-3/16x12	3/4
1J071-16-12	1 1-7/16x12	3/4
1J071-16-16	1 1-7/16x12	1
1J071-20-20	1-1/4 1-11/16x12	1-1/4
1J071-24-24	1-1/2 2x12	1-1/2

1J171

Female Seal-Lok™ - Swivel - 90° Elbow - Long Drop
ISO 12151-1 - SWEL90

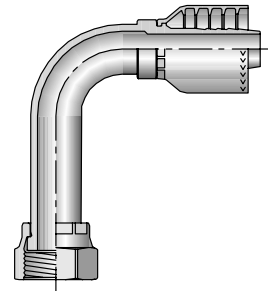

Part Number	Thread inch	Hose ID inch
1J171-6-6	3/8 11/16x16	3/8
1J171-8-8	1/2 13/16x16	1/2
1J171-10-10	5/8 1x14	5/8
1J171-12-12	3/4 1-3/16x12	3/4
1J171-16-12	1 1-7/16x12	3/4
1J171-16-16	1 1-7/16x12	1
1J171-20-20	1-1/4 1-11/16x12	1-1/4
1J171-24-24	1-1/2 2x12	1-1/2

1J571

Female Seal-Lok™ - Swivel - 90° Elbow - Medium Drop
ISO 12151-1 - SWEM90

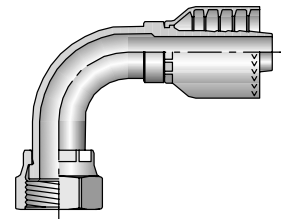

Part Number	Thread inch	Hose ID inch
1J571-8-8	1/2 13/16x16	1/2
1J571-10-10	5/8 1x14	5/8
1J571-12-12	3/4 1-3/16x12	3/4

71 Series: Use with 711, 721, 721TC, 721ST, 722TC, 722ST, 774 hoses.
Dimensions and pressures are for reference only and are subject to change.

1J771

Female Seal-Lok™ - Swivel - 45° Elbow
ISO 12151-1 - SWE45

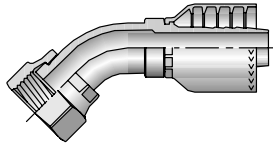

Part Number	Thread inch	Hose ID inch
1J771-6-6	3/8 11/16x16	3/8
1J771-8-8	1/2 13/16x16	1/2
1J771-10-8	5/8 1x14	1/2
1J771-10-10	5/8 1x14	5/8
1J771-12-12	3/4 1-3/16x12	3/4
1J771-16-16	1 1-7/16x12	1
1J771-20-20	1-1/4 1-11/16x12	1-1/4
1J771-24-24	1-1/2 2x12	1-1/2

1J971

Female Seal-Lok™ - Swivel - 90° Elbow - Short Drop
ISO 12151-1 - SWES90

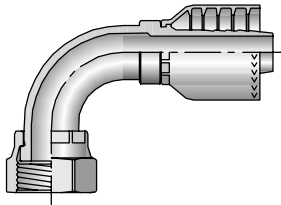

Part Number	Thread inch	Hose ID inch
1J971-6-6	3/8 11/16x16	3/8
1J971-8-8	1/2 13/16x16	1/2
1J971-10-8	5/8 1x14	1/2
1J971-10-10	5/8 1x14	5/8
1J971-10-12	5/8 1x14	3/4
1J971-12-10	3/4 1-3/16x12	5/8
1J971-12-12	3/4 1-3/16x12	3/4
1J971-16-16	1 1-7/16x12	1
1J971-20-20	1-1/4 1-11/16x12	1-1/4
1J971-24-24	1-1/2 2x12	1-1/2

1JC71

Female Seal-Lok™ - Swivel - Short
ISO 12151-1 - SWSA

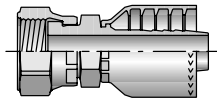

Part Number	Thread inch	Hose ID inch
1JC71-8-8	1/2 13/16x16	1/2
1JC71-10-10	5/8 1x14	5/8
1JC71-12-12	3/4 1-3/16x12	3/4
1JC71-16-16	1 1-7/16x12	1
1JC71-20-16	1-1/4 1-11/16x12	1

1JS71

Female Seal-Lok™ - Swivel - Long
ISO 12151-1 - SWSB

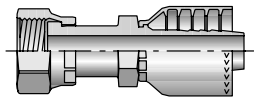

Part Number	Thread inch	Hose ID inch
1JS71-6-6	3/8 11/16x16	3/8
1JS71-6-8	3/8 11/16x16	1/2
1JS71-8-8	1/2 13/16x16	1/2
1JS71-10-8	5/8 1x14	1/2
1JS71-10-10	5/8 1x14	5/8
1JS71-10-12	5/8 1x14	3/4
1JS71-12-10	3/4 1-3/16x12	5/8
1JS71-12-12	3/4 1-3/16x12	3/4
1JS71-16-12	1 1-7/16x12	3/4
1JS71-16-16	1 1-7/16x12	1
1JS71-20-16	1-1/4 1-11/16x12	1
1JS71-20-20	1-1/4 1-11/16x12	1-1/4
1JS71-24-24	1-1/2 2x12	1-1/2

1L971

Female JIC 37° - Swivel - 90° Elbow - Medium Drop

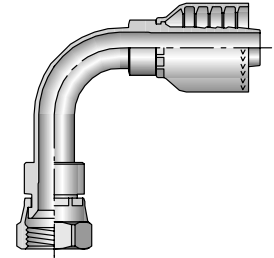

Part Number	Thread inch	Hose ID inch
1L971-10-8	5/8 7/8x14	1/2

1MU71

Female Metric - Swivel - (30° Flare)

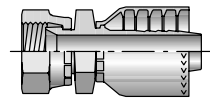

Part Number	Thread inch	Hose ID inch
1MU71-6-6	M18x1,5	3/8
1MU71-8-8	M22x1,5	1/2

Japanese Fittings - Female Swivel 30° Flare with Metric Threads. All 30° flared fitting sizes are available by combining 1MU71 fittings in sizes up to 1/2 with 1XU71 fittings in sizes 5/8 inch and larger.

1UT71

Male BSP Taper Pipe - Rigid - (60° Cone)

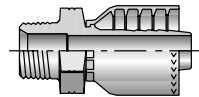

Part Number	Hose ID inch
1UT71-8-8	1/2
1UT71-12-12	3/4

71 Series: Use with 711, 721, 721TC, 721ST, 722TC, 772TC, 772ST, 774 hoses.
Dimensions and pressures are for reference only and are subject to change.

1XU71

Female Metric - Swivel - (30° Flare)

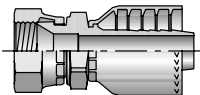

Part Number	Thread mm	Hose ID inch
1XU71-10-10	M24x1,5	5/8
1XU71-12-12	M30x1,5	3/4
1XU71-16-16	M33x1,5	1
1XU71-20-20	M36x1,5	1-1/4
1XU71-24-24	M42x1,5	1-1/2

Japanese Fittings - Female Swivel 30° Flare with Metric Threads. All 30° flared fitting sizes are available by combining 1MU71 fittings in sizes up to 1/2 with 1XU71 fittings in sizes 5/8 inch and larger.

10577

Male SAE Straight Thread with O-Ring - Rigid - Straight

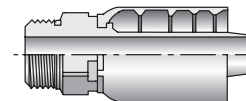

Part Number	Thread inch	Hose ID inch
10577-8-8	1/2	3/4x16
10577-12-12	3/4	1-1/16x12
10577-16-16	1	1-5/16x12
10577-20-20	1-1/4	1-5/8x12

10677

Female JIC 37° - Swivel - Straight

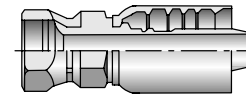

Part Number	Thread inch	Hose ID inch
10677-8-8	1/2	3/4x16
10677-10-8	5/8	7/8x14
10677-10-10	5/8	7/8x14
10677-10-12	5/8	7/8x14
10677-12-8	3/4	1-1/16x12
10677-12-10	3/4	1-1/16x12
10677-12-12	3/4	1-1/16x12
10677-12-16	3/4	1-1/16x12
10677-14-12	7/8	1-3/16x12
10677-16-12	1	1-5/16x12
10677-16-16	1	1-5/16x12
10677-20-16	1-1/4	1-5/8x12
10677-20-20	1-1/4	1-5/8x12
10677-24-20	1-1/2	1-7/8x12
10677-24-24	1-1/2	1-7/8x12
10677-32-32	2	2-1/2x12

All sizes of 10677 fittings are rated at 5,000 psi working pressure.

77 Series

10177

Male NPTF Pipe - Rigid - Straight

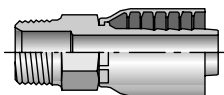

Part Number	Thread inch	Hose ID inch
10177-8-8	1/2x14	1/2
10177-8-12	1/2x14	3/4
10177-12-12	3/4x14	3/4
10177-16-16	1x11-1/2	1
10177-20-20	1-1/4x11-1/2	1-1/4
10177-24-24	1-1/2x11-1/2	1-1/2
10177-32-32	2x11-1/2	2

All sizes of 10177 fittings are rated at 5,000 psi working pressure.

⚠ Refer to [Section O](#) for Pressure Rating of Hose End Connections chart.

10377

Male JIC 37° - Rigid - Straight

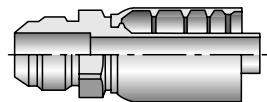

Part Number	Thread inch	Hose ID inch
10377-8-8	1/2	3/4x16
10377-10-8	5/8	7/8x14
10377-10-10	5/8	7/8x14
10377-12-10	3/4	1-1/16x12
10377-12-12	3/4	1-1/16x12
10377-16-12	1	1-5/16x12
10377-16-16	1	1-5/16x12
10377-20-16	1-1/4	1-5/8x12
10377-20-20	1-1/4	1-5/8x12
10377-32-32	2	2-1/2x12

All sizes of 10377 are rated at 5,000 psi working pressure.

⚠ Refer to [Section O](#) for Pressure Rating of Hose End Connections chart.

10C77

Female Metric S - Swivel - 45° Elbow - (24° Cone with O-Ring) ISO 12151-2-SWE-45

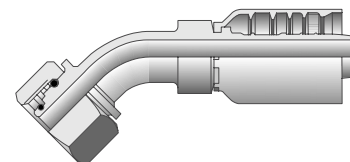

Part Number	Thread mm	Hose ID inch
10C77-16-8	16 M24x1,5	1/2
10C77-20-10	20 M30x2	5/8
10C77-20-12	20 M30x2	3/4
10C77-25-12	25 M36x2	3/4
10C77-30-16	30 M42x2	1
10C77-38-20	38 M52x2	1-1/4
10C77-38-24	38 M52x2	1-1/2

71 Series: Use with [711](#), [721](#), [721TC](#), [721ST](#), [722TC](#), [722TC](#), [722ST](#), [774](#) hoses.
Dimensions and pressures are for reference only and are subject to change.

11577

SAE Code 61 Flange Head
ISO 12151-3-S-L

Part Number	Flange inch	Hose ID inch
11577-8-8	1/2	1/2
11577-10-10	5/8	5/8
11577-12-8	3/4	1/2
11577-12-10	3/4	5/8
11577-12-12	3/4	3/4
11577-16-12	1	3/4
11577-16-16	1	1
11577-32-32	2	2

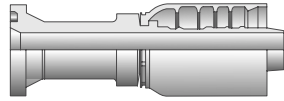

11977

SAE Code 61 Flange Head - 90° Elbow
ISO 12151-3-E90M-L

Part Number	Flange inch	Hose ID inch
11977-8-8	1/2	1/2
11977-12-8	3/4	1/2
11977-12-12	3/4	3/4
11977-16-10	1	5/8
11977-16-12	1	3/4
11977-16-16	1	1
11977-20-20	1-1/4	1-1/4
11977-24-24	1-1/2	1-1/2
11977-32-32	2	2

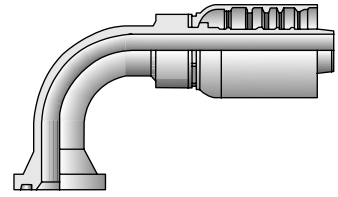

11677

SAE Code 61 Flange Head - 22-1/2° Elbow
ISO 12151-3-E22M-L

Part Number	Flange inch	Hose ID inch
11677-16-16	1	1
11677-20-20	1-1/4	1-1/4
11677-24-24	1-1/2	1-1/2
11677-32-32	2	2

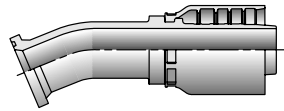

11C77

Female Metric S - Swivel - 90° Elbow - (24° Cone with O-Ring)
ISO 12151-2-SWE

Part Number	Thread mm	Hose ID inch
11C77-16-8	M24x1,5	1/2
11C77-20-10	M30x2	5/8
11C77-20-12	M30x2	3/4
11C77-25-12	M36x2	3/4
11C77-25-16	M36x2	1
11C77-30-16	M42x2	1
11C77-38-20	M52x2	1-1/4
11C77-38-24	M52x2	1-1/2

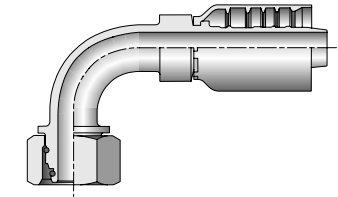

11777

SAE Code 61 Flange Head - 45° Elbow
ISO 12151-3-E45M-L

Part Number	Flange inch	Hose ID inch
11777-8-8	1/2	1/2
11777-12-12	3/4	3/4
11777-16-12	1	3/4
11777-16-16	1	1
11777-32-32	2	2

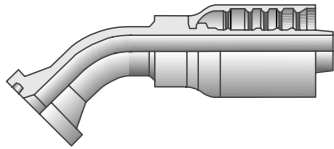

12677

SAE Code 61 Flange Head - 30° Elbow
ISO 12151-3-E30M-L

Part Number	Flange inch	Hose ID inch
12677-16-16	1	1
12677-20-20	1-1/4	1-1/4
12677-32-32	2	2

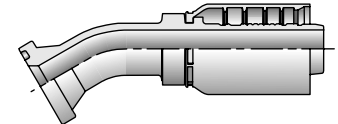

11877

SAE Code 61 Flange Head - 67-1/2° Elbow
ISO 12151-3-E67M-L

Part Number	Flange inch	Hose ID inch
11877-16-16	1	1
11877-32-32	2	2

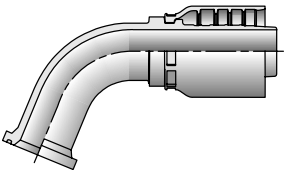

12777

SAE Code 61 Flange Head - 60° Elbow
ISO 12151-3-E60M-L

Part Number	Flange inch	Hose ID inch
12777-12-12	3/4	3/4
12777-16-12	1	3/4
12777-16-16	1	1
12777-32-32	2	2

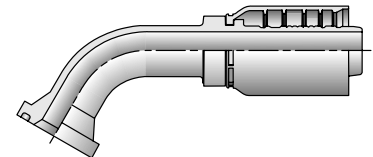

77 Series: Use with [787TC](#), [797TC](#) hoses.

Dimensions and pressures are for reference only and are subject to change.

13777

Female JIC 37° - Swivel - 45° Elbow - Short Drop

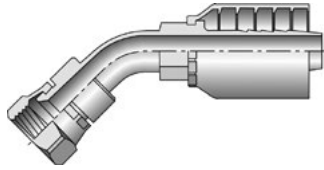

Part Number	Thread inch	Hose ID inch
13777-8-8	1/2 3/4x16	1/2
13777-10-8	5/8 7/8x14	1/2
13777-10-10	5/8 7/8x14	5/8
13777-12-12	3/4 1-1/16x12	3/4
13777-16-12	1 1-5/16x12	3/4
13777-16-16	1 1-5/16x12	1
13777-20-20	1-1/4 1-5/8x12	1-1/4

All sizes of 13777 fittings are rated at 5,000 psi working pressure.

13977

Female JIC 37° - Swivel - 90° Elbow - Short Drop

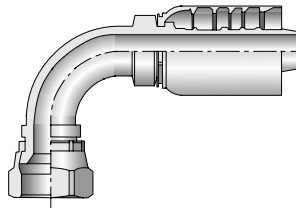

Part Number	Thread inch	Hose ID inch
13977-8-8	1/2 3/4x16	1/2
13977-10-8	5/8 7/8x14	1/2
13977-10-10	5/8 7/8x14	5/8
13977-12-10	3/4 1-1/16x12	5/8
13977-12-12	3/4 1-1/16x12	3/4
13977-16-12	1 1-5/16x12	3/4
13977-16-16	1 1-5/16x12	1
13977-20-20	1-1/4 1-5/8x12	1-1/4
13977-24-24	1-1/2 1-7/8x12	1-1/2
13977-32-32	2 2-1/2x12	2

All sizes of 13977 fittings are rated at 5,000 psi working pressure.

14177

Female JIC 37° - Swivel - 90° Elbow - Long Drop
ISO 12151-5

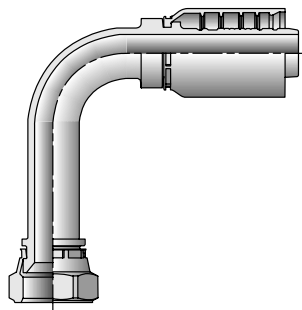

Part Number	Thread inch	Hose ID inch
14177-8-8	1/2 3/4x16	1/2
14177-12-12	3/4 1-1/16x12	3/4
14177-16-16	1 1-5/16x12	1

All sizes of 14177 fittings are rated at 5,000 psi working pressure.

14A77

SAE Code 61 Flange Head - Straight
ISO 12151-3-S-L

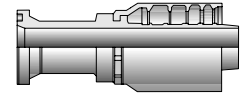

Part Number	Flange inch	Hose ID inch
14A77-20-16	1-1/4	1
14A77-20-20	1-1/4	1-1/4
14A77-24-20	1-1/2	1-1/4
14A77-24-24	1-1/2	1-1/2
14A77-32-24	2	1-1/2
14A77-32-32	2	2

14B77

SAE Code 61 Flange Head - 22-1/2° Elbow
ISO 12151-3-E22M-L (5000 psi)

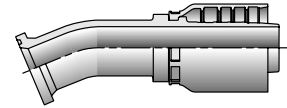

Part Number	Flange inch	Hose ID inch
14B77-20-20	1-1/4	1-1/4
14B77-24-24	1-1/2	1-1/2
14B77-32-32	2	2

14F77

SAE Code 61 5000 psi Flange Head - 45°
ISO 12151-3-E45M-L

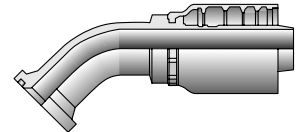

Part Number	Flange inch	Hose ID inch
14F77-20-16	1-1/4	1
14F77-20-20	1-1/4	1-1/4
14F77-24-20	1-1/2	1-1/4
14F77-24-24	1-1/2	1-1/2
14F77-32-24	2	1-1/2
14F77-32-32	2	2

14G77

SAE Code 61 Flange Head - 60° Elbow
ISO 12151-3-E60M-L

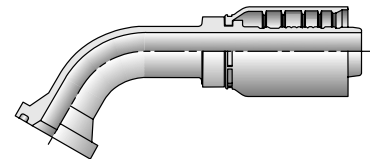

Part Number	Flange inch	Hose ID inch
14G77-20-16	1-1/4	1
14G77-32-32	2	2

77 Series: Use with [787TC](#), [797TC](#) hoses.

Dimensions and pressures are for reference only and are subject to change.



14N77

SAE Code 61 Flange Head - 90°
ISO 12151-3-E90M-L

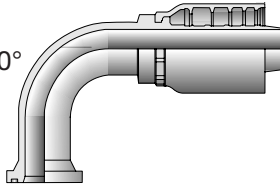

Part Number	Flange inch	Hose ID inch
14N77-20-16	1-1/4	1
14N77-20-20	1-1/4	1-1/4
14N77-24-20	1-1/2	1-1/4
14N77-24-24	1-1/2	1-1/2
14N77-32-24	2	1-1/2
14N77-32-32	2	2

16A77

SAE Code 62 Flange Head - Straight
ISO 12151-3-S-S

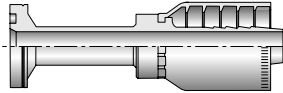

Part Number	Flange inch	Hose ID inch
16A77-8-8	1/2	1/2
16A77-12-10	3/4	5/8
16A77-12-12	3/4	3/4
16A77-12-16	3/4	1
16A77-16-12	1	3/4
16A77-16-16	1	1
16A77-16-20	1	1-1/4
16A77-20-16	1-1/4	1
16A77-20-20	1-1/4	1-1/4
16A77-20-24	1-1/4	1-1/2
16A77-24-16	1-1/2	1
16A77-24-20	1-1/2	1-1/4
16A77-24-24	1-1/2	1-1/2
16A77-32-24	2	1-1/2
16A77-32-32	2	2

16B77

SAE Code 62 Flange Head - 22-1/2° Elbow
ISO 12151-3-E22M-S

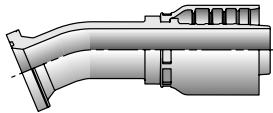

Part Number	Flange inch	Hose ID inch
16B77-12-12	3/4	3/4
16B77-16-12	1	3/4
16B77-16-16	1	1
16B77-20-20	1-1/4	1-1/4
16B77-24-24	1-1/2	1-1/2
16B77-32-32	2	2

16E77

SAE Code 62 Flange Head - 30° Elbow
ISO 12151-3-E30M-S

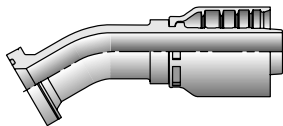

Part Number	Flange inch	Hose ID inch
16E77-12-12	3/4	3/4
16E77-16-16	1	1
16E77-20-20	1-1/4	1-1/4
16E77-24-24	1-1/2	1-1/2
16E77-32-32	2	2

16F77

SAE Code 62 Flange Head - 45° Elbow
ISO 12151-3-E45M-S

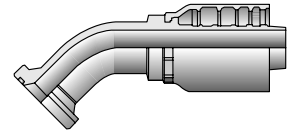

Part Number	Flange inch	Hose ID inch
16F77-8-8	1/2	1/2
16F77-12-10	3/4	5/8
16F77-12-12	3/4	3/4
16F77-12-16	3/4	1
16F77-16-12	1	3/4
16F77-16-16	1	1
16F77-16-20	1	1-1/4
16F77-20-16	1-1/4	1
16F77-20-20	1-1/4	1-1/4
16F77-20-24	1-1/4	1-1/2
16F77-24-20	1-1/2	1-1/4
16F77-24-24	1-1/2	1-1/2
16F77-32-32	2	2

16G77

SAE Code 62 Flange Head - 60° Elbow
ISO 12151-3-E60M-S

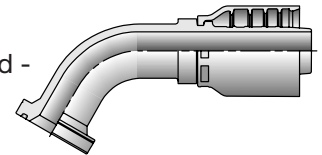

Part Number	Flange inch	Hose ID inch
16G77-12-12	3/4	3/4
16G77-16-16	1	1
16G77-20-20	1-1/4	1-1/4
16G77-24-24	1-1/2	1-1/2
16G77-32-32	2	2

16N77

SAE Code 62 Flange Head - 90° Elbow
ISO 12151-3 - E90M - S

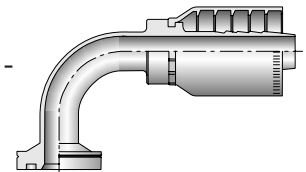

Part Number	Flange inch	Hose ID inch
16N77-8-8	1/2	1/2
16N77-8-10	1/2	5/8
16N77-12-10	3/4	5/8
16N77-12-12	3/4	3/4
16N77-12-16	3/4	1
16N77-16-12	1	3/4
16N77-16-16	1	1
16N77-16-20	1	1-1/4
16N77-20-16	1-1/4	1
16N77-20-20	1-1/4	1-1/4
16N77-20-24	1-1/4	1-1/2
16N77-24-20	1-1/2	1-1/4
16N77-24-24	1-1/2	1-1/2
16N77-32-24	2	1-1/2
16N77-32-32	2	2

77 Series: Use with 787TC, 797TC hoses.

Dimensions and pressures are for reference only and are subject to change.

1AP77

Male API Pipe - Rigid - Straight

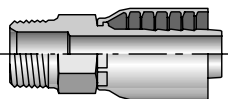

Part Number	Thread inch	Hose ID inch
1AP77-24-24	1-1/2x11-1/2	1-1/2
1AP77-32-32	2x11-1/2	2

1C977

Female Metric S - Swivel - Straight (24° Cone with O-Ring)
ISO 12151-2-SWS

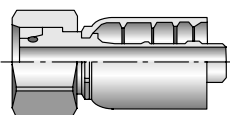

Part Number	Thread mm	Hose ID inch
1C977-16-8	16 M24x1,5	1/2
1C977-16-10	16 M24x1,5	5/8
1C977-20-10	20 M30x2	5/8
1C977-20-12	20 M30x2	3/4
1C977-25-12	25 M36x2	3/4
1C977-25-16	25 M36x2	1
1C977-30-12	30 M42x2	3/4
1C977-30-16	30 M42x2	1
1C977-30-20	30 M42x2	1-1/4
1C977-38-20	38 M52x2	1-1/4
1C977-38-24	38 M52x2	1-1/2

1D277

Male Metric S - Rigid - (24° Cone)
End Connection per ISO 8434-1-BHS

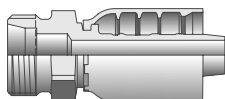

Part Number	Thread mm	Hose ID inch
1D277-16-8	M24x1,5	1/2
1D277-20-10	M30x2	5/8
1D277-20-12	M30x2	3/4
1D277-25-12	M36x2	3/4
1D277-25-16	M36x2	1
1D277-30-16	M42x2	1
1D277-38-20	M52x2	1-1/4
1D277-38-24	M52x2	1-1/2

1FU77

Female BSP Parallel Pipe - Swivel - (30° Flare)
B8363 Code F

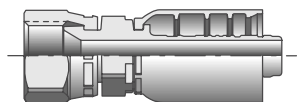

Part Number	Thread mm	Hose ID inch
1FU77-8-8	1/2x14	1/2
1FU77-12-12	3/4x14	3/4
1FU77-16-16	1x11	1
1FU77-20-20	1-1/4x11	1-1/4

1GU77

Female BSP Parallel Pipe - Swivel - Straight (60° Cone)

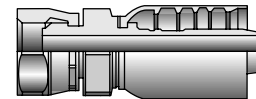

Part Number	Thread inch	Hose ID inch
1GU77-8-8	1/2x14	1/2
1GU77-12-12	3/4x14	3/4
1GU77-16-16	1x11	1
1GU77-20-20	1-1/4x11	1-1/4

1J077

Male Seal-Lok™ - Rigid - Straight - (with O-Ring)
ISO 12151-1-S

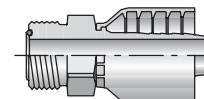

Part Number	Thread inch	Hose ID inch
1J077-8-8	13/16x16	1/2
1J077-10-8	1x14	1/2
1J077-10-10	1x14	5/8
1J077-12-10	1-3/16x12	5/8
1J077-12-12	1-3/16x12	3/4
1J077-16-12	1-7/16x12	3/4
1J077-16-16	1-7/16x12	1
1J077-20-16	1-11/16x12	1
1J077-20-20	1-11/16x12	1-1/4
1J077-24-20	2x12	1-1/4

⚠ Refer to [Section O](#) for Pressure Rating of Hose End Connections chart.

1J177

Female Seal-Lok™ - Swivel - 90° Elbow - Long Drop
ISO 12151-1-SWEL90

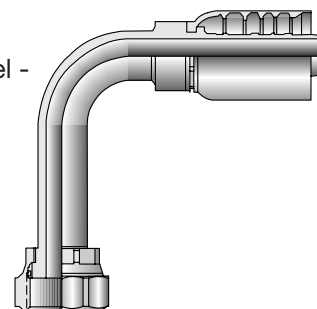

Part Number	Thread inch	Hose ID inch
1J177-8-8	13/16x16	1/2
1J177-10-10	1x14	5/8
1J177-12-10	1-3/16x12	5/8
1J177-12-12	1-3/16x12	3/4
1J177-16-12	1-7/16x12	3/4
1J177-16-16	1-7/16x12	1
1J177-20-16	1-11/16x12	1
1J177-20-20	1-11/16x12	1-1/4

⚠ Refer to [Section O](#) for Pressure Rating of Hose End Connections chart.

77 Series: Use with [787TC](#), [797TC](#) hoses.

Dimensions and pressures are for reference only and are subject to change.

1J577

Female Seal-Lok™ - Swivel - 90° Elbow - Medium Drop
ISO 12151-1 - SWEM90

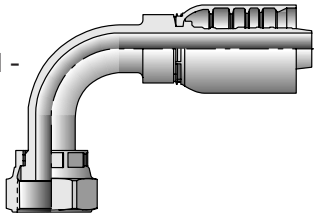

Part Number	Thread inch	Hose ID inch
1J577-8-8	1/2 13/16x16	1/2
1J577-10-10	5/8 1x14	5/8
1J577-12-12	3/4 1-3/16x12	3/4
1J577-16-12	1 1-7/16x12	3/4
1J577-16-16	1 1-7/16x12	1
1J577-20-20	1-1/4 1-11/16x12	1-1/4

⚠ Refer to [Section O](#) for Pressure Rating of Hose End Connections chart.

1J777

Female Seal-Lok™ - Swivel - 45° Elbow
ISO 12151-1-SWE45

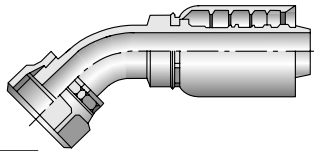

Part Number	Thread inch	Hose ID inch
1J777-8-8	1/2 13/16x16	1/2
1J777-10-8	5/8 1x14	1/2
1J777-10-10	5/8 1x14	5/8
1J777-12-12	3/4 1-3/16x12	3/4
1J777-16-16	1 1-7/16x12	1
1J777-20-20	1-1/4 1-11/16x12	1-1/4
1J777-24-20	1-1/2 2x12	1-1/4
1J777-24-24	1-1/2 2x12	1-1/2

⚠ Refer to [Section O](#) for Pressure Rating of Hose End Connections chart.

1J977

Female Seal-Lok™ - Swivel - 90° Elbow - Short Drop
ISO 12151-1-SWES90

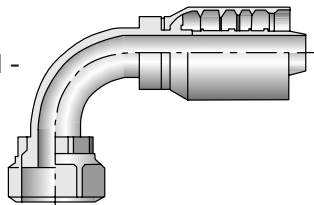

Part Number	Thread inch	Hose ID inch
1J977-8-8	1/2 13/16x16	1/2
1J977-10-8	5/8 1x14	1/2
1J977-10-10	5/8 1x14	5/8
1J977-12-8	3/4 1-3/16x12	1/2
1J977-12-10	3/4 1-3/16x12	5/8
1J977-12-12	3/4 1-3/16x12	3/4
1J977-16-12	1 1-7/16x12	3/4
1J977-16-16	1 1-7/16x12	1
1J977-16-20	1 1-7/16x12	1-1/4
1J977-20-16	1-1/4 1-11/16x12	1
1J977-20-20	1-1/4 1-11/16x12	1-1/4
1J977-24-24	1-1/2 2x12	1-1/2

⚠ Refer to [Section O](#) for Pressure Rating of Hose End Connections chart.

1JC77

Female Seal-Lok™ - Swivel - Straight - Short
ISO 12151-1-SWSA

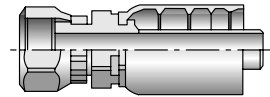

Part Number	Thread inch	Hose ID inch
1JC77-8-8	1/2 13/16x16	1/2
1JC77-10-10	5/8 1x14	5/8
1JC77-12-12	3/4 1-3/16x12	3/4
1JC77-16-12	1 1-7/16x12	3/4
1JC77-16-16	1 1-7/16x12	1
1JC77-20-16	1-1/4 1-11/16x12	1
1JC77-32-32	2 2-1/2x12	2

1JS77

Female Seal-Lok™ - Swivel - Straight - Long
ISO 12151-1-SWSB

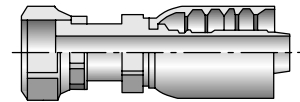

Part Number	Thread inch	Hose ID inch
1JS77-6-8	3/8 11/16x16	1/2
1JS77-8-8	1/2 13/16x16	1/2
1JS77-10-8	5/8 1x14	1/2
1JS77-10-10	5/8 1x14	5/8
1JS77-12-8	3/4 1-3/16x12	1/2
1JS77-12-10	3/4 1-3/16x12	5/8
1JS77-12-12	3/4 1-3/16x12	3/4
1JS77-12-16	3/4 1-3/16x12	1
1JS77-16-12	1 1-7/16x12	3/4
1JS77-16-16	1 1-7/16x12	1
1JS77-16-20	1 1-7/16x12	1-1/4
1JS77-20-16	1-1/4 1-11/16x12	1
1JS77-20-20	1-1/4 1-11/16x12	1-1/4
1JS77-24-24	1-1/2 2x12	1-1/2
1JS77-32-32	2 2-1/2x12	2

⚠ Refer to [Section O](#) for Pressure Rating of Hose End Connections chart.

-32 size rated to 3,000 psi.

1K577

Komatsu® Flange Head - Straight

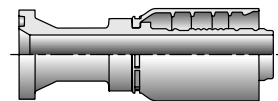

Part Number	Flange inch	Hose ID inch
1K577-16-16	1	1

1K777

Komatsu® Flange Head - 45° Elbow

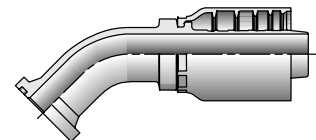

Part Number	Flange inch	Hose ID inch
1K777-12-12	3/4	3/4
1K777-16-16	1	1
1K777-20-20	1-1/4	1-1/4

77 Series: Use with 787TC, 797TC hoses.

Dimensions and pressures are for reference only and are subject to change.

1K977

Komatsu® Flange Head - 90° Elbow

Part Number	Flange inch	Hose ID inch
1K977-12-12	3/4	3/4
1K977-16-16	1	1
1K977-20-20	1-1/4	1-1/4

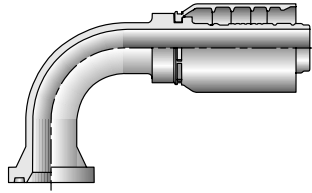

1X577

Full Flange - Straight - Code 61/62

Part Number	Flange inch	Hose ID inch
1X577-8-8	1/2	1/2
1X577-12-12	3/4	3/4
1X577-16-12	1	3/4
1X577-16-16	1	1
1X577-16-20	1	1-1/4
1X577-20-16	1-1/4	1
1X577-20-20	1-1/4	1-1/4
1X577-24-20	1-1/2	1-1/4
1X577-24-24	1-1/2	1-1/2

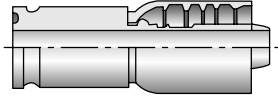

1X777

Full Flange - 45° Elbow - Code 61/62

Part Number	Flange inch	Hose ID inch
1X777-12-12	3/4	3/4
1X777-16-12	1	3/4
1X777-16-16	1	1
1X777-16-20	1	1-1/4
1X777-20-16	1-1/4	1
1X777-20-20	1-1/4	1-1/4
1X777-24-20	1-1/2	1-1/4
1X777-24-24	1-1/2	1-1/2

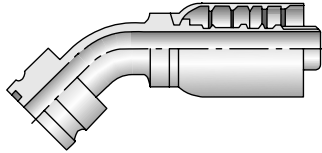

1X977

Full Flange - 90° Elbow - Code 61/62

Part Number	Flange inch	Hose ID inch
1X977-8-8	1/2	1/2
1X977-12-12	3/4	3/4
1X977-12-16	3/4	1
1X977-16-12	1	3/4
1X977-16-16	1	1
1X977-16-20	1	1-1/4
1X977-20-16	1-1/4	1
1X977-20-20	1-1/4	1-1/4
1X977-24-20	1-1/2	1-1/4
1X977-24-24	1-1/2	1-1/2

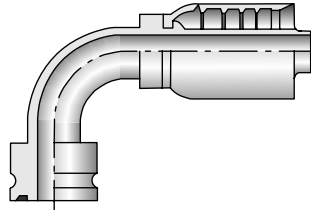

1XA77

Caterpillar® Flange Head - Straight

Part Number	Flange inch	Hose ID inch
1XA77-12-12	3/4	3/4
1XA77-12-16	3/4	1
1XA77-16-12	1	3/4
1XA77-16-16	1	1
1XA77-20-16	1-1/4	1
1XA77-20-20	1-1/4	1-1/4
1XA77-20-24	1-1/4	1-1/2
1XA77-24-20	1-1/2	1-1/4
1XA77-24-24	1-1/2	1-1/2
1XA77-32-24	2	1-1/2
1XA77-32-32	2	2

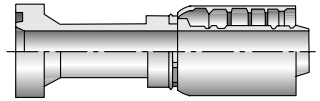

1XB77

Caterpillar® Flange Head - 22-1/2° Elbow

Part Number	Flange inch	Hose ID inch
1XB77-12-12	3/4	3/4
1XB77-16-12	1	3/4
1XB77-16-16	1	1
1XB77-20-16	1-1/4	1
1XB77-20-20	1-1/4	1-1/4
1XB77-24-20	1-1/2	1-1/4
1XB77-24-24	1-1/2	1-1/2

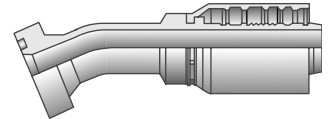

1XE77

Caterpillar® Flange Head - 30° Elbow

Part Number	Flange inch	Hose ID inch
1XE77-12-12	3/4	3/4
1XE77-16-12	1	3/4
1XE77-16-16	1	1
1XE77-20-16	1-1/4	1
1XE77-20-20	1-1/4	1-1/4
1XE77-24-20	1-1/2	1-1/4
1XE77-24-24	1-1/2	1-1/2

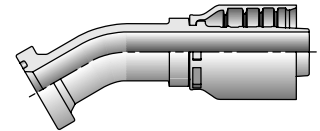

1XF77

Caterpillar® Flange Head - 45° Elbow

Part Number	Flange inch	Hose ID inch
1XF77-12-12	3/4	3/4
1XF77-16-12	1	3/4
1XF77-16-16	1	1
1XF77-20-16	1-1/4	1
1XF77-20-20	1-1/4	1-1/4
1XF77-24-20	1-1/2	1-1/4
1XF77-24-24	1-1/2	1-1/2

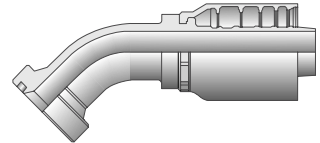

77 Series: Use with [787TC](#), [797TC](#) hoses.

Dimensions and pressures are for reference only and are subject to change.

1XG77

Caterpillar® Flange Head - 60° Elbow

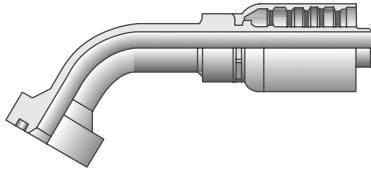

Part Number	Flange inch	Hose ID inch
1XG77-12-12	3/4	3/4
1XG77-16-12	1	3/4
1XG77-16-16	1	1
1XG77-20-16	1-1/4	1
1XG77-20-20	1-1/4	1-1/4
1XG77-24-20	1-1/2	1-1/4
1XG77-24-24	1-1/2	1-1/2

1XM77

Caterpillar® Flange - 67-1/2° Elbow

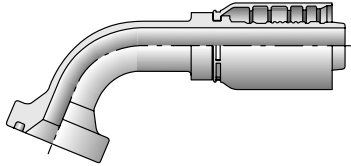

Part Number	Flange inch	Hose ID inch
1XM77-12-12	3/4	3/4
1XM77-16-12	1	3/4
1XM77-16-16	1	1
1XM77-20-16	1-1/4	1
1XM77-20-20	1-1/4	1-1/4
1XM77-24-20	1-1/2	1-1/4

1XN77

Caterpillar® Flange Head - 90° Elbow

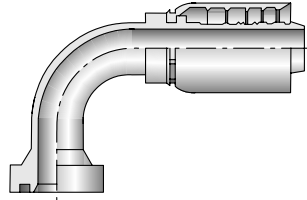

Part Number	Flange inch	Hose ID inch
1XN77-12-12	3/4	3/4
1XN77-16-12	1	3/4
1XN77-16-16	1	1
1XN77-20-16	1-1/4	1
1XN77-20-20	1-1/4	1-1/4
1XN77-20-24	1-1/4	1-1/2
1XN77-24-20	1-1/2	1-1/4
1XN77-24-24	1-1/2	1-1/2
1XN77-32-24	2	1-1/2

1ZM77

Male 24° Cone Metric - Rigid - Straight

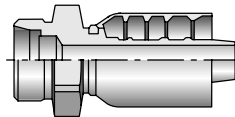

Part Number	Thread mm	Hose ID inch
1ZM77-22-10	M30x1,5	5/8
1ZM77-22-12	M30x1,5	3/4
1ZM77-28-12	M36x1,5	3/4
1ZM77-28-16	M36x1,5	1
1ZM77-35-16	M45x1,5	1

79 Series

16A79

SAE Code 62 Flange Head
ISO 12151-3 - S - S

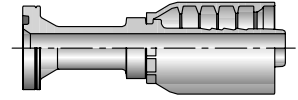

Part Number	Flange inch	Hose ID inch
16A79-12-12	3/4	3/4
16A79-16-12	1	3/4
16A79-16-16	1	1
16A79-20-16	1-1/4	1
16A79-20-20	1-1/4	1-1/4
16A79-24-24	1-1/2	1-1/2

16F79

SAE Code 62 Flange Head - 45° Elbow
ISO 12151-3 - E45S - S
(1 Piece: ISO 12151-3 - E45M - S)

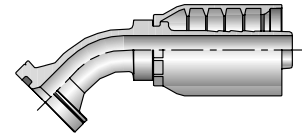

Part Number	Flange inch	Hose ID inch
16F79-12-12	3/4	3/4
16F79-16-16	1	1
16F79-16-20	1	1-1/4
16F79-20-16	1-1/4	1
16F79-20-20	1-1/4	1-1/4
16F79-24-24	1-1/2	1-1/2

16G79

SAE Code 62 Flange Head - 60° Elbow
ISO 12151-3 - E60S - S
(1 Piece: ISO 12151-3 - E60M - S)

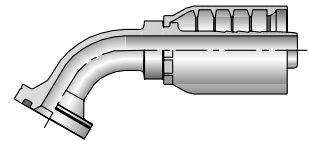

Part Number	Flange inch	Hose ID inch
16G79-16-16	1	1

16N79

SAE Code 62 Flange Head - 90° Elbow
ISO 12151-3 - E90S - S
(1 Piece: ISO 12151-3 - E90M - S)

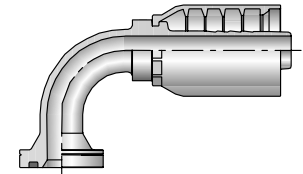

Part Number	Flange inch	Hose ID inch
16N79-12-12	3/4	3/4
16N79-16-12	1	3/4
16N79-16-16	1	1
16N79-20-16	1-1/4	1
16N79-20-20	1-1/4	1-1/4
16N79-24-24	1-1/2	1-1/2

77 Series: Use with 787TC, 797TC hoses.

79 Series: Use with 791TC, 792TC, 792ST, F42 hoses.

Dimensions and pressures are for reference only and are subject to change.

1J779

Female Seal-Lok™ - Swivel - 45° Elbow
ISO 12151-1 - SWE45

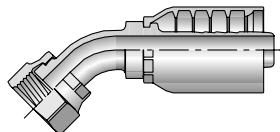

Part Number	Flange inch	Thread inch	Hose ID inch
1J779-12-12	3/4	1-3/16x12	3/4
1J779-16-16	1	1-7/16x12	1
1J779-20-20	1-1/4	1-11/16x12	1-1/4

⚠ Refer to [Section O](#) for Pressure Rating of Hose End Connections chart.

1J979

Female Seal-Lok™ - Swivel - 90° Elbow - Short Drop
ISO - 12151-1 - SWES90

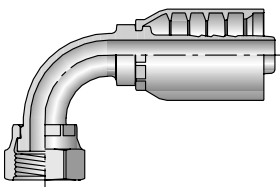

Part Number	Flange inch	Thread inch	Hose ID inch
1J979-12-12	3/4	1-3/16x12	3/4
1J979-16-16	1	1-7/16x12	1
1J979-20-20	1-1/4	1-11/16x12	1-1/4

⚠ Refer to [Section O](#) for Pressure Rating of Hose End Connections chart.

1JS79

Female Seal-Lok™ - Swivel - Long
ISO 12151-1 - SWSB

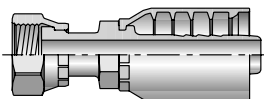

Part Number	Flange inch	Thread inch	Hose ID inch
1JS79-12-12	3/4	1-3/16x12	3/4
1JS79-16-12	1	1-7/16x12	3/4
1JS79-16-16	1	1-7/16x12	1
1JS79-20-16	1-1/4	1-11/16x12	1
1JS79-20-20	1-1/4	1-11/16x12	1-1/4
1JS79-24-24	1-1/2	2x12	1-1/2

⚠ Refer to [Section O](#) for Pressure Rating of Hose End Connections chart.

1XA79

Caterpillar® Flange Head

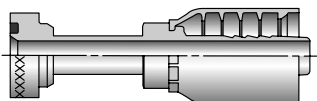

Part Number	Flange inch	Hose ID inch
1XA79-12-12	3/4	3/4
1XA79-16-16	1	1
1XA79-20-16	1-1/4	1
1XA79-20-20	1-1/4	1-1/4
1XA79-24-24	1-1/2	1-1/2

1XF79

Caterpillar® Flange Head - 45° Elbow

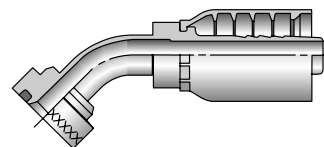

Part Number	Flange inch	Hose ID inch
1XF79-12-12	3/4	3/4
1XF79-16-16	1	1
1XF79-20-16	1-1/4	1
1XF79-20-20	1-1/4	1-1/4

1XN79

Caterpillar® Flange Head - 90° Elbow

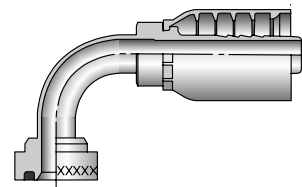

Part Number	Flange inch	Hose ID inch
1XN79-12-12	3/4	3/4
1XN79-16-16	1	1
1XN79-20-16	1-1/4	1
1XN79-20-20	1-1/4	1-1/4
1XN79-24-24	1-1/2	1-1/2

81 Series

10081

Crimp Shell



Part Number	Hose ID inch
10081-12	3/4
10081-16	1
10081-20	1-1/4
10081-24	1-1/2
10081-32	2

81 Series consists of a 10081 crimp shell and is completed by adding any 88 Series Fittings. See Equipment [Section N](#) for complete 81 Series Assembly and Crimping instructions.

79 Series: Use with 791TC, 792TC, 792ST, F42 hoses.

Dimensions and pressures are for reference only and are subject to change.

91N/91 Series

10191N

Male Taper Pipe Rigid

Part Number	Thread inch	Hose Size
10191N-2-4	1/8-27	-4
10191N-4-4	1/4-18	-4
10191N-4-5	1/4-18	-5
10191N-4-6	1/4-18	-6
10191N-6-6	3/8-18	-6
10191N-6-8	3/8-18	-8
10191N-8-8	1/2-14	-8
10191N-8-10	1/2-14	-10
10191N-8-12	1/2-14	-12
10191N-12-12	3/4-14	-12
10191N-16-16	1-11-1/2	-16
10191-20-20	1-1/4-11-1/2	-20

Construction: Brass nipple, steel shell.
 Add "B" for Brass nipple and shell.
 Add "C" for Stainless Steel.

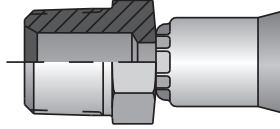

10391N

Male (JIC) 37°

Part Number	Thread inch	Hose Size
10391N-4-4	7/16-20	-4
10391N-5-5	1/2-20	-5
10391N-6-6	9/16-18	-6
10391N-8-6	3/4-16	-6
10391N-8-8	3/4-16	-8
10391N-10-10	7/8-14	-10
10391N-12-12	1-1/16-12	-12
10391N-16-16	1-5/16-1/2	-16

Construction: Brass nipple, steel shell.
 Add "B" for Brass nipple and shell.
 Add "C" for Stainless Steel.

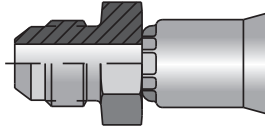

10691N

SAE (JIC) 37° Swivel

Part Number	Thread inch	Hose Size
10691N-4-4	7/16-20	-4
10691N-5-5	1/2-20	-5
10691N-6-6	9/16-18	-6
10691N-6-8	9/16-18	-8
10691N-8-8	3/4-16	-8
10691N-8-10	3/4-16	-10
10691N-10-10	7/8-14	-10
10691N-12-12	1-1/16-12	-12
10691N-16-16	1-5/16-12	-16
10691-20-20	1-5/8-12	-20

Construction: Brass nipple, steel nut and shell.
 Add "B" for Brass nipple, nut and shell.
 Add S for Steel nipple, nut and shell.
 Add "C" for Stainless Steel.

Note: Sizes -4, -5, -8 and -10 incorporate a dual seat.

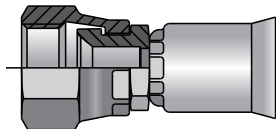

10791N

Female Pipe Swivel

Part Number	Thread inch	Hose Size
10791N-4-4	1/4-18	-4
10791N-6-6	3/8-18	-6
10791N-8-8	1/2-14	-8
10791N-12-12	3/4-14	-12
10791N-16-16	1-11-1/2	-16

Construction: Brass nipple, steel nut and shell.
 Add S for Steel nipple, nut and shell.
 Add "C" for Stainless Steel.

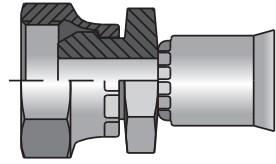

10891N

SAE 45° Swivel

Part Number	Thread inch	Hose Size
10891N-6-6	5/8-18	-6
10891N-12-12	1-1/16-14	-12

Construction: Brass nipple, steel nut and shell.
 Add S for Steel nipple, nut and shell.
 Add "C" for Stainless Steel.

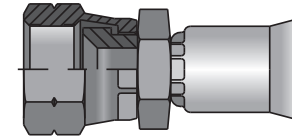

12891N

Male Inverted Swivel - Straight

Part Number	Thread inch	Hose Size
12891N-4-4	7/16-24	-4
12891N-5-5	1/2-20	-5
12891N-5-6	1/2-20	-6
12891N-6-6	5/8-18	-6
12891N-8-8	3/4-18	-8
12891N-10-10	7/8-18	-10
12891N-12-12	1-1/16-16	-12

Construction: Steel nipple, tube, nut and shell.
 Add "C" for Stainless Steel.

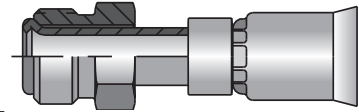

13491N

Straight Tube

Part Number	Hose Size
13491N-8-8	-8
13491N-8-10	-10
13491N-10-10	-10
13491N-12-12	-12

Construction: Brass nipple, steel shell.
 Add "B" for Brass nipple and shell.
 Add "C" for Stainless Steel.

Note: The 16T91N fitting includes 13491N with the 60HAB sleeve and 61HAB nut.

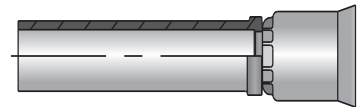

91/91N Series: Use with [919 hose](#).

Dimensions and pressures are for reference only and are subject to change.

13791N

JIC 37° Swivel
45° Elbow

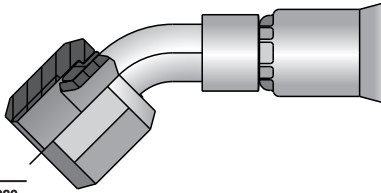

Part Number	Thread inch	Hose Size
13791N-4-4	7/16-20	-4
13791N-5-5	1/2-20	-5
13791N-6-6	9/16-18	-6
13791N-8-8	3/4-16	-8
13791N-10-10	7/8-14	-10
13791N-12-12	1-1/16-12	-12
13791N-16-16	1-5/16-12	-16
13791-20-20	1-5/8-12	-20

Construction: Steel tube, nipple, nut and shell.
Add "C" for Stainless Steel.

16791N

Male Inverted Swivel
45° Elbow

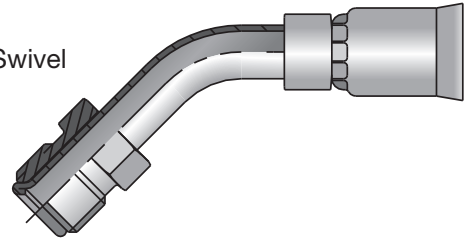

Part Number	Thread inch	Hose Size
16791N-4-4	7/16-24	-4
16791N-5-5	1/2-20	-5
16791N-6-6	5/8-18	-6
16791N-8-8	3/4-18	-8
16791N-10-10	7/8-18	-10
16791N-12-12	1-1/16-16	-12

Construction: Steel tube, nipple, nut and shell.
Add "C" for Stainless Steel.

13991N

JIC 37° Swivel 90° Elbow
Short Drop

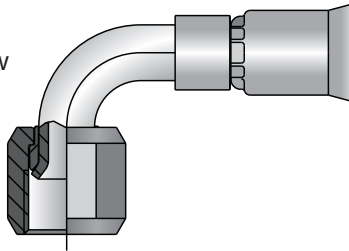

Part Number	Thread inch	Hose Size
13991N-4-4	7/16-20	-4
13991N-5-5	1/2-20	-5
13991N-6-6	9/16-18	-6
13991N-8-8	3/4-16	-8
13991N-10-10	7/8-14	-10
13991N-12-12	1-1/16-12	-12
13991N-16-16	1-5/16-12	-16
13991-20-20	1-5/8-12	-20

Construction: Steel tube, nipple, nut and shell.
Add "C" for Stainless Steel.

16991N

Male Inverted Swivel
90° Elbow

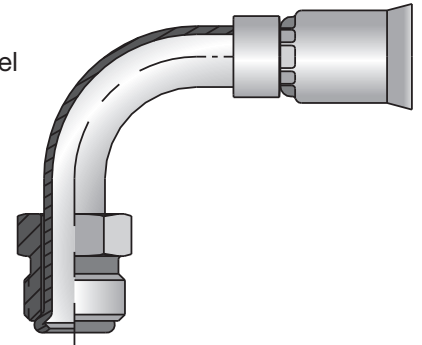

Part Number	Thread inch	Hose Size
16991N-4-4	7/16-24	-4
16991N-5-5	1/2-20	-5
16991N-5-6	1/2-20	-6
16991N-6-6	5/8-18	-6
16991N-8-8	3/4-18	-8
16991N-10-10	7/8-18	-10
16991N-12-12	1-1/16-16	-12

Construction: Steel tube, nipple, nut and shell.
Add "C" for Stainless Steel.

14191N

JIC 37° Swivel 90° Elbow
Long Drop

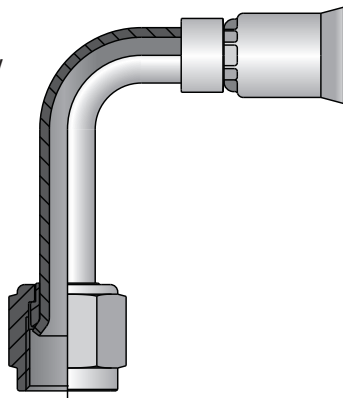

Part Number	Thread inch	Hose Size
14191N-4-4	7/16-20	-4
14191N-5-5	1/2-20	-5
14191N-6-6	9/16-18	-6
14191N-8-8	3/4-16	-8
14191N-10-10	7/8-14	-10
14191N-12-12	1-1/16-12	-12
14191N-16-16	1-5/16-12	-16
14191-20-20	1-5/8-12	-20

Construction: Steel tube, nipple, nut and shell.
Add "C" for Stainless Steel.

91/91N Series: Use with [919 hose](#).

Dimensions and pressures are for reference only and are subject to change.

17791N

SAE 45° Swivel
45° Elbow

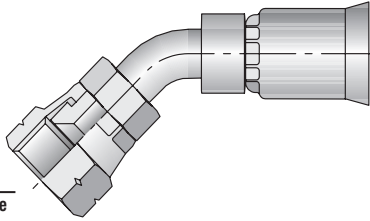

Part Number	Thread inch	Hose Size
17791N-6-6	5/8-18	3/8
17791N-12-12	1-1/16-14	3/4

Construction: Steel tube, nipple, nut and shell.
Add "C" for Stainless Steel.

17991N

SAE 45° Swivel
90° Elbow

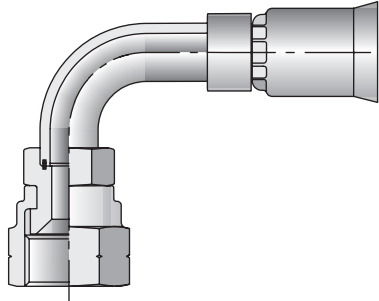

Part Number	Thread inch	Hose Size
17991N-6-6	5/8-18	3/8
17991N-12-12	1-1/16-14	3/4

Construction: Steel tube, nipple, nut and shell.
Add "C" for Stainless Steel.

19291N

Female BSP Parallel
Pipe Swivel Straight
(60° Cone)

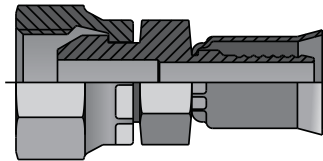

Part Number	Thread inch	Hose Size
19291N-8-8	PF-1/2-14	-8
19291N-12-12	PF-3/4-14	-12

Construction: Steel nipple, nut and shell.
Add "B" for Brass nipple, nut and shell.
Add "C" for Stainless Steel.

1B291N

Female BSP Parallel
Pipe Swivel - 90° Elbow
(60° Cone)

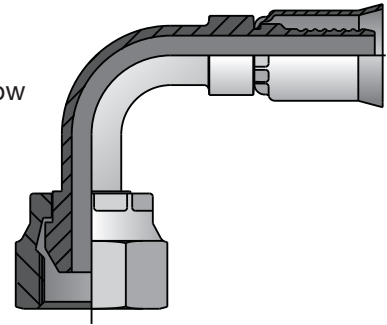

Part Number	Thread inch	Hose Size
1B291N-8-8	PF-1/2-14	-8
1B291N-12-12	PF-3/4-14	-12

Construction: Steel nipple, nut and shell.
Add "C" for Stainless Steel.

1J191N

Female Seal-Lok™
Swivel 90° Elbow
Long Drop

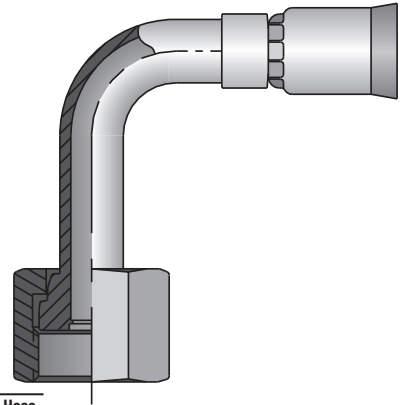

Part Number	Thread inch	Hose Size
1J191N-4-4	9/16-18	-4
1J191N-4-5	9/16-18	-5
1J191N-6-5	11/16-16	-5
1J191N-6-6	11/16-16	-6
1J191N-8-6	13/16-16	-6
1J191N-8-8	13/16-16	-8
1J191N-10-10	1-14	-10
1J191N-12-12	1-3/16-12	-12
1J191N-16-16	1-7/16-12	-16

Construction: Steel tube, nipple, nut and shell.
Add "C" for Stainless Steel.

91/91N Series: Use with [919 hose](#).

Dimensions and pressures are for reference only and are subject to change.

1J791N

Female Seal-Lok™
Swivel 45° Elbow

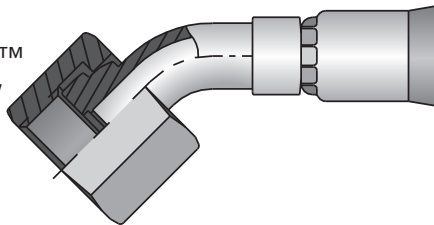

Part Number	Thread inch	Hose Size
1J791N-4-4	9/16-18	-4
1J791N-4-6	9/16-18	-6
1J791N-6-6	11/16-16	-6
1J791N-8-8	13/16-16	-8
1J791N-8-10	13/16-16	-8
1J791N-10-10	1-14	-10
1J791N-12-12	1-3/16-12	-12
1J791N-16-16	1-7/16-12	-16

Construction: Steel tube, nipple, nut and shell.
Add "C" for Stainless Steel.

1J991N

Female Seal-Lok™
Swivel 90° Elbow
Short Drop

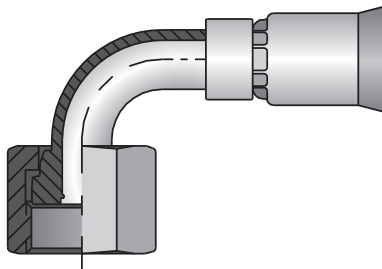

Part Number	Thread inch	Hose Size
1J991N-4-4	9/16-18	-4
1J991N-6-6	11/16-16	-6
1J991N-8-8	13/16-16	-6
1J991N-10-10	1-14	-10
1J991N-12-12	1-3/16-12	-12
1J991N-16-16	1-7/16-12	-16

Construction: Steel tube, nipple, nut and shell.
Add "C" for Stainless Steel.

1JC91N

Female Seal-Lok™ Swivel
Straight

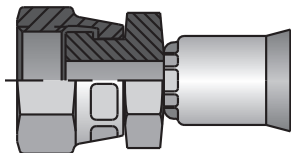

Part Number	Thread inch	Hose Size
1JC91N-4-4	9/16-18	-4
1JC91N-6-6	11/16-16	-6
1JC91N-8-8	13/16-16	-8
1JC91N-10-10	1-14	-10
1JC91N-12-10	1-3/16-12	-10
1JC91N-12-12	1-3/16-12	-12
1JC91N-16-16	1-7/16-12	-16
1JC91N-20-16	1-11/16-12	-16
1JC91-20-20	1-11/16-12	-20

Construction: Steel nipple, nut and shell.
Add "B" for Brass nipple, nut and shell.
Add "C" for Stainless Steel

1TU91N

Universal Tube Stub

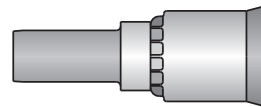

Part Number	R Dia. inch	Hose Size
1TU91-2-3C	1/8	-3
1TU91-3-3C	3/16	-3
1TU91N-4-4C	1/4	-4
1TU91N-4-5C	1/4	-5
1TU91N-6-6C	3/8	-6
1TU91N-8-8C	1/2	-8
1TU91N-8-10C	1/2	-10
1TU91N-10-10C	5/8	-10
1TU91N-12-12C	3/4	-12
1TU91N-16-16C	1	-16

Construction: Stainless Steel.

Note: Use with A-LOK and CPI nuts, sleeves and adapters. These components are manufactured by Parker's Instrumentation Connectors Division. Refer to catalogs 4230 & 4233 for additional information.

93N Series

10193N

Male Taper Pipe Rigid

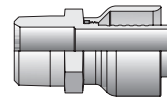

Part Number	Thread inch	Hose Size	
		inch	mm
10193N-8-8	1/2-14	1/2	13
10193N-12-12	3/4-14	3/4	19
10193N-16-16	1-11-1/2	1	25
10193N-20-20	1-1/4-11-1/2	1-1/4	32
10193N-24-24	1-1/2-11-1/2	1-1/2	38
10193N-32-32	2-11-1/2	2	51

Construction: Steel nipple, nut and shell.
Add "C" for Stainless Steel.

10693N

(JIC) 37° Female Swivel

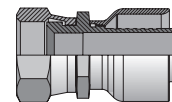

Part Number	Thread inch	Hose Size	
		inch	mm
10693N-6-6	9/16-18	3/8	10
10693N-8-8	3/4-16	1/2	13
10693N-10-10	7/8-14	5/8	16
10693N-12-12	1-1/16-12	3/4	19
10693N-16-16	1-5/16-12	1	25
10693N-20-20	1-5/8-12	1-1/4	32
10693N-24-24	1-7/8-12	1-1/2	38
10693N-32-32	2-1/2-12	2	51

Construction: Steel nipple, nut and shell.
Add "C" for Stainless Steel.

91/91N Series: Use with [919 hose](#).

93N Series: Use with [PTFE hoses](#).

Dimensions and pressures are for reference only and are subject to change.

[Link to Master Table of Contents](#)

[Link to Section Table of Contents](#)

13793N

JIC 37° Swivel 45° Elbow

Part Number	Thread inch	Hose Size
13793N-12-12	1-1/16-12	-12
13793N-16-16	1-5/16-12	-16
13793N-20-20	1-5/8-12	-20
13793N-24-24	1-7/8-12	-24

Construction: Steel nipple, nut and shell.
Add "C" for Stainless Steel.

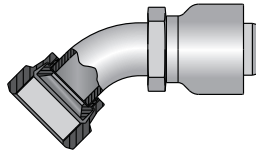

13993N

JIC 37° Swivel 90° Elbow Short Drop

Part Number	Thread inch	Hose Size
13993N-8-8	3/4-16	-8
13993N-10-10	7/8-14	-10
13993N-12-12	1-1/16-12	-12
13993N-16-16	1-5/16-12	-16
13993N-20-20	1-5/8-12	-20
13993N-24-24	1-7/8-12	-24

Construction: Steel nipple, nut and shell.
Add "C" for Stainless Steel.

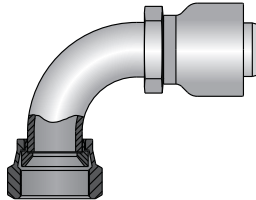

14K93N

ANSI B16.5 Flange

Part Number	Hose Size		Flange Diameter	
	inch	mm	inch	mm
14K93N-8-8	1/2	13	3-1/2	89
14K93N-12-12	3/4	19	3-7/8	98
14K93N-16-16	1	25	4-1/4	108
14K93N-20-20	1-1/4	32	4-5/8	117
14K93N-24-24	1-1/2	38	5	127
14K93N-32-32	2	51	6	152

Construction: Steel nipple and shell, stainless steel flange.
Note: Also available in PAGE Fittings.

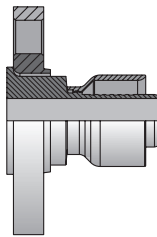

1J793N

Seal-Lok™ 45° Elbow

Part Number	Thread inch	Hose Size inch	Hose Size mm
1J793N-20-20	1-11/16-12	1-1/4	32

Construction: Steel nipple, tube, nut and shell.
Add "C" for Stainless Steel.
Note: Also available in PAGE Fittings.

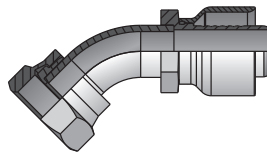

1J993N

Seal-Lok™ 90° Elbow Short Drop

Part Number	Thread Size	Hose Size inch	Hose Size mm
1J993N-20-20	1-11/16-12	1-1/4	32

Construction: Steel nipple, tube, nut and shell.
Add "C" for Stainless Steel.
Note: Also available in PAGE Fittings.

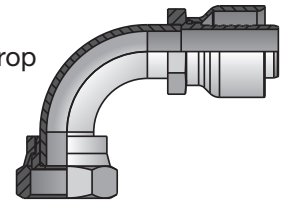

1JC93N

Seal-Lok™ Swivel Straight Short

Part Number	Thread inch	Hose Size inch	Hose Size mm
1JC93N-12-12	1-3/16-12	3/4	19
1JC93N-16-16	1-7/16-12	1	25
1JC93N-20-20	1-11/16-12	1-1/4	32

Construction: Steel nipple, nut and shell.
Add "C" for Stainless Steel.

Note: Also available in PAGE Fittings. When measuring overall length to the end of the nut, B+C dimensions must be used to calculate cut-off allowance. Stainless steel fittings must be assembled with [Karykrimp2](#) or [Parkimp2](#). See www.parker.com/crimpsource for more information.

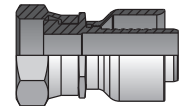

CY Series

101CY

Male Taper Pipe Rigid

Part Number	Thread inch	Hose Size inch	Hose Size mm
101CY-2-2	1/8-27	1/8	3
101CY-2-3	1/8-27	3/16	5
101CY-4-2	1/4-18	1/8	3
101CY-4-3	1/4-18	3/16	5

Construction: Steel.
Add "C" for Stainless Steel.

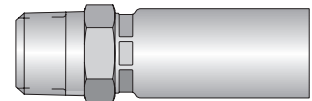

102CY

Female Pipe Thread

Part Number	Thread inch	Hose Size inch	Hose Size mm
102CY-2-3	1/8-27	3/16	5

Construction: Steel.
Add "C" for Stainless Steel.

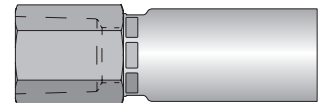

93N Series: Use with [PTFE hoses](#).
CY Series: Use with [HLB](#), [56DH](#), [568DH](#) hoses.

Dimensions and pressures are for reference only and are subject to change.

106CY

Female SAE (JIC)
37° Swivel

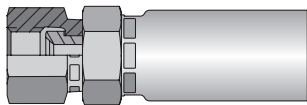

Part Number	Thread inch	Hose Size	
		inch	mm
106CY-2-2	Flare 5/16-24	1/8	3
106CY-3-2	Flare 3/8-24	1/8	3
106CY-4-2	Flare 7/16-20	1/8	3
106CY-4-3	Flare 7/16-20	3/16	5

Construction: Steel.
Add "C" for Stainless Steel.
Note: Sizes -4 incorporates a dual seat.

113CY

Male Pipe Swivel*

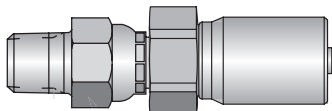

Part Number	Thread inch	Hose Size	
		inch	mm
113CY-2-2	1/8-27	1/8	3
113CY-2-3	1/8-27	3/16	3

Construction: Steel.
Add "C" for Stainless Steel.
***Note:** For use with petroleum based fluids.

⚠ WARNING: Fittings allow minor movement to relieve stress on hose but are not recommended for continued or extensive swiveling. Not recommended for use in CNG applications.

139CY

Female JIC
37° Swivel
90° Elbow
Short Drop

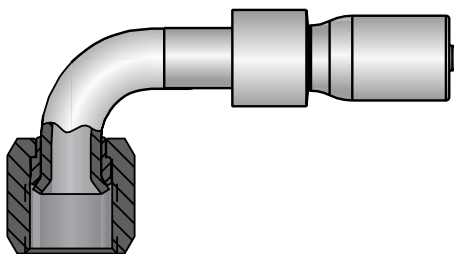

Part Number	Thread inch	Hose Size	
		inch	mm
139CY-4-2	7/16-20	1/8	3
139CY-4-3	7/16-20	3/16	5

Construction: Steel.
Add "C" for Stainless Steel.

1GKCY

Bulkhead with
Integrated Zerk Port

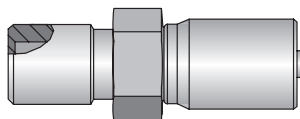

Part Number	Thread inch	Hose Size	
		inch	mm
1GKCY-2-2	1/8-27 NPSM Male w/1/4-28 UNF Female	1/8	3
1GKCY-2-3	1/8-27 NPSM Male w/1/4-28 UNF Female	3/16	5
1GKCY-2-2-L77*	1/8-27 NPSM Male w/1/4-28 UNF Female	1/8	3
1GK91N-2-4**	1/8-27 NPSM Male w/1/4-28 UNF Female	3/16	5

Construction: Steel.
Add "C" for Stainless Steel.
Note: *Long bulkhead for use with plates under 3/4" thick. Uses 2GK-NUT, sold separately.
**Use with [919 hoses](#).

1J9CY

Female O-Ring Face Seal
Swivel Short Drop

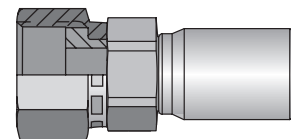

Part Number	Thread inch	Hose Size	
		inch	mm
1J9CY-4-2	9/16-18	1/8	3

Construction: Steel.
Add "C" for Stainless Steel.

1JCCY

Female Seal-Lok™
Swivel Straight
Short

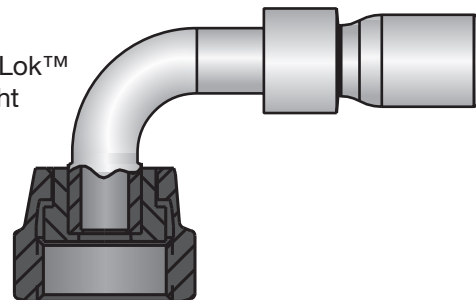

Part Number	Thread inch	Hose Size	
		inch	mm
1JCCY-4-2	9/16-18	1/8	3

Construction: Steel.
Add "C" for Stainless Steel.

1LMCY

Male Grease

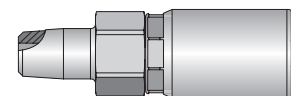

Part Number	Thread Size	Hose ID	
		inch	mm
1LMCY-2-2	1/4-28	1/8	3

Construction: Steel.
Add "C" for Stainless Steel.

CY Series: Use with [HLB](#), [56DH](#), [568DH](#) hoses.

Dimensions and pressures are for reference only and are subject to change.

HY Series

101HY

Male NPTF Pipe - Rigid

Part Number	Thread inch	Hose ID inch
101HY-2-4	1/8x27	1/4
101HY-4-4	1/4x18	1/4
101HY-4-5	1/4x18	5/16
101HY-4-6	1/4x18	3/8
101HY-6-4	3/8x18	1/4
101HY-6-5	3/8x18	5/16
101HY-6-6	3/8x18	3/8
101HY-6-8	3/8x18	1/2
101HY-8-4	1/2x14	1/4
101HY-8-6	1/2x14	3/8
101HY-8-7	1/2x14	13/32
101HY-8-8	1/2x14	1/2
101HY-8-10	1/2x14	5/8
101HY-8-12	1/2x14	3/4
101HY-12-8	3/4x14	1/2
101HY-12-10	3/4x14	5/8
101HY-12-12	3/4x14	3/4
101HY-12-16	3/4x14	1
101HY-16-12	1x11-1/2	3/4
101HY-16-14	1x11-1/2	7/8
101HY-16-16	1x11-1/2	1
101HY-20-20	1-1/4x11-1/2	1-1/4

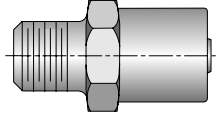

Stainless steel fittings must be assembled with [Karrykrimp 2](#), [Phastkrimp](#), [Superkrimp](#) or [Parkrimp 2](#). See www.parker.com/crimpsource for more information.

102HY

Female NPTF Pipe - Rigid

Part Number	Thread inch	Hose ID inch
102HY-2-4	1/8x27	1/4
102HY-4-4	1/4x18	1/4
102HY-4-6	1/4x18	3/8
102HY-6-4	3/8x18	1/4
102HY-6-6	3/8x18	3/8
102HY-8-6	1/2x14	3/8
102HY-8-8	1/2x14	1/2
102HY-12-12	3/4x14	3/4
102HY-16-16	1x11-1/2	1

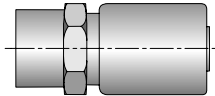

103HY

Male JIC 37° - Rigid

Part Number	Thread inch	Hose ID inch
103HY-4-4	7/16x20	1/4
103HY-5-4	1/2x20	1/4
103HY-6-4	9/16x18	1/4
103HY-6-5	9/16x18	5/16
103HY-6-6	9/16x18	3/8
103HY-6-8	9/16x18	1/2
103HY-8-6	3/4x16	3/8
103HY-8-8	3/4x16	1/2
103HY-10-6	7/8x14	3/8
103HY-10-8	7/8x14	1/2
103HY-10-10	7/8x14	5/8
103HY-10-12	7/8x14	3/4
103HY-12-8	1-1/16x12	1/2
103HY-12-10	1-1/16x12	5/8
103HY-12-12	1-1/16x12	3/4
103HY-14-12	1-3/16x12	3/4
103HY-16-12	1-5/16x12	3/4
103HY-16-16	1-5/16x12	1
103HY-20-16	1-5/8x12	1
103HY-20-20	1-5/8x12	1-1/4

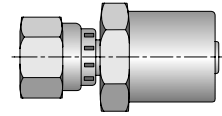

105HY

Male SAE Straight Thread with O-Ring - Rigid

Part Number	Thread inch	Hose ID inch
105HY-4-4	7/16x20	1/4
105HY-5-4	1/2x20	1/4
105HY-6-4	9/16x18	1/4
105HY-6-6	9/16x18	3/8
105HY-8-6	3/4x16	3/8
105HY-8-8	3/4x16	1/2
105HY-10-6	7/8x14	3/8
105HY-10-8	7/8x14	1/2
105HY-10-10	7/8x14	5/8
105HY-12-8	1-1/16x12	1/2
105HY-12-10	1-1/16x12	5/8
105HY-12-12	1-1/16x12	3/4
105HY-16-12	1-5/16x12	3/4
105HY-16-16	1-5/16x12	1

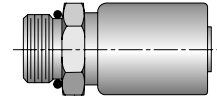

O-Ring not compatible with Phosphate Ester fluids.

HY Series: Use with [AX](#), [BXX](#), [S4](#), [S5](#), [S6](#) and [S9](#) hoses.

Dimensions and pressures are for reference only and are subject to change.

106HY

Female JIC 37° - Swivel

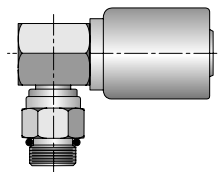

Part Number	Thread inch	Hose ID inch
106HY-3-4	3/8x24	1/4
106HY-4-4	7/16x20	1/4
106HY-4-6	7/16x20	3/8
106HY-5-4	1/2x20	1/4
106HY-5-5	1/2x20	5/16
106HY-5-6	1/2x20	3/8
106HY-6-4	9/16x18	1/4
106HY-6-5	9/16x18	5/16
106HY-6-6	9/16x18	3/8
106HY-8-6	3/4x16	3/8
106HY-8-8	3/4x16	1/2
106HY-8-10	3/4x16	5/8
106HY-8-12	3/4x16	3/4
106HY-10-6	7/8x14	3/8
106HY-10-8	7/8x14	1/2
106HY-10-10	7/8x14	5/8
106HY-10-12	7/8x14	3/4
106HY-12-6	1-1/16x12	3/8
106HY-12-8	1-1/16x12	1/2
106HY-12-10	1-1/16x12	5/8
106HY-12-12	1-1/16x12	3/4
106HY-12-16	1-1/16x12	1
106HY-14-12	1-3/16x12	3/4
106HY-16-12	1-5/16x12	3/4
106HY-16-14	1-5/16x12	7/8
106HY-16-16	1-5/16x12	1
106HY-16-20	1-5/16x12	1-1/4
106HY-20-16	1-5/8x12	1
106HY-20-20	1-5/8x12	1-1/4

Stainless steel fittings must be assembled with [Karrykrimp 2](#), [PHastkrimp](#), [Superkrimp](#) or [Parkrimp 2](#).
See www.parker.com/crimpsource for more information.

107HY

Female NPSM Pipe - Swivel - (60° Cone)

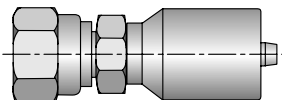

Part Number	Thread inch	Hose ID inch
107HY-4-4	1/4x18	1/4
107HY-6-4	3/8x18	1/4
107HY-6-6	3/8x18	3/8
107HY-8-8	1/2x14	1/2
107HY-12-8	3/4x14	1/2
107HY-12-12	3/4x14	3/4
107HY-16-16	1x11-1/2	1

108HY

Female SAE 45° - Swivel

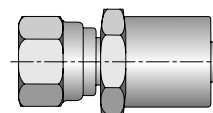

Part Number	Thread inch	Hose ID inch
108HY-4-4	7/16x20	1/4
108HY-5-4	1/2x20	1/4
108HY-5-5	1/2x20	5/16
108HY-6-4	5/8x18	1/4
108HY-6-5	5/8x18	5/16
108HY-6-6	5/8x18	3/8
108HY-8-6	3/4x16	3/8
108HY-8-8	3/4x16	1/2
108HY-8-12	3/4x16	3/4
108HY-10-8	7/8x14	1/2
108HY-10-10	7/8x14	5/8
108HY-12-10	1-1/16x12	5/8
108HY-12-12	1-1/16x12	3/4

10GHY

Male SAE Straight Thread with O-Ring - Swivel

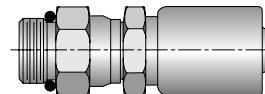

Part Number	Thread inch	Hose ID inch
10GHY-4-4	7/16x20	1/4
10GHY-5-4	1/2x20	1/4
10GHY-6-4	9/16x18	1/4
10GHY-6-6	9/16x18	3/8
10GHY-8-6	3/4x16	3/8
10GHY-8-8	3/4x16	1/2
10GHY-10-8	7/8x14	1/2
10GHY-12-8	1-1/16x12	1/2
10GHY-12-12	1-1/16x12	3/4
10GHY-16-16	1-5/16x12	1

Fitting allows minor movement under pressure to relieve stress on hose but is not to be used on extensive or continuous swiveling.
O-Ring not compatible with Phosphate Ester fluids.

10LHY

Male SAE Straight Thread with O-Ring - Swivel - 90° Elbow

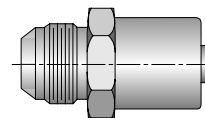

Part Number	Thread inch	Hose ID inch
10LHY-4-4	7/16x20	1/4
10LHY-6-4	9/16x18	1/4
10LHY-6-6	9/16x18	3/8
10LHY-8-4	3/4x16	1/4
10LHY-8-6	3/4x16	3/8
10LHY-8-8	3/4x16	1/2
10LHY-10-8	7/8x14	1/2
10LHY-12-12	1-1/16x12	3/4

Fitting allows minor movement under pressure to relieve stress on hose but is not to be used on extensive or continuous swiveling.

HY Series: Use with [AX](#), [BXX](#), [S4](#), [S5](#), [S6](#) and [S9](#) hoses.

Dimensions and pressures are for reference only and are subject to change.

111HY

Male Ferulok Flareless - Rigid
(24° Cone w/Nut and Ferrule)

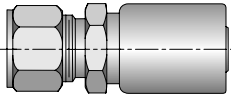

Part Number	Thread inch	Hose ID inch
111HY-4-4	7/16x20	1/4
111HY-4-6	7/16x20	3/8
111HY-5-6	1/2x20	3/8
111HY-6-4	9/16x18	1/4
111HY-6-6	9/16x18	3/8
111HY-8-6	3/4x16	3/8
111HY-8-8	3/4x16	1/2
111HY-10-8	7/8x14	1/2
111HY-12-12	1-1/16x12	3/4

The Parker Ferrule-Fix fitting makes it possible to salvage the bent tube section from a hose assembly for quick, easy on the job repairs. For additional information see Ferrule-Fix installation instructions in [Section N](#).

113HY

Male NPTF Pipe - Swivel

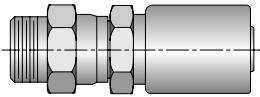

Part Number	Thread inch	Hose ID inch
113HY-2-4	1/8x27	1/4
113HY-4-4	1/4x18	1/4
113HY-4-6	1/4x18	3/8
113HY-6-4	3/8x18	1/4
113HY-6-6	3/8x18	3/8
113HY-6-8	3/8x18	1/2
113HY-8-6	1/2x14	3/8
113HY-8-8	1/2x14	1/2
113HY-12-12	3/4x14	3/4
113HY-16-16	1x11-1/2	1

Fitting allows minor movement under pressure to relieve stress on hose but is not to be used for continuous swiveling. See [Section O](#) for Pressure Limitations.

11LHY

Male NPTF Pipe - Swivel -
90° Elbow

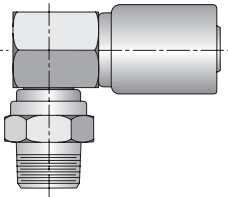

Part Number	Thread inch	Hose ID inch
11LHY-2-4	1/8x27	1/4
11LHY-4-4	1/4x18	1/4
11LHY-4-6	1/4x18	3/8
11LHY-6-4	3/8x18	1/4
11LHY-6-6	3/8x18	3/8
11LHY-8-6	1/2x14	3/8
11LHY-8-8	1/2x14	1/2

128HY

Male Inverted SAE 45° -
Swivel

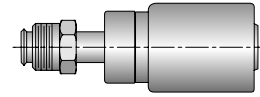

Part Number	Thread inch	Hose ID inch
128HY-3-4	3/8x24	1/4
128HY-4-4	7/16x24	1/4
128HY-5-4	1/2x20	1/4
128HY-5-6	1/2x20	3/8
128HY-6-5	5/8x18	5/16
128HY-6-6	5/8x18	3/8
128HY-7-6	11/16x18	3/8
128HY-8-6	3/4x18	3/8
128HY-8-8	3/4x18	1/2

129HY

Female Inverted SAE 45° -
Rigid

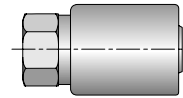

Part Number	Thread inch	Hose ID inch
129HY-5-4	1/2x20	1/4
129HY-6-6	5/8x18	3/8

137HY

Female JIC 37° - Swivel -
45° Elbow - Short Drop

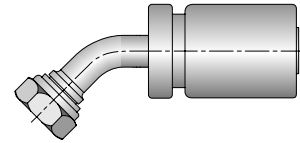

Part Number	Thread inch	Hose ID inch
137HY-4-4	7/16x20	1/4
137HY-5-4	1/2x20	1/4
137HY-6-4	9/16x18	1/4
137HY-6-5	9/16x18	5/16
137HY-6-6	9/16x18	3/8
137HY-8-6	3/4x16	3/8
137HY-8-8	3/4x16	1/2
137HY-10-8	7/8x14	1/2
137HY-10-10	7/8x14	5/8
137HY-12-10	1-1/16x12	5/8
137HY-12-12	1-1/16x12	3/4
137HY-16-12	1-5/16x12	3/4
137HY-16-16	1-5/16x12	1

134HY

Male Standpipe - Rigid -
(Inch Size Tube O.D.)

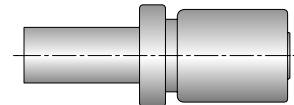

Part Number	R inch	Hose ID inch
134HY-6-6	3/8	3/8
134HY-8-6	1/2	3/8
134HY-12-12	3/4	3/4

HY Series: Use with [AX](#), [BXX](#), [S4](#), [S5](#), [S6](#) and [S9](#) hoses.

Dimensions and pressures are for reference only and are subject to change.

139HY

Female JIC 37° - Swivel - 90° Elbow - Short Drop

Part Number	Thread inch	Hose ID inch
139HY-4-4	7/16x20	1/4
139HY-5-4	1/2x20	1/4
139HY-6-4	9/16x18	1/4
139HY-6-5	9/16x18	5/16
139HY-6-6	9/16x18	3/8
139HY-6-8	9/16x18	1/2
139HY-8-6	3/4x16	3/8
139HY-8-8	3/4x16	1/2
139HY-10-8	7/8x14	1/2
139HY-10-10	7/8x14	5/8
139HY-10-12	7/8x14	3/4
139HY-12-8	1-1/16x12	1/2
139HY-12-10	1-1/16x12	5/8
139HY-12-12	1-1/16x12	3/4
139HY-16-12	1-5/16x12	3/4
139HY-16-16	1-5/16x12	1

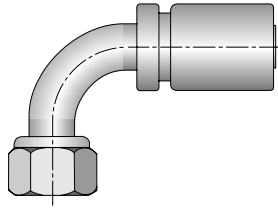

167HY

Male Inverted SAE 45° - Swivel - 45° Elbow

Part Number	Thread inch	Hose ID inch
167HY-4-4	7/16x24	1/4
167HY-5-4	1/2x20	1/4
167HY-5-6	1/2x20	3/8
167HY-6-6	5/8x18	3/8
167HY-8-8	3/4x18	1/2

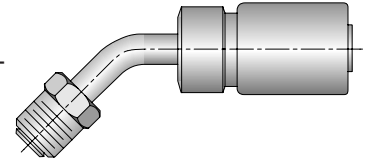

169HY

Male Inverted SAE 45° - Swivel - 90° Elbow

Part Number	Thread inch	Hose ID inch
169HY-3-4	3/8x24	1/4
169HY-4-4	7/16x24	1/4
169HY-4-6	7/16x24	3/8
169HY-5-4	1/2x20	1/4
169HY-5-6	1/2x20	3/8
169HY-6-5	5/8x18	5/16
169HY-6-6	5/8x18	3/8
169HY-7-6	11/16x18	3/8
169HY-8-8	3/4x18	1/2

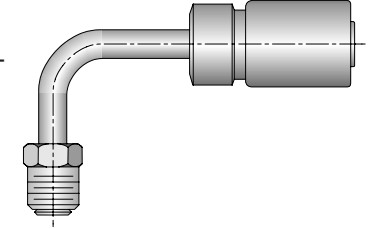

13DHY

Male Standpipe Metric S - Rigid

End Connection per ISO 8434-1-SDS

Part Number	R mm	Hose ID inch
13DHY-16-8	16	1/2
13DHY-30-16	30	1

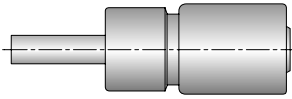

177HY

Female SAE 45° - Swivel - 45° Elbow

Part Number	Thread inch	Hose ID inch
177HY-6-6	5/8x18	3/8
177HY-12-12	1-1/16x14	3/4

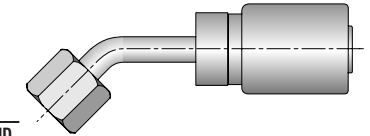

141HY

Female JIC 37° - Swivel - 90° Elbow - Long Drop

Part Number	Thread inch	Hose ID inch
139HY-4-4	7/16x20	1/4
139HY-5-4	1/2x20	1/4
139HY-6-4	9/16x18	1/4
139HY-6-5	9/16x18	5/16
139HY-6-6	9/16x18	3/8
139HY-6-8	9/16x18	1/2
139HY-8-6	3/4x16	3/8
139HY-8-8	3/4x16	1/2
139HY-10-8	7/8x14	1/2
139HY-10-10	7/8x14	5/8
139HY-10-12	7/8x14	3/4
139HY-12-8	1-1/16x12	1/2
139HY-12-10	1-1/16x12	5/8
139HY-12-12	1-1/16x12	3/4
139HY-16-12	1-5/16x12	3/4
139HY-16-16	1-5/16x12	1

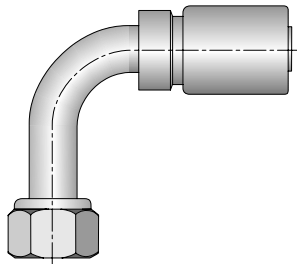

179HY

Female SAE 45° - Swivel - 90° Elbow

Part Number	Thread inch	Hose ID inch
179HY-6-5	5/8x18	5/16
179HY-6-6	5/8x18	3/8
179HY-12-12	1-1/16x14	3/4

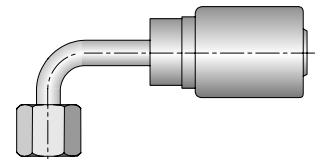

193HY

Female JIC 37° - Swivel - 90° Elbow - (Block Type)

Part Number	Thread inch	Hose ID inch
193HY-6-6	9/16x18	3/8
193HY-8-6	3/4x16	3/8
193HY-8-8	3/4x16	1/2
193HY-12-12	1-1/16x12	3/4

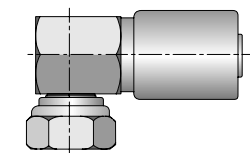

HY Series: Use with AX, BXX, S4, S5, S6 and S9 hoses.

Dimensions and pressures are for reference only and are subject to change.

1D0HY

Male Metric L - Rigid -
(24° Cone)
ISO 12151-2

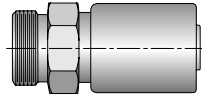

Part Number	Thread mm	Hose ID inch
1D0HY-6-4	6 M12x1.5	1/4
1D0HY-8-4	8 M14x1.5	1/4
1D0HY-10-4	10 M16x1.5	1/4
1D0HY-10-6	10 M16x1.5	3/8
1D0HY-12-6	12 M18x1.5	3/8
1D0HY-15-6	15 M22x1.5	3/8
1D0HY-15-8	15 M22x1.5	1/2
1D0HY-18-10	18 M26x1.5	5/8

1D9HY

Male BSP Parallel Pipe -
Rigid - (60° Cone)
ISO 228-1

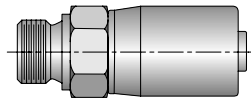

Part Number	Thread inch	Hose ID inch
1D9HY-4-4	1/4x19	1/4
1D9HY-6-6	3/8x19	3/8
1D9HY-8-6	1/2x14	3/8
1D9HY-8-8	1/2x14	1/2

When used in a port, a bonded seal must be used.

1GJHY

Female Grease Connection -
SPL - PTF Taper Thread -
Rigid - 1/2x27

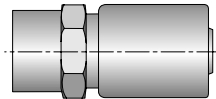

Part Number	Thread inch	Hose ID inch
1GJHY-8-4	1/2x27	1/4

1GUHY

Female BSP Parallel Pipe -
Swivel - (60° Cone)
ISO 228-1

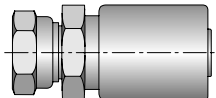

Part Number	Thread inch	Hose ID inch
1GUHY-4-4	1/4x19	1/4
1GUHY-6-4	3/8x19	1/4
1GUHY-6-6	3/8x19	3/8
1GUHY-8-6	1/2x14	3/8
1GUHY-8-8	1/2x14	1/2
1GUHY-12-12	3/4x14	3/4
1GUHY-16-16	1x11	1

1J0HY

Male Seal-Lok™ - Rigid -
(with O-Ring)
ISO 1215-1 - S

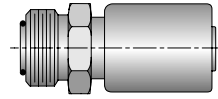

Part Number	Thread inch	Hose ID inch
1J0HY-4-4	9/16x18	1/4
1J0HY-6-6	11/16x16	3/8
1J0HY-8-8	13/16x16	1/2
1J0HY-12-8	1-3/16x12	1/2

1J1HY

Female Seal-Lok™ - Swivel -
90° Elbow - Long Drop
ISO 12151-1 - SWEL90

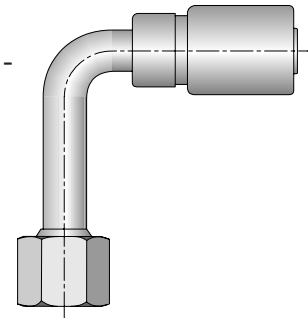

Part Number	Thread inch	Hose ID inch
1J1HY-4-4	9/16x18	1/4
1J1HY-6-4	11/16x16	1/4
1J1HY-6-6	11/16x16	3/8
1J1HY-8-6	13/16x16	3/8
1J1HY-8-8	13/16x16	1/2
1J1HY-10-8	1x14	1/2
1J1HY-10-10	1x14	5/8
1J1HY-12-12	1-3/16x12	3/4
1J1HY-16-16	1-7/16x12	1

1J7HY

Female Seal-Lok™ -
Swivel - 45° Elbow
ISO 12151-1 - SWE45

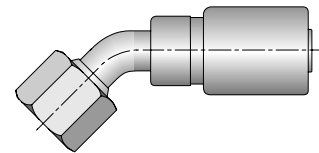

Part Number	Thread inch	Hose ID inch
1J7HY-4-4	9/16x18	1/4
1J7HY-6-4	11/16x16	1/4
1J7HY-6-6	11/16x16	3/8
1J7HY-6-8	11/16x16	1/2
1J7HY-8-4	13/16x16	1/4
1J7HY-8-6	13/16x16	3/8
1J7HY-8-8	13/16x16	1/2
1J7HY-10-8	1x14	1/2
1J7HY-10-10	1x14	5/8
1J7HY-10-12	1x14	3/4
1J7HY-12-10	1-3/16x12	5/8
1J7HY-12-12	1-3/16x12	3/4
1J7HY-16-12	1-7/16x12	3/4
1J7HY-16-16	1-7/16x12	1

HY Series: Use with AX, BXX, S4, S5, S6 and S9 hoses.

Dimensions and pressures are for reference only and are subject to change.

1J9HY

Female Seal-Lok™ -
Swivel - 90° Elbow -
Short Drop
ISO 12151-1 - SWES90

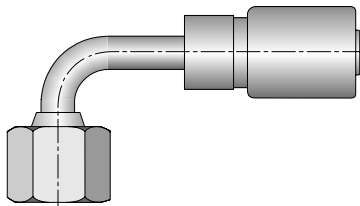

Part Number	Thread inch	Hose ID inch
1J9HY-4-4	9/16x18	1/4
1J9HY-4-6	9/16x18	3/8
1J9HY-6-4	11/16x16	1/4
1J9HY-6-5	11/16x16	5/16
1J9HY-6-6	11/16x16	3/8
1J9HY-6-8	11/16x16	1/2
1J9HY-8-6	13/16x16	3/8
1J9HY-8-8	13/16x16	1/2
1J9HY-10-8	1x14	1/2
1J9HY-10-10	1x14	5/8
1J9HY-10-12	1x14	3/4
1J9HY-12-8	1-3/16x12	1/2
1J9HY-12-10	1-3/16x12	5/8
1J9HY-12-12	1-3/16x12	3/4
1J9HY-16-12	1-7/16x12	3/4
1J9HY-16-16	1-7/16x12	1
1J9HY-20-16	1-11/16x12	1

1JCHY

Female Seal-Lok™ -
Swivel - Short
ISO 12151-1 - SWSA

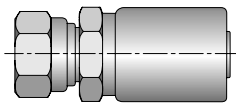

Part Number	Thread inch	Hose ID inch
1JCHY-4-4	9/16x18	1/4
1JCHY-6-6	11/16x16	3/8
1JCHY-8-8	13/16x16	1/2
1JCHY-12-12	1-3/16x12	3/4

1JSHY

Female Seal-Lok™ -
Swivel - Long
ISO 12151-1 - SWSB

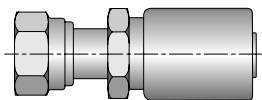

Part Number	Thread inch	Hose ID inch
1JSHY-4-4	9/16x18	1/4
1JSHY-6-4	11/16x16	1/4
1JSHY-6-5	11/16x16	5/16
1JSHY-6-6	11/16x16	3/8
1JSHY-8-6	13/16x16	3/8
1JSHY-8-8	13/16x16	1/2
1JSHY-10-8	1x14	1/2
1JSHY-10-10	1x14	5/8
1JSHY-10-12	1x14	3/4
1JSHY-12-10	1-3/16x12	5/8
1JSHY-12-12	1-3/16x12	3/4
1JSHY-16-12	1-7/16x12	3/4
1JSHY-16-16	1-7/16x12	1
1JSHY-20-16	1-11/16x12	1
1JSHY-20-20	1-11/16x12	1-1/4

1UTHY

Male BSP Taper Pipe -
Rigid - (60° Cone)

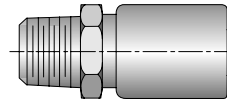

Part Number	Thread inch	Hose ID inch
1UTHY-2-4	1/8x28	1/4
1UTHY-4-4	1/4x19	1/4

1XUHY

Female Metric Swivel -
(30° Flare)

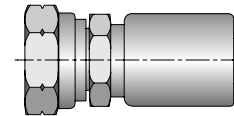

Part Number	Thread mm	Hose ID inch
1XUHY-24-8	24 M24x1.5	1/2
1XUHY-24-10	24 M24x1.5	5/8
1XUHY-30-12	30 M30x1.5	3/4
1XUHY-33-16	33 M33x1.5	1

SF Series

101SF

Male Taper Pipe Rigid

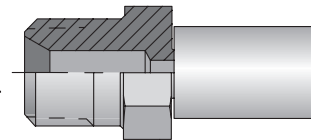

Part Number	Thread inch	Hose Size inch	mm
101SF-2-1	1/8-27	.090	2.3

Construction: Steel

106SF

JIC 37° Swivel

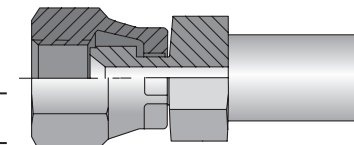

Part Number	Thread inch	Hose Size inch	mm
106SF-2-1	5/16-24	.090	2.3

Construction: Steel

1JBSF

Male Seal-Lok™
Bulkhead with O-Ring

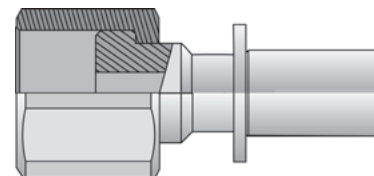

Part Number	Thread inch	Hose Size inch	mm
1JBSF-4-1	9/16-18	.090	2.3

Construction: Steel

Note: Bulkhead Locknut sold separately.
WLN Locknuts are Manufactured by the
Tube Fittings Division. Refer to Catalog 4300
for additional information.

HY Series: Use with AX, BXX, S4, S5, S6 and S9 hoses.

SF Series: Use with 56DH and 568DH hoses.

Dimensions and pressures are for reference only and are subject to change.

1JSSF

Female Seal-Lok™ Swivel Long

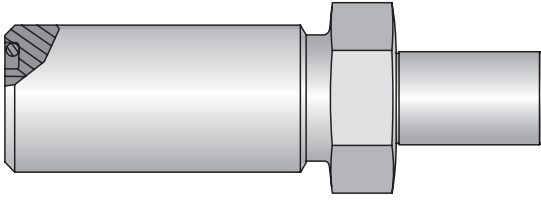

Part Number	Thread inch	Hose Size	
		inch	mm
1JSSF-4-1	9/16-18	.090	2.3

Construction: Steel

SF Series: Use with [56DH](#) and [568DH](#) hoses.

Dimensions and pressures are for reference only and are subject to change.