



P: 800.961.7370  
www.solerpalau-usa.com



# MODEL TR90

(Energy Recovery Ventilators (ERV))



## Specifications

Ventilation Type: Static Plate, Heat and Humidity Transfer				
Typical Airflow Range: 40-110 CFM				
Painted Case, Low Voltage Controls, Line Cord				
Unit may be mounted in any orientation and in heated or unheated locations				
Number Motors: Two, 0.03 hp each, totally enclosed, thermally protected, 0.35A				
V	Hz	Phase	Input Watts	FLA
120	60	Single	94 @ 69 CFM	0.16
Control Voltage: 24 VAC				
Filters: MERV 8, spun polyester media. 7-12" x 10-1/2" x 1"				
Weight: 36 lbs (unit), 41 lbs (in carton)				
Shipping Dimensions: 21-1/2" W x 28-1/2" L x 14-3/4" H				
Options:				
SPTL - Percentage Timer Control				
SPBL - Push Button Point-of-Use Control				
SFM Percentage Timer Control with Furnace Interlock				
SHW-20 - Dehumidistat Control				

## Core Performance

Airflow CFM	Temp EFF%	Total EFF% Winter*	Total EFF% Summer*
113	61	55	42
98	64	58	46
85	67	61	49
73	69	63	53
58	72	66	57
40	76	70	61

\* Contact Factory for HVI certification report for complete certified rating.

## Dimensions

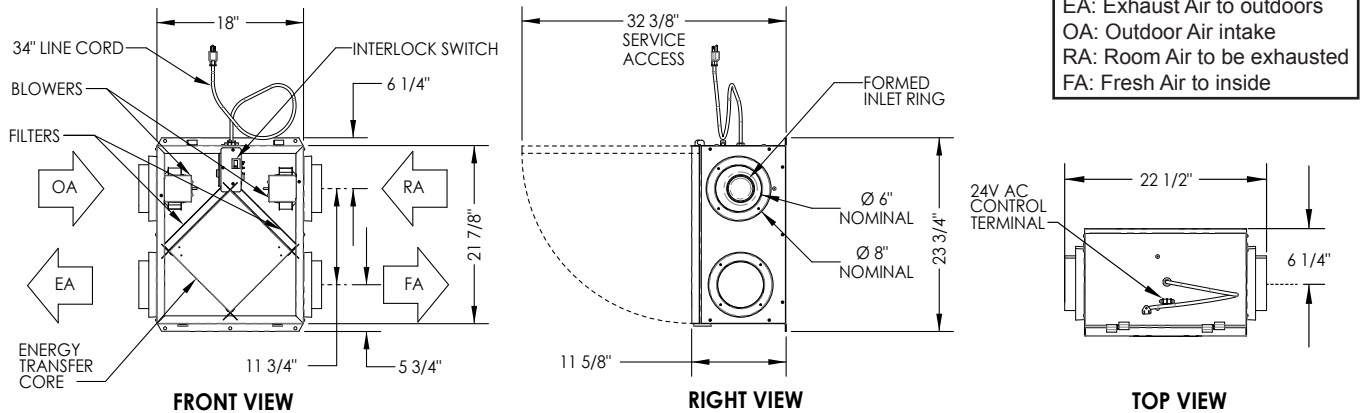

For more information contact us at [www.solerpalau-usa.com](http://www.solerpalau-usa.com) or 1.800.961.7370 for additional submittal drawings. Soler & Palau will not be responsible for fabrication changes or errors resulting from customer use of a non-current submittal drawing.