

# IB418 3/8"-2"

**Bronze Globe Valve  
125 SWP - 200 WOG †  
Bronze Disc  
Threaded Bonnet • Solder Ends  
Conforms to: MSS SP-80**

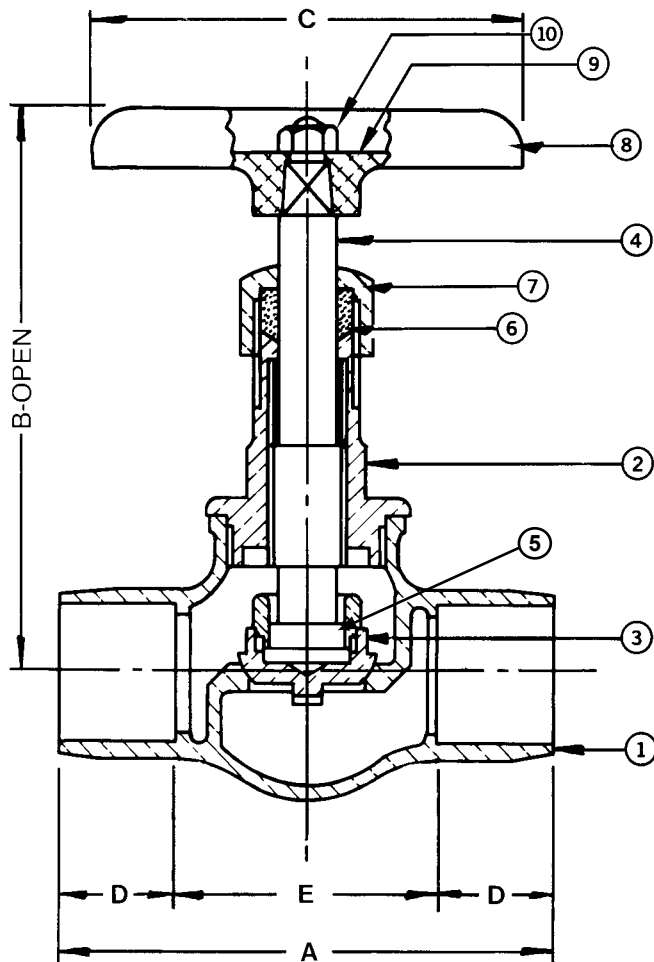

Note: Not intended for use in potable water.

MATERIAL LIST			
No.	PART	MATERIAL	SPECIFICATION
1	Body	Bronze	ASTM B62
2	Bonnet	Bronze	ASTM B62
3	Disc*	Bronze	ASTM B62
4	Stem	Bronze	ASTM B16
5	Disc Ring	Brass	ASTM B16 3/4" to 2" Incl.
6	Packing	Graphite	Commercial
7	Packing Nut	Brass	ASTM B16
8	Handwheel	Mall. Iron	Commercial
9	Name Plate	Aluminum	Commercial
10	Handwheel Nut	Brass	Commercial

\* 3/8" and 1/2" sizes have the disc integral with the stem and have no disc ring. 3/4" - 1 1/4" sizes Disc material is ASTM B453 C4500

DIMENSIONS - INCHES/MILLIMETERS							
Units	Size	A	B	C	D	E	C <sub>v</sub>
Inches mm	3/8	2.00 59	3.19 82	2.00 51	0.38 10	1.25 32	2.21
Inches mm	1/2	2.44 62	3.75 95	2.25 57	0.50 13	1.44 37	3.64
Inches mm	3/4	3.19 81	4.00 102	2.50 64	0.75 19	1.69 43	6.65
Inches mm	1	3.69 94	4.38 111	2.75 70	0.91 23	1.88 43	11.10
Inches mm	1 1/4	4.19 106	5.13 130	3.13 80	0.97 25	2.25 57	20.00
Inches mm	1 1/2	4.75 121	5.63 143	3.50 89	1.09 28	2.56 65	28.00
Inches mm	2	5.94 151	6.69 170	4.00 102	1.34 34	3.25 83	48.00

† Non-Shock

The information presented on this sheet is correct at time of publication. Hammond Valve reserves the right to change design and/or materials without notice. For our Installation, Operation and Maintenance Manual and the most current product information go to [www.hammondvalve.com](http://www.hammondvalve.com). Hammond Valve is a registered trademark of Milwaukee Valve.

⚠ State of California Prop 65 **WARNING:** Cancer and Reproductive Harm. For more information visit [www.p65warnings.ca.gov](http://www.p65warnings.ca.gov).