









Location:



S-3502-CYL-B
Tub/Shower System
Specification Submittal

<p>Feature Highlights</p> <ul style="list-style-type: none"> • Secondary integral diverter • Metal lever handle • Adjustable stop screw to limit handle turn • 7" non-diverter tub spout • 1 mode showerhead • 2.5 gpm (9.5 L/min) standard flow restrictor • Components shall be metal and nonmetallic construction, plated in standard polished chrome finish 	<p>Options/Modifications cont.</p> <ul style="list-style-type: none"> <input type="checkbox"/> -X <i>Integral service stops - allows water shutoff at valve for service</i> <input type="checkbox"/> -X-CHKS <i>Integral check stops - for use in installations where a positive shut-off device is used downstream of mixing valve</i> <input type="checkbox"/> -BBZ <i>Brushed Bronze finish</i> <input type="checkbox"/> -MB <i>Matte Black finish</i> <input type="checkbox"/> -STN <i>Satin Nickel finish</i>
<p>Model Numbers</p> <ul style="list-style-type: none"> <input type="checkbox"/> S-3502-CYL-B Tub/Shower Shower System with Symmons Temptrol® 4-port pressure balancing mixing valve <input type="checkbox"/> S-46-2-BODY Symmons Temptrol 4-port pressure balancing mixing valve <input type="checkbox"/> S-46-2X-BODY Symmons Temptrol 4-port pressure balancing mixing valve with integral service stops 	<p>Note: Append appropriate -suffix to model number.</p> <p>Compliance</p> <p>- ASME A112.18.1/CSA B125.1</p> 
<p>Options/Modifications</p> <ul style="list-style-type: none"> <input type="checkbox"/> -1.5  <i>1.5 gpm (5.7 L/min) flow restrictor</i> <input type="checkbox"/> -2.0 <i>2.0 gpm (7.6 L/min) flow restrictor</i> <input type="checkbox"/> Delete Suffix B <i>Chrome only plastic escutcheon on valve with color graphics/indicators</i> <input type="checkbox"/> -IPS <i>1/2" female IPS connections</i> <input type="checkbox"/> -L/HD <i>Less showerhead</i> <input type="checkbox"/> -REB <i>Rebuild trim kit, includes TA-10 and TA-4</i> <input type="checkbox"/> -REV <i>Reverse coring, hot on right, cold on left, for back to back installations</i> <input type="checkbox"/> -SH2  <i>Alternative 352SH-3, 3 mode showerhead (Chrome and Satin Nickel finish only)</i> <input type="checkbox"/> -SH3  <i>Alternative 362SH Duro showerhead</i> <input type="checkbox"/> -SH4  <i>Alternative 361SH Duro square showerhead</i> <input type="checkbox"/> -SS <i>Slip spout (available in chrome and STN finish only)</i> <input type="checkbox"/> -T4  <i>Alternative 361TS, non-diverter square tub spout</i> <input type="checkbox"/> -TRM <i>Trim only, valve must be ordered separately</i> <input type="checkbox"/> -VP <i>Vandal resistant escutcheon screws in place of standard screws</i> 	<p>Warranty</p> <p>Limited Lifetime - to the original end purchaser in consumer/residential installations. 5 Years - for industrial/commercial installations. Refer to www.symmons.com/warranty for complete warranty information.</p>

Dimensions

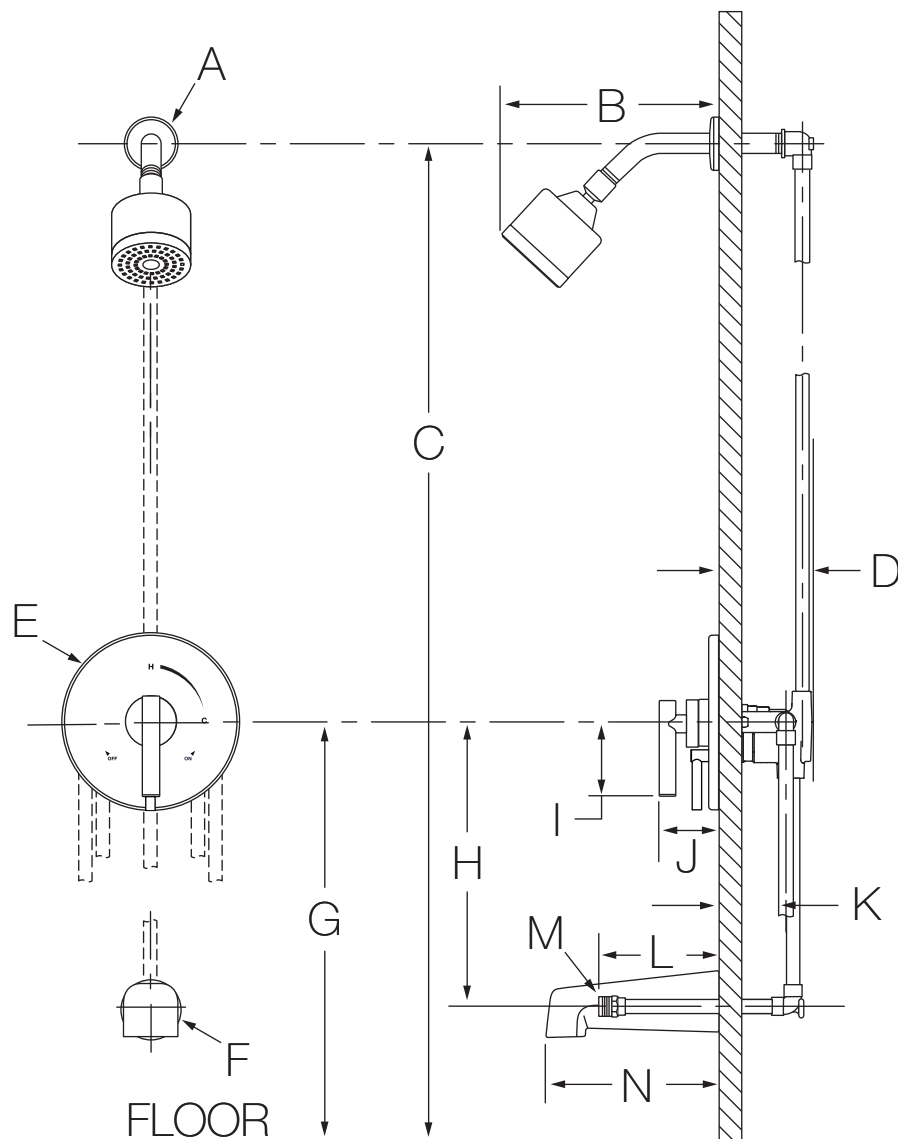

Measurements	
A	Ø 2-1/2", 64 mm
B	6-3/4", 171 mm
C	Ref. 77", 1956 mm
D	3-1/2", 89 mm
E	Ø 7-1/2", 191 mm
F	Ø 2-1/2", 64 mm
G	Ref. 32", 813 mm
H	Ref. 12", 305 mm
I	3", 76 mm
J	2-7/8", 73 mm
K	Rough-in 2-3/8" ± 1/2", 60 mm ± 13 mm
L	5-1/4", 133 mm
M	Male 1/2-14 NPT fitting must protrude 5-1/4" (133 mm) from finished wall
N	7", 178 mm
O	6-3/4", 171 mm
P	6", 152 mm
Q	5-5/8", 143 mm
R	2-1/4", 57 mm
S	2-1/2", 64 mm
T	5-5/8", 143 mm
U	Male 1/2-14 NPT fitting must protrude 4-7/16" (113 mm) from finished wall

-SH2

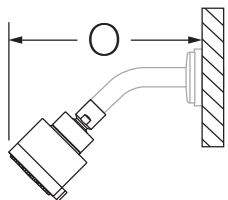

-SH3

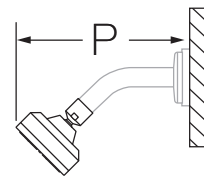

-SH4

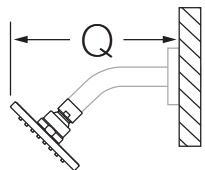
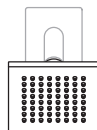

-T4

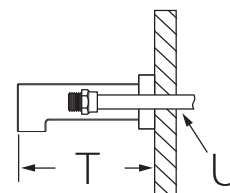
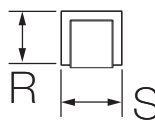

Notes:

- 1) Plaster shield (p/n T-176) for dry wall, plaster or other type walls 1/2" or greater.
- 2) Do not install positive shut-off device/devices that do not allow the valve to flow at least 1.5 gpm to valve outlets.
- 3) All dimensions measured from nominal rough-in (see K as reference).
- 4) Dimensions subject to change without notice.