



ARMORCAST® WATER UTILITY PRODUCTS



ARMORCAST PRODUCTS COMPANY

13230 Saticoy Street, North Hollywood, Ca 91605 Tel: (818) 982-3600 Fax: (818) 982-7742 www.armorcastprod.com

ARMORCAST COMPANY INFORMATION



ARMORCAST PRODUCTS COMPANY

• INNOVATION

Innovation has been a cornerstone of Armorcast since 1966. Combined with our outstanding Quality, Variety and Service that we are renowned for, Armorcast Products continues as the innovative leader for below and above grade enclosures.

Two words describe innovation; Improvement and Originality. To our staff this also means creating and developing effective and efficient solutions to problems. To accomplish all of this takes a tremendous amount of ingenuity, vision, understanding and experience.

We have been developing successful, innovative solutions for over 40 years.

• QUALITY

Outstanding quality is a direct result of careful planning, diligent adherence to many established practices and implementation of precise and repetitive procedures and practices. Our customer driven Quality Assurance Guidelines and Procedures initiated many years ago, insure the highest standards for raw materials, manufacturing operations and consistency in workmanship in all our offerings. Every one of our products will meet and/or exceed the most stringent and demanding conditions set forth by our customers, time after time.

• VARIETY

Numerous situations arise whereby the need for product variety, versatility and affordability for specific applications or projects are most critical. Armorcast offers the broadest range of underground and above grade enclosures for a multitude of applications, industries and markets.

• SERVICE

We believe that the growth of Armorcast is in direct proportion to the success of our customers in their individual endeavors by providing them with excellent service, on-time delivery and complete satisfaction.

TABLE OF CONTENTS PAGE

ARMORCAST COMPANY INFORMATION.....	1-2
PRODUCT INFORMATION.....	3-4
BOXES & COVERS.....	5-6
VAULTS & COVERS.....	7-8
AIR VACUUM ENCLOSURES.....	9
WATER SAMPLING STATIONS.....	10



ORDERING INFORMATION:

Contact an Armorcast Products Company representative or an Authorized Distributor for more information and technical assistance on our products and capabilities.

 **Armorcast** Products Company
13230 Saticoy Street
North Hollywood, California 91605



ARMORCAST PRODUCTS COMPANY

ARMORCAST COMPANY INFORMATION

Since 1966, Armorcast Products has been the innovative leader in supplying the utility industry with secure and protective enclosures. Providing below and above grade ground boxes and vaults of all shapes and sizes. Armorcast continues to be the sought after source for enclosures from numerous utilities, municipalities, contractors, state agencies and communication companies. The markets we serve are as diverse as our product offerings. Armorcast produces durable, functional and effective finished products, engineered to the end-user specifications and are available when and where they are needed. Armorcast has several facilities totaling nearly 400,000 sq. ft. of manufacturing space.



*Corporate Headquarters
North Hollywood, California*



Corporate Facility / North Hollywood, California

Ontario, California



www.armorcastprod.com

Tel: (818) 982-3600 Fax: (818) 982-7742

PRODUCT INFORMATION

COVERS



ARMORCAST PRODUCTS COMPANY

Armorcast Polymer Concrete Fiberglass, and Rotocast products compared to conventional material; Concrete, Wood, Steel etc..

- Lighter weight
- High load carrying capacity
- High impact resistance
- Non-conductive or sparking
- Non-combustible
- Superior weathering resistance
- Excellent chemical resistance
- Excellent insulating properties for cold climate installations
- Bolt Down options available
- Ease of installation
- Zero maintenance

Covers: Slip Resistance Surfaces

All covers that are exposed to foot traffic have a slip resistant surface with a minimum coefficient of friction of 0.60 under wet or dry conditions. Armorcast Products Company slip resistant covers meet the American with Disabilities Act slip resistance requirements.

ROUND / DROP IN / HINGED READER LIDS



ROUND AMR/AMI
UNDER MOUNT



COVER WITH
DROP-IN LID

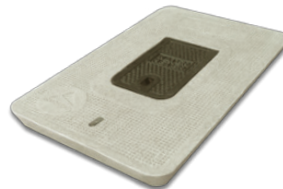

COVER WITH
CAST IRON HINGED LID

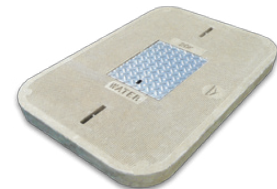

COVER WITH
DIAMOND PLATE HINGED LID

AMR / AMI FEATURES

Covers are compatible to most AMR/AMI manufacturers, transmitter holes vary in size and location. Bottom surface mounting options are available. Contact an Armorcast representative for more information.



COVER WITH
SINGLE TOP MOUNT AMR/AMI



COVER WITH
DUAL TOP MOUNT AMR/AMI

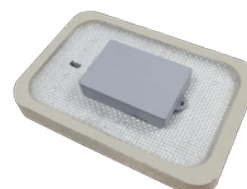

COVER WITH
BOTTOM MOUNT AMR/AMI



ARMORCAST PRODUCTS COMPANY

PRODUCT INFORMATION

METER BOXES, VAULTS & ROUNDS

Polymer Concrete / Fiberglass Meter Boxes & Vaults

The Armorcast Products Company line of Polymer Concrete and Fiberglass Boxes and Vaults are designed to provide maximum strength and durability. Lighterweight than traditional concrete, they are easily installed and provide superior strength and longevity. Meets all WUC and SCTE / ANSI 77 specifications.

Polyethylene Rotocast Meter Boxes & Round Meter Pits

Elite blend of Polyethylene material formula with UV inhibitors have exceptional weatherability and durability characteristics as well as high environmental stress crack resistance. Superior tensile and impact strengths at both ambient and sub-zero temperatures and unique structural design provides added strengths and stability.

WATER METER BOXES & COVERS

Available with AMR/AMI Covers, Drop-In Covers and/or Hinged Reader Lids



**STRAIGHT WALL
POLYMER CONCRETE**



**FLARED WALL
POLYMER CONCRETE**



**POLYETHYLENE
ROTOCAST**



**FLARED WALL
FIBERGLASS**

WATER METER VAULTS & ROUNDS

Available with Standard or Torsion Assist covers with AMR/AMI, Drop-in and Hinged Reader Lids



POLYETHYLENE ROTOCAST ROUND PIT



POLYMER CONCRETE VAULT



FIBERGLASS VAULT

WATER METER BOXES & COVERS



ARMORCAST PRODUCTS COMPANY

POLYMER CONCRETE BOX COVERS

COVER with
HINGED READER LID

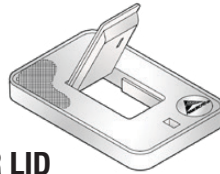

COVER with DROP-IN LID

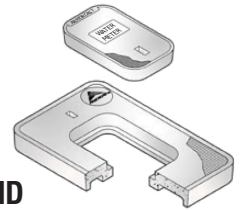

COVER SIZE	10K PART#	WT.	20K PART#	WT.	10K PART#	WT.	20K PART#	WT.	Drop-In Part#	Size
9" x 14"	---	---	---	---	---	---	---	---	---	---
10" x 15"	A6001922R	13 lbs.	A6001922TR	18 lbs.	A6001922DQ	10 lbs.	A6001922TDQ	16 lbs.	A6000487T	5" x 7"
10" x 20"	A6000483R	15 lbs.	A6000483TR	19 lbs.	A6000483DQ	13 lbs.	A6000483TDQ	16 lbs.	A6000487T	5" x 7"
11" x 21"	A6000489R	23 lbs.	A6000489TR	26 lbs.	---	---	---	---	---	---
11" x 18"	A6001428R	15 lbs.	A6001428TR	16 lbs.	---	---	---	---	---	---
12" x 18"	A6001426R	19 lbs.	A6001426TR	20 lbs.	---	---	---	---	---	---
12" x 20"	A6000484R	17 lbs.	A6000484TR	23 lbs.	A6000484DQ	13 lbs.	A6000484TDQ	19 lbs.	A6000487T	5" x 7"
13" x 24"	A6001866R	35 lbs.	A6001969TR	37 lbs.	A6001866DQ	34 lbs.	A6001866TDQ	37 lbs.	A6000487T	5" x 7"
17" x 28"	A6001420R	29 lbs.	A6001420TR	45 lbs.	A6001420DW	29 lbs.	A6001420TDW	42 lbs.	A6000481DT	7" x 13"
17" x 30"	A6001643R	45 lbs.	A6001947TR	69 lbs.	A6001643DZ	45 lbs.	A6001947TDZ	65 lbs.	A6000482T	9" x 14"
18" x 19"	A6000491R	30 lbs.	A6000491TR	42 lbs.	---	---	---	---	---	---
24" x 36"	A6001975R	102 lbs.	A6001975TR	104 lbs.	A6001975DZ	---	A6001975TDZ	---	---	---
30" x 48"	---	---	---	---	A6001470DZ	---	A6001470TDZ	---	---	---

Contact an Armorcast Products Company representative for more information and technical assistance on our products and capabilities.

WATER METER BOXES

INDUSTRY
REFERENCE

STRAIGHT WALL
POLYMER CONCRETE

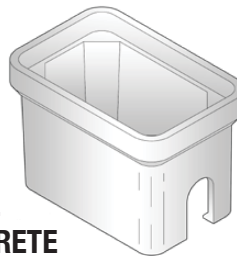

FLARED WALL
POLYMER CONCRETE

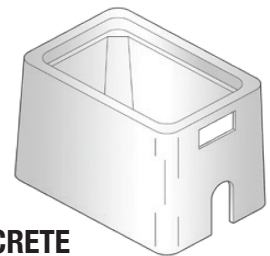

BOX SIZE	Concrete Cross Reference		PART#	WEIGHT	PART#	WEIGHT
9" x 14" x 12"	3	B-3	---	---	A6000494	39 lbs.
10" x 15" x 12"	36, 3.5	B-9	---	---	A6001921X12	46 lbs.
10" x 20" x 12"	33, 4	---	A6000486	34 lbs.	A6000486SA	38 lbs.
11" x 21" x 12"	---	B-16	A6000492	51 lbs.	---	---
12" x 18" x 12"	---	---	A6001425	41 lbs.	---	---
12" x 20" x 12"	37, 4.5	B-12	A6000485	33 lbs.	A6000485SA	38 lbs.
13" x 24" x 12"	38, 5.25	B-30	A6001946PCX12	50 lbs.	---	---
17" x 28" x 12"	65, 5.5	---	A6001419	55 lbs.	A6001419SA	78 lbs.
17" x 30" x 12"	66, 6	B-36	A6001640PCX12	70 lbs.	---	---
17" x 30" x 18"	66, 6	B-36	A6001640PCX18	96 lbs.	---	---
18" x 19" x 12"	---	B-24	A6000490	60 lbs.	---	---
24" x 36" x 12"	67	B-40	A6001974PCX12	100 lbs.	---	---
24" x 36" x 18"	67	B-40	A6001974PCX18	147 lbs.	---	---
30" x 48" x 18"	68	B-48	A6001430PCX18	192 lbs.	---	---

OTHER SIZES & DEPTHS ARE AVAILABLE.

Contact an Armorcast Products Company representative for more information and technical assistance on our products and capabilities.

www.armorcastprod.com

Tel: (818) 982-3600 Fax: (818) 982-7742



ARMORCAST PRODUCTS COMPANY

WATER METER BOXES & COVERS



COVER with AMR/AMI TOP MOUNT

*Specify Hole Size / 1" to 14"



COVER with AMR/AMI SLOT



ONE PIECE COVER

10K PART#	WT.	20K PART#	WT.	10K PART#	WT.	20K PART#	WT.	10K PART#	WT.	20K PART#	WT.
A6000482-H*	9 lbs.	A6000482T-H*	10 lbs.	---	---	---	---	A6000482	9 lbs.	A6000482T	10 lbs.
A6001922-H*	11 lbs.	A6001922-TH*	19 lbs.	A6001922-IT	13 lbs.	A6001922T-IT	15 lbs.	A6001922	11 lbs.	A6001922T	19 lbs.
A6000483-H*	14 lbs.	A6000483-TH*	19 lbs.	---	---	---	---	A6000483	14 lbs.	A6000483T	19 lbs.
A6000489-H*	21 lbs.	A6000489-TH*	28 lbs.	A6000489-IT	20 lbs.	A6000489T-IT	22 lbs.	A6000489	21 lbs.	A6000489T	28 lbs.
A6001428-H*	13 lbs.	A6001428-TH*	14 lbs.	---	---	---	---	A6001428	13 lbs.	A6001428T	14 lbs.
A6001426-H*	17 lbs.	A6001426-TH*	18 lbs.	---	---	---	---	A6001426	17 lbs.	A6001426T	18 lbs.
A6000484-H*	15 lbs.	A6000484-TH*	23 lbs.	A6000484-IT	23 lbs.	A6000484T-IT	24 lbs.	A6000484	15 lbs.	A6000484T	23 lbs.
A6001866-H*	33 lbs.	A6001969-TH*	43 lbs.	A6001866-IT	39 lbs.	A6001866T-IT	41 lbs.	A6001866	33 lbs.	A6001969T	43 lbs.
A6001420-H*	27 lbs.	A6001420-TH*	45 lbs.	A6001420-IT	43 lbs.	A6001420T-IT	45 lbs.	A6001420	27 lbs.	A6001420T	45 lbs.
A6001643-H*	43 lbs.	A6001947-TH*	70 lbs.	A6001643-IT	66 lbs.	A6001947T-IT	68 lbs.	A6001643	43 lbs.	A6001947T	70 lbs.
A6000491-H*	34 lbs.	A6000491-TH*	44 lbs.	---	---	---	---	A6000491	34 lbs.	A6000491T	44 lbs.
A6001975-H*	97 lbs.	A6001975-TH*	102 lbs.	---	---	---	---	A6001975	97 lbs.	A6001975T	102 lbs.
A6001470-H*	96 lbs.	A6001470-TH*	98 lbs.	---	---	---	---	A6001470	96 lbs.	A6001470T	98 lbs.

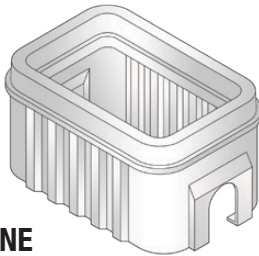

ROTOCAST POLYETHYLENE

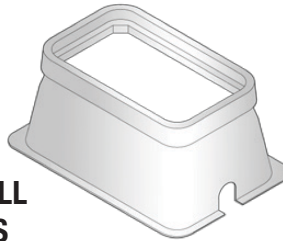

FLARED WALL FIBERGLASS

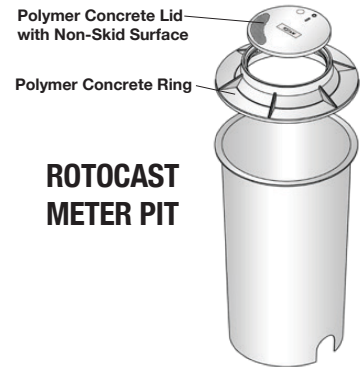

ROTOCAST METER PIT

PART#	WEIGHT	PART#	WEIGHT	PIT SIZE	PART#	WEIGHT
---	22 lbs.	---	---	20" DIA. x 36"	A6000201X36	20 lbs.
P6001921X12	30 lbs.	A6001923X12	25 lbs.	COVER		
P6000486	32 lbs.	---	---	12" DIA.	A6001996	7 lbs.
---	---	---	---	---	---	---
P6000485	32 lbs.	A6000485FRP	31 lbs.	---	---	---
P6001868X12	42 lbs.	A6001946X12	47 lbs.	---	---	---
---	---	---	---	---	---	---
P6001534X12	50 lbs.	A6001640X12	49 lbs.	---	---	---
P6001534X18	42/49 lbs.	A6001640X18	57 lbs.	---	---	---
---	---	---	---	---	---	---
---	---	---	---	---	---	---
---	---	---	---	---	---	---
---	---	---	---	---	---	---

Armorcast Products Company reserves the right to update or discontinue product information at any time without notice.

www.armorcastprod.com

Tel: (818) 982-3600 Fax: (818) 982-7742

WATER METER VAULTS & COVERS



ARMORCAST PRODUCTS COMPANY

POLYMER CONCRETE VAULTS

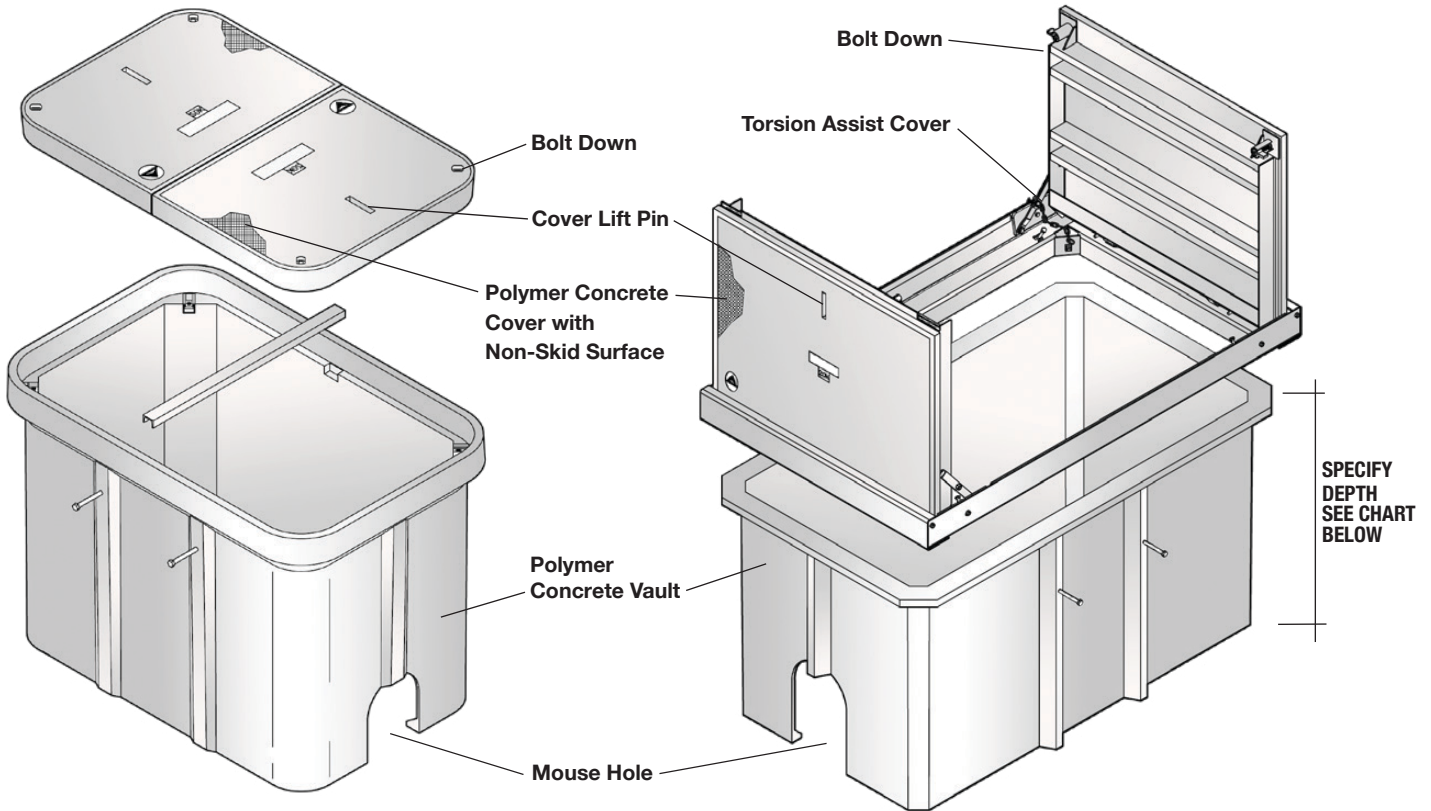

10K COVER POLYMER CONCRETE

10K TORSION COVER POLYMER CONCRETE

VAULT SIZE	PART#	WEIGHT	COVER	PART#	WEIGHT	COVER
30" x 60" x 36"	A6001460APCX36	670 lbs.	2 PIECE	---	---	---
36" x 60" x 36"	A6001436APCX36	815 lbs.	2 PIECE	A6001833AX36MT	990 lbs.	2 PIECE
44" x 60" x 30"	A6001925APCX30	750 lbs.	2 PIECE	---	---	---
48" x 48" x 36"	A6001433APCX36	750 lbs.	2 PIECE	---	---	---
48" x 60" x 36"	A6001447APCX36	1250 lbs.	2 PIECE	A6001447AP36MT	1200 lbs.	2 PIECE
48" x 72" x 48"	A6001506APCX48	1370 lbs.	2 PIECE	A6001506AP48MT	1425 lbs.	2 PIECE
48" x 96" x 48"	A6001449APCX48	1730 lbs.	3 PIECE	A6001449AP48MT	1990 lbs.	3 PIECE

20K COVER POLYMER CONCRETE

20K TORSION COVER POLYMER CONCRETE

VAULT SIZE	PART#	WEIGHT	COVER	PART#	WEIGHT	COVER
30" x 60" x 36"	A6001460TAPCX36	675 lbs.	2 PIECE	---	---	---
36" x 60" x 36"	A6001436TAPCX36	820 lbs.	2 PIECE	A6001833TAX36MT	990 lbs.	2 PIECE
44" x 60" x 30"	A6001925TAPCX30	755 lbs.	2 PIECE	---	---	---
48" x 48" x 36"	A6001433TAPCX36	755 lbs.	2 PIECE	---	---	---
48" x 60" x 36"	A6001447TAPCX36	1255 lbs.	2 PIECE	A6001447TAP36MT	1200 lbs.	2 PIECE
48" x 72" x 48"	A6001506TAPCX48	1375 lbs.	2 PIECE	A6001506TAP48MT	1425 lbs.	2 PIECE
48" x 96" x 48"	A6001449TAPCX48	1740 lbs.	3 PIECE	A6001449TAP48MT	1990 lbs.	3 PIECE

Contact an Armorcast representative for more information.

Aarmorcast Products Company reserves the right to update or discontinue product information at any time without notice.

www.armorcastprod.com

Tel: (818) 982-3600 Fax: (818) 982-7742



ARMORCAST PRODUCTS COMPANY

WATER METER VAULTS & COVERS

FIBERGLASS VAULTS

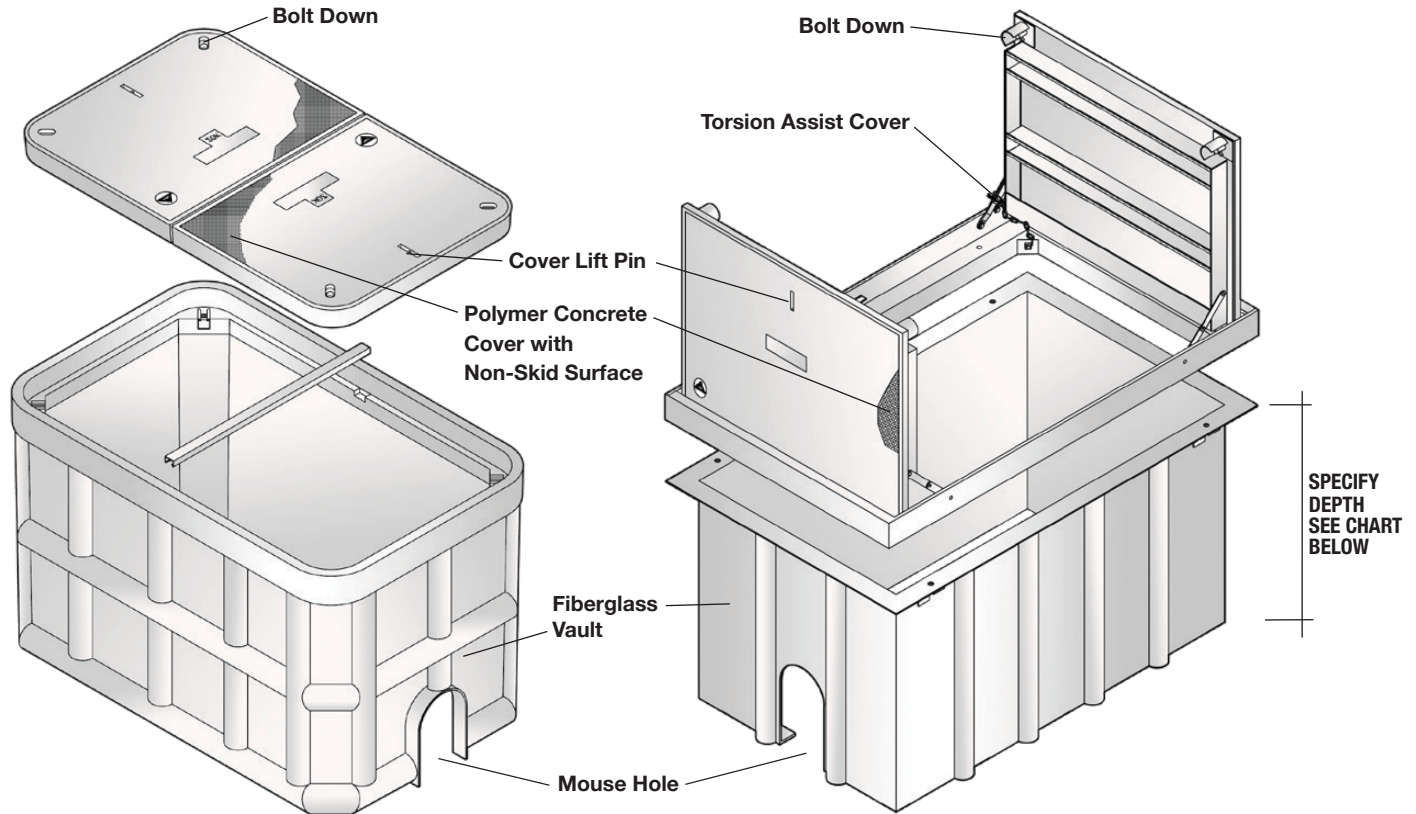

STANDARD COVER FIBERGLASS

TORSION COVER FIBERGLASS

VAULT SIZE	10K PART#	20K PART#	COVER	10K PART#	20K PART#	COVER
24" x 36" x Specify	A6001509AX	A6001509TAX	1 PIECE	---	---	---
30" x 48" x Specify	A6001430AX	A6001430TAX	1 PIECE	A6001430AX_MT	A6001430TAX_MT	1 PIECE
30" x 60" x Specify	A6001460AX	A6001460TAX	2 PIECE	A6001460AX_MT	A6001460TAX_MT	2 PIECE
36" x 36" x Specify	A6001441AX	A6001441TAX	2 PIECE	---	---	---
36" x 60" x Specify	A6001436AX	A6001436TAX	2 PIECE	---	---	---
36" x 72" x Specify	A6001491AX	A6001491TAX	2 PIECE	---	---	---
48" x 48" x Specify	A6001440AX	A6001440TAX	2 PIECE	A6001440AX_MT	A6001440TAX_MT	2 PIECE
48" x 60" x Specify	A6001447AX	A6001447TAX	2 PIECE	A6001447AX_MT	A6001447TAX_MT	2 PIECE
48" x 72" x Specify	A6001506AX	A6001506TAX	2 PIECE	A6001506AX_MT	A6001506TAX_MT	2 PIECE
48" x 78" x Specify	A6001448AX	A6001448TAX	2 PIECE	A6001448AX_MT	A6001448TAX_MT	2 PIECE
48" x 96" x Specify	A6001449AX	A6001449TAX	3 PIECE	A6001449AX_MT	A6001449TAX_MT	3 PIECE

WHEN ORDERING PLEASE SPECIFY DEPTH

WHEN ORDERING PLEASE SPECIFY DEPTH AFTER "X"

Contact an Armorcast representative for more information.

EXAMPLE: A6001430TAX48MT

Armorcast Products Company reserves the right to update or discontinue product information at any time without notice.

www.armorcastprod.com

Tel: (818) 982-3600 Fax: (818) 982-7742

ROUND ENCLOSURES

AIR VACUUM VALVE ENCLOSURES



ARMORCAST PRODUCTS COMPANY **POLYMER CONCRETE**

FEATURES

Armorcast Products Air Vacuum Valve Enclosures are manufactured from low density polyethylene material with UV inhibitors for commercial or residential settings. They are maintenance free, graffiti resistant, sturdy, lightweight, high impact resistance and has outstanding weatherability. Mounting frame is designed for easy removal to facilitate entry to those particular valves that may require frequent access. Aesthetically pleasing finishes include Sandstone, Granite, Light and Dark Green, additional colors are available.

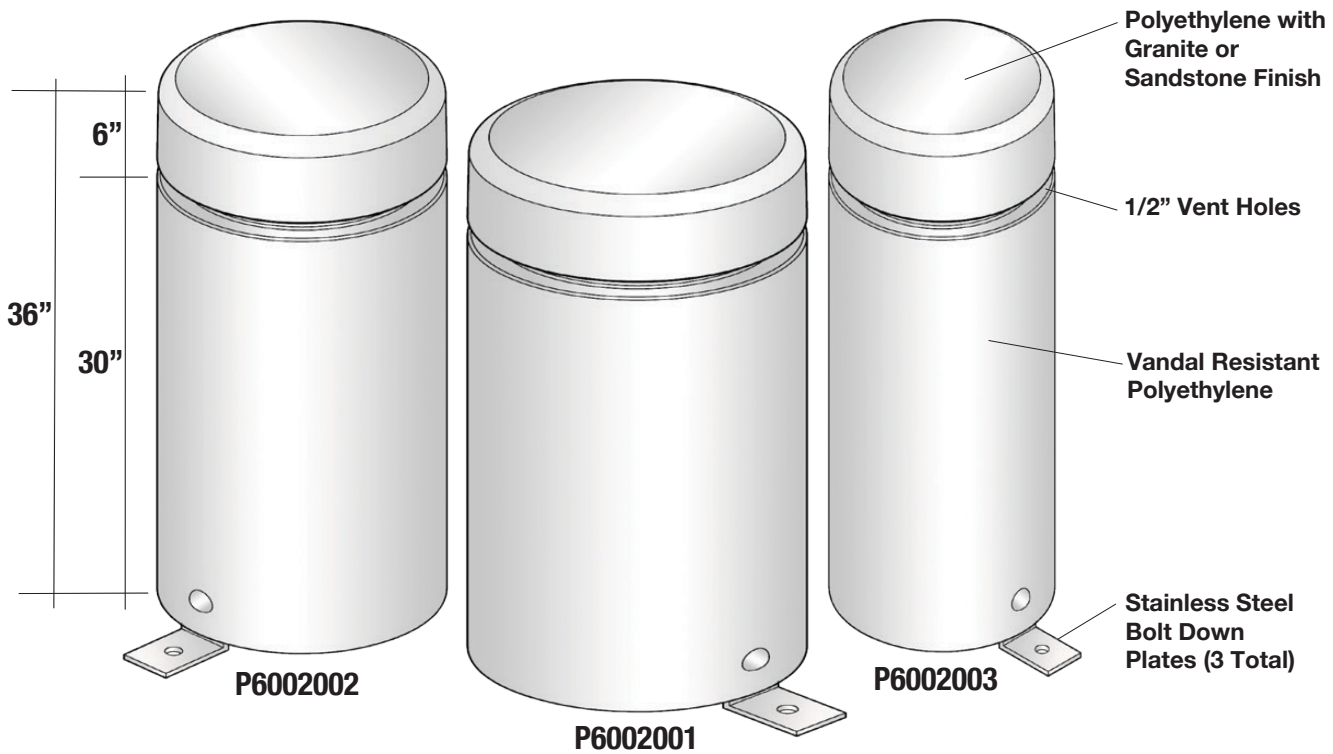

AIR VACUUM VALVE ROUND VENT ENCLOSURES

DESCRIPTION	NOMINAL SIZE W x H	PART NUMBER	APPROX. WEIGHT	PALLET QTY.
Round Enclosure	24" DIA. x 36" with 18- 1/2" Vent Holes	P6002001	40 lbs.	6
Round Enclosure	20" DIA. x 36" with 14- 1/2" Vent Holes	P6002002	25 lbs.	6
Round Enclosure	12" DIA. x 36" with 10- 1/2" Vent Holes	P6002003	15 lbs.	9

Contact an Armorcast representative for more information.

Armorcast Products Company reserves the right to update or discontinue product information at any time without notice.

www.armorcastprod.com Tel: (818) 982-3600 Fax: (818) 982-7742



ARMORCAST PRODUCTS COMPANY

ROUND ENCLOSURES WATER SAMPLING STATION

POLYETHYLENE

FEATURES

Sampling Stations are manufactured from low density polyethylene material with UV inhibitors for commercial or residential settings. Easy access, safe sampling and non-corrosive. They are maintenance free, graffiti resistant, sturdy, lightweight, high impact resistance with outstanding weatherability. Aesthetically pleasing finishes include Sandstone and Granite, additional colors are available.

OPTIONAL ITEMS INCLUDE: Sampling Bibb, Directional Flow Flush Valve.

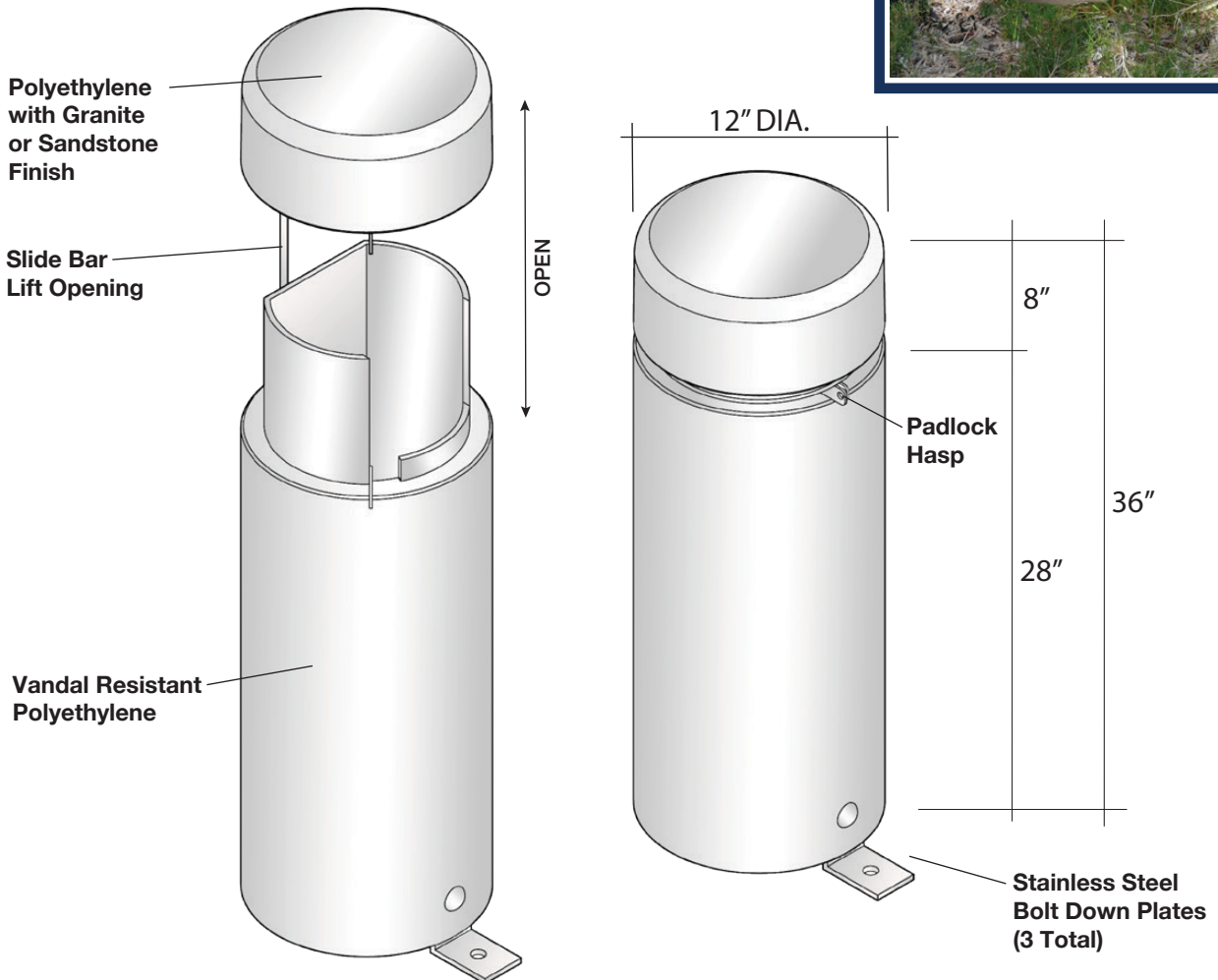

12" x 36" WATER SAMPLING STATION

DESCRIPTION	NOMINAL SIZE W x H	PART NUMBER	APPROX. WEIGHT	PALLET QTY.
Round Enclosure	12" DIA. x 36"	P6002010	15 lbs.	9

Contact an Armorcast representative for more information.

Armorcast Products Company reserves the right to update or discontinue product information at any time without notice.

www.armorcastprod.com

Tel: (818) 982-3600 Fax: (818) 982-7742



ARMORCAST®
WATER UTILITY PRODUCTS

MADE IN THE U.S.A.



ARMORCAST PRODUCTS COMPANY

13230 Saticoy Street, North Hollywood, Ca 91605 Tel: (818) 982-3600 Fax: (818) 982-7742 www.armorcastprod.com