

# Deck Mounted Faucets Installation Instructions

Recommended for base numbers 50, 50T, 51, 51T, 333, 335, 349, 350, 525, 526, 527, 700, 701, 730, 797, 802, 891, 894, 895, 929, 930, 931, 1100, 1102, 1891, 1895, and LWM Series Centerset and Single Basin Fittings, Pop-Up Drain Installation and Rigid/Swing Convertible Spout Installation.

## Overview

Chicago Faucets deck mounted faucets feature cast brass bodies and precision cartridges for years of reliable operation. Metering models with adjustable cycle time offer true water savings.

## Notice to the Installer

- Read this entire instruction sheet before installing to ensure proper installation.
- Installation must comply with local codes and ordinances.
- For fittings installed with pre-rinse or glass filler valves, check valves must be installed to prevent crossflow.

Pressurized plumbing fixtures shall be installed in accordance with manufacturer's recommendations. The supply piping to these devices shall be securely anchored to the building structure to prevent installed device from unnecessary movement when operated by the user. Care shall be exercised when installing the device to prevent marring the exposed surface.

NOTE: The information in this manual is subject to change without notice.

Please leave this manual with the facility manager after completing the faucet installation. This document contains information necessary for routine maintenance and servicing.

NOTE: Before installation, turn off water supplies to existing faucet and remove faucet if replacing. Clean faucet basin and clear away debris. Flush all supply lines before connecting to faucet. Failure to do so can result in debris clogging the inlets and/or cartridges.



## Single Hole Mixing Fittings — Base numbers 50, 50T, 51, 51T

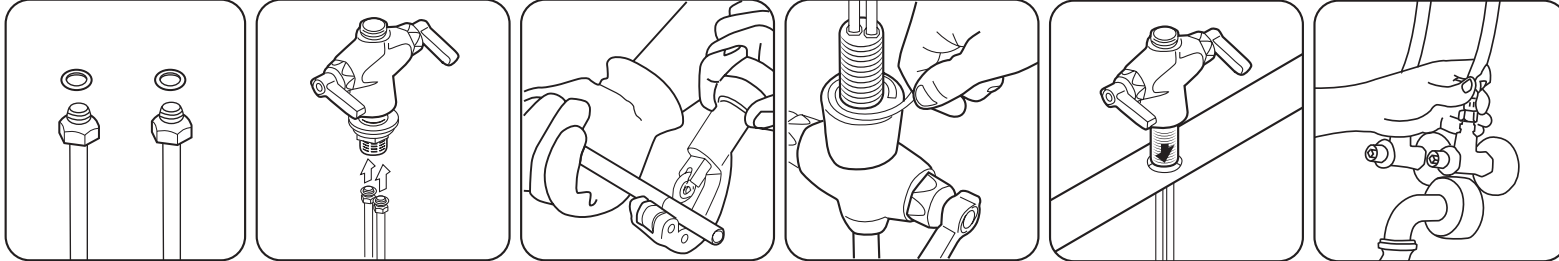

1. Ensure O-Rings are installed on hoses or tubes.
2. Install hoses or tubes.
- Copper Tube Installation**  
2b. Cut tubes to desired length.
3. Apply putty to underside of faucet body to assure a good seal and level fit.
4. Place shank through hole in sink and assemble mounting hardware.
5. Attach hoses or tubes to supply stops. Make sure gasket is installed.

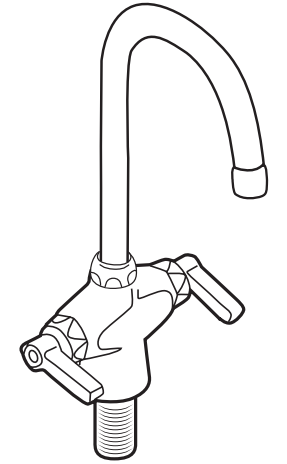

## Mixing Tee Installation

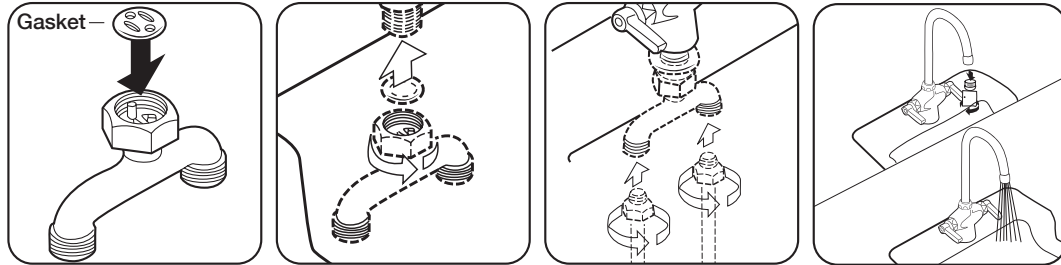

1. Install tee gasket over guide pins and secure coupling nut of tee to body shank.
2. Secure coupling nut of tee to body shank. Tighten securely.
3. Attach supply lines with coupling nuts. Tighten securely.
4. Remove outlet and flush lines for about one minute. Replace outlet.

## Centerset and Single Basin Fittings — Base numbers 333, 335, 349, 350, 525, 526, 527, 700, 701, 730, 797, 802, 891, 894, 895, 1100, 1102, 1891, 1895

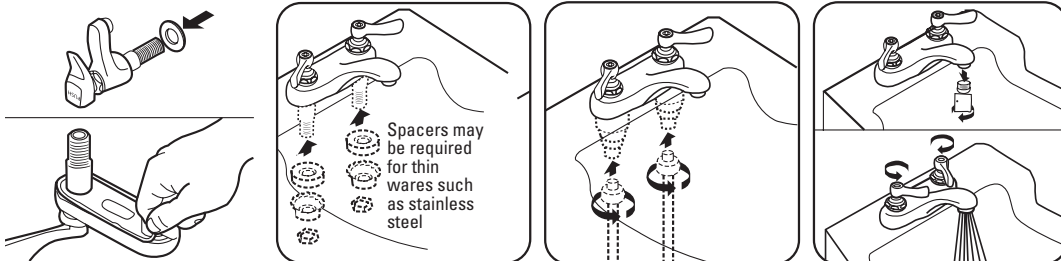

1. Apply putty or rubber washer to underside of faucet body to assure a good seal and level fit.
2. Place shank(s) through holes in sink and assemble mounting hardware. Use spacers if necessary.
3. Attach supply lines with coupling nuts and tighten securely. Attach spout if provided separately.
4. Remove outlet and flush lines for about one minute. Replace outlet.

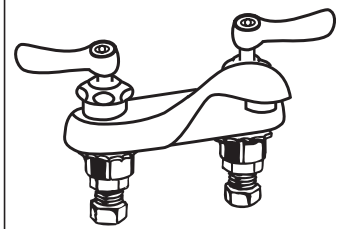

## Pop-Up Drain Installation

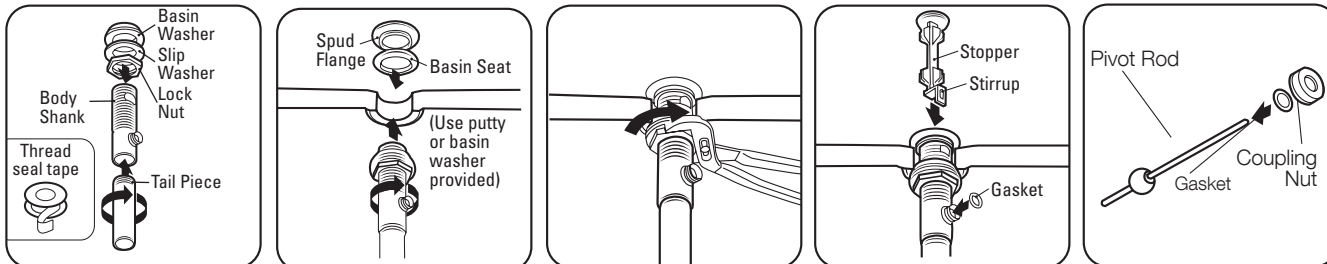

1. Assemble tail piece to body shank with thread seal tape. Assemble lock nut, slip washer, and basin washer to body shank.
2. Fully assemble the basin seat and spud flange to body shank assembly. (Use putty or basin washer provided)
3. Position body shank toward the lift rod. Tighten lock nut until properly sealed.
4. Place stopper into body shank cavity orienting the stirrup for removable or non-removable stopper as desired. (see #6)
5. Insert pivot ball rod assembly through pivot rod gasket and coupling nut.

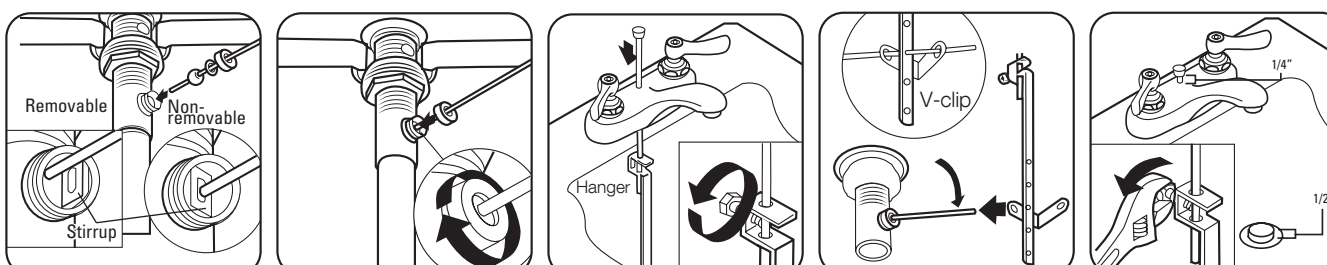

6. Attach pivot rod assembly to body shank.
7. Tighten pivot rod assembly nut as required to seal and provide smooth operation.
8. Insert pop up rod through holes in hanger and hand tighten.
9. Push pivot ball rod to lowest position, squeeze v-clip and slide pivot ball rod through v-clip and appropriate hole in hanger.
10. Test the assembly for proper function and make adjustments as necessary. Once set, tighten securely.

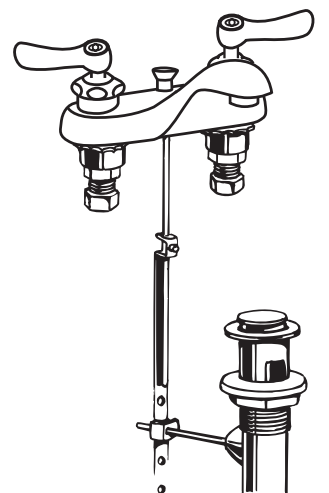

# Deck Mounted Faucets Installation Instructions

(continued)

## Rigid/Swing Convertible Spout Installation

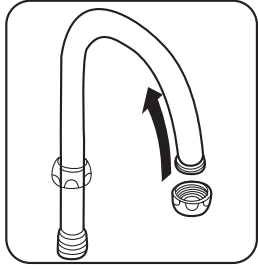

1. Remove outlet and assemble spout nut over outlet end, until it rests on shoulder of spout joint.

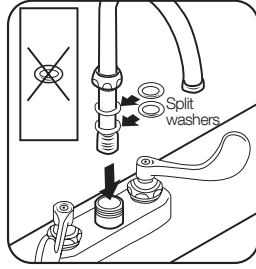

- For Swing Spouts**
- 2a. Assemble two plastic split washers to spout joint and discard 1/8" thick plastic washer.

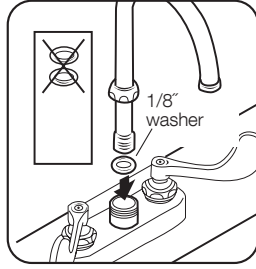

- For Rigid Spouts Only**
- 2b. Place 1/8" thick plastic washer into spout base bore and discard plastic split washers.

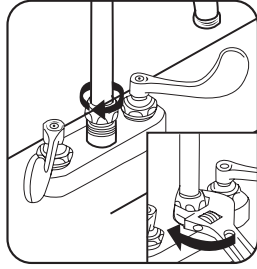

3. Insert spout assembly firmly into spout base and tighten spout nut.

Chicago Faucets deck mounted faucets come with cartridges already installed. Instructions for adjusting the timing on metering cartridges are shown below. For complete instructions on servicing and replacing Chicago Faucets cartridges, see our Cartridge Maintenance/Repair Guide, available online at [chicagofaucets.com/pdf/CF1081.pdf](http://chicagofaucets.com/pdf/CF1081.pdf). You may also order a copy of the Guide by calling 800-832-8783.

## Supplemental Bubbler Installation Instructions for 748-665CP, 748-665FHCP, 748-244CP and 748-244FHCP

### Installation with Anti-Rotational Pins (Figure A)

1. Choose Two holes in bubbler base that corresponds with the deck/sink drilling and tap each anti-rotational pin with a hammer until seated. There should be approximately 1/8" length of pin exposed when fully seated.
2. Drill 3/16" diameter holes on 1-9/32" centers and 1/4" deep in the deck/sink for anti-rotational pins if mounting holes are not provided.
3. Attach Bubbler to deck using the anti-rotational washer provided.

### Flow Adjustments (Figure B)

1. The projection of water flow can be adjusted by using the 1/8" hex wrench provided. Insert hex wrench and rotate control clockwise or counterclockwise until the desired flow is achieved.

Note: Bubblers have been designed to utilize the 722-013K inlet flow control. To insure proper performance, it is imperative that the 722-013K be installed with each bubbler.

## Timing Adjustment on an MVP Metering Cartridge

1. With cartridge and handle installed in body and water supply turned on, purge cartridge of air by pushing handle completely down 4-8 times repeatedly, then check timing cycle.
2. To change cycle time, remove index button, then handle using a 3/32" hex wrench. (Figure C)
3. Using your fingers, change height of adjustment nut by 1/4 turn only. Turn adjustment nut clockwise to increase cycle time or counter-clockwise to decrease cycle time. (Figure D)
4. If filter and lower valve cartridge have been removed from fitting, replace them by inserting filter first.
5. If gasket has been removed from the actuator assembly, replace it by inserting into bottom of actuator assembly.
6. Assemble actuator assembly to body and tighten to 12-15 ft-lbs torque.
7. Replace handle and verify desired cycle time. NOTE: TIMING MUST BE CHECKED WITH HANDLE IN PLACE.
8. If additional adjustment is necessary, repeat steps 3 through 7 until desired cycle time is achieved.  
Note: Some new installations might produce a slight closing noise. This is normally the result of air trapped in the cartridge. The noise will dissipate over time.
9. Attach handle and tighten set screw with a 3/32" hex wrench. If index button is included, snap into handle.

## Timing Adjustment on Push-Button (NAIAD) & Tip-Tap Self-Closing Cartridges

1. Turn off water supply.
2. Remove cartridge from valve body with 1-1/4" flat hex wrench. Use care to prevent damage to cap hex nut.
3. Locate timing hex nut on bottom of dashpot. Turn hex nut clockwise to increase cycle time or counter-clockwise to decrease cycle time (Figure E). NOTE: Turn in 90 degree increments for each adjustment cycle. Fill the dashpot with water, slide it over the bottom of the cartridge, and place both back into the faucet body.
4. Place cartridge into faucet body and fully tighten cap nut with wrench to 15-25 ft-lbs torque. Turn on water and verify cycle time by depressing cartridge fully.  
NOTE: Insure that cap gasket is in place within cap before assembly into valve body.

NOTE: Cartridges with 'SLO' designation include an external timing adjustment via a set screw in the top of the handle. Using a 7/64" hex wrench, turn the set screw clockwise to decrease cycle time or counter-clockwise to increase cycle time. (Figure F)

## Timing Adjustment on a Push-Tilt Self-Closing Cartridge

For Push-Tilt cartridges, the timing adjustment procedure is identical to Push-Button Self-Closing Cartridges, except for an external timing adjustment feature that is integral to Push-Tilt handles. This adjustment can be used for minor cycle time changes without the need to remove the cartridge from the body.

For external adjustment, lift handle slightly to expose 1/16" hex socket set screw (Figure F). Turn adjustment set screw clockwise to increase cycle time or counter-clockwise to decrease cycle time. If greater timing adjustment is required, follow the instructions for adjusting the timing on a Push-Button Self-Closing Cartridge.

## RGD1 and RGD2 Only Spout Installation

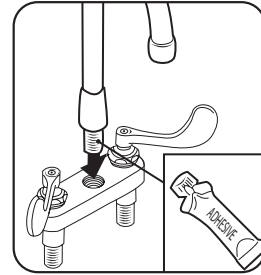

1. Apply Loctite 680, Permabond HH-040 anaerobic sealant, or equivalent NSF 61 approved sealant to threads of spout and tighten spout into base. Back off as necessary for centered position.

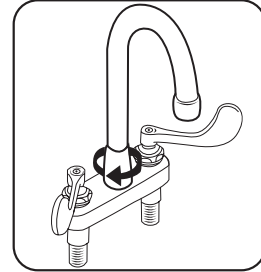

2. Hand tighten sleeve until flush with body.

## FIGURE A

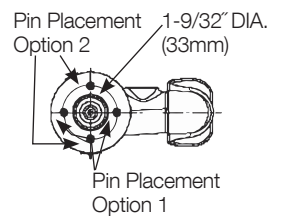

## FIGURE B

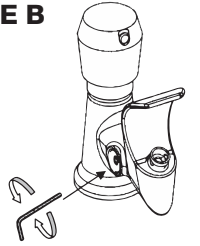

## FIGURE C

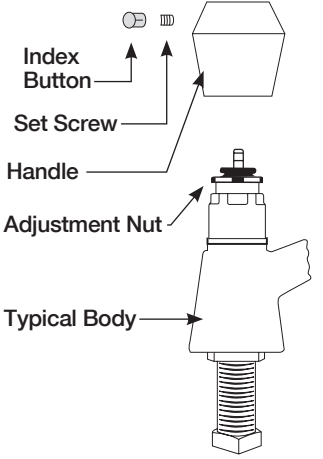

## FIGURE D

How To Adjust (Top View)

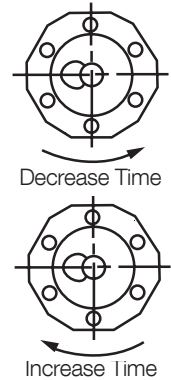

## FIGURE E

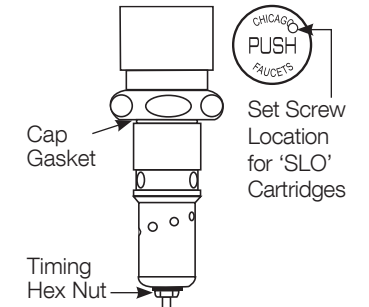

## FIGURE F

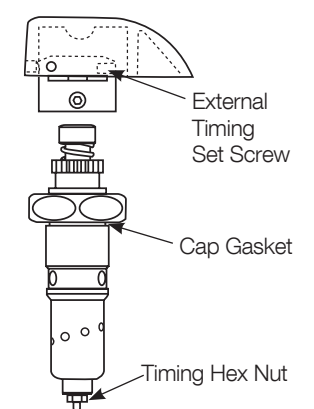

## Care and Maintenance

All Chicago Faucets fittings are designed and engineered to meet or exceed industry performance standards. Care should be taken when cleaning this product. Do not use abrasive cleaners, chemicals or solvents as they can result in surface damage. Use mild soap with warm water for cleaning and protecting the surface of Chicago Faucets fittings.

For additional technical assistance, call 800/TEC-TRUE (800-832-8783) or visit our website at [chicagofaucets.com](http://chicagofaucets.com).

## CHICAGO FAUCETS LIMITED WARRANTY

**TO WHOM DOES THIS WARRANTY APPLY?** — The Company extends the following limited warranty to the original user only.

**WHAT DOES THIS WARRANTY COVER AND HOW LONG DOES IT LAST?**

This warranty covers the following Commercial Products:

**LIFETIME FAUCET WARRANTY** — The "Faucet," defined as any metal cast, forged, stamped or formed portion of the Product, not including electronic or moving parts or other products separately covered by this Limited Warranty or water restricting components or other components, is warranted against material manufacturing defects for the life of the Product.

**FIVE YEAR FAUCET WARRANTY** — Certain Products and portions of the Product are warranted against material manufacturing defects for a period of five (5) years from the date of Product purchase. Products warranted against material manufacturing defects for a period of five (5) years from the date of Product purchase are referred to by the product numbers 42X, 43X, 15XX and E-Tronic® - 4X, 5X, 6X, 7X, 8X and 9X. All zinc die cast portions of Product are warranted against material manufacturing defects for a period of five (5) years from the date of Product purchase.

**THREE YEAR ELECTRONICS WARRANTY** — Electronic components, including the solenoid, are warranted for three (3) years from the date of installation.

**FIVE YEAR CARTRIDGE WARRANTY** — The "Cartridge," defined as the metal portion of any Product typically referred to by the product numbers containing 1-099, 1-100, 377X, 217X and 274X, excluding any rubber or plastic components, is warranted against material manufacturing defects for a period of five (5) years from the date of Product purchase. All Cartridges included in the Company's Single Control or Shower Products also are warranted against material manufacturing defects for a period of five (5) years from the date of Product purchase.

**ONE YEAR FINISH WARRANTY - COMMERCIAL** — For Products used in commercial applications, the finish of the Product is warranted against material manufacturing defects for a period of one (1) year from the date of Product purchase.

**OTHER WARRANTIES** — All other Products not covered above are warranted against material manufacturing defects for a period of one (1) year from the date of Product purchase.

Other restrictions and limitations apply. For complete warranty details, call Chicago Faucets Customer Service at 847-803-5000 or visit [chicagofaucets.com](http://chicagofaucets.com).

The Chicago Faucet Company  
2100 South Clearwater Drive  
Des Plaines, IL 60018  
Phone: 847/803-5000  
Fax: 847/849-1845  
Technical: 800/832-8783  
[www.chicagofaucets.com](http://www.chicagofaucets.com)