

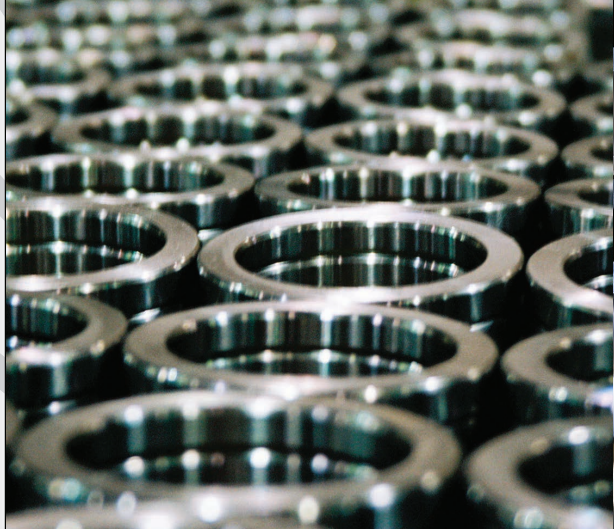

GASKET & FASTENER HANDBOOK

A TECHNICAL GUIDE TO
GASKETING & BOLTED FLANGES



Sealing Global - Servicing Local

ABOUT LAMONS

Lamons is one of the largest gasket and bolt suppliers in the world, committed to quality and local service. We have 6 manufacturing and 21 sales and services branches positioned all around the world combined with many licensees and distributors.

We are strategically located to provide customers with the widest selection of gasket materials and fastener stock ready for immediate delivery. Lamons' various locations feature leading technology and state of the art manufacturing facilities capable of producing engineered products to custom specifications serving the refining, chemical, power generation, offshore, subsea, petrochemical (upstream and downstream), and pulp and paper industries, among others.



www.lamons.com

TABLE OF CONTENTS

INTRODUCTION	
Why Gaskets are Used • Effecting A Seal • Gasket Seating Flange Types • Flange Finish • Material Considerations	5
CHAPTER 1: GASKET SELECTION	
SECTION 1: NON-METALLIC GASKETS	
Elastomers	17
PTFE Products	19
Compressed Non-Asbestos	23
High Temperature Sheet Products	38
Soft Gasket Dimensions	39
SECTION 2: SEMI-METALLIC GASKETS	
CorruKamm™ Gaskets & Dimensions	51
Kammprofile™ Gaskets & Dimensions	53
Spiral Wound Gaskets & Dimensions	65
Corrugated Metal Gaskets & Dimensions	105
Metal / Double Jacketed Gaskets & Dimensions	109
SECTION 3: METALLIC GASKETS	
Ring Joints & Dimensions	115
Lens Ring Dimensions	126
Specialty Machined Products	127
SECTION 4: ISO TEK™ ISOLATION GASKETS & KITS	
Defender™ Sealing - Isolating Gasket	128
Defender™ FS Sealing - Isolating Gasket	131
IsoGuard™ Sealing - Isolating Gasket	136
IsoMate™ Sealing - Isolating Gasket	139
Sleeves and Washers	141
Installation • Torque Values • Suggested Media	145
CHAPTER 2: GASKET INSTALLATION	
Installation and Bolting Practices	153
Bolt Torque Sequence	160
Trouble Shooting Leaking Joints	165
CHAPTER 3: TECHNICAL & DESIGN	
ASME Section VIII, Design Consideration for Bolted Flange Connections	169
Bolt Load Formulas	172
Notation Symbols and Definitions	173
Common Metals Description	177
Bolt Reference Charts for ASME B16.5 Flanges	180
Bolt Reference Charts for ASME B16.47 A and B Flanges	182
Torque Chart	184
CHAPTER 4: APPENDIX	
Chemical Resistance • Galvanic Corrosion • Temperature Conversion Hardness Conversion • Pipe Dimensions & Weights • Circumferences & Areas of Circles • Fastener Details	187

INTRO

GASKET
SELECTION

GASKET
INSTALLATION

TECHNICAL
& DESIGN

APPENDIX

Lamons Gasket Company makes no expressed or implied warranty or representation whatsoever concerning the statements and information set forth in this handbook and expressly disclaims any liability for direct, incidental or consequential damages arising from injury to persons or products resulting directly or indirectly from the use of, or reliance upon, any statement or information set forth in this handbook.

The content of this handbook is the property of Lamons Gasket Company and is not to be reproduced in any form without permission of Lamons.

LAMONS IS A COMPANY OF  TriMas

Revision February 2016

The cost of leaky joints in industry today is staggering. Out-of-pocket costs run into billions of dollars annually in lost production, waste of energy, loss of product and, most recently, impact on the environment. These problems are increasing, not decreasing. It behooves all of us to consolidate our knowledge and experience to solve or at least minimize these problems. This publication is being produced because we, as gasket and fastener manufacturers and suppliers, are constantly called upon to solve sealing problems after the fact. Too often we find insufficient time and attention has been given to:

- Proper design of flanged joint;
- Installation procedures; and,
- Selection of the optimum gasket material required to solve a particular sealing problem.

We will endeavor to outline in this publication those areas we believe to be essential in a properly designed, installed and maintained gasketed joint.

We believe most people involved with the design, installation, and maintenance of gasketed joints realize that no such thing as “zero” leakage can be achieved. Whether or not a joint is “tight” depends on the sophistication of the methods used to measure leakage. In certain applications the degree of leakage may be perfectly acceptable if one drop of water per minute is noted at the gasketed joint. Another requirement is that no bubbles would be observed if the gasketed joint was subjected to an air or gas test underwater. A still more stringent inspection would require passing a mass spectrometer test. The rigidity of any test method would be determined by:

- The hazard of the material being confined;
- Loss of critical materials in a process flow;
- Impact on the environment should a particular fluid escape into the atmosphere; and,
- Danger of fire or of personal injury.

All of these factors dictate proper attention must be given to:

- Design of flange joints or closures;
- Proper selection of gasket type;
- Proper gasket material; and,
- Proper installation procedures.

Care in these areas will ensure that the best technology and planning goes into the total package and will minimize operating costs, pollution of the environment and hazards to employees and the general public.

WHY GASKETS ARE USED

Gaskets are used to create a static seal between two stationary members of a mechanical assembly and to maintain that seal under operating conditions, which may vary dependent upon changes in pressures and temperatures. If it were possible to have perfectly mated flanges and if it were possible to maintain an intimate contact of these perfectly mated flanges throughout the extremes of operating conditions, a gasket would not be required.

This is virtually impossible either because of:

- The size of the vessel and/or the flanges;
- The difficulty in maintaining such extremely smooth flange finishes during handling and assembly;
- Corrosion and erosion of the flange surface during operations; and,
- The sheer number of flanged joints in a typical industrial setting, and commercial implications.

As a consequence, relatively inexpensive gaskets are used to provide the sealing element in these mechanical assemblies. In most cases, the gasket provides a seal by utilizing external forces to flow the gasket material into the imperfections between the mating surfaces. It follows then that in a properly designed gasket closure, three major considerations must be taken into account in order for a satisfactory seal to be achieved.

- Sufficient force must be available to initially seat the gasket. Stated this way, adequate means must be provided to flow the gasket into the imperfections in the gasket seating surfaces.
- Sufficient forces must be available to maintain a residual stress on the gasket under operating conditions to ensure that the gasket will be in continuous intimate contact with the gasket seating surfaces to prevent leakage.
- The selection of the gasket material must be such that it will withstand the pressures exerted against the gasket, satisfactorily resist the entire temperature range to which the closure will be exposed and withstand corrosive attack of the confined medium.

EFFECTING A SEAL

A seal is effected by compressing the gasket material and causing it to flow into the imperfections on the gasket seating surfaces so that intimate contact is made between the gasket and the seating surfaces.

There are four different methods that may be used either singly or in combination to achieve this unbroken barrier:

1. Compression

This is the most common method of effecting a seal on a flange joint and the compression force is normally applied by bolting;

2. Attrition

Is a combination of a dragging action combined with compression, such as in a spark plug gasket where the spark plug is turned down on a gasket that is both compressed and screwed in to the flange;

3. Heat

An example is the case of sealing a ball and valve joint on cast iron pipe by means of molten lead. Molten lead is poured, then is tamped into place using a tamping tool and a hammer; and,

4. Gasket Lip Expansion

This is a phenomenon that would occur due to edge swelling when the gasket would be affected by confined fluid. Elastomeric compounds affected by confined fluids, such

as solvents, cause the gasket material to swell and increase the interaction of the gasket against the flange faces.

Generally, gaskets are called upon to effect a seal across the faces of contact with the flanges. Permeation of the media through the body of the gasket is also a possibility depending on material, confined media, and acceptable leakage rate.

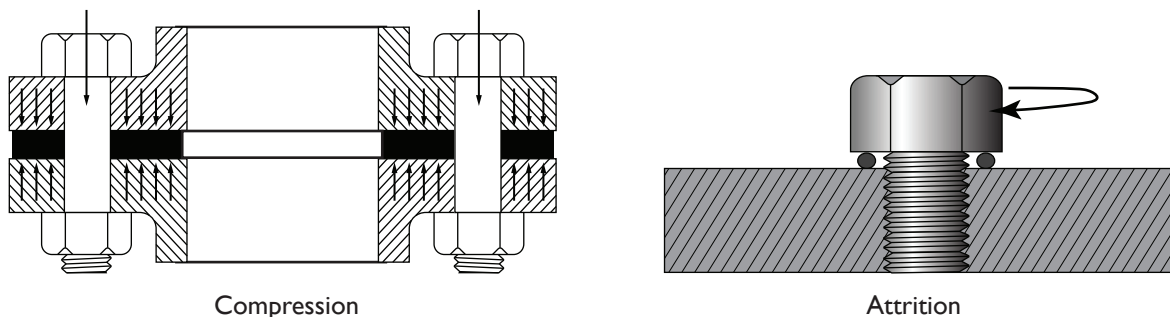

GASKET SEATING

There are two major factors to be considered with regard to gasket seating:

First, the gasket itself. The ASME Unfired Pressure Vessel Code Section VIII, Division I defines minimum design seating stresses for a variety of gasket types and materials. These design seating stresses range from zero psi for so-called self-sealing gasket types such as low durometer elastomers and O-rings to 26,000 psi (179 MPa) to properly seat solid flat metal gaskets. Between these two extremes there is a multitude of types and materials available to the designer enabling them to make a selection based upon the specific operating conditions under investigation.

Second, the other major factor to take into consideration must be the surface finish of the gasket seating surface. As a general rule, it is necessary to have a relatively rough gasket seating surface for elastomeric and PTFE gaskets on the order of magnitude of 500 micro inches. Solid metal gaskets normally require a surface finish not rougher than 63 micro inches. Semi-metallic gaskets, such as spiral wound gaskets, fall between these two general types. The reason for the difference is that with non-metallic gaskets such as rubber, there must be sufficient roughness on the gasket seating surfaces to bite into the gasket, thereby preventing excessive extrusion and increasing resistance to gasket blowout. In the case of solid metal gaskets, extremely high unit loads are required to flow the gasket into imperfections on the gasket seating surfaces. This requires that the gasket seating surfaces be as smooth as possible to ensure an effective seal. Spiral wound gaskets require some surface roughness to prevent excessive radial slippage of the gasket under compression. The characteristics of the type of gasket being used dictate the proper flange surface finish that must be taken into consideration by the flange designer, and there is no such thing as a single optimum gasket surface finish for all types of gaskets. The problem of the proper finish for gasket seating surface is further complicated by the type of the flange design. For example, a totally enclosed facing such as tongue and groove will permit the use of a much smoother gasket seating surface than can be tolerated with a raised face.

FLANGE TYPES

A flange is used to join pipe, valves, or a vessel within a system. The most common flanges used in industrial applications follow. When applying gasket and sealing components to these flanges, the user must take into consideration sizing limitations, available clamp load, optimum surface finish, and gasket placement to minimize flange rotation. Pressure ratings for ASME standard flanges are classified by pressure class of 150, 300, 400, 600, 900, 1500 and 2500. The most common terminology used is the pound reference, although the more formal reference is by class, such as class 150 flange. ASME requires that each flange be stamped with

the manufacturer's name, nominal pipe size, pressure classification, flange facing, bore, material designation, ring gasket number (when using a ring type joint flange facing) and heat number or code.

RAISED FACE FLANGE

Raised Face flanges are the most common type used in industrial applications due to their versatility in gasket compatibility, robust construction that prevents flange rotation under load and the unitized design.

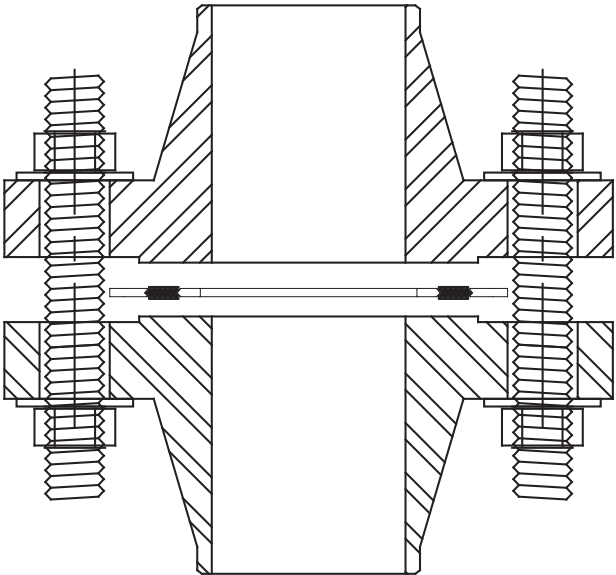

FLAT FACE FLANGE

Mating faces of both flanges are flat across the entire face both inside and outside the bolts. These unconfined gaskets require a mechanical stop to control compression height, such as a spiral wound gasket, should be designed with this consideration.

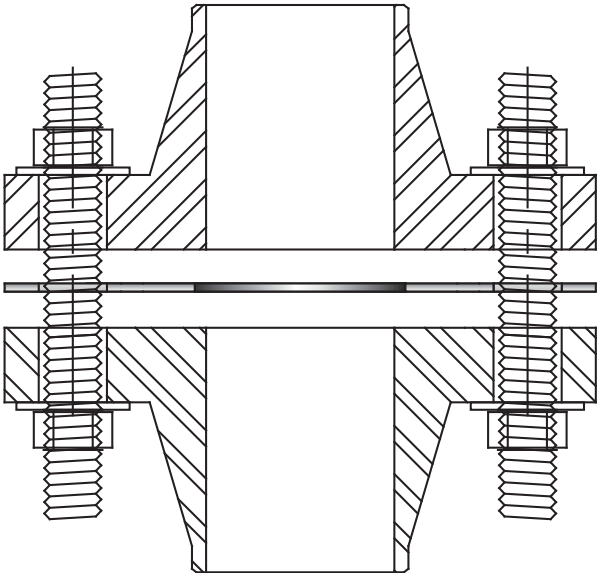

TONGUE AND GROOVE FLANGE

Compressibility characteristics of the confined design need to be taken into consideration when applying gaskets to this flange style to ensure flange surfaces do not meet and prevent over-compression on the gasket. The groove width is typically not wider than 1/16" (1.5 mm) over the tongue width to control gasket compression and creep relaxation due to gasket migration. The gasket dimensions will typically match the tongue dimensions.

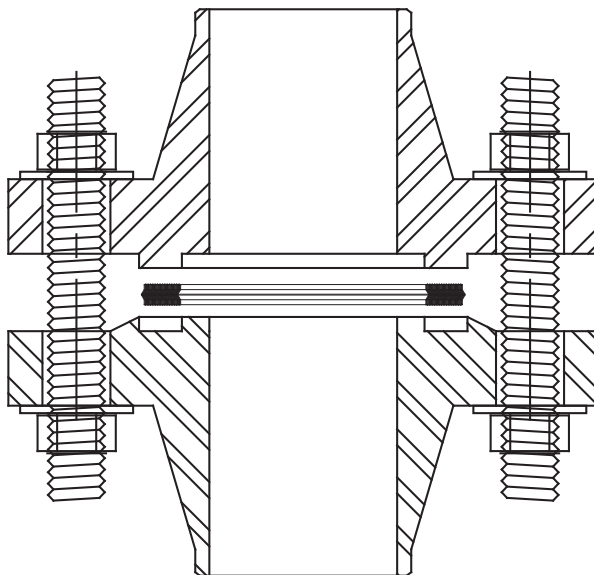

MALE - FEMALE OR RECESSED GROOVE FLANGE

Compressibility characteristics need to be taken into consideration when applying gaskets to this flange style to ensure flange surfaces do not meet and prevent over compression on the gasket.

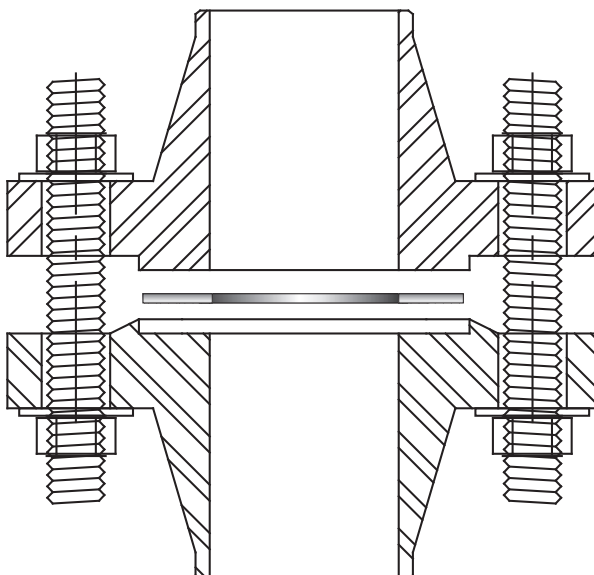

LAP JOINT AND SLIP ON FLANGE

A lap joint flange and slip on flange are very similar in that they are typically associated with non-critical applications and systems that require frequent dismantling for inspection. The slip on flange is bored slightly larger than the OD of the matching pipe. The pipe slips into the flange prior to welding both inside and outside to prevent leaks. The lap joint has a curved radius at the bore and face to accommodate a lap joint stub end.

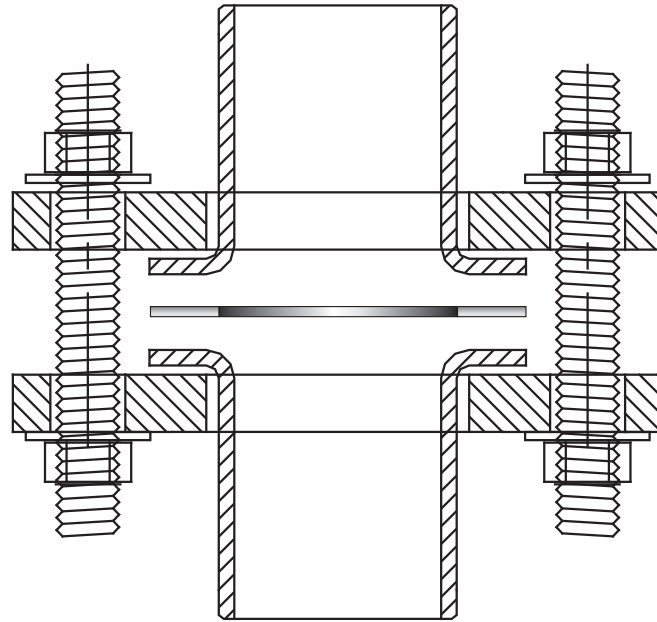

Lap Joint Flange

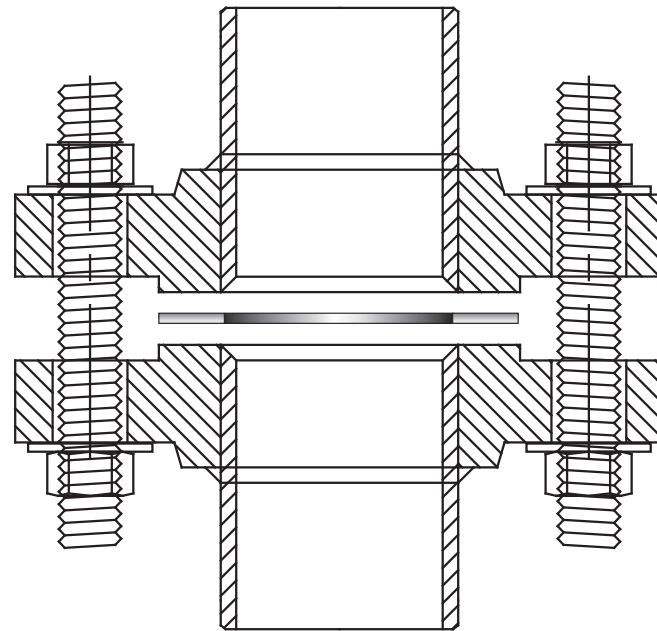

Slip On Flange

SOCKET WELDING FLANGE

The flange is similar to the slip on flange, except it has a bore and a counter bore. The counter bore is slightly larger than the OD of matching pipe, allowing the pipe to be inserted. A restriction is built into the bottom of the bore, which acts as a shoulder for the pipe to rest on, and has the same ID of the matching pipe. The flow is not restricted in any direction.

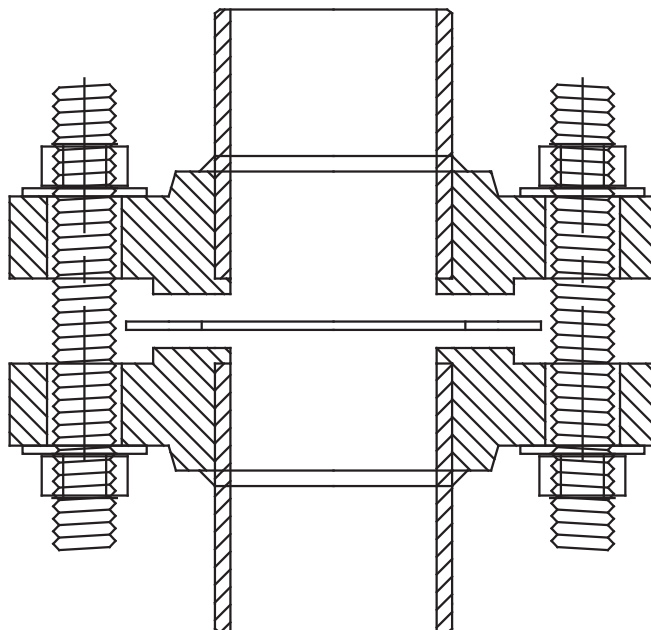

RING TYPE JOINT (RTJ)

Very often used for high pressure applications, ring type joints utilize octagonal or oval shaped ring gaskets that are ideally softer than the flange material. The gasket is confined in the joint, where surface finish is critical for the traditional metal to metal seal.

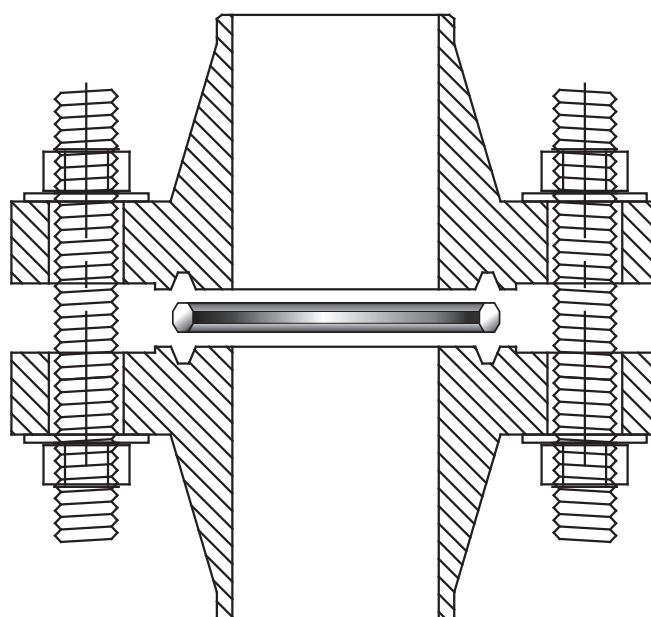

THE IMPACT OF FLANGE FINISH ON GASKET PERFORMANCE

A critical and fundamental aspect of sealing is the level of friction between the flange and gasket surfaces. The level of roughness characteristic of the flange faces can have a dramatic effect on gasket creep relaxation, blow out resistance and bolted joint tightness. Dependent upon the type of gasket that is being used in the connection, different surface finishes can be utilized to optimize gasket performance.

As a general rule, metal gaskets and those that have less conformable surfaces require a very smooth surface finish. Given the creep resistance and structural stability of most metal gaskets, the two mating surfaces can create a very tight and reliable seal. Alignment, parallelism and flange finish must be within specified limits in order to achieve an optimal result. Metal gaskets such as solid metal and jacketed designs offer very little forgiveness in regards to flange finish, and bolting and assembly deficiencies. A typical surface finish recommendation for these types of metal contact seals is 64 AARH/RMS or smoother.

Soft gaskets such as compressed fiber sheet, that are more compressible, can be more forgiving in regards to alignment and parallelism of the flange. However, these designs are more susceptible to creep relaxation and movement while under a load. The flange surface finish can play a critical role in the gasket's service life and long term reliability. A smooth surface finish will not create the necessary friction between these mating surfaces, allowing a non-reinforced gasket design to be more susceptible to creep under load. This creep would translate to a loss in bolted joint tightness and potential leakage. A rougher surface finish is generally recommended for soft, non-reinforced materials to create this necessary friction, which lends to stability and tightness between the mating surfaces. A typical surface finish recommendation for soft, non-reinforced materials is 125-250 AARH/RMS or rougher.

FLANGE FINISH DEFINITION AND COMMON TERMINOLOGY

Raised and flat flange facings are machined with serrations; serrations may be either phonographic or concentric. The industry standard is a phonographic serrated finish. The facing finish is judged by visual comparison with Roughness Average (Ra) standards. Ra is stated in microinches (μin) or micrometers (μm) and is shown as an Arithmetic Average Roughness Height (AARH) or Root Mean Square (RMS). AARH and RMS are different methods of calculation giving essentially the same result and are used interchangeably. The more common finishes are represented in the illustration below. Normally the manufacturer furnishes the "Stock Finish" unless the purchaser specifies otherwise.

Defined on following page, flanges are available in many different surface textures that can affect gasket performance.

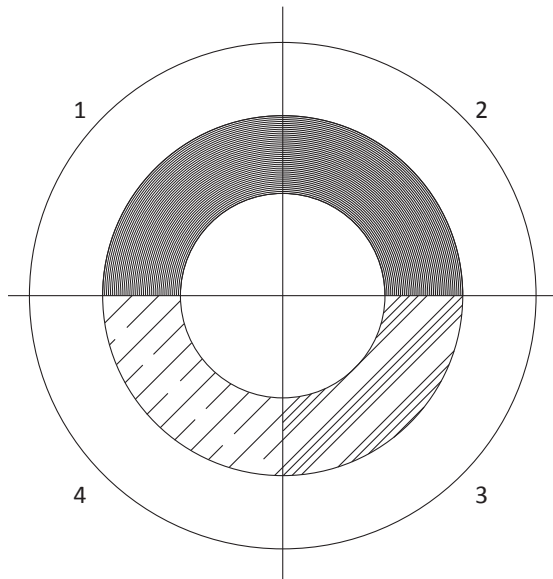

1. **Stock Finish:** This is a continuous spiral groove. Suitable for practically all ordinary service conditions, this is the most widely used of any gasket surface finish. The AARH/RMS microinch finish for this typically ranges from a 125 to 250 value. This finish is suitable for gaskets that have a soft conformable face. Under compression, the soft face will embed into this finish which helps create a seal. A high level of friction is generated between the mating surfaces due to this aspect. The stock finish for 12" (305 mm) and smaller flanges is generated by a 1/16" (1.59 mm) radius round nosed tool at a feed of 1/32" (0.79 mm) per revolution. For sizes above 12" (305 mm) the tool nose is 1/8" (3.17 mm) radius and the feed is 3/64" (1.19 mm) per revolution.
2. **Spiral Serrated:** This, too, is a continuous spiral groove but it differs from the stock finish in that the groove is generated using a 90 degree tool which creates a "V" geometry with 45 degree angled serration.
3. **Concentric Serrated:** (Not depicted) As the name suggests this finish is comprised of concentric grooves. A 90 degree tool is used and the serrations are spaced evenly across the face. This is a non-standard custom finish which must be specified.
4. **Smooth Finish:** This finish show no definite signs of tool markings apparent to the naked eye. These finishes are typically utilized for gaskets with metal facings such as double jacketed flat steel. The smooth surfaces mate to create a seal and depend on the flatness of the opposing faces to effect a seal. AARH/RMS Microinch finish values are typically better than a 64 value.
5. **Lapped Finish (Cold Water Finish):** Produced by using a wide tool at high speeds, this finish is equivalent to a ground surface. It is mirror like in appearance. Surfaces such as this are typically intended to be used without a gasket.

The concepts of surface roughness, waviness, and lay are illustrated schematically below.

RMS microinch value is defined as the root mean square (square root of the mean square) of an infinite series of distances measured in microinches from the hypothetical nominal or mean surface line to the actual irregular surface contour. For all practical purposes, the RMS microinch value is a weighted average unit of surface roughness that is affected to a greater extent by the highest and lowest deviation from the nominal surface that is by the minor deviation. AARH is calculated by obtaining the average roughness height of the irregular surface.

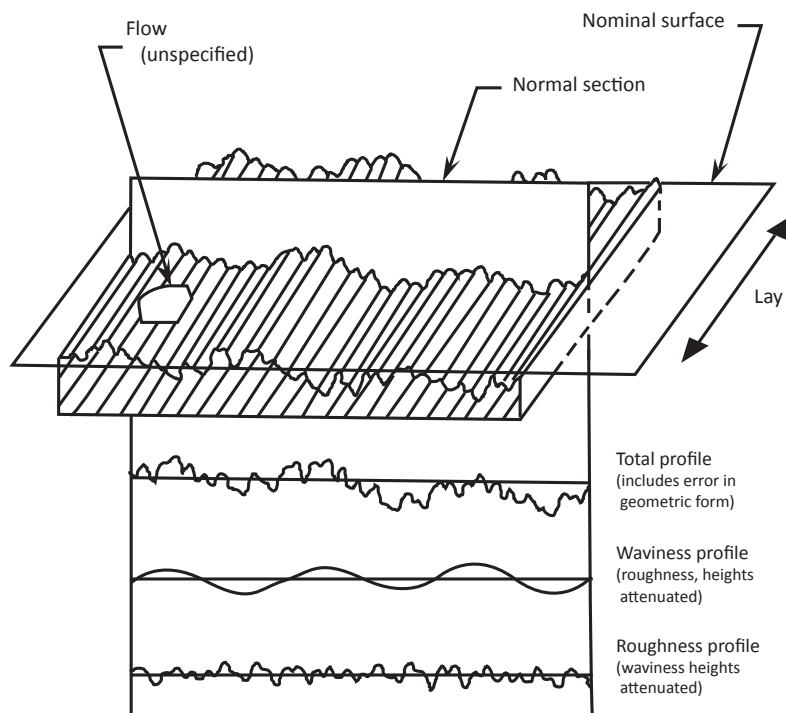

MEAN ROUGHNESS

Arithmetical mean deviation (R_a) Root-mean-square deviation (R_q)

$$R_a = \frac{1}{n} \left(\sum_{i=1}^n |y(x_i) - \bar{y}| \right), \forall x \in \mathbb{R}$$

$$R_q = \sqrt{\frac{1}{n} \left(\sum_{i=1}^n (y(x_i) - \bar{y})^2 \right)}, \forall x \in \mathbb{R}$$

$$\bar{y} = \frac{1}{n} \sum y(x) = \text{mean of the distribution (average)}$$

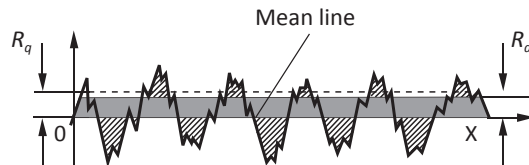

Calculations for statistical parameters of profilometry data.
One microinch equals one millionth of an inch (0.000001”).

MATERIAL CONSIDERATIONS

A most important factor in selecting the proper gasket is selecting the suitable material that will be compatible with the application service.

The optimum gasket material would have the following characteristics:

- It would have the chemical resistance of PTFE;
- The heat resistance of Flexible Graphite;
- The strength of steel;
- It requires a zero seating stress, such as with soft rubber; and,
- Be cost effective.

Obviously there is no known gasket material that has all these characteristics, and each material has certain limitations that restrict its use. It is possible to overcome limitations partially by several methods such as:

- Including the use of reinforcing inserts;
- Utilizing combination of materials;
- Varying the construction and/or density; and,
- Designing the joint itself to overcome some of the limitations.

Evidently, mechanical factors are important in the design of the joint but the primary selection of a gasket material is influenced by different factors:

I. The temperature of the fluid or gas in the service

Gaskets are affected in two ways by temperature. Gross physical characteristics are determined by temperature, including material state, oxidation point, and resilience. Also the mechanical (creep or stress relaxation) and chemical properties are highly temperature dependent.

2. The pressure of the fluid or gas in the service.

Internal pressure acts in two ways against a gasket. First, the hydrostatic end force, equal to the pressure multiplied by the area of pressure boundary, tends to separate the flanges. This force must be opposed by the flange clamp force. The difference between the initial flange clamp force and the hydrostatic end force is residual flange load. The residual load must be positive to prevent joint leakage. The magnitude of the residual flange load required to prevent leakage is dependent upon the style of gasket selected and its material of construction. Second, the internal pressure acts to blow out the gasket across the gasket flange interface.

3. The corrosive characteristics of the fluid or gas to be contained

The gasket must be resistant to deterioration from corrosive attack. The severity of attack and resulting corrosion is dependent upon temperature and time.

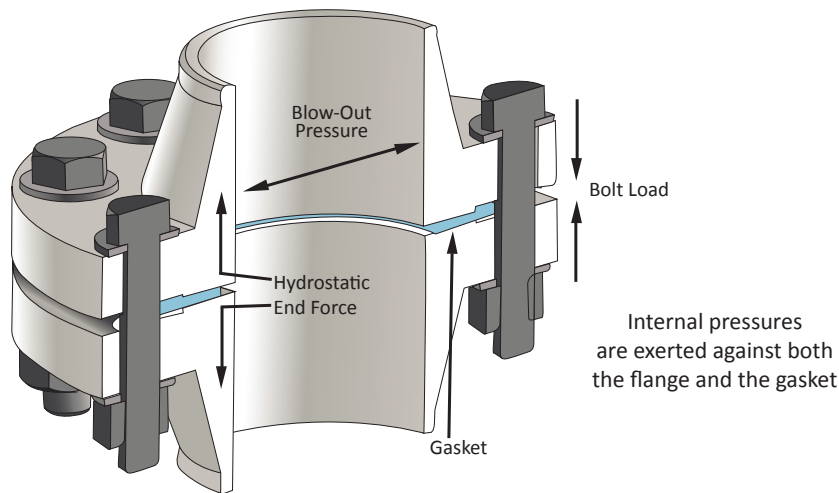

4. Flange Compatibility

The gasket is intended to be the renewable component in the joint system therefore it should be softer or more deformable than the mating surfaces. It must also be chemically compatible. For metallic gaskets, this means consideration must be given to galvanic corrosion. Galvanic effects can be minimized by selecting metals for the gasket and flange which are close together in the galvanic series, or the gasket should be sacrificial (anodic) to prevent damage to the flanges.

SUMMARY

There are charts that are included in the appendix that shows the maximum temperature limits for non-metal and metal materials. The ratings are based upon hot air constant temperatures. The presence of contaminating fluids and cyclic conditions may drastically affect the temperature range. Also, there are charts that indicate general recommendations for non-metallic and metallic materials against various corrosive media. These charts are general references, as there are many additional factors that can influence the corrosion resistance of a particular material at operating conditions. Some of these factors include:

- Concentration of the corrosive agent (full strength solutions are not necessarily more corrosive than those of dilute proportions and the opposite is also true);
- The purity of a corrosive agent. For example, dissolved oxygen in otherwise pure water may cause rapid oxidation of steam generation equipment at high temperatures; and,
- The temperature of the corrosive agent. In general, higher temperatures of corrosive agents will accelerate corrosive attack.

As a consequence, it is often necessary to “field-test” materials for resistance to corrosion under normal operating conditions to determine if the material selected will have the required resistance to corrosion.



SECTION ONE: NON-METALLIC GASKETS

A “Soft Gasket” material is a term used when referring to a gasket material that is easily compressed under a low bolt load. This term has been used to distinguish the difference from a metallic gasket. A soft gasket material can be selected from a large variety of elastomers, compressed non-asbestos, PTFE, flexible graphite and high temperature sheet products. Soft gaskets are used in a wide range of applications such as for pipe flanges, heat exchangers, compressors and bonnet valves, to name just a few. Soft gasket material can be purchased in a variety of cut shapes or be provided in sheet or rolls.

As part of Lamons strategy to offer customers a wider range of products, we are pleased to supply the following soft gasket materials:



- Elastomeric and Fiber Sheet
- Compressed Non-Asbestos Sheet
- Matrix Biaxially Orientated PTFE Sheet
- Matrix LI20 Expanded PTFE Sheet
- Matrix LI20 PTFE Joint Sealant
- PTFE Envelope Gaskets
- Virgin / Glass-Filled / Reprocessed PTFE Sheet
- Flexible Graphite Sheet
- Mica Sheet
- Ceramic Fiber

ELASTOMERS

An Elastomer is a polymer with the physical property of elasticity. Elastomer is a term derived from elastic polymer, which is often used interchangeably with the term rubber. Each of the monomers which link to form the polymer is usually made of carbon, hydrogen, oxygen and/ or silicon. Elastomers are usually thermosets requiring a curing process involving heat and the addition of sulfur or other equivalent curatives. In addition, elastomers might also be thermoplastic.

SBR (STYRENE-BUTADIENE)

SBR is a synthetic rubber that has excellent abrasion resistance and has good resistance to weak organic acids, alcohols, moderate chemicals and ketones. It is not good in ozone, strong acids, fats, oils, greases and most hydrocarbons. Its temperature range would be from approximately -65°F to 250°F (-54°C to 121°C).

CR-CHLOROPRENE (NEOPRENE)

Chloroprene is a synthetic rubber that is suitable for use against moderate acids, alkalis and salt solutions. It has good resistance to commercial oils and fuels. It is very poor against strong oxidizing acids, aromatic and chlorinated hydrocarbons. Its temperature range would be from approximately -60°F to 250°F (-51°C to 121°C).

BUNA-N/RUBBER (NITRILE, NBR)

Buna-N is a synthetic rubber that has good resistance to oils and solvents, aromatic and aliphatic hydrocarbons, petroleum oils and gasoline over a wide range of temperature. It also has good resistance to caustics and salts but only fair acid resistance. It is poor in strong oxidizing agents, chlorinated hydrocarbons, ketones and esters. It is suitable over a temperature range of approximately -60°F to 250°F (-51°C to 121°C).

EPDM (ETHYLENE PROPYLENE)

This synthetic material has good resistance to strong acids, alkalis, salts and chlorine solutions. It is not suitable for use in oils, solvents or aromatic hydrocarbons. Its temperature range would be between -70°F to 350°F (-57°C to 177°C).

FLUOROCARBON (VITON®)

Fluorocarbon elastomer has good resistance to oils, fuel, chlorinated solvents, aliphatic and aromatic hydrocarbons and strong acids. It is not suitable for use against amines, esters, ketones or steam. Its normal temperature range would be between -15°F to 450°F (-26°C to 232°C).

CHLOROSULFONATED POLYETHYLENE (HYPALON®)

Hypalon® has good acid, alkali and salt resistance. It resists weathering, sunlight, ozone, oils and commercial fuels such as diesel and kerosene. It is not good in aromatics or chlorinated hydrocarbons and has poor resistance against chromic acid and nitric acid. Its normal temperature range would be between -50°F and 275°F (-46°C and 135°C).

NATURAL RUBBER

Natural rubber has good resistance to mild acids and alkalis, salts and chlorine solutions. It has poor resistance to oils and solvents and is not recommended for use with ozone. Its temperature range is very limited and is suitable only for use from -70°F to 200°F (-57°C to 93°C).

SILICONES

Silicone rubbers have good resistance to hot air. They are unaffected by sunlight and ozone. They are not, however, suitable for use against steam, aliphatic and aromatic hydrocarbons. The temperature range would be between -65°F to 500°F (-54°C to 260°C).

VEGETABLE FIBER SHEET

Vegetable fiber sheet is a tough pliable gasket material manufactured by paper making techniques utilizing plant fibers and a glue-glycerine impregnation. It is widely used for sealing petroleum products, gases and a wide variety of solvents. Its maximum temperature limit is 250°F (121°C). If a more compressible material is required, a combination cork-fiber sheet is available. The cork-fiber sheet has the same maximum temperature limitation as the vegetable fiber sheet.

NOTE: Viton® and Hypalon® are registered trademarks of DuPont.

PTFE PRODUCTS

PTFE (Polytetrafluoroethylene) has emerged as the most common thermoplastic gasket material. PTFE's outstanding properties include resistance to temperature extremes from cryogenic to 500°F (260°C). PTFE is highly resistant to chemicals, solvents, caustics and acids except free fluorine and alkali metals. It has a very low surface energy and does not adhere to the flanges. PTFE gaskets can be supplied in a variety of forms; either as virgin or reprocessed material, and also with a variety of filler material. The principal advantage in adding fillers to PTFE is to inhibit cold flow or creep relaxation.

Matrix is a premium range of PTFE material that covers the full spectrum of customer requirements. This product line covers, biaxially orientated filled materials (L100, L104, L110) for low creep, higher loaded applications. High compression (L120) for applications where high load values are not achievable but low creep is still required.

Matrix L100, L104 and L110 products are manufactured to the HS10 method which was developed by DuPont in 1960. The result is a material that has exceptional strength and stability under load. The resultant biaxial orientation of the PTFE particles creates a unique strength where both the longitudinal and transverse directions are equally as strong. This superior matrix orientation and addition of premium fillers allows the material to resist creep and cold flow when subject to load.

Matrix L120 is our range of high quality Expanded PTFE materials, it is offered in both sheet, cut gaskets and joint sealant form.

Expanded PTFE (ePTFE) is manufactured by heating solid Polytetrafluoroethylene, the material is then stretched up to 800% of its original size and this forms a microporous structure which consists of around 70% air. This gives the material good compression characteristics, which allows the ePTFE to seal under low loads.

The Matrix range can be used in its pure form or can be used as facings or fillers for our range of semi-metallic gaskets.

All of our Matrix materials conform to FDA requirements.

MATRIX
MADE IN THE U.S.A.

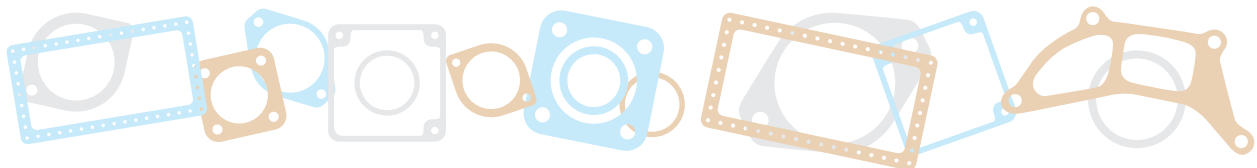

L100 MATRIX

A biaxially orientated high quality silica-filled PTFE sheet for use in sealing most chemicals except molten alkali metals, fluorine gas, and hydrogen fluoride. This material is approved for potable water service, complies with requirements of FDA regulations and can be used at all concentrations of sulfuric acid.



L104 MATRIX

A superior performance, biaxially orientated sheet material containing PTFE and hollow glass microspheres for use in sealing most chemicals except molten alkali metals, fluorine gas and hydrogen fluoride. This material is approved for potable water service, complies with requirements of FDA regulations and has exceptional compression characteristics making it good for use in glass lined flanges or where loading problems exist.

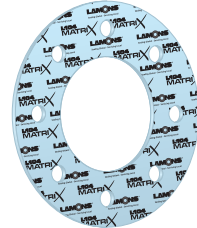

L110 MATRIX

A pigment-free biaxially orientated with superior performance, barium sulfate-filled PTFE sheet for use in sealing food, pharmaceuticals, and other general chemical media. This material complies with requirements of FDA regulations and is acceptable for use in aqueous hydrofluoric acid below 49%, but is not suitable for sealing molten alkali metals or fluorine gas.



TYPICAL PHYSICAL PROPERTIES

Style	MATRIX L100	MATRIX L104	MATRIX L110
Color	Tan	Blue	Off White
Density	137 lbs/ft ³ (2.2 g/cc)	87 lbs/ft ³ (1.4 g/cc)	180 lbs/ft ³ (2.9 g/cc)
Temperature Limits	-450°F (-268°C) to 500°F (260°C)	-450°F (-268°C) to 500°F (260°C)	-450°F (-268°C) to 500°F (260°C)
MAX Pressure	1235 psi (8.5 MPa)	1235 psi (8.5 MPa)	1235 psi (8.5 MPa)
F36 Compression	7%	35%	6%
F36 Recovery	45%	45%	40%
F152 Tensile Strength	2320 psi (16 MPa)	1885 psi (13 MPa)	2030 psi (14 MPa)
F37 Liquid Leakage	<0.3 mL/hr	<0.25 mL/hr	<0.2 mL/hr
F38 Creep Relaxation	35%	31%	13%
F149 Dielectric Strength	20 kV/mm	15 kV/mm	21 kV/mm
Residual Stress BS7531 @ 175°C	4496 psi (31 MPa)	4351 psi (30 MPa)	4351 psi (30 MPa)
Gas Leakage - DIN 3535	<0.01 mg/(s-m)	<0.02 mg/(s-m)	<0.01 mg/(s-m)
Gas Leakage - BS7531	<0.005 mL/min	<0.01 mL/min	<0.004 mL/min
ROTT Constant Gb	172	100	146
ROTT Constant a	0.401	0.401	0.375
ROTT Constant Gs	2.76 x 10 ⁻⁶	2.87 x 10 ⁻⁵	1.2
Tpmax	24260	33240	60460
m	4	2	2
y	2175 psi (15 MPa)	1595 psi (11 MPa)	1740 psi (12 MPa)

EXPANDED PTFE SHEET



Matrix L120 effectively fills flange imperfections for a tight, leak-free seal. It is easily compressed under lower loads, beneficial for applications such as FRP or glass-lined flanges. Unlike

conventional PTFE, which is prone to creep and cold flow, L120 has good creep resistance and bolt torque retention properties even under higher compressive force. With L120, it is much more possible to bolt up once and not have to re-torque later. Most commonly FDA/USDA suitable.



Complies with the requirements of FDA21 CFR 177.1550

Minimum Temperature: -450°F (-268°C)

Maximum Temperature: 500°F (260°C)

Maximum Pressure: 735 psi (5.1 MPa)

Thickness Range: 0.020" (0.5 mm) to 1/4" (6.4 mm)

TYPICAL PHYSICAL PROPERTIES

Property	ASTM Method	Typical Values
Compressibility	F36	55%
Recovery	F36	15%
Tensile Strength	F152	3190 psi (22MPa)
Liquid Leakage	F37	<0.1 mL/hr
Creep Relaxation	F38	17%
Density	-	59 lbs/ft ³ (0.95 g/cc)
Gas Leakage	BS7531	<0.03 mL/min

PTFE JOINT SEALANT



100% pure, specially processed PTFE sealant provides soft, highly compressible gasketing on a roll for long-life, trouble-free sealing that cuts maintenance and storing costs. Under

pressure, PTFE sealant provides a very thin and wide ribbon-like joint sealant so that the smallest possible gasket surface area is exposed to the harmful effects of corrosive media.



Width (in)	Length (ft)
1/8	100
1/4	50
3/8	25
3/8	250
1/2	15
1/2	30
1/2	150
5/8	15
5/8	30
5/8	150

Width (in)	Length (ft)
3/4	15
3/4	30
3/4	50
3/4	100
1	15
1	30
1	75

PTFE ENVELOPE GASKETS

Envelope gaskets utilizing PTFE jackets have become popular for use in severely corrosive services because of their low minimum seating stresses, excellent creep resistance, high deformability and choice of a variety of filler materials to assure optimum performance on any specific application. Fillers such as corrugated metal and rubber sheets are available.

There are three basic designs of envelopes:

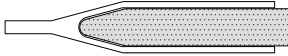
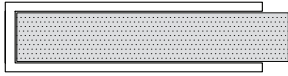
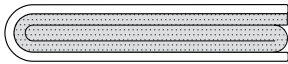
1. **Slit Type / V Type / Style 800:** sliced from cylinders and split from the outside diameter to within approximately 1/16" (1.5 mm) of the inside diameter. The bearing surface is determined by the filler dimensions. Clearance is required between the ID of the filler and the envelope ID. The gasket OD normally rests within the bolt hole circle and the ID is approximately equal to the nominal ID of pipe. Available in sizes to a maximum OD of 24. 
2. **Milled Type / Square Cut / Style 820:** machined from cylinder stock. The jacket is machined from the OD to within approximately 1/32" (0.8 mm) of its ID. The jacket's ID fits flush with pipe bore and its OD nests within the bolts. Available in sizes up to a maximum OD of 24" (609 mm). Milled envelopes are more expensive than slit type since considerably more material is lost in machining. 
3. **Formed Tape Type:** large diameter (over 12 NPS) and irregularly shaped envelopes are formed from tape and heat sealed to produce a continuous jacket construction. 

VIRGIN / GLASS-FILLED / REPROCESSED PTFE SHEET

TYPICAL PHYSICAL PROPERTIES

Property	Units	ASTM Method	Typical Values (Virgin)	Typical Values (G-F)	Typical Values (Repro)
Specific Gravity	g/cc	D-792	2.14 - 2.20	2.15 - 2.24	2.13 - 2.20
Hardness	Shore D	D-2240	52 - 65	55 - 58	52 - 65
Tensile Strength	psi (MPa)	D-638 D-1708	2800 min (19.3 MPa)	1000 - 2000 (7-14 MPa)	1500 - 2400 (10 MPa - 17 MPa)
Elongation	%	D638 D-1708	270 min	50 - 150	75 - 200
Deformation Under Load (73°F, 2000 psi, 24 hrs.)	%	D-621	15 - 16	3 - 9	N/A
Coefficient of Linear Thermal Expansion (78°F - 400°F)	in/in/°F	D-696	4 - 9 x 10 ⁻⁵	3 - 8 x 10 ⁻⁵	N/A
Thermal Conductivity	BTU/hr/ ft ² /F-in	C-177	1.7	2.5 - 3.5	
Dielectric Strength	volts/mil	D-149a	300 min	N/A	500 - 1000
Temperature Range	°F (°C)		Cryogenic to 450°F (232°C)	Cryogenic to 450°F (232°C)	Cryogenic to 450°F (232°C)



COMPRESSED NON-ASBESTOS

Early efforts to replace asbestos resulted in the introduction and testing of compressed non-asbestos products in the 1970's. Many of these products have seen extensive use since that period, however there have been enough problems to warrant careful consideration in choosing a replacement material for compressed asbestos. Most manufacturers of non-asbestos sheet materials use synthetic fibers, like aramid or Kevlar®, in conjunction with an elastomeric binder. The elastomeric binder makes up a larger percentage of this sheet and thereby becomes a more important consideration when determining applications.

NOTE: Kevlar® is a registered trademark of DuPont.

L420

L420 is a general purpose sheet jointing material with good mechanical properties. Constructed with aramid/ organic fiber and a high quality nitrile rubber binder.

Creep Relaxation	ASTM F-38B (1/32")	30%
Residual Stress	DIN 52913 (50 MPa @ 175°C)	25 MPa
Sealability	ASTM F-37A (1/32")	0.25 ml/hr
Gas Leakage	DIN 3535/6	< 1.0 ml/min
Compressibility	ASTM F-36 J	7 - 15%
Recovery	ASTM F-36 J	50% min
Tensile Strength	ASTM F-152	1500 psi (10 MPa)
Weight Increase	ASTM F-146 after immersion in Fuel B for 5 Hrs @ 73°F (23°C)	25% max
Thickness Increase	ASTM F-146	
	ASTM Oil I, 5 hrs / 300°F (149°C)	0 - 5%
	ASTM Oil 3, 5 hrs / 300°F (149°C)	0 - 5%
	ASTM Fuel A, 5 Hrs / 73°F (23°C)	0 - 5%
	ASTM Fuel B, 5 Hrs / 73°F (23°C)	0 - 7%
Standard Line Callout	ASTM F-104	F712111E12M4
Leachable Chlorides	FSA Method (Typical)	200 ppm
Density		112 lbs/ft ³ (1.8 g/cc)
Color	Green	
Pressure Range	Vacuum to 580 psi (40 Bar) @ 1/16" thickness and below	
Thickness Range	1/64" (0.4 mm) to 1/8" (3.2 mm)	
Sheet Size Availability	Max: 120" x 60" (3 m x 1.5 m)	
Temperature Limits	-40°F to 356°F (-40°C to 180°C)	

Applications and Characteristics:

- Used successfully in mild organic and inorganic acids
- Diluted alkalis
- General chemicals
- Synthetic oils
- Petroleum and petroleum derivatives

NOTE: Please refer to Lamons Chemical Compatibility Chart (in the Appendix of this manual) for more information. All Lamons sheet gasket materials are supplied with anti-stick coating as standard. Can be manufactured with wire insert.



L430

L430 is a general purpose sheet jointing material with superior mechanical properties. Constructed with premium aramid fiber and a high quality nitrile rubber binder.

Applications and Characteristics:

- Used successfully in mild organic and inorganic acids
- Diluted alkalis
- General chemicals
- Synthetic oils
- Petroleum and petroleum derivatives

NOTE: Please refer to Lamons Chemical Compatibility Chart (in the Appendix of this manual) for more information. All Lamons sheet gasket materials are supplied with anti-stick coating as standard. Can be manufactured with wire insert.



Creep Relaxation	ASTM F-38B (1/32")	25%
Residual Stress	DIN 52913 (50 MPa @ 175°C)	25 MPa
	BS7531 (40 MPa @ 300°C)	16 MPa
Sealability	ASTM F-37A (1/32")	0.25 ml/hr
Gas Leakage	DIN 3535/6	< 1.0 ml/min
Compressibility	ASTM F-36 J	7 - 17%
Recovery	ASTM F-36 J	50% min
Tensile Strength	ASTM F-152	1500 psi (10 MPa)
Weight Increase	ASTM F-146 after immersion in Fuel B for 5 Hrs @ 73°F (23°C)	15% max
Thickness Increase	ASTM F-146	
	ASTM Oil I, 5 hrs / 300°F (149°C)	0 - 5%
	ASTM Oil 3, 5 hrs / 300°F (149°C)	0 - 5%
	ASTM Fuel A, 5 Hrs / 73°F (23°C)	0 - 5%
	ASTM Fuel B, 5 Hrs / 73°F (23°C)	0 - 7%
Standard Line Callout	ASTM F-104	F712111E12M4
m & y values	1/16" thickness	1/8" thickness
m	2.5	3.2
y	3800	4100
Dielectric Strength	ASTM D149-95a	14 kV/mm
Leachable Chlorides	FSA Method (Typical)	200 ppm
Density		112 lbs/ft ³ (1.8 g/cc)
Color	Green	
Thickness Range	1/64" (0.4 mm) to 1/8" (3.2 mm)	
Sheet Size Availability	Max: 120" x 60" (3 m x 1.5 m)	
Temperature Limits	-40°F to 428°F (-40°C to 220°C)	
Maximum Pressure	50 Bar (725 PSI)	

L430 PRESSURE / TEMPERATURE GRAPH

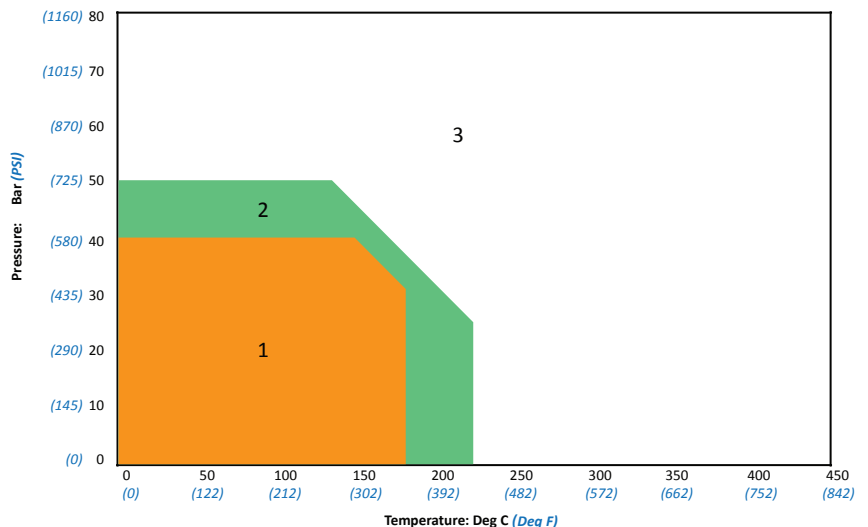

All Pressure / Temperature values are based on 1/16" (1.5 mm) gasket thickness.

1. Suitable (Chemical Compatibility has to be considered).
2. Please contact Lamons Engineering department for clarification. engineering@lamons.com
3. Not Suitable.

L433

L433 is a premium sheet gasket material with a reinforcement structure consisting of glass and aramid fibers, it is bound together with a high quality nitrile rubber binder. L433 has excellent resistance to steam due to the addition of glass fiber.

Creep Relaxation	ASTM F-38B (1/32")	20%
Residual Stress	DIN 52913 (50 MPa @ 175°C)	32 MPa
	BS7531 (40 MPa @ 300°C)	27 MPa
Sealability	ASTM F-37A (1/32")	0.25 ml/hr
Gas Leakage	DIN 3535/6	< 1.0 ml/min
Compressibility	ASTM F-36 J	7 - 17%
Recovery	ASTM F-36 J	50% min
Tensile Strength	ASTM F-152	1500 psi (10 MPa)
Weight Increase	ASTM F-146 after immersion in Fuel B for 5 Hrs @ 73°F (23°C)	15% max
Thickness Increase	ASTM F-146	
	ASTM Oil 1, 5 hrs / 300°F (149°C)	0 - 5%
	ASTM Oil 3, 5 hrs / 300°F (149°C)	0 - 5%
	ASTM Fuel A, 5 Hrs / 73°F (23°C)	0 - 5%
	ASTM Fuel B, 5 Hrs / 73°F (23°C)	0 - 7%
Standard Line Callout	ASTM F-104	F712132B3E21M5
m & y values	1/16" thickness	1/8" thickness
m	2.5	3.2
y	3800	4100
Dielectric Strength	ASTM D149-95a	18 kV/mm
Leachable Chlorides	FSA Method (Typical)	200 ppm
Density		100 lbs/ft ³ (1.6 g/cc)
Color	Red/Brown	
Thickness Range	1/64" (0.4 mm) to 1/8" (3.2 mm)	
Sheet Size Availability	Max: 120" x 60" (3 m x 1.5 m)	
Approvals	Meets "BS7531 Grade AX" API 607 Fire Safe	
Temperature Limits	-150°F to 800°F (-100°C to 425°C)	
Maximum Pressure	80 Bar (1160 PSI)	

Applications and Characteristics:

- Excellent sealing ability, high resistance to creep
- Good steam resistance
- Stronger acids and alkalis, inert gases, general chemicals, oils and fuels
- Petroleum and petroleum derivatives

NOTE: Please refer to Lamons Chemical Compatibility Chart (in the Appendix of this manual) for more information. All Lamons sheet gasket materials are supplied with anti-stick coating as standard. Can be manufactured with wire insert.



L433 PRESSURE / TEMPERATURE GRAPH

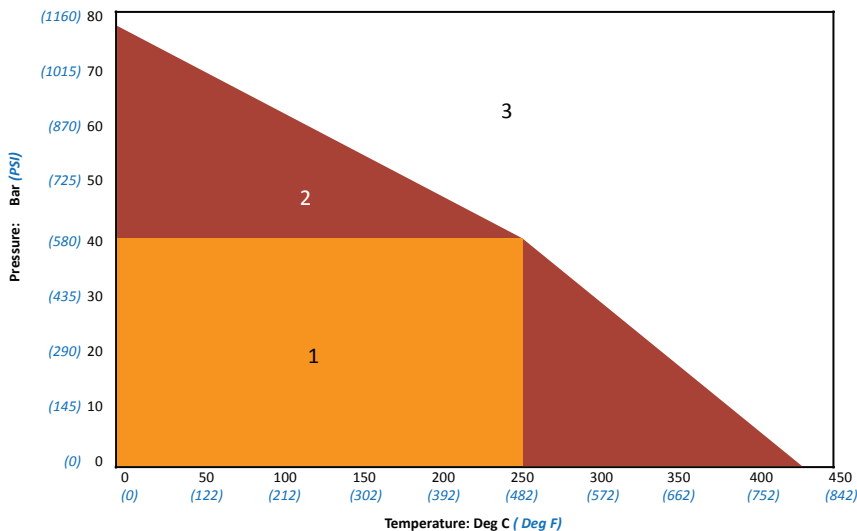

All Pressure / Temperature values are based on 1/16" (1.5 mm) gasket thickness.

1. Suitable (Chemical Compatibility has to be considered).
2. Please contact Lamons Engineering department for clarification. engineering@lamons.com
3. Not Suitable.

L440

L440 is a good quality sheet gasket material with a wide range of application potential. Manufactured with a formulation of high quality fillers, premium aramid fibers and a nitrile rubber binder, L440 is a cost effective, high performance gasket material.

Applications and Characteristics:

- Excellent sealing ability, good resistance to creep
- Good chemical resistance
- Inert gases, general chemicals, oils and fuels
- Great Recovery

NOTE: Please refer to Lamons Chemical Compatibility Chart (in the Appendix of this manual) for more information. All Lamons sheet gasket materials are supplied with anti-stick coating as standard. Can be manufactured with wire insert.



Creep Relaxation	ASTM F-38B (1/32")	20%
Residual Stress	DIN 52913 (50 MPa @ 175°C)	30 MPa
	BS7531 (40 MPa @ 300°C)	24 MPa
Sealability	ASTM F-37A (1/32")	0.2 ml/hr
Gas Leakage	DIN 3535/6	< 1.0 ml/min
Compressibility	ASTM F-36 J	7 - 17%
Recovery	ASTM F-36 J	50% min
Tensile Strength	ASTM F-152	1600 psi (11 MPa)
Weight Increase	ASTM F-146 after immersion in Fuel B for 5 Hrs @ 73°F (23°C)	25% max
Thickness Increase	ASTM F-146	
	ASTM Oil 1, 5 hrs / 300°F (149°C)	0 - 5%
	ASTM Oil 3, 5 hrs / 300°F (149°C)	0 - 5%
	ASTM Fuel A, 5 Hrs / 73°F (23°C)	0 - 5%
	ASTM Fuel B, 5 Hrs / 73°F (23°C)	0 - 7%
Standard Line Callout	ASTM F-104	F712121B3E22M5
m & y values	1/16" thickness	1/8" thickness
m	2.5	3.2
y	3800	4100
Dielectric Strength	ASTM D149-95a	17 kV/mm
Leachable Chlorides	FSA Method (Typical)	100 ppm
Density		112 lbs/ft ³ (1.8 g/cc)
Color	Green	
Thickness Range	1/64" (0.4 mm) to 1/8" (3.2 mm)	
Sheet Size Availability	Max: 120" x 60" (3 m x 1.5 m)	
Approvals	Meets "BS7531 Grade AY"	
Temperature Limits	-100°F to 752°F (-73°C to 400°C)	
Maximum Pressure	65 Bar (943 PSI)	

L440 PRESSURE / TEMPERATURE GRAPH

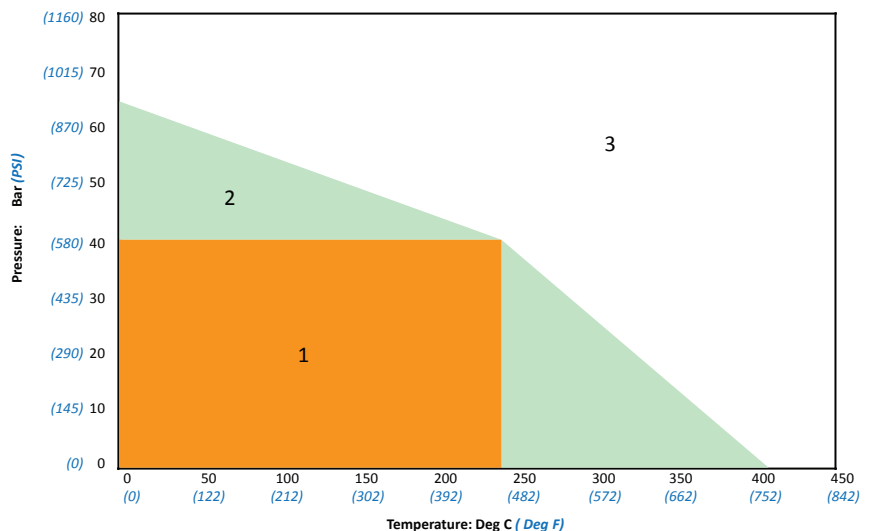

All Pressure / Temperature values are based on 1/16" (1.5 mm) gasket thickness.

1. Suitable (Chemical Compatibility has to be considered).
2. Please contact Lamons Engineering department for clarification. engineering@lamons.com
3. Not Suitable.

L441

A general service sheet gasket material with a wide range of application potential. Manufactured with a formulation of high quality fillers, premium aramid fibers and nitrile binder, L441 is the workhorse of the Lamons gasket line

Creep Relaxation	ASTM F-38B (1/32")	20%
Residual Stress	DIN 52913 (50 MPa @ 175°C)	28 MPa
	BS7531 (40 MPa @ 300°C)	20 MPa
Sealability	ASTM F-37A (1/32")	0.25 ml/hr
Gas Leakage	DIN 3535/6	< 1.0 ml/min
Compressibility	ASTM F-36 J	7 - 17%
Recovery	ASTM F-36 J	50% min
Tensile Strength	ASTM F-152	1500 psi (10 MPa)
Weight Increase	ASTM F-146 after immersion in Fuel B for 5 Hrs @ 73°F (23°C)	25% max
Thickness Increase	ASTM F-146	
	ASTM Oil 1, 5 hrs / 300°F (149°C)	0 - 5%
	ASTM Oil 3, 5 hrs / 300°F (149°C)	0 - 5%
	ASTM Fuel A, 5 Hrs / 73°F (23°C)	0 - 5%
	ASTM Fuel B, 5 Hrs / 73°F (23°C)	0 - 7%
Standard Line Callout	ASTM F-104	F712121B3E22M5
m & y values	1/16" thickness	1/8" thickness
m	2.5	3.2
y	3800	4100
Dielectric Strength	ASTM D149-95a	15 kV/mm
Leachable Chlorides	FSA Method (Typical)	100 ppm
Density		112 lbs/ft ³ (1.8 g/cc)
Color	Blue	
Thickness Range	1/64" (0.4 mm) to 1/8" (3.2 mm)	
Sheet Size Availability	Max: 120" x 60" (3 m x 1.5 m)	
Temperature Limits	-100°F to 707°F (-73°C to 375°C)	
Maximum Pressure	60 Bar (870 PSI)	

Applications and Characteristics:

- Excellent sealing ability
- Good chemical resistance
- Creep relaxation minimization
- Great Recovery

NOTE: Please refer to Lamons Chemical Compatibility Chart (in the Appendix of this manual) for more information. All Lamons sheet gasket materials are supplied with anti-stick coating as standard. Can be manufactured with wire insert.



L441 PRESSURE / TEMPERATURE GRAPH

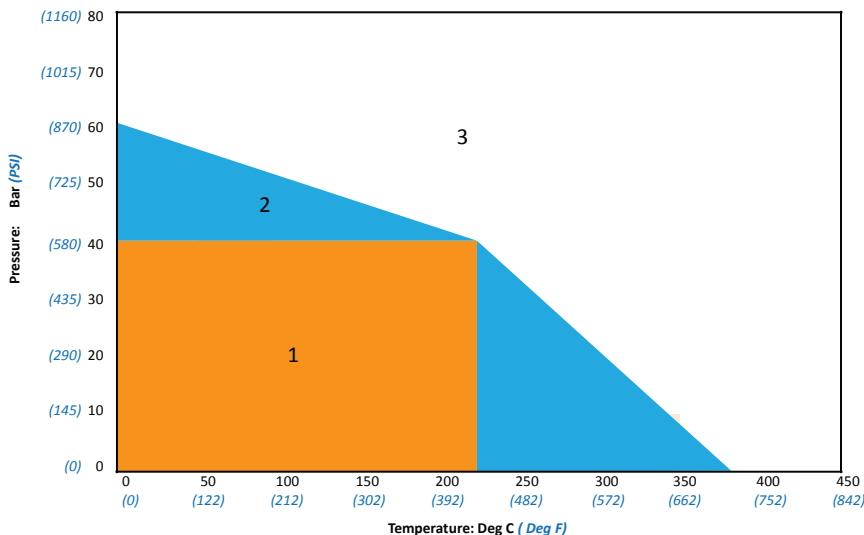

All Pressure / Temperature values are based on 1/16" (1.5 mm) gasket thickness.

1. Suitable (Chemical Compatibility has to be considered).
2. Please contact Lamons Engineering department for clarification. engineering@lamons.com
3. Not Suitable.

L443

L443 is a premium sheet gasket material with a reinforcement structure consisting of glass and aramid fibers, it is bound together with a high quality nitrile rubber binder. L443 has excellent resistance to steam due to the addition of glass fiber.

Applications and Characteristics:

- Excellent sealing ability, high resistance to creep
- Good steam resistance
- Stronger acids and alkalis, inert gases, general chemicals, oils and fuels
- Petroleum and petroleum derivatives

NOTE: Please refer to Lamons Chemical Compatibility Chart (in the Appendix of this manual) for more information. All Lamons sheet gasket materials are supplied with anti-stick coating as standard. Can be manufactured with wire insert.



Creep Relaxation	ASTM F-38B (1/32")	20%
Residual Stress	DIN 52913 (50 MPa @ 175°C)	32 MPa
	BS7531 (40 MPa @ 300°C)	27 MPa
Sealability	ASTM F-37A (1/32")	0.25 ml/hr
Gas Leakage	DIN 3535/6	< 1.0 ml/min
Compressibility	ASTM F-36 J	7 - 17%
Recovery	ASTM F-36 J	50% min
Tensile Strength	ASTM F-152	1500 psi (10 MPa)
Weight Increase	ASTM F-146 after immersion in Fuel B for 5 Hrs @ 73°F (23°C)	15% max
Thickness Increase	ASTM F-146	
	ASTM Oil I, 5 hrs / 300°F (149°C)	0 - 5%
	ASTM Oil 3, 5 hrs / 300°F (149°C)	0 - 5%
	ASTM Fuel A, 5 Hrs / 73°F (23°C)	0 - 5%
	ASTM Fuel B, 5 Hrs / 73°F (23°C)	0 - 7%
Standard Line Callout	ASTM F-104	F712132B3E2IM5
m & y values	1/16" thickness	1/8" thickness
m	2.5	3.2
y	3800	4100
Dielectric Strength	ASTM DI49-95a	18 kV/mm
Leachable Chlorides	FSA Method (Typical)	200 ppm
Density		100 lbs/ft ³ (1.6 g/cc)
Color	White/Green	
Thickness Range	1/64" (0.4 mm) to 1/8" (3.2 mm)	
Sheet Size Availability	Max: 120" x 60" (3 m x 1.5 m)	
Approvals	Meets "BS7531 Grade AX" API 607 Fire Safe, ABS, GL	
Temperature Limits	-150°F to 800°F (-100°C to 425°C)	
Maximum Pressure	80 Bar (1160 PSI)	

L443 PRESSURE / TEMPERATURE GRAPH

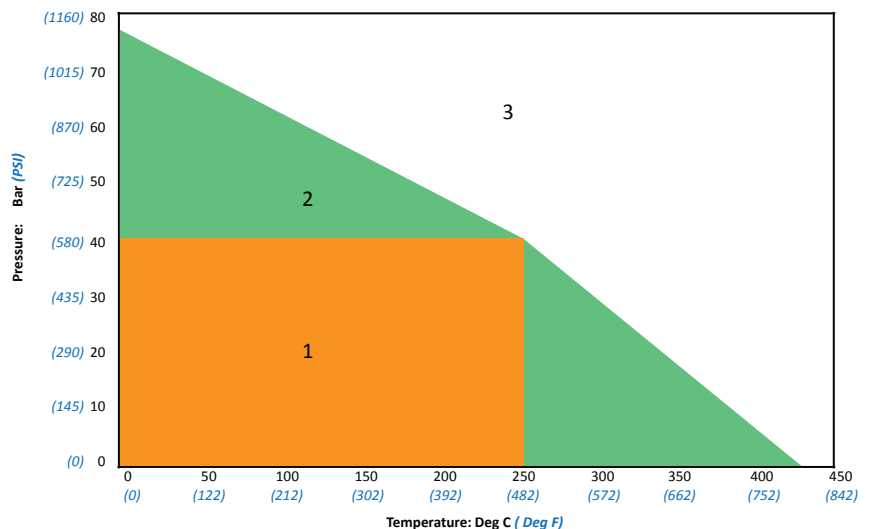

All Pressure / Temperature values are based on 1/16" (1.5 mm) gasket thickness.

1. Suitable (Chemical Compatibility has to be considered).
2. Please contact Lamons Engineering department for clarification. engineering@lamons.com
3. Not Suitable.

L450

L450 is a premium sheet gasket material utilizing carbon and aramid fibers, it is bound together with a high quality nitrile rubber binder. L450 is designed to perform at high temperatures and pressures. Standardization and consolidation of many other gasket materials can be achieved by the use of L450.

Creep Relaxation	ASTM F-38B (1/32")	18%
Residual Stress	DIN 52913 (50 MPa @ 175°C)	31 MPa
	BS7531 (40 MPa @ 300°C)	26 MPa
Sealability	ASTM F-37A (1/32")	0.3 ml/hr
Gas Leakage	DIN 3535/6	< 1.0 ml/min
Compressibility	ASTM F-36 J	7 - 17%
Recovery	ASTM F-36 J	50% min
Tensile Strength	ASTM F-152	1500 psi (10 MPa)
Weight Increase	ASTM F-146 after immersion in Fuel B for 5 Hrs @ 73°F (23°C)	15% max
Thickness Increase	ASTM F-146	
	ASTM Oil 1, 5 hrs / 300°F (149°C)	0 - 5%
	ASTM Oil 3, 5 hrs / 300°F (149°C)	0 - 5%
	ASTM Fuel A, 5 Hrs / 73°F (23°C)	0 - 5%
	ASTM Fuel B, 5 Hrs / 73°F (23°C)	0 - 7%
Standard Line Callout	ASTM F-104	F712122B3E22M5
m & y values	1/16" thickness	1/8" thickness
m	2.5	3.2
y	3800	4100
Dielectric Strength	ASTM D149-95a	5 kV/mm
Leachable Chlorides	FSA Method (Typical)	200 ppm
Density		100 lbs/ft ³ (1.6 g/cc)
Color	Black	
Thickness Range	1/64" (0.4 mm) to 1/8" (3.2 mm)	
Sheet Size Availability	Max: 120" x 60" (3 m x 1.5 m)	
Approvals	Meets "BS7531 Grade AX" API 607 Fire Safe	
Temperature Limits	-150°F to 842°F (-100°C to 450°C)	
Maximum Pressure	80 Bar (1160 PSI)	

L450 PRESSURE / TEMPERATURE GRAPH

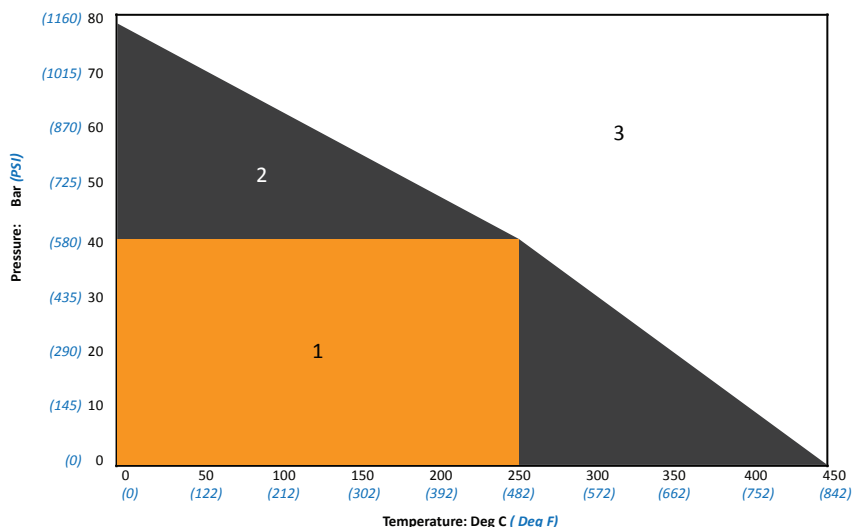

Applications and Characteristics:

- Excellent sealing ability, high resistance to creep
- Good steam resistance
- Stronger acids and alkalis, inert gases, general chemicals, oils and fuels

NOTE: Please refer to Lamons Chemical Compatibility Chart (in the Appendix of this manual) for more information. All Lamons sheet gasket materials are supplied with anti-stick coating as standard. Can be manufactured with wire insert.



All Pressure / Temperature values are based on 1/16" (1.5 mm) gasket thickness.

1. Suitable (Chemical Compatibility has to be considered).
2. Please contact Lamons Engineering department for clarification. engineering@lamons.com
3. Not Suitable.

* Can be used up to a maximum short term peak temperature of 900°F (482°C)

L460

L460 is a premium sheet gasket material utilizing graphite and aramid fibers, it is bound together with a high quality nitrile rubber binder. L460 is designed to perform at high temperatures and pressures. Standardization and consolidation of many other gasket materials can be achieved by the use of L460.

Applications and Characteristics:

- Excellent sealing ability, high resistance to creep
- Good steam resistance
- Stronger acids and alkalis, inert gases, general chemicals, oils and fuels
- Petroleum and petroleum derivatives

NOTE: Please refer to Lamons Chemical Compatibility Chart (in the Appendix of this manual) for more information. All Lamons sheet gasket materials are supplied with anti-stick coating as standard. Can be manufactured with wire insert.



Creep Relaxation	ASTM F-38B (1/32")	19%
Residual Stress	DIN 52913 (50 MPa @ 175°C)	30 MPa
	BS7531 (40 MPa @ 300°C)	25 MPa
Sealability	ASTM F-37A (1/32")	0.3 ml/hr
Gas Leakage	DIN 3535/6	< 1.0 ml/min
Compressibility	ASTM F-36 J	11%
Recovery	ASTM F-36 J	55% min
Tensile Strength	ASTM F-152	1500 psi (10 MPa)
Weight Increase	ASTM F-146 after immersion in Fuel B for 5 Hrs @ 73°F (23°C)	15% max
Thickness Increase	ASTM F-146	
	ASTM Oil 1, 5 hrs / 300°F (149°C)	0 - 5%
	ASTM Oil 3, 5 hrs / 300°F (149°C)	0 - 5%
	ASTM Fuel A, 5 Hrs / 73°F (23°C)	0 - 5%
	ASTM Fuel B, 5 Hrs / 73°F (23°C)	0 - 7%
Standard Line Callout	ASTM F-104	F712122B3E22M5
m & y values	1/16" thickness	1/8" thickness
m	2.5	3.2
y	3800	4100
Dielectric Strength	ASTM D149-95a	5 kV/mm
Leachable Chlorides	FSA Method (Typical)	200 ppm
Density		100 lbs/ft ³ (1.6 g/cc)
Color	Black	
Thickness Range	1/64" (0.4 mm) to 1/8" (3.2 mm)	
Sheet Size Availability	Max: 120" x 60" (3 m x 1.5 m)	
Approvals	Meets "BS7531 Grade AX"	
Temperature Limits	-150°F to 842°F (-100°C to 450°C)	
Maximum Pressure	65 Bar (943 PSI)	

L460 PRESSURE / TEMPERATURE GRAPH

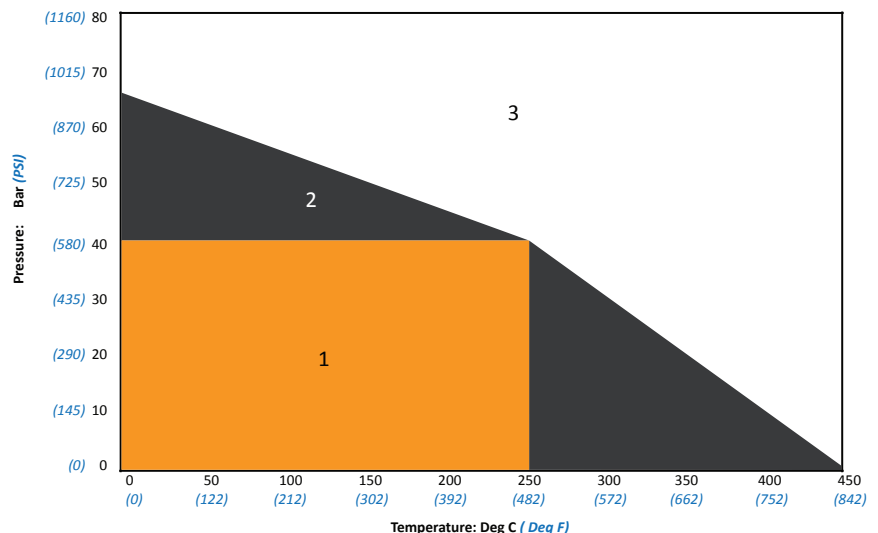

All Pressure / Temperature values are based on 1/16" (1.5 mm) gasket thickness.

1. Suitable (Chemical Compatibility has to be considered).
2. Please contact Lamons Engineering department for clarification. engineering@lamons.com
3. Not Suitable.

L540

L540 is a compressed sheet gasket material utilizing a high quality Neoprene binder. It is reinforced with aramid and inorganic fibers. This material has an inherent resistance to oil and petroleum based solvents

Creep Relaxation	ASTM F-38B (1/32")	25%
Residual Stress	DIN 52913 (50 MPa @ 175°C)	28 MPa
	BS7531 (40 MPa @ 300°C)	20 MPa
Sealability	ASTM F-37A (1/32")	0.2 ml/hr
Gas Leakage	DIN 3535/6	< 1.0 ml/min
Compressibility	ASTM F-36 J	7 - 17%
Recovery	ASTM F-36 J	50% min
Tensile Strength	ASTM F-152	1600 psi (11 MPa)
Weight Increase	ASTM F-146 after immersion in Fuel B for 5 Hrs @ 73°F (23°C)	20% max
Thickness Increase	ASTM F-146	
	ASTM Oil I, 5 hrs / 300°F (149°C)	0 - 10%
	ASTM Oil 3, 5 hrs / 300°F (149°C)	15 - 25%
	ASTM Fuel A, 5 Hrs / 73°F (23°C)	0 - 10%
	ASTM Fuel B, 5 Hrs / 73°F (23°C)	10 - 20%
Standard Line Callout	ASTM F-104	F712332B4E45M5
m & y values	1/16" thickness	1/8" thickness
m	2.5	3.2
y	3800	4100
Dielectric Strength	ASTM D149-95a	12 kV/mm
Leachable Chlorides	FSA Method (Typical)	500 ppm
Density		106 lbs/ft ³ (1.7 g/cc)
Color	Dark Gray	
Thickness Range	1/64" (0.4 mm) to 1/8" (3.2 mm)	
Sheet Size Availability	Max: 120" x 60" (3 m x 1.5 m)	
Temperature Limits	-60°F to 572°F (-51°C to 300°C)	
Maximum Pressure	60 Bar (870 PSI)	

Applications and Characteristics:

- It is chemically stable and possesses good mechanical properties
- It is an excellent choice for water and saturated steam
- Refrigerants
- Oils and fuels

NOTE: Please refer to Lamons Chemical Compatibility Chart (in the Appendix of this manual) for more information. All Lamons sheet gasket materials are supplied with anti-stick coating as standard. Can be manufactured with wire insert.

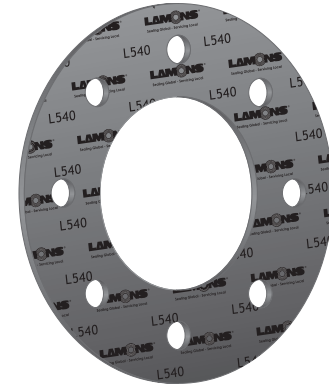

L540 PRESSURE / TEMPERATURE GRAPH

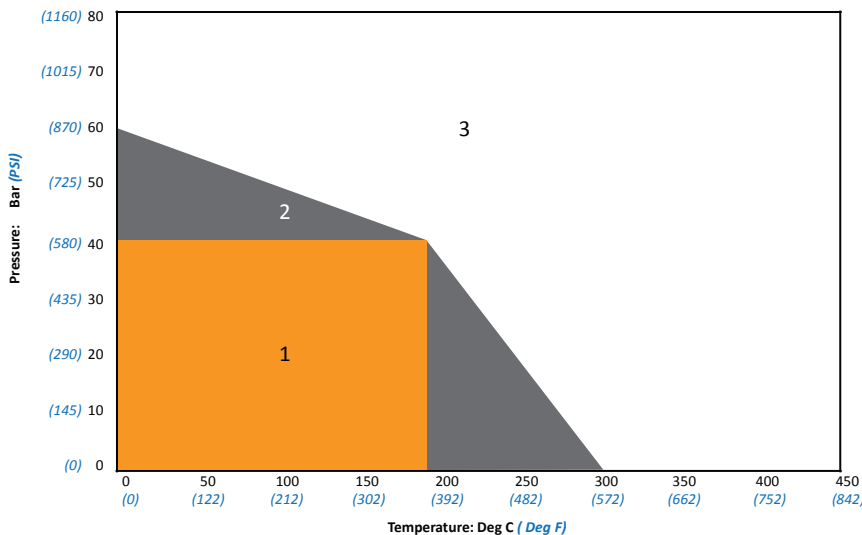

All Pressure / Temperature values are based on 1/16" (1.5 mm) gasket thickness.

1. Suitable (Chemical Compatibility has to be considered).
2. Please contact Lamons Engineering department for clarification. engineering@lamons.com
3. Not Suitable.

L640W

L640W is a premium compressed sheet gasket material utilizing a high quality SBR binder. It is reinforced with an engineered blend of aramid and inorganic fibers.

Applications and Characteristics:

- It is chemically stable and possesses good mechanical properties
- It is an excellent choice for water and saturated steam
- Mild acids and alkalis
- Inert gases.

NOTE: Please refer to Lamons Chemical Compatibility Chart (in the Appendix of this manual) for more information. All Lamons sheet gasket materials are supplied with anti-stick coating as standard. Can be manufactured with wire insert.



Creep Relaxation	ASTM F-38B (1/32")	20%
Residual Stress	DIN 52913 (50 MPa @ 175°C)	29 MPa
	BS7531 (40 MPa @ 300°C)	23 MPa
Sealability	ASTM F-37A (1/32")	0.2 ml/hr
Gas Leakage	DIN 3535/6	< 1.0 ml/min
Compressibility	ASTM F-36 J	7 - 17%
Recovery	ASTM F-36 J	50% min
Tensile Strength	ASTM F-152	1600 psi (11 MPa)
Weight Increase	ASTM F-146 after immersion in Fuel B for 5 Hrs @ 73°F (23°C)	25% max
Thickness Increase	ASTM F-146	
	ASTM Oil 1, 5 hrs / 300°F (149°C)	0 - 15%
	ASTM Oil 3, 5 hrs / 300°F (149°C)	20 - 35%
	ASTM Fuel A, 5 Hrs / 73°F (23°C)	0 - 15%
	ASTM Fuel B, 5 Hrs / 73°F (23°C)	15 - 25%
Standard Line Callout	ASTM F-104	F712541B3E45M5
m & y values	1/16" thickness	1/8" thickness
m	2.5	3.2
y	3800	4100
Dielectric Strength	ASTM D149-95a	16 kV/mm
Leachable Chlorides	FSA Method (Typical)	200 ppm
Density		112 lbs/ft ³ (1.8 g/cc)
Color	Off White	
Thickness Range	1/64" (0.4 mm) to 1/8" (3.2 mm)	
Sheet Size Availability	Max: 120" x 60" (3 m x 1.5 m)	
Approvals	Meets "BS7531 Grade AY"	
Temperature Limits	-65°F to 662°F (-54°C to 350°C)	
Maximum Pressure	60 Bar (870 PSI)	

All Pressure / Temperature values are based on 1/16" (1.5 mm) gasket thickness.

1. Suitable (Chemical Compatibility has to be considered).
2. Please contact Lamons Engineering department for clarification. engineering@lamons.com
3. Not Suitable.

L640W PRESSURE / TEMPERATURE GRAPH

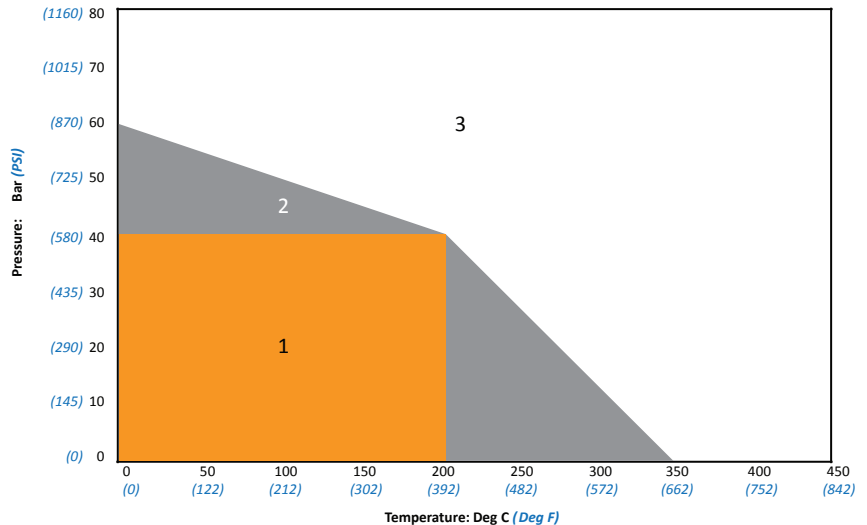

L740

L740 is a premium compressed sheet gasket material utilizing a high quality EPDM binder. It is reinforced with an engineered blend of aramid and inorganic fibers.

Creep Relaxation	ASTM F-38B (1/32")	24%
Residual Stress	DIN 52913 (50 MPa @ 175°C)	30 MPa
	BS7531 (40 MPa @ 300°C)	22 MPa
Sealability	ASTM F-37A (1/32")	0.2 ml/hr
Gas Leakage	DIN 3535/6	< 1.0 ml/min
Compressibility	ASTM F-36 J	7 - 15%
Recovery	ASTM F-36 J	50% min
Tensile Strength	ASTM F-152	1600 psi (11 MPa)
Weight Increase	ASTM F-146 after immersion in Fuel B for 5 Hrs @ 73°F (23°C)	23% max
Thickness Increase	ASTM F-146	
	ASTM Oil I, 5 hrs / 300°F (149°C)	15 - 35%
	ASTM Oil 3, 5 hrs / 300°F (149°C)	30 - 50%
	ASTM Fuel A, 5 Hrs / 73°F (23°C)	10 - 35%
	ASTM Fuel B, 5 Hrs / 73°F (23°C)	15 - 35%
Standard Line Callout	ASTM F-104	F712690A-9B4E99L104M9
m & y values	1/16" thickness	1/8" thickness
m	2.5	3.2
y	3800	4100
Dielectric Strength	ASTM D149-95a	16 kV/mm
Leachable Chlorides	FSA Method (Typical)	200 ppm
Density		112 lbs/ft ³ (1.8 g/cc)
Color	Off White/Gray	
Thickness Range	1/64" (0.4 mm) to 1/8" (3.2 mm)	
Sheet Size Availability	Max: 120" x 60" (3 m x 1.5 m)	
Temperature Limits	-100°F to 707°F (-73°C to 375°C)	
Maximum Pressure	65 Bar (943 PSI)	

Applications and Characteristics:

- It is chemically stable and possesses good mechanical properties
- It is an excellent choice for water and saturated steam
- Mild acids and alkalis
- Inert gases

NOTE: Please refer to Lamons Chemical Compatibility Chart (in the Appendix of this manual) for more information. All Lamons sheet gasket materials are supplied with anti-stick coating as standard. Can be manufactured with wire insert.



L740 PRESSURE / TEMPERATURE GRAPH

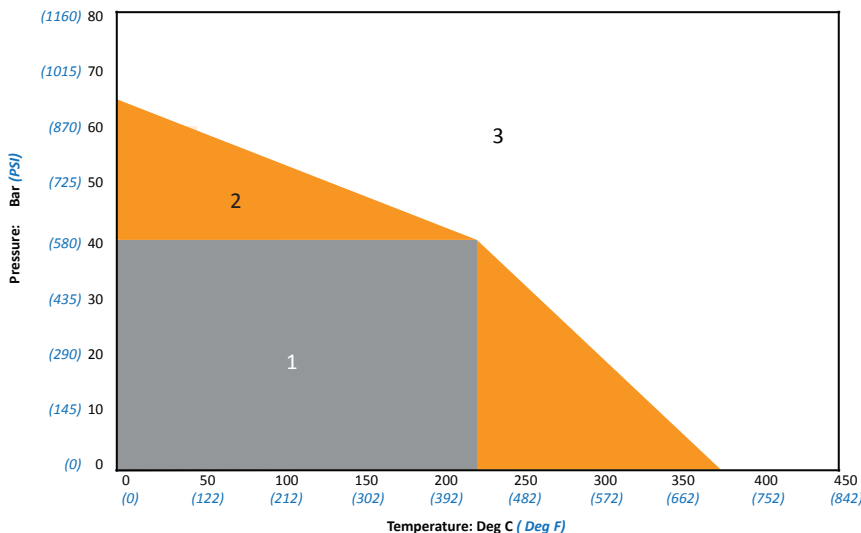

All Pressure / Temperature values are based on 1/16" (1.5 mm) gasket thickness.

1. Suitable (Chemical Compatibility has to be considered).
2. Please contact Lamons Engineering department for clarification. engineering@lamons.com
3. Not Suitable.

FLEXIBLE GRAPHITE

This is an all graphite material containing no resins or inorganic fillers. It is available with or without a metal insertion, and in adhesive-back tape form. Flexible Graphite has outstanding resistance to corrosion against a wide variety of acids, alkalies and salt solutions, organic compounds, and heat transfer fluids, even at high temperatures. There are two proven metal reinforced flexible graphite laminate materials ideal for 95% of all sheet gasket applications. Lamons flexible graphite laminates (LG-SS and LG-TC) are surface branded for easy identification. These gasket materials meet refinery, petrochemical and industrial service requirements.

GRAPHITE TAPE

Rolls of graphite tape can be furnished with a strong self-adhesive backing strip, to facilitate repair of multiple surfaces, enhancement of existing design or installation as a form-in-place gasket.



TEMPERATURE LIMITS

	Minimum	Maximum
In air	-320°F (-200°C)	840°F (450°C)
In Steam	-320°F (-200°C)	1200°F (650°C)
In Inert or Reducing Media	-320°F (-200°C)	5400°F (3000°C)

STANDARD DIMENSIONS

Thickness	0.005" (0.127 mm), 0.01" (0.254 mm), 0.015" (0.381), 0.02" (0.508 mm), 0.03"(0.762 mm) and 0.04" (1.016 mm)
Width	1/2" (12.7 mm) to 2" (50.8 mm)
Length	20' (6.1 m), 50' (15.24 m), 100' (30.48 m)

NOTE: Custom widths and lengths available

LAMONS LG-SS

LG-SS is a flat metal 316/316L stainless steel reinforced flexible graphite sheet material made with minimum 98% typical carbon content.

Creep Relaxation	<4%
Stability under stress (DIN 52913)	48 N/m ²
Compressibility	30%-40%
Recovery	15%-20%
ASME code factor "M value"	2
ASME code factor "Y value"	900 psi
Number of inserts	1
Total chlorine (Max)	50 ppm
Density	70 lb/ft ³ (1.12 g/cc)
Ash content (Max)	2.0%
Tp max at 15,000 psi gasket stress	3227 psi (22 MPa)
PVRC design constants*:	G _b = 816 psi a = 0.377 psi G _s = 0.066 psi
Gas permeability according DIN 3535 (0.60")	<1.0 ml/min
Nominal Thickness	0.030"-0.120" (0.8 mm - 3 mm)
Typical Thicknesses	1/16" (1.5 mm) 1/8" (3 mm)
316/316L Insert Thickness	0.002" (0.05 mm)
Temperature Limits	Cryogenic to 850°F (454°C)



*The values are taken from BFG-6.1 and ROTT. Test results are subject to interpretation and can lead to differing design constants.

LG-SS PRESSURE / TEMPERATURE GRAPH

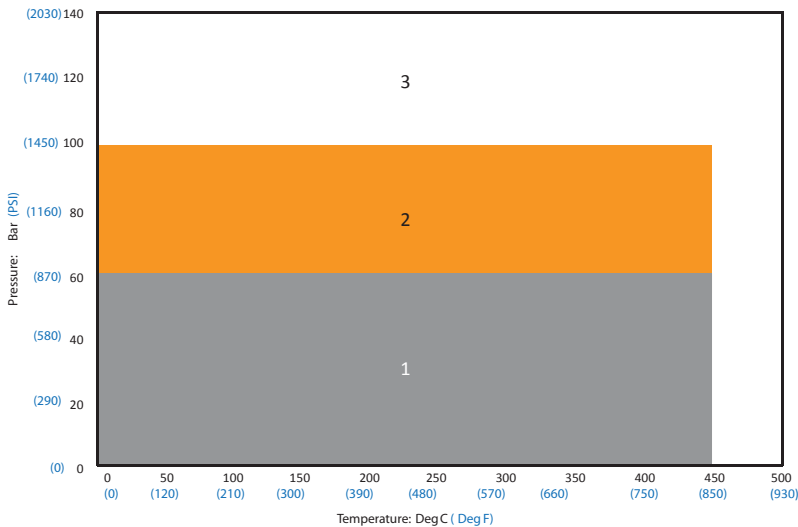

All Pressure / Temperature values are based on 1/16" (1.5 mm) gasket thickness.

1. Suitable (Chemical Compatibility has to be considered).
2. Please contact Lamons Engineering department for clarification. engineering@lamons.com
3. Not Suitable.

LAMONS LG-TC

LG-TC is a reinforced flexible graphite sheet material laminated with tanged 316/316L stainless steel insert and made with minimum 98% typical carbon content.



Creep Relaxation	<4%
Stability under stress (DIN 52913)	48 N/m ²
Compressibility	30%-40%
Recovery	15%-20%
ASME code factor "M value"	2
ASME code factor "Y value"	2500 psi
Number of inserts	1
Total chlorine (Max)	50 ppm
Density	70 lb/ft ³ (1.12 g/cc)
Ash content (Max)	1.0%
Tp max at 15,000 psi gasket stress	2287 psi (16 MPa)
PVRC design constants*:	G _b = 1400 psi a = 0.324 psi G _s = 0.010 psi
Gas permeability according DIN 3535 (0.60")	<1.0 ml/min
Nominal Thickness	0.030" - 0.120" (0.8 mm - 3 mm)
Typical Thicknesses	1/16" (1.5 mm) 1/8" (3 mm)
316/316L Insert Thickness	0.004"/0.005" (0.1/0.127 mm)
Temperature Limits	Cryogenic to 850°F (454°C)

*The values are taken from BFG-6.1 and ROTT. Test results are subject to interpretation and can lead to differing design constants.

All Pressure / Temperature values are based on 1/16" (1.5 mm) gasket thickness.

1. Suitable (Chemical Compatibility has to be considered).
2. Please contact Lamons Engineering department for clarification. engineering@lamons.com
3. Not Suitable.

LG-TC PRESSURE / TEMPERATURE GRAPH

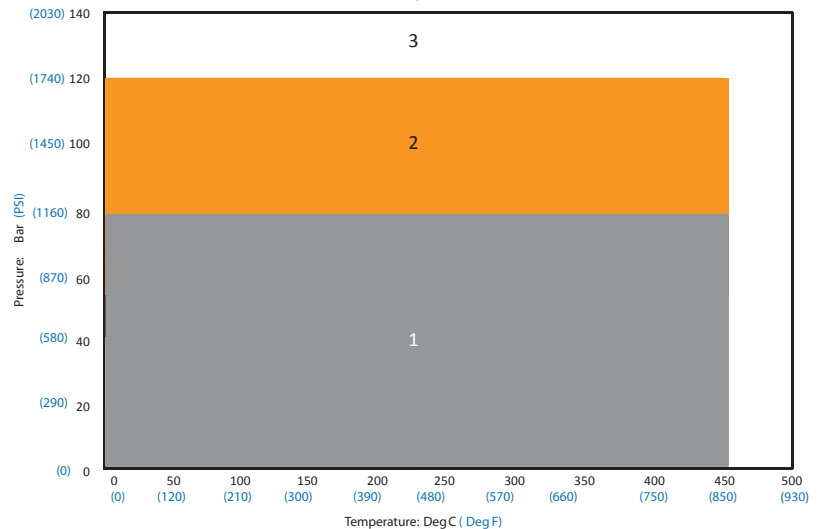

LAMONS LG-L

LG-L homogeneous graphite sheets are manufactured from high carbon content of minimum 98% natural graphite.

Creep Relaxation	<4%
Stability under stress (DIN 52913)	48 N/m ²
Compressibility	30%-40%
Recovery	15%-20%
ASME code factor "M value"	2
ASME code factor "Y value"	2500 psi
Number of inserts	1
Total chlorine (Max)	50 ppm
Density	62.4 lbs/ft ³ (0.99 g/cc) - 70 lbs/ft ³ (1.12 g/cc) (ASTM F-1315)
Ash content (Max)	1.0%
Tp max at 15,000 psi gasket stress	2287 psi (16 MPa)
PVRC design constants*:	G _b = 1400 psi a = 0.324 psi G _s = 0.010 psi
Gas permeability according DIN 3535 (0.60")	<1.0 ml/min
Nominal Thickness	0.030" - 0.120" (0.8 mm - 3 mm)
Typical Thicknesses	1/16" (1.5 mm) 1/8" (3 mm)
316/316L Insert Thickness	0.004"/0.005" (0.1/0.127 mm)
Temperature Limits	Cryogenic to 850°F (454°C)



*The values are taken from BFG-6.1 and ROTT. Test results are subject to interpretation and can lead to differing design constants.

LG-L PRESSURE / TEMPERATURE GRAPH

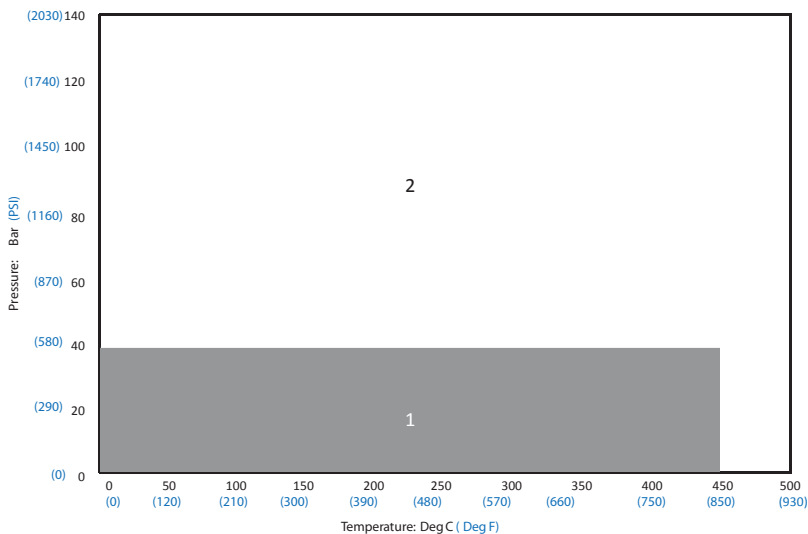

All Pressure / Temperature values are based on 1/16" (1.5 mm) gasket thickness.

1. Suitable (Chemical Compatibility has to be considered).
2. Not Suitable.

HIGH TEMPERATURE SHEET PRODUCTS

MICA

Mica sheet is a readily-processible form comprised of a high percentage of mineral held together with small amount of silicon binder. Its lamellar and non-fibrous structure, together with the low ratio of binder allows for a significant reduction of weight loss at elevated temperatures, and especially when compared to other high temperature compositions. It resists a wide array of chemicals and is unaffected by water, acids, bases, solvents and mineral oils.

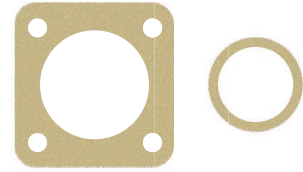

TYPICAL PHYSICAL PROPERTIES

Property	Method	Typical Values
Density	IEC 371-2	118 lbs/ft ³ (1.9 g/cc)
Tensile Strength	DIN 52910	2,900 psi (20 MPa)
Compressibility	ASTM F36-J	25%
Recovery	ASTM F36-J	35%
Ignition Loss @ 800°C	DIN 52911	<5%
Dielectric Strength	IEC 243 - 23°C	Approx. 20 kV/mm (508 V/mil)
Creep Strength 50MPa, 300°C	DIN 52913	Approx. 5801 psi (40 MPa)
Creep Strength 7252psi, 572°F	DIN 52913	5800 (40 MPa)
MAX Temperature	N/A	1832 (1000)
MAX Pressure	N/A	72.5 psi (5 bar)

Mica sheet is used in automobile exhaust manifolds, gas turbines, gas and oil burners, heat exchangers and other bolted flanged connections.

NOTE ON HIGH TEMPERATURE GASKETS: Lamons also utilizes mica in conjunction with oxidation resistant grade flexible graphite as a filler material for spiral wound gaskets, and as a facing material for kammprofiled and corrugated gaskets in the semi-metallic section. While the HTG configuration is not quite as high in temperature rating as mica sheet, it offers the sealing ability for pressure rating found in a semi-metallic gasket design

CERAMIC FIBER

Ceramic fiber is available in sheet or blanket form and makes an excellent gasket material for hot air duct work with low pressures and light flanges. It is satisfactory for service up to approximately 2000°F (1093°C). Ceramic material is also used as a filler material in spiral-wound gaskets.

NON - METALLIC GASKET DIMENSIONS FOR PIPE FLANGES

Soft material gaskets are dimensionally sized per ASME B16.21 for use with ASME B16.5 flanges. Non-metallic gaskets are used in Raised Face (RF), Flat Face (FF), Welding Neck (WN), and Slip On (SO) flanges. Typically, the outside diameter dimension is the bolt circle diameter minus one bolt diameter unless a full face gasket is requested.

ASME B16.21 GASKET TOLERANCES:

Nominal Pipe Size (NPS) 12 and smaller Outside Diameter (OD): +0.0", -1/16" (+0.0, -1.5 mm)

Nominal Pipe Size (NPS) 14 and Larger Outside Diameter (OD): +0.0", -1/8" (+0.0, -3.0 mm)

Nominal Pipe Size (NPS) 12 and smaller Inside Diameter (ID): $\pm 1/16"$ (± 1.5 mm)

Nominal Pipe Size (NPS) 14 and Larger Inside Diameter (ID): $\pm 1/8"$ (± 3.0 mm)

Bolt Circle Diameter: $\pm 1/16"$ (± 1.5 mm)

Center to center of adjacent bolt holes: $\pm 1/32"$ (± 1.0 mm)

DIMENSIONS FOR RING GASKETS PER ASME B16.21 TO SUIT ASME B16.5 FLANGES

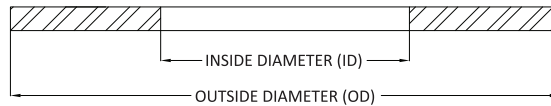

Nominal Pipe Size (NPS)	Class 150			
	Inside Diameter (ID)		Outside Diameter (OD)	
	Inches	mm	Inches	mm
1/2	0.84	21	1.88	48
3/4	1.06	27	2.25	57
1	1.31	33	2.62	67
1 1/4	1.66	42	3.00	76
1 1/2	1.91	49	3.38	86
2	2.38	60	4.12	105
2 1/2	2.88	73	4.88	124
3	3.50	89	5.38	137
3 1/2	4.00	102	6.38	162
4	4.50	114	6.88	175
5	5.56	141	7.75	197
6	6.62	168	8.75	222
8	8.62	219	11.00	279
10	10.75	273	13.38	340
12	12.75	324	16.13	410
14	14.00	356	17.75	451
16	16.00	406	20.25	514
18	18.00	457	21.62	549
20	20.00	508	23.88	607
24	24.00	610	28.25	718

DIMENSIONS FOR RING GASKETS PER ASME B16.21
TO SUIT ASME B16.5 FLANGES

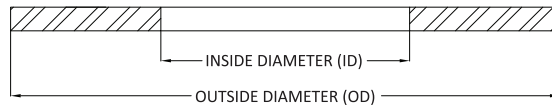

Nominal Pipe Size (NPS)	Class 300			
	Inside Diameter (ID)		Outside Diameter (OD)	
	Inches	mm	Inches	mm
1/2	0.84	21	2.12	54
3/4	1.06	27	2.62	67
1	1.31	33	2.88	73
1 1/4	1.66	42	3.25	83
1 1/2	1.91	49	3.75	95
2	2.38	60	4.38	111
2 1/2	2.88	73	5.12	130
3	3.50	89	5.88	149
3 1/2	4.00	102	6.50	165
4	4.50	114	7.12	181
5	5.56	141	8.50	216
6	6.62	168	9.88	251
8	8.62	219	12.12	308
10	10.75	273	14.25	362
12	12.75	324	16.62	422
14	14.00	356	19.12	486
16	16.00	406	21.25	540
18	18.00	457	23.50	597
20	20.00	508	25.75	654
24	24.00	610	30.50	775

Nominal Pipe Size (NPS)	Class 400			
	Inside Diameter (ID)		Outside Diameter (OD)	
	Inches	mm	Inches	mm
1/2	0.84	21	2.12	54
3/4	1.06	27	2.62	67
1	1.31	33	2.88	73
1 1/4	1.66	42	3.25	83
1 1/2	1.91	49	3.75	95
2	2.38	60	4.38	111
2 1/2	2.88	73	5.12	130
3	3.50	89	5.88	149
3 1/2	4.00	102	6.38	162
4	4.50	114	7.00	178
5	5.56	141	8.38	213
6	6.62	168	9.75	248
8	8.62	219	12.00	305
10	10.75	273	14.12	359
12	12.75	324	16.50	419
14	14.00	356	19.00	483
16	16.00	406	21.12	536
18	18.00	457	23.38	594
20	20.00	508	25.50	648
24	24.00	610	30.25	768

DIMENSIONS FOR RING GASKETS PER ASME B16.21
TO SUIT ASME B16.5 FLANGES

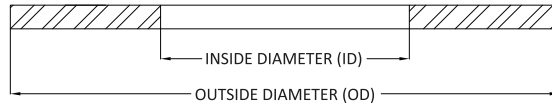

Nominal Pipe Size (NPS)	Class 600			
	Inside Diameter (ID)		Outside Diameter (OD)	
	Inches	mm	Inches	mm
1/2	0.84	21	2.12	54
3/4	1.06	27	2.62	67
1	1.31	33	2.88	73
1 1/4	1.66	42	3.25	83
1 1/2	1.91	49	3.75	95
2	2.38	60	4.38	111
2 1/2	2.88	73	5.12	130
3	3.50	89	5.88	149
3 1/2	4.00	102	6.38	162
4	4.50	114	7.62	194
5	5.56	141	9.50	241
6	6.62	168	10.50	267
8	8.62	219	12.62	321
10	10.75	273	15.75	400
12	12.75	324	18.00	457
14	14.00	356	19.38	492
16	16.00	406	22.25	565
18	18.00	457	24.12	613
20	20.00	508	26.88	683
24	24.00	610	31.12	791

DIMENSIONS FOR FULL FACE GASKETS
TO SUIT ASME B16.5 FLANGES

Class 150								
Nominal Pipe Size (NPS)	Inside Diameter (ID)		Outside Diameter (OD)		# of Bolt Holes	Bolt Hole Diameter (Inches)	Bolt Circle Diameter (BCD)	
	Inches	mm	Inches	mm			Inches	mm
1/2	0.84	21	3.50	89	4	0.62	2.38	60.3
3/4	1.06	27	3.88	99	4	0.62	2.75	69.9
1	1.31	33	4.25	108	4	0.62	3.12	79.4
1 1/4	1.66	42	4.63	118	4	0.62	3.50	88.9
1 1/2	1.91	49	5.00	127	4	0.62	3.88	98.4
2	2.38	60	6.00	152	4	0.75	4.75	120.7
2 1/2	2.88	73	7.00	178	4	0.75	5.50	139.7
3	3.50	89	7.50	191	4	0.75	6.00	152.4
3 1/2	4.00	102	8.50	216	8	0.75	7.00	177.8
4	4.50	114	9.00	229	8	0.75	7.50	190.5
5	5.56	141	10.00	254	8	0.88	8.50	215.9
6	6.62	168	11.00	279	8	0.88	9.50	241.3
8	8.62	219	13.50	343	8	0.88	11.75	298.5
10	10.75	273	16.00	406	12	1.00	14.25	362.0
12	12.75	324	19.00	483	12	1.00	17.00	431.8
14	14.00	356	21.00	533	12	1.12	18.75	476.3
16	16.00	406	23.50	597	16	1.12	21.25	539.8
18	18.00	457	25.00	635	16	1.25	22.75	577.9
20	20.00	508	27.50	699	20	1.25	25.00	635.0
24	24.00	610	32.00	813	20	1.38	29.50	749.3

Class 300								
Nominal Pipe Size (NPS)	Inside Diameter (ID)		Outside Diameter (OD)		# of Bolt Holes	Bolt Hole Diameter (Inches)	Bolt Circle Diameter (BCD)	
	Inches	mm	Inches	mm			Inches	mm
1/2	0.84	21	3.75	95	4	0.63	2.63	66.8
3/4	1.06	27	4.62	117	4	0.75	3.25	82.6
1	1.31	33	4.88	124	4	0.75	3.50	88.9
1 1/4	1.66	42	5.25	133	4	0.75	3.88	98.4
1 1/2	1.91	49	6.12	155	4	0.88	4.50	114.3
2	2.38	60	6.50	165	8	0.75	5.00	127.0
2 1/2	2.88	73	7.50	191	8	0.88	5.88	149.2
3	3.50	89	8.25	210	8	0.88	6.63	168.3
3 1/2	4.00	102	9.00	229	8	0.88	7.25	184.2
4	4.50	114	10.00	254	8	0.88	7.88	200.0
5	5.56	141	11.00	279	8	0.88	9.25	235.0
6	6.62	168	12.50	318	12	0.88	10.63	269.9
8	8.62	219	15.00	381	12	1.00	13.00	330.2
10	10.75	273	17.50	445	16	1.13	15.25	387.4
12	12.75	324	20.50	521	16	1.25	17.75	450.9
14	14.00	356	23.00	584	20	1.25	20.25	514.4
16	16.00	406	25.50	648	20	1.38	22.50	571.5
18	18.00	457	28.00	711	24	1.38	24.75	628.7
20	20.00	508	30.50	775	24	1.38	27.00	685.8
24	24.00	610	36.00	914	24	1.63	32.00	812.8

DIMENSIONS FOR FULL FACE GASKETS
TO SUIT ASME B16.5 FLANGES

Class 400								
Nominal Pipe Size (NPS)	Inside Diameter (ID)		Outside Diameter (OD)		# of Bolt Holes	Bolt Hole Diameter (Inches)	Bolt Circle Diameter (BCD)	
	Inches	mm	Inches	mm			Inches	mm
1/2	0.84	21	3.75	95	4	0.63	2.62	66.5
3/4	1.06	27	4.63	117	4	0.75	3.25	82.6
1	1.31	33	4.88	124	4	0.75	3.50	88.9
1 1/4	1.66	42	5.25	133	4	0.75	3.88	98.4
1 1/2	1.91	49	6.13	156	4	0.88	4.50	114.3
2	2.38	60	6.50	165	8	0.75	5.00	127.0
2 1/2	2.88	73	7.50	191	8	0.88	5.88	149.2
3	3.50	89	8.25	210	8	0.88	6.63	168.3
3 1/2	4.00	102	9.00	229	8	1.00	7.25	184.2
4	4.50	114	10.00	254	8	1.00	7.88	200.0
5	5.56	141	11.00	279	8	1.00	9.25	235.0
6	6.62	168	12.50	318	12	1.00	10.63	269.9
8	8.62	219	15.00	381	12	1.13	13.00	330.2
10	10.75	273	17.50	445	16	1.25	15.25	387.4
12	12.75	324	20.50	521	16	1.38	17.75	450.9
14	14.00	356	23.00	584	20	1.38	20.25	514.4
16	16.00	406	25.50	648	20	1.50	22.50	571.5
18	18.00	457	28.00	711	24	1.50	24.75	628.7
20	20.00	508	30.50	775	24	1.63	27.00	685.8
24	24.00	610	36.00	914	24	1.88	32.00	812.8

Class 600								
Nominal Pipe Size (NPS)	Inside Diameter (ID)		Outside Diameter (OD)		# of Bolt Holes	Bolt Hole Diameter (Inches)	Bolt Circle Diameter (BCD)	
	Inches	mm	Inches	mm			Inches	mm
1/2	0.84	21	3.75	95	4	0.63	2.63	66.8
3/4	1.06	27	4.63	117	4	0.75	3.25	82.6
1	1.31	33	4.88	124	4	0.75	3.50	88.9
1 1/4	1.66	42	5.25	133	4	0.75	3.88	98.4
1 1/2	1.91	49	6.13	156	4	0.88	4.50	114.3
2	2.38	60	6.50	165	8	0.75	5.00	127.0
2 1/2	2.88	73	7.50	191	8	0.88	5.88	149.2
3	3.50	89	8.25	210	8	0.88	6.63	168.3
3 1/2	4.00	102	9.00	229	8	1.00	7.25	184.2
4	4.50	114	10.75	273	8	1.00	8.50	215.9
5	5.56	141	13.00	330	8	1.13	10.50	266.7
6	6.62	168	14.00	356	12	1.13	11.50	292.1
8	8.62	219	16.50	419	12	1.25	13.75	349.3
10	10.75	273	20.00	508	16	1.38	17.00	431.8
12	12.75	324	22.00	559	20	1.38	19.25	489.0
14	14.00	356	23.75	603	20	1.50	20.75	527.1
16	16.00	406	27.00	686	20	1.63	23.75	603.3
18	18.00	457	29.25	743	20	1.75	25.75	654.1
20	20.00	508	32.00	813	24	1.75	28.50	723.9
24	24.00	610	37.00	940	24	2.00	33.00	838.2

DIMENSIONS FOR RING GASKETS PER ASME B16.21
TO SUIT ASME B16.47 SERIES A FLANGES

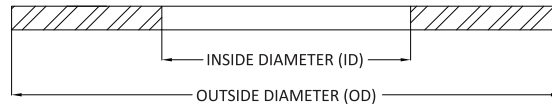

Nominal Pipe Size (NPS)	Class 150			
	Inside Diameter (ID)		Outside Diameter (OD)	
	Inches	mm	Inches	mm
26	26.00	660	30.50	775
28	28.00	711	32.75	832
30	30.00	762	34.75	883
32	32.00	813	37.00	940
34	34.00	864	39.00	991
36	36.00	914	41.25	1048
38	38.00	965	43.75	1111
40	40.00	1016	45.75	1162
42	42.00	1067	48.00	1219
44	44.00	1118	50.25	1276
46	46.00	1168	52.25	1327
48	48.00	1219	54.50	1384
50	50.00	1270	56.50	1435
52	52.00	1321	58.75	1492
54	54.00	1372	61.00	1549
56	56.00	1422	63.25	1607
58	58.00	1473	65.50	1664
60	60.00	1524	67.50	1715

Nominal Pipe Size (NPS)	Class 300			
	Inside Diameter (ID)		Outside Diameter (OD)	
	Inches	mm	Inches	mm
26	26.00	660	32.88	835
28	28.00	711	35.38	899
30	30.00	762	37.50	953
32	32.00	813	39.62	1006
34	34.00	864	41.62	1057
36	36.00	914	44.00	1118
38	38.00	965	41.50	1054
40	40.00	1016	43.88	1115
42	42.00	1067	45.88	1165
44	44.00	1118	48.00	1219
46	46.00	1168	50.12	1273
48	48.00	1219	52.12	1324
50	50.00	1270	54.25	1378
52	52.00	1321	56.25	1429
54	54.00	1372	58.75	1492
56	56.00	1422	60.75	1543
58	58.00	1473	62.75	1594
60	60.00	1524	64.75	1645

DIMENSIONS FOR RING GASKETS PER ASME B16.21
TO SUIT ASME B16.47 SERIES A FLANGES

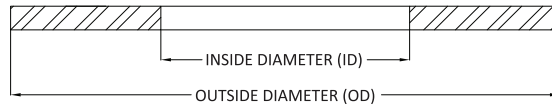

Class 400				
Nominal Pipe Size (NPS)	Inside Diameter (ID)		Outside Diameter (OD)	
	Inches	mm	Inches	mm
26	26.00	660	32.75	832
28	28.00	711	35.12	892
30	30.00	762	37.25	946
32	32.00	813	39.50	1003
34	34.00	864	41.50	1054
36	36.00	914	44.00	1118
38	38.00	965	42.25	1073
40	40.00	1016	44.38	1127
42	42.00	1067	46.38	1178
44	44.00	1118	48.50	1232
46	46.00	1168	50.75	1289
48	48.00	1219	53.00	1346
50	50.00	1270	55.25	1403
52	52.00	1321	57.26	1454
54	54.00	1372	59.75	1518
56	56.00	1422	61.75	1568
58	58.00	1473	63.75	1619
60	60.00	1524	66.25	1683

Class 600				
Nominal Pipe Size (NPS)	Inside Diameter (ID)		Outside Diameter (OD)	
	Inches	mm	Inches	mm
26	26.00	660	34.12	867
28	28.00	711	36.00	914
30	30.00	762	38.25	972
32	32.00	813	40.25	1022
34	34.00	864	42.25	1073
36	36.00	914	44.50	1130
38	38.00	965	43.50	1105
40	40.00	1016	45.50	1156
42	42.00	1067	48.00	1219
44	44.00	1118	50.00	1270
46	46.00	1168	52.26	1327
48	48.00	1219	54.75	1391
50	50.00	1270	57.00	1448
52	52.00	1321	59.00	1499
54	54.00	1372	61.25	1556
56	56.00	1422	63.50	1613
58	58.00	1473	65.50	1664
60	60.00	1524	67.75	1721

**DIMENSIONS FOR FULL FACE GASKETS TO SUIT
ASME B16.47 SERIES A FLANGES**

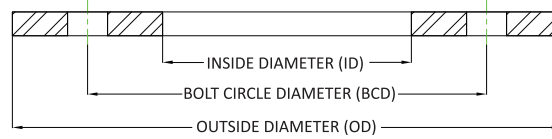

Class 150								
Nominal Pipe Size (NPS)	Inside Diameter (ID)		Outside Diameter (OD)		# of Bolt Holes	Bolt Hole Diameter	Bolt Circle Diameter (BCD)	
	Inches	mm	Inches	mm			Inches	mm
26	26.00	660	34.25	870	24	1.38	31.75	806.5
28	28.00	711	36.50	927	28	1.38	34.00	863.6
30	30.00	762	38.75	984	28	1.38	36.00	914.4
32	32.00	813	41.75	1060	28	1.63	38.50	977.9
34	34.00	864	43.75	1111	32	1.63	40.50	1028.7
36	36.00	914	46.00	1168	32	1.63	42.75	1085.9
38	38.00	965	48.75	1238	32	1.63	45.25	1149.4
40	40.00	1016	50.75	1289	36	1.63	47.25	1200.2
42	42.00	1067	53.00	1346	36	1.63	49.50	1257.3
44	44.00	1118	55.25	1403	40	1.63	51.75	1314.5
46	46.00	1168	57.25	1454	40	1.63	53.75	1365.3
48	48.00	1219	59.50	1511	44	1.63	56.00	1422.4
50	50.00	1270	61.75	1568	44	1.88	58.25	1479.6
52	52.00	1321	64.00	1626	44	1.88	60.50	1536.7
54	54.00	1372	66.25	1683	44	1.88	62.75	1593.9
56	56.00	1422	68.75	1746	48	1.88	65.00	1651.0
58	58.00	1473	71.00	1803	48	1.88	67.25	1708.2
60	60.00	1524	73.00	1854	52	1.88	69.25	1759.0

Class 300								
Nominal Pipe Size (NPS)	Inside Diameter (ID)		Outside Diameter (OD)		# of Bolt Holes	Bolt Hole Diameter	Bolt Circle Diameter (BCD)	
	Inches	mm	Inches	mm			Inches	mm
26	26.00	662	38.25	972	28	1.75	34.50	876.3
28	28.00	713	40.75	1035	28	1.75	37.00	939.8
30	30.00	764	43.00	1092	28	1.88	39.25	997.0
32	32.00	815	45.25	1149	28	2.00	41.50	1054.1
34	34.00	866	47.50	1207	28	2.00	43.50	1104.9
36	36.00	917	50.00	1270	32	2.13	46.00	1168.4
38	38.00	968	46.00	1168	32	1.63	43.00	1092.2
40	40.00	1019	48.75	1238	32	1.75	45.50	1155.7
42	42.00	1070	50.75	1289	32	1.75	47.50	1206.5
44	44.00	1121	53.25	1353	32	1.88	49.75	1263.7
46	46.00	1172	55.75	1416	28	2.00	52.00	1320.8
48	48.00	1223	57.75	1467	32	2.00	54.00	1371.6
50	50.00	1274	60.25	1530	32	2.13	56.25	1428.8
52	52.00	1324	62.25	1581	32	2.13	58.25	1479.6
54	54.00	1375	65.25	1657	28	2.38	61.00	1549.4
56	56.00	1426	67.25	1708	28	2.38	63.00	1600.2
58	58.00	1477	69.25	1759	32	2.38	65.00	1651.0
60	60.00	1528	71.25	1810	32	2.38	67.00	1701.8

DIMENSIONS FOR RING GASKETS PER ASME B16.21
TO SUIT ASME B16.47 SERIES B FLANGES

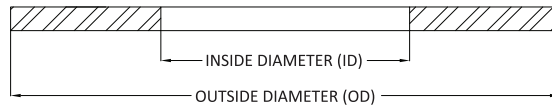

Nominal Pipe Size (NPS)	Class 150			
	Inside Diameter (ID)		Outside Diameter (OD)	
	Inches	mm	Inches	mm
26	26.00	660	28.56	725
28	28.00	711	30.56	776
30	30.00	762	32.56	827
32	32.00	813	34.69	881
34	34.00	864	36.81	935
36	36.00	914	38.88	988
38	38.00	965	41.12	1044
40	40.00	1016	43.12	1095
42	42.00	1067	45.12	1146
44	44.00	1118	47.12	1197
46	46.00	1168	49.44	1256
48	48.00	1219	51.44	1307
50	50.00	1270	53.44	1357
52	52.00	1321	55.44	1408
54	54.00	1372	57.62	1464
56	56.00	1422	59.62	1514
58	58.00	1473	62.19	1580
60	60.00	1524	64.19	1630

Nominal Pipe Size (NPS)	Class 300			
	Inside Diameter (ID)		Outside Diameter (OD)	
	Inches	mm	Inches	mm
26	26.00	660	30.38	772
28	28.00	711	32.50	826
30	30.00	762	34.88	886
32	32.00	813	37.00	940
34	34.00	864	39.12	994
36	36.00	914	41.25	1048
38	38.00	965	43.25	1099
40	40.00	1016	45.25	1149
42	42.00	1067	47.25	1200
44	44.00	1118	49.25	1251
46	46.00	1168	51.88	1318
48	48.00	1219	53.88	1369
50	50.00	1270	55.88	1419
52	52.00	1321	57.88	1470
54	54.00	1372	60.25	1530
56	56.00	1422	62.75	1594
58	58.00	1473	65.19	1656
60	60.00	1524	67.12	1705

DIMENSIONS FOR FLAT RING GASKETS PER ASME B16.21
TO SUIT ASME B16.47 SERIES B FLANGES

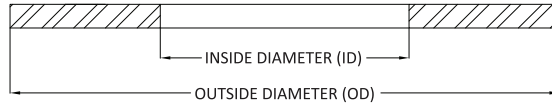

Class 400				
Nominal Pipe Size (NPS)	Inside Diameter (ID)		Outside Diameter (OD)	
	Inches	mm	Inches	mm
26	26.00	660	29.38	746
28	28.00	711	31.50	800
30	30.00	762	33.75	857
32	32.00	813	35.88	911
34	34.00	864	37.88	962
36	36.00	914	40.25	1022

Class 600				
Nominal Pipe Size (NPS)	Inside Diameter (ID)		Outside Diameter (OD)	
	Inches	mm	Inches	mm
26	26.00	660	30.12	765
28	28.00	711	32.25	819
30	30.00	762	34.62	879
32	32.00	813	36.75	933
34	34.00	864	39.25	997
36	36.00	914	41.25	1048

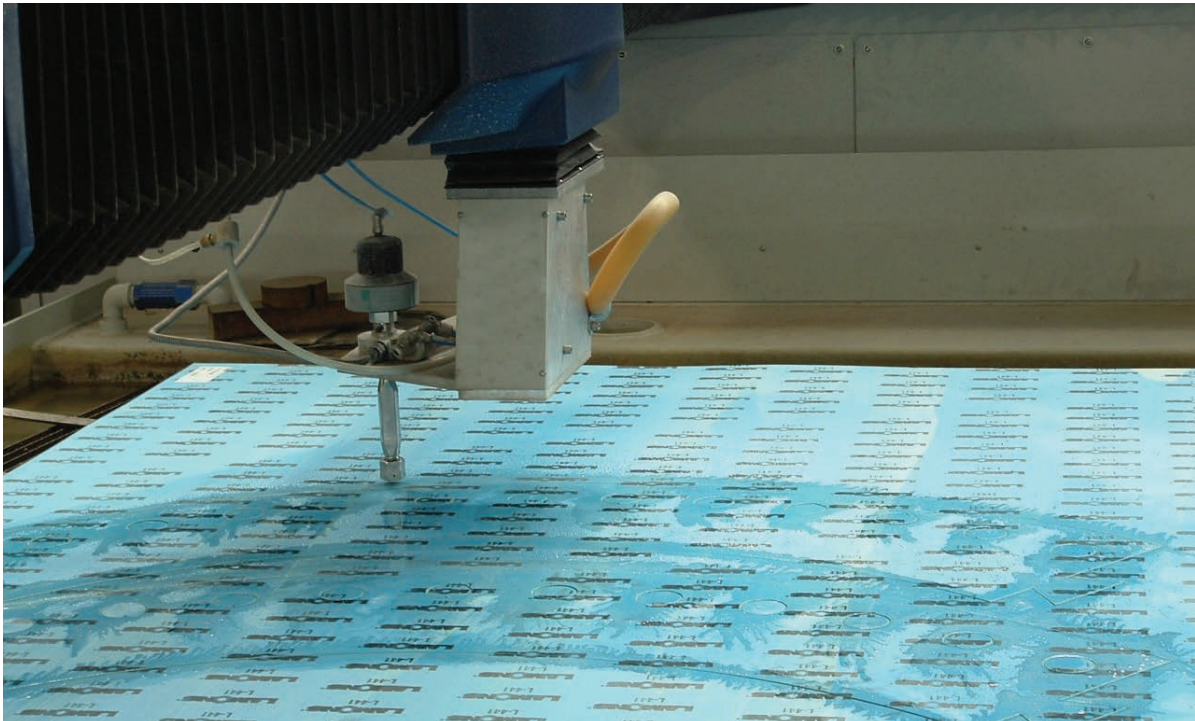

DIMENSIONS FOR FULL FACE GASKETS TO SUIT
ASME B16.47 SERIES B FLANGES

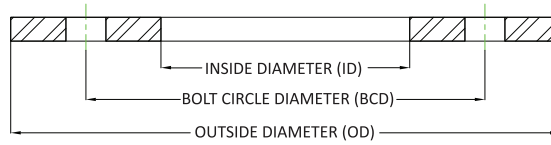

Nominal Pipe Size (NPS)	Class 150							
	Inside Diameter (ID)		Outside Diameter (OD)		# of Bolt Holes	Bolt Hole Diameter	Bolt Circle Diameter (BCD)	
	Inches	mm	Inches	mm			Inches	mm
26	26.00	660	30.94	786	36	0.88	29.31	744.5
28	28.00	711	32.94	837	40	0.88	31.31	795.3
30	30.00	762	34.94	887	44	0.88	33.31	846.1
32	32.00	813	37.06	941	48	0.88	35.44	900.2
34	34.00	864	39.56	1005	40	1.00	37.69	957.3
36	36.00	914	41.63	1057	44	1.00	39.75	1009.7
38	38.00	965	44.25	1124	40	1.13	42.13	1070.1
40	40.00	1016	46.25	1175	44	1.13	44.13	1120.9
42	42.00	1067	48.25	1226	48	1.13	46.13	1171.7
44	44.00	1118	50.25	1276	52	1.13	48.13	1222.5
46	46.00	1168	52.81	1341	40	1.25	50.56	1284.2
48	48.00	1219	54.81	1392	44	1.25	52.56	1335.0
50	50.00	1270	56.81	1443	48	1.25	54.56	1385.8
52	52.00	1321	58.81	1494	52	1.25	56.56	1436.6
54	54.00	1372	61.00	1549	56	1.25	58.75	1492.3
56	56.00	1422	63.00	1600	60	1.25	60.75	1543.1
58	58.00	1473	65.94	1675	48	1.38	63.44	1611.4
60	60.00	1524	67.94	1726	52	1.38	65.44	1662.2

Nominal Pipe Size (NPS)	Class 300							
	Inside Diameter (ID)		Outside Diameter (OD)		# of Bolt Holes	Bolt Hole Diameter	Bolt Circle Diameter (BCD)	
	Inches	mm	Inches	mm			Inches	mm
26	26.00	660	34.13	867	32	1.38	31.63	803.4
28	28.00	711	36.25	921	36	1.38	33.75	857.3
30	30.00	762	39.00	991	36	1.50	36.25	920.8
32	32.00	813	41.50	1054	32	1.63	38.50	977.9
34	34.00	864	43.63	1108	36	1.63	40.63	1032.0
36	36.00	914	46.13	1172	32	1.75	42.88	1089.2
38	38.00	965	48.13	1223	36	1.75	44.88	1140.0
40	40.00	1016	50.13	1273	40	1.75	46.88	1190.8
42	42.00	1067	52.50	1334	36	1.88	49.00	1244.6
44	44.00	1118	54.50	1384	40	1.88	51.00	1295.4
46	46.00	1168	57.50	1461	36	2.00	53.75	1365.3
48	48.00	1219	59.50	1511	40	2.00	55.75	1416.1
50	50.00	1270	61.50	1562	44	2.00	57.75	1466.9
52	52.00	1321	63.50	1613	48	2.00	59.75	1517.7
54	54.00	1372	65.88	1673	48	2.00	62.13	1578.1
56	56.00	1422	69.50	1765	36	2.38	65.00	1651.0
58	58.00	1473	71.94	1827	40	2.38	67.44	1713.0
60	60.00	1524	73.94	1878	40	2.38	69.44	1763.8

SECTION TWO: SEMI-METALLIC GASKETS

Semi-Metallic gaskets are designed to feature soft, pliable sealing materials - which enhance the tightness of the assembly with lower overall load requirements when compared to full metallic gaskets. They are most popular due to this configuration, and are available in a wide variety of styles and sizes. They can typically be fabricated of any metal which is available in thin strip or sheet, and which can be welded. Therefore, they can be used against virtually any corrosive medium dependent upon the choice of the metal and filler/facing material. Additionally, they can be used over the complete temperature range from cryogenic to approximately 2000°F (1093°C). Semi-metallic gaskets can generally be used in pressures ranging from vacuum to those seen in ASME B16.5 standard 2500 pressure class flange ratings. They are resilient and, as a consequence, can compensate somewhat for flange movement that may occur due to temperature gradients, variations of pressure and vibration.

Lamons offers the following filler / facing materials for semi-metallic gaskets:

TEMPERATURE RANGE

PTFE	Cryogenic to 500°F (260°C)
Flexible Graphite	Cryogenic to 850°F (454°C)
Oxidation Resistant Grade Flexible Graphite	Cryogenic to 975°F (524°C)
HTG (High Temperature Gasket)	Cryogenic to 1500°F (816°C)
Mica	Cryogenic to 1832°F (1000°C)
Ceramic	Cryogenic to 2000°F (1093°C)

LAMONS CORRUKAMM™ PRODUCT FAMILY

The Lamons CorruKamm™ resembles a typical kammprofiled sealing element in that it utilizes a heavy substrate capable of extreme load bearing properties. The dramatic feature that this design incorporates is a precisely located corrugated pattern which greatly enhances the ability to deflect and compress under load. This creates a scenario in which the gasket will be more forgiving where perfect alignment and parallelism do not exist.

The base core material is very thick and resembles what is used with traditional kammprofile technology. This added substrate thickness, with an exacting corrugated pattern allows the gasket to recover substantially and maintain very stable load bearing characteristics. A kammprofile incorporates a specific serration pattern on both sealing surfaces that do not relate in any way to the opposing sides. The CorruKamm™ technology utilizes a geometry on the sealing surface that is machined rather than formed. These corrugation profiles are strategically aligned so that deflection can occur and maximum resilience and recovery can be achieved.

Lamons CorruKamm™ technology is a revolutionary new design that provides the benefits of a kammprofile technology with the additional attribute of recovery that is desired to offset flange relaxation and unloading. It combines the proven concepts of a kammprofile and a corrugated design.

The result eliminates many of the deficiencies found in both designs while consolidating the benefits. A machined profile, not formed, allows for a correcting alternated geometry, strategically indexed and aligned so that deflection occurs. The result is maximum stability, recovery, resiliency, deflection and conformance.



CORRUKAMM™ CK1

Lamons Corrugated Metal Gasket (CMG) is manufactured without a guide ring for tongue and groove, or recessed flange applications such as male and female. It is typically used in heat exchanger applications and applied as an upgrade to double jacketed gaskets. It is highly suggested to have the nubbin (if present) machined out as a best practice. Where pass partitions are required, they are also kamm profiled and laminated. They are the same thickness as the ring, and securely held in place with welds.

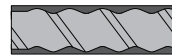

CORRUKAMM™ CK2

Lamons CMG-EX gasket is constructed with an integral guide ring for aligning purposes. It is suggested to be used in raised face flanges. The gasket is typically designed and sized per EN12560-6 spec for ASME B16.5 flanges, but can be manufactured to fit other standards.



CORRUKAMM™ HTG

Lamons CMG-PTFE gasket is a problem solver for higher operating temperature scenarios. It utilizes sections of high performance mica/ phyllosilicate that protect oxidation resistant grade graphite and shields it from contact with oxidizers. It represents the best technology available in regards to torque retention and sealing ability at elevated temperatures. Lamons CMG-PTFE gaskets can be applied to high temperature applications to 1500°F (850°C) or higher, depending on operating conditions.

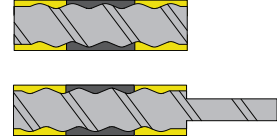

CORRUKAMM™ PTFE

Lamons CMG-EX gasket is a premium variation of Lamons original CMG gasket. The CMG-EX was designed specifically for heat exchanger applications and provides superior performance in cyclic applications and where a high level of radial shear is present. Differential movement between flanges can cause tremendous relaxation issues on traditional heat exchanger gaskets. This problem is addressed in the design of the CMG-EX gasket, as it maintains a highest degree of tightness through operation and the full cycle event.

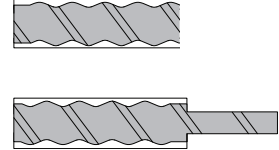

LAMONS KAMMPRO® GASKET PRODUCT FAMILY

Lamons Kammpro gaskets are recognized as a problem solver for heat exchangers, large vessels, and equipment that experience excessive movement due to thermal expansion. The Kammpro provides one of the tightest seals combined with superior load bearing characteristics. Kammpro gaskets consist of a metal sealing core with or without a guide ring. The sealing core is a solid metal gasket with concentric serrations on both sealing surfaces and faced with a soft material such as flexible graphite, EPTFE, or a Lamons HTG configuration depending on operating conditions. It is the preferred design when needing improved performance at low seating stresses. The simultaneous actions of a high compressibility facing material on the outside of the grooved metal in combination with limited penetration of the tips of the solid metal core enhance the interaction of the two materials. This allows the components to perform individually to their optimum capabilities. Kammpro gaskets are manufactured in different materials and non-circular shapes with extreme accuracy. They can also be custom engineered to fit various applications. The suggested flange surface finish for Kammpro gaskets is 125-250 AARH.



KAMMPRO LP1 is manufactured without a guide ring for tongue and groove, or recessed flange applications such as male and female. It is typically used in heat exchanger applications and applied as an upgrade to double jacketed gaskets. It is highly suggested to have the nubbin (if present) machined out as a best practice. Where pass partitions are required, they are also kamm profiled and laminated. They are the same thickness as the ring, and securely held in place with welds.

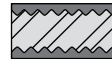

KAMMPRO LP2 is constructed with an integral guide ring for aligning purposes. It is suggested to be used in raised face flanges. The gasket is typically designed and sized per EN12560-6 spec for ASME B16.5 flanges, but can be manufactured to fit other standards.

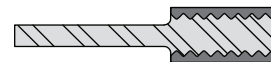

KAMMPRO LP3 utilizes a loose fit guide ring. This popular design is preferred for nominal pipe size and pressure class raised face flanges and is used in equipment with excessive radial shear characteristics, thermal cycling, and expansions. The gasket is typically designed and sized per EN12560-6 spec for ASME B16.5 flanges, but can be manufactured to fit other standards.

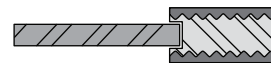

KAMMPRO-HTG is a problem solver for higher operating temperature scenarios. It utilizes sections of high performance mica/phyllsilicate that protect oxidation resistant grade graphite and shields it from contact with oxidizers. Lamons Kammpro-HTG represents the best technology available in regards to torque retention and sealing ability at elevated temperatures. Lamons Kammpro HTG gaskets can be applied to high temperature applications to 1500°F (850°C) or higher, depending on operating conditions.

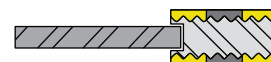

KAMMPRO ACHE (FIN FAN) gaskets are specifically designed to replace traditional solid metal “washer” type gaskets typically used in air cooled heat exchangers. The design takes advantage of the serrated profile with graphite facing to bite against the finish of the header plate.



KAMMPRO DUAL SEAL gaskets are designed to mate with leak detection devices incorporated into flanged assemblies used in critical applications, such as lethal service. This highly effective gasket has a primary seal followed towards the outer portion of the sealing area by a relief section with through holes, where the leak detection equipment is mounted. Past this relief section is a secondary sealing area that will maintain the integrity of the bolted joint should the primary seal be compromised and pressure differential is identified.

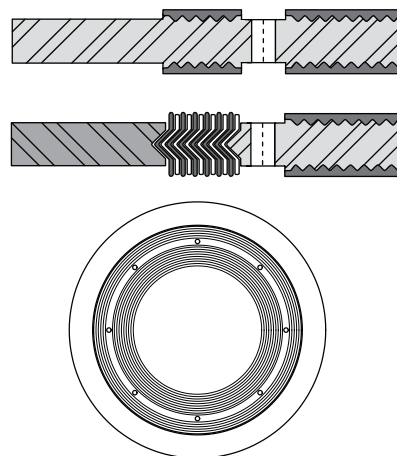

**DIMENSIONS FOR KAMMPRO LP3/LP2 PER EN 12560-6
TO SUIT ASME B16.5 FLANGES (INCHES)**

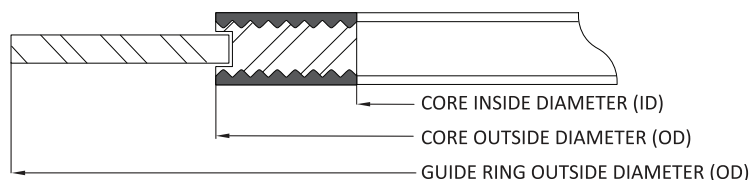

Nominal Pipe Size (NPS)	Core Inside Diameter (ID) Inches	Core Outside Diameter (OD) Inches	Guide Ring Outside Diameter (OD)						
			Class 150 Inches	Class 300 Inches	Class 400 Inches	Class 600 Inches	Class 900 Inches	Class 1500 Inches	Class 2500 Inches
1/2	0.91	1.31	1.75	2.00	2.00	2.00	2.37	2.37	2.63
3/4	1.13	1.56	2.12	2.50	2.50	2.50	2.63	2.63	2.87
1	1.44	1.87	2.50	2.75	2.75	2.75	3.00	3.00	3.25
1 1/4	1.75	2.37	2.87	3.13	3.13	3.13	3.37	3.37	4.00
1 1/2	2.06	2.75	3.25	3.63	3.63	3.63	3.75	3.75	4.50
2	2.75	3.50	4.00	4.25	4.25	4.25	5.50	5.50	5.62
2 1/2	3.25	4.00	4.75	5.00	5.00	5.00	6.37	6.37	6.50
3	3.87	4.87	5.25	5.75	5.75	5.75	6.50	6.75	7.63
3 1/2	4.37	5.37	6.25	6.37	6.25	6.25	-	-	-
4	4.87	6.06	6.75	7.00	6.87	7.50	8.00	8.13	9.12
5	5.94	7.19	7.63	8.37	8.25	9.37	9.63	9.87	10.87
6	7.00	8.37	8.63	9.75	9.63	10.37	11.25	11.00	12.37
8	9.00	10.50	10.87	12.00	11.87	12.50	14.00	9.81	15.12
10	11.13	12.63	13.25	14.13	14.00	15.63	17.00	17.00	18.62
12	13.37	14.87	16.00	16.50	16.37	17.87	19.50	20.37	21.50
14	14.63	16.13	17.63	19.00	18.87	19.25	20.37	22.63	-
16	16.63	18.37	20.13	21.13	21.00	22.12	22.50	25.12	-
18	18.87	20.87	21.50	23.37	23.25	24.00	25.00	27.63	-
20	20.87	22.87	23.75	25.63	25.37	26.75	27.37	29.62	-
22	22.87	24.87	25.87	27.63	27.50	28.75	-	-	-
24	24.87	26.87	28.13	30.37	30.13	31.00	32.87	35.37	-

**DIMENSIONS FOR KAMMPRO LP3/LP2 PER EN 12560-6
TO SUIT ASME B16.5 FLANGES (MILLIMETERS)**

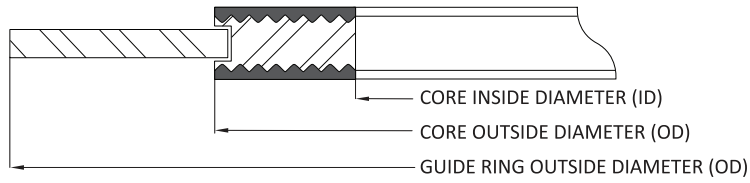

Nominal Pipe Size (NPS)	Core Inside Diameter (ID)	Core Outside Diameter (OD)	Guide Ring Outside Diameter (OD)						
			Class 150	Class 300	Class 400	Class 600	Class 900	Class 1500	Class 2500
	mm	mm	mm	mm	mm	mm	mm	mm	mm
1/2	23.0	33.3	44.4	50.8	50.8	50.8	60.3	60.3	66.7
3/4	28.6	39.7	53.9	63.5	63.5	63.5	66.7	66.7	73.0
1	36.5	47.6	63.5	69.8	69.8	69.8	76.2	76.2	82.5
1 1/4	44.4	60.3	73.0	79.4	79.4	79.4	85.7	85.7	101.6
1 1/2	52.4	69.8	82.5	92.1	92.1	92.1	95.2	95.2	114.3
2	69.8	88.9	101.6	108.0	108.0	108.0	139.7	139.7	142.8
2 1/2	82.5	101.6	120.6	127.0	127.0	127.0	161.9	161.9	165.1
3	98.4	123.8	133.4	146.1	146.1	146.1	165.1	171.5	193.7
3 1/2	111.1	136.5	158.8	161.9	158.7	158.7	-	-	-
4	123.8	154.0	171.5	177.8	174.6	190.5	203.2	206.4	231.7
5	150.8	182.6	193.7	212.7	209.5	238.1	244.5	250.8	276.2
6	177.8	212.7	219.1	247.7	244.5	263.5	285.8	279.4	314.3
8	228.6	266.7	276.2	304.8	301.6	317.5	355.6	249.3	384.1
10	282.6	320.7	336.5	358.8	355.6	396.9	431.8	431.8	473.0
12	339.7	377.8	406.4	419.1	415.9	454.0	495.3	517.5	546.1
14	371.5	409.6	447.7	482.6	479.4	488.9	517.5	574.7	-
16	422.3	466.7	511.2	536.6	533.4	561.9	571.5	638.1	-
18	479.4	530.2	546.1	593.7	590.5	609.6	635.0	701.7	-
20	530.2	581.0	603.2	650.9	644.5	679.5	695.3	752.4	-
22	581.0	631.8	657.2	701.7	698.5	730.3	-	-	-
24	631.8	682.6	714.4	771.5	765.2	787.4	835.0	898.5	-



DIMENSIONS FOR KAMMPRO LP3/LP2 PER ASME B16.20 2012 TO
SUIT B16.5 FLANGES (INCHES)

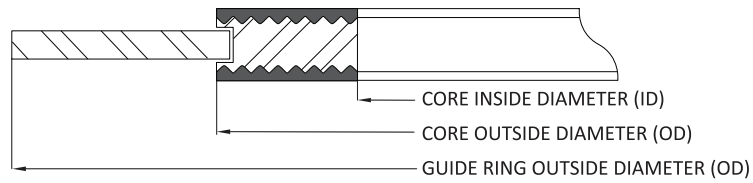

Nominal Pipe Size (NPS)	Core Inside Diameter (ID)	Core Outside Diameter (OD)	Guide Ring Outside Diameter (OD)						
			Class 150	Class 300	Class 400	Class 600	Class 900	Class 1500	Class 2500
1/2	0.91	1.31	1.88	2.13	2.13	2.13	2.50	2.50	2.75
3/4	1.13	1.56	2.25	2.63	2.63	2.63	2.75	2.75	3.00
1	1.44	1.87	2.63	2.88	2.88	2.88	3.13	3.13	3.38
1 1/4	1.75	2.37	3.00	3.25	3.25	3.25	3.50	3.50	4.13
1 1/2	2.06	2.75	3.38	3.75	3.75	3.75	3.88	3.88	4.63
2	2.75	3.50	4.13	4.38	4.38	4.38	5.63	5.63	5.75
2 1/2	3.25	4.00	4.88	5.13	5.13	5.13	6.50	6.50	6.63
3	3.87	4.87	5.38	5.88	5.88	5.88	6.63	6.88	7.75
4	4.87	6.06	6.88	7.13	7.00	7.63	8.13	8.25	9.25
5	5.94	7.19	7.75	8.50	8.38	9.50	9.75	10.00	11.00
6	7.00	8.37	8.75	9.88	9.75	10.50	11.38	11.13	12.50
8	9.00	10.50	11.00	12.13	12.00	12.63	14.13	13.88	15.25
10	11.13	12.63	13.38	14.25	14.13	15.75	17.13	17.13	18.75
12	13.37	14.87	16.13	16.63	16.50	18.00	19.63	20.50	21.63
14	14.63	16.13	17.75	19.31	19.00	19.38	20.50	22.75	-
16	16.63	18.37	20.25	21.25	21.13	22.25	22.63	25.25	-
18	18.87	20.87	21.63	23.50	23.38	24.13	25.13	27.75	-
20	20.87	22.87	23.88	25.75	25.50	26.88	27.50	29.75	-
24	24.87	26.87	28.25	30.50	30.25	31.13	33.00	35.50	N/A

DIMENSIONS FOR KAMMPRO LP3/LP2 PER ASME B16.20 2012 TO
SUIT B16.5 FLANGES (MILLIMETERS)

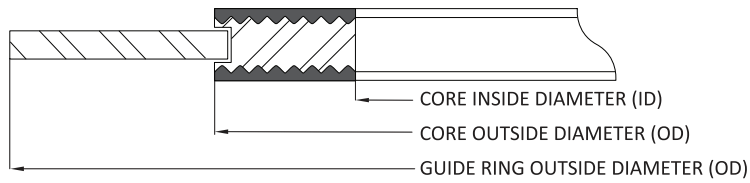

Nominal Pipe Size (NPS)	Core Inside Diameter (ID)	Core Outside Diameter (OD)	Guide Ring Outside Diameter (OD)						
			Class 150	Class 300	Class 400	Class 600	Class 900	Class 1500	Class 2500
1/2	23.1	33.3	47.8	54.1	54.1	54.1	63.5	63.5	69.9
3/4	28.7	39.6	57.2	66.8	66.8	66.8	69.9	69.9	76.2
1	36.6	47.5	66.8	73.2	73.2	73.2	79.5	79.5	85.9
1 1/4	44.5	60.2	76.2	82.6	82.6	82.6	88.9	88.9	104.9
1 1/2	52.3	69.9	85.9	95.3	95.3	95.3	98.6	98.6	117.6
2	69.9	88.9	104.9	111.3	111.3	111.3	143.0	143.0	146.1
2 1/2	82.6	101.6	124.0	130.3	130.3	130.3	165.1	165.1	168.4
3	98.3	123.7	136.7	149.4	149.4	149.4	168.4	174.8	196.9
4	123.7	153.9	174.8	181.1	177.8	193.8	206.5	209.6	235.0
5	150.9	182.6	196.9	215.9	212.9	241.3	247.7	254.0	279.4
6	177.8	212.6	222.3	251.0	247.7	266.7	289.1	282.7	317.5
8	228.6	266.7	279.4	308.1	304.8	320.8	358.9	352.6	387.4
10	282.7	320.8	339.9	362.0	358.9	400.1	435.1	435.1	476.3
12	339.6	377.7	409.7	422.4	419.1	457.2	498.6	520.7	549.4
14	371.6	409.7	450.9	485.9	482.6	492.3	520.7	577.9	-
16	422.4	466.6	514.4	539.8	536.7	565.2	574.8	641.4	-
18	479.3	530.1	549.4	596.9	593.9	612.9	638.3	704.9	-
20	530.1	580.9	606.6	654.1	647.7	682.8	698.5	755.7	-
24	631.7	682.5	717.6	774.7	768.4	790.7	838.2	901.7	N/A

**DIMENSIONS FOR KAMMPRO LP3/LP2 PER ASME B16.47 SERIES A
TO SUIT B16.47 SERIES A (INCHES)**

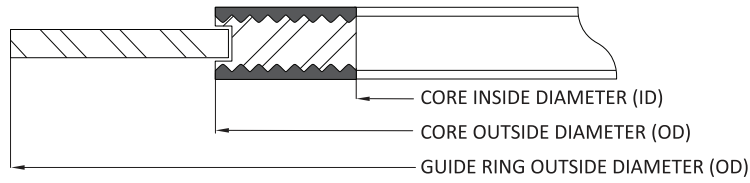

NPS	Class 150			Class 300			Class 400			Class 600			Class 900		
	Grooved Core		Centering Ring	Grooved Core		Centering Ring	Grooved Core		Centering Ring	Grooved Core		Centering Ring	Grooved Core		Centering Ring
	Inside Diameter	Outside Diameter	Outside Diameter	Inside Diameter	Outside Diameter	Outside Diameter	Inside Diameter	Outside Diameter	Outside Diameter	Inside Diameter	Outside Diameter	Outside Diameter	Inside Diameter	Outside Diameter	Outside Diameter
26	26.50	27.75	30.50	27.00	29.00	32.88	27.00	29.00	32.75	27.00	29.00	34.13	27.00	29.00	34.75
28	28.50	29.75	32.75	29.00	31.00	35.38	29.00	31.00	35.13	29.00	31.00	36.00	29.00	31.00	37.25
30	30.50	31.75	34.75	31.25	33.25	37.50	31.25	33.25	37.25	31.25	33.25	38.25	31.25	33.25	39.75
32	32.50	33.88	37.00	33.50	35.50	39.63	33.50	35.50	39.50	33.50	35.50	40.25	33.50	35.50	42.25
34	34.50	35.88	39.00	35.50	37.50	41.63	35.50	37.50	41.50	35.50	37.50	42.25	35.50	37.50	44.75
36	36.50	38.13	41.25	37.63	39.63	44.00	37.63	39.63	44.00	37.63	39.63	44.50	37.75	39.75	47.25
38	38.50	40.13	43.75	38.50	40.00	41.50	38.25	40.25	42.25	39.00	41.00	43.50	40.75	42.75	47.25
40	40.50	42.13	45.75	40.25	42.13	43.88	40.38	42.38	44.38	41.25	43.25	45.50	43.25	45.25	49.25
42	42.50	44.25	48.00	42.25	44.13	45.88	42.38	44.38	46.38	43.50	45.50	48.00	45.25	47.25	51.25
44	44.50	46.38	50.25	44.50	46.50	48.00	44.50	46.50	48.50	45.75	47.75	50.00	47.50	49.50	53.88
46	46.50	48.38	52.25	46.38	48.38	50.13	47.00	49.00	50.75	47.75	49.75	52.25	50.00	52.00	56.50
48	48.50	50.38	54.50	48.63	50.63	52.13	49.00	51.00	53.00	50.00	52.00	54.75	52.00	54.00	58.50
50	50.50	52.50	56.50	51.00	53.00	54.25	51.00	53.00	55.25	52.00	54.00	57.00	--	--	--
52	52.50	54.50	58.75	53.00	55.00	56.25	53.00	55.00	57.25	54.00	56.00	59.00	--	--	--
54	54.50	56.50	61.00	55.25	57.25	58.75	55.25	57.25	59.75	56.25	58.25	61.25	--	--	--
56	56.50	63.25	63.25	57.25	59.25	60.75	57.25	59.25	61.75	58.25	60.25	63.50	--	--	--
58	58.50	65.50	65.50	59.50	61.50	62.75	59.25	61.25	63.75	60.50	62.50	65.50	--	--	--
60	60.50	67.50	67.50	61.50	63.50	64.75	61.75	63.75	66.25	62.75	64.75	68.25	--	--	--

**DIMENSIONS FOR KAMMPRO LP3/LP2 PER ASME B16.47 SERIES A
TO SUIT B16.47 SERIES A (MILLIMETERS)**

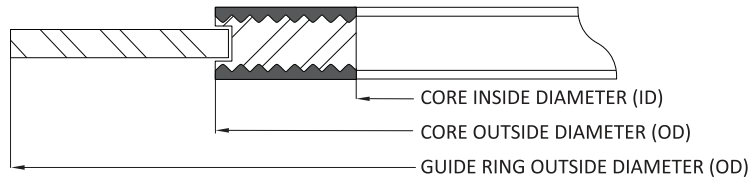

NPS	Class 150			Class 300			Class 400			Class 600			Class 900		
	Grooved Core		Centering Ring	Grooved Core		Centering Ring	Grooved Core		Centering Ring	Grooved Core		Centering Ring	Grooved Core		Centering Ring
	Inside Diameter	Outside Diameter	Outside Diameter	Inside Diameter	Outside Diameter	Outside Diameter	Inside Diameter	Outside Diameter	Outside Diameter	Inside Diameter	Outside Diameter	Outside Diameter	Inside Diameter	Outside Diameter	Outside Diameter
26	673.1	704.9	774.7	685.8	736.6	835.2	685.8	736.6	831.9	685.8	736.6	866.9	685.8	736.6	882.7
28	723.9	755.7	831.9	736.6	787.4	898.7	736.6	787.4	892.3	736.6	787.4	914.4	736.6	787.4	946.2
30	774.7	806.5	882.7	793.8	844.6	952.5	793.8	844.6	946.2	793.8	844.6	971.6	793.8	844.6	1009.7
32	825.5	860.6	939.8	850.9	901.7	1006.6	850.9	901.7	1003.3	850.9	901.7	1022.4	850.9	901.7	1073.2
34	876.3	911.4	990.6	901.7	952.5	1057.4	901.7	952.5	1054.1	901.7	952.5	1073.2	901.7	952.5	1136.7
36	927.1	968.5	1047.8	955.8	1006.6	1117.6	955.8	1006.6	1117.6	955.8	1006.6	1130.3	958.9	1009.7	1200.2
38	977.9	1019.3	1111.3	977.9	1016.0	1054.1	971.6	1022.4	1073.2	990.6	1041.4	1104.9	1035.1	1085.9	1200.2
40	1028.7	1070.1	1162.1	1022.4	1070.1	1114.6	1025.7	1076.5	1127.3	1047.8	1098.6	1155.7	1098.6	1149.4	1251.0
42	1079.5	1124.0	1219.2	1073.2	1120.9	1165.4	1076.5	1127.3	1178.1	1104.9	1155.7	1219.2	1149.4	1200.2	1301.8
44	1130.3	1178.1	1276.4	1130.3	1181.1	1219.2	1130.3	1181.1	1231.9	1162.1	1212.9	1270.0	1206.5	1257.3	1368.6
46	1181.1	1228.9	1327.2	1178.1	1228.9	1273.3	1193.8	1244.6	1289.1	1212.9	1263.7	1327.2	1270.0	1320.8	1435.1
48	1231.9	1279.7	1384.3	1235.2	1286.0	1324.1	1244.6	1295.4	1346.2	1270.0	1320.8	1390.7	1320.8	1371.6	1485.9
50	1282.7	1333.5	1435.1	1295.4	1346.2	1378.0	1295.4	1346.2	1403.4	1320.8	1371.6	1447.8	--	--	--
52	1333.5	1384.3	1492.3	1346.2	1397.0	1428.8	1346.2	1397.0	1454.2	1371.6	1422.4	1498.6	--	--	--
54	1384.3	1435.1	1549.4	1403.4	1454.2	1492.3	1403.4	1454.2	1517.7	1428.8	1479.6	1555.8	--	--	--
56	1435.1	1485.9	1606.6	1454.2	1505.0	1543.1	1454.2	1505.0	1568.5	1479.6	1530.4	1612.9	--	--	--
58	1485.9	1536.7	1663.7	1511.3	1562.1	1593.9	1505.0	1555.8	1619.3	1536.7	1587.5	1663.7	--	--	--
60	1536.7	1587.5	1714.5	1562.1	1612.9	1644.7	1568.5	1619.3	1682.8	1593.9	1644.7	1733.6	--	--	--

**DIMENSIONS FOR KAMMPRO LP3/LP2 PER ASME B16.47 SERIES B
TO SUIT B16.47 SERIES B (INCHES)**

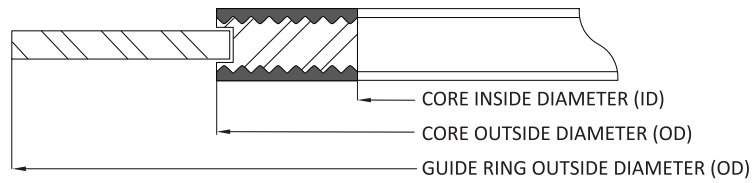

NPS	Class 150			Class 300			Class 400			Class 600			Class 900		
	Grooved Core		Centering Ring	Grooved Core		Centering Ring	Grooved Core		Centering Ring	Grooved Core		Centering Ring	Grooved Core		Centering Ring
	Inside Diameter	Outside Diameter	Outside Diameter	Inside Diameter	Outside Diameter	Outside Diameter	Inside Diameter	Outside Diameter	Outside Diameter	Inside Diameter	Outside Diameter	Outside Diameter	Inside Diameter	Outside Diameter	Outside Diameter
26	26.50	27.50	28.56	26.50	28.00	30.38	26.25	27.50	29.38	26.13	28.13	30.13	27.25	29.50	33.00
28	28.50	29.50	30.56	28.50	30.00	32.50	28.13	29.50	31.50	27.75	29.75	32.25	29.25	31.50	35.50
30	30.50	31.50	32.56	30.50	32.00	34.88	30.13	31.75	33.75	30.63	32.63	34.63	31.75	33.75	37.75
32	32.50	33.50	34.69	32.50	34.00	37.00	32.00	33.88	35.88	32.75	34.75	36.75	34.00	36.00	40.00
34	34.50	35.75	36.81	34.50	36.00	39.13	34.13	35.88	37.88	35.00	37.00	39.25	36.25	38.25	42.25
36	36.50	37.75	38.88	36.50	38.00	41.25	36.13	38.00	40.25	37.00	39.00	41.25	37.25	39.25	44.25
38	38.38	39.75	41.13	39.75	41.25	43.25	38.25	40.25	42.25	39.00	41.00	43.50	40.75	42.75	47.25
40	40.25	41.88	43.13	41.75	43.25	45.25	40.38	42.38	44.38	41.25	43.25	45.50	43.25	45.25	49.25
42	42.50	43.88	45.13	43.75	45.25	47.25	42.38	44.38	46.38	43.50	45.50	48.00	45.25	47.25	51.25
44	44.25	45.88	47.13	45.75	47.25	49.25	44.50	46.50	48.50	45.75	47.75	50.00	47.50	49.50	53.88
46	46.50	48.19	49.44	47.88	49.38	51.88	47.00	49.00	50.75	47.75	49.75	52.25	50.00	52.00	56.50
48	48.50	50.00	51.44	49.75	51.63	53.88	49.00	51.00	53.00	50.00	52.00	54.75	52.00	54.00	58.50
50	50.50	52.19	53.44	51.88	53.38	55.88	51.00	53.00	55.25	52.00	54.00	57.00	--	--	--
52	52.50	54.19	55.44	53.88	55.38	57.88	53.00	55.00	57.25	54.00	56.00	59.00	--	--	--
54	54.50	56.00	57.63	55.25	57.25	60.25	55.25	57.25	59.75	56.25	58.25	61.25	--	--	--
56	56.88	58.19	59.63	58.25	60.00	62.75	57.25	59.25	61.75	58.25	60.25	63.50	--	--	--
58	59.08	60.19	62.19	60.44	61.94	65.19	59.25	61.25	63.75	60.50	62.50	65.50	--	--	--
60	61.31	62.44	64.19	62.56	64.19	67.19	61.75	63.75	66.25	62.75	64.75	68.25	--	--	--

**DIMENSIONS FOR KAMMPRO LP3/LP2 PER ASME B16.47 SERIES B
TO SUIT B16.47 SERIES B (MILLIMETERS)**

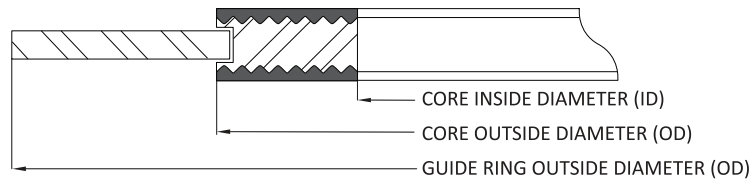

NPS	Class 150			Class 300			Class 400			Class 600			Class 900		
	Grooved Core		Centering Ring	Grooved Core		Centering Ring	Grooved Core		Centering Ring	Grooved Core		Centering Ring	Grooved Core		Centering Ring
	Inside Diameter	Outside Diameter	Outside Diameter	Inside Diameter	Outside Diameter	Outside Diameter	Inside Diameter	Outside Diameter	Outside Diameter	Inside Diameter	Outside Diameter	Outside Diameter	Inside Diameter	Outside Diameter	Outside Diameter
26	673.1	698.5	725.4	673.1	711.2	771.7	666.8	698.5	746.3	663.7	714.5	765.3	692.2	749.3	838.2
28	723.9	749.3	776.2	723.9	762.0	825.5	714.5	749.3	800.1	704.9	755.7	819.2	743.0	800.1	901.7
30	774.7	800.1	827.0	774.7	812.8	886.0	765.3	806.5	857.3	778.0	828.8	879.6	806.5	857.3	958.9
32	825.5	850.9	881.1	825.5	863.6	939.8	812.8	860.6	911.4	831.9	882.7	933.5	863.6	914.4	1016.0
34	876.3	908.1	935.0	876.3	914.4	993.9	866.9	911.4	962.2	889.0	939.8	997.0	920.8	971.6	1073.2
36	927.1	958.9	987.6	927.1	965.2	1047.8	917.7	965.2	1022.4	939.8	990.6	1047.8	946.2	997.6	1124.0
38	974.9	1009.7	1044.7	1009.7	1047.8	1098.6	971.6	1022.4	1073.2	990.6	1041.4	1104.9	1035.1	1085.9	1200.2
40	1022.4	1063.8	1095.5	1060.5	1098.6	1149.4	1025.7	1076.5	1127.3	1047.8	1098.6	1155.7	1098.6	1149.4	1251.0
42	1079.5	1114.6	1146.3	1111.3	1149.4	1200.2	1076.5	1127.3	1178.1	1104.9	1155.7	1219.2	1149.4	1200.2	1301.8
44	1124.0	1165.4	1197.1	1162.1	1200.2	1251.0	1130.3	1181.1	1231.9	1162.1	1212.9	1270.0	1206.5	1257.3	1368.6
46	1181.1	1224.0	1255.8	1216.2	1254.3	1317.8	1193.8	1244.6	1289.1	1212.9	1263.7	1327.2	1270.0	1320.8	1435.1
48	1231.9	1270.0	1306.6	1263.7	1311.4	1368.6	1244.6	1295.4	1346.2	1270.0	1320.8	1390.7	1320.8	1371.6	1485.9
50	1282.7	1325.6	1357.4	1317.8	1355.9	1419.4	1295.4	1346.2	1403.4	1320.8	1371.6	1447.8	--	--	--
52	1333.5	1376.4	1408.2	1368.6	1406.7	1470.2	1346.2	1397.0	1454.2	1371.6	1422.4	1498.6	--	--	--
54	1384.3	1422.4	1463.8	1403.4	1454.2	1530.4	1403.4	1454.2	1517.7	1428.8	1479.6	1555.8	--	--	--
56	1444.8	1478.0	1514.6	1479.6	1524.0	1593.9	1454.2	1505.0	1568.5	1479.6	1530.4	1612.9	--	--	--
58	1500.6	1528.8	1579.6	1535.2	1573.3	1655.8	1505.0	1555.8	1619.3	1536.7	1587.5	1663.7	--	--	--
60	1557.3	1586.0	1630.4	1589.0	1630.4	1706.6	1568.5	1619.3	1682.8	1593.9	1644.7	1733.6	--	--	--

DIMENSIONS FOR KAMMPRO LP3/LP2 PER EN 1514-6 TO
SUIT TYPE A AND B FLANGES FACINGS (INCHES)

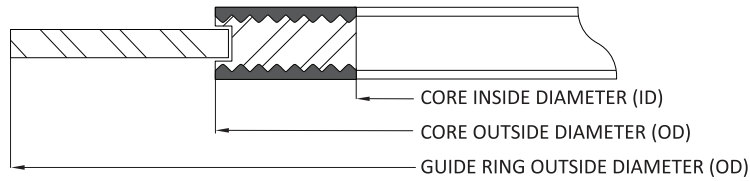

DN	Core Inside Diameter	Core Outside Diameter (OD)			Guide Ring Outside Diameter (OD)											
		PN10/40	PN 64/160	PN 250/400	PN 10	PN 16	PN 25	PN 40	PN 64	PN 100	PN 160	PN 250	PN 320	PN 400		
mm	Inches	Inches			Inches											
10	0.87	See PN 64 to PN 160	See PN 250 to PN 400	1.42	1.81	1.81	1.81	1.81	2.20	2.20	2.20	2.64	2.64	2.64		
15	1.02			1.65	2.01	2.01	2.01	2.01	2.40	2.40	2.40	2.83	2.83	--		
20	1.22			1.85	2.40	2.40	2.40	2.40	--	--	--	--	--	--		
25	1.42			2.05	2.80	2.80	2.80	2.80	3.23	3.23	3.23	3.27	3.62	4.09		
32	1.81			2.44	2.60	3.23	3.23	3.23	3.23	--	--	--	--	--		
40	2.09			2.72	2.87	3.62	3.62	3.62	3.62	4.06	4.06	4.06	4.29	4.69	5.31	
50	2.56			3.19	3.43	4.21	4.21	4.21	4.21	4.45	4.69	4.69	4.88	5.28	5.91	
65	3.19			3.94	4.06	5.00	5.00	5.00	5.00	5.39	5.63	5.63	6.02	6.69	7.56	
80	3.74			4.53	4.76	5.59	5.59	5.59	5.59	5.83	6.06	6.06	6.69	7.48	8.15	
100	4.65			5.43	5.75	6.38	6.38	6.61	6.61	6.85	7.09	7.09	7.95	9.02	10.08	
125	5.59			6.38	7.01	7.56	7.56	7.64	7.64	8.27	8.54	8.54	9.53	10.79	11.85	
150	6.69			7.48	8.35	8.54	8.54	8.82	8.82	9.72	10.12	10.12	11.18	12.24	13.70	
175	7.68			8.46	9.65	9.72	9.72	10.00	10.43	10.91	11.30	11.18	12.44	14.09	15.83	
200	8.66			9.45	9.76	11.02	10.71	10.71	11.18	11.42	12.17	12.76	12.76	14.09	15.67	17.40
250	10.63			11.42	11.81	13.39	12.87	12.91	13.39	13.86	14.33	15.39	15.28	17.40	19.21	--
300	12.60	13.39	14.02	15.75	14.84	15.08	15.75	16.42	16.69	18.03	18.03	21.10	--	--		
350	14.76	15.55	16.34	--	17.20	17.44	17.99	18.66	19.13	20.16	--	--	--	--		
400	16.77	17.72	18.66	--	19.25	19.49	20.24	21.50	21.38	22.52	--	--	--	--		
450	18.90	19.92	--	--	21.22	21.85	--	22.48	--	--	--	--	--	--		
500	20.87	22.05	23.15	--	23.39	24.29	24.57	24.72	25.87	27.72	--	--	--	--		
600	24.80	26.14	27.56	--	27.36	28.90	28.78	29.41	30.08	32.01	--	--	--	--		
700	28.74	30.31	31.97	--	31.89	31.65	32.80	33.54	34.61	37.40	--	--	--	--		
800	32.68	34.49	34.88	--	36.10	35.87	37.09	38.35	38.90	--	--	--	--	--		
900	36.61	38.66	39.13	--	40.04	39.80	41.02	42.68	43.62	--	--	--	--	--		
1000	40.94	43.23	43.70	--	44.25	44.41	45.43	47.01	48.03	--	--	--	--	--		
1200	49.21	51.97	52.52	--	52.80	52.83	53.70	55.04	57.17	--	--	--	--	--		
1400	56.69	59.92	--	--	60.94	60.71	62.13	63.70	--	--	--	--	--	--		
1600	64.96	6.77	--	--	69.76	69.45	70.79	72.05	--	--	--	--	--	--		
1800	72.83	75.35	--	--	77.64	77.32	78.74	--	--	--	--	--	--	--		
2000	80.71	83.46	--	--	85.91	85.35	87.80	--	--	--	--	--	--	--		
2200	88.58	91.65	--	--	93.86	93.62	--	--	--	--	--	--	--	--		
2400	96.85	98.90	--	--	102.13	--	--	--	--	--	--	--	--	--		
2600	105.12	107.40	--	--	110.00	--	--	--	--	--	--	--	--	--		
2800	113.78	116.22	--	--	118.66	--	--	--	--	--	--	--	--	--		
3000	122.05	124.65	--	--	127.09	--	--	--	--	--	--	--	--	--		

**DIMENSIONS FOR KAMMPRO LP3/LP2 PER EN 1514-6 TO
SUIT TYPE A AND B FLANGES F ACINGS (MILLIMETERS)**

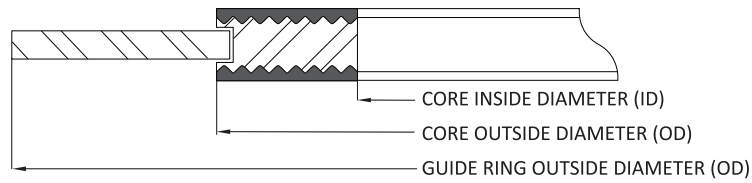

DN	Core Inside Diameter (ID)	Core Outside Diameter (OD)			Guide Ring Outside Diameter (OD)										
		PN 10/40	PN 64/160	PN 250/400	PN 10	PN 16	PN 25	PN 40	PN 64	PN 100	PN 160	PN 250	PN 320	PN 400	
mm	mm	mm			mm										
10	22	See PN 64 to PN 160	See PN 250 to PN 400	36	46	46	46	46	56	56	56	67	67	67	
15	26			42	51	51	51	51	61	61	61	61	72	72	--
20	31			47	61	61	61	61	--	--	--	--	--	--	--
25	36			52	71	71	71	71	82	82	82	82	83	92	104
32	46			62	66	82	82	82	82	--	--	--	--	--	--
40	53			69	73	92	92	92	92	103	103	103	109	119	135
50	65			81	87	107	107	107	107	113	119	119	124	134	150
65	81			100	103	127	127	127	127	137	143	143	153	170	192
80	95			115	121	142	142	142	142	148	154	154	170	190	207
100	118			138	146	162	162	168	168	174	180	180	202	229	256
125	142			162	178	192	192	194	194	210	217	217	242	274	301
150	170			190	212	217	217	224	224	247	257	257	284	311	348
175	195			215	245	247	247	254	265	277	287	284	316	358	402
200	220			240	248	280	272	272	284	290	309	324	324	358	398
250	270	290	300	340	327	328	340	352	364	391	388	442	488	--	
300	320	340	356	400	377	383	400	417	424	458	458	536	--	--	
350	375	395	415	--	437	443	457	474	486	512	--	--	--	--	
400	426	450	474	--	489	495	514	546	543	572	--	--	--	--	
450	480	506	--	--	539	555	--	571	--	--	--	--	--	--	
500	530	560	588	--	594	617	624	628	657	704	--	--	--	--	
600	630	664	700	--	695	734	731	747	764	813	--	--	--	--	
700	730	770	812	--	810	804	833	852	879	950	--	--	--	--	
800	830	876	886	--	917	911	942	974	988	--	--	--	--	--	
900	930	982	994	--	1017	1011	1042	1084	1108	--	--	--	--	--	
1000	1040	1098	1110	--	1124	1128	1154	1194	1220	--	--	--	--	--	
1200	1250	1320	1334	--	1341	1342	1364	1398	1452	--	--	--	--	--	
1400	1440	1522	--	--	1548	1542	1578	1618	--	--	--	--	--	--	
1600	1650	172	--	--	1772	1764	1798	1830	--	--	--	--	--	--	
1800	1850	1914	--	--	1972	1964	2000	--	--	--	--	--	--	--	
2000	2050	2120	--	--	2182	2168	2230	--	--	--	--	--	--	--	
2200	2250	2328	--	--	2384	2378	--	--	--	--	--	--	--	--	
2400	2460	2512	--	--	2594	--	--	--	--	--	--	--	--	--	
2600	2670	2728	--	--	2794	--	--	--	--	--	--	--	--	--	
2800	2890	2952	--	--	3014	--	--	--	--	--	--	--	--	--	
3000	3100	3166	--	--	3228	--	--	--	--	--	--	--	--	--	

A NOTE ON KAMMPRO GASKET DIMENSIONS

Kammpro gaskets are an ideal upgrade for equipment applications where standard spiral wound gaskets, double jacketed designs, and corrugated metallic gaskets are commonly used.

Kammpro LP1 dimensions can be the same as Style W or Style 300/310 gaskets that are seated in large male/female, large tongue/groove, and small tongue/groove joints. Technically, the dimensions that are specified for large spiral wound ASME B16.20 for ASME B16.47 Series A and B flanges can still apply for the Kammpro Gaskets per LP3/LP2 design.

KAMMPRO LP3/LP2 TOLERANCES PER ASME B16.20 SPECIFICATION:

- Core inside diameter for NPS ½ to 24 is +1/64", - 0" (+0.4 mm, - 0 mm)
- Core outside diameter for NPS ½ to 24 is +0", -1/64" (+0 mm, - 0.4 mm)
- Guide ring outside diameter for NPS ½ to 24 is ±1/32" (±0.8 mm)

KAMMPRO LP3/LP2 TOLERANCES PER EN 1514-6 SPECIFICATION:

- Core inside diameter for DN 10 through DN 1000 is +1/64", - 0" (+0.4 mm, - 0 mm)
- Core outside diameter for DN 10 through DN 1000 is +0", -1/64" (+0 mm, - 0.4 mm)
- Core inside diameter for DN 1000 and larger is +3/64", -0" (+1.0 mm, - 0 mm)
- Core outside diameter for DN 1000 and larger is +0", -3/64" (+0 mm, - 1.0mm)
- Guide ring outside diameter is ±1/32" (±0.8 mm)



LAMONS SPIRASEAL®

PRODUCT FAMILY

Spiral wound gaskets have become extremely popular due to the wide variety of available styles and sizes. Spiral wound gaskets can be fabricated of any metal which is available in thin strip and which can be welded; therefore, they can be used against virtually any corrosive medium dependent upon the choice of the metal and filler. They can be used over the complete temperature range from cryogenic to approximately 2000°F (1093°C). This type of gasket can be used in all pressures from vacuum to the standard 2500 pressure class flange ratings. Spiral wound gaskets can also be manufactured with variable densities, i.e. relatively low density gaskets for vacuum service up to extremely high density gaskets having a seating stress of approximately 30,000 psi (207 MPa). The softer gaskets would require a seating stress in the range of 5,000 psi (34 MPa).



VARIABLE DENSITY

Spiral wound gaskets are manufactured by alternately winding strips of metal and soft fillers on the outer edge of winding mandrels that determine the inside dimensions of the wound component. In the winding process, the alternating plies are maintained under pressure. Varying the pressure during the winding operation and/or the thickness of the soft filler, the density of the gasket can be controlled over a wide range. As a general rule, low winding pressure and thick soft fillers are used for low pressure applications. Thin fillers and high pressure loads are used for high pressure applications. This, of course, would account for the higher bolt loads that have to be applied to the gasket in high pressure applications. In addition to all these advantages of the spiral wound gasket, they are relatively low cost.

AVAILABLE SIZES AND THICKNESSES

Lamons spiral wound gaskets are available in thicknesses of 0.0625" (1.5 mm), 0.100" (2.5 mm), 0.125" (3 mm), 0.175" (4 mm), 0.250" (6.4 mm), and 0.285" (7 mm). The chart on page 47 indicates the size range that can normally be fabricated in the various thicknesses along with the recommended compressed thickness of each and the maximum flange width.

FLANGE SURFACE FINISH

Use of spiral wound gaskets gives the designer and the user a wider tolerance for flange surface finishes than other metallic gaskets. While they can be used against most commercially available flange surface finishes, experience has indicated that the appropriate flange surface finishes used with spiral wound gaskets are as follows:

- 125 to 250 AARH optimum
- 500 AARH maximum

AVAILABLE SPIRASEAL® STYLES

Lamons spiral wound gaskets are available in a variety of styles to suit the particular flange facing being utilized on the flanges.

LAMONS STYLE W

Style W gaskets are SpiraSeal® windings only. No inner or outer ring is utilized. Used in a variety of different applications, they may be furnished in many different sizes and thicknesses.

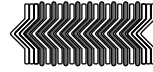

Style W gaskets are made in standard sizes to fit:

- A. Large tongue and groove joints, 1/2 to 24 NPS, standard pressures;
- B. Small tongue and groove joints, 1/2 to 24 NPS, standard pressures; and,
- C. Large male and female joints 1/4 to 24 NPS, standard pressures,

LAMONS STYLE WR

Style WR gaskets consist of a spiral wound sealing component with a solid metal outer guide ring. The outer guide ring serves to center the gasket properly in the flange joint, acts as an anti-blowout device, provides radial support for the spiral wound component, and acts as a compression gauge to prevent the spiral wound component from being over crushed. Normally the outer guide rings are furnished in mild steel, but can be supplied in other metals when required by operating conditions.

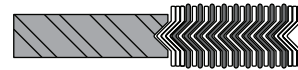

LAMONS STYLE WRI

Style WRI is identical to style WR, with the addition of an inner ring. The inner ring also serves several functions. Primarily, it provides radial support for the gasket on the ID to help prevent the occurrences of buckling or imploding. The inner ring also serves as an additional compression limiter. Its ID is normally sized slightly larger than the ID of the flange bore, minimizing turbulence in process flow. The inner rings are normally supplied in the same material as the spiral wound component. Lamons normally manufactures standard Style WR and WRI spiral wound gaskets to ASME B16.20, designed to suit ASME B16.5 and ASME B16.47 flanges.

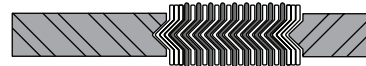

LAMONS STYLE WRI-LE

Style WRI-LE design is the optimum choice when gasket high density and low emissions are a must. The improved spiral wound design incorporates the typical essentials such as a carbon steel guide ring, along with a stainless steel inner ring.

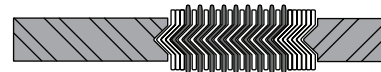

Manufacturing procedures for the low emissions gasket precisely regulate the amount of metal wire wraps per inch; this higher number of wraps helps create a more robust and dense gasket, which in turn reduce emissions. Machinery settings are carefully regulated and set to higher pressure settings which generate higher tension on the winding to densify and extrude the filler to a minimum of 0.008" (0.2032 mm) above the winding metal surface. This extruded material creates a thin barrier between the winding surface and flange sealing surface to help fill minor flange surface blemishes and inconsistencies. Flanges in the 150 to 2500 pressure class range will benefit from this leading edge design.

LAMONS STYLE WRI-LC

Style WRI-LC gaskets provide a seal at relatively lower seating stress. This means that our design requires less bolt load to seat, yet still has the recovery like a standard spiral wound. The WRI-LC gasket is typical to Class 150 and 300 flanges, where users have a concern with insufficient potential of pre-load. But, the density of the WRI-LC gasket can be varied to meet virtually any requirement. Electronic controls on Lamons' SpiraSeal machines assure high quality precision welding with equal spacing, the correct number of metal plies on the gasket inside periphery, proper ratio of metal to filler, proper number of metal plies on the outside and spot welds on the OD.

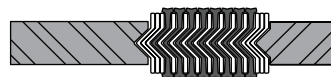

LAMONS STYLE WRI-HTG

Style WRI-HTG gaskets combine the corrosion and oxidation resistance of mica with the "sealability" of flexible graphite. The mica material, in conjunction with the metal spirals serves as a barrier between oxidizing process conditions and/or external air and the graphite. While Inconel® X-750 is commonly selected as the winding metal, any alloy can be selected. The overall effective rating of the HTG configuration can be utilized in temperatures of up to 1500°F (815°C). Higher temperatures can be realized given further consultation with Lamons Engineering Department.



LAMONS STYLE WRI-LP

Designed for highly corrosive environments, Style WRI-LP is a Spiral wound gasket with a conventional outer guide ring and a "Kammpro" style LPI inner ring. This dual sealing design engages the raised face completely from the OD to the bore. The winding can be constructed with the required metal and soft filler specified by the user. The "Kammpro" inner ring metal can be ordered in any alloy, such as Monel®, or in carbon steel. A carbon steel inner ring can be given a protective PTFE coating for increased chemical resistance. The Kammpro inner ring is faced typically with either 0.020" (0.5 mm) thick EPTFE or graphite. The WRI-LP has seen wide-spread approvals for Hydrofluoric Acid (HF) service, although this design has much further potential. Its main advantages are: no metal contact with the media; chemical resistance; fire safe design; sizing to meet ASME B16.5; available in large diameter and for special flanges.

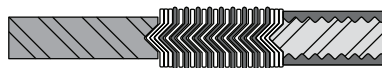

LAMONS INHIBITOR

Lamons Inhibitor gasket provides corrosion resistance in the most extreme conditions. It combines a HTG filler configuration with highest purity graphite, and a Kammpro inner ring laminated with soft PTFE material. The design of the Inhibitor gasket utilizes the Kammpro inner ring to provide the primary sealing interface. The inner ring material and its covering layer are inert in terms of corrosion through contact with dissimilar materials. This fire safe design incorporates the sealing integrity of highest purity graphite in conjunction with mica on the ID and OD, preventing the entrance of further corrosive conditions to the media.



LAMONS STYLE WR-AB

Inward buckling of spiral wound gaskets is sometimes a concern in industry today. Work is ongoing through various industry committees to improve the standard in this regard. Some end users do not want to use inner rings due to cost or bore intrusion - to address this stance, Lamons offers Style WR-AB. By creating a space for expansion between the OD of the winding and the outer ring, the buckling along the inside could be reduced. This feature, combined with a reinforced inside circumference, help to further reduce the likelihood of inward buckling after installation.

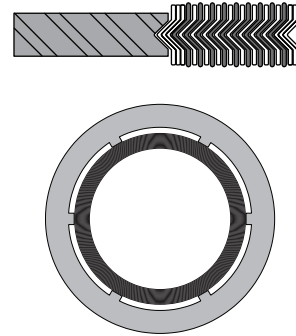

LAMONS STYLE WRI-HF

This gasket was developed for Hydrofluoric (HF) acid applications. It consists of a Monel® and PTFE winding with a carbon steel centering ring and a PTFE inner ring. The carbon steel outer ring can be coated with special HF acid detecting paint if desired. The PTFE inner ring reduces corrosion to the flanges between the bore of the pipe and the ID of the spiral wound sealing element.

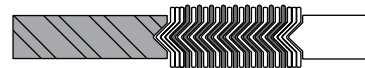

LAMONS STYLE WRI-RJ

The style WRI-RJ gasket is identical to a Style WRI in construction features but is specially sized to be used as a replacement gasket for flanges machined to accept oval or octagonal ring joint gaskets. The sealing component is located between the ID of the groove machined in the flange and the flange bore. These are intended to be used as replacement parts and are considered a maintenance item. In new construction, where spiral wound gaskets are intended to be used, raised face flanges should be utilized.

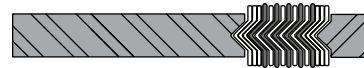

LAMONS STYLE MW, MWC & MWI

These gaskets are available in round, obround, and oval shapes and are used for standard manhole cover plates. When spiral wound manhole gaskets with a straight side are required, it is necessary that some curvature be allowable, given to the fact that spiral wound gaskets are wrapped under tension and therefore tend to buckle inward when the gaskets are removed from the winding mandrel. As a rule of thumb, the ratio of the long ID to the short ID should not exceed three to one.

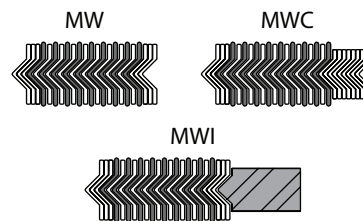

LAMONS STYLE H

Style H gaskets are for use on boiler hand hole and tubecap assemblies. They are available in round, square, rectangular, diamond, obround, oval and pear shapes. Lamons has tooling available for manufacturing most of the standard handhold and tubecap sizes of the various boiler manufacturers. However, these are also available in special sizes and shapes. (To order special gaskets, dimensional drawings or sample cover plates should be provided in order to assure proper fit.)

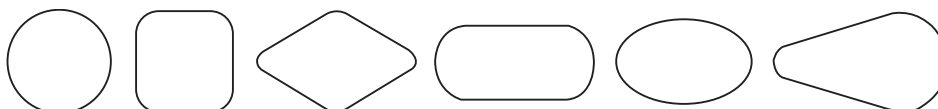
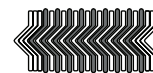

LAMONS STYLE WP & WRP

These gaskets are similar to Style W and Style WR, with the addition of pass partitions for use with shell and tube heat exchangers. Partitions are normally supplied as double-jacketed construction, made of the same material as the spiral wound component. The partition strips can be soft soldered, tack welded or silver soldered to the spiral wound component. The double-jacketed partition strips are normally slightly thinner than the spiral wound component in order to minimize the bolt loading required to properly seat the gasket.

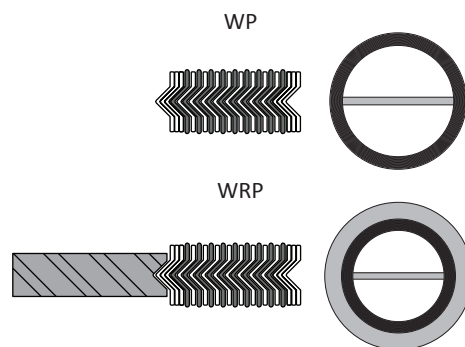

LAMONS STYLE L

The spiral wound components of Style L are identical to those of Style W and in addition have a wire loop welded to the outer periphery of the gasket, sized so as to fit over diametrically opposite bolts, for proper centering of the spiral wound component on the gasket seating surface. Whenever possible, it is recommended that a Style WR gasket be used in lieu of a Style L gasket because of the obvious advantages of the outer solid metal guide ring. The Style L is considerably more difficult to produce than the Style WR and therefore more expensive.

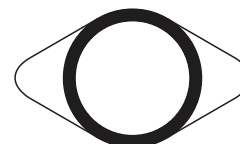

SPIRAL WOUND GASKET DIMENSIONS FOR PIPE FLANGES

Spiral wound gaskets must be sized to ensure the winding component is seated properly between flat surfaces. If it protrudes beyond a raised face or into a flange bore, mechanical damage and leakage may occur.

Style W typically is applied in confined groove type flanges, and it is sized by the following formulas:

Gasket is confined on the Inside Diameter (ID) and Outside Diameter (OD):

$$\text{Gasket Inside Diameter (ID)} = \text{Groove Inside Diameter (ID)} + 1/16'' (1.5 \text{ mm})$$

$$\text{Gasket Outside Diameter (OD)} = \text{Groove Outside Diameter (OD)} - 1/16'' (1.5 \text{ mm})$$

Gasket is confined on the Outside Diameter (OD):

$$\text{Gasket Inside Diameter (ID)} = \text{Bore} + \text{Minimum } 1/4'' (6.4 \text{ mm})$$

$$\text{Gasket Outside Diameter (OD)} = \text{Recess Outside Diameter (OD)} - 1/16'' (1.5 \text{ mm})$$

LIMITATIONS OF SIZE & THICKNESS

Gasket Thickness		Maximum Inside Diameter (ID)*		Maximum Flange Width*		Recommended Compressed Thickness	
Inches	mm	Inches	mm	Inches	mm	Inches	mm
0.063	1.59	9	229	0.375	9.53	0.050/0.055	1.27/1.39
0.100	2.54	12	305	0.500	12.70	0.075/0.080	1.91/2.03
0.125	3.18	40	1016	0.750	19.05	0.090/0.100	2.29/2.54
0.175	4.45	75	1905	1.000	25.40	0.125/0.135	3.18/3.43
0.250	6.35	160	4064	1.250	31.75	0.180/0.200	4.57/5.08
0.285	7.24	160	4064	1.250	31.75	0.200/0.220	5.08/5.59

*These limitations are intended as a general guide only. Materials of construction and flange width of gasket can affect the limitations listed.

DIMENSIONS FOR STYLE W TO SUIT LARGE MALE AND FEMALE JOINTS

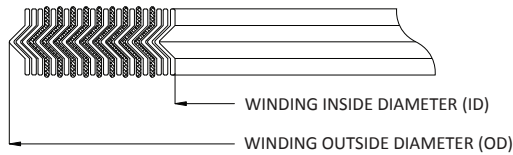

Nominal Pipe Size (NPS)	Pressure Class							
	150, 300, 400, 600				900, 1500			
	Inside Diameter (ID)		Outside Diameter (OD)		Inside Diameter (ID)		Outside Diameter (OD)	
	Inches	mm	Inches	mm	Inches	mm	Inches	mm
1/4	0.50	12.7	1.00	25.4	-	-	-	-
1/2	1.00	25.4	1.38	34.9	1.00	25.4	1.38	34.9
3/4	1.31	33.3	1.69	42.9	1.31	33.3	1.69	42.9
1	1.50	38.1	2.00	50.8	1.50	38.1	2.00	50.8
1 1/4	1.88	47.6	2.50	63.5	1.88	47.6	2.50	63.5
1 1/2	2.13	54.0	2.88	73.0	2.13	54.0	2.88	73.0
2	2.88	73.0	3.63	92.1	2.88	73.0	3.63	92.1
2 1/2	3.38	85.7	4.13	104.8	3.38	85.7	4.13	104.8
3	4.25	108.0	5.00	127.0	4.25	108.0	5.00	127.0
3 1/2	4.75	120.7	5.50	139.7	4.75	120.7	5.50	139.7
4	5.19	131.8	6.19	157.2	5.19	131.8	6.19	157.2
4 1/2	5.69	144.5	6.75	171.5	-	-	-	-
5	6.31	160.3	7.31	185.7	6.31	160.3	7.31	185.7
6	7.50	190.5	8.50	215.9	7.50	190.5	8.50	215.9
8	9.38	238.1	10.63	269.9	9.38	238.1	10.63	269.9
10	11.25	285.8	12.75	323.9	11.25	285.8	12.75	323.9
12	13.50	342.9	15.00	381.0	13.50	342.9	15.00	381.0
14	14.75	374.7	16.25	412.8	14.75	374.7	16.25	412.8
16	17.00	431.8	18.50	469.9	17.00	431.8	18.50	469.9
18	19.25	489.0	21.00	533.4	19.25	489.0	21.00	533.4
20	21.00	533.4	23.00	584.2	21.00	533.4	23.00	584.2
24	25.25	641.4	27.25	692.2	25.25	641.4	27.25	692.2

Nominal Pipe Size (NPS)	Pressure Class			
	2500			
	Inside Diameter (ID)		Outside Diameter (OD)	
	Inches	mm	Inches	mm
1/4	-	-	-	-
1/2	0.81	20.6	1.38	34.9
3/4	1.06	27.0	1.69	42.9
1	1.25	31.8	2.00	50.8
1 1/4	1.63	41.3	2.50	63.5
1 1/2	1.88	47.6	2.88	73.0
2	2.38	60.3	3.63	92.1
2 1/2	3.00	76.2	4.13	104.8
3	3.75	95.3	5.00	127.0
3 1/2	-	-	-	-
4	4.75	120.7	6.19	157.2
4 1/2	-	-	-	-
5	5.75	146.1	7.31	185.7
6	6.75	171.5	8.50	215.9
8	8.75	222.3	10.63	269.9
10	10.75	273.1	12.75	323.9
12	13.00	330.2	15.00	381.0

DIMENSIONS FOR STYLE W

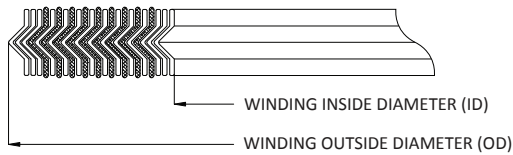

FOR LARGE TONGUE AND GROOVE JOINTS

Nominal Pipe Size (NPS)	Pressure Class			
	150-2500*			
	Inside Diameter (ID)		Outside Diameter (OD)	
	Inches	mm	Inches	mm
1/2	1.00	25.4	1.38	34.9
3/4	1.31	33.3	1.69	42.9
1	1.50	38.1	2.00	50.8
1 1/4	1.88	47.6	2.50	63.5
1 1/2	2.13	54.0	2.88	73.0
2	2.88	73.0	3.63	92.1
2 1/2	3.38	85.7	4.13	104.8
3	4.25	108.0	5.00	127.0
3 1/2	4.75	120.7	5.50	139.7
4	5.19	131.8	6.19	157.2
5	6.31	160.3	7.31	185.7
6	7.50	190.5	8.50	215.9
8	9.38	238.1	10.63	269.9
10	11.25	285.8	12.75	323.9
12	13.50	342.9	15.00	381.0
14	14.75	374.7	16.25	412.8
16	16.75	425.5	18.50	469.9
18	19.25	489.0	21.00	533.4
20	21.00	533.4	23.00	584.2
24	25.25	641.4	27.25	692.2

* 2500# only thru 12" NPS

FOR SMALL TONGUE AND GROOVE JOINTS

Nominal Pipe Size (NPS)	Pressure Class			
	150-2500*			
	Inside Diameter (ID)		Outside Diameter (OD)	
	Inches	mm	Inches	mm
1/2	1.00	25.4	1.38	34.9
3/4	1.31	33.3	1.69	42.9
1	1.50	38.1	1.88	47.6
1 1/4	1.88	47.6	2.25	57.2
1 1/2	2.13	54.0	2.50	63.5
2	2.88	73.0	3.25	82.6
2 1/2	3.38	85.7	3.75	95.3
3	4.25	108.0	4.63	117.5
3 1/2	4.75	120.7	5.13	130.2
4	5.19	131.8	5.69	144.5
5	6.31	160.3	6.81	173.0
6	7.50	190.5	8.00	203.2
8	9.38	238.1	10.00	254.0
10	11.25	285.8	12.00	304.8
12	13.50	342.9	14.25	362.0
14	14.75	374.7	15.50	393.7
16	16.75	425.5	17.63	447.7
18	19.25	489.0	20.13	511.2
20	21.00	533.4	22.00	558.8
24	25.25	641.4	26.25	666.8

* 2500# only thru 12" NPS

STYLE W GASKET TOLERANCES:

Gasket Diameter (Inches)	Inside Diameter (ID)	Outside Diameter (OD)
Up to 1"	(+3/64", -0.00")	(+0.00", -1/32")
1" to 24"	(+1/32", -0.00")	(+0.00", -1/32")
24" to 36"	(+3/64", -0.00")	(+0.00", -1/16")
36" to 60"	(+1/16", -0.00")	(+0.00", -1/16")
60" and above	(+3/32", -0.00")	(+0.00", -3/32")

Gasket Diameter (mm)	Inside Diameter (ID)	Outside Diameter (OD)
Up to 25.4 mm	(+1.2 mm, -0.00 mm)	(+0.00 mm, -0.8 mm)
25.4 mm to 610 mm	(+0.8 mm, -0.00 mm)	(+0.00 mm, -0.8 mm)
610 mm to 914 mm	(+1.2 mm, -0.00 mm)	(+0.00 mm, -1.6 mm)
914 mm to 1524 mm	(+1.6 mm, -0.00 mm)	(+0.00 mm, -1.6 mm)
1524 mm and above	(+2.4 mm, -0.00 mm)	(+0.00 mm, -2.4 mm)

Thickness +0.015" - 0.00" (+0.381 mm, -0.00 mm) on special gaskets with:

- a. Less than 1" (25.4 mm) ID greater than 26" (660.4 mm) ID.
- b. PTFE fillers
- c. 1" (25.4 mm) or larger flange width.

Thickness +0.010 - 0.000" (+0.254 mm, -0.00 mm) for most other sizes and materials.

DIMENSIONS FOR STYLE WRI PER ASME B16.20
TO SUIT ASME B16.5 FLANGES

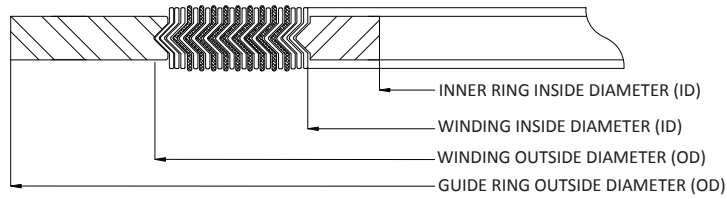

Nominal Pipe Size (NPS)	Class 150							
	Inner Ring Inside Diameter (ID)		Winding Inside Diameter (ID)		Winding Outside Diameter (OD)		Guide Ring Outside Diameter (OD)	
	Inches	mm	Inches	mm	Inches	mm	Inches	mm
1/4*	-	-	0.50	12.7	0.88	22.2	1.75	44.5
1/2	0.56	14.2	0.75	19.1	1.25	31.8	1.88	47.6
3/4	0.81	20.6	1.00	25.4	1.56	39.7	2.25	57.2
1	1.06	26.9	1.25	31.8	1.88	47.6	2.63	66.7
1 1/4	1.50	38.1	1.88	47.6	2.38	60.3	3.00	76.2
1 1/2	1.75	44.5	2.13	54.0	2.75	69.9	3.38	85.7
2	2.19	55.6	2.75	69.9	3.38	85.7	4.13	104.8
2 1/2	2.62	66.5	3.25	82.6	3.88	98.4	4.88	123.8
3	3.19	81.0	4.00	101.6	4.75	120.7	5.38	136.5
3 1/2*	3.50	88.9	4.50	114.3	5.25	133.4	6.38	161.9
4	4.19	106.4	5.00	127.0	5.88	149.2	6.88	174.6
5	5.19	131.8	6.13	155.6	7.00	177.8	7.75	196.9
6	6.19	157.2	7.19	182.6	8.25	209.6	8.75	222.3
8	8.50	215.9	9.19	233.4	10.38	263.5	11.00	279.4
10	10.56	268.2	11.31	287.3	12.50	317.5	13.38	339.7
12	12.50	317.5	13.38	339.7	14.75	374.7	16.13	409.6
14	13.75	349.3	14.63	371.5	16.00	406.4	17.75	450.9
16	15.75	400.1	16.63	422.3	18.25	463.6	20.25	514.4
18	17.69	449.3	18.69	474.7	20.75	527.1	21.63	549.3
20	19.69	500.1	20.69	525.5	22.75	577.9	23.88	606.4
24	23.75	603.3	24.75	628.7	27.00	685.8	28.25	717.6

*Not Listed in ASME B16.20

DOUBLE COLOR CODING FOR SPIRASEAL® GASKETS PER ASME B16.20

METALLIC WINDINGS

NON-METALLIC FILLERS

304 SS	Yellow	Incoloy 800/825	White	PTFE	White Stripe
316L SS	Green	Titanium	Purple	Ceramic	Light Green Stripe
317L SS	Maroon	Alloy 20	Black	Flexible Graphite	Gray Stripe
347 SS	Blue	Carbon Steel	Silver	Phyllosilicate (HTG)	Light Blue Stripe
321 SS	Turquoise	Hastelloy® "B"	Brown		
Monel®	Orange	Hastelloy® "C"	Beige		
Inconel® 600/625	Gold	Phos. Bronze	Copper		
Nickel	Red				

**DIMENSIONS FOR STYLE WRI PER ASME B16.20
TO SUIT ASME B16.5 FLANGES**

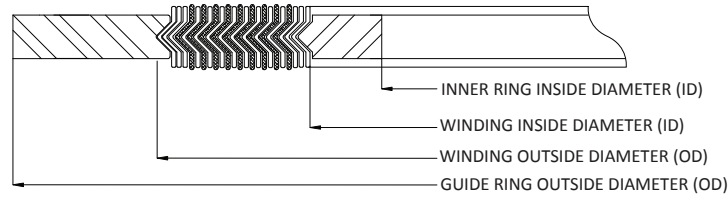

Nominal Pipe Size (NPS)	Class 300							
	Inner Ring Inside Diameter (ID)		Winding Inside Diameter (ID)		Winding Outside Diameter (OD)		Guide Ring Outside Diameter (OD)	
	Inches	mm	Inches	mm	Inches	mm	Inches	mm
1/4*	-	-	0.50	12.7	0.88	22.2	1.75	44.5
1/2	0.56	14.2	0.75	19.1	1.25	31.8	2.13	54.0
3/4	0.81	20.6	1.00	25.4	1.56	39.7	2.63	66.7
1	1.06	26.9	1.25	31.8	1.88	47.6	2.88	73.0
1 1/4	1.50	38.1	1.88	47.6	2.38	60.3	3.25	82.6
1 1/2	1.75	44.5	2.13	54.0	2.75	69.9	3.75	95.3
2	2.19	55.6	2.75	69.9	3.38	85.7	4.38	111.1
2 1/2	2.62	66.5	3.25	82.6	3.88	98.4	5.13	130.2
3	3.19	81.0	4.00	101.6	4.75	120.7	5.88	149.2
3 1/2*	3.50	88.9	4.50	114.3	5.25	133.4	6.50	165.1
4	4.19	106.4	5.00	127.0	5.88	149.2	7.13	181.0
5	5.19	131.8	6.13	155.6	7.00	177.8	8.50	215.9
6	6.19	157.2	7.19	182.6	8.25	209.6	9.88	250.8
8	8.50	215.9	9.19	233.4	10.38	263.5	12.13	308.0
10	10.56	268.2	11.31	287.3	12.50	317.5	14.25	362.0
12	12.50	317.5	13.38	339.7	14.75	374.7	16.63	422.3
14	13.75	349.3	14.63	371.5	16.00	406.4	19.13	485.8
16	15.75	400.1	16.63	422.3	18.25	463.6	21.25	539.8
18	17.69	449.3	18.69	474.7	20.75	527.1	23.50	596.9
20	19.69	500.1	20.69	525.5	22.75	577.9	25.75	654.1
24	23.75	603.3	24.75	628.7	27.00	685.8	30.50	774.7

Nominal Pipe Size (NPS)	Class 400							
	Inner Ring Inside Diameter (ID)		Winding Inside Diameter (ID)		Winding Outside Diameter (OD)		Guide Ring Outside Diameter (OD)	
	Inches	mm	Inches	mm	Inches	mm	Inches	mm
1/4*	-	-	0.50	12.7	0.88	22.2	1.75	44.5
1/2	0.56	14.2	0.75	19.1	1.25	31.8	2.13	54.0
3/4	0.81	20.6	1.00	25.4	1.56	39.7	2.63	66.7
1	1.06	26.9	1.25	31.8	1.88	47.6	2.88	73.0
1 1/4	1.50	38.1	1.88	47.6	2.38	60.3	3.25	82.6
1 1/2	1.75	44.5	2.13	54.0	2.75	69.9	3.75	95.3
2	2.19	55.6	2.75	69.9	3.38	85.7	4.38	111.1
2 1/2	2.62	66.5	3.25	82.6	3.88	98.4	5.13	130.2
3	3.19	81.0	4.00	101.6	4.75	120.7	5.88	149.2
3 1/2*	3.50	88.9	4.13	104.8	5.25	133.4	6.38	161.9
4	4.04	102.6	4.75	120.7	5.88	149.2	7.00	177.8
5	5.05	128.3	5.81	147.6	7.00	177.8	8.38	212.7
6	6.10	154.9	6.88	174.6	8.25	209.6	9.75	247.7
8	8.10	205.7	8.88	225.4	10.38	263.5	12.00	304.8
10	10.05	255.3	10.81	274.6	12.50	317.5	14.13	358.8
12	12.10	307.3	12.88	327.0	14.75	374.7	16.50	419.1
14	13.50	342.9	14.25	362.0	16.00	406.4	19.00	482.6
16	15.35	389.9	16.25	412.8	18.25	463.6	21.13	536.6
18	17.25	438.2	18.50	469.9	20.75	527.1	23.38	593.7
20	19.25	489.0	20.50	520.7	22.75	577.9	25.50	647.7
24	23.25	590.6	24.75	628.7	27.00	685.8	30.25	768.4

*Not Listed in ASME B16.20

DIMENSIONS FOR STYLE WRI PER ASME B16.20
TO SUIT ASME B16.5 FLANGES

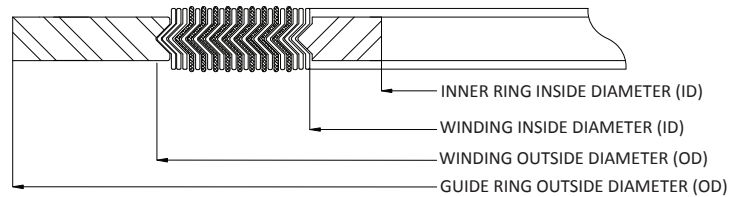

Nominal Pipe Size (NPS)	Class 600							
	Inner Ring Inside Diameter (ID)		Winding Inside Diameter (ID)		Winding Outside Diameter (OD)		Guide Ring Outside Diameter (OD)	
	Inches	mm	Inches	mm	Inches	mm	Inches	mm
1/4*	-	-	0.50	12.7	0.88	22.2	1.75	44.5
1/2	0.56	14.2	0.75	19.1	1.25	31.8	2.13	54.0
3/4	0.81	20.6	1.00	25.4	1.56	39.7	2.63	66.7
1	1.06	26.9	1.25	31.8	1.88	47.6	2.88	73.0
1 1/4	1.50	38.1	1.88	47.6	2.38	60.3	3.25	82.6
1 1/2	1.75	44.5	2.13	54.0	2.75	69.9	3.75	95.3
2	2.19	55.6	2.75	69.9	3.38	85.7	4.38	111.1
2 1/2	2.62	66.5	3.25	82.6	3.88	98.4	5.13	130.2
3	3.19	81.0	4.00	101.6	4.75	120.7	5.88	149.2
3 1/2	3.50	88.9	4.13	104.8	5.25	133.4	6.38	161.9
4	4.04	102.6	4.75	120.7	5.88	149.2	7.63	193.7
5	5.05	128.3	5.81	147.6	7.00	177.8	9.50	241.3
6	6.10	154.9	6.88	174.6	8.25	209.6	10.50	266.7
8	8.10	205.7	8.88	225.4	10.38	263.5	12.63	320.7
10	10.05	255.3	10.81	274.6	12.50	317.5	15.75	400.1
12	12.10	307.3	12.88	327.0	14.75	374.7	18.00	457.2
14	13.50	342.9	14.25	362.0	16.00	406.4	19.38	492.1
16	15.35	389.9	16.25	412.8	18.25	463.6	22.25	565.2
18	17.25	438.2	18.50	469.9	20.75	527.1	24.13	612.8
20	19.25	489.0	20.50	520.7	22.75	577.9	26.88	682.6
24	23.25	590.6	24.75	628.7	27.00	685.8	31.13	790.6

Nominal Pipe Size (NPS)	Class 900							
	Inner Ring Inside Diameter (ID)		Winding Inside Diameter (ID)		Winding Outside Diameter (OD)		Guide Ring Outside Diameter (OD)	
	Inches	mm	Inches	mm	Inches	mm	Inches	mm
1/4*	-	-	-	-	-	-	-	-
1/2	0.56	14.2	0.75	19.1	1.25	31.8	2.50	63.5
3/4	0.81	20.6	1.00	25.4	1.56	39.7	2.75	69.9
1	1.06	26.9	1.25	31.8	1.88	47.6	3.13	79.4
1 1/4	1.31	33.3	1.56	39.7	2.38	60.3	3.50	88.9
1 1/2	1.63	41.4	1.88	47.6	2.75	69.9	3.88	98.4
2	2.06	52.3	2.31	58.7	3.38	85.7	5.63	142.9
2 1/2	2.50	63.5	2.75	69.9	3.88	98.4	6.50	165.1
3	3.10	78.7	3.75	95.3	4.75	120.7	6.63	168.3
3 1/2*	3.50	88.9	4.13	104.8	5.25	133.4	7.50	190.5
4	4.04	102.6	4.75	120.7	5.88	149.2	8.13	206.4
5	5.05	128.3	5.81	147.6	7.00	177.8	9.75	247.7
6	6.10	154.9	6.88	174.6	8.25	209.6	11.38	288.9
8	7.75	196.9	8.75	222.3	10.13	257.2	14.13	358.8
10	9.69	246.1	10.88	276.2	12.25	311.2	17.13	435.0
12	11.50	292.1	12.75	323.9	14.50	368.3	19.63	498.5
14	12.63	320.8	14.00	355.6	15.75	400.1	20.50	520.7
16	14.75	374.7	16.25	412.8	18.00	457.2	22.63	574.7
18	16.75	425.5	18.25	463.6	20.50	520.7	25.13	638.2
20	19.00	482.6	20.50	520.7	22.50	571.5	27.50	698.5
24	23.25**	590.6	24.75	628.7	26.75	679.5	33.00	838.2

*Not Listed in ASME B16.20 ** Inner rings are required

**DIMENSIONS FOR STYLE WRI PER ASME B16.20
TO SUIT ASME B16.5 FLANGES**

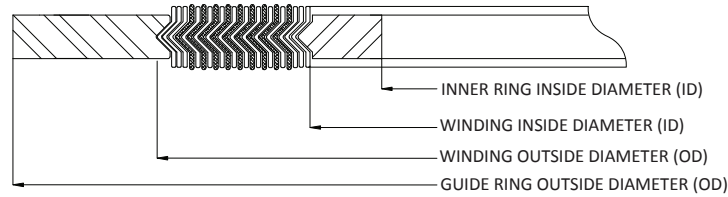

Nominal Pipe Size (NPS)	Class 1500							
	Inner Ring Inside Diameter (ID)		Winding Inside Diameter (ID)		Winding Outside Diameter (OD)		Guide Ring Outside Diameter (OD)	
	Inches	mm	Inches	mm	Inches	mm	Inches	mm
1/4*	-	-	-	-	-	-	-	-
1/2	0.56	14.2	0.75	19.1	1.25	31.8	2.50	63.5
3/4	0.81	20.6	1.00	25.4	1.56	39.7	2.75	69.9
1	1.06	26.9	1.25	31.8	1.88	47.6	3.13	79.4
1 1/4	1.31	33.3	1.56	39.7	2.38	60.3	3.50	88.9
1 1/2	1.63	41.4	1.88	47.6	2.75	69.9	3.88	98.4
2	2.06	52.3	2.31	58.7	3.38	85.7	5.63	142.9
2 1/2	2.50	63.5	2.75	69.9	3.88	98.4	6.50	165.1
3	3.10	78.7	3.63	92.1	4.75	120.7	6.88	174.6
3 1/2*	3.50	88.9	4.13	104.8	5.25	133.4	7.38	187.3
4	3.85	97.8	4.63	117.5	5.88	149.2	8.25	209.6
5	4.90	124.5	5.63	142.9	7.00	177.8	10.00	254.0
6	5.80	147.3	6.75	171.5	8.25	209.6	11.13	282.6
8	7.75	196.9	8.50	215.9	10.13	257.2	13.88	352.4
10	9.69	246.1	10.50	266.7	12.25	311.2	17.13	435.0
12	11.50**	292.1**	12.75	323.9	14.50	368.3	20.50	520.7
14	12.63**	320.8**	14.25	362.0	15.75	400.1	22.75	577.9
16	14.50**	368.3**	16.00	406.4	18.00	457.2	25.25	641.4
18	16.75**	425.5**	18.25	463.6	20.50	520.7	27.75	704.9
20	18.75**	476.3**	20.25	514.4	22.50	571.5	29.75	755.7
24	22.75**	577.9**	24.25	616.0	26.75	679.5	35.50	901.7

Nominal Pipe Size (NPS)	Class 2500							
	Inner Ring Inside Diameter (ID)		Winding Inside Diameter (ID)		Winding Outside Diameter (OD)		Guide Ring Outside Diameter (OD)	
	Inches	mm	Inches	mm	Inches	mm	Inches	mm
1/4*	-	-	-	-	-	-	-	-
1/2	0.56	14.2	0.75	19.1	1.25	31.8	2.75	69.9
3/4	0.81	20.6	1.00	25.4	1.56	39.7	3.00	76.2
1	1.06	26.9	1.25	31.8	1.88	47.6	3.38	85.7
1 1/4	1.31	33.3	1.56	39.7	2.38	60.3	4.13	104.8
1 1/2	1.63	41.4	1.88	47.6	2.75	69.9	4.63	117.5
2	2.06	52.3	2.31	58.7	3.38	85.7	5.75	146.1
2 1/2	2.50	63.5	2.75	69.9	3.88	98.4	6.63	168.3
3	3.10	78.7	3.63	92.1	4.75	120.7	7.75	196.9
3 1/2*	3.50	88.9	-	-	-	-	-	-
4	3.85**	97.8**	4.63	117.5	5.88	149.2	9.25	235.0
5	4.90**	124.5**	5.63	142.9	7.00	177.8	11.00	279.4
6	5.80**	147.3**	6.75	171.5	8.25	209.6	12.50	317.5
8	7.75**	196.9**	8.50	215.9	10.13	257.2	15.25	387.4
10	9.69**	246.1**	10.63	269.9	12.25	311.2	18.75	476.3
12	11.50**	292.1**	12.50	317.5	14.50	368.3	21.63	549.3

*Not Listed in ASME B16.20 ** Inner rings are required

GASKET SELECTION

**SPIRAL-WOUND WR/WRI TOLERANCES
PER ASME B16.20 SPECIFICATIONS**

- The winding thickness: $\pm 0.005''$ (0.13 mm) measured across the metallic portion of the winding not including the filler.
- The winding outside diameter
 - o NPS ½ through NPS 8 is $\pm 1/32''$ (± 0.8 mm)
 - o NPS 10 through NPS 24 is $+1/16''$, $- 1/32''$ (+1.5 mm, -0.8 mm)
- The winding inside diameter
 - o NPS ½ through NPS 8 is $\pm 1/64''$ (± 0.4 mm)
 - o NPS 10 through NPS 24 is $\pm 1/32''$ (± 0.8 mm)
- The guide ring outside diameter: $\pm 1/32''$ (± 0.8 mm)
- The guide ring and inner thickness shall be from 0.117'' (2.97 mm) to 0.131'' (3.33 mm)
- The inner ring inside diameter:
 - o NPS ½ through 3 is $\pm 1/32''$ (± 0.8 mm)
 - o NPS 4 through 24 is $\pm 1/16''$ (± 1.5 mm)

TABLE FOR MINIMUM PIPE WALL THICKNESS THAT IS SUITABLE FOR USE WITH STANDARD INNER RINGS PER THE ASME B16.20

Nominal Pipe Size (NPS)	Pressure Class								
	150	300	400	600	900	1500	2500		
1/2	Schedule 80								
3/4									
1									
1 1/4	Schedule 40					Schedule 80			
1 1/2									
2									
2 1/2									
3									
3 1/2*									
4									
5	Schedule 10S					Schedule 80			
6									
8						Schedule 30		Schedule 80	
10									
12								Schedule 80	
14									
16									
18									
20									
24									

General Notes per ASME B16.20:

- The pipe wall schedules identified represent the minimum pipe wall thickness suitable for use with inner rings for ASME B16.5 flanges (reference ASME B 36.10M and B36.19M).
- Gasket with inner rings should be used only with socket welding, lapped, welding neck, and integral flanges.

* Not Listed in ASME B16.20

**TABLE FOR LIMITATIONS ON THE MAXIMUM ASME B16.5 FLANGE BORE
FOR USE WITH STANDARD ASME B16.20 SPIRAL WOUND GASKETS**

Nominal Pipe Size (NPS)	Pressure Class							
	150	300	400	600	900 (1)	1500 (1)	2500 (1)	
1/2	WN Flange only (2)		No Flanges Use 600	WN Flange only	No Flanges Use 1500	WN flange only (2)		
3/4				SO Flange (3) WN Flange (2)				
1				SO and WN Flange any bore				
1 1/4	SO Flange (3) WN Flange, any bore			SO and WN Flange any bore		WN flange with SW bore (include nozzle (4) but excludes SO flange)		
1 1/2								
2	SO and WN Flange any bore		WN Flange with Schedule 0S bore described in ASME B36.19M (Includes nozzle (4) but excludes SO Flanges)			WN flange with schedule 80 bore (excludes nozzle (4) and SO flange) (5)		
2 1/2								
3								
4								
5								
6			WN Flange with Schedule 10S bore described in ASME B36.19M (Excludes nozzle (4) and SO Flanges) (5)				No Flanges	
8								
10								
12								
14								
16								
18								
20								
24								

Abbreviations:

- SO = slip on and threaded
- WN = welding neck
- SW = standard wall

Notes per the ASME B16.20 specification:

1. Inner rings are required for class 900 NPS 24, class 1500 NPS 12 through 24, and class 2500 NPS 4 through NPS 12 per the ASME B16.20. These inner rings may extend into the pipe bore a maximum of 1/16" (1.5 mm) under the worst combination of maximum bore, eccentric installation, and additive tolerances.
2. In these sizes, the gasket is suitable for a welding neck flange with a standard wall bore, if the gasket and the flanges are assembled concentrically. This also applies to a nozzle. It is the user's responsibility to determine if the gasket is satisfactory for a flange or any larger bore.
3. Gaskets in these sizes are suitable for slip on flanges only if the gaskets and flanges are assembled concentrically
4. A nozzle is a long welding neck; the bore equals the flange NPS
5. A NPS 24 gasket is suitable for nozzles.

**DIMENSIONS FOR STYLE WR/WRI TO SUIT AWWA C207
CLASS E SLIP-ON AND WELDING NECK FLANGES**

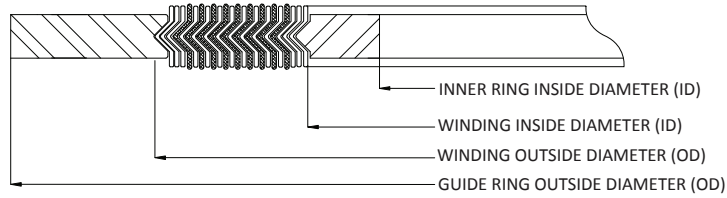

Nominal Pipe Size (NPS)	Class 125							
	Inner Ring Inside Diameter (ID)		Winding Inside Diameter (ID)		Winding Outside Diameter (OD)		Guide Ring Outside Diameter (OD)	
	Inches	mm	Inches	mm	Inches	mm	Inches	mm
22	22.00	558.8	22.75	577.9	24.00	609.6	26.00	660.4
26	26.00	660.4	26.50	673.1	27.75	704.9	30.50	774.7
28	28.00	711.2	28.50	723.9	27.75	704.9	32.75	831.9
30	30.00	762.0	30.50	774.7	31.75	806.5	34.75	882.7
32	32.00	812.8	32.50	825.5	33.88	860.4	37.00	939.8
34	34.00	863.6	34.50	876.3	35.88	911.2	39.00	990.6
36	36.00	914.4	36.50	927.1	38.13	968.4	41.25	1047.8
38	38.00	965.2	38.50	977.9	40.13	1019.2	43.75	1111.3
40	40.00	1016.0	40.50	1028.7	42.13	1070.0	45.75	1162.1
42	42.00	1066.8	42.50	1079.5	44.25	1124.0	48.00	1219.2
44	44.00	1117.6	44.50	1130.3	46.38	1177.9	50.25	1276.4
46	46.00	1168.4	46.50	1181.1	48.38	1228.7	52.25	1327.2
48	48.00	1219.2	48.50	1231.9	50.38	1279.5	54.50	1384.3
50	50.00	1270.0	50.50	1282.7	52.50	1333.5	56.50	1435.1
52	52.00	1320.8	52.50	1333.5	54.50	1384.3	58.75	1492.3
54	54.00	1371.6	54.50	1384.3	56.50	1435.1	61.00	1549.4
60	60.00	1524.0	60.50	1536.7	62.50	1587.5	67.50	1714.5

Nominal Pipe Size (NPS)	Class 175							
	Inner Ring Inside Diameter (ID)		Winding Inside Diameter (ID)		Winding Outside Diameter (OD)		Guide Ring Outside Diameter (OD)	
	Inches	mm	Inches	mm	Inches	mm	Inches	mm
26	26.00	660.4	26.50	673.1	27.75	704.9	29.13	739.8
28	28.00	711.2	28.50	723.9	29.75	755.7	31.13	790.6
30	30.00	762.0	30.50	774.7	31.75	806.5	33.38	847.7
32	32.00	812.8	32.50	825.5	33.75	857.3	35.38	898.5
34	34.00	863.6	34.50	876.3	35.88	911.2	37.50	952.5
36	36.00	914.4	36.50	927.1	37.88	962.0	39.50	1003.3
38	38.00	965.2	38.50	977.9	39.88	1012.8	41.50	1054.1
40	40.00	1016.0	40.50	1028.7	42.00	1066.8	43.50	1104.9
42	42.00	1066.8	42.50	1079.5	44.00	1117.6	45.88	1165.2
44	44.00	1117.6	44.50	1130.3	46.00	1168.4	47.88	1216.0
46	46.00	1168.4	46.50	1181.1	48.00	1219.2	49.88	1266.8
48	48.00	1219.2	48.50	1231.9	50.13	1273.2	51.88	1317.6
50	50.00	1270.0	50.50	1282.7	52.25	1327.2	53.88	1368.4
52	52.00	1320.8	52.50	1333.5	54.38	1381.1	56.13	1425.6
54	54.00	1371.6	54.50	1384.3	56.38	1431.9	58.13	1476.4
60	60.00	1524.0	60.50	1536.7	62.50	1587.5	61.13	1552.6

DIMENSIONS FOR STYLE WR/WRI TO SUIT AWWA C207
CLASS E SLIP-ON AND WELDING NECK FLANGES

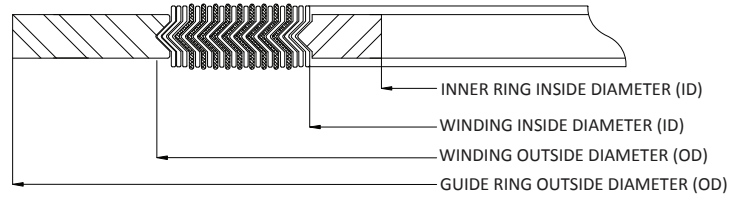

Nominal Pipe Size (NPS)	Class 250							
	Inner Ring Inside Diameter (ID)		Winding Inside Diameter (ID)		Winding Outside Diameter (OD)		Guide Ring Outside Diameter (OD)	
	Inches	mm	Inches	mm	Inches	mm	Inches	mm
26	26.00	660.4	26.50	673.1	27.75	704.9	32.75	831.9
28	28.00	711.2	28.50	723.9	29.75	755.7	35.25	895.4
30	30.00	762.0	30.50	774.7	31.75	806.5	37.50	952.5
32	32.00	812.8	32.50	825.5	33.88	860.4	39.75	1009.7
34	34.00	863.6	34.50	876.3	35.88	911.2	41.75	1060.5
36	36.00	914.4	36.50	927.1	38.13	968.4	44.00	1117.6
38	38.00	965.2	38.50	977.9	40.13	1019.2	46.00	1168.4
40	40.00	1016.0	40.50	1028.7	42.13	1070.0	48.25	1225.6
42	42.00	1066.8	42.50	1079.5	44.25	1124.0	50.75	1289.1
44	44.00	1117.6	44.50	1130.3	46.38	1177.9	53.00	1346.2
46	46.00	1168.4	46.50	1181.1	48.38	1228.7	55.25	1403.4
48	48.00	1219.2	48.50	1231.9	50.38	1279.5	58.75	1492.3

Nominal Pipe Size (NPS)	Class 350							
	Inner Ring Inside Diameter (ID)		Winding Inside Diameter (ID)		Winding Outside Diameter (OD)		Guide Ring Outside Diameter (OD)	
	Inches	mm	Inches	mm	Inches	mm	Inches	mm
26	26.00	660.4	26.50	673.1	27.75	704.9	29.63	752.5
28	28.00	711.2	28.50	723.9	29.75	755.7	31.63	803.3
30	30.00	762.0	30.50	774.7	31.75	806.5	33.88	860.4
32	32.00	812.8	32.50	825.5	33.88	860.4	35.88	911.2
34	34.00	863.6	34.50	876.3	35.88	911.2	37.88	962.0
36	36.00	914.4	36.50	927.1	38.13	968.4	40.38	1025.5
38	38.00	965.2	38.50	977.9	40.13	1019.2	42.38	1076.3
40	40.00	1016.0	40.50	1028.7	42.13	1070.0	44.38	1127.1
42	42.00	1066.8	42.50	1079.5	44.25	1124.0	46.63	1184.3
44	44.00	1117.6	44.50	1130.3	46.38	1177.9	49.00	1244.6
46	46.00	1168.4	46.50	1181.1	48.38	1228.7	51.00	1295.4
48	48.00	1219.2	48.50	1231.9	50.38	1279.5	53.00	1346.2
52	52.00	1320.8	52.50	1333.5	54.25	1378.0	57.38	1457.3
54	54.00	1371.6	54.50	1384.3	56.50	1435.1	59.38	1508.1
60	60.00	1524.0	60.50	1536.7	62.50	1587.5	65.38	1660.5
66	66.00	1676.4	66.50	1689.1	68.50	1739.9	72.50	1841.5

GASKET SELECTION

**DIMENSIONS FOR STYLE WR/WRI PER ASME B16.20 TO SUIT
ASME B16.47 SERIES A OR MSS-SP-44 FLANGES**

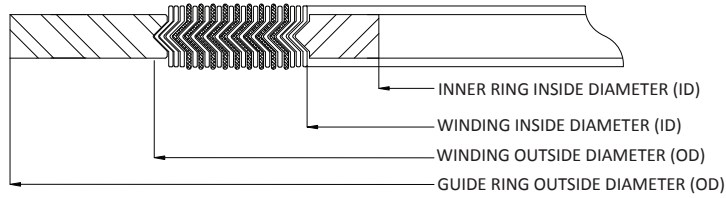

Nominal Pipe Size (NPS)	Class 150							
	Inner Ring Inside Diameter (ID)		Winding Inside Diameter (ID)		Winding Outside Diameter (OD)		Guide Ring Outside Diameter (OD)	
	Inches	mm	Inches	mm	Inches	mm	Inches	mm
22*	-	-	22.75	577.9	24.00	609.6	26.00	660.4
26	25.75	654.1	26.50	673.1	27.75	704.9	30.50	774.7
28	27.75	704.9	28.50	723.9	29.75	755.7	32.75	831.9
30	29.75	755.7	30.50	774.7	31.75	806.5	34.75	882.7
32	31.75	806.5	32.50	825.5	33.88	860.4	37.00	939.8
34	33.75	857.3	34.50	876.3	35.88	911.2	39.00	990.6
36	35.75	908.1	36.50	927.1	38.13	968.4	41.25	1047.8
38	37.75	958.9	38.50	977.9	40.13	1019.2	43.75	1111.3
40	39.75	1009.7	40.50	1028.7	42.13	1070.0	45.75	1162.1
42	41.75	1060.5	42.50	1079.5	44.25	1124.0	48.00	1219.2
44	43.75	1111.3	44.50	1130.3	46.38	1177.9	50.25	1276.4
46	45.75	1162.1	46.50	1181.1	48.38	1228.7	52.25	1327.2
48	47.75	1212.9	48.50	1231.9	50.38	1279.5	54.50	1384.3
50	49.75	1263.7	50.50	1282.7	52.50	1333.5	56.50	1435.1
52	51.75	1314.5	52.50	1333.5	54.50	1384.3	58.75	1492.3
54	53.50	1358.9	54.50	1384.3	56.50	1435.1	61.00	1549.4
56	55.50	1409.7	56.50	1435.1	58.50	1485.9	63.25	1606.6
58	57.50	1460.5	58.50	1485.9	60.50	1536.7	65.50	1663.7
60	59.50	1511.3	60.50	1536.7	62.50	1587.5	67.50	1714.5

Nominal Pipe Size (NPS)	Class 300							
	Inner Ring Inside Diameter (ID)		Winding Inside Diameter (ID)		Winding Outside Diameter (OD)		Guide Ring Outside Diameter (OD)	
	Inches	mm	Inches	mm	Inches	mm	Inches	mm
22*	-	-	22.75	577.9	24.75	628.7	27.75	704.9
26	25.75	654.1	27.00	685.8	29.00	736.6	32.88	835.0
28	27.75	704.9	29.00	736.6	31.00	787.4	35.38	898.5
30	29.75	755.7	31.25	793.8	33.25	844.6	37.50	952.5
32	31.75	806.5	33.50	850.9	35.50	901.7	39.63	1006.5
34	33.75	857.3	35.50	901.7	37.50	952.5	41.63	1057.3
36	35.75	908.1	37.63	955.7	39.63	1006.5	44.00	1117.6
38	37.50	952.5	38.50	977.9	40.00	1016.0	41.50	1054.1
40	39.50	1003.3	40.25	1022.4	42.13	1070.0	43.88	1114.4
42	41.50	1054.1	42.25	1073.2	44.13	1120.8	45.88	1165.2
44	43.50	1104.9	44.50	1130.3	46.50	1181.1	48.00	1219.2
46	45.38	1152.7	46.38	1177.9	48.38	1228.7	50.13	1273.2
48	47.63	1209.8	48.63	1235.1	50.63	1285.9	52.13	1324.0
50	49.00	1244.6	51.00	1295.4	53.00	1346.2	54.25	1378.0
52	52.00	1320.8	53.00	1346.2	55.00	1397.0	56.25	1428.8
54	53.25	1352.6	55.25	1403.4	57.25	1454.2	58.75	1492.3
56	55.25	1403.4	57.25	1454.2	59.25	1505.0	60.75	1543.1
58	57.00	1447.8	59.50	1511.3	61.50	1562.1	62.75	1593.9
60	60.00	1524.0	61.50	1562.1	63.50	1612.9	64.75	1644.7

*Not listed in ASME B16.20

DIMENSIONS FOR STYLE WR/WRI PER ASME B16.20 TO SUIT
ASME B16.47 SERIES A OR MSS-SP-44 FLANGES

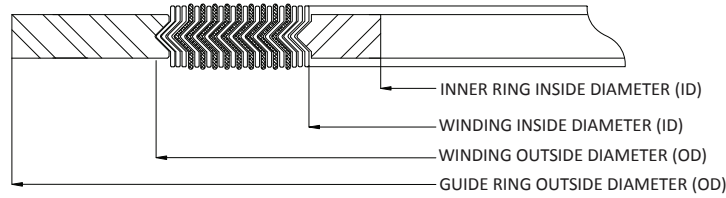

Nominal Pipe Size (NPS)	Class 400							
	Inner Ring Inside Diameter (ID)		Winding Inside Diameter (ID)		Winding Outside Diameter (OD)		Guide Ring Outside Diameter (OD)	
	Inches	mm	Inches	mm	Inches	mm	Inches	mm
22*	-	-	22.75	577.9	24.75	628.7	27.63	701.7
26	26.00	660.4	27.00	685.8	29.00	736.6	32.75	831.9
28	28.00	711.2	29.00	736.6	31.00	787.4	35.13	892.2
30	29.75	755.7	31.25	793.8	33.25	844.6	37.25	946.2
32	32.00	812.8	33.50	850.9	35.50	901.7	39.50	1003.3
34	34.00	863.6	35.50	901.7	37.50	952.5	41.50	1054.1
36	36.13	917.7	37.63	955.7	39.63	1006.5	44.00	1117.6
38	37.50	952.5	38.25	971.6	40.25	1022.4	42.25	1073.2
40	39.38	1000.3	40.38	1025.5	42.38	1076.3	44.38	1127.1
42	41.38	1051.1	42.38	1076.3	44.38	1127.1	46.38	1177.9
44	43.50	1104.9	44.50	1130.3	46.50	1181.1	48.50	1231.9
46	46.00	1168.4	47.00	1193.8	49.00	1244.6	50.75	1289.1
48	47.50	1206.5	49.00	1244.6	52.00	1320.8	53.00	1346.2
50	49.50	1257.3	51.00	1295.4	53.00	1346.2	55.25	1403.4
52	51.50	1308.1	53.00	1346.2	55.00	1397.0	57.25	1454.2
54	53.25	1352.6	55.25	1403.4	57.25	1454.2	59.75	1517.7
56	55.25	1403.4	57.25	1454.2	59.25	1505.0	61.75	1568.5
58	57.25	1454.2	59.25	1505.0	61.25	1555.8	63.75	1619.3
60	59.75	1517.7	61.75	1568.5	63.75	1619.3	66.25	1682.8

Nominal Pipe Size (NPS)	Class 600							
	Inner Ring Inside Diameter (ID)		Winding Inside Diameter (ID)		Winding Outside Diameter (OD)		Guide Ring Outside Diameter (OD)	
	Inches	mm	Inches	mm	Inches	mm	Inches	mm
22*	-	-	22.75	577.9	24.75	628.7	28.88	733.4
26	25.50	647.7	27.00	685.8	29.00	736.6	34.13	866.8
28	27.50	698.5	29.00	736.6	31.00	787.4	36.00	914.4
30	29.75	755.7	31.25	793.8	33.25	844.6	38.25	971.6
32	32.00	812.8	33.50	850.9	35.50	901.7	40.25	1022.4
34	34.00	863.6	35.50	901.7	37.50	952.5	42.25	1073.2
36	36.13	917.7	37.63	955.7	39.63	1006.5	44.50	1130.3
38	37.50	952.5	39.00	990.6	41.00	1041.4	43.50	1104.9
40	39.75	1009.7	41.25	1047.8	43.25	1098.6	45.50	1155.7
42	42.00	1066.8	43.50	1104.9	45.50	1155.7	48.00	1219.2
44	43.75	1111.3	45.75	1162.1	47.75	1212.9	50.00	1270.0
46	45.75	1162.1	47.75	1212.9	49.75	1263.7	52.25	1327.2
48	48.00	1219.2	50.00	1270.0	52.00	1320.8	54.75	1390.7
50	50.00	1270.0	52.00	1320.8	54.00	1371.6	57.00	1447.8
52	52.00	1320.8	54.00	1371.6	56.00	1422.4	59.00	1498.6
54	54.25	1378.0	56.25	1428.8	58.25	1479.6	61.25	1555.8
56	56.25	1428.8	58.25	1479.6	60.25	1530.4	63.50	1612.9
58	58.00	1473.2	60.50	1536.7	62.50	1587.5	65.50	1663.7
60	60.25	1530.4	62.75	1593.9	64.75	1644.7	68.25	1733.6

*Not listed in ASME B16.20

DIMENSIONS FOR STYLE WR/WRI PER ASME B16.20 TO SUIT
ASME B16.47 SERIES A OR MSS-SP-44 FLANGES

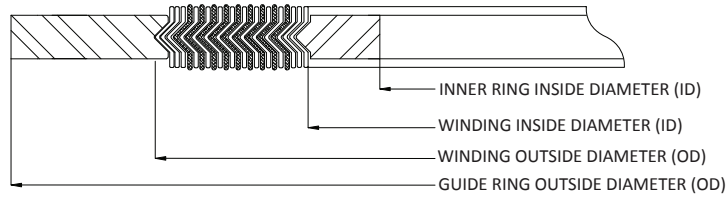

Nominal Pipe Size (NPS)	Class 900							
	Inner Ring Inside Diameter (ID)**		Winding Inside Diameter (ID)		Winding Outside Diameter (OD)		Guide Ring Outside Diameter (OD)	
	Inches	mm	Inches	mm	Inches	mm	Inches	mm
22*	-	-	24.25	616.0	27.00	685.8	33.00	838.2
26	26.00	660.4	27.00	685.8	29.00	736.6	34.75	882.7
28	28.00	711.2	29.00	736.6	31.00	787.4	37.25	946.2
30	30.25	768.4	31.25	793.8	33.25	844.6	39.75	1009.7
32	32.00	812.8	33.50	850.9	35.50	901.7	42.25	1073.2
34	34.00	863.6	35.50	901.7	37.50	952.5	44.75	1136.7
36	36.25	920.8	37.75	958.9	39.75	1009.7	47.25	1200.2
38	39.75	1009.7	40.75	1035.1	42.75	1085.9	47.25	1200.2
40	41.75	1060.5	43.25	1098.6	45.25	1149.4	49.25	1251.0
42	43.75	1111.3	45.25	1149.4	47.25	1200.2	51.25	1301.8
44	45.50	1155.7	47.50	1206.5	49.50	1257.3	53.88	1368.4
46	48.00	1219.2	50.00	1270.0	52.00	1320.8	56.50	1435.1
48	50.00	1270.0	52.00	1320.8	54.00	1371.6	58.50	1485.9

*Not listed in ASME B16.20

**Inner rings are required

LARGE SPIRAL WOUND GASKET TOLERANCES PER ASME B16.20
TO BE USED WITH ASME B16.47 SERIES A FLANGES

- The winding thickness is $\pm 0.005''$ (± 0.13 mm) measured across the metallic portion of the gasket not including the filler
- The winding inside diameter
 - o NPS 26 through NPS 34 is $\pm 1/32''$ (± 0.8 mm)
 - o NPS 36 through NPS 60 is $\pm 3/64''$ (± 1.3 mm)
- The winding outside diameter
 - o NPS 26 through 60 is $\pm 1/16''$ (1.5 mm)
- The guide ring outside diameter tolerance is $\pm 1/32''$ (± 0.8 mm)
- The guide ring and inner thickness shall be from 0.117" (2.97 mm) to 0.131" (3.33 mm)
- The inner ring inside diameter is: $\pm 1/8''$ (± 3.0 mm)
- These inner rings are suitable for use with pipe walls 0.38" (9.53 mm) or thicker

DIMENSIONS FOR STYLE WR/WRI PER ASME B16.20 TO SUIT
ASME B16.47 SERIES B OR API-605 FLANGES

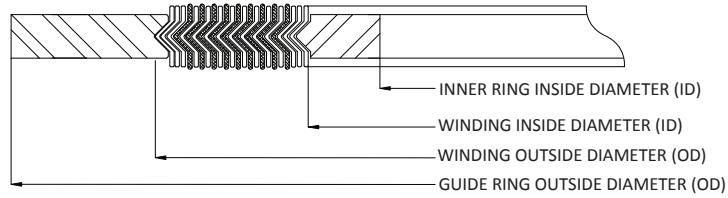

Nominal Pipe Size (NPS)	Class 150							
	Inner Ring Inside Diameter (ID)		Winding Inside Diameter (ID)		Winding Outside Diameter (OD)		Guide Ring Outside Diameter (OD)	
	Inches	mm	Inches	mm	Inches	mm	Inches	mm
26	25.75	654.05	26.50	673.1	27.50	698.5	28.56	725.5
28	27.75	704.9	28.50	723.9	29.50	749.3	30.56	776.3
30	29.75	755.7	30.50	774.7	31.50	800.1	32.56	827.1
32	31.75	806.5	32.50	825.5	33.50	850.9	34.69	881.1
34	33.75	857.3	34.50	876.3	35.75	908.1	36.81	935.0
36	35.75	908.1	36.50	927.1	37.75	958.9	38.88	987.4
38	37.75	958.9	38.38	974.7	39.75	1009.7	41.13	1044.6
40	39.75	1009.7	40.25	1022.4	41.88	1063.6	43.13	1095.4
42	41.75	1060.5	42.50	1079.5	43.88	1114.4	45.13	1146.2
44	43.75	1111.3	44.25	1124.0	45.88	1165.2	47.13	1197.0
46	45.75	1162.1	46.50	1181.1	48.19	1224.0	49.44	1255.7
48	47.75	1212.9	48.50	1231.9	50.00	1270.0	51.44	1306.5
50	49.75	1263.7	50.50	1282.7	52.19	1325.6	53.44	1357.3
52	51.75	1314.5	52.50	1333.5	54.19	1376.4	55.44	1408.1
54	53.75	1365.3	54.50	1384.3	56.00	1422.4	57.63	1463.7
56	56.00	1422.4	56.88	1444.6	58.19	1478.0	59.63	1514.5
58	58.19	1478.0	59.08	1500.6	60.19	1528.8	62.19	1579.6
60	60.44	1535.2	61.31	1557.3	62.44	1585.9	64.19	1630.4

Nominal Pipe Size (NPS)	Class 300							
	Inner Ring Inside Diameter (ID)		Winding Inside Diameter (ID)		Winding Outside Diameter (OD)		Guide Ring Outside Diameter (OD)	
	Inches	mm	Inches	mm	Inches	mm	Inches	mm
26	25.75	654.05	26.50	673.1	28.00	711.2	30.38	771.5
28	27.75	704.9	28.50	723.9	30.00	762.0	32.50	825.5
30	29.75	755.7	30.50	774.7	32.00	812.8	34.88	885.8
32	31.75	806.5	32.50	825.5	34.00	863.6	37.00	939.8
34	33.75	857.3	34.50	876.3	36.00	914.4	39.13	993.8
36	35.75	908.1	36.50	927.1	38.00	965.2	41.25	1047.8
38	38.25	971.6	39.75	1009.7	41.25	1047.8	43.25	1098.6
40	40.25	1022.4	41.75	1060.5	43.25	1098.6	45.25	1149.4
42	42.75	1085.9	43.75	1111.3	45.25	1149.4	47.25	1200.2
44	44.25	1124.0	45.75	1162.1	47.25	1200.2	49.25	1251.0
46	46.38	1178.1	47.88	1216.0	29.38	746.1	51.88	1317.6
48	45.50	1155.7	49.75	1263.7	51.63	1311.3	53.88	1368.4
50	49.88	1267.0	51.88	1317.6	53.38	1355.7	55.88	1419.2
52	51.88	1317.8	53.88	1368.4	55.38	1406.5	57.88	1470.0
54	53.75	1365.3	55.25	1403.4	57.25	1454.2	60.25	1530.4
56	56.25	1428.8	58.25	1479.6	60.00	1524.0	62.75	1593.9
58	58.44	1484.4	60.44	1535.1	61.94	1573.2	65.19	1655.8
60	61.31	1557.3	62.56	1589.1	64.19	1630.4	67.19	1706.6

DIMENSIONS FOR STYLE WR/WRI PER ASME B16.20 TO SUIT
ASME B16.47 SERIES B OR API-605 FLANGES

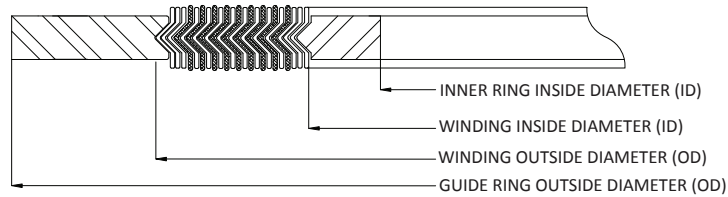

Nominal Pipe Size (NPS)	Class 400							
	Inner Ring Inside Diameter (ID)		Winding Inside Diameter (ID)		Winding Outside Diameter (OD)		Guide Ring Outside Diameter (OD)	
	Inches	mm	Inches	mm	Inches	mm	Inches	mm
26	25.75	654.05	26.25	666.8	27.50	698.5	29.38	746.1
28	27.63	701.8	28.13	714.4	29.50	749.3	31.50	800.1
30	29.63	752.6	30.13	765.2	31.75	806.5	33.75	857.3
32	31.50	800.1	32.00	812.8	33.88	860.4	35.88	911.2
34	33.50	850.9	34.13	866.8	35.88	911.2	37.88	962.0
36	35.38	898.7	36.13	917.6	38.00	965.2	40.25	1022.4
38	37.50	952.5	38.25	971.6	40.25	1022.4	42.25	1073.2
40	39.38	1000.3	40.38	1025.5	42.38	1076.3	44.38	1127.1
42	41.38	1051.1	42.38	1076.3	44.38	1127.1	46.38	1177.9
44	43.50	1104.9	44.50	1130.3	46.50	1181.1	48.50	1231.9
46	46.00	1168.4	47.00	1193.8	49.00	1244.6	50.75	1289.1
48	47.50	1206.5	49.00	1244.6	51.00	1295.4	53.00	1346.2
50	49.50	1257.3	51.00	1295.4	53.00	1346.2	55.25	1403.4
52	51.50	1308.1	53.00	1346.2	55.00	1397.0	57.25	1454.2
54	53.25	1352.6	55.25	1403.4	57.25	1454.2	59.75	1517.7
56	55.25	1403.4	57.25	1454.2	59.25	1505.0	61.75	1568.5
58	57.25	1454.2	59.25	1505.0	61.25	1555.8	63.75	1619.3
60	59.75	1517.7	61.75	1568.5	63.75	1619.3	66.25	1682.8

Nominal Pipe Size (NPS)	Class 600							
	Inner Ring Inside Diameter (ID)		Winding Inside Diameter (ID)		Winding Outside Diameter (OD)		Guide Ring Outside Diameter (OD)	
	Inches	mm	Inches	mm	Inches	mm	Inches	mm
26	25.38	644.652	26.13	663.6	28.13	714.4	30.13	765.2
28	27.00	685.8	27.75	704.9	29.75	755.7	32.25	819.2
30	29.63	752.6	30.63	777.9	32.63	828.7	34.63	879.5
32	31.25	793.8	32.75	831.9	34.75	882.7	36.75	933.5
34	33.50	850.9	35.00	889.0	37.00	939.8	39.25	997.0
36	35.50	901.7	37.00	939.8	39.00	990.6	41.25	1047.8
38	37.50	952.5	39.00	990.6	41.00	1041.4	43.50	1104.9
40	39.75	1009.7	41.25	1047.8	43.25	1098.6	45.50	1155.7
42	42.00	1066.8	43.50	1104.9	45.50	1155.7	48.00	1219.2
44	43.75	1111.3	45.75	1162.1	47.75	1212.9	50.00	1270.0
46	45.75	1162.1	47.75	1212.9	49.75	1263.7	52.25	1327.2
48	48.00	1219.2	50.00	1270.0	52.00	1320.8	54.75	1390.7
50	50.00	1270.0	52.00	1320.8	54.00	1371.6	57.00	1447.8
52	52.00	1320.8	54.00	1371.6	56.00	1422.4	59.00	1498.6
54	54.25	1378.0	56.25	1428.8	58.25	1479.6	61.25	1555.8
56	56.25	1428.8	58.25	1479.6	60.25	1530.4	63.50	1612.9
58	58.00	1473.2	60.50	1536.7	62.50	1587.5	65.50	1663.7
60	60.25	1530.4	62.75	1593.9	64.75	1644.7	68.25	1733.6

DIMENSIONS FOR STYLE WR/WRI PER ASME B16.20 TO SUIT
ASME B16.47 SERIES B OR API-605 FLANGES

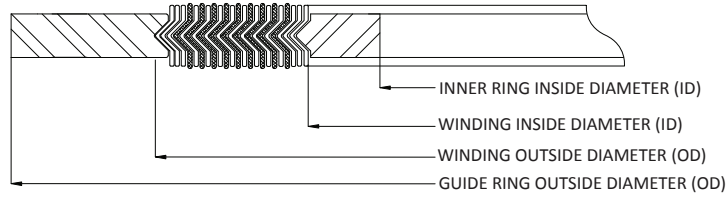

Nominal Pipe Size (NPS)	Class 900							
	Inner Ring Inside Diameter (ID)		Winding Inside Diameter (ID)		Winding Outside Diameter (OD)		Guide Ring Outside Diameter (OD)	
	Inches	mm	Inches	mm	Inches	mm	Inches	mm
26	26.25	666.75	27.25	692.2	29.50	749.3	33.00	838.2
28	28.25	717.6	29.25	743.0	31.50	800.1	35.50	901.7
30	30.75	781.1	31.75	806.5	33.75	857.3	37.75	958.9
32	33.00	838.2	34.00	863.6	36.00	914.4	40.00	1016.0
34	35.25	895.4	36.25	920.8	38.25	971.6	42.25	1073.2
36	36.25	920.8	37.25	946.2	39.25	997.0	44.25	1124.0
38	39.75	1009.7	40.75	1035.1	42.75	1085.9	47.25	1200.2
40	41.75	1060.5	43.25	1098.6	45.25	1149.4	49.25	1251.0
42	43.75	1111.3	45.25	1149.4	47.25	1200.2	51.25	1301.8
44	45.50	1155.7	47.50	1206.5	49.50	1257.3	53.88	1368.4
46	48.00	1219.2	50.00	1270.0	52.00	1320.8	56.50	1435.1
48	50.00	1270.0	52.00	1320.8	54.00	1371.6	58.50	1485.9

* Inner rings are required

LARGE SPIRAL WOUND GASKET TOLERANCES PER ASME B16.20
TO BE USED WITH ASME B16.47 SERIES B FLANGES

- The winding thickness is $\pm 0.005''$ (± 0.13 mm) measured across the metallic portion of the gasket, not including the filler
- The winding inside diameter
 - NPS 26 through NPS 34 NPS is $\pm 1/32''$ (± 0.8 mm)
 - NPS 36 through NPS 60 NPS is $\pm 3/64''$ (± 1.3 mm)
- The winding outside diameter
 - NPS 26 through 60 NPS is $\pm 1/16''$ (1.5 mm)
- The guide ring outside diameter tolerance is $\pm 1/32''$ (± 0.8 mm)
- The guide and inner ring thickness shall be from 0.117'' (2.97 mm) to 0.131'' (3.33 mm)
- The inner ring inside diameter is: $\pm 1/8''$ (± 3.0 mm)
- These inner rings are suitable for use with pipe walls 0.38'' (9.53 mm) or thicker

DIMENSIONS FOR STYLE WR/WRI TO SUIT
ASME/ANSI B16.5 AND SLIP-ON FLANGES

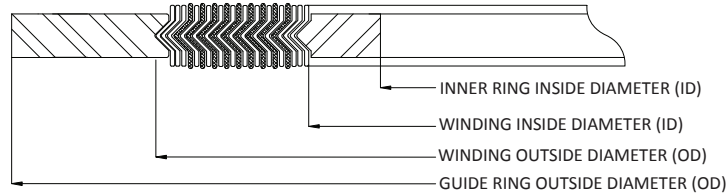

Nominal Pipe Size (NPS)	Class 150							
	Inner Ring Inside Diameter (ID)		Winding Inside Diameter (ID)		Winding Outside Diameter (OD)		Guide Ring Outside Diameter (OD)	
	Inches	mm	Inches	mm	Inches	mm	Inches	mm
1/4	-	-	0.56	14.3	0.88	22.2	1.75	44.5
1/2	0.56	14.3	0.94	23.8	1.25	31.8	1.88	47.6
3/4	0.81	20.6	1.19	30.2	1.56	39.7	2.25	57.2
1	1.06	27.0	1.44	36.5	1.88	47.6	2.63	66.7
1 1/4	1.38	34.9	1.88	47.6	2.38	60.3	3.00	76.2
1 1/2	1.63	41.3	2.13	54.0	2.75	69.9	3.38	85.7

Nominal Pipe Size (NPS)	Class 300							
	Inner Ring Inside Diameter (ID)		Winding Inside Diameter (ID)		Winding Outside Diameter (OD)		Guide Ring Outside Diameter (OD)	
	Inches	mm	Inches	mm	Inches	mm	Inches	mm
1/4	-	-	0.56	14.3	0.88	22.2	1.75	44.5
1/2	0.56	14.3	0.94	23.8	1.25	31.8	2.13	54.0
3/4	0.81	20.6	1.19	30.2	1.56	39.7	2.63	66.7
1	1.06	27.0	1.44	36.5	1.88	47.6	2.88	73.0
1 1/4	1.38	34.9	1.88	47.6	2.38	60.3	3.25	82.6
1 1/2	1.63	41.3	2.13	54.0	2.75	69.9	3.75	95.3

Nominal Pipe Size (NPS)	Class 400							
	Inner Ring Inside Diameter (ID)		Winding Inside Diameter (ID)		Winding Outside Diameter (OD)		Guide Ring Outside Diameter (OD)	
	Inches	mm	Inches	mm	Inches	mm	Inches	mm
1/4	-	-	0.56	14.3	0.88	22.2	1.75	44.5
1/2	0.56	14.3	0.94	23.8	1.25	31.8	2.13	54.0
3/4	0.81	20.6	1.19	30.2	1.56	39.7	2.63	66.7
1	1.06	27.0	1.44	36.5	1.88	47.6	2.88	73.0
1 1/4	1.38	34.9	1.88	47.6	2.38	60.3	3.25	82.6
1 1/2	1.63	41.3	2.13	54.0	2.75	69.9	3.75	95.3

Nominal Pipe Size (NPS)	Class 600							
	Inner Ring Inside Diameter (ID)		Winding Inside Diameter (ID)		Winding Outside Diameter (OD)		Guide Ring Outside Diameter (OD)	
	Inches	mm	Inches	mm	Inches	mm	Inches	mm
1/4	-	-	0.56	14.3	0.88	22.2	1.75	44.5
1/2	0.56	14.3	0.94	23.8	1.25	31.8	2.13	54.0
3/4	0.81	20.6	1.19	30.2	1.56	39.7	2.63	66.7
1	1.06	27.0	1.44	36.5	1.88	47.6	2.88	73.0
1 1/4	1.38	34.9	1.88	47.6	2.38	60.3	3.25	82.6
1 1/2	1.63	41.3	2.13	54.0	2.75	69.9	3.75	95.3

DIMENSIONS FOR STYLE WR/WRI TO SUIT
ASME/ANSI B16.5 AND SLIP-ON FLANGES

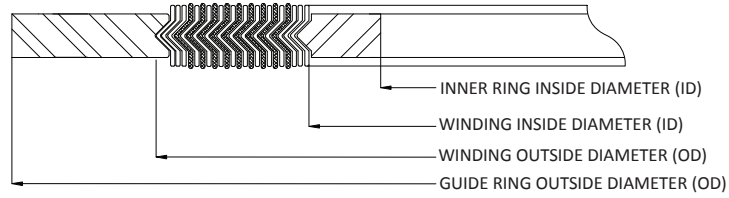

Nominal Pipe Size (NPS)	Class 900							
	Inner Ring Inside Diameter (ID)		Winding Inside Diameter (ID)		Winding Outside Diameter (OD)		Guide Ring Outside Diameter (OD)	
	Inches	mm	Inches	mm	Inches	mm	Inches	mm
1/2	0.56	14.3	0.94	23.8	1.25	31.8	2.50	63.5
3/4	0.81	20.6	1.19	30.2	1.56	39.7	2.75	69.9
1	1.06	27.0	1.44	36.5	1.88	47.6	3.13	79.4
1 1/4	1.38	34.9	1.88	47.6	2.38	60.3	3.50	88.9
1 1/2	1.63	41.3	2.13	54.0	2.75	69.9	3.88	98.4

Nominal Pipe Size (NPS)	Class 1500							
	Inner Ring Inside Diameter (ID)		Winding Inside Diameter (ID)		Winding Outside Diameter (OD)		Guide Ring Outside Diameter (OD)	
	Inches	mm	Inches	mm	Inches	mm	Inches	mm
1/2	0.56	14.3	0.94	23.8	1.25	31.8	2.50	63.5
3/4	0.81	20.6	1.19	30.2	1.56	39.7	2.75	69.9
1	1.06	27.0	1.44	36.5	1.88	47.6	3.13	79.4
1 1/4	1.38	34.9	1.88	47.6	2.38	60.3	3.50	88.9
1 1/2	1.63	41.3	2.13	54.0	2.75	69.9	3.88	98.4

Standard spiral wound gasket dimensions are not compatible with slip-on flanges, threaded flange, or lap joint flanges in certain sizes due to the larger bore on slip-on flanges.

DIMENSIONS FOR STYLE WR/WRI TO SUIT TYPE A AND B
FLANGE FACINGS PER EN 1514-2 (INCHES)

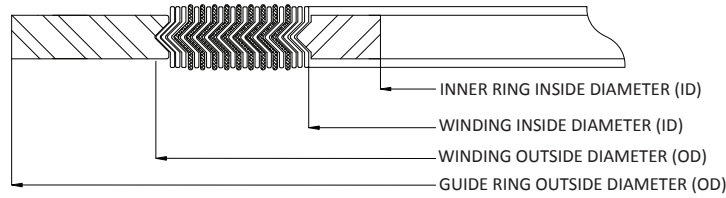

DN	Inner ring Inside Diameter (ID)	Winding Inside Diameter (ID)	Winding Outside Diameter (OD)	Winding Outside Diameter (OD)	Guide Ring Outside Diameter (OD)					
					PN10, PN25, PN40	PN63, PN100, PN160	PN10	PN25	PN40	PN63
mm	Inches	Inches	Inches	Inches	Inches					
10	0.709	0.945	1.339	1.339	1.811			2.205		
15	0.906	1.142	1.535	1.535	2.008			2.402		
20	1.102	1.339	1.811	-	2.402			-		
25	1.378	1.614	2.087	2.087	2.795			3.228		
32	1.693	1.929	2.402	-	3.228			-		
40	1.969	2.205	2.677	2.677	3.622			4.055		
50	2.402	2.756	3.386	3.386	4.213			4.449	4.685	
65	3.031	3.386	4.016	4.173	5.000			5.394	5.630	
80	3.543	3.898	4.528	4.685	5.591			5.827	6.063	
100	4.528	5.000	5.630	5.787	6.378	6.614		6.850	7.087	
125	5.512	5.984	6.772	6.929	7.559	7.638		8.268	8.543	
150	6.575	7.047	7.835	7.992	8.543	8.819		9.724	10.118	
200	8.504	8.976	9.764	9.921	10.709	11.181	11.417	12.165	12.756	
250	10.512	10.984	11.929	12.087	12.874	13.386	13.858	14.331	15.394	15.276
300	12.520	12.992	13.937	14.094	14.842	15.748	16.417	16.693	18.031	18.031
350	14.173	14.803	15.748	15.905	17.205	17.992	18.661	19.134	20.157	-
400	16.142	16.614	17.717	17.953	19.213	20.236	21.496	21.378	22.520	-
500	20.079	20.551	21.654	21.890	23.346	24.567	24.724	25.866	27.716	-
600	24.016	24.488	25.591	25.827	27.362	28.779	29.409	30.079	32.008	-
700	27.953	28.425	29.764	30.000	31.890	32.795	33.543	34.606	37.402	-
800	31.890	32.677	34.016	34.252	36.102	37.087	38.346	38.898	-	-
900	35.827	36.614	37.953	38.189	40.039	41.024	42.677	43.622	-	-
1000	39.764	40.551	42.283	42.520	44.252	45.433	47.008	-	-	-

DIMENSIONS FOR STYLE WR/WRI TO SUIT TYPE A AND B
FLANGE FACINGS PER EN 1514-2 (MILLIMETERS)

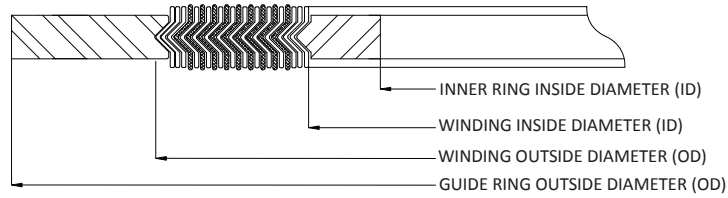

DN	Inner ring Inside Diameter (ID)	Winding Inside Diameter (ID)	Winding Outside Diameter (OD)	Winding Outside Diameter (OD)	Guide Ring Outside Diameter (OD)					
			PN10, PN25, PN40	PN63, PN100, PN160	PN10	PN25	PN40	PN63	PN100	PN160
mm	mm	mm	mm	mm	mm					
10	18	24	34	34	46			56		
15	23	29	39	39	51			61		
20	28	34	46	-	61			-		
25	35	41	53	53	71			82		
32	43	49	61	-	82			-		
40	50	56	68	68	92			103		
50	61	70	86	86	107		113	119		
65	77	86	102	106	127		137	143		
80	90	99	115	119	142		148	154		
100	115	127	143	147	162	168		174	180	
125	140	152	172	176	192	194		210	217	
150	167	179	199	203	217	224		247	257	
200	216	228	248	252	272	284	290	309	324	
250	267	279	303	307	327	340	352	364	391	388
300	318	330	354	358	377	400	417	424	458	458
350	360	376	400	404	437	457	474	486	512	-
400	410	422	450	456	488	514	546	543	572	-
500	510	522	550	556	593	624	628	657	704	-
600	610	622	650	656	695	731	747	764	813	-
700	710	722	756	762	810	833	852	879	950	-
800	810	830	864	870	917	942	974	988	-	-
900	910	930	964	970	1017	1042	1084	1108	-	-
1000	1010	1030	1074	1080	1124	1154	1194	-	-	-

DIMENSIONS FOR STYLE WR TO SUIT BRITISH STANDARD BS 10
WELDED NECK & SLIP-ON FLANGES TABLE D AND E (MILLIMETERS)

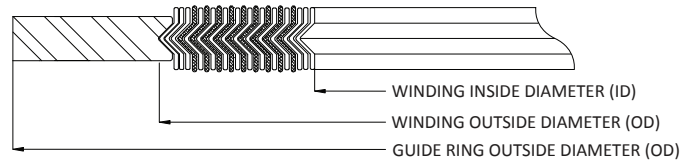

Nominal Pipe Size (NPS)	Winding Inside Diameter (ID)	Winding Outside Diameter (OD)	Guide Ring Outside Diameter (OD)	
			TABLE D	TABLE E
1/2	26.2	37.3	54.0	54.0
3/4	31.8	42.9	60.3	60.3
1	39.7	52.4	69.9	69.9
1 1/4	47.6	60.3	74.6	74.6
1 1/2	54.0	66.7	85.8	85.8
2	66.7	79.4	98.5	98.5
2 1/2	82.6	98.5	111.2	111.2
3	96.9	112.8	130.2	130.2
3 1/2	109.6	125.5	149.3	149.3
4	123.9	139.7	161.9	161.9
4 1/2	136.6	152.4	174.6	174.6
5	149.2	165.1	193.6	193.6
6	174.6	190.5	219.0	215.9
7	200.0	219.0	244.5	241.3
8	225.4	244.5	276.2	273.0
9	250.8	269.9	308.0	304.8
10	276.3	295.3	336.6	336.6
11	301.6	320.7	362.0	362.0
12	327.0	349.3	387.4	384.2
13	368.3	390.6	419.1	415.9
14	393.7	416.0	447.7	447.7
15	419.1	441.3	473.0	473.0
16	444.5	466.7	498.5	498.5
17	473.0	498.5	530.3	527.0
18	498.5	523.9	562.0	562.0
19	523.9	549.3	587.4	587.4
20	549.3	574.7	619.2	619.2
21	574.7	603.3	651.0	647.7
22	600.0	628.7	673.1	673.1
23	625.5	654.0	698.5	698.5
24	650.9	679.5	730.3	728.7

DIMENSIONS FOR STYLE WR TO SUIT BRITISH STANDARD BS 10 WELDED
NECK & SLIP-ON FLANGES TABLE F, H, J, K, & R (MILLIMETERS)

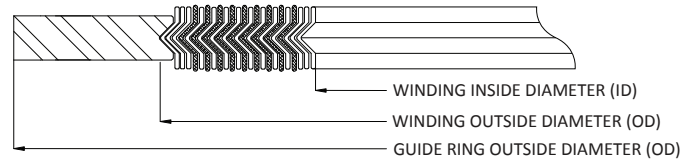

Nominal Pipe Size (NPS)	Winding Inside Diameter (ID)	Winding Outside Diameter (OD)	Guide Ring Outside Diameter (OD)				
			TABLE F	TABLE H	TABLE J	TABLE K	TABLE R
1/2	26.2	38.9	54.0	66.7	66.7	66.7	66.7
3/4	31.8	44.5	60.3	66.7	66.7	66.7	66.7
1	39.7	55.6	71.5	71.5	71.5	79.4	79.4
1 1/4	47.6	63.5	82.6	82.6	82.6	82.6	82.6
1 1/2	54.0	69.9	88.9	88.9	88.9	95.3	95.3
2	66.7	82.6	111.2	111.2	108.0	111.2	111.2
2 1/2	82.6	101.6	130.2	130.2	127.0	127.0	127.0
3	96.9	115.9	149.3	149.3	146.0	146.0	146.0
3 1/2	109.6	128.6	162.0	162.0	158.9	162.0	162.0
4	123.9	142.9	174.7	174.7	171.5	174.7	174.7
4 1/2	136.6	158.9	190.5	190.5	187.4	187.4	187.4
5	149.2	171.5	215.9	215.9	212.8	212.8	212.8
6	174.6	196.9	241.3	241.3	238.2	238.2	238.2
7	200.0	225.4	273.0	273.0	269.9	266.7	266.7
8	225.4	250.9	304.8	304.8	301.7	292.1	298.5
9	250.8	276.3	333.4	333.4	330.2	330.2	330.2
10	279.4	304.8	358.8	358.8	355.6	355.6	362.0
11	304.8	330.2	384.2	384.2	381.0	384.2	403.3
12	330.2	358.7	416.0	416.0	412.8	403.3	428.7
13	362.0	390.6	444.5	444.5	441.4	451.0	463.6
14	387.4	415.9	470.0	470.0	466.8	476.3	495.3
15	412.8	441.4	495.3	495.3	492.2	508.0	520.7
16	444.5	476.3	527.0	527.0	523.9	533.4	552.5
17	469.9	504.9	558.8	558.8	555.7	565.2	577.9
18	495.3	530.3	581.0	581.0	577.9	619.2	638.2
19	523.9	562.0	612.3	612.3	609.6	-	-
20	549.3	587.4	644.6	644.6	641.4	673.1	692.2
21	574.7	619.2	670.0	670.0	666.8	-	-
22	600.0	644.5	695.4	695.4	692.2	730.3	755.7
23	625.5	670.0	723.9	723.9	720.8	-	-
24	651.0	695.4	749.3	749.3	746.1	-	-

**DIMENSIONS FOR STYLE WR TO SUIT BRITISH STANDARD BS 10
WELDED NECK & SLIP-ON FLANGES TABLE S (MILLIMETERS)**

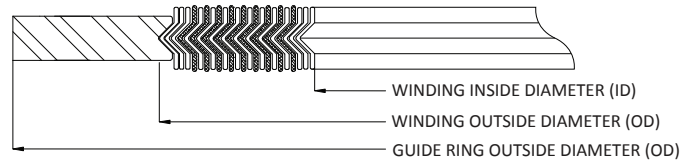

Nominal Pipe Size (NPS)	BS 10: 1931		BS 10: 1962		Guide Ring Outside Diameter (OD)
	Winding Inside Diameter (ID)	Winding Outside Diameter (OD)	Winding Inside Diameter (ID)	Winding Outside Diameter (OD)	
1/2	19.1	31.8	19.1	31.8	69.9
3/4	25.4	39.7	25.4	39.7	69.9
1	31.8	47.6	31.8	47.6	82.6
1 1/4	38.1	55.6	38.1	55.6	88.9
1 1/2	44.5	63.5	44.5	63.5	101.6
2	57.2	76.2	57.2	79.4	114.3
2 1/2	69.9	88.9	73.0	95.3	127.0
3	82.6	101.6	85.7	108.0	142.9
3 1/2	95.3	114.3	98.4	120.7	168.3
4	108.0	127.0	111.1	136.5	177.8
4 1/2	120.7	139.7	123.8	149.2	190.5
5	133.4	152.4	136.5	161.9	212.7
6	158.8	177.8	161.9	187.3	247.7
7	187.3	209.6	187.3	219.1	288.9
8	212.7	235.0	212.7	244.5	323.9
9	238.1	260.4	241.3	273.1	358.8
10	263.5	285.8	266.7	301.6	393.7
11 (12) 3/4 O/D Pipe	288.9	317.5	292.1	327.0	435.0
12 (14) 3/4 O/D Pipe	314.3	346.1	320.7	355.6	469.9
13 (15) 3/4 O/D Pipe	339.7	371.5	346.1	384.2	501.7
14 (16) 3/4 O/D Pipe	365.1	400.1	371.5	409.6	539.8
15 (17) 3/4 O/D Pipe	390.5	428.6	400.1	438.2	581.0
16 (18) 3/4 O/D Pipe	415.9	454.0	425.5	466.7	616.0

DIMENSIONS FOR STYLE WR/WRI PER BRITISH BS 3381 TO SUIT
BS 1560 AND ASME/ANSI B16.5 FLANGES (MILLIMETERS)

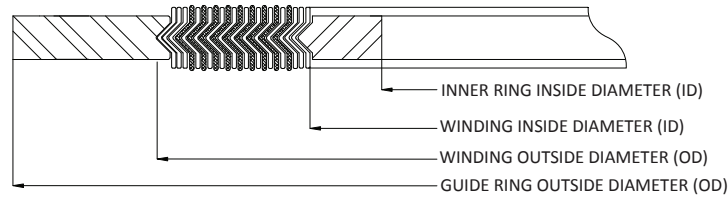

Nominal Pipe Size (NPS)	Class 150			
	Inner Ring Inside Diameter (ID)	Winding Inside Diameter (ID)	Winding Outside Diameter (OD)	Guide Ring Outside Diameter (OD)
1/2	14.3	18.7	32.2	47.6
3/4	20.6	26.6	40.1	57.2
1	27.0	32.9	48.0	66.7
1 1/4	34.9	45.6	60.7	76.2
1 1/2	41.3	53.6	70.3	85.7
2	52.4	69.5	86.1	104.8
2 1/2	63.5	82.2	98.8	123.8
3	77.8	101.2	121.1	136.5
4	103.2	126.6	149.6	174.6
5	128.5	153.6	178.2	196.9
6	154.0	180.6	210.0	222.3
8	203.2	231.4	263.9	279.4
10	254.0	286.9	317.9	339.7
12	303.2	339.3	375.1	409.6
14	342.9	371.1	406.8	450.9
16	393.7	421.9	464.0	514.4
18	444.5	475.9	527.5	549.3
20	495.3	526.7	578.3	606.4
24	596.9	631.4	686.2	717.6

Nominal Pipe Size (NPS)	Class 300			
	Inner Ring Inside Diameter (ID)	Winding Inside Diameter (ID)	Winding Outside Diameter (OD)	Guide Ring Outside Diameter (OD)
1/2	14.3	18.7	32.2	54.0
3/4	20.6	25.0	40.1	66.7
1	27.0	31.4	48.0	73.0
1 1/4	34.9	44.1	60.7	82.6
1 1/2	41.3	50.4	70.3	95.3
2	52.4	66.3	86.1	111.1
2 1/2	63.5	79.0	98.8	130.2
3	77.8	94.9	121.1	149.2
4	103.2	120.3	149.6	181.0
5	128.5	147.2	178.2	215.9
6	154.0	174.2	210.0	250.8
8	203.2	225.0	263.9	308.0
10	254.0	280.6	317.9	362.0
12	303.2	333.0	375.1	422.3
14	342.9	364.7	406.8	485.8
16	393.7	415.5	464.0	539.8
18	444.5	469.5	527.5	596.9
20	495.3	520.3	578.3	654.1
24	596.9	625.1	686.2	774.7

DIMENSIONS FOR STYLE WR/WRI PER BRITISH BS 3381 TO SUIT
BS 1560 AND ASME/ANSI B 16.5 FLANGES (MILLIMETERS)

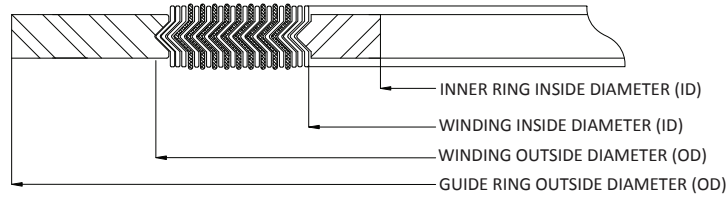

Nominal Pipe Size (NPS)	Class 600			
	Inner Ring Inside Diameter (ID)	Winding Inside Diameter (ID)	Winding Outside Diameter (OD)	Guide Ring Outside Diameter (OD)
1/2	14.3	18.7	32.2	54.0
3/4	20.6	25.0	40.1	66.7
1	27.0	31.4	48.0	73.0
1 1/4	34.9	44.1	60.7	82.6
1 1/2	41.3	50.4	70.3	95.3
2	52.4	66.3	86.1	111.1
2 1/2	63.5	79.0	98.8	130.2
3	77.8	94.9	121.1	149.2
4	103.2	120.3	149.6	193.7
5	128.5	147.2	178.2	241.3
6	154.0	174.2	210.0	266.7
8	203.2	225.0	263.9	320.7
10	254.0	280.6	317.9	400.1
12	303.2	333.0	375.1	457.2
14	342.9	364.7	406.8	492.1
16	393.7	415.5	464.0	565.2
18	444.5	469.5	527.5	612.8
20	495.3	520.3	578.3	682.6
24	596.9	625.1	686.2	790.6

Nominal Pipe Size (NPS)	Class 900			
	Inner Ring Inside Diameter (ID)	Winding Inside Diameter (ID)	Winding Outside Diameter (OD)	Guide Ring Outside Diameter (OD)
1/2	14.3	18.7	32.2	63.5
3/4	20.6	25.0	40.1	69.9
1	27.0	31.4	48.0	79.4
1 1/4	34.9	44.1	60.7	88.9
1 1/2	41.3	50.4	70.3	98.4
2	52.4	66.3	86.1	142.9
2 1/2	63.5	79.0	98.8	165.1
3	77.8	94.9	121.1	168.3
4	103.2	120.3	149.6	206.4
5	128.5	147.2	178.2	247.7
6	154.0	174.2	210.0	288.9
8	203.2	225.0	263.9	358.8
10	254.0	280.6	317.9	435.0
12	303.2	333.0	375.1	498.5
14	342.9	364.7	406.8	520.7
16	393.7	415.5	464.0	574.7
18	444.5	469.5	527.5	638.2
20	495.3	520.3	578.3	698.5
24	596.9	625.1	686.2	838.2

DIMENSIONS FOR STYLE WR/WRI PER BRITISH BS 3381 TO SUIT
BS 1560 AND ASME/ANSI B16.5 FLANGES (MILLIMETERS)

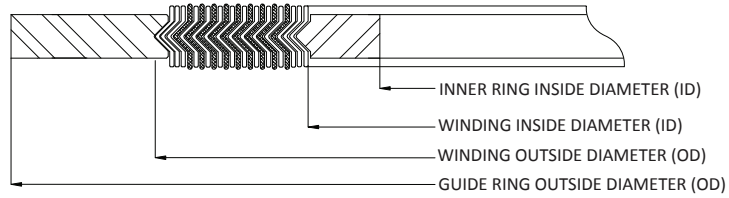

Nominal Pipe Size (NPS)	Class 1500			
	Inner Ring Inside Diameter (ID)	Winding Inside Diameter (ID)	Winding Outside Diameter (OD)	Guide Ring Outside Diameter (OD)
1/2	14.3	18.7	32.2	63.5
3/4	20.6	25.0	40.1	69.9
1	27.0	31.4	48.0	79.4
1 1/4	34.9	44.1	60.7	88.9
1 1/2	41.3	50.4	70.3	98.4
2	52.4	66.3	86.1	142.9
2 1/2	63.5	79.0	98.8	165.1
3	77.8	94.9	121.1	174.6
4	103.2	120.3	149.6	209.6
5	128.5	147.2	178.2	254.0
6	154.0	174.2	210.0	282.6
8	203.2	225.0	263.9	352.4
10	254.0	280.6	317.9	435.0
12	303.2	333.0	375.1	520.7
14	342.9	364.7	406.8	577.9
16	393.7	415.5	464.0	641.4
18	444.5	469.5	527.5	704.9
20	495.3	520.3	578.3	755.7
24	596.9	625.1	686.2	901.7

Nominal Pipe Size (NPS)	Class 2500			
	Inner Ring Inside Diameter (ID)	Winding Inside Diameter (ID)	Winding Outside Diameter (OD)	Guide Ring Outside Diameter (OD)
1/2	14.3	18.7	32.2	69.9
3/4	20.6	25.0	40.1	76.2
1	27.0	31.4	48.0	85.7
1 1/4	34.9	39.3	60.7	104.8
1 1/2	41.3	47.2	70.3	117.5
2	52.4	58.3	86.1	146.1
2 1/2	63.5	69.5	98.8	168.3
3	77.8	91.7	121.1	196.9
4	103.2	117.1	149.6	235.0
5	128.5	142.5	178.2	279.4
6	154.0	171.1	210.0	317.5
8	203.2	215.5	263.9	387.4
10	254.0	269.5	317.9	476.3
12	303.2	323.5	375.1	549.6

DIMENSIONS FOR STYLE WR TO SUIT FRENCH STANDARD NF-M-8762 1
(MILLIMETERS)

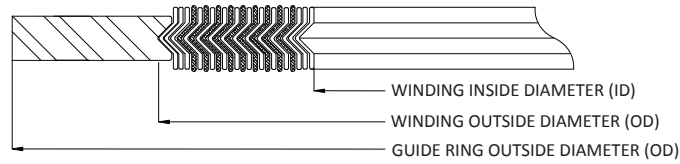

Nominal Pipe Size (NPS)	Class 150			Class 300			Class 600		
	Winding Inside Diameter (ID)	Winding Outside Diameter (OD)	Guide Ring Outside Diameter (OD)	Winding Inside Diameter (ID)	Winding Outside Diameter (OD)	Guide Ring Outside Diameter (OD)	Winding Inside Diameter (ID)	Winding Outside Diameter (OD)	Guide Ring Outside Diameter (OD)
1/2	19	29	47	19	29	54	19	29	54
3/4	25	37	57	25	37	66	25	37	66
1	32	44	66	32	44	73	32	44	73
1 1/4	48	57	76	48	57	82	48	57	82
1 1/2	54	67	85	54	67	95	54	67	95
2	70	82	104	70	82	111	70	82	111
2 1/2	83	95	124		95	130	83	95	130
3	102	117	136	102	117	149	102	117	149
4	127	146	174	127	146	181	120	146	193
5	156	176	197	156	176	216	148	176	241
6	183	206	222	183	206	251	175	206	266
8	233	260	279	233	260	308	225	260	320
10	287	314	339	287	314	362	275	314	400
12	340	371	409	340	371	422	327	371	457
14	372	403	451	372	403	485	362	403	492
16	422	460	514	422	460	539	413	460	565
18	475	524	549	475	524	597	470	524	612
20	525	575	606	525	575	654	521	575	682
24	629	682	717	629	682	774	629	682	790

Nominal Pipe Size (NPS)	Class 900			Class 1500			Class 2500		
	Winding Inside Diameter (ID)	Winding Outside Diameter (OD)	Guide Ring Outside Diameter (OD)	Winding Inside Diameter (ID)	Winding Outside Diameter (OD)	Guide Ring Outside Diameter (OD)	Winding Inside Diameter (ID)	Winding Outside Diameter (OD)	Guide Ring Outside Diameter (OD)
1/2	19	29	63	19	29	63	19	29	70
3/4	25	37	70	25	37	70	25	37	76
1	32	44	79	32	44	79	32	44	86
1 1/4	40	57	89	40	57	89	40	57	105
1 1/2	48	67	98	48	67	98	48	67	117
2	59	82	143	59	82	143	59	82	146
2 1/2	70	95	165	70	95	165	70	95	168
3	95	117	168	92	117	174	92	117	197
4	120	146	206	118	146	209	118	146	235
5	148	176	247	143	176	254	143	176	279
6	175	206	289	171	206	282	171	206	317
8	225	260	359	216	260	352	216	260	387
10	275	314	435	270	314	435	270	314	476
12	327	371	498	324	371	520	324	371	549
14	362	403	520	362	403	578	-	-	-
16	413	460	574	413	460	641	-	-	-
18	464	524	638	454	524	705	-	-	-
20	514	575	698	514	575	756	-	-	-
24	616	682	838	516	682	901	-	-	-

DIMENSIONS FOR STYLE WR TO SUIT JAPANESE (JIS) FLANGES

PRESSURE RATING 10 KGF/CM²

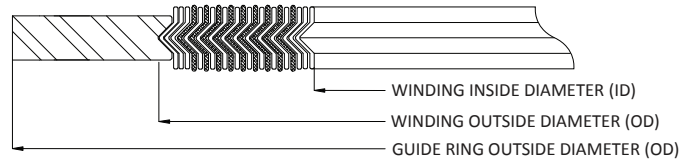

DN	Winding Inside Diameter (ID)		Winding Outside Diameter (OD)		Guide Ring Outside Diameter (OD)	
	Inches	mm	Inches	mm	Inches	mm
10	0.945	24	1.457	37	2.047	52
15	1.102	28	1.614	41	2.244	57
20	1.339	34	1.850	47	2.441	62
25	1.575	40	2.087	53	2.913	74
32	2.008	51	2.638	67	3.307	84
40	2.244	57	2.874	73	3.504	89
50	2.717	69	3.504	89	4.094	104
65	3.425	87	4.213	107	4.882	124
80	3.858	98	4.646	118	5.276	134
90	4.331	110	5.118	130	5.669	144
100	4.843	123	5.630	143	6.260	159
125	5.827	148	6.811	173	7.480	190
150	6.850	174	7.835	199	8.661	220
175	7.913	201	8.898	226	9.646	245
200	8.937	227	9.921	252	10.629	270
225	9.921	252	10.906	277	11.417	290
250	10.945	278	12.205	310	13.071	332
300	12.953	329	14.213	361	14.843	377
350	14.409	366	15.984	406	16.614	422
400	16.417	417	17.992	457	19.055	484
450	18.425	468	20.394	518	21.220	539
500	20.394	518	22.362	568	23.386	594
550	22.402	569	24.370	619	25.591	650
600	24.409	620	26.378	670	27.559	700

DIMENSIONS FOR STYLE WR TO SUIT JAPANESE (JIS) FLANGES

PRESSURE RATING 16-20 KGF/CM²

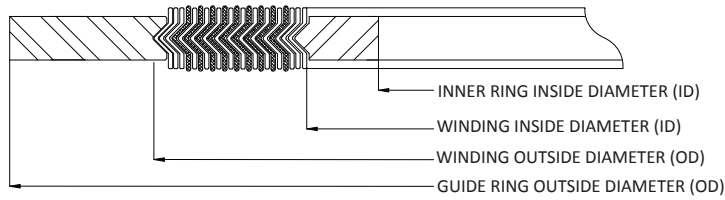

DN	Inner Ring Inside Diameter (ID)		Winding Inside Diameter (ID)		Winding Outside Diameter (OD)		Guide Ring Outside Diameter (OD)	
	Inches	mm	Inches	mm	Inches	mm	Inches	mm
10	0.709	18	0.945	24	1.457	37	2.047	52
15	0.866	22	1.102	28	1.614	41	2.244	57
20	1.102	28	1.339	34	1.850	47	2.441	62
25	1.339	34	1.575	40	2.087	53	2.913	74
32	1.693	43	2.008	51	2.638	67	3.307	84
40	1.929	49	2.244	57	2.874	73	3.504	89
50	2.402	61	2.717	69	3.504	89	4.094	104
65	3.031	77	3.425	87	4.213	107	4.882	124
80	3.504	89	3.898	99	4.685	119	5.512	140
90	4.016	102	4.488	114	5.472	139	5.906	150
100	4.528	115	5.000	127	5.984	152	6.496	165
125	5.512	140	5.984	152	6.969	177	7.953	202
150	6.535	166	7.165	182	8.425	214	9.331	237
175	-	-	-	-	-	-	-	-
200	8.543	217	9.173	233	10.433	265	11.102	282
225	-	-	-	-	-	-	-	-
250	10.551	268	11.339	288	12.913	328	13.937	354
300	12.559	319	13.346	339	14.921	379	15.906	404
350	14.016	356	14.803	376	16.378	416	17.717	450
400	16.024	407	17.008	432	18.976	482	20.000	508
450	18.031	458	19.016	483	20.984	533	22.559	573
500	20.000	508	20.984	533	22.953	583	24.724	628
550	22.008	559	22.992	584	24.961	634	26.929	684
600	24.016	610	25.000	635	26.969	685	28.898	734

DIMENSIONS FOR STYLE WR TO SUIT JAPANESE (JIS) FLANGES

PRESSURE RATING 30 KGF/CM²

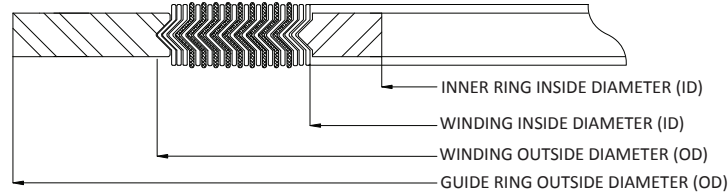

DN	Inner Ring Inside Diameter (ID)		Winding Inside Diameter (ID)		Winding Outside Diameter (OD)		Guide Ring Outside Diameter (OD)	
	Inches	mm	Inches	mm	Inches	mm	Inches	mm
10	0.709	18	0.945	24	1.457	37	2.323	59
15	0.866	22	1.102	28	1.614	41	2.520	64
20	1.102	28	1.339	34	1.850	47	2.717	69
25	1.339	34	1.575	40	2.087	53	3.110	79
32	1.693	43	2.008	51	2.638	67	3.504	89
40	1.929	49	2.244	57	2.874	73	3.937	100
50	2.402	61	2.717	69	3.504	89	4.488	114
65	2.677	68	3.071	78	3.858	98	5.512	140
80	3.150	80	3.543	90	4.331	110	5.906	150
90	3.622	92	4.016	102	5.000	127	6.378	162
100	4.094	104	4.567	116	5.551	141	6.772	172
125	5.039	128	5.512	140	6.496	165	8.150	207
150	6.024	153	6.496	165	7.756	197	9.803	249
200	7.953	202	8.583	218	9.843	250	11.575	294
250	9.882	251	10.669	271	12.244	311	14.173	360
300	11.811	300	12.598	320	14.173	360	16.457	418
350	13.228	336	14.016	356	15.591	396	18.228	463
400	15.079	383	15.866	403	17.835	453	20.630	524

DIMENSIONS FOR STYLE WR TO SUIT JAPANESE (JIS) FLANGES

PRESSURE RATING 40 KGF/CM²

DN	Inner Ring Inside Diameter (ID)		Winding Inside Diameter (ID)		Winding Outside Diameter (OD)		Guide Ring Outside Diameter (OD)	
	Inches	mm	Inches	mm	Inches	mm	Inches	mm
10	0.591	15	0.827	21	1.339	34	2.323	59
15	0.709	18	0.945	24	1.457	37	2.520	64
20	0.906	23	1.142	29	1.654	42	2.717	69
25	1.142	29	1.378	35	1.890	48	3.110	79
32	1.496	38	1.732	44	2.362	60	3.504	89
40	1.693	43	2.008	51	2.638	67	3.937	100
50	2.165	55	2.480	63	3.110	79	4.488	114
65	2.677	68	3.071	78	3.858	98	5.512	140
80	3.150	80	3.543	90	4.331	110	5.906	150
90	3.622	92	4.016	102	5.000	127	6.378	162
100	4.094	104	4.567	116	5.551	141	7.165	182
125	5.039	128	5.512	140	6.496	165	8.819	224
150	6.024	153	6.496	165	7.756	197	10.433	265
200	7.953	202	8.583	218	9.843	250	12.402	315
250	9.882	251	10.669	271	12.244	311	14.882	378
300	11.811	300	12.598	320	14.173	360	17.087	434
350	13.228	336	14.016	356	15.591	396	18.858	479
400	15.079	383	15.866	403	17.835	453	20.906	531

DIMENSIONS FOR STYLE WR TO SUIT JAPANESE (JIS) FLANGES
PRESSURE RATING 63 KGF/CM²

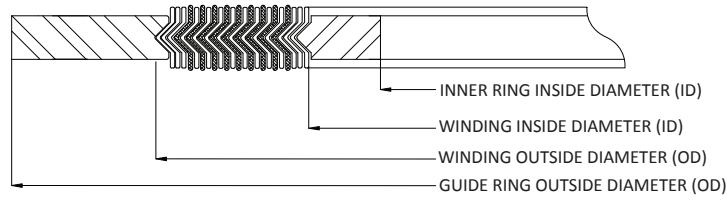

DN	Inner Ring Inside Diameter (ID)		Winding Inside Diameter (ID)		Winding Outside Diameter (OD)		Guide Ring Outside Diameter (OD)	
	Inches	mm	Inches	mm	Inches	mm	Inches	mm
10	0.591	15	0.827	21	1.339	34	2.520	64
15	0.709	18	0.945	24	1.457	37	2.717	69
20	0.906	23	1.142	29	1.654	42	2.953	75
25	1.142	29	1.378	35	1.890	48	3.150	80
32	1.496	38	1.732	44	2.362	60	3.543	90
40	1.693	43	2.008	51	2.638	67	4.213	107
50	2.165	55	2.480	63	3.110	79	4.921	125
65	2.677	68	3.071	78	3.858	98	5.984	152
80	3.150	80	3.543	90	4.331	110	6.378	162
90	3.622	92	4.016	102	5.000	127	7.047	179
100	4.094	104	4.567	116	5.551	141	7.638	194
125	5.039	128	5.512	140	6.496	165	9.252	235
150	6.024	153	6.496	165	7.756	197	10.827	275
200	7.953	202	8.583	218	9.843	250	12.913	328
250	9.882	251	10.669	271	12.244	311	15.512	394
300	11.811	300	12.598	320	14.173	360	17.559	446
350	13.228	336	14.016	356	15.591	396	19.213	488
400	15.079	383	15.866	403	17.835	453	21.457	545

**DIMENSIONS FOR STYLE WR-RJ/WRI-RJ TO SUIT
RAISED FACE TO RTJ FLANGES**

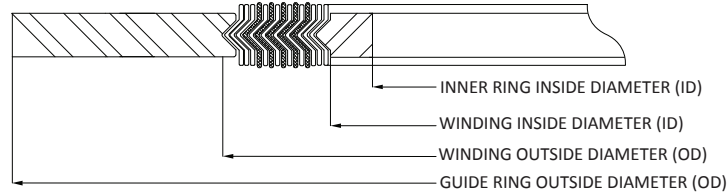

Nominal Pipe Size (NPS)	Class 150							
	Inner Ring Inside Diameter (ID)		Winding Inside Diameter (ID)		Winding Outside Diameter (OD)		Guide Ring Outside Diameter (OD)	
	Inches	mm	Inches	mm	Inches	mm	Inches	mm
1	Contact Lamons Engineering for Sizes							
1 1/4	Inside Diameter of inner ring will depend on bore schedule. Please consult with Lamons Engineering for proper sizing		1.38	34.9	1.81	46.0	3.00	76.2
1 1/2			1.63	41.3	2.13	54.0	3.38	85.7
2			2.13	54.0	2.75	69.9	4.13	104.8
2 1/2			2.75	69.9	3.31	84.1	4.88	123.8
3			3.31	84.1	3.94	100.0	5.38	136.5
4			4.31	109.5	5.19	131.8	6.88	174.6
5			5.31	134.9	6.19	157.2	7.75	196.9
6			6.31	160.3	7.19	182.6	8.75	222.3
8			8.25	209.6	9.19	233.4	11.00	279.4
10			10.31	261.9	11.44	290.5	13.38	339.7
12			12.19	309.6	13.56	344.5	16.13	409.6
14			13.44	341.3	14.94	379.4	17.75	450.9
16			15.31	388.9	16.94	430.2	20.25	514.4
18			17.25	438.2	19.00	482.6	21.63	549.3
20		19.13	485.8	21.13	536.6	23.88	606.4	
24		23.00	584.2	25.25	641.4	28.25	717.6	

Nominal Pipe Size (NPS)	Class 300							
	Inner Ring Inside Diameter (ID)		Winding Inside Diameter (ID)		Winding Outside Diameter (OD)		Guide Ring Outside Diameter (OD)	
	Inches	mm	Inches	mm	Inches	mm	Inches	mm
1/2	Inside Diameter of inner ring will depend on bore schedule. Please consult with Lamons Engineering for proper sizing		0.56	14.3	0.94	23.8	2.13	54.0
3/4			0.81	20.6	1.25	31.8	2.63	66.7
1			1.06	27.0	1.56	39.7	2.88	73.0
1 1/4			1.31	33.3	1.88	47.6	3.25	82.6
1 1/2			1.56	39.7	2.19	55.6	3.75	95.3
2			2.13	54.0	2.69	68.3	4.38	111.1
2 1/2			2.75	69.9	3.31	84.1	5.13	130.2
3			3.31	84.1	3.94	100.0	5.88	149.2
4			4.31	109.5	5.19	131.8	7.13	181.0
5			5.31	134.9	6.44	163.5	8.50	215.9
6			6.44	163.5	7.63	193.7	9.88	250.8
8			8.25	209.6	9.94	252.4	12.13	308.0
10			10.31	261.9	12.00	304.8	14.25	362.0
12			12.88	327.0	14.25	362.0	16.63	422.3
14			14.25	362.0	15.75	400.1	19.13	485.8
16			16.25	412.8	17.75	450.9	21.25	539.8
18			18.25	463.6	20.25	514.4	23.50	596.9
20			20.25	514.4	22.19	563.6	25.75	654.1
24		24.25	616.0	26.31	668.3	30.50	774.7	

**DIMENSIONS FOR STYLE WR-RJ/WRI-RJ TO SUIT
RAISED FACE TO RT J FLANGES**

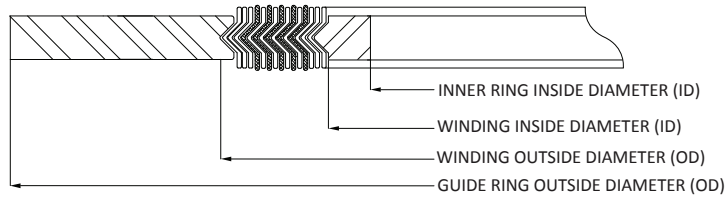

Nominal Pipe Size (NPS)	Class 400							
	Inner Ring Inside Diameter (ID)		Winding Inside Diameter (ID)		Winding Outside Diameter (OD)		Guide Ring Outside Diameter (OD)	
	Inches	mm	Inches	mm	Inches	mm	Inches	mm
1/2	Inside Diameter of inner ring will depend on bore schedule. Please consult with Lamons Engineering for proper sizing		0.56	14.3	0.94	23.8	2.13	54.0
3/4			0.81	20.6	1.25	31.8	2.63	66.7
1			1.06	27.0	1.56	39.7	2.88	73.0
1 1/4			1.31	33.3	1.88	47.6	3.25	82.6
1 1/2			1.56	39.7	2.19	55.6	3.75	95.3
2			2.13	54.0	2.69	68.3	4.38	111.1
2 1/2			2.75	69.9	3.31	84.1	5.13	130.2
3			3.31	84.1	3.94	100.0	5.88	149.2
4			4.31	109.5	5.19	131.8	7.00	177.8
5			5.31	134.9	6.44	163.5	8.38	212.7
6			6.44	163.5	7.63	193.7	9.75	247.7
8			8.25	209.6	9.94	252.4	12.00	304.8
10			10.31	261.9	12.00	304.8	14.13	358.8
12			12.88	327.0	14.25	362.0	16.50	419.1
14			14.25	362.0	15.75	400.1	19.00	482.6
16			16.25	412.8	17.75	450.9	21.13	536.6
18			18.25	463.6	20.25	514.4	23.38	593.7
20			20.25	514.4	22.19	563.6	25.50	647.7
24	24.25	616.0	26.31	668.3	30.25	768.4		

Nominal Pipe Size (NPS)	Class 600							
	Inner Ring Inside Diameter (ID)		Winding Inside Diameter (ID)		Winding Outside Diameter (OD)		Guide Ring Outside Diameter (OD)	
	Inches	mm	Inches	mm	Inches	mm	Inches	mm
1/2	Inside Diameter of inner ring will depend on bore schedule. Please consult with Lamons Engineering for proper sizing		0.56	14.3	0.94	23.8	2.13	54.0
3/4			0.81	20.6	1.25	31.8	2.63	66.7
1			1.06	27.0	1.56	39.7	2.88	73.0
1 1/4			1.31	33.3	1.88	47.6	3.25	82.6
1 1/2			1.56	39.7	2.19	55.6	3.75	95.3
2			2.13	54.0	2.69	68.3	4.38	111.1
2 1/2			2.75	69.9	3.31	84.1	5.13	130.2
3			3.31	84.1	3.94	100.0	5.88	149.2
4			4.31	109.5	5.19	131.8	7.63	193.7
5			5.31	134.9	6.44	163.5	9.50	241.3
6			6.44	163.5	7.63	193.7	10.50	266.7
8			8.25	209.6	9.94	252.4	12.63	320.7
10			10.31	261.9	12.00	304.8	15.75	400.1
12			12.88	327.0	14.25	362.0	18.00	457.2
14			14.25	362.0	15.75	400.1	19.38	492.1
16			16.25	412.8	17.75	450.9	22.25	565.2
18			18.25	463.6	20.25	514.4	24.13	612.8
20			20.25	514.4	22.19	563.6	26.88	682.6
24	24.25	616.0	26.31	668.3	31.13	790.6		

**DIMENSIONS FOR STYLE WR-RJ/WRI-RJ TO SUIT
RAISED FACE TO RT J FLANGES**

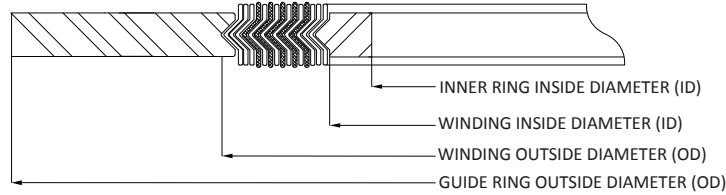

Nominal Pipe Size (NPS)	Class 900							
	Inner Ring Inside Diameter (ID)		Winding Inside Diameter (ID)		Winding Outside Diameter (OD)		Guide Ring Outside Diameter (OD)	
	Inches	mm	Inches	mm	Inches	mm	Inches	mm
1/2	Inside Diameter of inner ring will depend on bore schedule. Please consult with Lamons Engineering for proper sizing		0.56	14.3	1.06	27.0	2.50	63.5
3/4			0.81	20.6	1.31	33.3	2.75	69.9
1			1.06	27.0	1.56	39.7	3.13	79.4
1 1/4			1.31	33.3	1.94	49.2	3.50	88.9
1 1/2			1.56	39.7	2.25	57.2	3.88	98.4
2			2.25	57.2	3.19	81.0	5.63	142.9
2 1/2			2.56	65.1	3.63	92.1	6.50	165.1
3			3.19	81.0	4.19	106.4	6.63	168.3
4			4.06	103.2	5.19	131.8	8.13	206.4
5			5.31	134.9	6.44	163.5	9.75	247.7
6			6.31	160.3	7.63	193.7	11.38	288.9
8			8.25	209.6	9.94	252.4	14.13	358.8
10			10.31	261.9	12.00	304.8	17.13	435.0
12			12.88	327.0	14.25	362.0	19.63	498.5
14			13.81	350.8	15.56	395.3	20.50	520.7
16			15.56	395.3	17.56	446.1	22.63	574.7
18		17.69	449.3	19.94	506.4	25.13	638.2	
20		19.69	500.1	21.94	557.2	27.50	698.5	
24		23.19	589.0	25.94	658.8	33.00	838.2	

Nominal Pipe Size (NPS)	Class 1500							
	Inner Ring Inside Diameter (ID)		Winding Inside Diameter (ID)		Winding Outside Diameter (OD)		Guide Ring Outside Diameter (OD)	
	Inches	mm	Inches	mm	Inches	mm	Inches	mm
1/2	Inside Diameter of inner ring will depend on bore schedule. Please consult with Lamons Engineering for proper sizing		0.56	14.3	1.06	27.0	2.50	63.5
3/4			0.81	20.6	1.31	33.3	2.75	69.9
1			1.06	27.0	1.56	39.7	3.13	79.4
1 1/4			1.31	33.3	1.94	49.2	3.50	88.9
1 1/2			1.56	39.7	2.25	57.2	3.88	98.4
2			2.25	57.2	3.19	81.0	5.63	142.9
2 1/2			2.56	65.1	3.63	92.1	6.50	165.1
3			3.19	81.0	4.69	119.1	6.88	174.6
4			4.06	103.2	5.69	144.5	8.25	209.6
5			5.06	128.6	6.94	176.2	10.00	254.0
6			6.00	152.4	7.56	192.1	11.13	282.6
8			7.88	200.0	9.75	247.7	13.88	352.4
10			9.81	249.2	11.88	301.6	17.13	435.0
12			11.94	303.2	13.94	354.0	20.50	520.7
14			13.44	341.3	15.19	385.8	22.75	577.9
16			15.00	381.0	17.00	431.8	25.25	641.4
18		17.25	438.2	19.50	495.3	27.75	704.9	
20		19.19	487.4	21.44	544.5	29.75	755.7	
24		23.00	584.2	25.50	647.7	35.50	901.7	

GASKET SELECTION

MARKINGS FOR STANDARD SPIRAL WOUND GASKETS

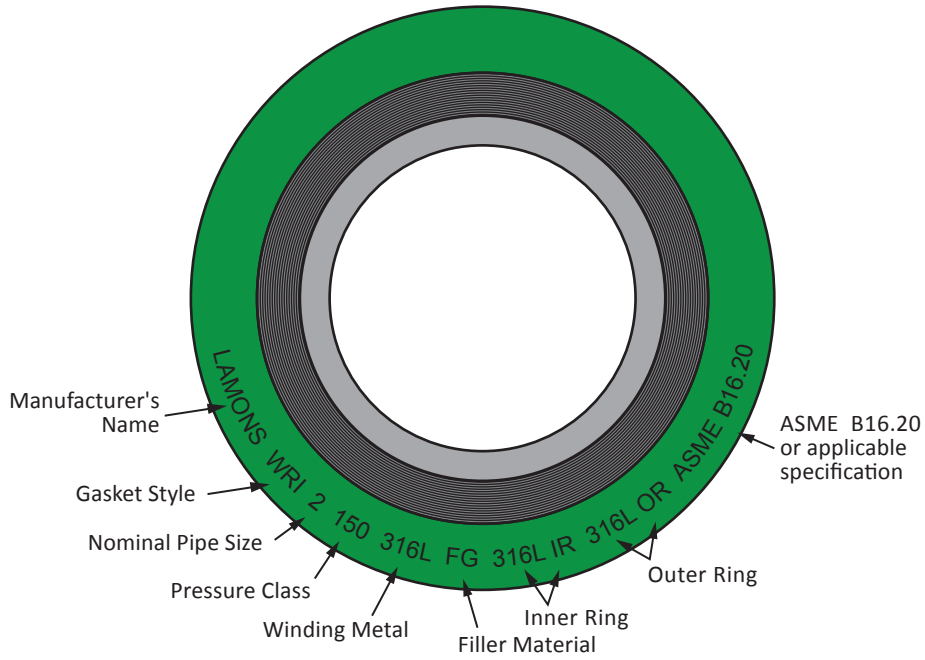

MARKINGS FOR STANDARD KAMMPRO® GASKETS

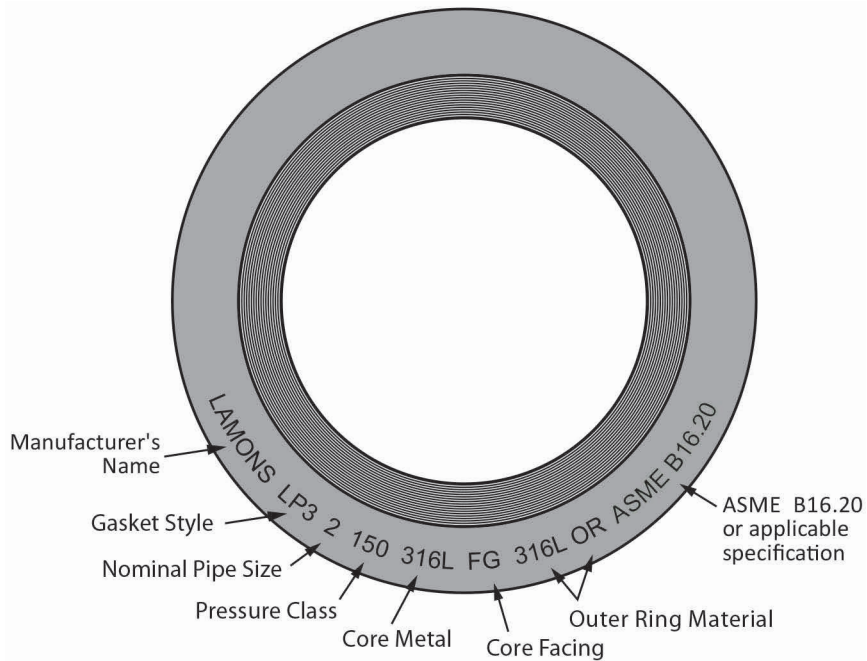

LAMONS CORRUGATED METAL GASKETS (CMG®) PRODUCT FAMILY

Lamons CMG gaskets are considered the standard in respect to corrugated metal gasket technology. They are an excellent choice for 150 and 300 class ASME flanges where available bolt loading is minimal. The substrate geometry promotes recovery and resilience through thermal cycles and extended service life. CMG's can be direct replacements for spiral wound gaskets and can eliminate inward buckling issues while creating a seal at moderate flange stresses. Available in a wide range of substrate alloys and covering layer options, CMG gaskets can be utilized to solve many common flange problems. CMG substrate geometries are designed to achieve maximum recovery characteristics. A specific pitch, core thickness and wall angle are engineered to maximize the seal's ability to overcome problems associated with joint relaxation, pressure and thermal cycles. CMG is an excellent choice for pressure classes 150 and 300 ASME B16.5 flanges where available load is minimal.

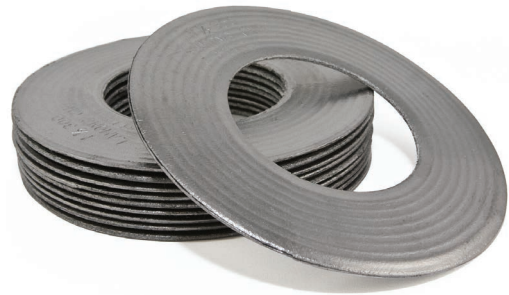

CMG

Lamons Corrugated Metal Gasket (CMG) is a high performance gasket for standard flange or heat exchanger applications. The CMG molds in place by filling in irregularities of the spaces, creating a superior seal. It maintains the seal even in harsh environments, including hydrocarbons and steam applications. The gasket is ideal where low bolt load is present or where high gasket stresses are available. The thin profile is beneficial in areas where flange separation is limited. The heavy 22 gauge core and 1/8" (3.175 mm) pitch frequency results in superior recovery and crush resistance in the most demanding applications.



CMG-EX

Lamons CMG-EX gasket is a premium variation of Lamons original CMG gasket. The CMG-EX was designed specifically for heat exchanger applications and provides superior performance in cyclic applications and where a high level of radial shear is present. Differential movement between flanges can cause tremendous relaxation issues on traditional heat exchanger gaskets. This problem is addressed in the design of the CMG-EX gasket, as it maintains a highest degree of tightness through operation and the full cycle event.



CMGT

Lamons CMGT style gasket maintains the same distinctive performance of the CMG, but provides an additional level of chemical resistance by utilizing a PTFE inner ring. Premium flexible graphite covering layers are used over a corrugated substrate with a PTFE facing covering the inner perimeter of the gasket. This configuration allows the user to maintain a "fire safe" design but have the benefits of additional chemical resistance with less potential of graphite contamination in their process.



CMG-PTFE

Lamons CMG-PTFE gasket is also based upon the same design as the CMG, but utilizes full expanded PTFE covering layers. This design is commonly used in FRP or plastic piping where low available load is critical. Premium chemical resistance is realized by the pure PTFE facings, and a variety of metallurgical substrates can be used to match the piping system. The same proprietary substrate geometry is utilized to optimize recovery and resilience.



CMG-HTG

Lamons CMG-HTG offers rebound and a recovery characteristics where movement between the flanges is a concern, and oxidation of the graphite facing is a potential at elevated temperatures. Lamons CMG-HTG (high temperature gasket) is configured such that the sealing benefit of graphite is included, and is protected with oxidation-resistant barriers of mica material.



DIMENSIONS FOR CORRUGATED METAL GASKET (CMG) TO SUIT ASME B16.5 FLANGES

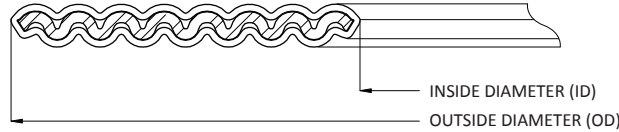

Nominal Pipe Size (NPS)	Class 150			
	Inside Diameter (ID)		Outside Diameter (OD)	
	Inches	mm	Inches	mm
1/2	0.84	21	1.88	48
3/4	1.06	27	2.25	57
1	1.31	33	2.62	67
1 1/4	1.66	42	3.00	76
1 1/2	1.91	49	3.38	86
2	2.38	60	4.12	105
2 1/2	2.88	73	4.88	124
3	3.50	89	5.38	137
3 1/2	4.00	102	6.38	162
4	4.50	114	6.88	175
5	5.56	141	7.75	197
6	6.62	168	8.75	222
8	8.62	219	11.00	279
10	10.75	273	13.38	340
12	12.75	324	16.13	410
14	14.00	356	17.75	451
16	16.00	406	20.25	514
18	18.00	457	21.62	549
20	20.00	508	23.88	607
24	24.00	610	28.25	718

Nominal Pipe Size (NPS)	Class 300			
	Inside Diameter (ID)		Outside Diameter (OD)	
	Inches	mm	Inches	mm
1/2	0.84	21	2.12	54
3/4	1.06	27	2.62	67
1	1.31	33	2.88	73
1 1/4	1.66	42	3.25	83
1 1/2	1.91	49	3.75	95
2	2.38	60	4.38	111
2 1/2	2.88	73	5.12	130
3	3.50	89	5.88	149
3 1/2	4.00	102	6.50	165
4	4.50	114	7.12	181
5	5.56	141	8.50	216
6	6.62	168	9.88	251
8	8.62	219	12.12	308
10	10.75	273	14.25	362
12	12.75	324	16.62	422
14	14.00	356	19.12	486
16	16.00	406	21.25	540
18	18.00	457	23.50	597
20	20.00	508	25.75	654
24	24.00	610	30.50	775

LAMONS HEAT EXCHANGER SPECIFICATIONS

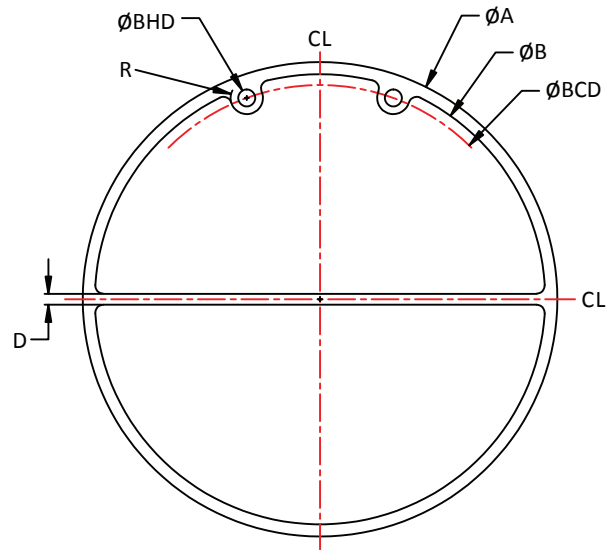
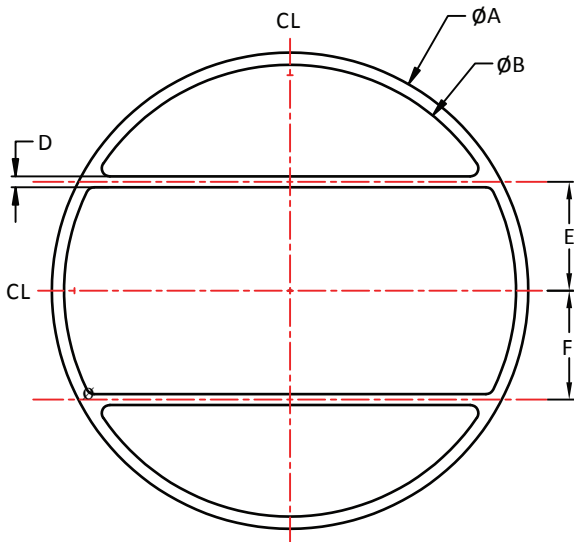

Information required to fill an order:

- Gasket shape per the standard shape index
- Metal material
- Filler/facing material
- Thickness





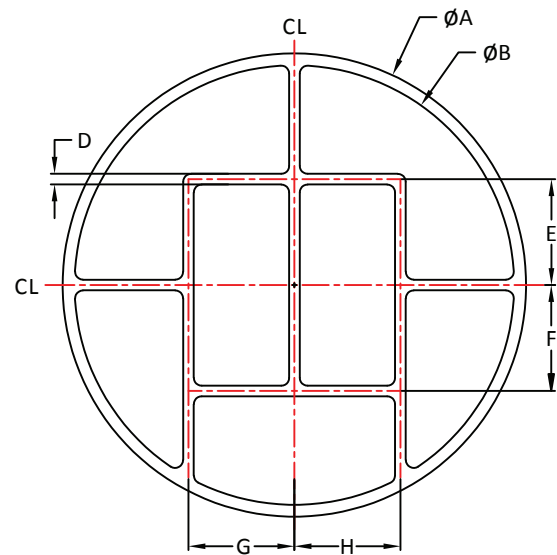





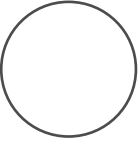
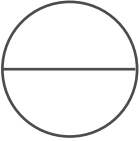

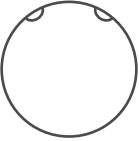
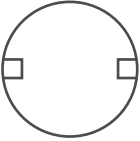
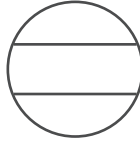
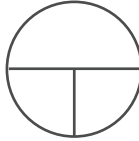
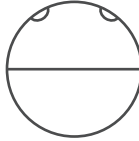
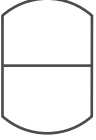

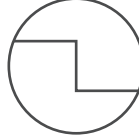
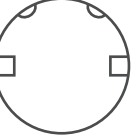
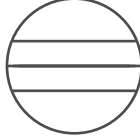
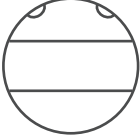
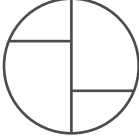
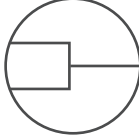
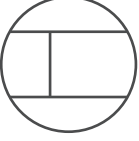
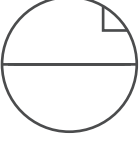
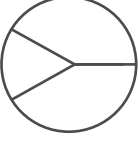
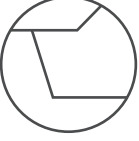
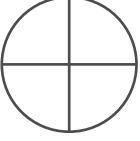
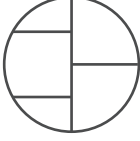
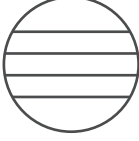
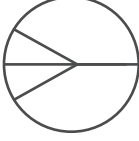
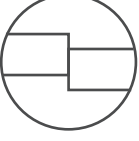
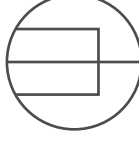
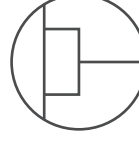
Dimensions required to fill an order:

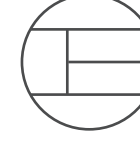
- A: Outside Diameter (OD)
- B: Inside Diameter (ID)
- D: Pass partition width
- E: Distance from centerline of gasket to centerline of first pass partition
- F: Distance from centerline of gasket to centerline of second pass partition
- G: Distance from centerline of gasket to centerline of third pass partition
- H: Distance from centerline of gasket to centerline of fourth pass partition
- BCD: Bolt Circle Diameter
- BHD: Bolt Hole Diameter
- R: Radius
- Number of bolt holes (for full face gasket shape)

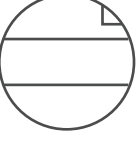
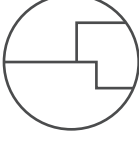
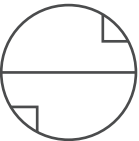
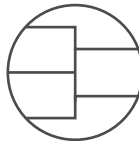
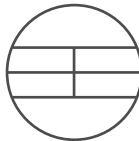
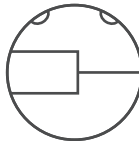
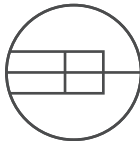
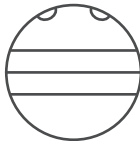
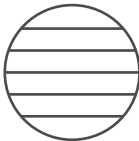
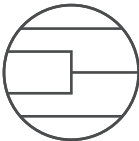
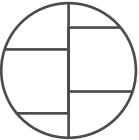
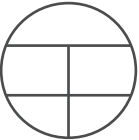
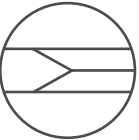

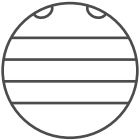
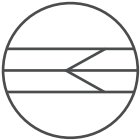
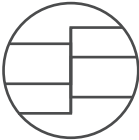
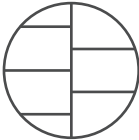
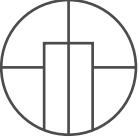
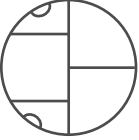
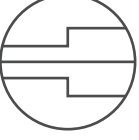
LAMONS HEAT EXCHANGER GASKETS

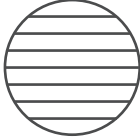
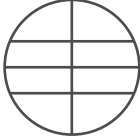
STANDARD SHAPE INDEX

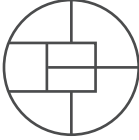
 R	 C-1	 C-2	 D-1	 D-2	 E-1	 E-2	 E-3
 E-4	 F-1	 F-2	 F-3	 G-1	 G-2	 G-3	 G-4
 G-5	 G-6	 G-7	 G-8	 G-9	 H-1	 H-2	 H-3
 H-4	 H-5	 H-6	 H-7	 H-8	 H-9	 H-10	 H-11
 H-12	 I-1	 I-2	 I-3	 I-4	 I-5	 I-6	 I-7
 I-8	 I-9	 I-10	 I-11	 J-1	 J-2	 J-3	 J-4
 J-5	 J-6	 J-7	 J-8	 K-1	 K-2	 K-3	 K-4

LAMONS METAL & JACKETED GASKET PRODUCT FAMILY

Lamons jacketed gaskets are normally supplied with a non-asbestos, high temperature filler. The standard filler is normally sufficient for applications up to 900°F (482°C). Other soft fillers are available for higher temperatures or special applications. Standard metals used to make jacketed gaskets, regardless of the type, are aluminum, copper, the various brasses, soft steel, nickel, Monel®, Inconel®, and stainless steel types 304, 316, 321, 347, 410. The choice of metal used for the jacketed part of gasket would depend upon the service conditions being encountered.



STYLE 300 DOUBLE JACKETED GASKET

Double jacketed gaskets are most commonly used in heat exchanger applications. They are available in virtually any material that is commercially found in 26 gauge sheet. They are also used in standard flanges where the service is not critical and at temperatures beyond which a soft gasket can be used. Since most double jacketed gaskets are custom made, there is virtually no limit to the size, shape or configuration in which these gaskets can be made. This particular type of gasket can be used in a myriad of applications. Since the size and shape are not a problem and since most materials can be obtained commercially, this particular gasket style is popular. It must be remembered that the primary seal against leakage, using a double jacketed gasket, is the metal inner lap where the gasket is thickest before being compressed and densest when compressed. This particular section flows, affecting the seal. As a consequence, the entire inner lap must be under compression. Frequently, the outer lap is not under compression and does not aid in the sealing of the gasket. On most heat exchanger applications the outer lap is also under compression, providing a secondary seal. The intermediate part of a double-jacketed gasket does very little to effect the sealing capability of the gasket. In some cases, nubbins are provided on heat exchanger designs to provide an intermediate seal. This nubbin is normally 1/64" (0.4 mm) high by 1/8" (3 mm) wide. Experience has indicated, however, that there is little advantage to this particular design. The primary seal is still dependent on the inner lap of the gasket doing the brute work and the secondary seal, when applicable, would be provided by the outer lap.



STYLE 310 PLAIN FLAT METAL GASKETS

Flat metal gaskets are best suited for applications such as valve bonnets, ammonia fittings, heat exchangers, hydraulic presses, tongue-and-groove joints. They can be used when compressibility is not required to compensate for flange surface finish, warpage or misalignment, and where sufficient clamping force is available to seat the particular metal selected. They must be sealed by the flow of the gasket metal into the imperfections on the gasket seating surfaces of the flange. This typically requires heavy compressive forces. The hardness of gasket metal must be less than the hardness of the flanges to prevent damage to the gasket seating surface of the flange. Flat metal gaskets are relatively inexpensive to produce and can be made of virtually any material that is available in sheet form. Size limitation is normally restricted to the sheet size. Larger gaskets can be fabricated by welding.



NOTE: Monel® and Inconel® are registered trademarks of Special Metals Corporation.

STYLE 320 ROUND CROSS SECTION, SOLID METAL GASKETS

Round cross section solid metal gaskets are used on specifically designed flanges grooved or otherwise faced to accurately locate the gasket during assembly. These gaskets seal by a line contact which provides an initial high seating stress at low bolt loads. This makes an ideal gasket for low pressures.

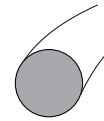

The more common materials used for this type of gasket would be aluminum, copper, soft iron or steel, Monel, nickel, and 300 series stainless steels. They are fabricated from wire, formed to size and welded. The weld is then polished to the exact wire diameter.

STYLE 333 DOUBLE JACKETED CORRUGATED GASKET

The double jacketed corrugated gasket is an improvement on a plain jacketed gasket in that the corrugations on the gasket will provide an additional labyrinth seal. It also provides the advantage of reducing the contact area of the gasket, enhancing its compressive characteristics. A double jacketed corrugated gasket still relies on the primary seal on the inner lap.



STYLE 340 DOUBLE JACKETED CORRUGATED GASKET WITH A CORRUGATED METAL FILLER

At temperatures in excess of the range of 900°F (483°C) to 1000°F (538°C) where the standard soft filler is normally not recommended, a double jacketed corrugated metal gasket with a corrugated metal filler can be beneficial. This construction has the advantages of the double jacketed corrugated metal gasket and, in addition, since the filler is normally the same material as the gasket itself, the upper temperature limit would be determined by the metal being used. This type of gasket, depending upon metal selected, is designed to be a heat exchanger gasket for high pressure, high temperature applications.



STYLE 341 DOUBLE JACKETED CORRUGATED GASKET WITH CORRUGATED METAL FILLER

Style 341 is the same general configuration as the Style 340, specifically using a 1/32" (0.8 mm) thick corrugated metal filler. In addition, 0.015" (0.4 mm) thick flexible graphite will be applied to both top/bottom

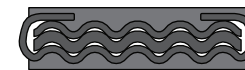

STYLE 344 PROFILE GASKETS

Profile type gaskets offer the desirable qualities of plain washer types and the added advantage of a reduced contact area provided by the V-shaped surface. It is used when a solid metal gasket is required because of pressure or temperature or because of the highly corrosive effect of the fluid to be contained and also when bolting is not sufficient to seat a flat washer.



STYLE 345/346 A PROFILE GASKET WITH A METAL JACKET

If flange conditions require a profile type gasket, but flange protection is required as well, the profile gasket may be supplied with either a single jacketed or a double jacketed shield. This will provide protection for the flanges and will minimize damage to the flange faces due to the profile surface.

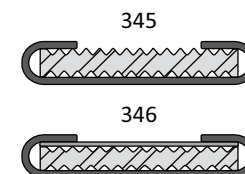

FRENCH TYPE GASKETS

French type gaskets are available in a one-piece jacketed construction for narrow radial widths not exceeding 1/4" (6.35 mm) and in two and three-piece constructions. This type of gasket can also be used with the jacket on the external edge of the gasket when the application requires the outer edge of the gasket to be exposed to fluid pressure. The most widely used French type gaskets are fabricated using a copper sheath. The double jacketed construction is preferred over the French or single jacketed construction, where practical, since it provides a totally sheathed gasket with none of the soft filler exposed.

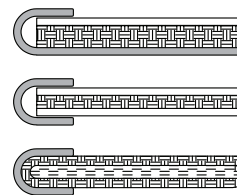

STYLE 350 SINGLE JACKETED GASKET

The majority of applications for single jacketed gaskets are normally 1/4" (6.35 mm) or less in radial width. This type of gasket is used in air tool applications and engine applications where space is limited, gasket seating surfaces are narrow and relatively low compressive forces are available for seating the gasket.



STYLE 382 SINGLE JACKETED OVERLAP

In the single-jacketed overlap construction the maximum flange width is approximately 1/4" (6.4 mm). This type of gasket is used when total enclosure of the soft filler material is required and when the flange width makes it impractical to use a double jacketed gasket.



STYLE 375 DOUBLE JACKETED DOUBLE SHELL GASKET

The double-jacketed, double-shelled gasket is similar to the double jacketed gasket except that instead of using a shell and a liner, two shells are used in the fabrication of the gasket. It has the advantage of a double lap at both the ID and the OD of the gasket, adding greater stability to the gasket. The construction will withstand higher compressive loads. Double-shell gaskets are normally restricted to use in high pressure applications.



STYLE 395 MODIFIED FRENCH TYPE

This particular type of gasket is normally used with very light flanges on duct work handling hot gases. Its construction consists of two French type shields welded together with a Cerafelt filler material on either side of the metal. Metal thickness is normally 26 gauge, rolled on the ID to act as a shield.

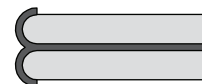

STYLE 370 CORRUGATED GASKET

The Style 370 includes adhering non-asbestos material strips or fiberglass cord to the corrugated faces – typically in the “valleys”.



NOTE: Without exception all of the solid metal gaskets require a very fine surface finish on the flanges. A flange with a flange surface roughness of 63 AARH or smoother is desired. Under no circumstances should the surface finish exceed 125 AARH. In addition, radial gouges or scores would be almost impossible to seal using solid metal gaskets.

DIMENSIONS FOR DOUBLE JACKETED (DJ) GASKETS PER
ASME B16.20 TO SUIT ASME B16.5 FLANGES

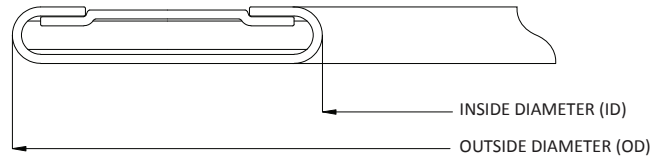

Nominal Pipe Size (NPS)	Gasket Inside Diameter (ID) (1)		Gasket Outside Diameter (OD) by Class (1)							
			150		300		400 (2)		600	
			Inches	mm	Inches	mm	Inches	mm	Inches	mm
1/2	0.880	22.4	1.750	44.5	2.000	50.8	--	--	2.000	50.8
3/4	1.130	28.7	2.130	54.1	2.500	63.5	--	--	2.500	63.5
1	1.500	38.1	2.500	63.5	2.750	69.9	--	--	2.750	69.9
1 1/4	1.880	47.8	2.880	73.2	3.130	79.5	--	--	3.130	79.5
1 1/2	2.130	54.1	3.250	82.6	3.630	92.2	--	--	3.630	92.2
2	2.880	73.2	4.000	101.6	4.250	108.0	--	--	4.250	108.0
2 1/2	3.380	85.9	4.750	120.7	5.000	127.0	--	--	5.000	127.0
3	4.250	108.0	5.250	133.4	5.750	146.1	--	--	5.750	146.1
4	5.190	131.8	6.750	171.5	7.000	177.8	6.880	174.8	7.500	190.5
5	6.000	152.4	7.630	193.8	8.380	212.9	8.250	209.6	9.380	238.3
6	7.500	190.5	8.630	219.2	9.750	247.7	9.630	244.6	10.380	263.7
8	9.380	238.3	10.880	276.4	12.000	304.8	11.880	301.8	12.500	317.5
10	11.250	285.8	13.250	336.6	14.130	358.9	14.000	355.6	15.630	397.0
12	13.500	342.9	16.000	406.4	16.500	419.1	16.380	416.1	17.880	454.2
14	14.750	374.7	17.630	447.8	19.000	482.6	18.880	479.6	19.250	489.0
16	16.750	425.5	20.130	511.3	21.130	536.7	21.000	533.4	22.130	562.1
18	19.250	489.0	21.500	546.1	23.380	593.9	23.250	590.6	24.000	609.6
20	21.000	533.4	23.750	603.3	25.630	651.0	25.380	644.7	26.750	679.5
24	25.250	641.4	28.130	714.5	30.380	771.7	30.130	765.3	31.000	787.4

Nominal Pipe Size (NPS)	Gasket Inside Diameter (ID) (1)		Gasket Outside Diameter (OD) by Class (1)							
			900 (3)		1500		2500 (4)			
			Inches	mm	Inches	mm	Inches	mm	Inches	mm
1/2	0.880	22.4	--	--	2.380	60.5	2.630	66.8	--	--
3/4	1.130	28.7	--	--	2.630	66.8	2.880	73.2	--	--
1	1.500	38.1	--	--	3.000	76.2	3.250	82.6	--	--
1 1/4	1.880	47.8	--	--	3.380	85.9	4.000	101.6	--	--
1 1/2	2.130	54.1	--	--	3.750	95.3	4.500	114.3	--	--
2	2.880	73.2	--	--	5.500	139.7	5.630	143.0	--	--
2 1/2	3.380	85.9	--	--	6.380	162.1	6.500	165.1	--	--
3	4.250	108.0	6.500	165.1	6.750	171.5	7.630	193.8	--	--
4	5.190	131.8	8.000	203.2	8.130	206.5	9.130	231.9	--	--
5	6.000	152.4	9.630	244.6	9.880	251.0	10.880	276.4	--	--
6	7.500	190.5	11.250	285.8	11.000	279.4	12.380	314.5	--	--
8	9.380	238.3	14.000	355.6	13.750	349.3	15.130	384.3	--	--
10	11.250	285.8	17.000	431.8	17.000	431.8	18.630	473.2	--	--
12	13.500	342.9	19.500	495.3	20.380	517.7	21.500	546.1	--	--
14	14.750	374.7	20.380	517.7	22.630	574.8	--	--	--	--
16	16.750	425.5	22.500	571.5	25.130	638.3	--	--	--	--
18	19.250	489.0	25.000	635.0	27.630	701.8	--	--	--	--
20	21.000	533.4	27.380	695.5	29.630	752.6	--	--	--	--
24	25.250	641.4	32.880	835.2	35.380	898.7	--	--	--	--

General Note:
The gasket thickness tolerance is (+0.03 in., - 0.000 in.) (+0.8 mm, - 0.0 mm)

Note:
(1) For gaskets NPS 1/2 through NPS 24, the outside and inside diameter tolerances are +0.06 in, - 0.0 in. (+1.5 mm, - 0.0 mm)

(2) There are no Class 400 flanges for NPS 1/2 through NPS 3 (use Class 600)

(3) There are no Class 900 flanges for NPS 1/2 through NPS 2 1/2 (use Class 1500)

(4) There are no Class 2500 flanges NPS 14 and larger

**DIMENSIONS FOR DOUBLE JACKETED (DJ) GASKETS PER
ASME B16.20 TO SUIT ASME B16.47 SERIES A FLANGES**

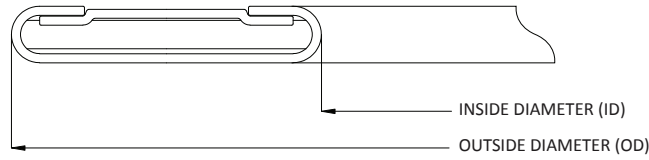

Nominal Pipe Size (NPS)	Inside Diameter (ID) (1)		Outside Diameter (OD) by Class (1)					
			Class 150		Class 300		Class 400 (2)	
	Inches	mm	Inches	mm	Inches	mm	Inches	mm
26	26.50	673.1	30.38	771.7	32.75	831.9	32.63	828.8
28	28.50	723.9	32.63	828.8	35.25	895.4	35.00	889.0
30	30.50	774.7	34.63	879.6	37.38	949.5	37.13	943.1
32	32.50	825.5	36.88	936.8	39.50	1003.3	39.38	1000.3
34	34.50	876.3	38.88	987.6	41.50	1054.1	41.38	1051.1
36	36.50	927.1	41.13	1044.7	43.88	1114.6	43.88	1114.6
38	38.50	977.9	43.63	1108.2	41.38	1051.1	42.13	1070.1
40	40.50	1028.7	45.63	1159.0	43.75	1111.3	44.25	1124.0
42	42.50	1079.5	47.88	1216.2	45.75	1162.1	46.25	1174.8
44	44.50	1130.3	50.13	1273.3	47.88	1216.2	48.38	1228.9
46	46.50	1181.1	52.13	1324.1	50.00	1270.0	50.63	1286.0
48	48.50	1231.9	54.38	1381.3	52.00	1320.8	52.88	1343.2
50	50.50	1282.7	56.38	1432.1	54.13	1374.9	55.13	1400.3
52	52.50	1333.5	58.63	1489.2	56.13	1425.7	57.13	1451.1
54	54.50	1384.3	60.88	1546.4	58.63	1489.2	59.63	1514.6
56	56.50	1435.1	63.13	1603.5	60.63	1540.0	61.63	1565.4
58	58.50	1485.9	65.38	1660.7	62.63	1590.8	63.63	1616.2
60	60.50	1536.7	67.38	1711.5	64.63	1641.6	66.13	1679.7

Nominal Pipe Size (NPS)	Inside Diameter (ID) (1)		Outside Diameter (OD) by Class (1)			
			Class 600		Class 900 (2)	
	Inches	mm	Inches	mm	Inches	mm
26	26.50	673.1	34.00	863.6	34.63	879.6
28	28.50	723.9	35.88	911.4	37.13	943.1
30	30.50	774.7	38.13	968.5	39.63	1006.6
32	32.50	825.5	40.13	1019.3	42.13	1070.1
34	34.50	876.3	42.13	1070.1	44.63	1133.6
36	36.50	927.1	44.38	1127.3	47.13	1197.1
38	38.50	977.9	43.38	1101.9	47.13	1197.1
40	40.50	1028.7	45.38	1152.7	49.13	1247.9
42	42.50	1079.5	47.88	1216.2	51.13	1298.7
44	44.50	1130.3	49.88	1267.0	53.75	1365.3
46	46.50	1181.1	52.13	1324.1	56.38	1432.1
48	48.50	1231.9	54.63	1387.6	58.38	1482.9
50	50.50	1282.7	56.88	1444.8	--	--
52	52.50	1333.5	58.88	1495.6	--	--
54	54.50	1384.3	61.13	1552.7	--	--
56	56.50	1435.1	63.13	1603.5	--	--
58	58.50	1485.9	65.38	1660.7	--	--
60	60.50	1536.7	68.13	1730.5	--	--

General Note:
The gasket thickness tolerance is +0.03 in, -0.000 in (+0.8 mm, -0.0 mm)

Notes:
(1) For gaskets NPS 26 through NPS 60, the outside diameter and inside diameter tolerances are +0.13 in, -0.000 in (+3.3 mm, -0.0 mm).

(2) There are no Class 900 flanges for NPS 50 and larger.

DIMENSIONS FOR DOUBLE JACKETED (DJ) GASKETS PER
ASME B16.20 TO SUIT ASME B16.47 SERIES B FLANGES

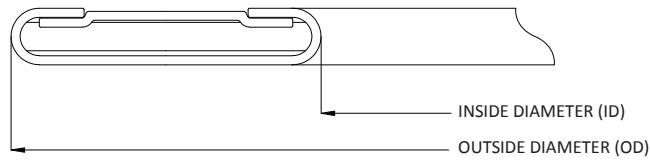

Nominal Pipe Size (NPS)	Inside Diameter (ID) (1)		Outside Diameter (OD) by Class (1)					
			Class 150		Class 300		Class 400 (2)	
	Inches	mm	Inches	mm	Inches	mm	Inches	mm
26	26.50	673.1	28.44	722.4	30.25	768.4	29.25	743.0
28	28.50	723.9	30.44	773.2	32.38	822.5	31.38	797.1
30	30.50	774.7	32.44	824.0	34.75	882.7	33.63	854.2
32	32.50	825.5	34.56	877.8	36.88	936.8	35.75	908.1
34	34.50	876.3	36.69	931.9	39.00	990.6	37.75	958.9
36	36.50	927.1	38.75	984.3	41.13	1044.7	40.13	1019.3
38	38.50	977.9	41.00	1041.4	43.13	1095.5	42.13	1070.1
40	40.50	1028.7	43.00	1092.2	45.13	1146.3	44.25	1124.0
42	42.50	1079.5	45.00	1143.0	47.13	1197.1	46.25	1174.8
44	44.50	1130.3	47.00	1193.8	49.13	1247.9	48.38	1228.9
46	46.50	1181.1	49.31	1252.5	51.75	1314.5	50.63	1286.0
48	48.50	1231.9	51.31	1303.3	53.75	1365.3	52.88	1343.2
50	50.50	1282.7	53.31	1354.1	55.75	1416.1	55.13	1400.3
52	52.50	1333.5	55.31	1404.9	57.75	1466.9	57.13	1451.1
54	54.50	1384.3	57.50	1460.5	60.13	1527.3	59.63	1514.6
56	56.50	1435.1	59.50	1511.3	62.63	1590.8	61.63	1565.4
58	58.50	1485.9	62.06	1576.3	65.06	1652.5	63.63	1616.2
60	60.50	1536.7	64.06	1627.1	67.06	1703.3	66.13	1679.7

Nominal Pipe Size (NPS)	Inside Diameter (ID) (1)		Outside Diameter (OD) by Class (1)			
			Class 600		Class 900 (2)	
	Inches	mm	Inches	mm	Inches	mm
26	26.50	673.1	30.00	762.0	32.88	835.2
28	28.50	723.9	32.13	816.1	35.38	898.7
30	30.50	774.7	34.50	876.3	37.63	955.8
32	32.50	825.5	36.63	930.4	39.88	1013.0
34	34.50	876.3	39.13	993.9	42.13	1070.1
36	36.50	927.1	41.13	1044.7	44.13	1120.9
38	38.50	977.9	43.38	1101.9	47.13	1197.1
40	40.50	1028.7	45.38	1152.7	49.13	1247.9
42	42.50	1079.5	47.88	1216.2	51.13	1298.7
44	44.50	1130.3	49.88	1267.0	53.75	1365.3
46	46.50	1181.1	52.13	1324.1	56.38	1432.1
48	48.50	1231.9	54.63	1387.6	58.38	1482.9
50	50.50	1282.7	56.88	1444.8	--	--
52	52.50	1333.5	58.88	1495.6	--	--
54	54.50	1384.3	61.13	1552.7	--	--
56	56.50	1435.1	63.13	1603.5	--	--
58	58.50	1485.9	65.38	1660.7	--	--
60	60.50	1536.7	68.13	1730.5	--	--

General Note:
The gasket thickness tolerance is
+0.03 in, -0.000 in
(+0.8 mm, -0.0 mm)

Notes:
(1) For gaskets NPS 26 through NPS 60, the outside diameter and inside diameter tolerances are +0.13 in, -0.000 in (+3.3 mm, -0.0 mm)

(2) There are no Class 900 flanges for NPS 50 and larger.

SECTION THREE: METALLIC GASKETS

LAMONS RING TYPE JOINT (RTJ) GASKET PRODUCT FAMILY

Lamons manufactures and supplies a large variety of ring type joint gaskets. Lamons Ring Type Joint (RTJ) standard size gaskets are manufactured in accordance to API 6A, API 17D and ASME B16.20 specifications.

□ OVAL (STYLE 377)

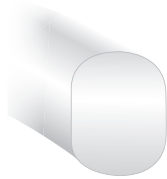

□ OCTAGONAL (STYLE 388)



Ring joint gaskets come in two basic types, an oval cross section (Style 377) and an octagonal cross section (Style 388). These basic shapes are used in pressures up to 10,000 psi (64 MPa). The dimensions are standardized and require specially grooved flanges. The octagonal cross section has a higher sealing efficiency than the oval and would be the preferred gasket. However, only the oval cross section can be used in the old type round bottom groove. The newer flat bottom groove design will accept either the oval or the octagonal cross section. The sealing surfaces on the ring joint grooves must be smoothly finished to 63 micro inches and be free of objectionable ridges, tool or chatter marks. RTJ assemblies seal by an initial line contact or an edging action as the compressive forces are applied.

The hardness of the ring should always be less than the hardness of the flanges to prevent flange deformation. Dimensions for standard ring joint gaskets and grooves are covered in ASME B16.20 and API 6A, API 17D and ASME B16.5/B16.20.

Lamons stocks a wide range of sizes and materials ready for immediate shipment, from R11 to R105. Our extensive inventory of raw materials allows for best in class delivery of special sizes and shapes. Please consult with Lamons Engineering for design of non-standard items.

TYPICAL RING JOINT GASKET MATERIALS

Material	Designation	Maximum Hardness Rockwell B	Maximum Hardness Brinell
Soft Iron	D	56	90
Low Carbon Steel	S	68	120
4-6 Chrome	F-5*	72	130
304 Stainless Steel	S304	83	160
316 Stainless Steel	S316	83	160
321 Stainless Steel	S321	83	160
347 Stainless Steel	S347	83	160
410 Stainless Steel	S410	86	170
Alloy 625	INC 625	89	180
Alloy 825	INC 825	92	195
Other CRAs	Hardness shall meet Lamons material specifications		

*F-5 identification designates ASTM Specification
A 182 chemical composition requirements only



SIZE DESIGNATIONS FOR OVAL OR OCTAGONAL RINGS

Nominal Pipe Size (NPS)	Flange Pressure Class					API 6A (psi)		
	150	300-600	900	1500	2500	2000	3000	5000
1/2	--	R-11	R-12	R-12	R-13	--	--	--
3/4	--	R-13	R-14	R-14	R-16	--	--	--
1	R-15	R-16	R-16	R-16	R-18	--	--	--
1 1/4	R-17	R-18	R-18	R-18	R-21	--	--	--
1 1/2	R-19	R-20	R-20	R-20	R-23	--	--	--
2	R-22	R-23	R-24	R-24	R-26	--	--	--
2 1/16	--	--	--	--	--	R-23	R-24	
2 1/2	R-25	R-26	R-27	R-27	R-28	--	--	--
2 9/16	--	--	--	--	--	R-26	R-27	
3	R-29	R-31	R-31	R-35	R-32	--	--	--
3 1/8	--	--	--	--	--	R-31		R-35
3 1/2	R-33	R-34	R-34	--	--	--	--	--
4	R-36	R-37	R-37	R-39	R-38	--	--	--
4 1/16	--	--	--	--	--	R-37		R-39
5	R-40	R-41	R-41	R-44	R-42	--	--	--
5 1/8	--	--	--	--	--	R-41		R-44
6	R-43	R-45	R-45	R-46	R-47	--	--	--
7 1/16	--	--	--	--	--	R-45		R-46
8	R-48	R-49	R-49	R-50	R-51	--	--	--
9	--	--	--	--	--	R-49		R-50
10	R-52	R-53	R-53	R-54	R-55	--	--	--
11	--	--	--	--	--	R-53		R-54
12	R-56	R-57	R-57	R-58	R-60	--	--	--
13 5/8	--	--	--	--	--	R-57		--
14	R-59	R-61	R-62	R-63	--	--	--	--
16	R-64	R-65	R-66	R-67	--	--	--	--
16 3/4	--	--	--	--	--	R-65		--
18	R-68	R-69	R-70	R-71	--	--	--	--
20	R-72	R-73	R-74	R-75	--	--	--	--
20 3/4	--	--	--	--	--	--	R74	--
21 1/4	--	--	--	--	--	R-73	--	--
22	R-80	R-81	--	--	--	--	--	--
24	R-76	R-77	R-78	R-79	--	--	--	--
26	--	R-93	R-100	--	--	--	--	--
28	--	R-94	R-101	--	--	--	--	--
30	--	R-95	R-102	--	--	--	--	--
32	--	R-96	R-103	--	--	--	--	--
34	--	R-97	R-104	--	--	--	--	--
36	--	R-98	R-105	--	--	--	--	--

**DIMENSIONS FOR TYPE R OCTAGONAL AND OVAL RING GASKETS
TO SUIT ASME B16.20 AND API 6A**

Ring Number	Pitch Diameter of Ring (P)		Width of Ring (A)		Height of Ring				Width of Flat on Octagonal Ring (C)		Radius in Octagonal Ring (R1)	
					Oval (B)		Octagonal (H)					
	Inches	mm	Inches	mm	Inches	mm	Inches	mm	Inches	mm	Inches	mm
R-11	1.344	34.14	0.250	6.35	0.440	11.2	0.380	9.7	0.170	4.32	0.060	1.5
R-12	1.563	39.70	0.313	7.95	0.560	14.2	0.500	12.7	0.206	5.23	0.060	1.5
R-13	1.688	42.88	0.313	7.95	0.560	14.2	0.500	12.7	0.206	5.23	0.060	1.5
R-14	1.750	44.45	0.313	7.95	0.560	14.2	0.500	12.7	0.206	5.23	0.060	1.5
R-15	1.875	47.63	0.313	7.95	0.560	14.2	0.500	12.7	0.206	5.23	0.060	1.5
R-16	2.000	50.80	0.313	7.95	0.560	14.2	0.500	12.7	0.206	5.23	0.060	1.5
R-17	2.250	57.15	0.313	7.95	0.560	14.2	0.500	12.7	0.206	5.23	0.060	1.5
R-18	2.375	60.33	0.313	7.95	0.560	14.2	0.500	12.7	0.206	5.23	0.060	1.5
R-19	2.563	65.10	0.313	7.95	0.560	14.2	0.500	12.7	0.206	5.23	0.060	1.5
R-20	2.688	68.28	0.313	7.95	0.560	14.2	0.500	12.7	0.206	5.23	0.060	1.5
R-21	2.844	72.24	0.438	11.13	0.690	17.5	0.630	16.0	0.305	7.75	0.060	1.5
R-22	3.250	82.55	0.313	7.95	0.560	14.2	0.500	12.7	0.206	5.23	0.060	1.5
R-23	3.250	82.55	0.438	11.13	0.690	17.5	0.630	16.0	0.305	7.75	0.060	1.5
R-24	3.750	95.25	0.438	11.13	0.690	17.5	0.630	16.0	0.305	7.75	0.060	1.5
R-25	4.000	101.60	0.313	7.95	0.560	14.2	0.500	12.7	0.206	5.23	0.060	1.5
R-26	4.000	101.60	0.438	11.13	0.690	17.5	0.630	16.0	0.305	7.75	0.060	1.5
R-27	4.250	107.95	0.438	11.13	0.690	17.5	0.630	16.0	0.305	7.75	0.060	1.5
R-28	4.375	111.13	0.500	12.70	0.750	19.1	0.690	17.5	0.341	8.66	0.060	1.5
R-29	4.500	114.30	0.313	7.95	0.560	14.2	0.500	12.7	0.206	5.23	0.060	1.5
R-30	4.625	117.48	0.438	11.13	0.690	17.5	0.630	16.0	0.305	7.75	0.060	1.5
R-31	4.875	123.83	0.438	11.13	0.690	17.5	0.630	16.0	0.305	7.75	0.060	1.5
R-32	5.000	127.00	0.500	12.70	0.750	19.1	0.690	17.5	0.341	8.66	0.060	1.5
R-33	5.188	131.78	0.313	7.95	0.560	14.2	0.500	12.7	0.206	5.23	0.060	1.5
R-34	5.188	131.78	0.438	11.13	0.690	17.5	0.630	16.0	0.305	7.75	0.060	1.5
R-35	5.375	136.53	0.438	11.13	0.690	17.5	0.630	16.0	0.305	7.75	0.060	1.5
R-36	5.875	149.23	0.313	7.95	0.560	14.2	0.500	12.7	0.206	5.23	0.060	1.5
R-37	5.875	149.23	0.438	11.13	0.690	17.5	0.630	16.0	0.305	7.75	0.060	1.5
R-38	6.188	157.18	0.625	15.88	0.880	22.4	0.810	20.6	0.413	10.49	0.060	1.5
R-39	6.375	161.93	0.438	11.13	0.690	17.5	0.630	16.0	0.305	7.75	0.060	1.5
R-40	6.750	171.45	0.313	7.95	0.560	14.2	0.500	12.7	0.206	5.23	0.060	1.5
R-41	7.125	180.98	0.438	11.13	0.690	17.5	0.630	16.0	0.305	7.75	0.060	1.5
R-42	7.500	190.50	0.750	19.05	1.000	25.4	0.940	23.9	0.485	12.32	0.060	1.5
R-43	7.625	193.68	0.313	7.95	0.560	14.2	0.500	12.7	0.206	5.23	0.060	1.5
R-44	7.625	193.68	0.438	11.13	0.690	17.5	0.630	16.0	0.305	7.75	0.060	1.5
R-45	8.313	211.15	0.438	11.13	0.690	17.5	0.630	16.0	0.305	7.75	0.060	1.5
R-46	8.313	211.15	0.500	12.70	0.750	19.1	0.690	17.5	0.341	8.66	0.060	1.5
R-47	9.000	228.60	0.750	19.05	1.000	25.4	0.940	23.9	0.485	12.32	0.060	1.5
R-48	9.750	247.65	0.313	7.95	0.560	14.2	0.500	12.7	0.206	5.23	0.060	1.5
R-49	10.625	269.88	0.438	11.13	0.690	17.5	0.630	16.0	0.305	7.75	0.060	1.5
R-50	10.625	269.88	0.625	15.88	0.880	22.4	0.810	20.6	0.413	10.49	0.060	1.5
R-51	11.000	279.40	0.875	22.23	1.130	28.7	1.060	26.9	0.583	14.81	0.060	1.5
R-52	12.000	304.80	0.313	7.95	0.560	14.2	0.500	12.7	0.206	5.23	0.060	1.5
R-53	12.750	323.85	0.438	11.13	0.690	17.5	0.630	16.0	0.305	7.75	0.060	1.5
R-54	12.750	323.85	0.625	15.88	0.880	22.4	0.810	20.6	0.413	10.49	0.060	1.5
R-55	13.500	342.90	1.125	28.58	1.440	36.6	1.380	35.1	0.750	19.05	0.090	2.3
R-56	15.000	381.00	0.313	7.95	0.560	14.2	0.500	12.7	0.206	5.23	0.060	1.5
R-57	15.000	381.00	0.438	11.13	0.690	17.5	0.630	16.0	0.305	7.75	0.060	1.5

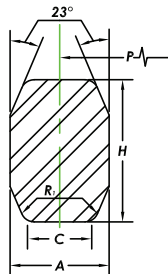

Octagonal

Tolerances:

P = average pitch diameter of ring, ± 0.007" (±0.18 mm)

A = width of ring, ± 0.008" (± 0.20 mm)

B, H = height of ring, (+ 0.05", -0.02") (+1.3 mm, -0.5 mm) Variation in height throughout the entire circumference of any given ring shall not exceed 0.02" within these tolerances

C = width of flat on octagonal ring ± 0.008" (±0.20 mm)

B1 = radius in ring, ± 0.02" (± 0.5 mm)

23 deg = angle, ± 1/2 deg (± 0 deg 30min)

DIMENSIONS FOR TYPE R OCTAGONAL AND OVAL RING GASKETS
PER ASME B16.20 AND API 6A

Ring Number	Pitch Diameter of Ring (P)		Width of Ring (A)		Height of Ring							
					Oval (B)		Octagonal (H)		Width of Flat on Octagonal Ring (C)		Radius in Octagonal Ring (R1)	
	Inches	mm	Inches	mm	Inches	mm	Inches	mm	Inches	mm	Inches	mm
R-58	15.000	381.00	0.875	22.23	1.130	28.7	1.060	26.9	0.583	14.81	0.060	1.5
R-59	15.625	396.88	0.313	7.95	0.560	14.2	0.500	12.7	0.206	5.23	0.060	1.5
R-60	16.000	406.40	1.250	31.75	1.560	39.6	1.500	38.1	0.879	22.33	0.090	2.3
R-61	16.500	419.10	0.438	11.13	0.690	17.5	0.630	16.0	0.305	7.75	0.060	1.5
R-62	16.500	419.10	0.625	15.88	0.880	22.4	0.810	20.6	0.413	10.49	0.060	1.5
R-63	16.500	419.10	1.000	25.40	1.310	33.3	1.250	31.8	0.681	17.30	0.090	2.3
R-64	17.875	454.03	0.313	7.95	0.560	14.2	0.500	12.7	0.206	5.23	0.060	1.5
R-65	18.500	469.90	0.438	11.13	0.690	17.5	0.630	16.0	0.305	7.75	0.060	1.5
R-66	18.500	469.90	0.625	15.88	0.880	22.4	0.810	20.6	0.413	10.49	0.060	1.5
R-67	18.500	469.90	1.125	28.58	1.440	36.6	1.380	35.1	0.780	19.81	0.090	2.3
R-68	20.375	517.53	0.313	7.95	0.560	14.2	0.500	12.7	0.206	5.23	0.060	1.5
R-69	21.000	533.40	0.438	11.13	0.690	17.5	0.630	16.0	0.305	7.75	0.060	1.5
R-70	21.000	533.40	0.750	19.05	1.000	25.4	0.940	23.9	0.485	12.32	0.060	1.5
R-71	21.000	533.40	1.125	28.58	1.440	36.6	1.380	35.1	0.780	19.81	0.090	2.3
R-72	22.000	558.80	0.313	7.95	0.560	14.2	0.500	12.7	0.206	5.23	0.060	1.5
R-73	23.000	584.20	0.500	12.70	0.750	19.1	0.690	17.5	0.341	8.66	0.060	1.5
R-74	23.000	584.20	0.750	19.05	1.000	25.4	0.940	23.9	0.485	12.32	0.060	1.5
R-75	23.000	584.20	1.250	31.75	1.560	39.6	1.500	38.1	0.879	22.33	0.090	2.3
R-76	26.500	673.10	0.313	7.95	0.560	14.2	0.500	12.7	0.206	5.23	0.060	1.5
R-77	27.250	692.15	0.625	15.88	0.880	22.4	0.810	20.6	0.413	10.49	0.060	1.5
R-78	27.250	692.15	1.000	25.40	1.310	33.3	1.250	31.8	0.681	17.30	0.090	2.3
R-79	27.250	692.15	1.375	34.93	1.750	44.5	1.630	41.4	0.977	24.82	0.090	2.3
R-80	24.250	615.95	0.313	7.95	--	--	0.500	12.7	0.206	5.23	0.060	1.5
R-81	25.000	635.00	0.563	14.30	--	--	0.750	19.1	0.377	9.58	0.060	1.5
R-82	2.250	57.15	0.438	11.13	--	--	0.630	16.0	0.305	7.75	0.060	1.5
R-84	2.500	63.50	0.438	11.13	--	--	0.630	16.0	0.305	7.75	0.060	1.5
R-85	3.125	79.38	0.500	12.70	--	--	0.690	17.5	0.341	8.66	0.060	1.5
R-86	3.563	90.50	0.625	15.88	--	--	0.810	20.6	0.413	10.49	0.060	1.5
R-87	3.938	100.03	0.625	15.88	--	--	0.810	20.6	0.413	10.49	0.060	1.5
R-88	4.875	123.83	0.750	19.05	--	--	0.940	23.9	0.485	12.32	0.060	1.5
R-89	4.500	114.30	0.750	19.05	--	--	0.940	23.9	0.485	12.32	0.060	1.5
R-90	6.125	155.58	0.875	22.23	--	--	1.060	26.9	0.583	14.81	0.060	1.5
R-91	10.250	260.35	1.250	31.75	--	--	1.500	38.1	0.879	22.33	0.090	2.3
R-92	9.000	228.60	0.438	11.13	0.690	--	0.630	16.0	0.305	7.75	0.060	1.5
R-93	29.500	749.30	0.750	19.05	--	--	0.940	23.9	0.485	12.32	0.060	1.5
R-94	31.500	800.10	0.750	19.05	--	--	0.940	23.9	0.485	12.32	0.060	1.5
R-95	33.750	857.25	0.750	19.05	--	--	0.940	23.9	0.485	12.32	0.060	1.5
R-96	36.000	914.40	0.875	22.23	--	--	1.060	26.9	0.583	14.81	0.060	1.5
R-97	38.000	965.20	0.875	22.23	--	--	1.060	26.9	0.583	14.81	0.060	1.5
R-98	40.250	1022.35	0.875	22.23	--	--	1.060	26.9	0.583	14.81	0.060	1.5
R-99	9.250	234.95	0.438	11.13	--	--	0.630	16.0	0.305	7.75	0.060	1.5
R-100	29.500	749.30	1.125	28.58	--	--	1.380	35.1	0.780	19.81	0.090	2.3
R-101	31.500	800.10	1.250	31.75	--	--	1.500	38.1	0.879	22.33	0.090	2.3
R-102	33.750	857.25	1.250	31.75	--	--	1.500	38.1	0.879	22.33	0.090	2.3
R-103	36.000	914.40	1.250	31.75	--	--	1.500	38.1	0.879	22.33	0.090	2.3
R-104	38.000	965.20	1.375	34.93	--	--	1.630	41.4	0.977	24.82	0.090	2.3
R-105	40.250	1022.35	1.375	34.93	--	--	1.630	41.4	0.977	24.82	0.090	2.3

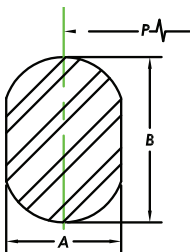

Oval

Tolerances:

P = average pitch diameter of ring, ±0.007" (±0.18 mm)

A = width of ring, ±0.008" (±0.20 mm)

B, H = height of ring, (+0.05", -0.02") (+1.3 mm, -0.5 mm) Variation in height throughout the entire circumference of any given ring shall not exceed 0.02" within these tolerances

C = width of flat on octagonal ring ±0.008" (±0.20 mm)

B1 = radius in ring, ±0.02" (±0.5 mm)

23 deg= angle, ±1/2 deg (±0 deg 30min)

RX RING DESIGNATIONS FOR API 6B FLANGES



RX ring gaskets are similar in shape to the standard octagonal ring joint gasket but their cross section is designed to take advantage of the contained fluid pressure in effecting a seal. They are made to API 6A and interchangeable with standard octagonal rings for oil field drilling and production applications in API 6B flanges. RX is used at pressures up to 5,000 psi (34.37 MPa). Standard sizes are stocked in low carbon steel, 304 and 316.

RX RING DESIGNATIONS FOR API 6B FLANGES

API Ring Number	Sizes of Flange (Inches)				Weight	
	2000 psi	2900 psi	3000 psi	5000 psi	lbs	Kg
RX 20	1 1/2	--	1 1/2	1 1/2	0.527	0.240
RX 23	2 1/16	--	--	--	1.150	0.523
RX 24	--	--	2 1/16	2 1/16	1.330	0.605
RX 26	2 9/16	--	--	--	1.420	0.645
RX 27	--	--	2 9/16	2 9/16	1.500	0.682
RX 31	3 1/8	--	3 1/8	--	1.730	0.786
RX 35	--	--	--	3 1/8	1.910	0.868
RX 37	4 1/16	--	4 1/16	--	2.090	0.950
RX 39	--	--	--	4 1/16	2.270	1.032
RX 41	5 1/8	--	5 1/8	--	2.540	1.155
RX 44	--	--	--	5 1/8	2.720	1.236
RX 45	7 1/16	--	7 1/16	--	2.960	1.345
RX 46	--	--	--	7 1/16	3.660	1.664
RX 47	--	--	--	8*	8.560	3.891
RX 49	9	--	9	--	3.790	1.723
RX 50	--	--	--	9	5.360	2.436
RX 53	11	--	11	--	4.560	2.073
RX 54	--	--	--	11	6.450	2.932
RX 57	13 5/8	--	13 5/8	--	5.360	2.436
RX 63	--	--	--	14	26.400	12.000
RX 65	16 3/4	--	--	--	6.630	3.014
RX 66	--	--	16 3/4	--	9.390	4.268
RX 69	18	--	--	--	7.520	3.418
RX 70	--	--	18	--	20.140	9.155
RX 73	21 1/4	--	--	--	11.630	5.286
RX 74	--	--	20 3/4	--	22.100	10.045
RX 82	--	1	--	--	0.790	0.359
RX 84	--	1 1/2	--	--	0.880	0.400
RX 85	--	2	--	--	0.880	0.400
RX 86	--	2 1/2	--	--	1.790	0.814
RX 87	--	3	--	--	1.980	0.900
RX 88	--	4	--	--	3.220	1.464
RX 89	--	3 1/2	--	--	2.980	1.355
RX 90	--	5	--	--	6.820	3.100
RX 91	--	10	--	--	17.100	7.773
RX 99	8*	--	8*	--	3.310	1.505
RX 201	--	--	--	--	0.250	0.114
RX 205	--	--	--	--	0.300	0.136
RX 210	--	--	--	--	0.750	0.341
RX 215	--	--	--	--	1.500	0.682

*Crossover Flange Connections

DIMENSIONS FOR TYPE RX RING GASKETS PER
ASME B16.20 AND API 6A

Ring Number	Pitch Diameter of Ring (P)		Width of Ring (A)		Width of Flat (C)		Height of Outside Bevel (D)		Height of Ring (H)		Radius of Ring (R1)		Hole Size (E)(1)	
	Inches	mm	Inches	mm	Inches	mm	Inches	mm	Inches	mm	Inches	mm	Inches	mm
RX-20	3.000	76.20	0.344	8.74	0.182	4.62	0.125	3.18	0.750	19.05	0.060	1.5	--	--
RX-23	3.672	93.27	0.469	11.91	0.254	6.45	0.167	4.24	1.000	25.40	0.060	1.5	--	--
RX-24	4.172	105.97	0.469	11.91	0.254	6.45	0.167	4.24	1.000	25.40	0.060	1.5	--	--
RX-25	4.313	109.55	0.344	8.74	0.182	4.62	0.125	3.18	0.750	19.05	0.060	1.5	--	--
RX-26	4.406	111.91	0.469	11.91	0.254	6.45	0.167	4.24	1.000	25.40	0.060	1.5	--	--
RX-27	4.656	118.26	0.469	11.91	0.254	6.45	0.167	4.24	1.000	25.40	0.060	1.5	--	--
RX-31	5.297	134.54	0.469	11.91	0.254	6.45	0.167	4.24	1.000	25.40	0.060	1.5	--	--
RX-35	5.797	147.24	0.469	11.91	0.254	6.45	0.167	4.24	1.000	25.40	0.060	1.5	--	--
RX-37	6.297	159.94	0.469	11.91	0.254	6.45	0.167	4.24	1.000	25.40	0.060	1.5	--	--
RX-39	6.797	172.64	0.469	11.91	0.254	6.45	0.167	4.24	1.000	25.40	0.060	1.5	--	--
RX-41	7.547	191.69	0.469	11.91	0.254	6.45	0.167	4.24	1.000	25.40	0.060	1.5	--	--
RX-44	8.047	204.39	0.469	11.91	0.254	6.45	0.167	4.24	1.000	25.40	0.060	1.5	--	--
RX-45	8.734	221.84	0.469	11.91	0.254	6.45	0.167	4.24	1.000	25.40	0.060	1.5	--	--
RX-46	8.750	222.25	0.531	13.49	0.263	6.68	0.188	4.78	1.125	28.58	0.060	1.5	--	--
RX-47	9.656	245.26	0.781	19.84	0.407	10.34	0.271	6.88	1.625	41.28	0.090	2.3	--	--
RX-49	11.047	280.59	0.469	11.91	0.254	6.45	0.167	4.24	1.000	25.40	0.060	1.5	--	--
RX-50	11.156	283.36	0.656	16.66	0.335	8.51	0.208	5.28	1.250	31.75	0.060	1.5	--	--
RX-53	13.172	334.57	0.469	11.91	0.254	6.45	0.167	4.24	1.000	25.40	0.060	1.5	--	--
RX-54	13.281	337.34	0.656	16.66	0.335	8.51	0.208	5.28	1.250	31.75	0.060	1.5	--	--
RX-57	15.422	391.72	0.469	11.91	0.254	6.45	0.167	4.24	1.000	25.40	0.060	1.5	--	--
RX-63	17.391	441.73	1.063	27.00	0.582	14.78	0.333	8.46	2.000	50.80	0.090	2.3	--	--
RX-65	18.922	480.62	0.469	11.91	0.254	6.45	0.167	4.24	1.000	25.40	0.060	1.5	--	--
RX-66	18.031	457.99	0.656	16.66	0.335	8.51	0.208	5.28	1.250	31.75	0.060	1.5	--	--
RX-69	21.422	544.12	0.469	11.91	0.254	6.45	0.167	4.24	1.000	25.40	0.060	1.5	--	--
RX-70	21.656	550.06	0.781	19.84	0.407	10.34	0.271	6.88	1.625	41.28	0.090	2.3	--	--
RX-73	23.469	596.11	0.531	13.49	0.263	6.68	0.208	5.28	1.250	31.75	0.060	1.5	--	--
RX-74	23.656	600.86	0.781	19.84	0.407	10.34	0.271	6.88	1.625	41.28	0.090	2.3	--	--
RX-82	2.672	67.87	0.469	11.91	0.254	6.45	0.167	4.24	1.000	25.40	0.060	1.5	0.060	1.5
RX-84	2.922	74.22	0.469	11.91	0.254	6.45	0.167	4.24	1.000	25.40	0.060	1.5	0.060	1.5
RX-85	3.547	90.09	0.531	13.49	0.263	6.68	0.167	4.24	1.000	25.40	0.060	1.5	0.060	1.5
RX-86	4.078	103.58	0.594	15.09	0.335	8.51	0.188	4.78	1.125	28.58	0.060	1.5	0.090	2.3
RX-87	4.453	113.11	0.594	15.09	0.335	8.51	0.188	4.78	1.125	28.58	0.060	1.5	0.090	2.3
RX-88	5.484	139.29	0.688	17.48	0.407	10.34	0.208	5.28	1.250	31.75	0.060	1.5	0.120	3.0
RX-89	5.109	129.77	0.719	18.26	0.407	10.34	0.208	5.28	1.250	31.75	0.060	1.5	0.120	3.0
RX-90	6.875	174.63	0.781	19.84	0.479	12.17	0.292	7.42	1.750	44.45	0.090	2.3	0.120	3.0
RX-91	11.297	286.94	1.188	30.18	0.780	19.81	0.297	7.54	1.781	45.24	0.090	2.3	0.120	3.0
RX-99	9.672	245.67	0.469	11.91	0.254	6.45	0.167	4.24	1.000	25.40	0.060	1.5	--	--
RX-201	2.026	51.46	0.226	5.74	0.126	3.20	0.057	1.45	0.445	11.30	0.02 (3)	0.5 (3)	--	--
RX-205	2.453	62.31	0.219	5.56	0.12	3.05	0.072 (2)	1.83 (2)	0.437	11.10	0.02 (3)	0.5 (3)	--	--
RX-210	3.844	97.64	0.375	9.53	0.231	5.87	0.125 (2)	3.18 (2)	0.750	19.05	0.03 (3)	0.8 (3)	--	--
RX-215	5.547	140.89	0.469	11.91	0.21	5.33	0.167 (2)	4.24 (2)	1.000	25.40	0.06 (3)	1.5 (3)	--	--

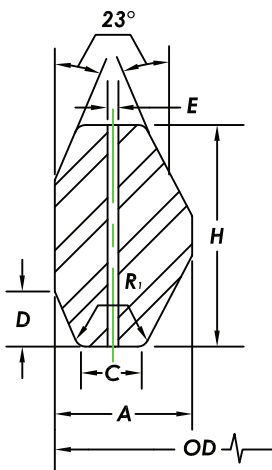

Note:

- (1) Rings RX-82 through RX-91 only require one pressure passage hole as illustrated. The Center line of the hole shall be located at the midpoint of dimension C.
- (2) Tolerance on these dimensions is (+0, -0.015") (+0 mm, -0.38 mm).
- (3) Tolerance on these dimensions is (+0.02", -0) (+0.5 mm, -0 mm)

Tolerances:

- OD** = outside diameter of ring, +0.020", -0 (+0.51 mm, -0 mm)
- A** = width of ring, +0.008", -0 (+0.20 mm, -0 mm) variation in width throughout the entire circumference of any ring shall not exceed 0.004" (0.10 mm) within these tolerances.
- C** = width of flat, +0.006", -0 (+0.15 mm, -0 mm)
- D** = height of outside bevel, +0, -0.03" (+0 mm, -0.76 mm)
- H** = height of ring, +0.008", -0 (+0.20 mm, -0 mm) variation in height throughout the entire circumference of any ring shall not exceed 0.004" (0.10 mm) within these tolerances.
- R1** = radius of ring, ±0.02" (±0.5 mm)
- E** = hole size, ±0.02" (±0.5 mm)
- 23 deg = angle, ±1/2 deg (±0 deg 30 min)

GASKET SELECTION



BX RING DESIGNATIONS FOR API 6BX FLANGES

The BX ring gasket differs from the standard oval or octagonal shape since it is square in cross section and tapers in each corner. They can only be used in API 6BX flanges. BX is used at pressures up to 20,000 psi (137.90 MPa). Standard sizes are stocked in low carbon steel, 304 and 316.

BX RING DESIGNATIONS FOR API 6BX FLANGES

API Ring Number	Nominal Flange Bore (Inches)						Weight	
	2000 psi	3000 psi	5000 psi	10000 psi	15000 psi	20000 psi	lbs	Kg
BX 150	--	--	--	1 11/16	1 11/16		0.295	0.134
BX 151	--	--	--	1 13/16	1 13/16	1 13/16	0.337	0.153
BX 152	--	--	--	2 1/16	2 1/16	2 1/16	0.425	0.193
BX 153	--	--	--	2 9/16	2 9/16	2 9/16	0.632	0.287
BX 154	--	--	--	3 1/16	3 1/16	3 1/16	0.875	0.398
BX 155	--	--	--	4 1/16	4 1/16	4 1/16	1.220	0.555
BX 156	--	--	--	7 1/16	7 1/16	7 1/16	4.140	1.882
BX 157	--	--	--	9	9	9	6.550	2.977
BX 158	--	--	--	11	11	11	9.600	4.364
BX 159	--	--	--	13 5/8	13 5/8	13 5/8	14.410	6.550
BX 160	--	--	13 5/8	--	--	--	6.750	3.068
BX 161	--	--	--	--	--	--	10.437	4.744
BX 162	--	--	16 3/4	16 3/4	--	--	4.375	1.989
BX 163	--	--	18 3/4	--	--	--	14.375	6.534
BX 164	--	--	--	18 3/4	18 3/4	--	21.000	9.545
BX 165	--	--	21 1/4	--	--	--	18.375	8.352
BX 166	--	--	--	21 1/4	--	--	27.500	12.500
BX 167	26 3/4	--	--	--	--	--	18.000	8.182
BX 168	--	26 3/4	--	--	--	--	24.500	11.136
BX 169	--	--	--	5 1/8	5 1/8	--	--	--
BX 303	30	30	--	--	--	--	--	--

Additional Sizes	
Ring Number	Nominal Size
BX 170	6 5/8
BX 171	8 9/16
BX 172	11 5/32

DIMENSIONS FOR TYPE BX RING GASKETS
TO SUIT ASME B16.20 AND API 6A

GASKET SELECTION

Ring Number	Nominal Size		Outside Diameter of Ring (OD)		Height of Ring, H		Width of Ring, A		Outside Diameter of Flat ODT		Width of Flat, C		Hole Size, D (1)	
	Inches	mm	Inches	mm	Inches	mm	Inches	mm	Inches	mm	Inches	mm	Inches	mm
BX-150	1 11/16	43	2.842	72.19	0.366	9.30	0.366	9.30	2.790	70.87	0.314	7.98	0.060	1.5
BX-151	1 13/16	46	3.008	76.40	0.379	9.63	0.379	9.63	2.954	75.03	0.325	8.26	0.060	1.5
BX-152	2 1/16	52	3.334	84.68	0.403	10.24	0.403	10.24	3.277	83.24	0.346	8.79	0.060	1.5
BX-153	2 9/16	65	3.974	100.94	0.448	11.38	0.448	11.38	3.910	99.31	0.385	9.78	0.060	1.5
BX-154	3 1/16	78	4.600	116.84	0.488	12.40	0.488	12.40	4.531	115.09	0.419	10.64	0.060	1.5
BX-155	4 1/16	103	5.825	147.96	0.560	14.22	0.560	14.22	5.746	145.95	0.481	12.22	0.060	1.5
BX-156	7 1/16	179	9.367	237.92	0.733	18.62	0.733	18.62	9.263	235.28	0.629	15.98	0.120	3.0
BX-157	9	229	11.593	294.46	0.826	20.98	0.826	20.98	11.476	291.49	0.709	18.01	0.120	3.0
BX-158	11	279	13.860	352.04	0.911	23.14	0.911	23.14	13.731	348.77	0.782	19.86	0.120	3.0
BX-159	13 5/8	346	16.800	426.72	1.012	25.70	1.012	25.70	16.657	423.09	0.869	22.07	0.120	3.0
BX-160	13 5/8	346	15.850	402.59	0.938	23.83	0.541	13.74	15.717	399.21	0.408	10.36	0.120	3.0
BX-161	16 5/8	422	19.347	491.41	1.105	28.07	0.638	16.21	19.191	487.45	0.482	12.24	0.120	3.0
BX-162	16 5/8	422	18.720	475.49	0.560	14.22	0.560	14.22	18.641	473.48	0.481	12.22	0.060	1.5
BX-163	18 3/4	476	21.896	556.16	1.185	30.10	0.684	17.37	21.728	551.89	0.516	13.11	0.120	3.0
BX-164	18 3/4	476	22.463	570.56	1.185	30.10	0.968	24.59	22.295	566.29	0.800	20.32	0.120	3.0
BX-165	21 1/4	540	24.595	624.71	1.261	32.03	0.728	18.49	24.417	620.19	0.550	13.97	0.120	3.0
BX-166	21 1/4	540	25.198	640.03	1.261	32.03	1.029	26.14	25.020	635.51	0.851	21.62	0.120	3.0
BX-167	26 3/4	679	29.896	759.36	1.412	35.86	0.516	13.11	29.696	754.28	0.316	8.03	0.060	1.5
BX-168	26 3/4	679	30.128	765.25	1.412	35.86	0.632	16.05	29.928	760.17	0.432	10.97	0.060	1.5
BX-169	5 1/8	130	6.831	173.51	0.624	15.85	0.509	12.93	6.743	171.27	0.421	10.69	0.060	1.5
BX-170	6 5/8	168	8.584	218.03	0.560	14.22	0.560	14.22	8.505	216.03	0.481	12.22	0.060	1.5
BX-171	8 9/16	217	10.529	267.44	0.560	14.22	0.560	14.22	10.450	265.43	0.481	12.22	0.060	1.5
BX-172	11 5/32	283	13.113	333.07	0.560	14.22	0.560	14.22	13.034	331.06	0.481	12.22	0.060	1.5
BX-303	30	762	33.573	852.75	1.494	37.95	0.668	16.97	33.361	847.37	0.457	11.61	0.060	1.5

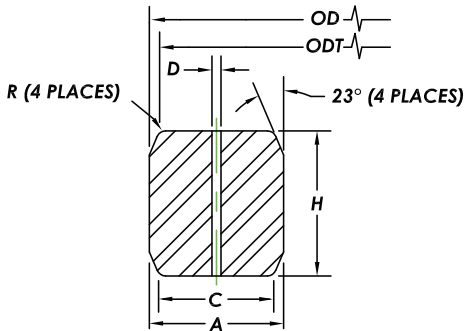

General Notes:

(a) Radius R shall be 8% to 12% of the gasket height H

Note:

(1) One pressure passage hole is required per gasket as illustrated. The center line of the hole shall be located at the midpoint of dimension C.

Tolerances:

OD = outside diameter of ring (+0, -0.005") (+0.00, -0.15 mm)

H = height of ring (+0.008", -0) (+0.20 mm, -0.00) Variation in height throughout the entire circumference of any ring shall not exceed (0.004") (0.10 mm) within these tolerances.

A = width of ring (+0.008", -0) (+0.20 mm, -0) Variation in width throughout the entire circumference of any ring shall not exceed (0.004") (0.10 mm) within these tolerances.

ODT = outside diameter of flat (±0.002") (±0.05 mm)

C = width of flat (+0.006", -0) (+0.15 mm, -0.00)

D = hole size (±0.02") (±0.5 mm)

R = radius of ring, see general note (b)

23 deg = angle, ±1/4 deg (±0 deg 150 min)

SRX AND SBX RING GASKETS

Type SRX and SBX gaskets per API 17D for Subsea Wellhead and Tree Equipment are vented to prevent pressure lock when connections are made up underwater. They have identical measurements to RX and BX ring gaskets with the same number designation, and they will fit the same corresponding connectors. The "S" indicates these gaskets have cross-drilled holes, as fluid entrapment in the ring groove can interfere with proper make up underwater (subsea). With the vent hole, any water trapped between a ring groove bottom and the sealing area of the gasket can escape to the equipment I.D. bore. Material per spec is defined as a corrosion resistant alloy.

SBX ring gaskets can be manufactured in two options for drilling the pressure passage holes as shown below.

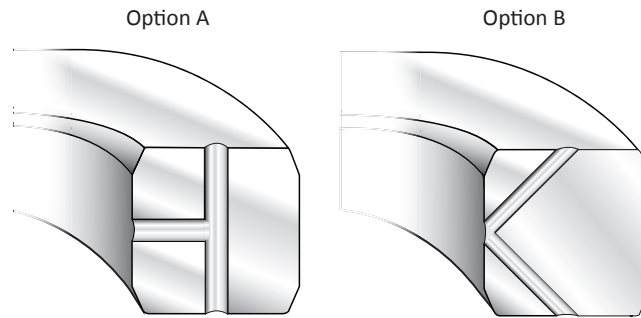

The purpose of these two pressure passage holes is to prevent pressure lock when connections are made up underwater.

MARKINGS FOR STANDARD RING TYPE JOINT GASKETS

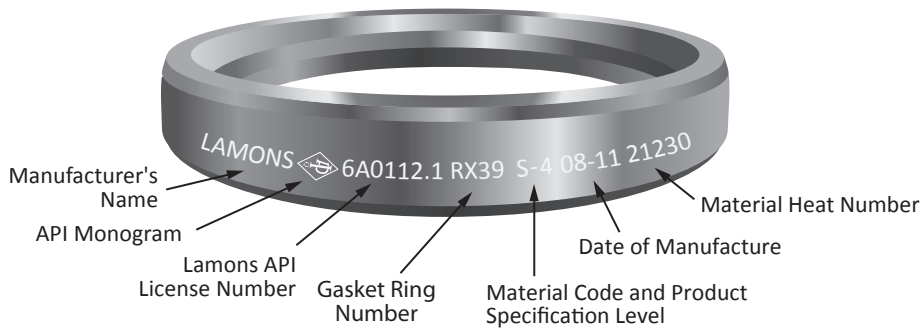

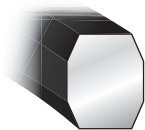

STYLE 377R (RUBBER COATED RINGS)

Style 377R is a rubber coated oval ring gasket (usually steel) used in pressure testing to minimize damage to flanges. The rubber contact points provide additional seals while protecting the flange surfaces.



STYLE 377T (TRANSITION RINGS)

Style 377T, combination rings combine two different sizes having the same pitch diameter permitting bolt up of differing size flanges.



BRIDGEMAN (STYLE 393)

The Bridgeman gasket is a pressure activated gasket for use on pressure vessel heads and valve bonnets for pressures of 1500 psi (10 MPa) and above. The cross section of the gasket is such that internal pressure acting against the ring forces it against the containing surface making a self-energized seal. Bridgeman gaskets are frequently silver plated or lead plated to provide a softer surface and minimize the force required to flow the gasket metal into the flange surface.



DELTA (STYLE 392)

A delta gasket is a pressure actuated gasket used primarily on pressure vessels and valve bonnets at very high pressures in excess of 5000 psi (34 MPa). As with the lens gasket, complete drawings and material specifications must be supplied. Internal pressure forces the gasket material to expand when the pressure forces tend to separate the flanges. Extremely smooth surface finishes of 63 micro inches or smoother are required when using this type of gasket.



LENS (STYLE 394)

A lens type gasket is a line contact seal for use in high pressure piping systems and in pressure vessel heads. The lens cross section is a spherical gasket surface and requires special machining on the flanges. These gaskets will seat with a small bolt load since the contact area is very small and gasket seating pressures are very high. Normally the gasket materials should be softer than the flange. In ordering lens gaskets, complete drawings and material specifications must be supplied.

DIMENSIONS FOR LENS RINGS PER DIN 2696
(MILLIMETERS)

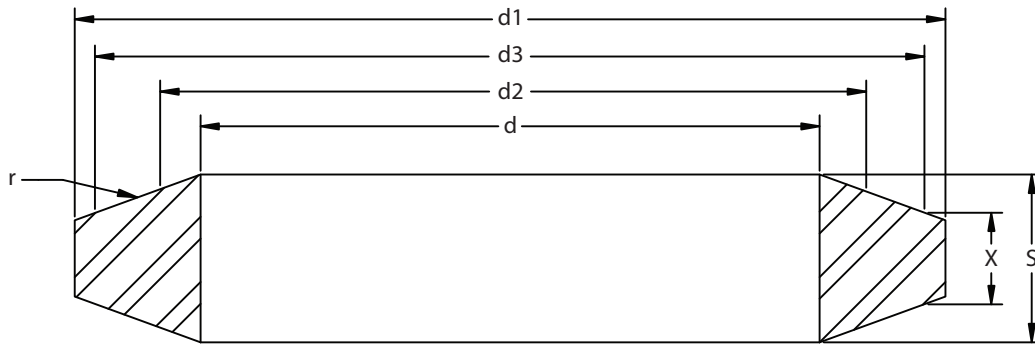

Nominal Pipe Size (DN)	d		d1	S for d Max	d2 Middle Contact Diameter	r	d3	X
	min.	max.						
Nominal Pressure PN64-400								
10	10	14	21	7	17.1	25	18	5.7
15	14	18	28	805	22	32	27	6
25	20	29	43	11	34	50	39	6
40	34	43	62	14	48	70	55	8
50	46	55	78	16	60	88	68	9
65	62	70	102	20	76.6	112	85	13
80	72	82	116	22	88.2	129	97	13
100	94	108	143	26	116	170	127	15
125	116	135	180	29	149	218	157	22
150	139	158	210	33	171	250	183	26
Nominal Pressure PN64-100								
*175	176	183	243	31	202.5	296	218	28
200	198	206	276	35	225	329	243	27
250	246	257	332	37	277.7	406	298	25
300	295	305	385	40	323.5	473	345	26
350	330	348	425	41	368	538	394	23
400	385	395	475	42	417.2	610	445	24
Nominal Pressure PN160-400								
*175	162	177	243	37	202.5	296	218	21
200	183	200	276	40	225	329	243	25
250	230	246	332	46	277.7	406	298	25
300	278	285	385	50	323.5	473	345	30

*Avoid using these Nominal Pipe Sizes

KAMMPRO® RING TYPE JOINT (RTJ) GASKETS

KAMMPRO-ORJ

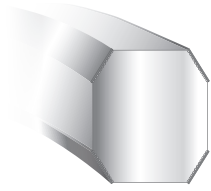

The Kammpro-ORJ is constructed to the standard octagonal API 6A or ASME B16.20 dimensions with the addition of the Kammpro design applied to the sealing areas and faced with oxidation resistant flexible graphite. This design is ideal for applications where cracking or embrittlement has been experienced in the ring joint groove. It is available in a large variety of metal material and can be fabricated as custom engineered designs. Special or custom sizing options are also available.

KAMM-PEG



Kamm-PEG represents a Pressure Energized Gasket with Kammprofiled sealing surfaces, where a RX type ring is typically used for high pressure reactors. Frequently, custom ring are used in the top and bottom of hydro processing reactors. To greatly enhance sealing ability, top and bottom OD angled sealing gasket surfaces are serrated per Kammprofiled specifications and faced with oxidation inhibited flexible graphite. It has the benefits of under compression graphite flows into minor imperfections creating higher seal tightness.

KAMMPRO ADAPTER (RTJ TO RF)

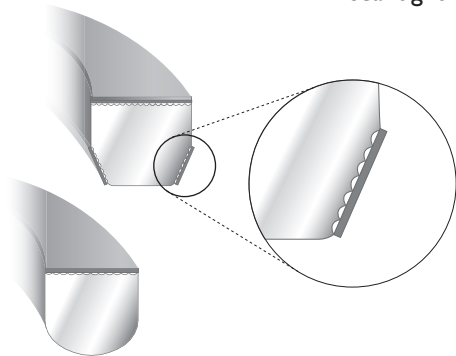

Kammpro-Adapter gaskets allow for ring type joint flanges to be mated up to raised face flanges, utilizing the strengths of the full metallic with the added benefit of kammprofiled sealing surfaces laminated with flexible graphite. Provided the pitch of the groove is sufficiently located under the raised face, this design is among the most robust of adapter styles.

SPECIALTY MACHINED PRODUCTS

Lamons maintains a high capacity of programable mill and lathe capability for custom machine work on most any specialty component. As a leading manufacturer of custom machined products for the refining, petrochemical and industrial markets, Lamons recognizes the quality and service levels these industries require. We have over 30 state of the art CNC machines operated by programmers and machinists to deliver high quality machined components with the quickest response time in the industry.

From a sample, drawing or CAD file, Lamons can program and manufacture/machine custom parts with the highest precision and repeatability within 0.0005" (0.013 mm).

Specialty rings and industrial machined components can be rapidly produced to exact dimensions and to customer specification. Lamons stocks the most extensive inventory of centrifugal castings, forgings and plate in the industry allowing us to respond quickly to most any customer need. From small machined components to rings over 6 feet (1800 mm), Lamons has the capacity and turning capability to deliver most any configuration of heavy cross sectioned components.



SECTION FOUR: ISOLATION GASKETS AND FLANGE ISOLATION KITS

DEFENDER™ SEALING/ISOLATING GASKETS AND FLANGE ISOLATION KITS

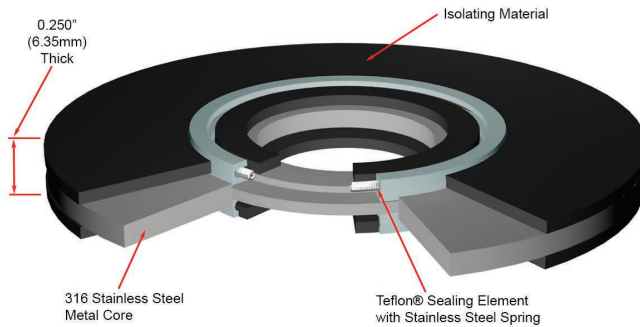

The DEFENDER™ sealing/isolating gasket system is designed for critical/extreme applications. Manufactured with a 316 stainless steel core retainer and laminated on both sides with high strength laminates, the DEFENDER™ gasket is resistant to deforming under load and is used when electrical isolation and corrosion control are required on pipes containing gas, natural gas, oil and other hydrocarbon based medias up to 392°F (200°C).

Available for flat face, raised face and ring type joint flanges from 1/2” to 48” (including corresponding API and DN diameters), ANSI 150-

2500#, API 2-10K and PN20-PN420, the DEFENDER™ gasket is an engineered solution for trouble-free operation that eliminates costly leaks and provides a solution for fugitive emissions.

Manufactured with an innovative industry first Press-n-Lock™ “Glue-Less Seal & Groove Technology” that combines a press-in, pressure activated and spring energized seal with a unique groove that retains the seal element without the use of glue on key contact surfaces! The Press-n-Lock™ feature provides a higher confidence in sealing.

GENERAL FEATURES

- Seals/isolates pressure ratings through ANSI 2500#, API 10K and PN420 service.
- Spring energized seal element.
- Press-n-Lock™ “Glue-Less Seal Groove Technology”.
- Inconel and Super Duplex Steel Cores available upon request.

APPLICATIONS

- DEFENDER™ gaskets were engineered for extreme, high reliability sealing and electrical isolation critical service applications.
- High Pressure Flanges: Up To 2500#, API 10K or PN420.
- Critical/Extreme Service
- High pH Service.
- H₂S/CO₂ Service.
- Locations where end users prefer an integral seal element.

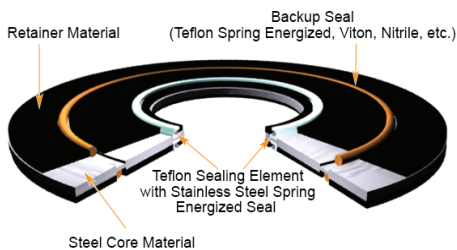

The DEFENDER™ Tandem Sealing/Isolation Gaskets utilizes Tandem Seal Configuration (two seals per gasket face) for subsea applications. The backup Viton O-ring Seals are bidirectional and can thus stop external pressure from the sea water while the Spring Energized PTFE main seal stops in the internal pipe pressure.

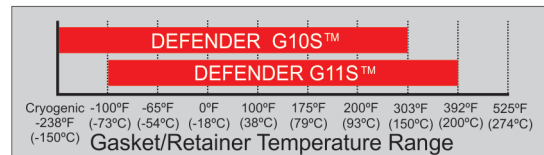
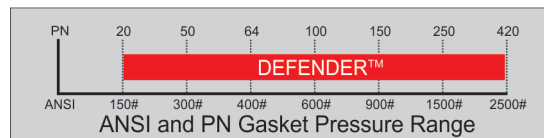
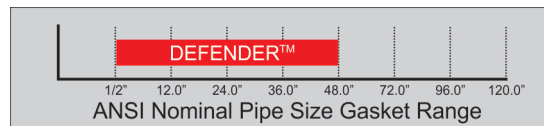

For applications outside ranges shown, consult factory.

DEFENDER™ (CONT.)

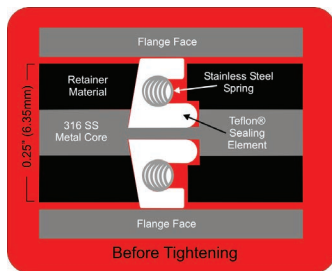

BEFORE TIGHTENING

The flange face makes initial contact with the sealing element which protrudes above the gasket retainer surface (isolation material) laminated on both sides of the stainless steel core.

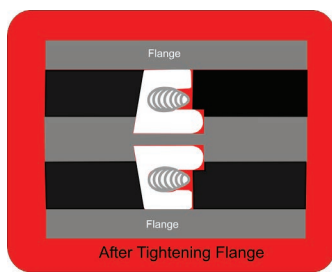

AFTER TIGHTENING

The Spring Energized, Pressure Activated Sealing System is initiated. The base of the Teflon® seal is contained within the stainless steel core to provide superior sealing strength for critical/extreme sealing applications. The spring prevents over-compression of the Teflon® seal thereby allowing the pressure of the media within the pipe to activate the seal.

G10 or G11, laminated on both sides, provides the dielectric strength needed to isolate the flanged application and has the compressive strength to easily withstand high bolt loads.

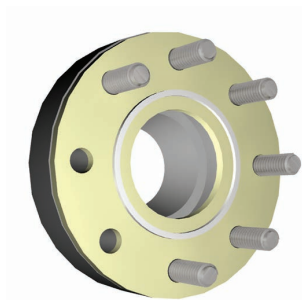

TYPE "E" GASKET

Fits over the bolt holes and extends to the O.D. of the flange to assist contractors as the bolt holes automatically center the gasket. Provides excellent protection against shorting out of the corrosion mitigation hardware.

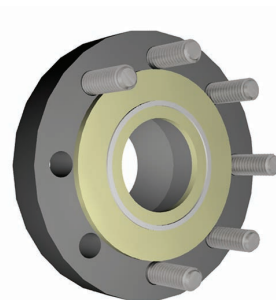

TYPE "F" GASKET

Fits within the bolt hole circle of the flange and extends to the I.D. of the bolt circle providing good protection against shorting out of the corrosion mitigation hardware.

FACTS

- Proven design based on the industry leader.
- Enhanced with innovative engineered features.
- Tested to Shell Certification Standards.
- Industry First! The Press-n-Lock™ “glueless seal & groove technology, an engineered design, has significant sealing advantages versus other brands.”
- Made in the U.S.A.
- Energy Applications.
- For critical sealing/isolating applications.
- Optimized sealing/isolating characteristics for high performance and longevity in critical applications.

DEFENDER™ (CONT.)

Type "F" Gasket Shown, Type "E" Gaskets are Also Available
Double Washer Set Shown, Single Washer Sets Also Available

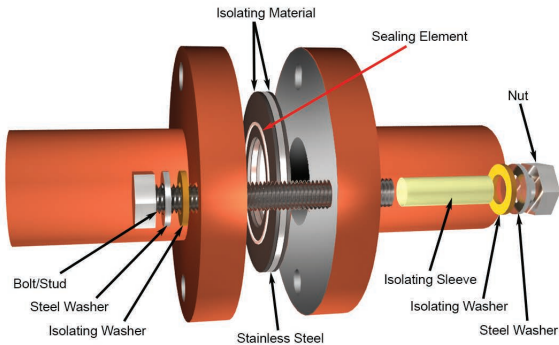

INDUSTRIES (OIL, GAS)

Production Fields, Petroleum Marketing Facilities, LNG/SNG Systems, Pipeline and Distribution Piping, Refineries.

DEFENDER™ FLANGE ISOLATION KITS

For a flange isolation kit, sleeves and washers are needed. Generally, 95% of steel core gasket flange isolation kits (DEFENDER™ Kits) are sold with G10 sleeves and G10 double washer sets.

SUGGESTED SLEEVE/WASHER SET

SD = Standard (G10 Sleeves, Steel ZP Washers and G10 Washers) - Double Washer Set.

RETAINER MATERIAL (G10S, G11S)

- 1/4" (.250") total thickness
- Metal Core .120" thick - 316SS
- Laminate .065" per side

GASKET/RETAINER MATERIAL SPECIFICATIONS

ASTM	TEST METHOD	G10	G11
D149	Dielectric Strength Volts/Mil Short Time	750-800	550
D695	Compressive Strength (psi)	65,000	63,000
D570	Water Absorption (%)	0.05	0.10
D790	Flexural Strength (psi)	65,000	60,000
D256	IZOD Impact Strength (Ft-Lbs/Inch)	14.00	12.00
D638	Tensile Strength (psi)	50,000	42,000
D732	Shear Strength (psi)	21,000	21,000
D952	Bond Strength (lb)	2,600	2,200
	Temperature - Operating	Cryogenic -238°F (-150°C) to +302°F (+150°C)	-100°F (-73°C) to +392°F (+200°C)

Note: Operating Temperature for Gaskets and Flange Isolation Kits is based off the Gasket Retainer Temperature. Seal element temperature does not dictate the min. and max. gasket operating temperature.

SEAL ELEMENT MATERIALS

- PTFE (Teflon®) Spring Energized. Spring is Stainless Steel
- Nitrile
- Viton®

SEALING ELEMENT MATERIAL SPECIFICATIONS

Sealing Element	Temperature - Operating
Teflon® (PTFE)	Cryogenic to +525°F (+274°C)
Nitrile	-40°F (-40°C) to +250°F (+121°C)
Viton®	-20°F (-29°C) to +392°F to (+200°C)

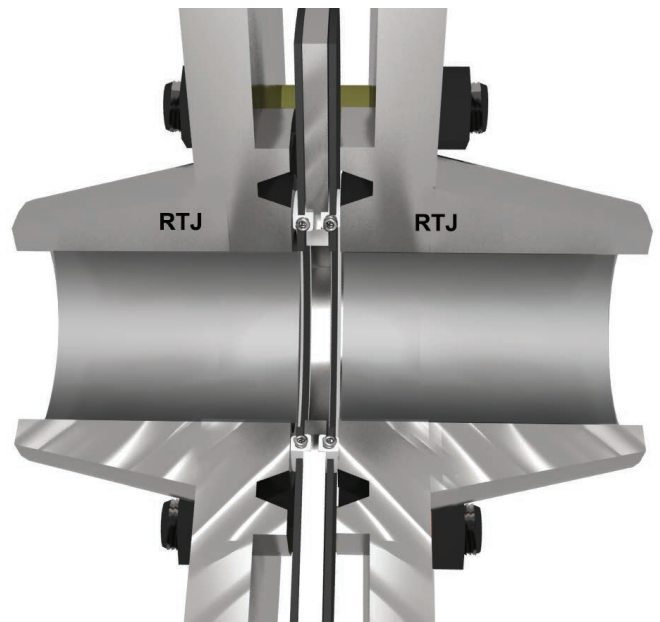
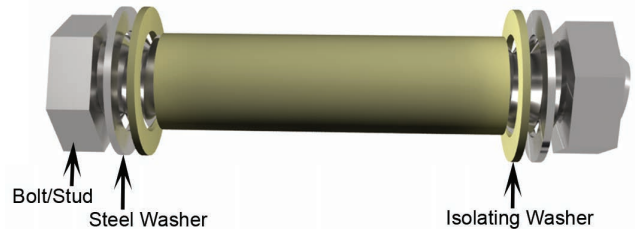

DEFENDER™ Sealing/Isolation Gaskets are suggested for RTJ Applications vs. Phenolic Ring Type Gaskets.

DEFENDER FS™

SEALING/ISOLATING GASKETS AND FLANGE ISOLATION KITS

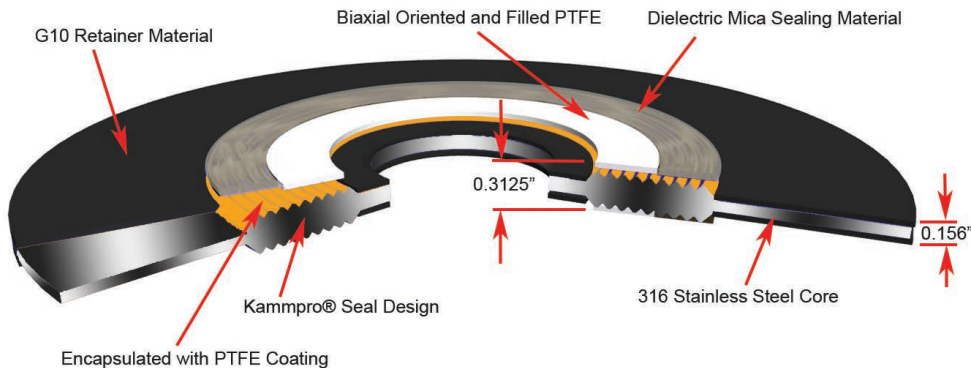

The DEFENDER FS™ sealing/isolating gasket is designed to withstand the rigorous API standard 6FB (Third Edition) test and therefore provides a solution for those who want to electrically isolate their flange while also requiring protection against the introduction of fire in and around the flange.

The objective of the test is to monitor the total leakage for the duration of the burn/cool-down cycle and during re-pressurization. Leakage was determined by the total water level drop through a visual sight gauge during the burn/cool-down cycles, by manually catching the water in a calibrated container during re-pressurization. The results concluded that the Defender FS™ Gasket was able to maintain its fire safe characteristics throughout the entirety of the test. During the 30 minute burn and 30 minute cool down period, the measured leakage was 0 ml/min versus the allowable rate of 22.765 ml/min. The leakage rate during the re-pressurization cycle was 5 ml/min versus the allowable rate of 22.765 ml/min.

Based on years of technological experience, the DEFENDER FS™ sealing/isolating gasket not only meets but exceeds the pressure-containing capabilities in standard 6FB (Third Edition) as outlined by API.

GENERAL FEATURES

- Tested and Certified to API 6FB (Third Edition).
- Two integral robust sealing elements for sealing and isolating in an engineered Fire Safe design.
- Serves as a sealing/isolation for Fire Safe Applications.
- Incorporates industry proven Kammpro® sealing technology.
- Patent pending design.
- Inconel and Super Duplex Steel Cores available upon request.

APPLICATIONS

DEFENDER FS™ gaskets were engineered for Fire Safe, extreme, high reliability sealing and electrical isolation critical service applications

- High Pressure Flanges: 2500#, API 10K or PN420.
- Critical/Extreme service
- High Ph service.
- H₂S/CO₂ service.
- Locations where end users prefer an integral seal element and when highly volatile fluids are present.

SIZES

- 1/2" through 48" diameter.
- Available as "E" or "F" Type Gaskets.

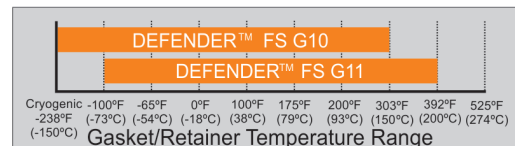
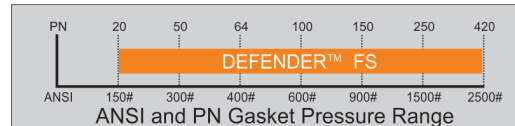
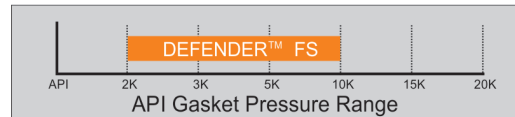
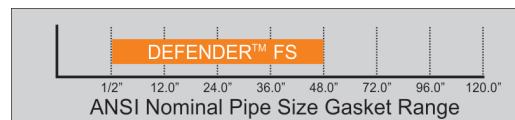

For applications outside ranges shown, consult factory.

DEFENDER FS™ (CONT.)

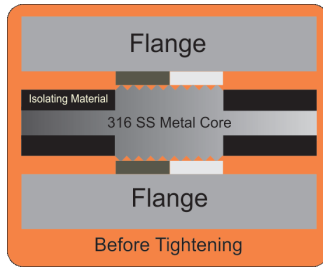

BEFORE TIGHTENING

The flange face makes initial contact with the sealing elements which protrude above the gasket retainer surface (isolation material) laminated on both sides of the stainless steel core.

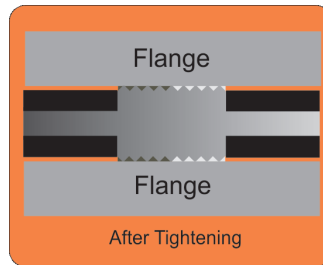

AFTER TIGHTENING

The sealing elements are compressed into the serrations of the stainless steel retainer.



TYPE "E" GASKET

Fits over the bolt holes and extends to the O.D. of the flange to assist contractors as the bolt holes automatically center the gasket. Provides excellent protection against shorting out of the corrosion mitigation hardware.



TYPE "F" GASKET

Fits within the bolt hole circle of the flange and extends to the I.D. of the bolt circle providing good protection against shorting out of the corrosion mitigation hardware.

FACTS

- Energy applications.
- For critical sealing/isolating applications.
- Optimized sealing/isolating characteristics for high performance and longevity in critical applications.
- Engineered for extreme, high reliability sealing and electrical isolation critical service applications.
- Fire Safe product that allows a work force at production facilities and offshore platforms extra time to prevent devastation and harm.
- Seconds count when valves and flanged applications need to be shut down in emergency situations.

DEFENDER FS™ (CONT.)

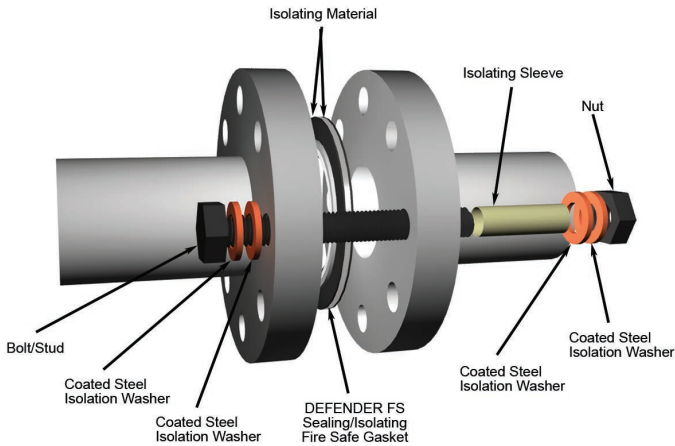

GASKET/RETAINER MATERIAL SPECIFICATIONS RETAINER MATERIAL (G10S6, G11S6)

- 0.3125" (7.94mm) total thickness
- Metal Core .1/4" (.250"- 6.35mm) thick - 316SS
- Laminate .032" (0.812mm) per side

ASTM	TEST METHOD	G10	G11
D149	Dielectric Strength Volts/Mil Short Time	750-800	550
D695	Compressive Strength (psi)	65,000	63,000
D570	Water Absorption (%)	0.05	0.10
D790	Flexural Strength (psi)	65,000	60,000
D256	IZOD Impact Strength (Ft-Lbs/Inch)	14.00	12.00
D638	Tensile Strength (psi)	50,000	42,000
D732	Shear Strength (psi)	21,000	21,000
D952	Bond Strength (lb)	2,600	2,200
	Temperature - Operating	Cryogenic -238°F (-150°C) to +302°F (+150°C)	-100°F (-73°C) to +392°F (+200°C)

NOTE: Operating Temperature for Gaskets and Flange Isolation Kits is based off the Gasket Retainer Temperature. Seal element temperature does not dictate the Min. and max. gasket operating temperature.

Performance suitability and material compatibility shall be determined by the user. The DEFENDER FS™ is an engineered fire safe gasket that has passed API 6FB fire test (Third Edition). No other claims regarding suitability/compatibility for a particular application or performance in a fire are made.

SEAL ELEMENT MATERIALS

Sealing Element	Temperature - Operating
Mica (Hi-Temp)	+1,832°F. (+1,000°C.)
Biaxial Oriented PTFE	-450°F (-268°C) to +500°F (+260°C)
Kammprofile PTFE Coating	-58°F (-50°C) to +350°F to (+176°C)

INDUSTRIES (OIL, GAS, OFFSHORE)

Production fields, petroleum marketing facilities, LNG/SNG systems, pipeline and distribution piping, refineries, tank farms, offshore platforms.

DEFENDER FS™ FLANGE ISOLATION KITS

For a flange isolation kit, sleeves and washers are needed. Generally, 95% of steel core flange isolation kits are sold with G10 sleeves and Coated Steel Isolation Washers.

SUGGESTED SLEEVE AND WASHER SET

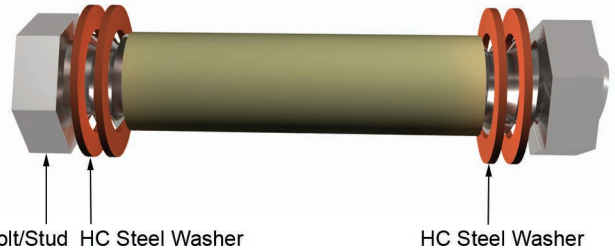

FD = G10 Sleeves, Steel HC Washers and Steel HC Washers - Double Washer Set

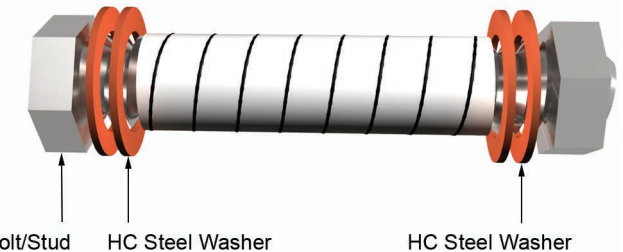

TFD = Nomex Sleeves, Steel HC Washers and Steel HC Washers - Double Washer Set

DEFENDER FS™ (CONT.)

We have requested that United Valve Inc. of Houston, Texas test and evaluate the Lamons 6" #300 Class Defender FS™ Gasket's pressure containing capabilities the API standard 6FB (Third Edition, Nov. 1998, Non bending, On shore or Open Offshore Fire Test). The test involved of affixing the gasket between two flanges and fitting the flanges to United's test setup. The gasket was then subject to burn cycle at an average flame temperature between 1400°F and 1800°F for 30 minutes while maintaining 555 psi. Upon completion of the burn, the pressure was then held during a 30 minute cool down to a temperature below 212°F. The gasket was depressurized and then pressurized back to 555psi and held for an additional 5 min.

The objective of the test was to monitor the total leakage during the duration of the burn/cool down cycle, along with the repressurization cycle with accordance to API 6FB standards.

Leakage was determined by the total water level drop through a visual sight gauge during the burn/cool down cycles, and then by manually catching the water in a calibrated container during the repressurization cycle.

TEST PROCEDURE:

Below is a summary of the test setup and protocol performed during the gasket fire test with accordance to API 6FB, Third Edition Non Bending, On shore or Open Offshore Fire Test.

1. Install the Defender FS™ gasket between two CS flanges.
2. Bolt the flanges together using the supplied B7 Studs, 2H Nuts, Dielectric Sleeves, and Coated Steel Washers
3. Apply non conductive PTFE lubricant to studs/bolts and torque to 225 ft. lbs.
4. Thread NPT pipe fittings into flanges and affix the flange package in the test setup.
5. Connect all pressure and temperature monitoring equipment in their correct positions. This consists of 2 flame thermocouples, 3 thermocouples and 3 calorimeter cubes spaced 120° apart around the circumference of the flange (respectively), and a 4th calorimeter/thermocouple cube placed furthest away from the flame sources.
6. Hydrotest the assembly to 555 psi to check all fittings/ connections for leaks prior to testing.
7. Confirm pressure and ignite the burners under the flange assembly and start the burn cycle clock.
8. Per the test protocol, the average temperature of the flame thermocouples must reach 1400°F within 2 minutes of ignition, and maintain an average temperature between 1400°F and 1800°F with no reading less than 1300°F until the average calorimeter temperature reaches 1200°F.
9. The average temperature between the 4 calorimeter cubes must reach 1200°F within 15 minutes of the burner ignition.
10. Conduct the burn cycle for at least 30 minutes.
11. Upon completion of the burn cycle, cool the valve below 212°F.
12. Depressurize the system.
13. Re-pressurize the system to 555 psi and hold for 5 minutes.
14. Determine the allowable leakage rates:

$$AL = SD * 3.41 = 7.25 * 3.41 = 22.765 \text{ in.}$$

Where: AL= Allowable Leakage

SD= Mean Gasket Seal Diameter

15. Compare the actual leakage rates vs. the allowable rate.

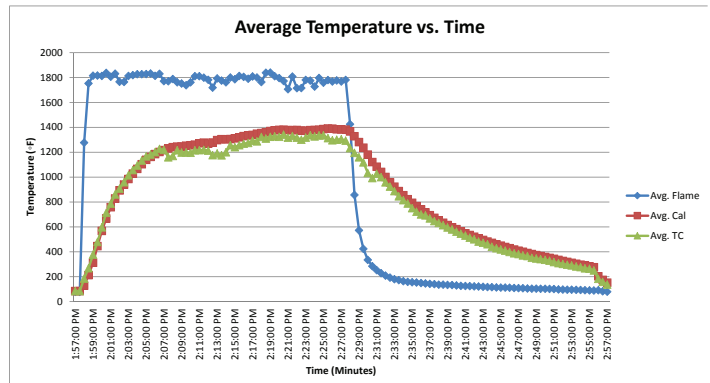
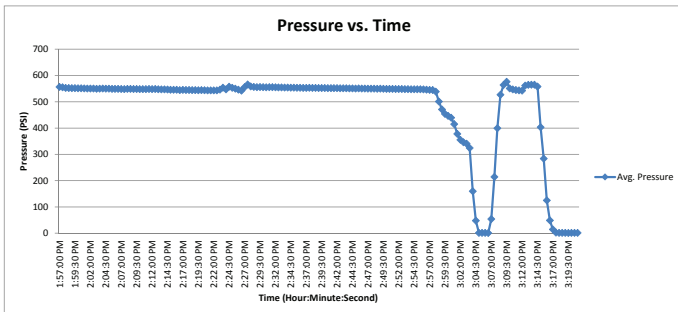

DEFENDER FS™ (CONT.)

VARIABLE	DATA RECORDED
Average System Pressure	550.59 psi
Average Flame Temperature	1722.72°F.
Time to reach flame temperature of 1400°F	1 minute, 30 seconds
Average Calorimeter Temperature	1329.4°F.
Time to reach average calorimeter temp. of 1200°F	10 minutes, 30 seconds
Total Burn Time	30 minutes
Total Cool Down Time	30 minutes
Total Repressurization Hold Time	5 minutes
Average System Pressure during Repressurization	556.71 psi

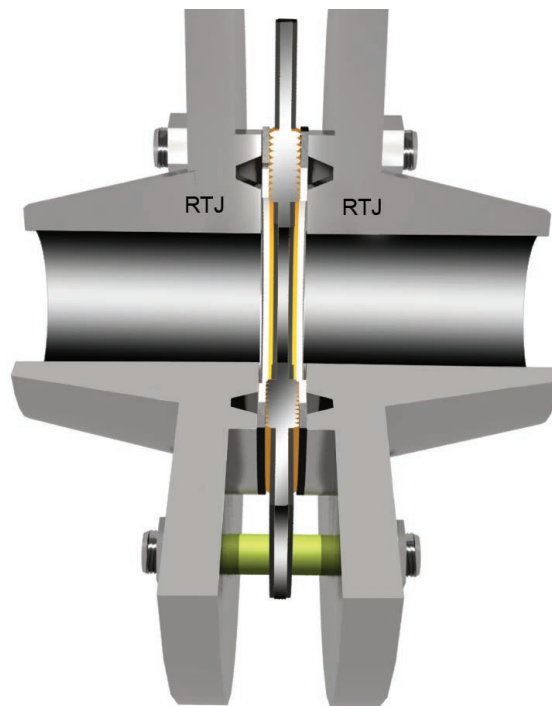

DEFENDER FS™ Sealing/Isolation Gaskets are suggested for RTJ Applications vs. Phenolic Ring Type Gaskets.

ISOGUARD™

SEALING/ISOLATING GASKETS AND FLANGE ISOLATION KITS

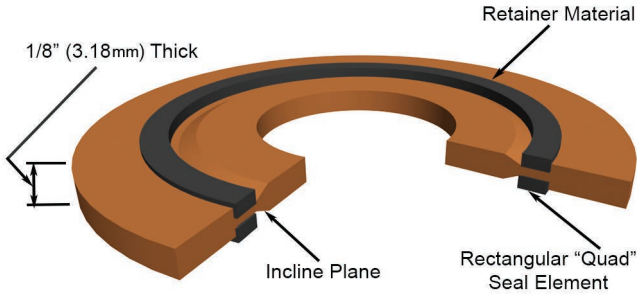

The ISOGUARD™ sealing/isolating gasket system is designed for general applications where electrical flange isolation and corrosion control are required on pipes containing water/wastewater, gas, natural gas, oil and other hydrocarbon based medias up to 302°F (150°C). Available for flat face, raised face and ring type joint flanges from 1/2" to 120" (and corresponding API and DN diameters), ANSI 150-1500#, API 2-5K and PN 20-250, the ISOGUARD™ gasket is an

engineered value added solution for trouble free operation. The ISOGUARD™ sealing/isolating gasket system consists of a retainer with an incline-plane seal groove geometry designed to optimize each seal's elastic memory, in conjunction with a proven rectangular sealing element ("Quad" ring). This design guarantees low bolt load requirements and high sealing reliability. ISOGUARD™ systems are available with a variety of retainers and seal elements.

APPLICATIONS

- ISOGUARD™ gaskets are engineered to provide high reliability sealing and electrical isolation for a wide variety of applications.
- High Pressure Flanges: Up To 1500#, API 5K and PN 250.
- Applications where end users prefer an integral seal element.
- For ANSI 2500#, API 10K and PN 420 applications, please consult factory.

GENERAL FEATURES

- Self Energizing Seal.
- Incline-plane groove geometry.
- Low bolt load required.

A FRESH LOOK AT SEALING - DESIGN FEATURES

A Fresh Look at Sealing - Design Feature: A non-spliced (one-piece) Teflon® seal element, available from 1/2" to 24". Combining this seal with the incline-plane groove design is a first for this generation of gasket technology; an excellent choice for engineers and end users wanting increased seal integrity.

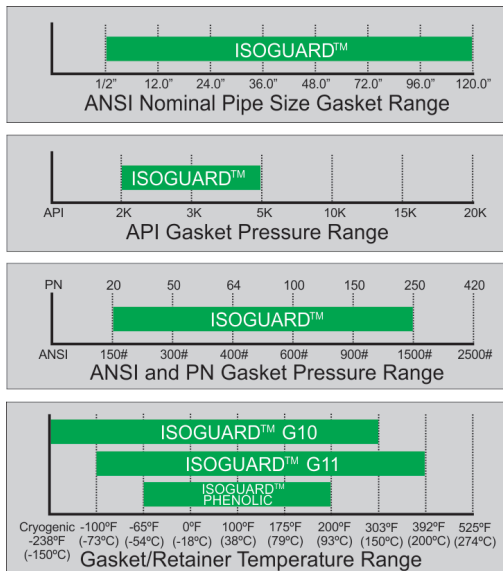

For applications outside ranges shown, consult factory.

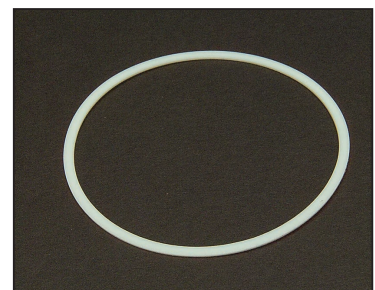

ISO GUARD™ (CONT.)

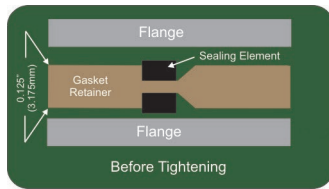

BEFORE TIGHTENING

The flange face makes initial/light contact with the gasket retainer surface (isolation material) and the sealing element protrudes just above the gasket retainer surface.

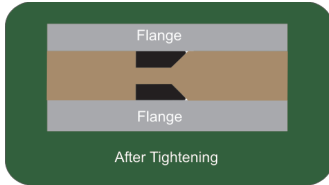

AFTER TIGHTENING

Rectangular Sealing Element “Quad Seal” in conjunction with the incline plane provides a self-energized seal. The small gap between seal element and retainer illustrates how the incline plane allows the seal material to move in a direction other than point loading the gasket web (small area of retainer between the two seals). This movement prevents cracking and breaking of the gasket retainer under high loads.

Furthermore, the incline plane groove provides the seal with greater elastic memory, thereby helping maintain an effective seal even when bolt load may relax over a period of time.

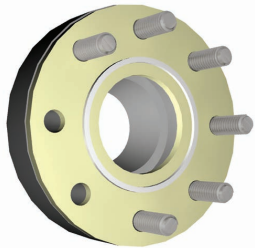

TYPE “E” GASKET

Fits over the bolt holes and extends to the O.D. of the flange to assist contractors as the bolt holes automatically center the gasket. Provides excellent protection against shorting out of the corrosion mitigation hardware. FIK “101” - 50% = Percentage of Type “E” ISO GUARD™ gaskets that are manufactured and specified for use on applications.

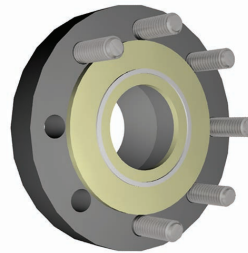

TYPE “F” GASKET

Fits within the bolt hole circle of the flange and extends to the I.D. of the bolt circle providing good protection against shorting out of the corrosion mitigation hardware. FIK “101” - 50% = Percentage of Type “F” ISO GUARD™ gaskets that are manufactured and specified for use on applications.

FACTS

- Based on an industry proven design.
- Enhanced with innovative engineered features.
- Cycled tested at 10,000psi at ambient temperature.
- Made in the U.S.A.
- Tested to Shell Certification Standards.
- Energy applications.
- Water and wastewater applications.
- Value added performance. Enhanced sealing/isolating features for a more durable solution.
- An engineered product with advantageous sealing/isolating features.

ISOGUARD™ (CONT.)

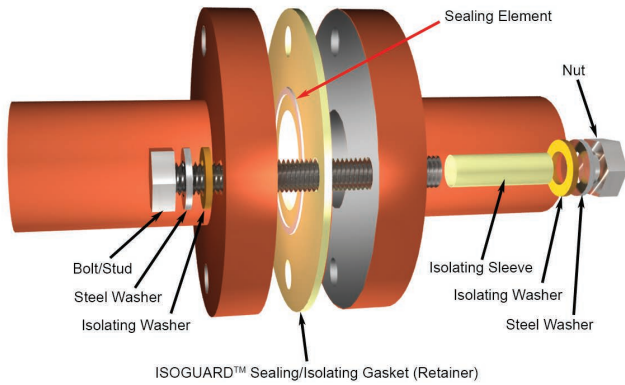

ISOGUARD™ FLANGE ISOLATION KITS

For a flange isolation kit, sleeves and washers are needed. Generally, 95% of ISOGUARD™ gasket flange isolation kits are sold with G10 sleeves and G10 double washer sets, when specified with a G10 retainer gasket.

SUGGESTED SLEEVE/WASHER SETS

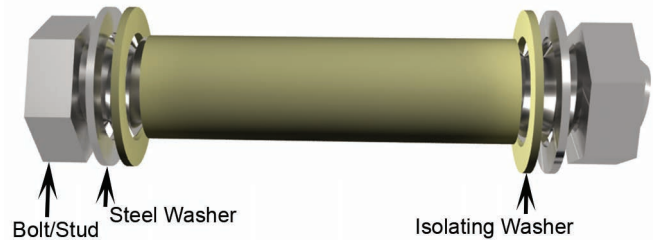

SD = Standard (G10 Sleeves, Steel ZP Washers and G10 Washers) - Double Washer Set.

NOTE: Use with G10 Gasket Material

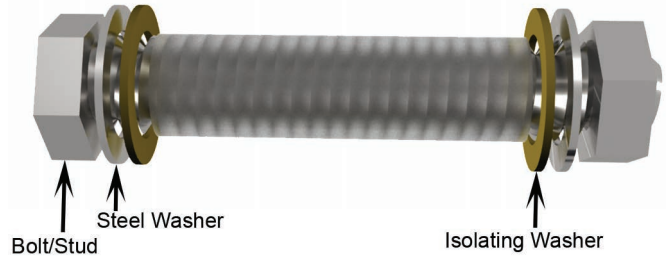

ED = Economy (Mylar Sleeves, Steel ZP Washers and Phenolic Washers) - Double Washer Set.

NOTE: Use with Phenolic Gasket Material

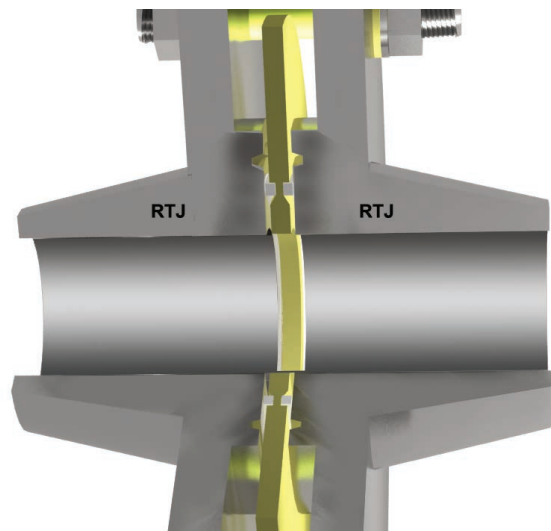

ISOGUARD™ G10 Sealing/Isolation Gaskets are suggested for RTJ Applications vs. Phenolic Ring Type Gaskets.

RETAINER MATERIALS

- G10, G11, Phenolic
- Retainer Thickness 1/8" (0.125") (3.18mm)

GASKET/RETAINER MATERIAL SPECIFICATIONS

ASTM	TEST METHOD	G10	G11	Phenolic
D149	Dielectric Strength Volts/Mil Short Time	750-800	550	500
D695	Compressive Strength (psi)	65,000	63,000	25,000
D570	Water Absorption (%)	0.05	0.10	1.60
D790	Flexural Strength (psi)	65,000	60,000	22,500
D256	IZOD Impact Strength (Ft-Lbs/ Inch)	14.00	12.00	1.20
D638	Tensile Strength (psi)	50,000	42,000	20,000
D732	Shear Strength (psi)	21,000	21,000	10,000
D952	Bond Strength (lb)*	2,600	2,200	1,500
	Temperature - Operating	Cryogenic -238°F (-150°C) to +302°F (+150°C)	-100°F -73°C) to 392°F 200°C)	-65°F (-54°C) to +220°F (+104°C)

Note: Operating Temperature for Gaskets and Flange Isolation Kits is based off the Gasket Retainer Temperature. Seal element temperature does not dictate the min. and max. gasket operating temperature.

SEALING ELEMENT MATERIAL SPECIFICATIONS SEAL ELEMENT MATERIALS

- Teflon®, Nitrile, Silicone, Viton®, EPDM

Sealing Element	Temperature - Operating
Teflon® (PTFE)	Cryogenic to +525°F (+274°C)
Nitrile	-40°F (-40°C) to +250°F (+121°C)
Silicone	-75°F (-115°C) to +392°F (+200°C)
Viton®	-20°F (-29°C) to +392°F to (+200°C)
EPDM	-65°F (-54°C) to +250°F (+121°C)

ISOMATE™

SEALING/ISOLATING GASKETS AND FLANGE ISOLATION KITS



The ISOMATE™ sealing/isolating gasket is designed for basic applications where electrical flange isolation and corrosion control are required on pipes containing water/wastewater, gas, natural gas, oil and other hydrocarbon based medias up to 175°F (79°C). Available for flat face and raised face joint flanges from 1/2" to 24", ANSI 150-300#, PN 20-50, the ISOMATE™ gasket is an economical solution for basic performance. The ISOMATE™ sealing/isolating gasket consists of a phenolic retainer faced on both sides with nitrile rubber material.

FEATURES

- Sealing and Isolating Gasket

APPLICATIONS

ISOMATE™ gaskets are designed to provide reliable sealing and electrical isolation for a wide variety of applications.

The industry has improved sealing technology in retainer type gaskets with engineered seal elements and groove designs. DEFENDER™ and ISOGUARD™ sealing systems should be reviewed, specified and used when a long-term maintenance-free solution is necessary.

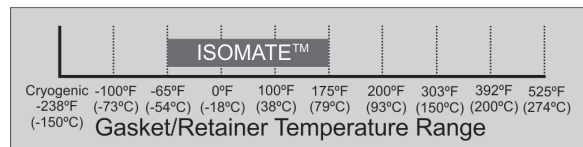
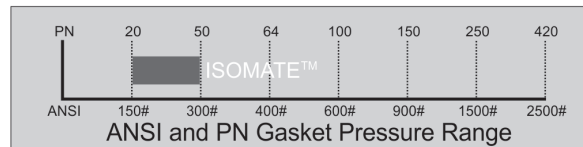
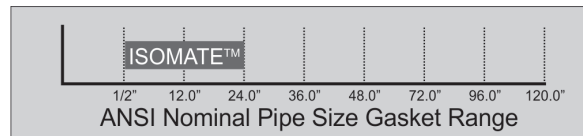

For applications outside ranges shown, consult factory.



TYPE "E" GASKET

Fits over the bolt holes and extends to the O.D. of the flange to assist contractors as the bolt holes automatically center the gasket. Provides excellent protection against shorting out of the corrosion mitigation hardware.

FIK "101" - 50% = Percentage of Type "E" ISOMATE™ gaskets that are manufactured and specified for use on applications.

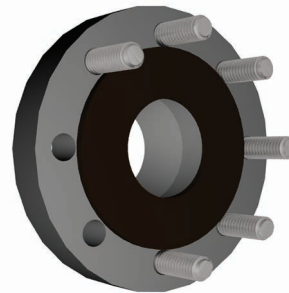

TYPE "F" GASKET

Fits within the bolt hole circle of the flange and extends to the I.D. of the bolt circle providing good protection against shorting out of the corrosion mitigation hardware.

FIK "101" - 50% = Percentage of Type "F" ISOMATE™ gaskets that are manufactured and specified for use on applications.

ISOMATE™ (CONT.)

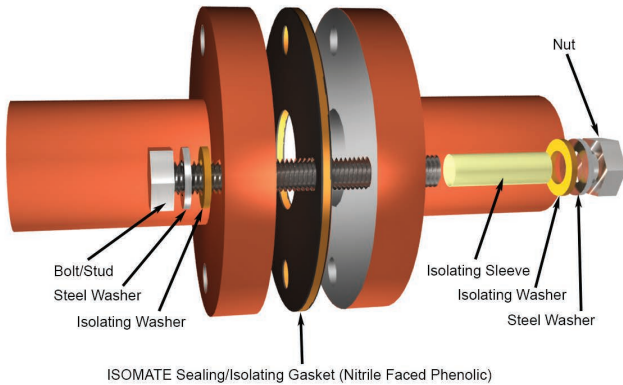

ISOMATE™ FLANGE ISOLATION KITS

For a flange isolation kits, sleeves and washers are needed. Generally, 90% of rubber faced flat gasket flange isolation kits (ISOMATE™ Kits) are sold with mylar sleeves and phenolic double washer sets.

For more packaged sleeve and washer sets and material property information, please review pages 17-20. For FLATMATE™ sealing/isolation gasket and flange isolation kit written specifications, please review page 26.

Suggested Sleeve/Washer Set

ED = Economy (Mylar Sleeves, Steel ZP Washers and Phenolic Washers) - Double Washer Set.

RETAINER MATERIALS

- Phenolic
- Retainer Thickness 1/8" (0.125") (3.18mm)

GASKET/RETAINER MATERIAL SPECIFICATIONS

ASTM	TEST METHOD	Rubber Faced Phenolic
D149	Dielectric Strength Volts/Mil Short Time	500
D695	Compressive Strength (psi)	25,000
D570	Water Absorption (%)	1.60
D790	Flexural Strength (psi)	22,500
D256	IZOD Impact Strength (Ft-Lbs/Inch)	1.20
D638	Tensile Strength (psi)	20,000
D732	Shear Strength (psi)	10,000
D952	Bond Strength (lb)*	1,500
	Temperature - Operating	-65°F (-54°C) to +175°F (+79°C)

Note: Operating Temperature for Gaskets and Flange Isolation Kits is based off the Gasket Retainer Temperature. Seal element temperature does not dictate the min. and max. gasket operating temperature.

SEAL MATERIAL

- Nitrile

SEALING ELEMENT MATERIAL SPECIFICATION

Sealing Material	Temperature - Operating
Nitrile	-40°F (-40°C) to +250°F (+121°C)

FACTS

- FLAT gaskets are a basic technology that has been in the industry for years. Applications should be monitored and maintained on a regular basis.
- Made in the U.S.A.
- Energy Applications
- Water and Wastewater Applications
- Basic Performance. An economical solution for sealing/isolating applications. Routine maintenance suggested.

“FIK 101”: Rubber faced flat gaskets have limitations, use Packaged ED sleeve and washers sets. If the application borders on technical limitations consider ISO GUARD™ G10 Flange Isolation Kits with packaged sleeve/washer set SD.

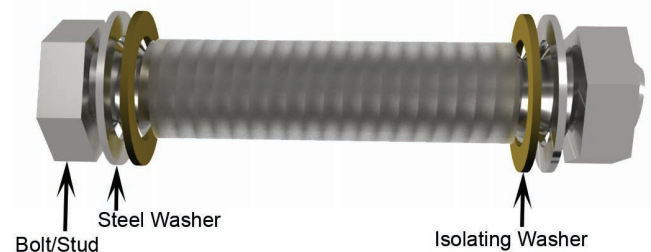

ED = Economy (Mylar Sleeves, Steel ZP Washers and Phenolic Washers) - Double Washer Set.

SLEEVE AND WASHER SETS

Lamons sleeve and washers sets, when combined with our sealing/isolation gaskets, complete a Flange Isolation Kit. For a successful flange isolation kit, it's critical to use the appropriate material for your application. Compressive strength, flexural strength, and cut through resistance are key material physical properties that should not be over looked.

WASHER DESIGN SPECIFICATIONS:

Available for bolt sizes = 1/2" (12.7mm) to 2 3/4" (69.85mm)

- Steel and Isolation Washers are designed with the same O.D. and I.D.
- Steel and Isolating washers are 1/8" (3.18mm) thick.
- Steel and Isolating washers are designed to fit over isolating sleeve material.

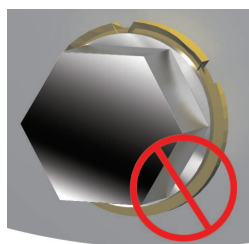

Steel back-up washers need to be supplied with the same O.D. and I.D. as the isolation washer. This graphic illustrates a steel back-up washer and phenolic isolation washer with different O.D and I.D. sizing.

The compressive load from the steel back-up washer is not equally distributed over the phenolic washer, causing the phenolic washer to crack. If this occurs, the gasket may not receive proper load and electrical isolation will most likely be lost, not equally distributed over the phenolic washer, causing the phenolic washer to crack. If this occurs, the gasket may not receive proper load and electrical isolation will most likely be lost.

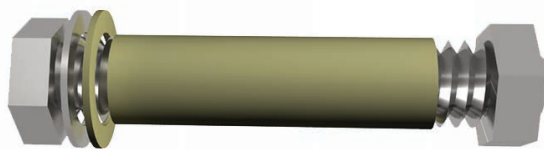
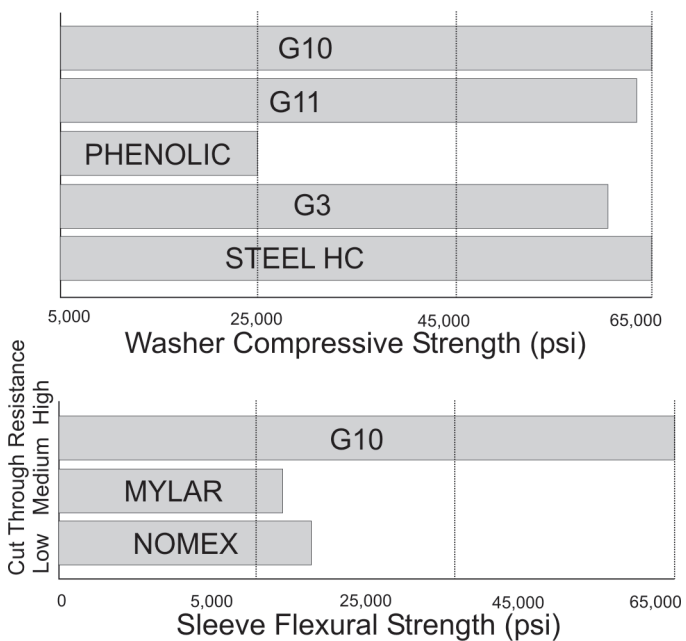

SINGLE WASHER SET (PER BOLT/STUD)

- (1) ea. 1/8" {0.125"} (3.18mm) thick Steel ZPWashers
- (1) ea. 1/8" {0.125"} (3.18mm) thick Isolating Washer
- (1) ea. Isolating Sleeve

"FIK 101": Generally, single washer sets are used for buried applications and may be used to allow the Cathodic Protection (CP) current to reach the nuts and bolts/studs. If desired, the nuts on the opposite side of the cathodically protected flange may be included as part of a Cathodic Protection System.



DOUBLE WASHER SET (PER BOLT/STUD)

- (2) ea. 1/8" {0.125"} (3.18mm) thick Steel ZPWashers
- (2) ea. 1/8" {0.125"} (3.18mm) thick Isolating Washers
- (1) ea. Isolating Sleeve

"FIK 101": Generally, double washer sets are used for applications, where added protection is needed against the possibility of "shorting out" the nuts and bolts. For complete electrical isolation, double washer sets isolate the nuts and bolts from both flanges.

SLEEVE AND WASHER SETS

LAMONS SLEEVES - MATERIAL PHYSICAL PROPERTY SPECIFICATIONS

ASTM	Test Method	Mylar	G10	Nomex
D149	Dielectric Strength Volts/Mil Short Time	4,000	750-800	600
D570	Water Absorption (%)	0.80	0.05	7.00
D790	Flexural Strength (psi)	13,000	65,000	18,000
	Cut Through Resistance	Low	High	Low
	Temperature - Operating	-75°F (-59°C) to 302°F (150°C)	Cryogenic to +302°F(+150°C)	-65°F (-54°C) to +450°F (+232°C)

LAMONS WASHERS - MATERIAL PHYSICAL PROPERTY SPECIFICATIONS

ASTM	Test Method	G10	G11	Phenolic	Steel (HC)	G3
D149	Dielectric Strength Volts/ Mil Short Time	750-800	550	500	800	500
D695	Compressive Strength (psi)	65,000	63,000	25,000	65,000	55,000
D570	Water Absorption (%)	0.05	0.10	1.60	N/A	1.00
	Temperature - Operating	Cryogenic to +302°F (+150°C)	-100°F (73°C) to +392°F (+200°C)	-65°F (-54°C) to +220°F (+104°C)	Cryogenic to +356°F (+180°C)	-100°F (-73°C) to +392°F (+200°C)

ISOLATING WASHERS (G10, G11, PHENOLIC, G3, STEEL HC)

Lamons isolating washers are designed/manufactured to have positive isolation characteristics and provide excellent compressive strength.

STEEL WASHERS/HC WASHERS

HC - Hardened 1050 steel with proprietary isolation coating has excellent dielectric properties and withstands UV. It's also abrasion resistant and will not break under compressive loads. They combine the technical features of steel into an isolating washer.

Steel Back-Up Washers/ZP Washers

ZP - Zinc Plated 1050 carbon steel washers are used as our standard steel back-up washer when kitted with retainer washers and isolating sleeve material. Note: 304 stainless steel available for special order.

SLEEVE DESIGN SPECIFICATIONS:

- Sleeves are designed to fit over standard bolts and studs for flanges.
- Wall Thickness = 1/32" {0.031"} (0.79mm)
- Available for bolt sizes = 1/2" {0.5"} (12.7mm) to 2-3/4" (69.85mm)
- Sleeve length is designed to pass completely through the isolating washer and halfway through the steel washer for cathodic protection and isolation.

ISOLATING SLEEVES (G10, MYLAR, NOMEX®)

Lamons isolating sleeves are designed/manufactured to fit over standard size flange fasteners (bolts/studs) with standard size bolt holes.

BULK SLEEVE AND WASHER MATERIAL

Lamons will provide washers in bulk quantities of 100. Sleeve material may also be purchased in bulk and is shipped and supplied in the lengths shown in the chart. Note: it is suggested that bulk sleeve material be cut in a controlled environment. If cutting in the field, installers should be well versed in determining appropriate sleeve length and have experience with cutting.

SLEEVE AND WASHER SETS

Lamons Standard Packaged Sleeve/Washer Sets. These sets have been selected from specification use and what the industry has installed on a consistent basis over the years for flange isolation and cathodic protection.

Single/Double choice is indicated after Packaged Set choice: S = Single D = Double



E = ECONOMY

Mylar Sleeves, Steel ZP Washers and Phenolic Washers (Double Washer Set Shown, Single Washer Sets Also Available)



V = VALUE

Mylar Sleeves, Steel ZP Washers and G10 Washers (Double Washer Set Shown, Single Washer Sets Also Available)

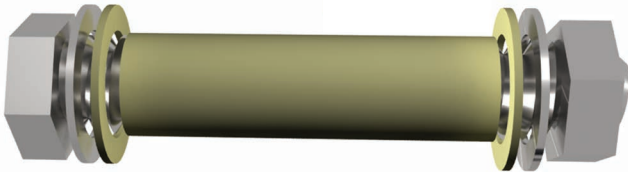

S = STANDARD

G10 Sleeves, Steel ZP Washers and G10 Washers (Double Washer Set Shown, Single Washer Sets Also Available)

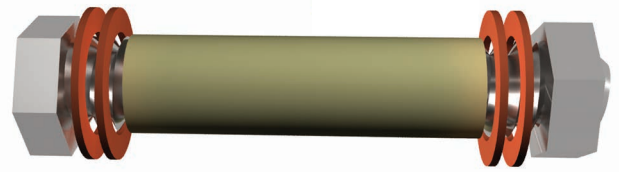

MODEL F = FIRE

G10 Sleeves, Steel HC Washers and Steel HC Washers (Double Washer Set Shown, Single Washer Sets Also Available)

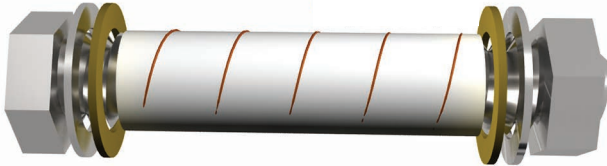

T = HIGH TEMPERATURE

Nomex Sleeves, Steel ZP Washers and G3 Washers (Double Washer Set Shown, Single Washer Sets Also Available)

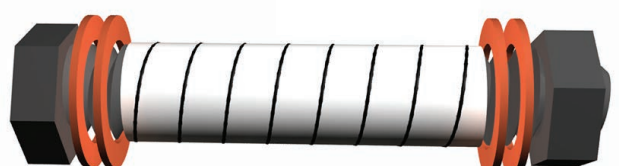

MODEL TF = HIGH TEMPERATURE FIRE

Nomex Sleeves, Steel HC Washers and Steel HC Washers (Double Washer Set Shown, Single Washer Sets Also Available)

SLEEVE AND WASHER SETS

CUT-THROUGH RESISTANCE



Cut Through Resistance and Flexural Strength is critical in selecting sleeve material for your flange isolation kit application. As nominal pipe size increases, as well as ANSI or API class, the fasteners (bolts/studs) increase in size and torque is generally higher. Larger and heavier stud bolts with higher torque loads can more easily cut through material during installation. This is more likely to occur if flanges and bolt holes are not in perfect alignment.

Use or specify G10 sleeve material as a standard for all applications. Or consider G10 sleeves for applications of Nominal Pipe Size 12”

and larger and ANSI pressure class 600# and higher.

The above graphic shows an example of a Mylar Sleeve being shredded; the bolt threads are cutting through the sleeve while misalignment is cracking the sleeve. Electrical isolation can be lost if your sleeve material does not have excellent cut through resistance. Isolation tests will fail and installation costs will increase significantly.

FULL LENGTH SLEEVE



A full length sleeve passes entirely through both flanges, the sealing/ isolation gasket both isolation washers, and half way through the steel back-up washers on each side.

Note: When using mis-matched flanges or flanges with different widths take precise measurements and account for the additional length needed to pass through washer set configuration. If you are unsure of proper length please consult the factory engineering support.

BOLT/STUD DIAMETERS-LENGTH



Bolts/Studs with smooth shank portions should not have a greater diameter than the maximum diameter of the threads. If this is the case, the sleeve may not fit over the shank portion. The adjacent graphic shows a smooth shank sized to the same diameter as the threads, for a successful installation.



When working with Flange Isolation Kits, the bolt length would be standard length + 0.75”. This accommodates for gasket thickness and the use of double washer sets.

INSTALLATION TECHNIQUES AND GUIDELINES FOR GASKETS AND FLANGE ISOLATION KITS

PRE-INSTALLATION

- Wear appropriate safety equipment (eye wear, steel toe boots, gloves)
- Have appropriate tools (torque wrenches, drift pins, & non-conductive lubricant).
- Confirm Lamons Product Label matches flange type and size for installation.
- Inspect Flanges:
 - Flange faces shall be free of oil, grease, pits, gouges, rust & debris. Surface finish shall be no greater than 250 RMS.
 - Refinish flange faces if corrective measures do not meet above requirements.
 - Flange bolt hole spot facings shall be clean and free of burrs.
- Bolts/Studs & Nuts: Make sure they are clean and you have the proper quantity.

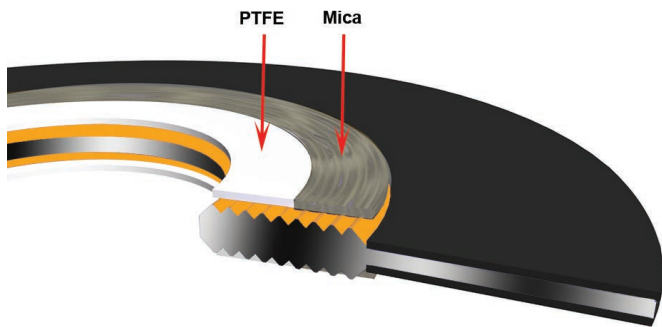

DO NOT REMOVE PTFE AND MICA SEAL ELEMENT MATERIAL FROM DFS GASKET KAMMPROFILE GROOVES.

INSTALLATION

1. Open boxed gasket kit and confirm that component parts are as specified: this includes gasket/flange size, pressure class, and bore.
2. Apply non-conductive lubricant to all threads and flange side of nuts.
3. Isolation Components: (if Gasket ONLY application skip to step 4)
 - Slide isolation sleeve over all bolts.
 - Complete one side of each assembly by attaching a nut (if needed) and ONE STEEL or HC Steel Washer against the nut followed by ONE ISOLATION retainer washer or HC Steel Washer.
 - Check each assembly to ensure that ISOLATION retainer washer or HC Steel Washer is set to land against the flange and STEEL or HC Steel Washer is against the nut.

- NOTE: HC Steel Washers are used for DFS Fire Safe Applications or when specified by user.
4. Align flanges & flanged bolt holes so they are concentric and parallel.
 - For horizontal installations, install the sleeve/washer assemblies, from Step 3, into the bottom half of the flange.
 - For vertical installations, pick either half of the flange, and install sleeve/washer assemblies from Step 3.
 - Do NOT force or cram sleeved bolt assemblies. If force is needed, recheck alignment to ensure sleeve damage has not occurred.

5. Gasket Installation:

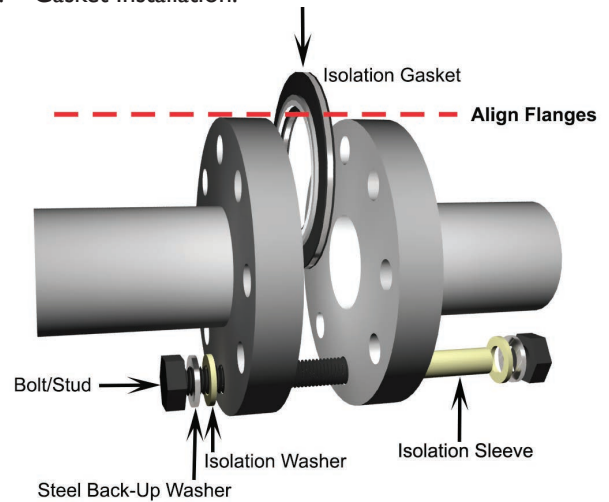

INSTALLATION TECHNIQUES AND GUIDELINES FOR GASKETS AND FLANGE ISOLATION KITS

- **TYPE F GASKET:** Carefully install the gasket and let it rest against the sleeves (or bolts if gasket only) that you installed in Step 4. The gasket is designed to be centered when resting on the bolt assemblies. Take every precaution to guard against damaging sealing element. Visually note seal element contacts flange face.
- **TYPE E GASKET:** Carefully install gasket bolt holes over bolt assemblies; this will automatically center gasket. Take every precaution to guard against damaging sealing element. Visually note seal element contacts flange face.
- Complete gasket installation by installing remaining bolts/sleeve assemblies as well as the opposing side of isolation and steel washers (if a double washer set was ordered).

OTHER CONSIDERATIONS:

1. **Galling:** If serious galling or damage to isolating washers exists replace with high strength washers. (Minimum 50K psi or greater).

CROSS TIGHTENING = EVEN PRESSURE

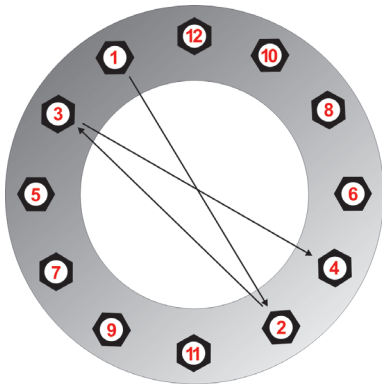

2. Some end users specify 1/4" larger bolt holes than bolt diameters on one flange only to allow for easier alignment in the field. In worst cases, the isolating washer can be as much as 1/4" off-center of the oversize bolt hole, resulting in a substantially reduced flange bearing area for the isolating washer. With flange assemblies of this type, each isolating washer should be sandwiched between two steel back-up washers for additional support.

3. If isolating both sides of a flanged assembly, isolating bolt sleeve lengths must be sized to compensate for additional
 - Unparallel flanges can cause numerous problems including:
 - a. Uneven loading of gasket which can cause leaking and/or damage to gasket retainer.
 - b. Mis-torqued flanged joint because torque is used to align flanges rather than clamp flanges.

washers.

TIGHTENING FLANGE

1. All tightening steps should be done with a torque wrench or with a stud tension measuring device.
2. Pull flanges together by initially cross tightening bolts (pattern above) ONLY until flange to gasket contact has been made.
3. Check for a flange segment that may show separation between gasket and flange by using a laser, flashlight, or feeler gauge. If one exists, the flanges are not parallel.
4. Directly 180° degrees opposite widest part of indicated separation/gap, loosen nuts, even if only finger tight. Return to segment with gap and tighten until both flanges are in contact with gasket retainer.
5. Re-tighten loosened nuts and proceed with torquing of the bolts according to above diagram to 10-15% of specified torque. (Note: Diagram shows 24 bolt holes, the same basic procedure should be used with flanges having more or less bolts)
6. Repeat torque sequence increasing to 50% of torque.
7. Repeat tightening to final torque value.
 - 7A. Optional – it is good practice to make a final check of each bolt for proper torque, especially on large diameter piping systems.

ISOMATE™ NOTE:

ISOMATE™ gaskets are made of compressible dielectric material and if tightened cold, "hot flow" of the gasket material may occur under operating conditions resulting in loss of bolt load. It is advisable to re-tighten bolts after operating temperature has been reached – preferably at zero line pressure and ambient temperature. Under no circumstances should the system be allowed to return to operating temperature after the initial cycling to ambient temperature without checking and re-tightening bolts where needed.

**DO NOT USE LUBRICANT,
GREASE OR ADHESIVES ON
EITHER THE GASKET OR
FLANGE FACES**

TORQUE VALUES FOR DEFENDER™, ISOGUARD™ AND ISOMATE™ SEALING GASKETS/FLANGE ISOLATION KITS

ANSI 150# FLANGES

NPS (Inches)	Qty. Bolts	Bolt Dia.	Rec. Torque (Ft.Lbs.)
1/2	4	0.5	40
3/4	4	0.5	40
1	4	0.5	40
1-1/4	4	0.5	40
1-1/2	4	0.5	50
2	4	0.625	80
2-1/2	4	0.625	90
3	4	0.625	110
3-1/2	8	0.625	90
4	8	0.625	100
5	8	0.75	120
6	8	0.75	130
8	8	0.75	130
10	12	0.875	225
12	12	0.875	225
14	12	1.0	320
16	16	1.0	320
18	16	1.125	450
20	20	1.125	450
22	20	1.25	460
24	20	1.25	650
26-A	24	1.25	650
28-A	28	1.25	650
30-A	28	1.25	650
32-A	28	1.5	1000
34-A	32	1.5	1000
36-A	32	1.5	1100
38-A	32	1.5	1100
40-A	36	1.5	1100
42-A	36	1.5	1150

Working Pressure = 285 psi
Hydro Test Pressure = 455 psi

ANSI 300# FLANGES

NPS (Inches)	Qty. Bolts	Bolt Dia.	Rec. Torque (Ft.Lbs.)
1/2	4	0.50	80
3/4	4	0.625	80
1	4	0.625	80
1-1/4	4	0.625	80
1-1/2	4	0.75	110
2	8	0.625	110
2-1/2	8	0.75	150
3	8	0.75	150
3-1/2	8	0.75	160
4	8	0.75	180
5	8	0.75	190
6	12	0.75	170
8	12	0.875	265
10	16	1.0	320
12	16	1.125	450
14	20	1.125	475
16	20	1.25	650
18	24	1.25	650
20	24	1.25	675
22	24	1.5	1125
24	24	1.5	1200
26-A	28	1.625	1400
28-A	28	1.625	1500
30-A	28	1.75	1700
32-A	28	1.875	2000
34-A	28	1.875	2250
36-A	32	2.0	2300
38-A	32	1.5	2300
40-A	32	1.625	2400
42-A	32	1.625	2400

Working Pressure = 740 psi
Hydro Test Pressure = 1135 psi

ANSI 400# FLANGES

NPS (Inches)	Qty. Bolts	Bolt Dia.	Rec. Torque (Ft.Lbs.)
1/2	4	0.50	80
3/4	4	0.625	80
1	4	0.625	80
1-1/4	4	0.625	110
1-1/2	4	0.75	110
2	8	0.625	110
2-1/2	8	0.75	150
3	8	0.75	150
3-1/2	8	0.875	180
4	8	0.875	180
5	8	0.875	220
6	12	0.875	220
8	12	1.0	320
10	16	1.125	450
12	16	1.25	650
14	20	1.25	650
16	20	1.375	820
18	24	1.375	820
20	24	1.5	1100
22	24	1.625	1425
24	24	1.75	1775
26-A	28	1.75	1750
28-A	28	1.875	2200
30-A	28	2.0	2300
32-A	28	2.0	2300
34-A	28	2.0	2350
36-A	32	2.0	2350
38-A,B	32	1.75	4800
40-A,B	32	1.875	5200
42-A,B	32	1.875	5500

Working Pressure = 990 psi
Hydro Test Pressure = 1510 psi

Lamons does not take responsibility for any of these torque values. They're theoretical values. These bolt torque values are intended for use as guidelines only and are based on ideal conditions, perfect flanges, flange alignment and new well lubricated bolts/nuts according to the National Boiler Code, installed in accordance with the proper tools and installation guide. Torque values are based on using weld-neck flanges and lubricated stud bolts with a 0.16 friction factor.

NOTE: NPS = Nominal Pipe Size, A = Series A Flange, B = Series B Flange

TORQUE VALUES FOR DEFENDER™, ISOGUARD™ AND ISOMATE™
SEALING GASKETS/FLANGE ISOLATION KITS

ANSI 600# FLANGES

NPS (Inches)	Qty. Bolts	Bolt Dia.	Rec. Torque (Ft.Lbs.)
1/2	4	0.50	80
3/4	4	0.625	80
1	4	0.625	80
1-1/4	4	0.625	110
1-1/2	4	0.75	110
2	8	0.625	120
2-1/2	8	0.75	150
3	8	0.75	175
3-1/2	8	0.875	200
4	8	0.875	225
5	8	1.0	350
6	12	1.0	325
8	12	1.125	450
10	16	1.25	650
12	20	1.25	675
14	20	1.375	820
16	20	1.5	1125
18	20	1.625	1430
20	24	1.625	1400
22	24	1.75	1775
24	24	1.875	2230
26-A	28	1.875	2200
28-A	28	2.0	2300
30-A	28	2.0	2360
32-A	28	2.0	3900
34-A	28	2.75	3950
36-A	28	2.5	5500
38-A,B	28	2.25	7000
40-A,B	32	2.25	7200
42-A,B	28	2.50	7400

Working Pressure = 1480 psi
 Hydro Test Pressure = 2245 psi

ANSI 900# FLANGES

NPS (Inches)	Qty. Bolts	Bolt Dia.	Rec. Torque (Ft.Lbs.)
1/2	4	0.75	110
3/4	4	0.75	110
1	4	0.875	110
1-1/4	4	0.875	170
1-1/2	4	1.0	240
2	8	0.875	170
2-1/2	8	1.0	240
3	8	0.875	225
4	8	1.125	450
5	8	1.25	650
6	12	1.125	455
8	12	1.375	825
10	16	1.375	850
12	20	1.375	870
14	20	1.5	1125
16	20	1.625	1430
18	20	1.875	2230
20	20	2.0	2300
24	20	2.5	5500
26-A	20	2.75	7400
28-A	20	3.0	8400
30-A	20	3.0	9500
32-A	20	3.25	10500
34-A	20	3.5	12400
36-A	20	3.5	13800

Working Pressure = 2220 psi
 Hydro Test Pressure = 3355 psi

ANSI 1500# FLANGES

NPS (Inches)	Qty. Bolts	Bolt Dia.	Rec. Torque (Ft.Lbs.)
1/2	4	0.75	110
3/4	4	0.75	110
1	4	0.875	110
1-1/4	4	0.875	170
1-1/2	4	1.0	250
2	8	0.875	170
2-1/2	8	1.0	250
3	8	1.125	375
4	8	1.25	650
5	8	1.5	1000
6	12	1.375	825
8	12	1.625	1400
10	12	1.875	2100
12	16	2.0	2300
14	16	2.25	3400
16	16	2.5	4300
18	16	2.75	6200
20	16	3.0	7800
24	16	3.5	13000

Working Pressure = 3705 psi
 Hydro Test Pressure = 5585 psi

ANSI 2500# FLANGES

NPS (Inches)	Qty. Bolts	Bolt Dia.	Rec. Torque (Ft.Lbs.)
1/2	4	0.75	175
3/4	4	0.75	175
1	4	0.875	175
1-1/4	4	1.0	300
1-1/2	4	1.125	400
2	8	1.0	300
2-1/2	8	1.125	400
3	8	1.25	600
4	8	1.5	650
5	8	1.75	1500
6	8	2.0	2300
8	12	2.0	2400
10	12	2.5	4900
12	12	2.75	7900

Working Pressure = 6170 psi
 Hydro Test Pressure = 9280 psi

TORQUE VALUES FOR DEFENDER FS™ SEALING GASKETS/FLANGE ISOLATION KITS

ASME B16.5 FLANGES 150#

NPS (Inches)	Qty. Bolts	Bolt Dia.	Rec. Torque (Ft.Lbs.)
1/2	4	0.5	28
3/4	4	0.5	30
1	4	0.5	28
1-1/4	4	0.5	34
1-1/2	4	0.5	45
2	4	0.625	89
2-1/2	4	0.625	121
3	4	0.625	134
3-1/2	8	0.625	107
4	8	0.625	134
5	8	0.75	208
6	8	0.75	241
8	8	0.75	241
10	12	0.875	369
12	12	0.875	390
14	12	1.0	570
16	16	1.0	570
18	16	1.125	835
20	20	1.125	731
22	20	1.25	460
24	20	1.25	987

ASME B16.5 FLANGES 600#

NPS (Inches)	Qty. Bolts	Bolt Dia.	Rec. Torque (Ft.Lbs.)
1/2	4	0.50	28
3/4	4	0.625	57
1	4	0.625	57
1-1/4	4	0.625	57
1-1/2	4	0.75	103
2	8	0.625	57
2-1/2	8	0.75	103
3	8	0.75	115
3-1/2	8	0.875	119
4	8	0.875	192
5	8	0.875	297
6	12	1.0	192
8	12	1.125	417
10	16	1.25	526
12	20	1.25	526
14	20	1.375	720
16	20	1.5	955
18	20	1.625	1238
20	24	1.625	1238
24	24	1.875	1958

ASME B16.5 FLANGES 1500#

NPS (Inches)	Qty. Bolts	Bolt Dia.	Rec. Torque (Ft.Lbs.)
1/2	4	0.75	103
3/4	4	0.75	103
1	4	0.875	166
1-1/4	4	0.875	166
1-1/2	4	1.0	250
2	8	0.875	166
2-1/2	8	1.0	250
3	8	1.125	371
4	8	1.25	526
5	8	1.5	955
6	12	1.375	720
8	12	1.625	1238
10	12	1.875	1958
12	16	2.0	2404
14	16	2.25	3490
16	16	2.5	4863
18	16	2.75	6555
20	16	3.0	8601
24	16	3.5	11879

TORQUE VALUES FOR DEFENDER FS™ SEALING

GASKETS/FLANGE ISOLATION KITS

ASME B16.5 FLANGES 300#

NPS (Inches)	Qty. Bolts	Bolt Dia.	Rec. Torque (Ft.Lbs.)
1/2	4	0.50	28
3/4	4	0.625	57
1	4	0.625	57
1-1/4	4	0.625	57
1-1/2	4	0.75	103
2	8	0.625	57
2-1/2	8	0.75	103
3	8	0.75	115
3-1/2	8	0.75	119
4	8	0.75	164
5	8	0.75	221
6	12	0.75	192
8	12	0.875	322
10	16	1.0	343
12	16	1.125	464
14	20	1.125	406
16	20	1.25	592
18	24	1.25	642
20	24	1.25	674
24	24	1.50	1015

ASME B16.5 FLANGES 900#

NPS (Inches)	Qty. Bolts	Bolt Dia.	Rec. Torque (Ft.Lbs.)
1/2	4	0.75	103
3/4	4	0.75	103
1	4	0.875	166
1-1/4	4	0.875	166
1-1/2	4	1.0	250
2	8	0.875	166
2-1/2	8	1.0	250
3	8	0.875	166
4	8	1.125	371
5	8	1.25	526
6	12	1.125	371
8	12	1.375	720
10	16	1.375	720
12	20	1.375	720
14	20	1.5	955
16	20	1.625	1238
18	20	1.875	1958
20	20	2.0	2404
24	20	2.5	4863

ASME B16.5 FLANGES 2500#

NPS (Inches)	Qty. Bolts	Bolt Dia.	Rec. Torque (Ft.Lbs.)
1/2	4	0.750	103
3/4	4	0.750	103
1	4	0.875	175
1-1/4	4	1.0	300
1-1/2	4	1.125	400
2	8	1.0	300
2-1/2	8	1.125	400
3	8	1.25	600
4	8	1.50	650
5	8	1.75	1500
6	8	2.0	2300
8	12	2.0	2400
10	12	2.5	4900
12	12	2.75	7900

For larger nominal pipe sizes, check website or consult factory.

NOTE: NPS = Nominal Pipe Size

SUGGESTED MEDIA

Listed here are the most common media applications for flanged pipelines. For media (contents of the pipeline) not mentioned in the provided chart, please consult factory or a local authorized Lamons distributor.

Note: The adjacent chart includes information which is intended for general use and as a guideline only. Performance for any specific application should be determined by user. Material selection is at the risk of the user. Consult with a specialist, engineer or the factory for specific applications.

Please keep in mind that variation in temperature, pressure, media concentration, mixtures and added inhibitors may preclude suggested use.

Selection Criteria	DEFENDER™ DEFENDER FS™ Sealing /Isolating Gasket	ISOGUARD™ Sealing /Isolating Gasket	ISOMATE™ Sealing /Isolating Gasket
Energy Industry			
Ethanol	X	X	
Ethylene	X	X	
Fuel Oil	X	X	
Gas, Natural	X	X	X
Gas, Sour	X	X	
Gasoline	X	X	X
Crude Oil	X	X	X
Propane	X	X	X
Nitrogen	X	X	X
Butane	X	X	
Diesel	X	X	
Methane	X	X	
Hydrocarbons	X	X	
Hydrogen Sulfide (H ₂ S)	X	X	
Carbon Dioxide (CO ₂ Mix)	X	X	
Water Industry			
Sewage		X	
Spent Liquor		X	
Water (hot)		X	
Water (potable)		X	X
Water (sea)		X	X
Water		X	

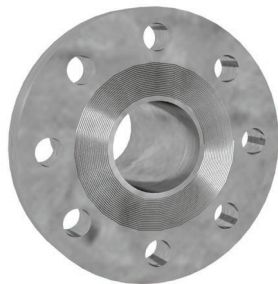

Flange Type	DEFENDER™	ISO-GUARD™	ISO MATE™	DEFENDER FS™
FF = Full Face	X	X	X	X
RF = Raised Face	X	X	X	X
RTJ	X	X		X
S = Slip-on	X	X	X	X
Other	Contact Factory	Contact Factory	Contact Factory	Contact Factory

*"FIK 101" For flange faces greater than 250 micro inches, consult factory.



INSTALLATION AND BOLTING PRACTICES

In the mission to eliminate leaks and control fugitive emissions in piping and pressure vessel systems, it is important to fully understand the mechanisms that impact reliable bolted joint performance. Proper inspection of all components and the utilization of proper installation techniques is a critical step in controlling bolted joint integrity. The following is a list of practices and recommendations that will help ensure maximum joint integrity. Some more difficult or critical joints will need additional steps and guidance from plant reliability to assemble correctly. As with any work, always follow all plant safety rules and guidelines.

There are two important facts you should keep in mind when dealing with tension joints.

- The bolt is a mechanism for creating and maintaining a force, the clamping force between joint members.
- The behavior and life of the bolted joint depend very much on the magnitude and stability of that clamping force.

The following procedures are of fundamental importance regardless of the style of gasket or material used in the bolted joint.

SUPPORT EQUIPMENT

- Ensure the stability of the equipment before loosening the fasteners.
- Loosen fasteners - Loosen fasteners systematically, loosening all fasteners slightly first, using a second step to completely loosen all fasteners.

NOTE: This avoids overloading one or two fasteners by releasing the load of the adjacent fasteners.

- Open flanges - Spread the flanges apart a distance that is ample to remove the old gasket, clean and inspect the seating surfaces, and install the new gasket.
- Do not allow tools to come into contact with the flange face.

REMOVE THE FASTENERS, HARDENED WASHERS, FLANGES, AND OLD GASKET

Fasteners - Hex head bolt and nut or threaded stud with one nut on each end.

- If the fasteners are to be reused, it is important to store them properly by replacing the nut onto the same fastener that it was removed from, replacing the nut onto the same end of the fastener that it was removed from, and stacking the fasteners so as not to damage the threads.

HARDENED WASHERS

- The washer should not be stored on the fastener as it may create a problem stacking the fasteners. Secure the washers in a dry container or area if possible.

FLANGES

- Extreme caution should be exercised in removing any detachable flanges. Care should be taken to protect the seating surface or flange face from hitting, bumping, or dragging against anything that would damage it.
- When storing these detachable flanges, do not lay the flange face against a rough surface such as concrete, pavement, or steel grating. Store on strong wood or other strong but non-abrasive material.
- If the flanges are to be left exposed to the weather, light oil should be applied to the flange face and the nut-bearing surface for protection against corrosion. The

commercial lubricant spray is not suitable for this purpose, it is primarily a solvent. If the storage time is to be prolonged, heavy grease is preferred.

OLD GASKET

- The old gasket should be removed using a scraper or other tools that will not damage the seating surfaces of the flanges. Brass brushes or abrasive wheel that is softer than the flange material is recommended so as not to alter the flange surface finish.
- If the joint has failed and a failure analysis is to be done, take special care in removing the gasket. Keep the gasket intact if possible, mark its orientation to the flanges, mark the problem areas, and store properly.

CLEAN EQUIPMENT

Flanges

- Remove all foreign materials from the flange seating surfaces. Use tools or approved solvents that will not damage the surfaces.

NOTE: In some situations, there may not be ample space to clean the flanges in the usual manner nor an approved solvent. Rough sanding, sandblasting, and rough filing are not recommended. Always scrape flange faces in a path or direction that corresponds with the serration path and not across them.

- Remove old paint and lubricant from the nut-bearing surface of the flanges. [This is the backside of the flange where the nut or the head of the bolt contacts it.]

Fasteners

- Use solvent, wire brush, buffing wheel, etc. to remove old lubricant, paint and rust from the fastener threads.
- Clean the fastener heads and nuts in a similar manner, being sure to clean the load bearing surfaces of both the head and the nut.

INSPECT EQUIPMENT

- Visually inspect the seating surfaces for any pitting, corrosion, cracks, dings, or cuts. Cracks, excessive pitting or corrosion may warrant the use of inspection by dye penetrate, x-ray, or ultrasound.
- Where possible, use a straight edge across the flange faces to check for warping, metal draw, and flange rotation. Any indication of problems at this point should be followed with a run-out check using a dial indicator.
- Physically run the nut or nuts onto the bolt or stud. The nuts should run freely past the point on the fastener where it will come to rest after it is installed and tightened. This is done on both new and old fasteners.
- Check to see if your plant has a policy on replacing used fasteners. As a general rule, it is always best to replace these expendable components that contribute to the success of the properly assembled joint.

HARDENED WASHERS

- Visually check for correct size and hardness, pits, cracks, marring, and flatness.

NOTE: Hardened washers that exhibit cracking may indicate a misuse of the product.

REPAIR OR REPLACE EQUIPMENT

Flanges

- a. Light to medium pitting, corrosion, cracks, dings, or cuts on the seating surfaces may be repaired by machining. Heavy pitting, corrosion, cracks, dings, or cuts may require fill welding and machining or replacement of the flange.
- b. Most warping, metal draw, and flange rotation can be removed by machining. Extensive out of tolerance conditions may require replacing the flanges.

- c. Excessively worn or damaged nut bearing surfaces may be repaired by machining or filing until flat and installing hardened washers.

NOTE: Tolerances for statements a. and b. should be based on the engineering design of the flanges, flange rigidity, the minimum gasket compression in thousandths of an inch, and the available bolt load.

FASTENERS

- Light corrosion, wear, and damage may be repaired by running a die nut over the threads or filing with a thread, blade, or three corner file. Excessive damage, wear, corrosion, incorrect size or grade, or cracks indicate that the fastener should be replaced. If there is considerable time between the repair and installation of a fastener, you will want to apply light oil to the threads and the nut face or bearing surface.

NOTE: The commercial lubricant spray is not suitable for this purpose, it is primarily a solvent. Do not apply heavy grease or anti-seize at this time, it may gather trash as the fastener is installed.

- Light wear and corrosion are tolerable on the fastener bearing surfaces. Medium to heavy wear and corrosion indicate that the fastener should be replaced. Damage, cracks, or incorrect size or grade indicate that the fastener should be replaced.
- The inability of the nut to run freely on the bolt or stud may be corrected by working the nut back and forth on the fastener or running a file or die nut over the threads. Many small imperfections can be worked out by running the nut down the fastener as far as it will go and then hit the nut against something solid. This flattens the burr or imperfection and allows the nut to travel on. If the nuts consistently stop traveling as soon as there is full engagement between the nut and the fastener, you have an improper thread pitch match. If problems persist with new bolts look for solutions through proper handling, shipping, storing, and purchasing. If your plant has a policy on replacing used fasteners, refer to it for assistance. If one does not exist or does not address your application, here are some solid guidelines.
- Yielded fasteners should be replaced because their performance is uncertain.
- Inexpensive fasteners that have been tightened by unmeasured methods should be replaced because their performance is uncertain.
- The stud and nuts fastener should be replaced where cost is not prohibitive because it is not likely that you can control friction or get repetitive results from this combination. Even loading of the gasket is dependent on even bolt loads across the joint. Even bolt loads are dependent on consistent friction from fastener to fastener. Consistent friction on used fasteners is dependent on the same thread areas from both the fastener and the engaging repetitively. This is highly improbable given the obstacles that we would have to overcome.

NOTE: The bolt and nut fastener is more likely to achieve repetitive loads as long as the same nut is properly installed on the bolt because of the fixed head of the bolt insures to some degree that the same threads are consistently used.

- Fasteners in high fatigue service should be replaced periodically
- Fasteners in critical service should be replaced because a failed joint becomes more costly than the fastener
- Fasteners subjected to extreme thermal cycles should be replaced.
- It is best to change all of the fasteners in a critical joint if you change one. If this is not feasible, attempt to install the new fasteners at evenly spaced intervals around the joint

HARDENED WASHERS

- Hardened washers should be replaced if they are damaged in any way.

NOTE: Hardened washers are the big equalizer in the joint. They reduce friction due to flange misalignment, nut embedment, and poor bearing surfaces. They also stiffen the flange and lengthen the effective length of the fastener. While accomplishing all of this, they should not be installed in services that attack hard steels. The failed washer is worse than the negative sum of all its benefits.

- Excessive spacing or gap [A condition where two flanges are separated by a distance greater than twice the thickness of the gasket when the flanges are at rest and the flanges will not come together using minimal force.]
- The force necessary to pull the flanges together should not exceed 10% of the maximum torque prescribed to properly load the gasket when using all of the fasteners in the joint.

ALIGNMENT OF ALL COMPONENTS

Rules for aligning flanges:

- Out of tolerance conditions should be corrected before the gasket is installed to avoid damaging it.
- The rule of thumb for aligning piping flanges is, "There shall not be any detrimental strain introduced into the piping system." Since it is very difficult for the craftsman to determine this point, a second rule usually will suffice in the field. "When aligning requires more force than can be exerted by hand or spud/pin wrenches consult your piping engineer."
- Before using jacks or wrench devices, you may want to do a pipe stress analysis, especially if the pipe is old or it is suspected that the walls have thinned from use.
- If the flanges that are in need of aligning are connected to pumps or rotating equipment, great care must be taken to prevent introducing a strain into the equipment housing or bearings. Measuring the movement in the equipment to insure that you do not disturb its aligned condition is a common and necessary practice.
- The best aligning is to repair the misaligned component by replacing it correctly, removing and reinstalling in the properly aligned position, or using uniform heat to relieve the stresses.
- In joints where one or more of the flanges are not attached to piping or vessels, such as cover plates and tube bundles, use ample force to accomplish the best aligned condition.
- Once the flanges are aligned, install the gasket and tighten the fasteners completely, and then release the aligning devices. Follow this rule as closely as possible. External forces have less effect on properly loaded joints.

NOTE: Proper alignment of all joint members is the very core of flange joint assembly. It results in maximum seating surface contact, maximum opportunity for even gasket loading, and reduced friction between the nut and the flange.

PREPARE FASTENERS, WASHERS, AND GASKET FOR INSTALLATION

Fasteners

- Fasteners should be checked for the proper diameter, length, threads per inch, grade, and condition.
- The nut should run freely on the stud or bolt past the point where the nut will come to rest after it is installed and tightened.
- The fasteners should be transported to the job site with the nut or nuts on them. The nuts should remain on the fasteners until you are ready to install them in the joint.

Washers

- The washers should be checked for proper outside diameter. A quick field test when using a heavy hex nut is to lay the washer on a flat surface and center the nut on top of it. The washer should extend from under the points of the nut about one sixteenth of an inch.
- The proper inside diameter of the washer should be one eighth of an inch larger than the fastener.

- The thickness of the washer will usually be one eighth or one fourth of an inch. All washers should have the same thickness. The washer would also have a uniform thickness.
- Most hardened washers will fit the above description. There should be, however, a grade marking stamped into the washer to indicate its hardness. In selecting a particular hardness of washer, you may want to consult your metallurgist. In order to improve the performance of the joint, the washer must be harder than the flange material.

Gaskets

- The gasket should be transported to the job site at the time that it is to be installed. The gasket should be kept in its protective packaging until it is time to install it. If there is no protective packaging or it is to be stored at the job site, secure the gasket so that it will not be bent, broken, scratched, exposed to adverse chemicals or elements, knocked around, stepped on, or receive damage of any kind.
- Some gaskets require the application of additional sealing materials at the time of installation, such as graphite or PTFE. This should be done in accordance with the manufacturer's recommendations [either the gasket or sealant manufacturer]. Care should be taken to keep any unwanted materials out of the application process.

INSTALL FASTENERS, WASHERS, AND GASKET

Fasteners

- Fasteners should be placed into the bolt holes carefully as to protect the threads from damage. Driving the fasteners in with a hammer can cause damage that will impact performance. Proper aligning of flanges will permit easy installation of fasteners.
- If the fastener is a stud and is being installed into a tapped hole, you may or may not want to perform this task before the flanges are brought together. In choosing between methods, care to protect the threads and ease of installation should be considered. Special care should be taken not to cross-thread the fastener in the tapped hole. Exercise caution not to damage the threads on the other end while attempting to screw the fastener in the hole.
- The nut should be installed with the flat bearing surface or washer side toward the flange or against the washer, if one is used. The other side of the nut should bear a raised grade and manufacturer's marking.
- The fastener should provide ample length for the installation of any washers, the installation of the gasket, full engagement of the nut. When the fasteners are completely tight and the gasket fully loaded, the fastener should be, at the least, flush with the outside of the nut.
- In the case of studs being installed with additional length, the additional length may be shared between both ends or moved to the end that is least likely to be tightened or removed. This statement concerns good engineering and field practices, not the aesthetics of the joint.
- The fastener must pass through the flanges at right angles. Any degree of angle will cause the fastener to bend during tightening and the nut to embed into the bearing surface. This results in higher more unpredictable friction on the fastener system which in turn results in less control in joint load.

Washers

- Washers should rest parallel to the flange surface. Remove any high points on the flange before installing washer.
- Washers may be installed on both ends of the fasteners if the fastener length is ample, this will increase the rigidity of the joint. When installing only one washer, it must be installed under the nut that is being turned. This will reduce the friction

and protect the bearing surface on the flange.

Gasket

- Always be sure that the gap between the flanges is at least 1/16" wider than the thickness of the gasket, and 1/8" is preferred when possible.
- Check to be certain that the gasket seating surface remains free of obstructions or trash.
- Do not force the gasket into place. When moving the gasket about, use a flat tool to gently slide it. Do not put your fingers between the flanges.
- Center the gasket on the seats. Some gaskets have full-face contact with bolt holes through the gasket to insure proper fit. Full-face gaskets without bolt holes, of the proper dimension, usually are not a problem to center. A problem does occur on flanges smaller than one inch where the standard tolerance leaves a reduced seating contact when the gasket is positioned completely against the fasteners on one side. The same situation does occur in certain size flanges when using spiral wound gaskets.
- Some very large gaskets may require an adhesive to hold them in place while they are being installed. The adhesive should be one that is approved by the gasket manufacturer, process engineers, and your metallurgist. The ideal adhesive will adhere well, dissipate completely with time and temperature, and not react with equipment materials or the process chemicals.

NOTE: Grease, tape, or petroleum gels are not recommended for this purpose. Also, the application of anti-seize to a gasket to cause it to be removed easily is not recommended.

- Once the gasket is installed, allow the flanges to come into contact with it slowly, squarely, and gently. Do not pull the flanges into alignment with the gasket in place.

LUBRICATE FASTENERS AND WASHERS

Fasteners

- Use an approved lubricant suited to the fastener material, process medium, temperature range, and friction requirements.
- Lubricant should be applied generously and evenly to all contacting surfaces of the fastener system.
- Except when installing bolts or studs into tapped holes, apply the lubricant after the fastener is installed in the flanges. If the lubricant is applied to the fastener beforehand, it may collect trash as it passes through the flanges.
- When the fastener system is a bolt and a tapped hole, apply the lubricant to the: bolt threads, under side of the head or the flange bearing surface, and the shank of the bolt where it may contact the flanges.
- When the fastener system is a bolt and nut, where the nut will be turned in the tightening process, apply lubricant to the bolt threads and the nut or flange-bearing surface.

NOTE: If the bolt is to be turned and not the nut, treat it as though it were a bolt and a tapped hole.

- When the fastener system is a stud, a nut, and tapped hole; lubricate the stud threads on the end to be installed into the tapped hole. After the stud is installed and the flanges assembled, lubricate the threads on the other end of the stud where the nut is to be installed and the nut or flange bearing surface.
- When the fastener system is a stud and two nuts, lubricant may be applied to the threads on both ends of the stud and to the bearing surface of both nuts and flanges. If you want one end to be difficult to loosen later, you may leave off the

lubricant.

NOTE: You must always lubricate the end where the nut is to be turned and always apply the lubricate to ample threads so that the nut does not run dry before it is tight.

Washers

- Apply the lubricant to the side of the washer that is against the nut that is to be turned or the head of the bolt.
- If you are using a washer on both ends of a stud and want one end to be difficult to loosen, you may leave off the lubricant.
- There is no advantage to applying lubricant to both sides of the washer, except that you are now certain that you lubricated the correct side.

TIGHTEN EVENLY

Squaring and Stabilizing

- Bring the flanges to contact the gasket slowly and squarely using minimal but sufficient force to lightly tighten the fasteners and stabilize the joint. Tighten the fasteners in a star or crisscross pattern, checking to be sure that the gap between the flanges remains even at ninety-degree intervals around the flanges. The use of all the bolts is preferred on flanges with up to eight bolts. Above eight fasteners, the use of eight fasteners for the initial squaring and stabilizing is usually considered to be sufficient. You should not initiate any significant gasket compression at this time.

NOTE: Very heavy flanges with stiff gaskets may require the use of additional fasteners. If the joint is considered critical for any reason, use all of the fasteners in the joint for this initial pass.

Compression Pass #I

Once the joint is stabilized, apply a medium or half strength tightening force. Use the same guidelines for this pass as you did for the stabilizing pass.

Compression Pass #II

After completing the medium pass, tighten the fasteners with ample but restrained force. Remember that there is a limit below which a joint will fail and an upper limit above which a joint component will fail. Use the same guidelines for this pass as for the first two passes.

Circular Compression Pass

Once the second compression pass is completed, you will apply the same tightening force in a circular pattern. Starting at the most convenient or practical point, tighten the fasteners, moving in one direction from one to the next in a circular fashion around the flanges. You will continue this, circling the flanges as many times as necessary until the nuts no longer turn. Do not increase the tightening force during this pass!

APPLICATION OF TORQUE

The most accurate method for obtaining the correct seating stress is to apply the bolt load by direct measuring its tension or stud elongation. However, in practice, this procedure is cumbersome and of difficult execution. As a consequence the trend in industry today is the use of torque wrenches, tensioning devices, hydraulic wrenches. The use of manpower to tighten the bolts, by sledgehammers, striking wrenches and pieces of pipe on the end of the wrench is not recommended since this offers no degree of accuracy.

Special thank you to Edward Hayman for his contribution of information for this chapter.

BOLT TORQUE SEQUENCE

4-BOLTS



Sequential Order

1-2
3-4

Rotational Order

1
3
2
4

8-BOLTS



Sequential Order

1-2
3-4
5-6
7-8

Rotational Order

1
5
3
7
2
6
4
8

12-BOLTS



Sequential Order	Rotational Order
1-2	1
3-4	5
5-6	9
7-8	3
9-10	7
11-12	11
	2
	6
	10
	4
	8
	12

16-BOLTS



Sequential Order	Rotational Order
1-2	1
3-4	9
5-6	5
7-8	13
9-10	3
11-12	11
13-14	7
15-16	15
	2
	10
	6
	14
	4
	12
	8
	16

20-BOLTS

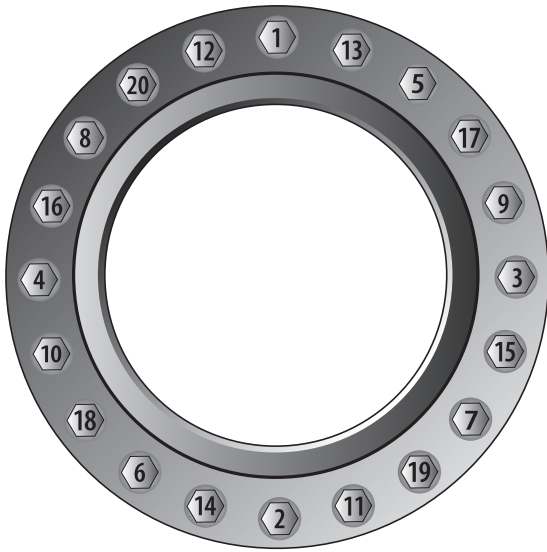

Sequential Order	Rotational Order
1-2	1
3-4	13
5-6	5
7-8	17
9-10	9
11-12	3
13-14	15
15-16	7
17-18	19
19-20	11
	2
	14
	6
	18
	10
	4
	16
	8
	20
	12

24-BOLTS

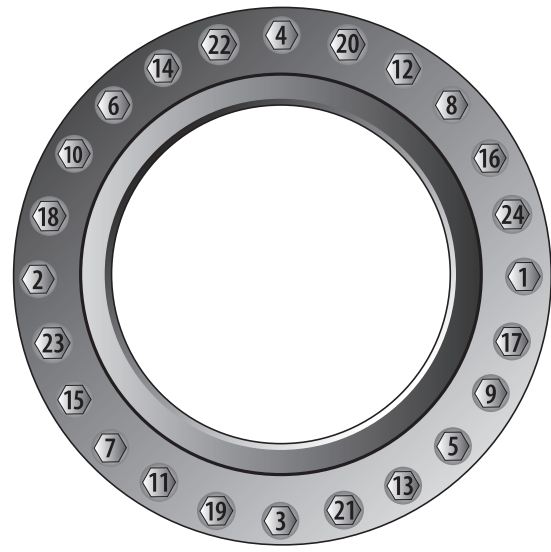

Sequential Order	Rotational Order
1-2	1
3-4	19
5-6	17
7-8	5
9-10	13
11-12	21
13-14	3
15-16	11
17-18	19
19-20	7
21-22	15
23-24	23
	2
	10
	10
	18
	6
	14
	22
	4
	12
	20
	8
	16
	24

28-BOLTS

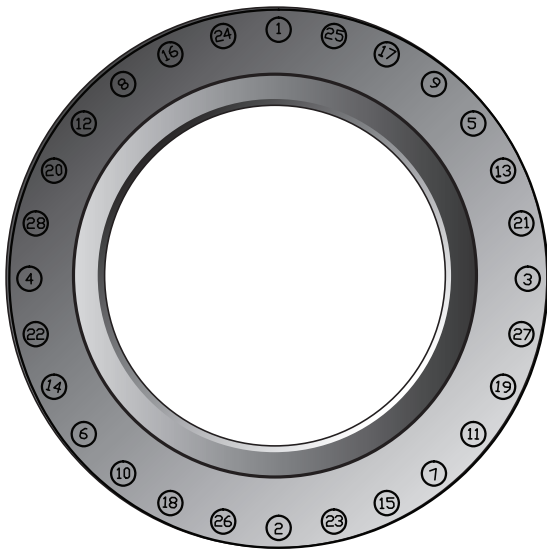

Sequential Order	Rotational Order
1-2	1
3-4	25
5-6	17
7-8	9
9-10	5
11-12	13
13-14	21
15-16	3
17-18	27
19-20	19
21-22	11
23-24	7
25-26	15
27-28	23
	2
	26
	18
	10
	6
	14
	22
	4
	28
	20
	12
	8
	16
	24

32-BOLTS

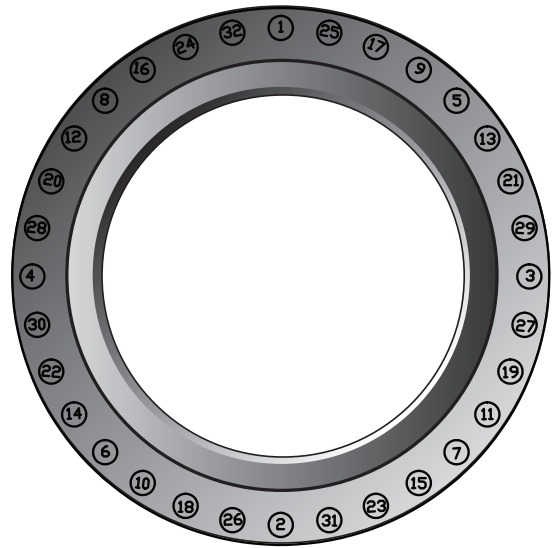

Sequential Order	Rotational Order
1-2	1
3-4	25
5-6	17
7-8	9
9-10	5
11-12	13
13-14	21
15-16	29
17-18	3
19-20	27
21-22	19
23-24	11
25-26	7
27-28	15
29-30	23
31-32	31
	2
	26
	18
	10
	6
	14
	22
	30
	4
	28
	20
	12
	8
	16
	24
	32

36-BOLTS

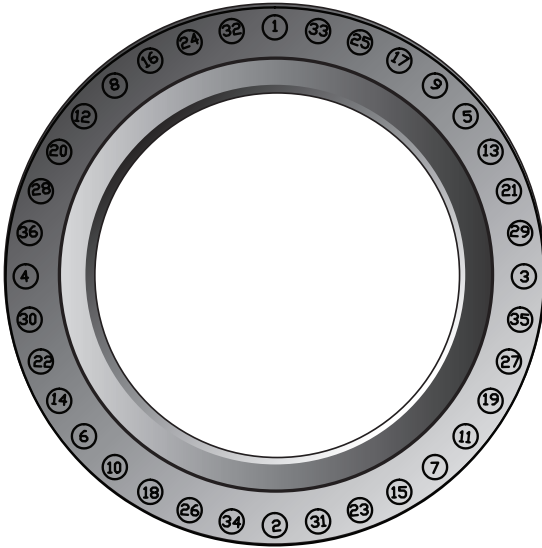

Sequential Order

1-2
3-4
5-6
7-8
9-10
11-12
13-14
15-16
17-18
19-20
21-22
23-24
25-26
27-28
29-30
31-32
33-34
35-36

Rotational Order

1
33
25
17
9
5
13
21
29
3
35
27
19
11
7
15
23
21
2
34
26
18
10
6
14
22
30
4
36
28
20
12
8
16
24
32

40-BOLTS

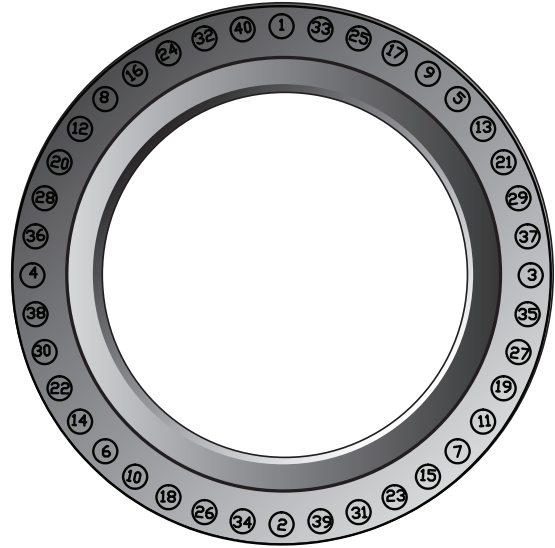

Sequential Order

1-2
3-4
5-6
7-8
9-10
11-12
13-14
15-16
17-18
19-20
21-22
23-24
25-26
27-28
29-30
31-32
33-34
35-36
37-38
39-40

Rotational Order

1
33
25
17
9
5
13
21
29
37
3
35
27
19
11
7
15
23
21
31
39
2
34
26
18
10
6
14
22
30
38
4
36
28
20
12
8
16
24
32
40

TROUBLE SHOOTING LEAKING JOINTS

One of the best available tools to aid in determining the cause of leakage is a careful examination of the gasket in use when leakage occurred.

Observation	Possible Remedies
Gasket badly corroded	Select replacement material with improved corrosion resistance.
Gasket extruded excessively	Select replacement material with better cold flow properties, select replacement material with better load bearing capability - i.e., more dense.
Gasket grossly crushed	Select replacement material with better load bearing capability, provide means to prevent crushing the gasket by use of a stop ring or re-design of flanges.
Gasket mechanically damaged due to overhang of raised face or flange bore	Review gasket dimensions to ensure gaskets are proper size. Make certain gaskets are properly centered in joint.
No apparent gasket compression achieved	Select softer gasket material. Select thicker gasket material. Reduce gasket area to allow higher unit seating load.
Gasket substantially thinner on OD than ID	Indicative of excessive "flange rotation" or bending. Alter gasket dimensions to move gasket reaction closer to bolts to minimize bending moment. Provide stiffness to flange by means of back-up rings. Select softer gasket material to lower required seating stresses. Reduce gasket area to lower seating stresses.
Gasket unevenly compressed around circumference	Improper bolting up procedures followed. Make certain proper sequential bolt up procedures are followed.
Gasket thickness varies periodically around circumference	Indicative of "flange bridging" between bolts or warped flanges. Provide reinforcing rings for flanges to better distribute bolt load. Select gasket material with lower seating stress. Provide additional bolts if possible to obtain better load distribution. If flanges are warped, re-machine or use softer gasket material.

OTHER BOLTED CONNECTION PROBLEM AREAS

Joint Must Compensate for Wide Temperature Variations:

Solution: Consider use of sleeve around bolts to increase effective bolt length:

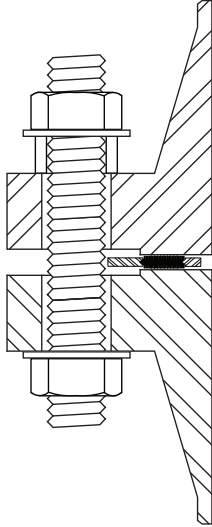

Or consider use of conical spring washers in place of sleeve to eliminate torque losses over wide temperature ranges.

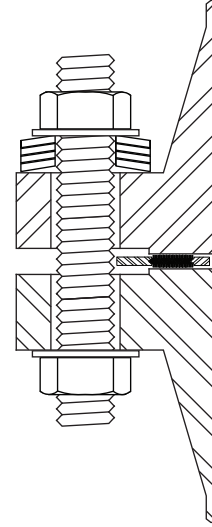

FLANGES OUT OF PARALLEL:

Total allowable out of parallel: $\Delta_1 + \Delta_2 = 0.015''$ (0.4 mm)

Note:

Deviation on right is less critical than deviation on left since bolt tightening will tend to bring flanges parallel due to flange bending.

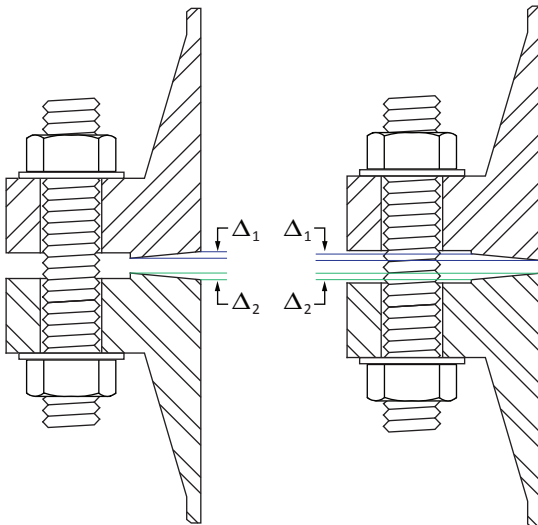

WAVY SURFACE FINISH:

Note:

1. If using jacketed or spiral wound gaskets - deviation should not exceed 0.015'' (0.4 mm).
2. If using solid metal gaskets - deviation should not exceed 0.005'' (0.13 mm).
3. If using rubber, more leeway is possible - suggested grade line total of 0.030'' (0.8 mm).

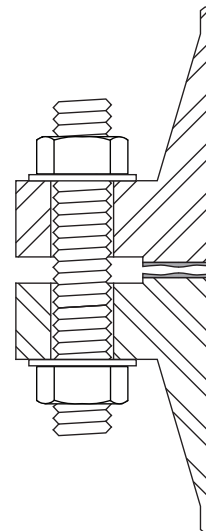



ASME SECTION VIII PRESSURE VESSELS DESIGN CONSIDERATIONS FOR BOLTED FLANGE CONNECTIONS

The primary purpose of the rules for bolted flange connections in Parts A and B of Appendix II is to insure safety, but there are certain practical matters to be taken into consideration in order to obtain a serviceable design. One of the most important of these is the proportioning of the bolting, i.e., determining the number and size of the bolts.

In the great majority of designs the practice that has been used in the past should be adequate, viz., to follow the design rules in Appendix II and tighten the bolts sufficiently to withstand the test pressure without leakage. The considerations presented in the following discussion will be important only when some unusual feature exists, such as a very large diameter, a high design pressure, a high temperature, severe temperature gradients, and unusual gasket arrangement, and so on.

The maximum allowable stress values for bolting given in the various tables of Subsection C are design values to be used in determining the minimum amount of bolting required under the rules. However, a distinction must be kept carefully in mind between the design value and the bolt stress that might actually exist or that might be needed for conditions other than the design pressure. The initial tightening of the bolts is a prestressing operation, and the amount of bolt stress developed must be within proper limits, to insure, on the one hand, that it is adequate to provide against all conditions that tend to produce a leaky joint, and on the other hand, that is not so excessive that yielding of the bolts and/or flanges can produce relaxation that also can result in leakage.

The first important consideration is the need for the joint to be tight in the hydrostatic test. An initial bolt stress of some magnitude must be provided. If it is not, further bolt strain develops during the test, which tends to part the joint and thereby to decompress the gasket enough to allow leakage. The test pressure is usually One and a half times the design pressure, and on this basis it may be thought that 50 percent extra bolt stress above the design value will be sufficient. However, this is an oversimplification, because, on the one hand, the safety factor against leakage under test conditions in general need not be as great as under operating conditions.

On the other hand, if a stress-strain analysis of the joint is made, it may indicate that an initial bolt stress still higher than 1 ½ times the design value is needed. Such an analysis is one that considers the changes in bolt elongation, flange deflection, and gasket load that take place with the application of internal pressure, starting from the prestressed condition. In any event, it is evident that an initial bolt stress higher than the design value may and, in some cases, must be developed in the tightening operation, and it is the intent of this Division of Section VIII that such a practice is permissible, provided it includes necessary and appropriate provision to insure against excessive flange distortion and gross crushing of the gasket.

It is possible for the bolt stress to decrease after initial tightening, because of slow creep or relaxation of the gasket, particularly in the case of the “softer” gasket materials. This may be the cause of leakage in the hydrostatic test, in which case it may suffice merely to retighten the bolts. A decrease in bolt stress can also occur in service at elevated temperatures, as a result of creep in the bolt and/or flange or gasket material, with consequent relaxation. When this results in leakage under service conditions, it is common practice to retighten the

bolts, and sometimes a single such operation, or perhaps several repeated at long intervals, is sufficient to correct the condition. To avoid chronic difficulties of this nature, however, it is advisable when designing a joint for high-temperature service to give attention to the relaxation properties of the materials involved, especially for temperatures where creep is the controlling factor in design. This prestress should not be confused with initial bolt stress, S_1 , used in the design of Part B flanges.

In the other direction, excessive initial bolt stress can present a problem in the form of yielding in the bolting itself, and may occur in the tightening operation to the extent of damage or even breakage. This is especially likely with bolts of small diameter and with bolt materials having a relatively low yield strength. The yield strength of mild carbon steel, annealed austenitic stainless steel, and certain of the nonferrous bolting materials can easily be exceeded with ordinary wrench effort in the smaller bolt sizes. Even if no damage is evident, any additional load generated when internal pressure is applied can produce further yielding with possible leakage. Such yielding can also occur when there is very little margin between initial bolt stress and yield strength.

An increase in bolt stress, above any that may be due to internal pressure, might occur in service during startup or other transient conditions, or perhaps even under normal operation. This can happen when there is an appreciable differential in temperature between the flanges and the bolts, or when the bolt material has a different coefficient of thermal expansion than the flange material. Any increase in bolt load due to this thermal effect, superposed on the load already existing, can cause yielding of the bolt material, whereas any pronounced decrease due to such effects can result in such a loss of bolt load as to be a direct cause of leakage. In either case, retightening of the bolts may be necessary, but it must not be forgotten that the effects of repeated retightening can be cumulative and may ultimately make the joint unserviceable.

In addition to the difficulties created by yielding of the bolts as described above, the possibility of similar difficulties arising from yielding of the flange or gasket material, under like circumstances or from other causes, should also be considered.

Excessive bolt stress, whatever the reason, may cause the flange to yield, even though the bolts may not yield. Any resulting excessive deflection of the flange, accompanied by permanent set, can produce a leaking joint when other effects are superposed. It can also damage the flange by making it more difficult to effect a tight joint thereafter. For example, irregular permanent distortion of the flange due to uneven bolt load around the circumference of the joint can warp the flange face and its gasket contact surface out of a true plane.

The gasket, too, can be overloaded, even without excessive bolt stress. The full initial bolt load is imposed entirely on the gasket, unless the gasket has a stop ring or the flange face detail is arranged to provide the equivalent. Without such means of controlling the compression of the gasket, consideration must be given to the selection of gasket type, size and material that will prevent gross crushing of the gasket.

From the foregoing, it is apparent that the bolt stress can vary over a considerable range above the design stress value. The design stress values for bolting in Subsection C have been set at a conservative value to provide a factor against yielding. At elevated temperatures, the design stress values are governed by the creep rate and stress-rupture strength. Any higher bolt stress existing before creep occurs in operation will have already served its purpose of seating the gasket and holding the hydrostatic test pressure, all at the design pressure and temperature.

Theoretically, the margin against flange yielding is not as great. The design values for flange materials may be as high as five-eighths or two-thirds of the yield strength. However, the highest stress in a flange is usually the bending stress in the hub or shell, and is more or less localized. It is too conservative to assume that local yielding is followed immediately by overall yielding of the entire flange. Even if a "plastic hinge" should develop, the ring portion of the flange takes up the portion of the load the hub and shell refuse to carry. Yielding is far more significant if it occurs first in the ring, but the limitation in the rules on the combined hub and ring stresses provides a safeguard. In this connection, it should be noted that a dual

set of stresses is given for some of the materials. In the ASME Boiler & Pressure Vessel Code, Section VIII: Division I, Table UHA-32, the lower values should be used in order to avoid yielding in the flanges.

Another very important item in bolting design is the question whether the necessary bolt stress is actually realized, and what special means of tightening, if any, must be employed. Most joints are tightened manually by ordinary wrenching, and it is advantageous to have designs that require no more than this. Some pitfalls must be avoided, however. The probable bolt stress developed manually, when using standard wrenches, is:

Where S is the bolt stress and d is the nominal diameter of the bolt. It can be seen that smaller bolts will have excessive stress unless judgement is exercised in pulling up on them. On the other hand, it will be impossible to develop the desired stress in very large bolts by ordinary hand wrenching. Impact wrenches may prove serviceable, but if not, resort may be had to such methods as preheating the bolt, or using hydraulically powered bolt tensioners. With some of these methods, control of the bolt stress is possible by means inherent in the procedure, especially if effective thread lubricants are employed, but in all cases the bolt stress can be regulated within reasonable tolerances by measuring the bolt elongation with suitable extensometer equipment. Ordinarily, simple wrenching without verification of the actual bolt stress meets all practical needs, and measured control of the stress is employed only when there is some special or important reason for doing so.

ALLOWABLE BOLT STRESS

The ASME Boiler & Pressure Vessel Code, Section VIII: Division I, Appendix S in particular deals with the bolt stress. For example, a flange designer should determine the necessary tightening at the given operating temperature specifically in accordance with the allowable stresses for the bolt material at the operating temperature. These allowable stresses are based on the particular material; and their strength at operating temperature.

Hydrostatic testing, which in the majority of cases is necessary to verify the system, is done at one and a half times the operational pressure. Consequently, a flanged joint designed in accordance with the ASME Code, which should be hydrostatic tested with a pressure higher than the design pressure, will require a higher initial stress on the stud to successfully pass the test.

Appendix S of the ASME Boiler & Pressure Vessel Code, Section VIII: Division I speaks in great length establishes that in order to pass the hydrostatic test, the bolts must be stressed to whatever level is required to satisfactorily pass the test. This introduces additional problems. In cases where low yield bolt material is being used, the stresses required in bolts sufficient to satisfactorily pass the test may exceed the yield point of the bolt material causing the bolts to fracture.

BOLT LOAD FORMULAS

The ASME Unfired Pressure Vessel Code, Section VIII, Division I defines the initial bolt load required to seat a gasket sufficiently as:

$$W_{m2} = \pi b G y$$

The required operating bolt load must be at least sufficient, under the most severe operating conditions, to contain the hydrostatic end force and, in addition, to maintain a residual compression load on the gasket that is sufficient to assure a tight joint ASME defines this bolt load as:

$$W_{m1} = \left(\frac{\pi}{4}\right) G^2 P + 2b \pi G m P$$

After W_{m1} and W_{m2} are calculated, then the minimum required bolt area A_m is determined:

$$A_{m1} = \frac{W_{m1}}{S_a}$$

$$A_{m2} = \frac{W_{m2}}{S_a}$$

$$\text{if } A_{m1} \geq A_{m2} \quad A_m = A_{m1}$$

$$\text{if } A_{m2} \geq A_{m1} \quad A_m = A_{m2}$$

Bolts are then selected so that the actual bolt area A_b is equal to or greater than A_m

$$A_b = (\text{Number of Bolts}) \times (\text{Minimum Cross-Sectional Area of Bolt in Square Inches})$$

$$A_b \geq A_m$$

The maximum unit load $Sg_{(max)}$ on the gasket bearing surface is equal to the total maximum bolt load in pounds divided by the actual sealing area of the gasket in square inches.

$$Sg_{(max)} = \frac{A_b S_a}{\frac{\pi}{4} [(OD - 0.125)^2 - (ID)^2]} \quad \left\{ \begin{array}{l} \text{Spiral} \\ \text{Wound} \\ \text{Gaskets} \end{array} \right.$$

$$Sg_{(max)} = \frac{A_b S_a}{\frac{\pi}{4} [(OD)^2 - (ID)^2]} \quad \left\{ \begin{array}{l} \text{All Other} \\ \text{Types of} \\ \text{Gaskets} \end{array} \right.$$

NOTATIONS SYMBOLS AND DEFINITIONS

Except as noted, the symbols and definitions below are those given in ASME Boiler and Pressure Vessel Code.

A_b = Actual total cross-sectional area of bolts at root of thread or section of least diameter under stress, square inches	N = Width, in inches, used to determine the basic gasket seating width b_0 , based upon the possible contact width of the gasket (Table 2)
A_m = Total required cross-sectional area of bolts, taken as the greater of A_{m1} or A_{m2} , square inches	P = Design pressure, pounds per square inch
A_{m1} = Total cross-sectional area of bolts at root of thread or section of least diameter under stress, required for the operating conditions	S_a = Allowable bolt stress at ambient temperature, pounds per square inch
A_{m2} = Total cross-sectional area of bolts at root of thread or section of least diameter under stress, required for gasket sealing	S_b = Allowable bolt stress at ambient temperature, pounds per square inch
b = Effective gasket or joint-contact-surface seating width, inches (Table 2)	S_g = Actual unit load at the gasket bearing surface, pounds per square inch
b_0 = Basic gasket sealing width, inches (Table 2)	W_{m1} = Required bolt load for operating conditions, pounds
G = Diameter at location of gasket load reaction (Table 2)	W_{m2} = Minimum required bolt load for gasket seating, pounds
m = Gasket factor (Table 1)	y = Gasket or joint-contact-surface unit seating load, minimum design seating stress, PSI (Table 1) pounds per square inch

TABLE 1 - GASKET MATERIALS AND CONTACT FACINGS

Gasket Factors (m) for Operating Conditions and Minimum Design Seating Stress (y) NOTE: This table gives a list of many commonly used gasket materials and contact facings with suggested design values of m and y that have generally proved satisfactory in actual service when using effective gasket seating width b given in Table 2-5.1. The design values and other details given in this table are suggested only and are not mandatory.				Refer to Table 2-5.1		
Gasket Material		Gasket Factor m	Min. design seating stress y (psi)	Sketches and Notes	Use Facing Sketch	Use Column
Self-Energizing types O Rings, Metallic, Elastomer other gasket types considered as self-seating		0	0	---	---	---
Elastomers without fabric. Below 75 Shore Durometer 75 or higher Shore Durometer		0.50 1.00	0 200		1 (a, b, c, d) 4, 5	
Elastomers with cotton fabric insertion		1.25	400			
Vegetable fiber		1.75	1100			
Spiral-wound metal, with nonmetallic filler		Carbon Stainless or Monel	3.00	10000		1 (a,b)
Corrugated metal, double jacketed with nonmetallic filler	Soft Aluminum	2.50	2900		1 (a,b)	
	Soft copper or brass	2.75	3700			
	Iron or soft steel	3.00	4500			
	Monel or 4-6% chrome	3.25	5500			
	Stainless steels	3.50	6500			
Corrugated metal	Soft Aluminum	2.75	3700		1 (a,b,c,d)	
	Soft copper or brass	3.00	4500			
	Iron or soft steel	3.25	5500			
	Monel or 4-6% chrome	3.50	6500			
	Stainless steels	3.75	7600			
Flat metal jacketed with nonmetallic filler	Soft Aluminum	3.25	5500		1a, 1b, 1c*, 1d*, 2*	
	Soft copper or brass	3.50	6500			
	Iron or soft steel	3.75	7600			
	Monel	3.50	8000			
	4-6% chrome Stainless steels	3.75 3.75	9000 9000			
Grooved metal	Soft Aluminum	3.25	5500		1 (a,b, c, d) 2, 3	
	Soft copper or brass	3.50	6500			
	Iron or soft steel	3.75	7600			
	Monel or 4-6% chrome	3.75	9000			
	Stainless steels	4.25	10100			
Solid flat metal	Soft Aluminum	4.00	8800		1 (a, b, c, d) 2,3,4,5	
	Soft copper or brass	4.75	13000			
	Iron or soft steel	5.50	18000			
	Monel or 4-6% chrome	6.00	21800			
	Stainless steels	6.50	26000			
Ring joint	Iron or soft steel	5.5	18000		6	
	Monel or 4-6% chrome	6.00	21800			
	Stainless steels	6.50	26000			

*The surface of a gasket having a lap should be against the smooth surface of the facing and not against the nubbin.

Reprinted with permission of ASME

TABLE 2 - EFFECTIVE GASKET SEATING WIDTH

Sketch #	Facing Sketch	Basic Gasket Seating Width, b_0	
		Column I	Column II
1(a)		$\frac{N}{2}$	$\frac{N}{2}$
1(b) See Note (1)			
1(c)		$\frac{w + T}{2}; \left(\frac{w + N}{4}\right) \text{ max.}$	$\frac{w + T}{2}; \left(\frac{w + N}{4}\right) \text{ max.}$
1(d) See Note (1)			
2		$\frac{w + N}{4}$	$\frac{w + 3N}{8}$
3		$\frac{N}{4}$	$\frac{3N}{8}$
4 See Note (1)		$\frac{3N}{8}$	$\frac{7N}{16}$
5 See Note (1)		$\frac{N}{4}$	$\frac{3N}{8}$
6		$\frac{w}{8}$...
<p>Effective Gasket Seating Width, b $b = b_0$, when $b_0 \leq \frac{1}{4}$ in.; $b = 0.5 \sqrt{b_0}$, when $b_0 > \frac{1}{4}$ in.</p>			

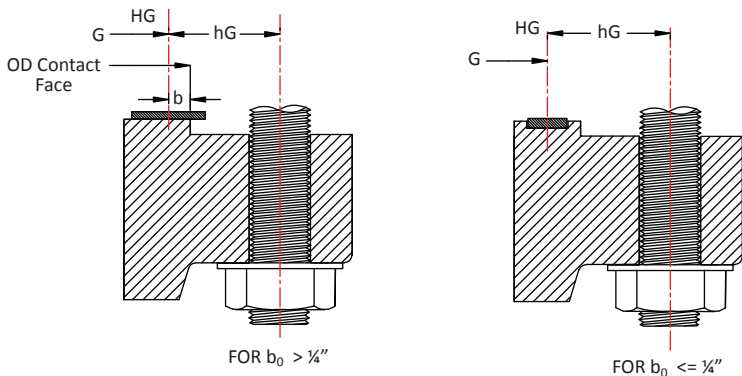

NOTES:

- (1) Where serrations do not exceed 1/64" depth and 1/32" width spacing, sketches (1b) and (1d) shall be used.
- (2) The gasket factors listed only apply to flanged joints in which the gasket is contained entirely within the inner edges of the bolt holes.

MECHANICS OF LOADING AND STRESSING A BOLT

When the nut is turned in a tightening direction by the applied torque (T), the flange, nut and bolt head surfaces are eventually put in contact along planes. This contact prevents further forward advance of the nut. Continued tightening is accomplished at the expense of metal deformations. While there are combination of metal deformations involved, normally only the tensile deformation in the bolt body is used to evaluate the resulting load.

When further torque is applied to the nut, the nut threads act on the bolt threads so as to pull the bolt up through the nut. This pull results in a lateral and axial deformation of the bolt body. The tensile force causing this deformation also causes an equally compressive load to be transferred from the nut and bolt head to the flanges.

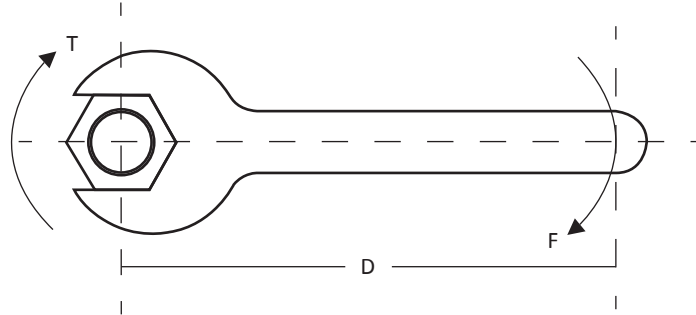

A step by step analysis of how a loading device for threaded fasteners works is as follows:

$$\mathbf{F \times D = T}$$

Where: F = Force in inch-lbs or (N)

D = Distance in inches, feet or (m)

T = Torque in inch-lbs, ft-lbs, (Nm)

For instance, if you were to pull on the end of a 12" wrench, distance D, with a force of 50 lbs, force F, the resulting torque would be:

$$\mathbf{F \times D = T}$$

$$50 \text{ lbs} \times 12" = 600 \text{ inch-lbs} \quad (222 \text{ N} \times 0.3048 \text{ m} = 68 \text{ Nm})$$

or

$$50 \text{ lbs} \times 1' = 50 \text{ ft-lbs}$$

An important step, often difficult to understand, is how we go from torque to bolt tension force. For a given size bolt and nut, a scale can be attached and measure the force F, shown above, and with a fixed distance D, the torque can be calculated. During this operation the bolt elongates and the amount of elongation could be measured. Another bolt of the same size is mounted in a tensile testing machine. This machine measures bolt tension force versus elongation. In the former case torque versus elongation was measured. In the latter case bolt tension force versus elongation was measured. Thus, torque versus bolt tension force can be correlated.

It is also important to note that friction and variability of the lever arm length (where the wrench is gripped) are all variables that contribute to the inaccuracies of using hand wrenches. Accurately translating this torque number into compressive stress requires a good understanding of the condition of the mating surfaces and friction factors involved throughout the bolted connection.

COMMON METALS DESCRIPTION

304 Stainless Steel: An 18-8 (Chromium 18-20%, Nickel 8-10%) Stainless with a maximum recommended working temperature of 1400°F (760°C). At least 80% of applications for non-corrosive services can use Type 304 Stainless in the temperature range of -320°F to 1000°F (-196°C to 538°C). Excellent corrosion resistance to a wide variety of chemicals. Subject to stress corrosion cracking and to intergranular corrosion at temperature range of 800°F to 1500°F (427 to 815°C) in presence of certain media for prolonged periods of time.

304L Stainless Steel: Carbon content maintained at a maximum of .03%. Recommended maximum working temperature of 1400°F (760°C) with same excellent corrosion resistance as type 304. The low carbon content tends to reduce the precipitation of carbides along grain boundaries. Less subject to intergranular corrosion than type 304.

316 Stainless Steel: 18-12 Chromium-Nickel steel with approximately 2% of Molybdenum added to the straight 18-8 alloy, which increases its strength at elevated temperatures and results in somewhat improved corrosion resistance. Has the highest creep strength at elevated temperatures of any conventional stainless type. Not suitable for extended service within the carbide precipitation range of 800°F to 1650°F (427°C to 899°C) when corrosive conditions are severe. Recommended maximum working temperature of 1400°F (760°C).

316-L Stainless Steel: Continuous maximum temperature range of 1400°F to 1500°F (760°C to 815°C). Carbon content held at a maximum of .03%. Subject to a lesser degree of stress corrosion cracking and also to intergranular corrossions than type 304.

347 Stainless Steel: 18-10 Chromium-Nickel steel with the addition of Columbium. Not as subject to intergranular corrosion as Type 304 is subject to stress corrosion. Recommended working temperature ranges 1400 to 1500°F (760°C to 815°C) and in some instances to 1700°F (927°C).

321 Stainless Steel: 18-10 Chromium-Nickel steel with a Titanium addition. Type 321 stainless has the same characteristics as Type 347. The recommended working temperature is 1400 to 1500°F (760°C to 815°C), and in some instances 1600°F (871°C).

410 Stainless Steel: 12% Chromium steel with a maximum temperature range of 1200°F to 1300°F (649°C to 704°C). Used for applications requiring good resistance to scaling at elevated temperatures. Is not recommended for use where severe corrosion is encountered but is still very useful for some chemical applications. May be used where dampness, alone or coupled with chemical pollution, causes steel to fail quickly.

502/501 Stainless Steel: 4-6% Chromium and 1/2 Molybdenum alloyed for mild corrosive resistance and elevated service. Maximum working temperature is 1200°F (649°C). If severe corrosion is anticipated, a better grade of stainless steel would probably be a better choice. Becomes extremely hard when welded.

Alloy 20: 45% Iron, 24% Nickel, 20% Chromium, and small amounts of Molybdenum and Copper. Maximum temperature range of 1400 to 1500°F (760°C to 815°C). Developed specifically for applications requiring resistance to corrosion by sulfuric acid.

Aluminum: Its excellent corrosion resistance and workability makes it ideal for double jacketed gaskets. Maximum continuous service temperature of 800°F (427°C).

Brass: Excellent to good corrosion resistance in most environments, but is not suitable for such materials as acetic acid, acetylene, ammonia, and salt. Maximum recommended temperature limit of 500°F (260°C).

Carbon Steel: Commercial quality sheet steel with an upper temperature limit of approximately 1000°F (538°C), particularly if conditions are oxidizing. Not suitable for handling crude acids or aqueous solutions of salts in the neutral or acid range. A high rate of failure may be expected in hot water service if the material is highly stressed. Concentrated acids and most alkalis have little or no action on iron and steel gaskets which are used regularly for such services.

Copper: Nearly pure copper with trace amounts of silver added to increase its working temperature. Recommended maximum continuous working temperature of 500°F (260°C).

Hastelloy B[®]: 26-30% Molybdenum, 62% Nickel, and 4-6% Iron. Maximum temperature range of 2000°F (1093°C). Resistant to hot, concentrated hydrochloric acid. Also resists the corrosive effects of wet hydrogen chlorine gas, sulfuric and phosphoric acid and reducing salt solutions. Useful for high temperature strength.

Hastelloy C-276[®]: 16-18% Molybdenum, 13-17.5% Chromium, 3.7-5.3% Tungsten, 4.5-7% Iron, and the balance is Nickel. Maximum temperature range of 2000°F. Very good in handling corrosives. High resistance to cold nitric acid of varying concentrations as well as boiling nitric acid up to 70% concentration. Good resistance to hydrochloric acid and sulfuric acid. Excellent resistance to stress corrosion cracking.

Inconel 600[®]: Recommended working temperatures of 2000°F (1093°C) and in some instances 2150°F (1177°C). It is a nickel base alloy containing 77 % Nickel, 15% Chromium, and 7% Iron. Excellent high temperature strength. Frequently used to overcome the problem of stress corrosion. Has excellent mechanical properties at the cryogenic temperature range.

Incoloy 800[®]: 32.5% Nickel, 46% Iron, 21% Chromium. Resistant to elevated temperatures, oxidation, and carburization. Recommended maximum temperature of 1600°F (871°C).

Monel[®]: Maximum temperature range of 1500°F (815°C) containing 67% Nickel and 30% Copper. Excellent resistance to most acids and alkalis, except strong oxidizing acids. Subject to stress corrosion cracking when exposed to fluorosilic acid, mercuric chloride and mercury, and should not be used with these media. With PTFE (Polytetrafluoroethylene), it is widely used for hydrofluoric acid service.

Nickel 200: Recommended maximum working temperature is 1400°F (760°C) and even higher under controlled conditions. Corrosion resistance makes it useful in caustic alkalis and where resistance in structural applications to corrosion is a prime consideration. Does not have all the around excellent resistance of Monel[®].

Titanium: Maximum temperature range of 2000°F (1093°C). Excellent corrosion resistance even at high temperatures. Known as the “Best solution” to chloride ion attack. Resistant to nitric acid in a wide range of temperatures and concentrations. Most alkaline solutions have little if any effect upon it. Outstanding in oxidizing environments.

Zirconium: Bio-compatible and non-toxic, excellent corrosion resistance to strong alkalis, most organic and inorganic acids and salt water environments where even the best stainless steels are not sufficient.

Duplex 2205: Dual Ferritic-Austenitic steel offers an excellent combination of both strength and corrosion resistance. Higher content of chrome and molybdenum provides superior resistance to general, pitting and crevice corrosion, while providing a higher yield strength over standard austenitic grades. Suitable for environments containing chlorides and hydrogen sulfide, dilute sulfuric acid solutions, organic acids.

AL6XN®: Of the 6 Moly group of materials, readily available in numerous forms. Superaustenitic stainless steel with excellent resistance to chloride pitting and crevice corrosion, and stress-corrosion cracking. Originally developed for seawater applications, offers good resistance to alkaline and salt solutions.

NOTE: Maximum Temperature ratings are based upon hot air constant temperatures. The presence of contaminating fluids and cyclic conditions may drastically affect the maximum temperature range

Monel®, Incoloy® and Inconel® are registered trademarks of Special Metals Corporation.

AL6XN® is a registered trademark of ATI Properties, Inc.

Hastelloy® is a registered trademark of Haynes International, Inc.

BOLT REFERENCE CHARTS FOR ASME B16.5 FLANGES

CLASS 150

NPS	Outside Diameter of Flange	Diameter of Bolt Circle	Diameter of Bolt Holes	Number of Bolts	Diameter of Bolts	Length of Stud Bolts [Note (1)]	
						Raised Face 0.06 in	Ring Joint
1/2	3 1/2	2 3/8	5/8	4	1/2	2 1/4	-
3/4	3 7/8	2 3/4	5/8	4	1/2	2 1/2	-
1	4 1/4	3 1/8	5/8	4	1/2	2 1/2	3
1 1/4	4 5/8	3 1/2	5/8	4	1/2	2 3/4	3 1/4
1 1/2	5	3 7/8	5/8	4	1/2	2 3/4	3 1/4
2	6	4 3/4	3/4	4	5/8	3 1/4	3 3/4
2 1/2	7	5 1/2	3/4	4	5/8	3 1/2	4
3	7 1/2	6	3/4	4	5/8	3 1/2	4
3 1/2	8 1/2	7	3/4	8	5/8	3 1/2	4
4	9	7 1/2	3/4	8	5/8	3 1/2	4
5	10	8 1/2	7/8	8	3/4	3 3/4	4 1/4
6	11	9 1/2	7/8	8	3/4	4	4 1/2
8	13 1/2	11 3/4	7/8	8	3/4	4 1/4	4 3/4
10	16	14 3/4	1	12	7/8	4 1/2	5
12	19	17	1	12	7/8	4 3/4	5 1/4
14	21	18 3/4	1 1/8	12	1	5 1/4	5 3/4
16	23 1/2	21 1/4	1 1/8	16	1	5 1/4	5 3/4
18	25	22 3/4	1 1/4	16	1 1/8	5 3/4	6 1/4
20	27 1/2	25	1 1/4	20	1 1/8	6 1/4	6 3/4
24	32	29 1/2	1 1/4	20	1 1/4	6 3/4	7 1/4

Dimensions in Inches

CLASS 300

NPS	Outside Diameter of Flange	Diameter of Bolt Circle	Diameter of Bolt Holes	Number of Bolts	Diameter of Bolts	Length of Stud Bolts [Note (1)]	
						Raised Face 0.06 in	Ring Joint
1/2	3 3/4	2 5/8	5/8	4	1/2	2 1/2	3
3/4	4 5/8	3 1/4	3/4	4	5/8	3	3 1/2
1	4 7/8	3 1/2	3/4	4	5/8	3	3 1/2
1 1/4	5 1/4	3 7/8	3/4	4	5/8	3 1/4	3 3/4
1 1/2	6 1/8	4 1/2	7/8	4	3/4	3 1/2	4
2	6 1/2	5	3/4	8	5/8	3 1/2	4
2 1/2	7 1/2	5 7/8	7/8	8	3/4	4	4 1/2
3	8 1/4	6 5/8	7/8	8	3/4	4 1/4	4 3/4
3 1/2	9	7 1/4	7/8	8	3/4	4 1/4	5
4	10	7 7/8	7/8	8	3/4	4 1/2	5
5	11	9 1/4	7/8	8	3/4	4 3/4	5 1/4
6	12 1/2	10 5/8	7/8	12	3/4	4 3/4	5 1/2
8	15	13	1	12	7/8	5 1/2	6
10	17 1/2	15 1/4	1 1/8	16	1	6 1/4	6 3/4
12	20 1/2	17 3/4	1 1/4	16	1 1/8	6 3/4	7 1/4
14	23	20 1/4	1 1/4	20	1 1/8	7	7 1/2
16	25 1/2	22 1/2	1 3/8	20	1 1/4	7 1/2	8
18	28	24 3/4	1 3/8	24	1 1/4	7 3/4	8 1/4
20	30 1/2	27	1 3/8	24	1 1/4	8	8 3/4
24	36	32	1 5/8	24	1 1/2	9	10

Dimensions in Inches

CLASS 600

NPS	Outside Diameter of Flange	Diameter of Bolt Circle	Diameter of Bolt Holes	Number of Bolts	Diameter of Bolts	Length of Stud Bolts [Note (1)]	
						Raised Face 0.06 in	Ring Joint
1/2	3 3/4	2 5/8	5/8	4	1/2	3	3
3/4	4 5/8	3 1/4	3/4	4	5/8	3 1/2	3 1/2
1	4 7/8	3 1/2	3/4	4	5/8	3 1/2	3 1/2
1 1/4	5 1/4	3 7/8	3/4	4	5/8	3 3/4	3 3/4
1 1/2	6 1/8	4 1/2	7/8	4	3/4	4 1/4	4 1/4
2	6 1/2	5	3/4	8	5/8	4 1/4	4 1/4
2 1/2	7 1/2	5 7/8	7/8	8	3/4	4 3/4	4 3/4
3	8 1/4	6 5/8	7/8	8	3/4	5	5
3 1/2	9	7 1/4	1	8	7/8	5 1/2	5 1/2
4	10 3/4	8 1/2	1	8	7/8	5 3/4	5 3/4
5	13	10 1/2	1 1/8	8	1	6 1/2	6 1/2
6	14	11 1/2	1 1/8	12	1	6 3/4	6 3/4
8	16 1/2	13 3/4	1 1/4	12	1 1/8	7 1/2	7 3/4
10	20	17	1 3/8	16	1 1/4	8 1/2	8 1/2
12	22	19 1/4	1 3/8	20	1 1/4	8 3/4	8 3/4
14	23 3/4	20 3/4	1 1/2	20	1 3/8	9 1/4	9 1/4
16	27	23 3/4	1 5/8	20	1 1/2	10	10
18	29 1/4	25 3/4	1 3/4	20	1 5/8	10 3/4	10 3/4
20	32	28 1/2	1 3/4	24	1 5/8	11 1/4	11 1/2
24	37	33	2	24	1 7/8	13	13 1/4

Dimensions in Inches

CLASS 900

NPS	Outside Diameter of Flange	Diameter of Bolt Circle	Diameter of Bolt Holes	Number of Bolts	Diameter of Bolts	Length of Stud Bolts [Note (1)]	
						Raised Face 0.06 in	Ring Joint
1/2	4 3/4	3 1/4	7/8	4	3/4	4 1/4	4 1/4
3/4	5 1/8	3 1/2	7/8	4	3/4	4 1/2	4 1/2
1	5 7/8	4	1	4	7/8	5	5
1 1/4	6 1/4	4 3/8	1	4	7/8	5	5
1 1/2	7	4 7/8	1 1/8	4	1	5 1/2	5 1/2
2	8 1/2	6 1/2	1	8	7/8	5 3/4	5 3/4
2 1/2	9 5/8	7 1/2	1 1/8	8	1	6 1/4	6 1/4
3	9 1/2	7 1/2	1	8	7/8	5 3/4	5 3/4
4	11 1/2	9 1/4	1 1/4	8	1 1/8	6 3/4	6 3/4
5	13 3/4	11	1 3/8	8	1 1/4	7 1/2	7 1/2
6	15	12 1/2	1 1/4	12	1 1/8	7 1/2	7 3/4
8	18 1/2	15 1/2	1 1/2	12	1 3/8	8 3/8	8 3/4
10	21 1/2	18 1/2	1 1/2	16	1 3/8	9 1/4	9 1/4
12	24	21	1 1/2	20	1 3/8	10	10
14	25 1/4	22	1 5/8	20	1 1/2	10 3/4	11
16	27 3/4	24 1/4	1 3/4	20	1 5/8	11 1/4	11 1/2
18	31	27	2	20	1 7/8	12 3/4	13 1/4
20	33 3/4	29 1/2	2 1/8	20	2	13 3/4	14 1/4
24	41	35 1/2	2 5/8	20	2 1/2	17 1/4	18

Dimensions in Inches

BOLT REFERENCE CHARTS FOR ASME B16.5 FLANGES CONT.

CLASS 1500

CLASS 2500

NPS	Outside Diameter of Flange	Diameter of Bolt Circle	Diameter of Bolt Holes	Number of Bolts	Diameter of Bolts	Length of Stud Bolts [Note (1)]	
						Raised Face 0.06 in	Ring Joint
1/2	4 3/4	3 1/4	7/8	4	3/4	4 1/4	4 1/4
3/4	5 1/8	3 1/2	7/8	4	3/4	4 1/2	4 1/2
1	5 7/8	4	1	4	7/8	5	5
1 1/4	6 1/4	4 3/8	1	4	7/8	5	5
1 1/2	7	4 7/8	1 1/8	4	1	5 1/2	5 1/2
2	8 1/2	6 1/2	1	8	7/8	5 3/4	5 3/4
2 1/2	9 5/8	7 1/2	1 1/8	8	1	6 1/4	6 1/4
3	10 1/2	8	1 1/4	8	1 1/8	7	7
4	12 1/4	9 1/2	1 3/8	8	1 1/4	7 3/4	7 3/4
5	14 3/4	11 1/2	1 5/8	8	1 1/2	9 3/4	9 3/4
6	15 1/2	12 1/2	1 1/2	12	1 3/8	10 1/4	10 1/2
8	19	15 1/2	1 3/4	12	1 5/8	11 1/2	12 3/4
10	23	19	2	12	1 7/8	13 1/4	13 1/2
12	26 1/2	22 1/2	2 1/8	16	2	14 3/4	15 1/4
14	29 1/2	25	2 3/8	16	2 1/4	16	16 3/4
16	32 1/2	27 3/4	2 5/8	16	2 1/2	17 1/2	18 1/2
18	36	30 1/2	2 7/8	16	2 3/4	19 1/2	20 3/4
20	38 3/4	32 3/4	3 1/8	16	3	21 1/4	22 1/4
24	46	39	3 5/8	16	3 1/2	24 1/4	25 1/2

Dimensions in Inches

NPS	Outside Diameter of Flange	Diameter of Bolt Circle	Diameter of Bolt Holes	Number of Bolts	Diameter of Bolts	Length of Stud Bolts [Note (1)]	
						Raised Face 0.06 in	Ring Joint
1/2	5 1/4	3 1/2	7/8	4	3/4	4 3/4	4 3/4
3/4	5 1/2	3 3/4	7/8	4	3/4	5	5
1	6 1/4	4 1/4	1	4	7/8	5 1/2	5 1/2
1 1/4	7 1/4	5 1/8	1 1/8	4	1	6	6
1 1/2	8	5 3/4	1 1/4	4	1 1/8	6 3/4	6 3/4
2	9 1/4	6 3/4	1 1/8	8	1	7	7
2 1/2	10 1/2	7 3/4	1 1/4	8	1 1/8	7 3/4	8
3	12	9	1 3/8	8	1 1/4	8 3/4	9
4	14	10 3/4	1 5/8	8	1 1/2	10	10 1/4
5	16 1/2	12 3/4	1 7/8	8	1 3/4	11 3/4	12 1/4
6	19	14 1/2	2 1/8	8	2	13 1/2	14
8	21 3/4	17 1/4	2 1/8	12	2	15	15 1/2
10	26 1/2	21 1/4	5 5/8	12	2 1/2	19 1/4	20
12	30	24 3/8	2 7/8	12	2 3/4	21 1/4	22

Dimensions in Inches

STANDARD LENGTH STUD BOLT

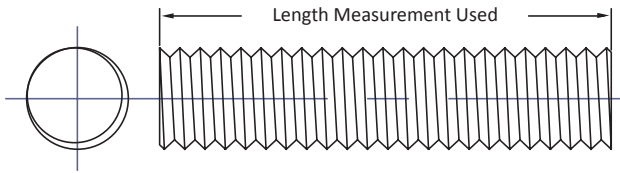

Note: (1) All studs are measured using effective thread length which is first thread to first thread. See diagrams above. Dimensions are in inches. Measurements based on ASME B 16.5 flange specifications.

NON-STANDARD LENGTH STUD BOLT

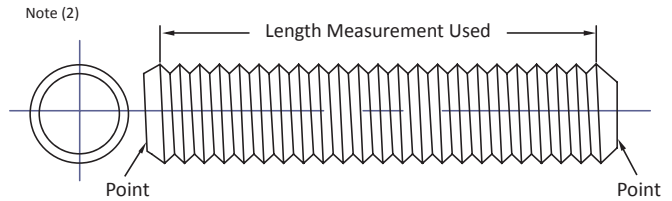

Note: (2) Length of point on studs and stud bolts shall be not less than one nor more than two complete threads as measured from the extreme end parallel to the axis. Typically 1/8" (3.175 mm).

BOLT REFERENCE CHARTS FOR ASME B16.47 SERIES A FLANGES

CLASS 150

NPS	Outside Diameter of Flange	Diameter of Bolt Circle	Diameter of Bolt Holes	Number of Bolts	Diameter of Bolts	Length of Stud Bolts [Note (1)]
26	34 1/4	31 3/4	1 3/8	24	1 1/4	8 3/4
28	36 1/2	34	1 3/8	28	1 1/4	9
30	38 3/4	36	1 3/8	28	1 1/4	9 1/4
32	41 3/4	38 1/2	1 5/8	28	1 1/2	10 1/2
34	43 3/4	40 1/2	1 5/8	32	1 1/2	10 1/2
36	46	42 3/4	1 5/8	32	1 1/2	11 1/4
38	48 3/4	45 1/4	1 5/8	32	1 1/2	11
40	50 3/4	47 1/4	1 5/8	36	1 1/2	11 1/4
42	53	49 1/2	1 5/8	36	1 1/2	11 3/4
44	55 1/4	51 3/4	1 5/8	40	1 1/2	12
46	57 1/4	53 3/4	1 5/8	40	1 1/2	12 1/4
48	59 1/2	56	1 5/8	44	1 1/2	12 3/4
50	61 3/4	58 1/4	1 7/8	44	1 3/4	13 1/2
52	64	60 1/2	1 7/8	44	1 3/4	13 3/4
54	66 1/4	62 3/4	1 7/8	44	1 3/4	14 1/4
56	68 3/4	65	1 7/8	48	1 3/4	14 1/2
58	71	67 1/4	1 7/8	48	1 3/4	14 3/4
60	73	69 1/4	1 7/8	52	1 3/4	15

Dimensions in Inches

CLASS 300

NPS	Outside Diameter of Flange	Diameter of Bolt Circle	Diameter of Bolt Holes	Number of Bolts	Diameter of Bolts	Length of Stud Bolts [Note (1)]
26	38 1/4	34 1/2	1 3/4	28	1 5/8	10 1/2
28	40 3/4	37	1 3/4	28	1 5/8	11
30	43	39 1/4	1 7/8	28	1 3/4	11 3/4
32	45 1/4	41 1/2	2	28	1 7/8	12 3/4
34	47 1/2	43 1/2	2	28	1 7/8	13
36	50	46	2 1/8	32	2	13 1/2
38	46	43	1 5/8	32	1 1/2	12 3/4
40	48 3/4	45 1/2	1 3/4	32	1 5/8	13 1/2
42	50 3/4	47 1/2	1 3/4	32	1 5/8	13 3/4
44	53 1/4	49 3/4	1 7/8	32	1 3/4	14 1/2
46	55 3/4	52	2	28	1 7/8	15
48	57 3/4	54	2	32	1 7/8	15 1/2
50	60 1/4	56 1/4	2 1/8	32	2	16 1/4
52	62 1/4	58 1/4	2 1/8	32	2	16 1/2
54	65 1/4	61	2 3/8	28	2 1/4	17 3/4
56	67 1/4	63	2 3/8	28	2 1/4	17 3/4
58	69 1/4	65	2 3/8	32	2 1/4	18 1/4
60	71 1/4	67	2 3/8	32	2 1/4	18 3/4

Dimensions in Inches

CLASS 400

NPS	Outside Diameter of Flange	Diameter of Bolt Circle	Diameter of Bolt Holes	Number of Bolts	Diameter of Bolts	Length of Stud Bolts [Note (1)]
26	38 1/4	34 1/2	1 7/8	28	1 3/4	12
28	40 3/4	37	2	28	1 7/8	13
30	43	39 1/4	2 1/8	28	2	13 1/2
32	45 1/4	41 1/2	2 1/8	28	2	14
34	47 1/2	43 1/2	2 1/8	28	2	14 1/4
36	50	46	2 1/8	32	2	14 1/2
38	47 1/2	44	1 7/8	32	1 3/4	15
40	50	46 1/4	2	32	1 7/8	15 1/2
42	52	48 1/4	2	32	1 7/8	16
44	54 1/2	50 1/2	2 1/8	32	2	16 1/2
46	56 3/4	52 3/4	2 1/8	36	2	17
48	59 1/2	55 1/4	2 3/8	28	2 1/4	18 1/4
50	61 3/4	57 1/2	2 3/8	32	2 1/4	18 3/4
52	63 3/4	59 1/2	2 3/8	32	2 1/4	19
54	67	62 1/4	2 5/8	28	2 1/2	20 1/4
56	69	64 1/4	2 5/8	32	2 1/2	20 1/2
58	71	66 1/4	2 5/8	32	2 1/2	20 3/4
60	74 1/4	69	2 7/8	32	2 3/4	22

Dimensions in Inches

CLASS 600

NPS	Outside Diameter of Flange	Diameter of Bolt Circle	Diameter of Bolt Holes	Number of Bolts	Diameter of Bolts	Length of Stud Bolts [Note (1)]
26	40	36	2	28	1 7/8	14
28	42 1/4	38	2 1/8	28	2	14 1/2
30	44 1/2	40 1/4	2 1/8	28	2	14 1/2
32	47	42 1/2	2 3/8	28	2 1/4	15 1/2
34	49	44 1/2	2 3/8	28	2 1/4	15 3/4
36	51 3/4	47	2 5/8	28	2 1/2	16 1/2
38	50	45 3/4	2 3/8	28	2 1/4	18 1/4
40	52	47 3/4	2 3/8	32	2 1/4	18 3/4
42	55 1/4	50 1/2	2 5/8	28	2 1/2	20
44	57 1/4	52 1/2	2 5/8	32	2 1/2	20 1/4
46	59 1/2	54 3/4	2 5/8	32	2 1/2	20 3/4
48	62 3/4	57 1/2	2 7/8	32	2 3/4	22 1/4
50	65 3/4	60	3 1/8	28	3	23 3/4
52	67 3/4	62	3 1/8	32	3	23 3/4
54	70	64 1/4	3 1/8	32	3	24 1/4
56	73	66 3/4	3 3/8	32	3 1/4	25 1/2
58	75	68 3/4	3 3/8	32	3 1/4	25 3/4
60	78 1/2	71 3/4	3 5/8	28	3 1/2	27 1/4

Dimensions in Inches

CLASS 900

NPS	Outside Diameter of Flange	Diameter of Bolt Circle	Diameter of Bolt Holes	Number of Bolts	Diameter of Bolts	Length of Stud Bolts [Note (1)]
26	42 3/4	37 1/2	2 7/8	20	2 3/4	18 1/4
28	46	40 1/4	3 1/8	20	3	19
30	48 1/2	42 3/4	3 1/8	20	3	19 1/2
32	51 3/4	45 1/2	3 3/8	20	3 1/4	20 3/4
34	55	48 1/4	3 5/8	20	3 1/2	21 3/4
36	57 1/2	50 3/4	3 5/8	20	3 1/2	22 1/4
38	57 1/2	50 3/4	3 5/8	20	3 1/2	23 3/4
40	59 1/2	52 3/4	3 5/8	24	3 1/2	24 1/4
42	61 1/2	54 3/4	3 5/8	24	3 1/2	25
44	64 7/8	57 5/8	3 7/8	24	3 3/4	26 1/4
46	68 1/4	60 1/2	4 1/8	24	4	27 1/2
48	70 1/4	62 1/2	4 1/8	24	4	28 1/4

Dimensions in Inches

BOLT REFERENCE CHARTS FOR ASME B16.47 SERIES B FLANGES

CLASS 150

NPS	Outside Diameter of Flange	Diameter of Bolt Circle	Diameter of Bolt Holes	Number of Bolts	Diameter of Bolts	Length of Stud Bolts [Note (1)]
26	30 15/16	29 5/16	7/8	36	3/4	5 1/2
28	32 15/16	31 5/16	7/8	40	3/4	5 3/4
30	34 15/16	33 5/16	7/8	44	3/4	5 3/4
32	37 1/16	35 7/16	7/8	48	3/4	5 3/4
34	39 9/16	37 11/16	1	40	7/8	6 1/4
36	41 5/8	39 3/4	1	44	7/8	6 3/4
38	44 1/4	42 1/8	1 1/8	40	1	7 1/4
40	46 1/4	44 1/8	1 1/8	44	1	7 1/4
42	48 1/4	46 1/8	1 1/8	48	1	7 1/2
44	50 1/4	48 1/8	1 1/8	52	1	7 3/4
46	52 13/16	50 9/16	1 1/4	40	1 1/8	8
48	54 13/16	52 9/16	1 1/4	44	1 1/8	8 1/4
50	56 13/16	54 9/16	1 1/4	48	1 1/8	8 1/2
52	58 13/16	56 9/16	1 1/4	52	1 1/8	8 3/4
54	61	58 3/4	1 1/4	56	1 1/8	8 3/4
56	63	60 3/4	1 1/4	60	1 1/8	9
58	65 15/16	63 7/16	1 3/8	48	1 1/4	9 1/4
60	67 15/16	65 7/16	1 3/8	52	1 1/4	9 1/2

Dimensions in Inches

CLASS 300

NPS	Outside Diameter of Flange	Diameter of Bolt Circle	Diameter of Bolt Holes	Number of Bolts	Diameter of Bolts	Length of Stud Bolts [Note (1)]
26	34 1/8	31 5/8	1 3/8	32	1 1/4	10 1/2
28	36 1/4	33 3/4	1 3/8	36	1 1/4	10 1/2
30	39	36 1/4	1 1/2	36	1 3/8	11 1/4
32	41 1/2	38 1/2	1 5/8	32	1 1/2	12 1/4
34	43 5/8	40 5/8	1 5/8	36	1 1/2	12 1/4
36	46 1/8	42 7/8	1 3/4	32	1 5/8	12 1/2
38	48 1/8	44 7/8	1 3/4	36	1 5/8	13 1/4
40	50 1/8	46 7/8	1 3/4	40	1 5/8	13 1/2
42	52 1/2	49	1 7/8	36	1 3/4	14
44	54 1/2	51	1 7/8	40	1 3/4	14 3/4
46	57 1/2	53 3/4	2	36	1 7/8	15
48	59 1/2	55 3/4	2	40	1 7/8	15
50	61 1/2	57 3/7	2	44	1 7/8	15 3/4
52	63 1/2	59 3/4	2	48	1 7/8	16
54	65 7/8	62 1/8	2	48	1 7/8	15 3/4
56	69 1/2	65	2 3/8	36	2 1/4	17 3/4
58	71 15/16	67 7/16	2 3/8	40	2 1/4	17 3/4
60	73 15/16	69 7/16	2 3/8	40	2 1/4	17 1/2

Dimensions in Inches

CLASS 400

NPS	Outside Diameter of Flange	Diameter of Bolt Circle	Diameter of Bolt Holes	Number of Bolts	Diameter of Bolts	Length of Stud Bolts [Note (1)]
26	33 1/2	30 3/4	1 1/2	28	1 3/8	11 1/4
28	36	33	1 5/8	24	1 1/2	12
30	38 1/4	35 1/4	1 5/8	28	1 1/2	12 1/2
32	40 3/4	37 1/2	1 3/4	28	1 5/8	13 1/2
34	42 3/4	39 1/2	1 3/4	32	1 5/8	13 3/4
36	45 1/2	42	1 7/8	28	1 3/4	15 1/2

Dimensions in Inches

CLASS 600

NPS	Outside Diameter of Flange	Diameter of Bolt Circle	Diameter of Bolt Holes	Number of Bolts	Diameter of Bolts	Length of Stud Bolts [Note (1)]
26	35	31 3/4	1 3/4	28	1 5/8	13 3/4
28	37 1/2	34	1 7/8	28	1 3/4	14 1/4
30	40 1/4	36 1/2	2	28	1 7/8	15 1/4
32	42 3/4	38 3/4	2 1/8	28	2	15 3/4
34	45 3/4	41 1/2	2 3/8	24	2 1/4	17 1/4
36	47 3/4	43 1/2	2 3/8	28	2 1/4	17 3/4

Dimensions in Inches

CLASS 900

NPS	Outside Diameter of Flange	Diameter of Bolt Circle	Diameter of Bolt Holes	Number of Bolts	Diameter of Bolts	Length of Stud Bolts [Note (1)]
26	40 1/4	35 1/2	2 5/8	20	2 1/2	17 1/4
28	43 1/2	38 1/4	2 7/8	20	2 3/4	19
30	46 1/2	40 3/4	3 1/8	20	3	20
32	48 3/4	43	3 1/8	20	3	20 1/4
34	51 3/4	45 1/2	3 3/8	20	3 1/4	21 3/4
36	53	47 1/4	3 1/8	24	3	21 1/4

Dimensions in Inches

TORQUE CHART

Nominal Diameter of Stud (Inches)	Diameter at Root of Threads (Inches)	Area at Root of Threads (Sq. Inches)	Bolt Stress					
			30,000 PSI		45,000 PSI		60,000 PSI	
			Torque Ft. Lbs.	Compression Lbs.	Torque Ft. Lbs.	Compression Lbs.	Torque Ft. Lbs.	Compression Lbs.
1/4	0.185	0.027	4	810	6	1215	8	1620
5/16	0.24	0.045	8	1350	12	2025	16	2700
3/8	0.294	0.068	12	2040	18	3060	24	4080
7/16	0.345	0.093	20	2790	30	4185	40	5580
1/2	0.4	0.126	30	3780	45	5670	60	7560
9/16	0.454	0.162	45	4860	68	7290	90	9720
5/8	0.507	0.202	60	6060	90	9090	120	12120
3/4	0.62	0.302	100	9060	150	13590	200	18120
7/8	0.731	0.419	160	12570	240	18855	320	25140
1	0.838	0.551	245	16530	368	24795	490	33060
1 1/8	0.963	0.728	355	21840	533	32760	710	43680
1 1/4	1.088	0.929	500	27870	750	41805	1000	55740
1 3/8	1.213	1.155	680	34650	1020	51975	1360	69300
1 1/2	1.338	1.405	800	42150	1200	63225	1600	84300
1 5/8	1.463	1.68	1100	50400	1650	75600	2200	100800
1 3/4	1.588	1.98	1500	59400	2250	89100	3000	118800
1 7/8	1.713	2.304	2000	69120	3000	103680	4000	138240
2	1.838	2.652	2200	79560	3300	119340	4400	159120
2 1/4	2.088	3.423	3180	102690	4770	154035	6360	205380
2 1/2	2.338	4.292	4400	128760	6600	193140	8800	257520
2 3/4	2.588	5.259	5920	157770	8880	236655	11840	315540
3	2.838	6.324	7720	189720	11580	284580	15440	379440



CHEMICAL RESISTANCE CHART

NON-METALLIC MATERIALS

A: Good Resistance
 B: Moderate Resistance
 C: Unsatisfactory

Media	PTFE				Compressed Sheet								Metal Reinforced FG	Mica
	Matrix L100	Matrix L104/CPG	Matrix L110	Matrix L120	L-420	L-430	L-440	L-441	L-433/L-443	L-450	L-540	L-640W		
Acetaldehyde	A	A	A	A	B	B	B	B	B	B	B	B	A	B
Acetamide	A	A	A	A	A	A	A	A	A	A	A	A	A	A
Acetic Acid	A	A	A	A	B	B	A	A	A	A	B	A	A	A
Acetic Acid Glacial	A	A	A	A	C	C	B	B	B	B	C	B	B	B
Acetic Anhydride	A	A	A	A	C	C	B	B	B	B	C	B	A	B
Acetone	A	A	A	A	B	B	B	B	B	B	B	B	A	B
Acetonitrile	A	A	A	A	C	C	C	C	C	C	C	C	A	-
Acetyl Chloride	A	A	A	A	C	C	C	C	C	C	C	C	A	-
Acetylene	A	A	A	A	A	A	A	A	A	A	A	A	A	B
Acrylic Acid	A	A	A	A	C	C	B	B	B	B	C	B	A	-
Acrylonitrile	A	A	A	A	C	C	C	C	C	C	C	C	A	-
Adipic Acid	A	A	A	A	A	A	A	A	A	A	A	A	A	A
Air	A	A	A	A	A	A	A	A	A	A	A	A	A	A
Allyl Chloride	A	A	A	A	C	C	C	C	C	C	C	C	B	-
Alum	A	A	A	A	A	A	A	A	A	A	A	A	A	A
Aluminium Acetate	A	A	A	A	A	A	A	A	A	A	A	A	A	A
Aluminium Chloride	A	A	A	A	A	A	A	A	A	A	A	A	A	A
Aluminium Hydroxide (Solid)	A	A	A	A	A	A	A	A	A	A	A	A	A	A
Aluminium Sulphate	A	A	A	A	A	A	A	A	A	A	A	A	A	A
Ammonia Gas	A	A	A	A	C	C	B	B	B	B	C	B	A	A
Ammonium Carbonate	A	A	A	A	A	A	A	A	A	A	A	A	A	A
Ammonium Chloride	A	A	A	A	B	B	A	A	A	A	B	A	C	A
Ammonium Hydroxide	A	A	A	A	A	A	A	A	A	A	A	A	A	A
Ammonium Sulphate	A	A	A	A	A	A	A	A	A	A	A	A	A	A
Amyl Acetate	A	A	A	A	C	C	B	B	B	B	C	B	A	A
Amyl Alcohol	A	A	A	A	A	A	A	A	A	A	A	A	A	A
Aniline	A	A	A	A	C	C	C	C	C	C	C	C	A	B
Arcton 12	A	A	A	A	C	C	C	C	C	C	B	C	B	C
Arcton 22	A	A	A	A	C	C	B	B	B	B	A	B	A	C
Asphalt	A	A	A	A	B	B	A	A	A	A	B	A	A	A
Aviation Fuel	A	A	A	A	A	A	A	A	A	A	B	B	A	A
Barium Chloride	A	A	A	A	A	A	A	A	A	A	A	A	A	A
Beer	A	A	A	A	A	A	A	A	A	A	A	A	A	A
Benzaldehyde	A	A	A	A	C	C	C	C	C	C	C	C	A	-
Benzene	A	A	A	A	B	B	A	A	A	A	B	A	A	B
Benzol	A	A	A	A	B	B	A	A	A	A	B	A	A	B
Benzyl Chloride	A	A	A	A	C	C	C	C	C	C	C	C	B	-
Benzoic Acid	A	A	A	A	C	C	B	B	B	B	C	B	A	A
Benzonitrile	A	A	A	A	C	C	C	C	C	C	C	C	C	-
Benzyl Alcohol	A	A	A	A	C	C	C	C	C	C	C	C	B	-
Blast Furnace Gas	A	A	A	A	B	B	A	A	A	A	B	A	A	A
Bleach (solution)	A	A	A	A	C	C	C	C	B	B	C	C	C	A
Boiler feed water	A	A	A	A	A	A	A	A	A	A	A	A	A	A
Borax	A	A	A	A	A	A	A	A	A	A	A	A	A	A
Boric Acid	A	A	A	A	A	A	A	A	A	A	A	A	A	A
Brine	A	A	A	A	A	A	A	A	A	A	A	A	A	A
Bromine	A	A	A	A	C	C	C	C	C	C	C	C	C	-

CHEMICAL RESISTANCE CHART (CONT.)

NON-METALLIC MATERIALS

A: Good Resistance
 B: Moderate Resistance
 C: Unsatisfactory

Media	PTFE				Compressed Sheet								Metal Reinforced FG	Mica
	Matrix L100	Matrix L104/CPG	Matrix L110	Matrix L120	L-420	L-430	L-440	L-441	L-433/L-443	L-450	L-540	L-640W		
Butadiene	A	A	A	A	C	C	C	C	C	C	C	C	A	-
Butane	A	A	A	A	B	B	A	A	A	A	B	A	A	A
Butanol	A	A	A	A	A	A	A	A	A	A	A	A	A	A
Butyl Acetate	A	A	A	A	C	C	B	B	B	B	C	B	A	B
Butyl Alcohol	A	A	A	A	A	A	A	A	A	A	A	A	A	B
Butyric Acid	A	A	A	A	B	B	A	A	A	A	B	A	A	B
Calcium Carbonate	A	A	A	A	A	A	A	A	A	A	A	A	A	A
Calcium Chloride	A	A	A	A	A	A	A	A	A	A	A	A	A	A
Calcium Hydroxide	A	A	A	A	A	A	A	A	A	A	A	A	A	A
Calcium Hypochlorite	A	A	A	A	A	A	A	A	A	A	A	A	A	A
Calcium Sulphate	A	A	A	A	A	A	A	A	A	A	A	A	A	A
Carbolic Acid	A	A	A	A	C	C	C	C	C	C	C	C	A	-
Carbon Dioxide	A	A	A	A	A	A	A	A	A	A	A	A	A	A
Carbon Disulphide	A	A	A	A	C	C	C	C	C	C	C	C	A	B
Carbon Monoxide	A	A	A	A	A	A	A	A	A	A	A	A	A	A
Carbon Tetrachloride	A	A	A	A	C	C	C	C	B	B	C	C	A	B
Castor Oil	A	A	A	A	A	A	A	A	A	A	A	A	A	A
Caustic Soda <25%	C	B	A	A	C	C	C	C	B	A	C	C	B	-
Caustic Soda <50%	C	B	A	A	C	C	C	C	B	B	C	C	B	-
Caustic Soda >50%	C	B	A	A	C	C	C	C	C	C	C	C	C	-
Chlorine Dioxide	A	A	A	A	C	C	C	C	C	C	C	C	C	C
Chlorine (Dry)	A	A	A	A	C	C	C	C	C	C	C	C	A	B
Chlorine (Wet)	A	A	A	A	C	C	C	C	C	C	C	C	C	C
Chlorine Liquid	A	A	A	A	C	C	C	C	C	C	C	C	B	-
Chloroacetic Acid	A	A	A	A	C	C	C	C	C	C	C	C	C	C
Chlorobezene	A	A	A	A	C	C	C	C	B	B	C	C	A	-
Chloroform	A	A	A	A	C	C	C	C	B	B	C	C	A	B
Chlorotrifluoride	C	C	C	C	C	C	C	C	C	C	C	C	C	C
Chromic Acid	A	A	A	A	C	C	C	C	C	C	C	C	C	B
Citric Acid	A	A	A	A	A	A	A	A	A	A	A	A	A	A
Copper Acetate	A	A	A	A	A	A	A	A	A	A	A	A	A	A
Copper Chloride	A	A	A	A	A	A	A	A	A	A	A	A	C	-
Copper Sulphate	A	A	A	A	A	A	A	A	A	A	A	A	A	A
Creosote	A	A	A	A	B	B	B	B	B	B	C	B	A	B
Cresol	A	A	A	A	B	B	B	B	B	B	C	B	A	A
Crude Oil	A	A	A	A	A	A	A	A	A	A	C	B	A	A
Cyclohexane	A	A	A	A	B	B	B	B	B	B	C	B	A	-
Cyclohexanol	A	A	A	A	A	A	A	A	A	A	A	A	A	A
Cyclohexanone	A	A	A	A	C	C	C	C	C	C	C	C	A	-
Dibenzyl Ether	A	A	A	A	C	C	C	C	C	C	C	C	A	B
Dibutyl Phthalate	A	A	A	A	B	B	B	B	B	B	B	B	A	A
Diethanolamine	A	A	A	A	B	B	B	B	B	B	B	B	A	B
Diethylamine	A	A	A	A	B	B	B	B	B	B	B	B	A	B
Di-iso Butyl Ketone	A	A	A	A	B	B	B	B	B	B	B	B	A	B
Dimethyl Formamide	A	A	A	A	C	C	C	C	C	C	C	C	A	-
Dimethylamine	A	A	A	A	B	B	B	B	B	B	C	B	A	-
Dioxane	A	A	A	A	B	B	B	B	B	B	C	B	A	-
Diphyl (Dowtherm A)	A	A	A	A	A	A	A	A	A	A	A	A	A	A
Ethane	A	A	A	A	A	A	A	A	A	A	A	A	A	A
Ethanol	A	A	A	A	A	A	A	A	A	A	A	A	A	A
Ethyl Acetate	A	A	A	A	B	B	B	B	B	B	C	B	A	B

A: Good Resistance
 B: Moderate Resistance
 C: Unsatisfactory

CHEMICAL RESISTANCE CHART (CONT.)

NON-METALLIC MATERIALS

Media	PTFE				Compressed Sheet								Metal Reinforced FG	Mica
	Matrix L100	Matrix L104/CPG	Matrix L110	Matrix L120	L-420	L-430	L-440	L-441	L-433/L-443	L-450	L-540	L-640W	LG-SS/LG-TC	
Ethyl Acrylate	A	A	A	A	C	C	C	C	C	C	C	C	A	-
Ethyl Alcohol	A	A	A	A	A	A	A	A	A	A	A	A	A	B
Ethyl Chloride (Dry)	A	A	A	A	C	C	C	C	B	B	C	C	A	B
Ethyl Ether	A	A	A	A	A	A	A	A	A	A	B	B	A	B
Ethylbenzene	A	A	A	A	B	B	B	B	B	B	C	B	A	-
Ethylene	A	A	A	A	A	A	A	A	A	A	A	A	A	A
Ethylene Chloride	A	A	A	A	C	C	C	C	C	C	C	C	A	B
Ethylene Glycol	A	A	A	A	A	A	A	A	A	A	A	A	A	A
Ferric Chloride	A	A	A	A	B	B	B	B	A	A	C	B	C	-
Ferric Sulphate	A	A	A	A	A	A	A	A	A	A	A	A	A	A
Fluorine Dioxide	C	C	C	C	C	C	C	C	C	C	C	C	C	C
Fluorine Gas	C	C	C	C	C	C	C	C	C	C	C	C	C	C
Fluorine Liquid	C	C	C	C	C	C	C	C	C	C	C	C	C	C
Formaldehyde	A	A	A	A	B	B	B	B	B	B	B	B	A	B
Formamide	A	A	A	A	B	B	B	B	B	B	B	B	A	B
Formic Acid 10%	A	A	A	A	A	A	A	A	A	A	A	A	A	A
Formic Acid 85%	A	A	A	A	B	B	B	B	B	B	C	B	A	B
Fuel Oil	A	A	A	A	A	A	A	A	A	A	A	B	A	A
Fuel Oil (Acid)	A	A	A	A	A	A	A	A	A	A	B	B	A	A
Furfural	A	A	A	A	C	C	C	C	C	C	B	C	A	A
Gas (LPG)	A	A	A	A	A	A	A	A	A	A	A	A	A	A
Gas (Natural)	A	A	A	A	A	A	A	A	A	A	A	A	A	A
Gas Oil	A	A	A	A	A	A	A	A	A	A	A	B	A	A
Gasoline	A	A	A	A	A	A	A	A	A	A	A	B	A	B
Glucose	A	A	A	A	A	A	A	A	A	A	A	A	A	A
Glue	A	A	A	A	A	A	A	A	A	A	A	A	A	A
Glycerine	A	A	A	A	A	A	A	A	A	A	A	A	A	A
Glycol	A	A	A	A	A	A	A	A	A	A	A	A	A	A
Heating Oil	A	A	A	A	A	A	A	A	A	A	A	B	A	A
Heptane	A	A	A	A	A	A	A	A	A	A	A	A	A	A
Hexane	A	A	A	A	A	A	A	A	A	A	A	A	A	A
Hydraulic Oil	A	A	A	A	A	A	A	A	A	A	A	B	A	A
Hydrobromic Acid	A	A	A	A	C	C	C	C	C	C	C	C	C	C
Hydrochloric Acid 20%	A	A	A	A	C	C	C	C	C	C	C	C	A	A
Hydrochloric Acid 37%	A	A	A	A	C	C	C	C	C	C	C	C	A	A
Hydrofluoric Acid <65%	C	C	A	A	C	C	C	C	C	C	C	C	C	C
Hydrofluoric Acid >65%	C	C	B	A	C	C	C	C	C	C	C	C	C	C
Hydrofluorosillic Acid	C	C	B	A	C	C	C	C	C	C	C	C	C	C
Hydrogen	A	A	A	A	A	A	A	A	A	A	A	A	A	A
Hydrogen Chloride (Dry)	A	A	A	A	C	C	C	C	C	C	C	C	A	-
Hydrogen Fluoride	C	C	C	C	C	C	C	C	C	C	C	C	C	C
Hydrogen Peroxide (6%)	A	A	A	A	B	B	B	B	B	B	B	B	A	A
Hydrogen Sulphide	A	A	A	A	B	B	B	B	B	B	B	B	C	-
Iso-Octane	A	A	A	A	A	A	A	A	A	A	B	B	A	A
Isopropyl Acetate	A	A	A	A	B	B	B	B	B	B	B	B	A	-
Isopropyl Alcohol	A	A	A	A	A	A	A	A	A	A	B	B	A	B
Isopropyl Ether	A	A	A	A	B	B	B	B	B	B	B	B	A	B
Kerosene	A	A	A	A	A	A	A	A	A	A	A	A	A	A
Lactic Acid	A	A	A	A	B	B	B	B	B	B	B	B	B	A
Linseed Oil	A	A	A	A	A	A	A	A	A	A	A	B	A	A
Liquid Petroleum Gas	A	A	A	A	A	A	A	A	A	A	A	A	A	A

CHEMICAL RESISTANCE CHART (CONT.)

NON-METALLIC MATERIALS

A: Good Resistance
 B: Moderate Resistance
 C: Unsatisfactory

Media	PTFE				Compressed Sheet								Metal Reinforced FG	Mica
	Matrix L100	Matrix L104/CPG	Matrix L110	Matrix L120	L-420	L-430	L-440	L-441	L-433/L-443	L-450	L-540	L-640W		
Lubricating Oil	A	A	A	A	A	A	A	A	A	A	A	B	A	A
Lye (Caustic)	C	B	A	A	C	C	C	C	C	C	C	C	C	C
Machine Oil	A	A	A	A	A	A	A	A	A	A	A	B	A	A
Magnesium Chloride	A	A	A	A	A	A	A	A	A	A	A	A	A	A
Magnesium Hydroxide	A	A	A	A	A	A	A	A	A	A	B	B	A	A
Magnesium Sulphate	A	A	A	A	A	A	A	A	A	A	A	A	A	A
Manganese Chloride	A	A	A	A	C	C	C	C	C	C	C	C	C	-
Maleic Acid	A	A	A	A	B	B	B	B	B	B	B	B	A	B
Maleic Anhydride	A	A	A	A	C	C	C	C	C	C	C	C	A	-
Mercuric Chloride	A	A	A	A	A	A	A	A	A	A	B	A	B	-
Mercury	A	A	A	A	A	A	A	A	A	A	A	A	A	A
Methane	A	A	A	A	A	A	A	A	A	A	A	A	A	A
Methanol	A	A	A	A	A	A	A	A	A	A	A	A	A	A
Methyl Alcohol	A	A	A	A	A	A	A	A	A	A	A	A	A	A
Methyl Chloride	A	A	A	A	B	B	B	B	B	B	B	B	A	B
Methyl Ethyl Ketone	A	A	A	A	B	B	B	B	B	B	B	B	A	B
Methyl Methacrylate	A	A	A	A	C	C	C	C	C	C	C	C	A	-
Methylated Spirits	A	A	A	A	A	A	A	A	A	A	A	A	A	A
Methylene Chloride	A	A	A	A	C	C	C	C	C	C	C	C	C	C
Mineral Oil	A	A	A	A	A	A	A	A	A	A	A	B	A	A
Mobiltherm 600	A	A	A	A	A	A	A	A	A	A	A	B	A	A
Mobiltherm 603 / 605	A	A	A	A	A	A	A	A	A	A	A	B	A	A
Molten Alkali Metals	C	C	C	C	C	C	C	C	C	C	C	C	C	C
Motor Oil	A	A	A	A	A	A	A	A	A	A	A	B	A	A
Muriatic Acid	A	A	A	A	C	C	C	C	C	C	C	C	C	C
Naptha	A	A	A	A	A	A	A	A	A	A	A	A	A	A
Naphthalene	A	A	A	A	C	C	C	C	C	C	C	C	B	-
Natural Gas	A	A	A	A	A	A	A	A	A	A	A	A	A	B
Nickel Chloride	A	A	A	A	A	A	A	A	A	A	A	A	A	A
Nickel Sulphate	A	A	A	A	A	A	A	A	A	A	A	A	A	A
Nitric Acid <30%	A	A	A	A	C	C	C	C	C	C	C	C	C	-
Nitric Acid >30%	A	A	A	A	C	C	C	C	C	C	C	C	C	-
Nitric Acid Red Fuming	A	A	A	A	C	C	C	C	C	C	C	C	C	-
Nitrogen	A	A	A	A	A	A	A	A	A	A	A	A	A	A
Nitrous Acid	A	A	A	A	C	C	C	C	C	C	C	C	C	C
Nitrous Oxide	A	A	A	A	B	B	B	B	A	A	B	B	C	-
Octane	A	A	A	A	A	A	A	A	A	A	A	A	A	A
Oleic Acid	A	A	A	A	A	A	A	A	A	A	A	A	A	A
Oleum	A	A	C	A	C	C	C	C	C	C	C	C	C	-
Oxalic Acid	A	A	A	A	C	C	C	C	C	C	C	C	A	A
Oxygen (BAM Approved*)	A*	A	A*	A	B	B	B	B	B	B	B	B	A	A
Palmitic Acid	A	A	A	A	A	A	A	A	A	A	A	A	A	A
Paraffin	A	A	A	A	A	A	A	A	A	A	B	B	A	A
Pentane	A	A	A	A	A	A	A	A	A	A	A	A	A	A
Perchlorethylene	A	A	A	A	C	C	C	C	C	C	C	C	A	-
Petroleum	A	A	A	A	A	A	A	A	A	A	B	B	A	A
Petroleum Oils-Crude	A	A	A	A	A	A	A	A	A	A	B	B	A	A
Phenol	A	A	A	A	C	C	C	C	C	C	C	C	A	A
Phosgene	A	A	A	A	C	C	C	C	C	C	C	C	A	-
Phosphoric Acid <45%	A	A	A	A	C	C	C	C	C	C	C	C	A	-
Phosphoric Acid >45%	B	B	A	A	C	C	C	C	C	C	C	C	C	-

A: Good Resistance
 B: Moderate Resistance
 C: Unsatisfactory

CHEMICAL RESISTANCE CHART (CONT.) NON-METALLIC MATERIALS

Media	PTFE				Compressed Sheet								Metal Reinforced FG	Mica
	Matrix L100	Matrix L104/CPG	Matrix L110	Matrix L120	L-420	L-430	L-440	L-441	L-433/L-443	L-450	L-540	L-640W		
Phthalic Acid	A	A	A	A	A	A	A	A	A	A	A	A	A	A
Phthalic Anhydride	A	A	A	A	C	C	C	C	C	C	C	C	A	-
Picric Acid	A	A	A	A	B	B	B	B	B	B	C	C	B	-
Potassium Acetate	A	A	A	A	A	A	A	A	A	A	A	A	A	A
Potassium Bromide	A	A	A	A	B	B	B	B	B	B	B	B	B	B
Potassium Carbonate	A	A	A	A	A	A	A	A	A	A	A	A	A	A
Potassium Chlorate	A	A	A	A	A	A	A	A	A	A	A	A	A	A
Potassium Chloride	A	A	A	A	A	A	A	A	A	A	A	A	A	A
Potassium Cyanide	A	A	A	A	A	A	A	A	A	A	A	A	A	A
Potassium Dichromate <20%	A	A	A	A	A	A	A	A	A	A	A	A	A	A
Potassium Hydroxide <50%	C	C	A	A	C	C	C	C	C	C	C	C	A	A
Potassium Hydroxide >50%	C	C	A	A	C	C	C	C	C	C	C	C	A	A
Potassium Hypochlorite	A	A	A	A	C	C	C	C	C	C	C	C	C	-
Potassium Nitrate	A	A	A	A	A	A	A	A	A	A	A	A	A	A
Potassium Permanganate	A	A	A	A	A	A	A	A	A	A	A	A	A	A
Potassium Sulphate	A	A	A	A	A	A	A	A	A	A	A	A	A	A
Producer Gas	A	A	A	A	A	A	A	A	A	A	A	A	A	A
Propane	A	A	A	A	A	A	A	A	A	A	A	A	A	A
Pyridine	A	A	A	A	C	C	C	C	C	C	C	C	A	B
Rape Seed Oil	A	A	A	A	A	A	A	A	A	A	A	A	A	A
Refrigerant R11	A	A	A	A	A	A	A	A	A	A	A	A	A	A
Refrigerant R112	A	A	A	A	A	A	A	A	A	A	A	A	A	A
Refrigerant R113	A	A	A	A	A	A	A	A	A	A	A	A	A	A
Refrigerant R114	A	A	A	A	A	A	A	A	A	A	A	A	A	A
Refrigerant R114B2	A	A	A	A	A	A	A	A	A	A	A	A	A	A
Refrigerant R115	A	A	A	A	A	A	A	A	A	A	A	A	A	A
Refrigerant R12	A	A	A	A	A	A	A	A	A	A	A	A	A	A
Refrigerant R123	A	A	A	A	B	B	B	B	B	B	A	B	B	A
Refrigerant R125	A	A	A	A	B	B	B	B	B	B	A	B	B	A
Refrigerant R13	A	A	A	A	A	A	A	A	A	A	A	A	A	A
Refrigerant R13B1	A	A	A	A	A	A	A	A	A	A	A	A	A	A
Refrigerant R134A	A	A	A	A	A	A	A	A	A	A	A	A	A	A
Refrigerant R141A	A	A	A	A	A	A	A	A	A	A	A	A	A	A
Refrigerant R141B	A	A	A	A	A	A	A	A	A	A	A	A	A	A
Refrigerant R152A	A	A	A	A	A	A	A	A	A	A	A	A	A	A
Refrigerant R22	A	A	A	A	B	B	B	B	B	B	A	B	A	A
Refrigerant R402A	A	A	A	A	A	A	A	A	A	A	A	A	A	A
Refrigerant R402B	A	A	A	A	A	A	A	A	A	A	A	A	A	A
Refrigerant R404A	A	A	A	A	A	A	A	A	A	A	A	A	A	A
Refrigerant R502	A	A	A	A	A	A	A	A	A	A	A	A	A	A
Refrigerant R507	A	A	A	A	A	A	A	A	A	A	A	A	A	A
Salicylic Acid	A	A	A	A	B	B	B	B	B	B	B	B	B	A
Santotherm 66	A	A	A	A	A	A	A	A	A	A	A	A	A	A
Sea Water	A	A	A	A	A	A	A	A	A	A	A	A	A	A
Sewage	A	A	A	A	A	A	A	A	A	A	B	A	B	A
Silicone Oil	A	A	A	A	A	A	A	A	A	A	A	A	A	A
Silver Nitrate	A	A	A	A	A	A	A	A	A	A	A	A	A	A
Soap	A	A	A	A	A	A	A	A	A	A	A	A	A	A
Sodium Aluminate	A	A	A	A	A	A	A	A	A	A	A	A	A	A
Sodium Bicarbonate	A	A	A	A	A	A	A	A	A	A	A	A	A	A
Sodium Bisulphite	A	A	A	A	A	A	A	A	A	A	A	A	A	A

See Recognized Temperature Limits on page 1??

CHEMICAL RESISTANCE CHART (CONT.)

NON-METALLIC MATERIALS

A: Good Resistance
 B: Moderate Resistance
 C: Unsatisfactory

Media	PTFE				Compressed Sheet								Metal Reinforced FG	Mica
	Matrix L100	Matrix L104/CPG	Matrix L110	Matrix L120	L-420	L-430	L-440	L-441	L-433/L-443	L-450	L-540	L-640W		
Sodium Carbonate	A	A	A	A	A	A	A	A	A	A	A	A	B	A
Sodium Chloride	A	A	A	A	A	A	A	A	A	A	A	A	A	A
Sodium Hydroxide <25%	C	B	A	A	C	C	C	C	B	A	C	C	B	-
Sodium Hydroxide <50%	C	B	A	A	C	C	C	C	B	B	C	C	B	-
Sodium Hydroxide >50%	C	B	A	A	C	C	C	C	C	C	C	C	C	-
Sodium Hypochlorite	A	A	A	A	C	C	C	C	C	C	C	C	C	-
Sodium Nitrate	A	A	A	A	B	B	B	B	B	B	B	B	B	B
Sodium Peroxide	A	A	A	A	C	C	C	C	C	C	C	C	C	-
Sodium Phosphate	A	A	A	A	A	A	A	A	A	A	A	A	A	A
Sodium Silicate	A	A	A	A	A	A	A	A	A	A	A	A	A	A
Sodium Sulphate	A	A	A	A	A	A	A	A	A	A	A	A	A	A
Sodium Sulphide	A	A	A	A	A	A	A	A	A	A	A	A	A	A
Stannic Chloride	A	A	A	A	B	B	B	B	B	B	C	B	C	-
Starch	A	A	A	A	A	A	A	A	A	A	A	A	A	A
Steam	A	A	A	A	B	B	B	B	A	A	B	A	A	A
Stearic Acid	A	A	A	A	B	B	A	A	A	A	B	A	A	A
Styrene	A	A	A	A	C	C	C	C	C	C	C	C	A	-
Sugar	A	A	A	A	A	A	A	A	A	A	A	A	A	A
Sulphur	A	A	A	A	B	B	B	B	A	A	B	B	A	A
Sulphur Chloride	A	A	A	A	C	C	C	C	C	C	C	C	C	-
Sulphur Dioxide Dry	A	A	A	A	C	C	C	C	C	C	C	C	A	A
Sulphur-Molten	A	A	A	A	C	C	C	C	C	C	C	C	B	-
Sulphur Trioxide	A	A	A	A	C	C	C	C	C	C	C	C	B	-
Sulphuric Acid (Fuming)	A	A	C	A	C	C	C	C	C	C	C	C	C	C
Sulphuric Acid 30%	A	A	A	A	C	C	C	C	C	C	C	C	C	C
Sulphuric Acid 50%	A	A	A	A	C	C	C	C	C	C	C	C	C	C
Sulphuric Acid 96%	A	A	A	A	C	C	C	C	C	C	C	C	C	C
Sulphurous Acid	A	A	A	A	C	C	C	C	C	C	C	C	C	A
Tannic Acid	A	A	A	A	A	A	A	A	A	A	A	A	A	A
Tar	A	A	A	A	B	B	A	A	A	A	C	B	A	A
Tartaric Acid	A	A	A	A	A	A	A	A	A	A	A	A	A	A
Tetrachlorethylene	A	A	A	A	C	C	C	C	C	C	C	C	A	B
Thermal Oil	A	A	A	A	A	A	A	A	A	A	A	B	A	A
Toluene	A	A	A	A	B	B	B	B	A	A	B	B	A	A
Transmission Oil	A	A	A	A	A	A	A	A	A	A	A	B	A	A
Trichlorethylene	A	A	A	A	B	B	B	B	B	B	B	B	A	B
Triethanolamine	A	A	A	A	A	A	A	A	A	A	A	A	A	A
Turpentine	A	A	A	A	A	A	A	A	A	A	A	A	A	A
Urea	A	A	A	A	A	A	A	A	A	A	A	A	A	A
Vegetable Oil	A	A	A	A	A	A	A	A	A	A	A	A	A	A
Vinegar	A	A	A	A	A	A	A	A	A	A	A	A	A	A
Vinyl Acetate	A	A	A	A	C	C	C	C	C	C	C	C	A	A
Vinyl Chloride	A	A	A	A	C	C	C	C	C	C	C	C	A	-
Vinyl Bromide	A	A	A	A	C	C	C	C	C	C	C	C	A	A
Water	A	A	A	A	A	A	A	A	A	A	A	A	A	A
White Spirit	A	A	A	A	A	A	A	A	A	A	A	B	A	A
Xylene	A	A	A	A	A	A	A	A	A	A	A	B	A	A
Zinc Chloride	A	A	A	A	A	A	A	A	A	A	A	A	A	A
Zinc Sulphate	A	A	A	A	A	A	A	A	A	A	A	A	A	A

See Recognized Temperature Limits on page 1??

A: Good Resistance
 B: Moderate Resistance
 C: Unsatisfactory

CHEMICAL RESISTANCE CHART METALLIC MATERIALS

Media	Metal										
	Aluminum	Alloy 20	Copper	Hastelloy	Inconel 600	Monel 400	Nickel 200	304 SS	316 SS	410 SS	Steel
Acetic Acid (Room Temp.)	A	A	A	A	B	B	B	B	A	A	C
Acetic Anhydride (Room Temp.)	A	A	A	A	B	B	A	A	A	A	B
Acetone	A	A	A	A	A	A	A	A	A	A	A
Aluminum Chloride (Room Temp.)	C	A	B	A	--	B	B	C	C	C	C
Alumium Fluoride (Room Temp.)	B	A	B	A	--	B	B	C	C	C	B
Aluminum Sulphate	B	A	B	A	B	B	B	A	A	B	C
Ammonia (Anhydrous)	A	A	C	A	A	B	B	A	A	A	B
Ammonium Chloride	C	A	C	A	A	B	B	C	B	B	B
Ammonium Hydroxide	B	A	C	A	A	C	C	A	A	A	A
Ammonium Nitrate	A	A	C	A	B	C	C	A	A	A	A
Ammonium Phosphate	A	A	B	A	B	B	B	A	A	A	C
Ammonium Sulphate	C	A	B	A	B	B	B	C	A	A	A
Amyl Acetate	A	A	A	A	A	A	A	A	A	--	B
Aniline	B	A	A	A	B	B	B	A	A	A	A
Barium Chloride	B	A	B	A	A	--	B	B	A	A	B
Beer	A	A	A	A	A	A	A	A	A	A	A
Benzene	A	A	A	A	A	A	B	A	A	A	A
Benzol	A	A	A	A	B	A	B	A	A	A	A
Borax	A	--	A	A	A	A	--	A	A	A	A
Boric Acid	A	A	A	A	B	B	B	A	A	A	C
Bromine	A	A	A	A	A	A	A	C	C	C	C
Butyl Alcohol	A	A	A	A	A	A	A	A	A	A	A
Calcium Carbonate	A	A	A	A	A	A	A	A	A	A	A
Calcium Chloride	B	A	A	A	A	B	B	B	A	C	A
Calcium Hydroxide	B	A	A	A	B	B	B	B	B	A	A
Calcium Hypochlorite	C	C	C	A	C	C	B	B	A	B	C
Carbolic Acid	A	A	A	A	B	B	B	A	A	C	C
Carbon Tetrachloride	B	A	B	A	A	A	A	A	A	A	C
Chlorine - Dry	A	A	A	A	A	A	A	C	C	C	A
Chlorine - Wet	C	C	C	C	B	B	B	C	C	C	C
Chromic Acid	B	A	C	A	B	C	C	A	A	B	--
Citric Acid	A	A	A	A	B	B	B	A	A	A	C
Copper Chloride	C	--	C	A	C	C	C	C	B	B	B
Copper Sulphate	C	A	B	A	B	B	B	A	A	A	C
Creosote (Coal Tar)	B	A	A	--	B	B	B	A	A	--	A
Crude Oil	A	A	B	A	--	B	--	A	A	A	A
Ether	A	A	A	A	B	B	B	A	A	A	A
Ethyl Acetate	A	A	A	A	A	A	A	A	A	--	A
Ethyl Chloride	B	A	A	A	--	B	B	A	A	A	A
Ferric Chloride	C	C	C	A	C	C	C	C	C	C	C
Ferric Sulphate	B	A	B	A	C	C	C	A	A	A	C
Formaldehyde	B	A	A	A	A	A	A	A	A	A	B
Formic Acid	C	A	A	A	B	B	B	B	A	C	C
Fuel Oil	A	A	A	A	B	B	A	A	A	--	A
Fuel Oil (Acid)	B	A	B	A	C	B	C	C	B	--	B
Furfural	A	A	A	A	B	A	B	A	A	--	A
Gasoline	A	A	A	A	A	A	A	A	A	A	A
Glue	A	A	A	A	A	A	A	A	A	A	A
Glycerin	A	A	A	A	A	A	A	A	A	A	A
Hydrobromic Acid	C	C	C	A	C	C	C	C	C	C	C
Hydrochloric Acid Room Temp. 150 F	C	C	C	A	C	C	C	C	C	C	C
Hydrocyanic Acid	A	A	C	A	--	B	--	A	A	C	B

See Recognized Temperature Limits on page 1??

CHEMICAL RESISTANCE CHART (CONT.)

METALLIC MATERIALS

A: Good Resistance
 B: Moderate Resistance
 C: Unsatisfactory

Media	Metal										
	Aluminum	Alloy 20	Copper	Hastelloy	Inconel 600	Monel 400	Nickel 200	304 SS	316 SS	410 SS	Steel
Hydrofluoric Acid	C	C	C	A	A	A	A	C	C	C	C
Hydrofluosilicic Acid	--	A	C	A	B	--	B	C	C	--	C
Hydrogen Peroxide	A	A	C	A	B	B	B	A	A	A	C
Hydrogen Sulphide	A	A	A	A	B	B	B	A	A	A	C
Kerosene	A	A	A	A	A	A	A	A	A	A	A
Lactic Acid	B	A	A	A	B	C	C	B	B	A	C
Linseed Oil	A	A	B	A	A	A	A	A	A	A	A
Lye (Caustic)	C	A	B	A	A	A	A	A	A	B	A
Manganese Carbonate	A	A	A	--	B	B	B	A	A	A	--
Manganese Chloride	C	B	B	--	B	B	B	A	A	--	--
Magnesium Carbonate	B	A	A	A	A	A	A	A	A	A	--
Magnesium Chloride	B	A	B	A	A	A	A	A	A	C	B
Magnesium Hydroxide	C	A	A	A	A	A	A	A	A	--	A
Magnesium Nitrate	A	A	B	A	B	B	--	A	A	A	B
Magnesium Sulphate	A	A	A	A	B	B	B	A	A	A	A
Methylene Chloride	C	C	C	A	C	C	C	C	C	C	B
Mercuric Chloride	C	C	C	A	C	C	C	C	C	C	C
Mercury	C	A	C	A	A	B	B	A	A	A	A
Muriatic Acid	C	C	C	A	C	C	C	C	C	C	C
Nitric Acid-Diluted	C	A	C	A	C	C	C	A	A	A	C
Nitric Acid-Concentrated	A	A	C	A	C	C	C	A	A	A	C
Nitrous Acid	B	A	B	--	B	--	--	A	A	A	--
Nitrous Oxide	A	A	A	A	C	A	C	--	--	--	B
Oleic Acid	A	A	A	A	A	B	B	A	A	B	B
Oxalic Acid	B	A	A	A	B	B	B	A	A	--	C
Petroleum Oils-Crude	A	A	C	A	A	A	A	A	A	A	A
Phosphoric Acid	C	A	B	A	B	B	B	A	A	B	C
Picric Acid	A	A		A	C	C	C	A	A	A	A
Potassium Bromide	B	A	A	A	B	A	B	B	A	--	B
Potassium Carbonate	B	A	A	A	B	A	B	A	A	A	B
Potassium Chloride	B	A	B	A	B	B	B	A	A	A	A
Potassium Cyanide	C	A	C	A	B	B	B	A	A	A	A
Potassium Hydroxide	C	A	C	A	B	A	A	B	A	--	B
Potassium Suphate	A	A	A	--	B	B	B	A	A	--	A
Sea Water	B	A	B	A	B	B	B	A	A	C	B
Sewage	B	--	B	--	--	--	--	A	A	--	B
Silver Nitrate	C	A	C	B	B	C	C	A	A	A	C
Soaps	B	A	B	A	A	A	A	A	A	A	A
Sodium Bicarbonate	B	A	A	A	A	A	A	A	A	A	B
Sodium Bisulphate	B	A	B	A	B	B	B	A	A	--	C
Sodium Bromide	B	A	A	A	B	B	B	A	A	--	B
Sodium Carbonate	B	A	A	A	B	B	B	A	A	A	A
Sodium Chloride	B	A	A	A	A	A	A	A	A	--	A
Sodium Hydroxide	C	A	B	A	A	A	A	A	A	A	A
Sodium Hyperchlorite	C	B	C	A	C	C	C	B	A	C	C
Sodium Nitrate	A	A	A	A	A	B	B	A	A	A	A
Sodium Peroxide	A	A	B	A	B	B	B	A	A	--	B
Sodium Phosphate	A	A	A	A	B	B	B	A	A	--	B
Sodium Silicate	B	A	A	A	--	B	--	A	A	A	A
Sodium Sulphate	A	A	A	A	B	B	B	A	A	A	A
Sodium Sulphide	C	A	C	A	B	--	B	B	--	B	A
Soy Bean Oil	A	A	A	A	--	B	--	A	A	--	--

See Recognized Temperature Limits on page 1??

A: Good Resistance
 B: Moderate Resistance
 C: Unsatisfactory

CHEMICAL RESISTANCE CHART (CONT.) METALLIC MATERIALS

Media	Metal										
	Aluminum	Alloy 20	Copper	Hastelloy	Inconel 600	Monel 400	Nickel 200	304 SS	316 SS	410 SS	Steel
Steam	A	A	B	--	A	A	A	A	A	A	A
Stearic Acid	A	A	A	A	B	B	B	A	A	A	B
Stannic Chloride	C	A	C	A	B	B	B	A	A	C	--
Sulphur Chloride	C	A	A	A	--	B	B	C	C	C	B
Sulphur Dioxide-Dry	A	A	A	A	A	A	A	A	A	--	A
Sulphuric Acid - <10%-Cold	B	A	B	A	C	B	B	C	B	C	C
Sulphuric Acid - <10%-Hot	C	B	C	A	C	B	C	C	C	C	C
Sulphuric Acid - 10-50% Cold	C	A	C	A	C	B	C	C	C	--	C
Sulphuric Acid - 10-50% Hot	C	C	C	A	C	C	C	C	C	C	C
Suphuric Acid - Fuming	A	A	C	A	C	C	C	A	A	--	B
Sulphurous Acid	B	A	C	A	C	C	C	C	B	C	A
Sulphur-Molten	A	A	C	A	A	C	C	A	A	A	A
Tannic Acid	B	A	A	A	B	B	B	A	A	A	C
Tartaric Acid	B	A	A	A	B	B	B	A	A	C	C
Vinegar	B	A	B	A	A	A	A	A	A	A	B
Zinc Chloride	C	A	B	B	B	B	B	C	C	C	B
Zinc Sulphate	B	A	A	A	B	B	B	A	A	A	B

See Recognized Temperature Limits on page 1??

RECOGNIZED TEMPERATURE LIMITS

METALLIC MATERIALS

Material	Maximum
Carbon Steel	1000°F (538°C)
304 SS	1400°F (760°C)
309 SS	2000°F (1095°C)
310 SS	2100°F (1150°C)
316 SS	1400°F (760°C)
321 SS	1500°F (815°C)
347 SS	1700°F (925°C)
410 SS	1300°F (705°C)
430 SS	1500°F (815°C)
501 SS	1200°F (649°C)
Alloy 20	1500°F (815°C)
Aluminum	800°F (427°C)
Brass	500°F (260°C)
Copper	500°F (260°C)
Hastelloy® B & C	2000°F (1095°C)
Inconel® 600	2000°F (1095°C)
Incolloy® 800	1600°F (871°C)
Monel®	1500°F (815°C)
Nickel	1400°F (760°C)
Phosphor Bronze	500°F (260°C)
Tantalum	3000°F (1649°C)
Titanium	2000°F (1095°C)

Note: Maximum temperature ratings are based upon hot air constant temperatures. The presence of contaminating fluids and cyclic conditions may drastically affect the maximum temperature range.

GALVANIC CORROSION

Galvanic Corrosion is the corrosion that results when two different metals with different potentials are placed in electrical contact in an electrolyte. Difference in electrical potential exists between the different metals and serves as the driving force for electrical current flow through the corroding electrolyte. The current flow results in corrosion of one of the metals. The larger the potential difference, the greater the probability of galvanic corrosion. Galvanic corrosion only causes deterioration of one of the metals. The less resistant, active metal becomes the anodic corrosion site. The stronger, more noble metal is cathodic and protected.

Metals close to one another on the chart generally do not have a strong effect on one another, but the farther apart any two metals are separated, the stronger the corroding effect on the one higher in the list. The following list represents the potential available to promote a corrosive reaction, however the actual corrosion in each application is difficult to predict. Typically, the presence of an electrolyte is necessary to promote galvanic corrosion.

GALVANIC CORROSION CHART

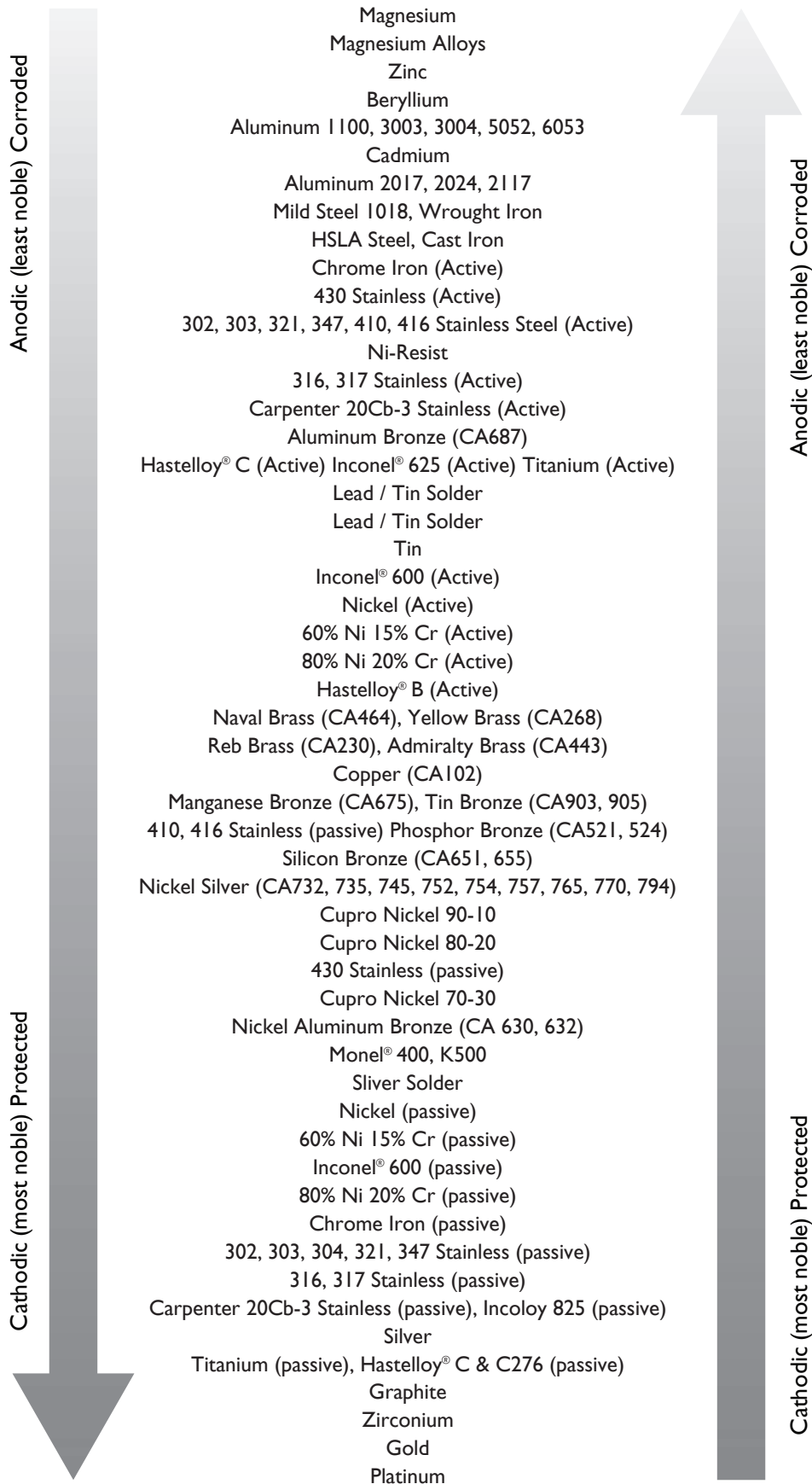

SECTION 3: METALLIC GASKETS

Metallic gaskets are available in many forms including

- Solid metal gaskets that require very smooth, plain surface finishes and high clamping forces in order to seal.
- Combinations with soft fillers such as double jacketed that can tolerate greater surface roughness and will seat with lesser compressive forces.
- Light cross section gaskets that are self-sealing and require minimum clamping forces for effective sealing.

In all cases, however, careful attention must be given to machining details of the flanges and sizing of the gaskets.

SOLID METAL GASKETS

Plain Flat Metal Gaskets (Style 310)

Flat metal gaskets are best suited for applications such as valve bonnets, ammonia fittings, heat exchangers, hydraulic presses, tongue-and-groove joints. They can be used when compressibility is not required to compensate for flange surface finish, warpage or misalignment and where sufficient clamping force is available to seat the particular metal selected. They must be sealed by the flow of the gasket metal into the imperfections on the gasket seating surfaces of the flange. This requires heavy compressive forces. The hardness of gasket metal must be less than the hardness of the flanges to prevent damage to the gasket seating surface of the flange. Flat metal gaskets are relatively inexpensive to produce and can be made of virtually any material that is available in sheet form. Size limitation is normally restricted to the sheet size. Larger gaskets can be fabricated by welding.

Profile Gaskets (Style 344)

Profile type gaskets offer the desirable qualities of plain washer types and the added advantage of a reduced contact area provided by the V-shaped surface. It is used when a solid metal gasket is required because of pressure or temperature or because of the highly corrosive effect of the fluid to be contained and also when bolting is not sufficient to seat a flat washer.

A Profile Gasket with a Metal Jacket (Style 345 and 346)

If flange conditions require a profile type gasket, but flange protection is required as well, the profile gasket may be supplied with either a single-jacketed or a double-jacketed shield. This will provide protection for the flanges and will minimize damage to the flange faces due to the profile surface.

NOTE: without exception all of the solid metal gaskets require a very fine surface finish on the flanges. A flange with a flange surface roughness of 63 micro inches or smoother is desired. Under no circumstances should the surface finish exceed 125 micro inches. In addition, radial gouges or scores would be almost impossible to seal using solid metal gaskets.

HARDNESS CONVERSION CHART

Rockwell						Rockwell Superficial				Brinell		Vickers	Shore	Approx Tensile Strength (psi)
A	B	C	D	E	F	15-N	30-N	45-N	30-T	3000 kg	500 kg	136		
60 kg Brale	100 kg 1/16" Ball	150 kg Brale	100 kg Brale	100 kg 1/8" Ball	60 kg 1/16" Ball	15 kg Brale	30 kg Brale	45 kg Brale	30 kg 1/16" Ball	10mm Ball Steel	10mm Ball Steel	Diamond Pyramid	Sciuroscope	
86.5	--	70	78.5	--	--	94.0	86.0	77.6	--	--	--	1076	101	--
86.0	--	69	77.7	--	--	93.5	85.0	76.5	--	--	--	1044	99	--
85.6	--	68	76.9	--	--	93.2	84.4	75.4	--	--	--	940	97	--
85.0	--	67	76.1	--	--	92.9	83.6	74.2	--	--	--	900	95	--
84.5	--	66	75.4	--	--	92.5	82.8	73.2	--	--	--	865	92	--
83.9	--	65	74.5	--	--	92.2	81.9	72.0	--	739	--	832	91	--
83.4	--	64	73.8	--	--	91.8	81.1	71.0	--	722	--	800	88	--
82.8	--	63	73.0	--	--	91.4	80.1	69.9	--	705	--	772	87	--
82.3	--	62	72.2	--	--	91.1	79.3	68.8	--	688	--	746	85	--
81.8	--	61	71.5	--	--	90.7	78.4	67.7	--	670	--	720	83	--
81.2	--	60	70.7	--	--	90.2	77.5	66.6	--	654	--	697	81	320000
80.7	--	59	69.9	--	--	89.8	76.6	65.5	--	634	--	674	80	310000
80.1	--	58	69.2	--	--	89.3	75.7	64.3	--	615	--	653	78	300000
79.6	--	57	68.5	--	--	88.9	74.8	63.2	--	595	--	633	76	380000
79.0	--	56	67.7	--	--	88.3	73.9	62.0	--	577	--	613	75	282000
78.5	120	55	66.9	--	--	87.9	73.0	60.9	--	560	--	595	74	274000
78.0	120	54	66.1	--	--	87.4	72.0	59.8	--	543	--	577	72	266000
77.4	119	53	65.4	--	--	86.9	71.2	58.6	--	525	--	560	71	257000
76.8	119	52	64.6	--	--	86.4	70.2	57.4	--	500	--	544	69	245000
76.3	118	51	63.8	--	--	85.9	69.4	56.1	--	487	--	528	68	239000
75.9	117	50	63.1	--	--	85.5	68.5	55.0	--	475	--	513	67	233000
75.2	117	49	62.1	--	--	85.0	67.6	53.8	--	464	--	498	66	227000
74.7	116	48	61.4	--	--	84.5	66.7	52.5	--	451	--	484	64	221000
74.1	116	47	60.8	--	--	83.9	65.8	51.4	--	442	--	471	63	217
73.6	115	46	60.0	--	--	83.5	64.8	50.3	--	432	--	458	62	212000
73.1	115	45	59.2	--	--	83.0	64.0	49.0	--	421	--	446	60	206000
72.5	114	44	58.5	--	--	82.5	63.1	47.8	--	409	--	434	58	200000
72.0	113	43	57.7	--	--	82.0	62.2	46.7	--	400	--	423	57	196000
71.5	113	42	56.9	--	--	81.5	61.3	45.5	--	390	--	412	56	191000
70.9	112	41	56.2	--	--	80.9	60.4	44.3	--	381	--	402	55	187000
70.4	112	40	55.4	--	--	80.4	59.5	43.1	--	371	--	392	54	182000
69.9	111	39	54.6	--	--	79.9	58.6	41.6	--	362	--	382	52	177000
69.4	110	38	53.8	--	--	79.4	57.7	40.8	--	353	--	372	51	173000
68.9	110	37	53.1	--	--	78.8	56.8	39.6	--	344	--	363	50	169000
68.4	109	36	52.3	--	--	78.3	55.9	38.4	--	336	--	354	49	165000
67.9	109	35	51.5	--	--	77.7	55.0	37.2	--	327	--	345	48	160000
67.4	108	34	50.8	--	--	77.2	54.2	36.1	--	319	--	336	47	156000
66.8	108	33	50.0	--	--	76.6	53.3	34.9	--	311	--	327	46	152000
66.3	107	32	49.2	--	--	76.1	52.1	33.7	--	301	--	318	44	147000
65.8	106	31	48.4	--	--	75.6	51.3	32.5	--	294	--	310	43	144000
65.3	105	30	47.7	--	--	75.0	50.4	31.3	--	286	--	302	42	140000
64.7	104	9	47.0	--	--	74.5	49.5	30.1	--	279	--	294	41	137000
64.3	104	28	46.1	--	--	73.9	48.6	28.9	--	271	--	286	41	133000
63.8	103	27	45.2	--	--	73.3	47.7	27.8	--	264	--	279	40	129000
63.3	103	26	44.6	--	--	72.8	46.8	26.7	--	258	--	272	39	126000
62.8	102	25	43.8	--	--	72.2	45.9	25.5	--	253	--	266	38	124000
62.4	101	24	43.1	--	--	71.6	45.0	24.3	--	247	--	260	37	121000
62.0	100	23	42.1	--	--	71.0	44.0	23.1	82	240	201	254	36	118000
61.5	99	22	41.6	--	--	70.5	43.2	22.0	81.5	234	195	248	35	115000
61.0	98	21	40.9	--	--	69.9	42.3	20.7	81	228	189	243	35	112000
60.5	97	20	40.1	--	--	69.4	41.5	19.6	80.5	222	184	238	34	109000
59.0	96	18	--	--	--	--	--	--	80	216	179	230	33	106000
58.0	95	16	--	--	--	--	--	--	79	210	175	222	32	103000
57.5	94	15	--	--	--	--	--	--	78.5	205	171	213	31	100000
57.0	93	13	--	--	--	--	--	--	78	200	167	208	30	98000
56.5	92	12	--	--	--	--	--	--	77.5	195	163	204	29	96000

HARDNESS CONVERSION CHART (CONT.)

Rockwell						Rockwell Superficial				Brinell		Vickers	Shore	Approx Tensile Strength (psi)
A	B	C	D	E	F	15-N	30-N	45-N	30-T	3000 kg	500 kg	136		
60 kg Brale	100 kg 1/16" Ball	150 kg Brale	100 kg Brale	100 kg 1/8" Ball	60 kg 1/16" Ball	15 kg Brale	30 kg Brale	45 kg Brale	30 kg 1/16" Ball	10mm Ball Steel	10mm Ball Steel	Diamond Pyramid	Sciero-scope	
56.0	91	10	--	--	--	--	--	--	77	190	160	193	28	93000
55.5	90	9	--	--	--	--	--	--	76	185	157	192	27	91000
55.0	89	8	--	--	--	--	--	--	75.5	180	154	188	26	88000
54.0	88	7	--	--	--	--	--	--	75	176	151	184	26	86000
53.5	87	6	--	--	--	--	--	--	74.5	172	148	180	26	84000
53.0	86	5	--	--	--	--	--	--	74	169	145	176	25	83000
52.5	85	4	--	--	--	--	--	--	73.5	165	142	173	25	81000
52.0	84	3	--	--	--	--	--	--	73	162	140	170	25	79000
51.0	83	2	--	--	--	--	--	--	72	159	137	166	24	78000
50.5	82	1	--	--	--	--	--	--	71.5	156	135	163	24	76000
50.0	81	0	--	--	--	--	--	--	71	153	133	160	24	75000
49.5	80	--	--	--	--	--	--	--	70	150	130	--	--	73000
49.0	79	--	--	--	--	--	--	--	69.5	147	128	--	--	--
48.5	78	--	--	--	--	--	--	--	69	144	126	--	--	--
48.0	77	--	--	--	--	--	--	--	68	141	124	--	--	--
47.0	76	--	--	--	--	--	--	--	67.5	139	122	--	--	--
46.5	75	--	--	--	99.5	--	--	--	67	137	120	--	--	--
46.0	74	--	--	--	99	--	--	--	66	135	118	--	--	--
45.5	73	--	--	--	98.5	--	--	--	65.5	132	116	--	--	--
45.0	72	--	--	--	98	--	--	--	65	130	114	--	--	--
44.5	71	--	--	100	97.5	--	--	--	64.2	127	112	--	--	--
44.0	70	--	--	99.5	97	--	--	--	63.5	125	110	--	--	--
43.5	69	--	--	99	93	--	--	--	62.8	123	109	--	--	--
43.0	68	--	--	98	95.5	--	--	--	62	121	107	--	--	--
42.5	67	--	--	97.5	95	--	--	--	61.4	119	106	--	--	--
42.0	66	--	--	97	94.5	--	--	--	60.5	117	104	--	--	--
41.8	65	--	--	93	94	--	--	--	60.1	116	102	--	--	--
41.5	64	--	--	95.5	93.5	--	--	--	59.5	114	101	--	--	--
41.0	63	--	--	95	93	--	--	--	58.7	112	99	--	--	--
40.5	62	--	--	94.5	92	--	--	--	58	110	98	--	--	--
40.0	61	--	--	93.5	91.5	--	--	--	57.3	108	96	--	--	--
39.5	60	--	--	93	91	--	--	--	56.5	107	95	--	--	--
39.0	59	--	--	92.5	90.5	--	--	--	55.9	106	94	--	--	--
38.5	58	--	--	92	90	--	--	--	55	104	92	--	--	--
38.0	57	--	--	91	89.5	--	--	--	54.6	102	91	--	--	--
37.8	56	--	--	90.5	89	--	--	--	54	101	90	--	--	--
37.5	55	--	--	90	88	--	--	--	53.2	99	89	--	--	--
37.0	54	--	--	89.5	87.5	--	--	--	52.5	--	87	--	--	--
36.5	53	--	--	89	87	--	--	--	51.8	--	86	--	--	--
36.0	52	--	--	88	86.5	--	--	--	51	--	85	--	--	--
35.5	51	--	--	87.5	86	--	--	--	50.4	--	84	--	--	--
35.0	50	--	--	87	85.5	--	--	--	49.5	--	83	--	--	--
34.8	49	--	--	86.5	85	--	--	--	49.1	--	82	--	--	--
34.5	48	--	--	85.5	84.5	--	--	--	48.5	--	81	--	--	--
34.0	47	--	--	85	84	--	--	--	47.7	--	80	--	--	--
33.5	46	--	--	84.5	83	--	--	--	47	--	79	--	--	--
33.0	45	--	--	84	82.5	--	--	--	46.2	--	79	--	--	--
32.5	44	--	--	83.5	82	--	--	--	45.5	--	78	--	--	--
32.0	43	--	--	82.5	81.5	--	--	--	44.8	--	77	--	--	--
31.5	42	--	--	82	81	--	--	--	44	--	76	--	--	--
31.0	41	--	--	81.5	80.5	--	--	--	43.4	--	75	--	--	--
30.8	40	--	--	81	79.5	--	--	--	43	--	74	--	--	--
30.5	39	--	--	80	79	--	--	--	42.1	--	74	--	--	--
30.0	38	--	--	79.5	78.5	--	--	--	41.5	--	73	--	--	--
29.5	37	--	--	79	78	--	--	--	40.7	--	72	--	--	--
29.0	36	--	--	78.5	77.5	--	--	--	40	--	71	--	--	--
28.5	35	--	--	78	77	--	--	--	39.3	--	71	--	--	--
28.0	34	--	--	77	76.5	--	--	--	38.5	--	70	--	--	--

HARDNESS CONVERSION CHART (CONT.)

Rockwell						Rockwell Superficial				Brinell		Vickers	Shore	Approx Tensile Strength (psi)
A	B	C	D	E	F	15-N	30-N	45-N	30-T	3000 kg	500 kg	136		
60 kg Brale	100 kg 1/16" Ball	150 kg Brale	100 kg Brale	100 kg 1/8" Ball	60 kg 1/16" Ball	15 kg Brale	30 kg Brale	45 kg Brale	30 kg 1/16" Ball	10mm Ball Steel	10mm Ball Steel	Diamond Pyramid	Sciuroscope	
27.8	33	--	--	76.5	75.5	--	--	--	37.9	--	69	--	--	--
27.5	32	--	--	76	75	--	--	--	37.5	--	68	--	--	--
27.0	31	--	--	75.5	74.5	--	--	--	36.6	--	68	--	--	--
26.5	30	--	--	75	74	--	--	--	36	--	67	--	--	--
26.0	29	--	--	74	73.5	--	--	--	35.2	--	66	--	--	--
25.5	28	--	--	73.5	73	--	--	--	34.5	--	66	--	--	--
25.0	27	--	--	73	72.5	--	--	--	33.8	--	65	--	--	--
24.5	26	--	--	72.5	72	--	--	--	33.1	--	65	--	--	--
24.2	25	--	--	72	71	--	--	--	32.4	--	64	--	--	--
24.0	24	--	--	71	70.5	--	--	--	32	--	64	--	--	--
23.5	23	--	--	70.5	70	--	--	--	31.1	--	63	--	--	--
23.0	22	--	--	70	69.5	--	--	--	30.4	--	63	--	--	--
22.5	21	--	--	69.5	69	--	--	--	29.7	--	62	--	--	--
22.0	20	--	--	68.5	68.5	--	--	--	29	--	62	--	--	--
21.5	19	--	--	68	68	--	--	--	28.1	--	61	--	--	--
21.2	18	--	--	67.5	67	--	--	--	27.4	--	61	--	--	--
21.0	17	--	--	67	66.5	--	--	--	26.7	--	60	--	--	--
20.5	16	--	--	66.5	66	--	--	--	26	--	60	--	--	--
20.0	15	--	--	65.5	65.5	--	--	--	25.3	--	59	--	--	--
--	14	--	--	65	65	--	--	--	24.6	--	59	--	--	--
--	13	--	--	64.5	64.5	--	--	--	23.9	--	58	--	--	--
--	12	--	--	64	64	--	--	--	23.5	--	58	--	--	--
--	11	--	--	63.5	63.5	--	--	--	22.6	--	57	--	--	--
--	10	--	--	62.5	63	--	--	--	21.9	--	57	--	--	--
--	9	--	--	62	62	--	--	--	21.2	--	56	--	--	--
--	8	--	--	61.5	61.5	--	--	--	20.5	--	56	--	--	--
--	7	--	--	61	61	--	--	--	19.8	--	56	--	--	--
--	6	--	--	60.5	60.5	--	--	--	19.1	--	55	--	--	--
--	5	--	--	60	60	--	--	--	18.4	--	55	--	--	--
--	4	--	--	59	59.5	--	--	--	18	--	55	--	--	--
--	3	--	--	58.5	59	--	--	--	17.1	--	54	--	--	--
--	2	--	--	58	58	--	--	--	16.4	--	54	--	--	--
--	1	--	--	57.5	57.5	--	--	--	15.7	--	53	--	--	--
--	0	--	--	57	57	--	--	--	15	--	53	--	--	--

PIPE DIMENSIONS AND WEIGHTS

NPS	OD	Schedule Designations			Wall		ID		Weight	
					Inches	mm	Inches	mm	Lbs/Ft	Kg/m
1/8	0.405	10		10S	0.049	1.2	0.307	7.8	0.19	0.28
		STD	40	40S	0.068	1.7	0.269	6.8	0.24	0.36
		XS	80	80S	0.095	2.4	0.215	5.5	0.31	0.47
1/4	0.540	10		10S	0.065	1.7	0.410	10.4	0.33	0.49
		STD	40	40S	0.088	2.2	0.364	9.2	0.42	0.63
		XS	80	80S	0.119	3.0	0.302	7.7	0.54	0.80
3/8	0.675	10		10S	0.065	1.7	0.545	13.8	0.42	0.63
		STD	40	40S	0.091	2.3	0.493	12.5	0.57	0.84
		XS	80	80S	0.126	3.2	0.423	10.7	0.74	1.10
1/2	0.840	5		5S	0.065	1.7	0.710	18.0	0.54	0.80
		10		10S	0.083	2.1	0.674	17.1	0.67	1.00
		STD	40	40S	0.109	2.8	0.622	15.8	0.85	1.26
		XS	80	80S	0.147	3.7	0.546	13.9	1.09	1.62
		160			0.188	4.8	0.464	11.8	1.31	1.95
		XX			0.294	7.5	0.252	6.4	1.71	2.55
3/4	1.050	5		5S	0.065	1.7	0.920	23.4	0.68	1.02
		10		10S	0.083	2.1	0.884	22.5	0.86	1.28
		STD	40	40S	0.113	2.9	0.842	21.4	1.13	1.68
		XS	80	80S	0.154	3.9	0.742	18.8	1.47	2.19
		160			0.219	5.6	0.612	15.5	1.94	2.89
		XX			0.308	7.8	0.434	11.0	2.44	3.63
1	1.315	5		5S	0.065	1.7	1.185	30.1	0.87	1.29
		10		10S	0.109	2.8	1.097	27.9	1.40	2.09
		STD	40	40S	0.133	3.4	1.049	26.6	1.68	2.50
		XS	80	80S	0.179	4.5	0.957	24.3	2.17	3.23
		160			0.250	6.4	0.815	20.7	2.84	4.23
		XX			0.358	9.1	0.599	15.2	3.66	5.44
1 1/4	1.660	5		5S	0.065	1.7	1.530	38.9	1.11	1.65
		10		10S	0.109	2.8	1.442	36.6	1.81	2.69
		STD	40	40S	0.140	3.6	1.380	35.1	2.27	3.38
		XS	80	80S	0.191	4.9	1.278	32.5	3.00	4.46
		160			0.250	6.4	1.160	29.5	3.77	5.60
		XX			0.382	9.7	0.896	22.8	5.21	7.76
1 1/2	1.900	5		5S	0.065	1.7	1.770	45.0	1.27	1.90
		10		10S	0.109	2.8	1.682	42.7	2.09	3.10
		STD	40	40S	0.145	3.7	1.610	40.9	2.72	4.04
		XS	80	80S	0.200	5.1	1.500	38.1	3.63	5.40
		160			0.281	7.1	1.338	34.0	4.86	7.23
		XX			0.400	10.2	1.100	27.9	6.41	9.54
2	2.375	5		5S	0.065	1.7	2.245	57.0	1.60	2.39
		10		10S	0.109	2.8	2.157	54.8	2.64	3.93
		STD	40	40S	0.154	3.9	2.067	52.5	3.65	5.44
		XS	80	80S	0.218	5.5	1.939	49.3	5.02	7.47
		160			0.344	8.7	1.687	42.8	7.46	11.10
		XX			0.436	11.1	1.503	38.2	9.03	13.44

PIPE DIMENSIONS AND WEIGHTS (CONT.)

NPS	OD	Schedule Designations			Wall		ID		Weight	
					Inches	mm	Inches	mm	Lbs/Ft	Kg/m
2 1/2	2.875	5		5S	0.083	2.1	2.709	68.8	2.48	3.68
		10		10S	0.120	3.0	2.635	66.9	3.53	5.25
		STD	40	40S	0.203	5.2	2.469	62.7	5.79	8.62
		XS	80	80S	0.276	7.0	2.323	59.0	7.66	11.40
		160			0.375	9.5	2.125	54.0	10.01	14.89
		XX			0.552	14.0	1.771	45.0	13.69	20.37
3	3.500	5		5S	0.083	2.1	3.334	84.7	3.03	4.51
		10		10S	0.120	3.0	3.260	82.8	4.33	6.45
		STD	40	40S	0.216	5.5	3.068	77.9	7.58	11.27
		XS	80	80S	0.300	7.6	2.900	73.7	10.25	15.25
		160			0.438	11.1	2.624	66.6	14.32	21.31
		XX			0.600	15.2	2.300	58.4	18.58	27.65
3 1/2	4.000	5		5S	0.083	2.1	3.834	97.4	3.47	5.17
		10		10S	0.120	3.0	3.760	95.5	4.97	7.40
		STD	40	40S	0.226	5.7	3.548	90.1	9.11	13.55
		XS	80	80S	0.318	8.1	3.364	85.4	12.50	18.60
		160			0.438	11.1	3.068	77.9	7.58	11.27
		XX			0.636	16.2	2.728	69.3	22.85	34.00
4	4.500	5		5S	0.083	2.1	4.334	110.1	3.92	5.83
		10		10S	0.120	3.0	4.260	108.2	5.61	8.35
					0.156	4.0	4.188	106.4	7.24	10.77
					0.188	4.8	4.124	104.7	8.66	12.88
		STD	40	40S	0.237	6.0	4.026	102.3	10.79	16.06
		XS	80	80S	0.337	8.6	3.826	97.2	14.98	22.29
		120			0.438	11.1	3.624	92.0	19.00	28.27
		160			0.531	13.5	3.438	87.3	22.51	33.49
XX			0.674	17.1	3.152	80.1	27.54	40.98		
4 1/2	5.000	STD	40	40S	0.247	6.3	4.506	114.5	12.53	18.64
		XS	80	80S	0.355	9.0	4.290	109.0	17.61	26.20
		XX			0.710	18.0	3.580	90.9	32.43	48.26
5	5.563	5		5S	0.109	2.8	5.345	135.8	6.35	9.45
		10		10S	0.134	3.4	5.295	134.5	7.77	11.56
		STD	40	40S	0.258	6.6	5.047	128.2	14.62	21.75
		XS	80	80S	0.375	9.5	4.813	122.3	20.78	30.92
					0.500	12.7	4.563	115.9	27.04	40.24
		160			0.625	15.9	4.313	109.6	32.96	49.04
		XX			0.750	19.1	4.063	103.2	38.55	57.36
6	6.625	5		5S	0.109	2.8	6.407	162.7	7.59	11.29
		10		10S	0.134	3.4	6.357	161.5	9.29	13.82
					0.188	4.8	6.249	158.7	12.92	19.22
		STD	40	40S	0.280	7.1	6.065	154.1	18.97	28.23
		XS	80	80S	0.432	11.0	5.761	146.3	28.57	42.51
		120			0.562	14.3	5.501	139.7	36.39	54.15
		160			0.719	18.3	5.187	131.7	45.35	67.48
		XX			0.864	21.9	4.897	124.4	53.16	79.10
7	7.625	STD	40	40S	0.301	7.6	7.023	178.4	23.57	35.07
		XS	80	80S	0.500	12.7	6.625	168.3	39.05	58.11
		XX			0.875	22.2	5.875	149.2	63.08	93.86

PIPE DIMENSIONS AND WEIGHTS (CONT.)

NPS	OD	Schedule Designations			Wall		ID		Weight	
					Inches	mm	Inches	mm	Lbs/Ft	Kg/m
8	8.625			5S	0.109	2.8	8.407	213.5	9.91	14.75
		10		10S	0.148	3.8	8.329	211.6	13.40	19.94
		20			0.250	6.4	3.125	79.4	22.36	33.27
		30			0.277	7.0	8.071	205.0	24.70	36.75
		STD	40	40S	0.322	8.2	7.981	202.7	28.55	42.48
		60			0.406	10.3	7.813	198.5	35.64	53.03
		XS	80	80S	0.500	12.7	7.625	193.7	43.39	64.56
		100			0.594	15.1	7.437	188.9	50.95	75.81
		120			0.719	18.3	7.187	182.5	60.71	90.34
		140			0.812	20.6	7.001	177.8	67.76	100.83
		XX			0.875	22.2	6.875	174.6	72.42	107.76
			0.906	23.0	6.813	173.1	74.69	111.14		
9	9.625	STD	40	40S	0.342	8.7	8.941	227.1	33.90	50.44
		XS	80	80S	0.500	12.7	9.625	244.5	48.72	72.50
		XX			0.875	22.2	7.875	200.0	81.77	121.67
10	10.750			5S	0.134	3.4	10.482	266.2	15.19	22.60
				10S	0.165	4.2	10.420	264.7	18.70	27.83
					0.188	4.8	10.374	263.5	21.21	31.56
		20			0.250	6.4	10.250	260.4	28.04	41.72
		30			0.307	7.8	10.136	257.5	34.24	50.95
		STD	40	40S	0.365	9.3	10.020	254.5	40.48	60.23
		XS	60	80S	0.500	12.7	9.750	247.7	54.74	81.45
		80			0.594	15.1	9.562	242.9	64.43	95.87
		100			0.719	18.3	9.312	236.5	77.03	114.62
		120			0.844	21.4	9.062	230.2	89.29	132.86
		140			1.000	25.4	8.750	222.3	104.13	154.95
160			1.125	28.6	8.500	215.9	115.64	172.07		
11	11.750	STD	40	40S	0.375	9.5	11.000	279.4	45.55	67.78
		XS	80	80S	0.500	12.7	10.750	273.1	60.07	89.38
		XX			0.875	22.2	10.000	254.0	101.63	151.23
12	12.750			5S	0.156	4.0	12.438	315.9	20.98	31.22
				10S	0.180	4.6	12.390	314.7	24.20	36.01
		20			0.250	6.4	12.250	311.2	33.38	49.67
		30			0.330	8.4	12.090	307.1	43.77	65.13
		STD		40S	0.375	9.5	12.000	304.8	49.56	73.75
		40			0.406	10.3	11.938	303.2	53.52	79.64
		XS		80S	0.500	12.7	11.750	298.5	65.42	97.34
		60			0.562	14.3	11.626	295.3	73.15	108.85
		80			0.688	17.5	11.374	288.9	88.62	131.87
		100			0.844	21.4	11.062	281.0	107.32	159.69
		120			1.000	25.4	10.750	273.1	125.49	186.73
140			1.125	28.6	10.500	266.7	139.67	207.83		
160			1.312	33.3	10.126	257.2	160.27	238.48		

PIPE DIMENSIONS AND WEIGHTS (CONT.)

NPS Inches	OD Inches	Schedule Designations			Wall		ID		Weight	
					Inches	mm	Inches	mm	Lbs/Ft	Kg/m
14	14.000			10S	0.188	4.8	13.624	346.0	27.73	41.26
		10			0.250	6.4	13.500	342.9	36.71	54.62
		20			0.312	7.9	13.376	339.8	45.61	67.87
		STD	30	40S	0.375	9.5	13.250	336.6	54.57	81.20
		40			0.438	11.1	13.124	333.3	63.44	94.40
		XS		80S	0.500	12.7	13.000	330.2	72.09	107.27
		60			0.594	15.1	12.812	325.4	85.05	126.55
		80			0.750	19.1	12.500	317.5	106.13	157.92
		100			0.938	23.8	12.124	307.9	130.85	194.70
		120			1.094	27.8	11.812	300.0	150.90	224.54
		140			1.250	31.8	11.500	292.1	170.21	253.27
			1.406	35.7	11.188	284.2	189.10	281.38		
16	16.000			10S	0.188	4.8	15.624	396.8	31.75	47.24
		10			0.250	6.4	15.500	393.7	42.05	62.57
		20			0.312	7.9	15.376	390.6	52.27	77.78
		STD	30	40S	0.375	9.5	15.250	387.4	62.58	93.12
		XS	40	80S	0.500	12.7	15.000	381.0	82.77	123.16
		60			0.656	16.7	14.688	373.1	107.50	159.96
		80			0.844	21.4	14.312	363.5	136.61	203.28
		100			1.031	26.2	13.938	354.0	164.82	245.25
		120			1.219	31.0	13.562	344.5	192.43	286.34
		140			1.438	36.5	13.124	333.3	223.64	332.78
		160			1.594	40.5	12.812	325.4	245.25	364.93
18	18.000			10S	0.188	4.8	17.624	447.6	35.76	53.21
		10			0.250	6.4	17.500	444.5	47.39	70.52
		20			0.312	7.9	17.376	441.4	58.94	87.70
		STD		40S	0.375	9.5	17.250	438.2	70.59	105.04
		30			0.438	11.1	17.124	434.9	82.15	122.24
		XS		80S	5.000	127.0	17.000	431.8	93.45	139.05
		40			0.562	14.3	16.876	428.7	104.67	155.75
		60			0.750	19.1	16.500	419.1	138.17	205.60
		80			0.938	23.8	16.124	409.5	170.92	254.33
		100			1.156	29.4	15.688	398.5	207.96	309.44
		120			1.375	34.9	15.250	387.4	244.14	363.28
140			1.562	39.7	14.876	377.9	274.22	408.04		
160			1.781	45.2	14.438	366.7	308.50	459.05		
20	20.000			10S	0.218	5.5	19.564	496.9	46.06	68.54
		10			0.250	6.4	19.500	495.3	52.73	78.46
		STD		40S	0.375	9.5	19.250	489.0	78.60	116.96
		XS		80S	0.500	12.7	19.000	482.6	104.13	154.95
		40			0.594	15.1	18.812	477.8	123.11	183.19
		60			0.812	20.6	18.376	466.8	166.40	247.60
		80			1.031	26.2	17.938	455.6	208.87	310.80
		100			1.261	32.0	17.438	442.9	256.10	381.08
		120			1.500	38.1	17.000	431.8	296.37	441.00
		140			1.750	44.5	16.500	419.1	341.09	507.54
		160			1.969	50.0	16.062	408.0	379.17	564.20

PIPE DIMENSIONS AND WEIGHTS (CONT.)

NPS	OD	Schedule Designations			Wall		ID		Weight	
					Inches	mm	Inches	mm	Lbs/Ft	Kg/m
22	22.000			10S	0.218	5.5	21.564	547.7	50.71	75.46
			10		0.250	6.4	21.500	546.1	58.07	86.41
		STD	20	40S	0.375	9.5	21.250	539.8	86.61	128.88
		XS	30	80S	0.500	12.7	21.000	533.4	114.81	170.84
		60			0.875	22.2	20.250	514.4	197.41	293.75
		80			1.125	28.6	19.750	501.7	250.81	373.21
		100			1.375	34.9	19.250	489.0	302.88	450.69
		120			1.625	41.3	18.750	476.3	353.61	526.17
		140			1.875	47.6	18.250	463.6	403.00	599.66
		160			2.125	54.0	17.750	450.9	451.06	671.18
24	24.000	10		10S	0.250	6.4	23.500	596.9	63.41	94.35
		STD	20	40S	0.375	9.5	23.250	590.6	94.62	140.79
		XS		80S	0.500	12.7	23.000	584.2	125.49	186.73
		30			0.562	14.3	22.876	581.1	140.68	209.33
		40			0.688	17.5	22.624	574.6	171.29	254.88
		60			0.969	24.6	22.062	560.4	238.35	354.66
		80			1.219	31.0	21.562	547.7	296.58	441.31
		100			1.531	38.9	20.938	531.8	367.39	546.68
		120			1.812	46.0	20.376	517.6	429.39	638.93
		140			2.062	52.4	19.876	504.9	483.10	718.85
160			2.344	59.5	19.312	490.5	542.13	806.69		
26	26.000		10		0.312	7.9	25.376	644.6	85.60	127.37
		STD		40S	0.375	9.5	25.250	641.4	102.63	152.71
		XS		80S	0.500	12.7	25.000	635.0	136.17	202.62
28	28.000		10		0.312	7.9	27.376	695.4	92.26	137.28
		STD		40S	0.375	9.5	27.250	692.2	110.64	164.63
		XS	20	80S	0.500	12.7	27.000	685.8	146.85	218.51
			30		0.625	15.9	26.750	679.5	182.73	271.90
30	30.000		10		0.312	7.9	29.376	746.2	98.93	147.21
		STD		40S	0.375	9.5	29.500	749.3	118.65	176.55
			20	80S	0.500	12.7	29.000	736.6	157.53	234.40
			30		0.625	15.9	28.750	730.3	196.08	291.77
32	32.000		10		0.312	7.9	31.376	797.0	105.59	157.12
		STD			0.375	9.5	31.250	793.8	126.66	188.47
			20		0.500	12.7	31.000	787.4	168.21	250.30
			30		0.625	15.9	30.750	781.1	209.43	311.63
			40		0.688	17.5	30.624	777.8	230.08	342.36
34	34.000		10		0.312	7.9	33.376	847.8	112.25	167.03
		STD			0.375	9.5	33.250	844.6	134.67	200.39
			20		0.500	12.7	33.000	838.2	178.89	266.19
			30		0.625	15.9	32.750	831.9	222.78	331.50
			40		0.688	17.5	32.624	828.6	244.77	364.22
36	36.000		10		0.312	7.9	35.376	898.6	118.92	176.95
		STD		40S	0.375	9.5	35.250	895.4	142.68	212.31
		XS		80S	0.500	12.7	35.000	889.0	189.57	282.08
42	42.000	STD		40S	0.375	9.5	41.250	1047.8	166.71	248.06
		XS		80S	0.500	12.7	41.000	1041.4	221.61	329.76
			30		0.625	15.9	40.750	1035.1	276.18	410.96
			40		0.750	19.1	40.500	1028.7	330.41	491.65
48	48.000	STD		40S	0.375	9.5	47.250	1200.2	190.74	283.82
		XS		80S	0.500	12.7	47.000	1193.8	253.65	377.43

CIRCUMFERENCES AND AREAS OF CIRCLES

Diam. (in)	Circ. (in)	Area (in ²)	Diam. (in)	Circ. (in)	Area (in ²)	Diam. (in)	Circ. (in)	Area (in ²)	Diam. (in)	Circ. (in)	Area (in ²)	Diam. (in)	Circ. (in)	Area (in ²)
1/32	.0981	.00076	1/2	1.570	.1963	1	3.141	.7854	2	6.283	3.141	3	9.424	7.068
1/16	.1963	.00306	9/16	1.767	.2485	1/8	3.534	.9940	1/8	6.675	3.546	1/8	9.817	7.669
1/8	.3926	.01227	5/8	1.963	.3097	1/4	3.927	1.227	1/4	7.068	3.976	1/4	10.21	8.295
3/16	.5890	.02761	11/16	2.159	.3712	3/8	4.319	1.484	3/8	7.461	4.430	3/8	10.60	8.946
1/4	.7854	.04908	3/4	2.356	.4417	1/2	4.712	1.767	1/2	7.854	4.908	1/2	10.99	9.621
5/16	.9817	.07669	13/16	2.552	.5184	5/8	5.105	2.073	5/8	8.246	5.411	5/8	11.38	10.320
3/8	1.178	.1104	7/8	2.748	.6013	3/4	5.497	2.405	3/4	8.639	5.939	3/4	11.78	11.044
7/16	1.374	.1503	15/16	2.945	.6902	7/8	5.890	2.761	7/8	9.032	6.491	7/8	12.17	11.793
4	12.65	12.566	5	15.70	19.635	6	18.84	28.274	7	21.90	38.484	8	25.13	50.265
1/8	12.95	13.364	1/8	16.10	20.629	1/8	29.24	29.464	1/8	22.38	39.871	1/8	25.52	51.848
1/4	13.35	14.186	1/4	16.49	21.647	1/4	19.63	30.679	1/4	22.77	41.282	1/4	25.91	53.456
3/8	13.74	15.033	3/8	16.88	22.690	3/8	20.02	31.919	3/8	23.16	42.718	3/8	26.31	55.088
1/2	14.13	15.904	1/2	17.27	23.758	1/2	20.42	33.183	1/2	23.56	44.178	1/2	26.70	56.745
5/8	14.52	16.800	5/8	17.77	24.840	5/8	20.81	34.471	5/8	23.95	45.663	5/8	27.09	58.426
3/4	14.92	17.720	3/4	18.06	25.967	3/4	21.20	35.784	3/4	24.34	47.173	3/4	27.47	60.132
7/8	15.31	18.665	7/8	18.45	27.108	7/8	21.57	37.122	7/8	24.74	48.707	7/8	27.88	61.862
9	28.27	63.617	10	31.41	78.539	11	34.55	95.033	12	37.69	113.00	13	40.84	132.73
1/8	28.66	65.396	1/8	31.80	80.515	1/8	34.95	97.205	1/8	38.09	115.46	1/8	41.23	135.29
1/4	29.05	67.200	1/4	32.20	82.516	1/4	35.34	99.402	1/4	38.48	117.85	1/4	41.62	137.88
3/8	29.45	69.029	3/8	32.59	84.540	3/8	35.73	101.62	3/8	38.87	120.27	3/8	42.01	140.50
1/2	29.84	70.882	1/2	32.98	86.590	1/2	36.12	103.86	1/2	39.27	122.71	1/2	42.41	143.13
5/8	30.23	72.759	5/8	33.37	88.664	5/8	36.52	106.13	5/8	39.66	125.18	5/8	42.80	145.80
3/4	30.63	74.662	3/4	33.77	90.762	3/4	36.91	108.43	3/4	40.05	127.67	3/4	43.19	148.48
7/8	31.02	76.588	7/8	34.16	92.885	7/8	37.30	110.75	7/8	40.55	130.19	7/8	43.58	151.20
14	43.98	153.92	15	47.12	176.71	16	50.26	201.06	17	53.40	226.98	18	56.54	254.46
1/8	44.37	156.69	1/8	47.51	179.67	1/8	50.65	204.21	1/8	53.79	230.33	1/8	56.94	258.01
1/4	44.76	159.48	1/4	47.90	182.72	1/4	51.05	207.39	1/4	54.19	233.70	1/4	57.33	261.58
3/8	45.16	162.29	3/8	48.30	185.66	3/8	51.44	210.59	3/8	54.58	237.10	3/8	57.72	265.18
1/2	45.55	165.13	1/2	48.69	188.69	1/2	51.83	213.82	1/2	54.97	240.52	1/2	58.11	268.80
5/8	45.94	167.98	5/8	49.08	191.74	5/8	52.22	217.07	5/8	55.37	243.97	5/8	58.51	272.44
3/4	46.33	170.87	3/4	49.48	194.82	3/4	52.62	220.35	3/4	55.76	247.45	3/4	58.90	276.11
7/8	46.73	173.78	7/8	49.88	197.73	7/8	53.01	223.65	7/8	56.16	250.94	7/8	59.29	279.81
19	59.69	283.52	20	62.83	314.16	21	65.97	346.36	22	69.11	380.13	23	72.25	415.47
1/8	60.08	287.27	1/8	63.22	318.09	1/8	66.37	350.49	1/8	69.50	384.46	1/8	72.64	4200.00
1/4	60.47	291.03	1/4	63.61	322.06	1/4	66.75	354.65	1/4	69.90	388.82	1/4	73.04	424.55
3/8	60.86	294.83	3/8	64.01	326.05	3/8	67.15	358.84	3/8	70.29	393.20	3/8	73.43	429.13
1/2	61.26	298.64	1/2	64.40	330.06	1/2	67.54	363.05	1/2	70.68	397.60	1/2	73.82	433.73
5/8	61.65	302.48	5/8	64.79	334.10	5/8	67.93	367.28	5/8	71.07	402.03	5/8	74.21	438.30
3/4	62.04	306.35	3/4	65.18	338.16	3/4	68.32	371.54	3/4	71.47	406.49	3/4	74.61	443.01
7/8	62.43	310.24	7/8	65.58	342.25	7/8	68.72	375.82	7/8	71.86	410.97	7/8	75.00	447.69
24	75.39	452.39	25	78.54	490.87	26	81.68	530.93	27	84.82	572.55	28	87.96	615.75
1/8	75.79	475.11	1/8	78.93	495.79	1/8	82.07	536.04	1/8	85.21	577.87	1/8	88.35	621.26
1/4	76.18	461.86	1/4	79.32	500.74	1/4	82.46	541.18	1/4	85.60	583.20	1/4	88.75	626.79
3/8	76.57	466.63	3/8	79.71	505.71	3/8	82.85	546.35	3/8	86.00	588.57	3/8	89.14	632.35
1/2	76.96	471.43	1/2	80.10	510.70	1/2	83.25	551.54	1/2	86.39	593.95	1/2	89.59	637.94
5/8	77.36	476.25	5/8	80.50	515.72	5/8	83.64	556.76	5/8	86.78	599.37	5/8	89.92	643.54
3/4	77.75	481.10	3/4	80.89	520.70	3/4	84.03	562.00	3/4	87.17	604.80	3/4	90.32	649.18
7/8	78.14	485.97	7/8	81.28	525.83	7/8	84.43	567.26	7/8	87.57	610.26	7/8	90.71	654.83
29	91.10	660.52	30	94.24	706.86	31	97.38	754.76	32	100.5	804.24	33	103.6	855.30
1/8	91.49	666.22	1/8	94.64	712.86	1/8	97.78	760.86	1/8	100.9	810.45	1/8	104.0	861.79
1/4	91.89	671.95	1/4	95.03	718.69	1/4	98.17	766.99	1/4	101.3	816.86	1/4	104.4	868.30
3/8	92.23	677.71	3/8	95.42	724.64	3/8	98.56	773.14	3/8	101.7	832.21	3/8	104.8	874.88
1/2	92.67	683.49	1/2	95.81	730.61	1/2	98.96	773.31	1/2	102.1	829.57	1/2	105.2	881.41
5/8	93.06	689.29	5/8	96.21	736.61	5/8	99.35	785.51	5/8	102.4	835.97	5/8	105.6	888.00
3/4	93.46	695.12	3/4	96.60	742.64	3/4	99.74	791.73	3/4	102.8	842.39	3/4	106.0	894.61
7/8	93.85	700.98	7/8	96.99	748.69	7/8	100.1	797.97	7/8	103.2	848.83	7/8	106.4	901.25

TEMPERATURE CONVERSION

To convert between degrees Fahrenheit (°F) and degrees Celsius (°C):

$$T_c = (5/9) \times (T_f - 32)$$

$$T_f = (9/5) \times T_c + 32$$

Where: T_c is temperature in Celsius
 T_f is temperature in Fahrenheit

To convert between degrees Fahrenheit (°F) and Kelvin (°K):

$$T_f = ((9/5) \times (T_k - 273.15)) + 32$$

$$T_k = (5/9 \times (T_f - 32)) - 273.15$$

Where: T_f is temperature in Fahrenheit
 T_k is temperature in Kelvin

To convert between degrees Fahrenheit (°F) to Rankine (°R):

$$T_f = T_r - 459.69$$

$$T = T_f + 459.69$$

Where: T_f is temperature in Fahrenheit
 T_r is temperature in Rankine

To convert between degrees Celsius (°C) to Kelvin (°K):

$$T_c = T_k - 273.15$$

$$T_k = T_c + 273.15$$

Where: T_c is temperature in Celsius
 T_k is temperature in Kelvin

To convert between degree Celsius (°C) to Rankine (°R):

$$T_c = (5/9) \times (T_r - 491.69)$$

$$T_r = (9/5) \times T_c + 491.69$$

Where: T_c is temperature in Celsius
 T_r is temperature in Rankine

To convert between Kelvin (°K) and Rankine (°R):

$$T_k = (5/9) \times (T_r - 764.84)$$

$$T_r = 9/5 \times T_k + 764.84$$

CIRCUMFERENCES AND AREAS OF CIRCLES (CONT.)

Where: T_k is temperature in Kelvin
 T_r is temperature in Rankine

PRESSURE CONVERSION

To convert between inches of mercury (inHg) and millimeters of mercury (mmHg) or torr:

$$P \text{ mmHg} = 25.4 \times P \text{ inHg}$$

$$P \text{ inHg} = 0.03937008 \times P \text{ mmHg}$$

To convert between inches of mercury (inHg) and millibars (mb) or hectopascals (hPa)

$$P \text{ mb} = 33.8639 \times P \text{ inHg}$$

$$P \text{ inHg} = 0.0295300 \times P \text{ mb}$$

To convert between inches of mercury (inHg) and kilopascals (kPa)

$$P \text{ kPa} = 3.38639 \times (P \text{ inHg}/10)$$

$$P \text{ inHg} = 0.295300 \times P \text{ kPa}$$

To convert between inches of mercury (inHg) and pounds per square inch (psi)

$$P \text{ psi} = 0.491130 \times P \text{ inHg}$$

$$P \text{ inHg} = 2.03602 \times P \text{ psi}$$

To convert between torr or millimeters of mercury (mmHg) and millibars (mb) or hectopascals (hPa)

$$P \text{ mb} = 1.333224 \times P \text{ mmHg}$$

$$P \text{ mmHg} = 0.750062 \times P \text{ mb}$$

To convert between torr or millimeters of mercury (mmHg) and kilopascals (kPa)

$$P \text{ kPa} = 0.1333224 \times (P \text{ mmHg}/10)$$

$$P \text{ mmHg} = 7.50062 \times P \text{ kPa}$$

To convert between torr or millimeters of mercury (mmHg) and pounds per square inch (psi)

$$P \text{ psi} = 0.0193368 \times P \text{ mmHg}$$

$$P \text{ mmHg} = 51.7149 \times P \text{ psi}$$

To convert between millibars (mb) or hectopascals (hPa) and kilopascals (kPa)

$$P \text{ kPa} = P \text{ mb}/10$$

$$P \text{ mb} = 10 \times P \text{ kPa}$$

To convert between millibars (mb) or hectopascals (hPa) and pounds per square inch (psi)

$$P \text{ psi} = 0.0145038 \times P \text{ mb}$$

$$P \text{ mb} = 68.9476 \times P \text{ psi}$$

To convert between kilopascals (kPa) and pounds per square inch (psi)

$$P \text{ psi} = 0.145038 \times P \text{ kPa}$$

$$P \text{ mb} = 6.89476 \times P \text{ psi}$$





CIRCUMFERENCES AND AREAS OF CIRCLES (CONT.)

Diam. (in)	Circ. (in)	Area (in ²)	Diam. (in)	Circ. (in)	Area (in ²)	Diam. (in)	Circ. (in)	Area (in ²)	Diam. (in)	Circ. (in)	Area (in ²)	Diam. (in)	Circ. (in)	Area (in ²)
34	106.8	907.92	35	109.9	962.11	36	113.0	101.8	37	116.2	1075.2	38	119.3	1134.1
1/8	107.2	914.61	1/8	110.3	968.99	1/8	113.4	1024.9	1/8	116.6	1082.4	1/8	119.7	1141.5
1/4	107.5	921.32	1/4	110.7	975.90	1/4	113.8	1032.0	1/4	117.0	1089.7	1/4	120.1	1149.0
3/8	107.9	928.06	3/8	111.1	982.84	3/8	114.2	1039.1	3/8	117.4	1097.1	3/8	120.5	1156.6
1/2	108.3	934.82	1/2	111.5	989.80	1/2	114.6	1049.3	1/2	117.8	1104.4	1/2	120.9	1164.1
5/8	108.7	941.60	5/8	111.9	996.78	5/8	115.0	1053.5	5/8	118.2	1111.8	5/8	121.3	1171.7
3/4	109.1	948.41	3/4	112.3	1003.7	3/4	115.4	1060.7	3/4	118.6	1119.2	3/4	121.7	1179.3
7/8	109.5	955.25	7/8	112.7	1010.8	7/8	115.8	1067.9	7/8	118.9	1126.6	7/8	122.1	1186.9
39	122.5	1194.5	40	125.6	1256.6	41	128.8	1320.2	42	131.9	1385.4	43	135.0	1452.2
1/8	122.9	1202.2	1/8	126.0	1264.5	1/8	129.1	1328.3	1/8	132.3	1393.7	1/8	135.4	1460.6
1/4	123.3	1209.9	1/4	126.4	1272.3	1/4	129.5	1336.4	1/4	132.7	1401.9	1/4	135.8	1469.1
3/8	123.7	1217.6	3/8	126.8	1280.3	3/8	129.9	1344.5	3/8	133.1	1410.2	3/8	136.2	1477.6
1/2	124.0	1225.4	1/2	127.2	1288.2	1/2	130.3	1352.6	1/2	133.5	1418.6	1/2	136.6	1486.1
5/8	124.4	1233.1	5/8	127.6	1291.2	5/8	130.7	1360.8	5/8	133.9	1426.9	5/8	137.0	1494.7
3/4	124.8	1240.9	3/4	128.0	1304.2	3/4	131.1	1369.0	3/4	134.3	1435.3	3/4	137.4	1503.3
7/8	125.2	1248.7	7/8	128.4	1312.2	7/8	131.5	1377.2	7/8	134.6	1443.7	7/8	137.8	1511.9
44	138.2	1520.5	45	141.3	1590.4	46	144.5	1661.9	47	147.6	1734.9	48	150.7	1809.5
1/8	138.6	1529.1	1/8	141.7	1599.2	1/8	144.9	1670.9	1/8	148.0	1744.1	1/8	151.1	1818.9
1/4	139.0	1537.8	1/4	142.1	1608.1	1/4	145.2	1680.0	1/4	148.4	1753.4	1/4	151.5	1828.4
3/8	139.4	1546.5	3/8	142.5	1617.0	3/8	145.6	1689.1	3/8	148.8	1762.7	3/8	151.9	1837.9
1/2	139.8	1555.2	1/2	142.9	1625.9	1/2	146.0	1698.2	1/2	149.2	1772.0	1/2	152.3	1847.4
5/8	140.1	1564.0	5/8	143.3	1634.9	5/8	146.4	1707.3	5/8	149.6	1781.3	5/8	152.7	1856.9
3/4	140.5	1572.8	3/4	143.7	1643.8	3/4	146.8	1716.5	3/4	150.0	1790.7	3/4	153.1	1866.5
7/8	140.9	1581.6	7/8	144.1	1652.8	7/8	147.2	1725.7	7/8	150.4	1800.1	7/8	153.5	1876.1
49	153.9	1885.7	50	157.0	1963.5	51	160.2	2042.8	52	163.3	2123.7	53	166.5	2206.1
1/8	154.4	1895.3	1/8	157.4	1973.3	1/8	160.6	2025.8	1/8	163.7	2133.9	1/8	166.8	2216.6
1/4	154.7	1905.0	1/4	157.8	1983.1	1/4	161.0	2062.9	1/4	164.1	2144.1	1/4	167.2	2227.0
3/8	155.5	1914.7	3/8	158.2	1993.0	3/8	161.3	2072.9	3/8	164.5	2154.4	3/8	167.6	2237.5
1/2	155.5	1924.4	1/2	158.6	2002.9	1/2	161.7	2083.0	1/2	164.9	2164.7	1/2	168.0	2248.0
5/8	155.9	1934.1	5/8	159.0	2012.8	5/8	162.1	2093.2	5/8	165.3	2175.0	5/8	168.4	2258.5
3/4	156.2	1943.9	3/4	159.4	2022.8	3/4	162.5	2103.3	3/4	165.7	2185.4	3/4	168.8	2269.0
7/8	156.6	1953.6	7/8	159.8	2032.8	7/8	162.9	2113.5	7/8	166.1	2195.7	7/8	169.2	2279.6
54	169.6	2290.2	55	172.7	2375.8	56	175.9	2463.0	57	179.0	2551.7	58	182.2	2642.0
1/8	170.0	2300.8	1/8	173.1	2386.6	1/8	176.3	2474.0	1/8	179.4	2562.9	1/8	182.6	2653.4
1/4	170.4	2311.4	1/4	173.5	2397.4	1/4	176.7	2485.0	1/4	179.8	2574.1	1/4	182.9	2664.9
3/8	170.8	2322.1	3/8	173.9	2408.3	3/8	177.1	2496.1	3/8	180.2	2585.4	3/8	183.3	2676.3
1/2	171.2	2332.8	1/2	174.3	2419.2	1/2	177.5	2507.1	1/2	180.6	2596.7	1/2	183.7	2687.8
5/8	171.6	2343.5	5/8	174.7	2430.1	5/8	177.8	2518.2	5/8	181.0	2608.0	5/8	184.1	2690.3
3/4	172.0	2354.2	3/4	175.1	2441.0	3/4	178.2	2529.4	3/4	181.4	2619.3	3/4	184.5	2710.8
7/8	172.3	2365.0	7/8	175.5	2452.0	7/8	178.6	2540.5	7/8	181.8	2630.7	7/8	184.9	2722.4
59	185.3	2733.9	60	188.4	2827.4	61	191.6	2922.4	62	194.7	3019.0	63	197.9	3117.2
1/8	185.7	2745.5	1/8	188.8	2839.2	1/8	192.0	2934.4	1/8	195.1	3031.2	1/8	198.3	3129.6
1/4	186.1	2757.1	1/4	189.2	2851.0	1/4	192.4	2946.4	1/4	195.5	3043.4	1/4	198.7	3142.0
3/8	186.5	2768.8	3/8	189.6	2862.8	3/8	192.8	2958.5	3/8	195.9	3055.7	3/8	199.0	3144.4
1/2	186.9	2780.5	1/2	190.0	2874.7	1/2	193.2	2970.5	1/2	196.3	3067.9	1/2	199.4	3166.9
5/8	187.3	2792.2	5/8	190.4	2886.6	5/8	193.6	2982.6	5/8	196.7	3080.2	5/8	199.8	3179.4
3/4	187.7	2803.9	3/4	190.8	2898.5	3/4	193.9	2994.6	3/4	197.1	3092.5	3/4	200.2	3191.9
7/8	188.1	2815.6	7/8	191.2	2910.5	7/8	194.3	3006.9	7/8	197.5	3104.8	7/8	200.6	3204.4
64	201.0	3216.9	65	204.2	3318.3	66	207.3	3421.2	67	210.4	3525.6	68	213.6	3631.6
1/8	201.4	3229.5	1/8	204.5	3331.0	1/8	207.7	3434.1	1/8	210.9	3538.8	1/8	214.0	3645.0
1/4	201.8	3242.1	1/4	204.9	3343.8	1/4	208.1	3447.1	1/4	211.2	3552.0	1/4	214.4	3658.4
3/8	202.2	3254.8	3/8	205.3	3356.7	3/8	208.5	3460.1	3/8	211.6	3565.2	3/8	214.8	3671.8
1/2	202.6	3267.4	1/2	205.7	3369.5	1/2	208.9	3473.2	1/2	212.0	3578.4	1/2	215.1	3685.2
5/8	203.0	3280.1	5/8	206.1	3382.4	5/8	209.3	3486.3	5/8	212.4	3591.7	5/8	215.1	3698.7
3/4	203.4	3292.8	3/4	206.5	3395.3	3/4	209.7	3499.3	3/4	212.8	3605.0	3/4	215.9	3712.2
7/8	203.8	3305.5	7/8	206.9	3408.2	7/8	210.0	3512.5	7/8	213.2	3618.3	7/8	216.3	3725.7



CIRCUMFERENCES AND AREAS OF CIRCLES (CONT.)

Diam. (in)	Circ. (in)	Area (in ²)	Diam. (in)	Circ. (in)	Area (in ²)	Diam. (in)	Circ. (in)	Area (in ²)	Diam. (in)	Circ. (in)	Area (in ²)	Diam. (in)	Circ. (in)	Area (in ²)
69	216.7	3739.2	70	219.9	3848.4	71	223.0	3959.2	72	226.1	4071.5	73	229.3	4185.3
1/8	217.1	3752.8	1/8	220.3	3862.2	1/8	223.4	3973.1	1/8	226.5	4085.6	1/8	229.7	4199.7
1/4	217.5	3766.4	1/4	220.6	3875.9	1/4	223.8	3987.1	1/4	226.9	4099.8	1/4	230.1	4214.1
3/8	217.9	3780.0	3/8	221.0	3889.8	3/8	224.2	4001.1	3/8	227.3	4114.0	3/8	230.5	4228.5
1/2	218.3	3793.6	1/2	221.4	3903.6	1/2	224.6	4015.1	1/2	227.7	4128.2	1/2	230.9	4242.9
5/8	218.7	3807.3	5/8	221.8	3917.4	5/8	225.0	4029.2	5/8	228.1	4142.5	5/8	231.3	4257.3
3/4	219.1	3821.0	3/4	222.2	3931.3	3/4	225.4	4043.2	3/4	228.5	4156.7	3/4	231.6	4271.8
7/8	219.5	3834.7	7/8	222.6	3945.2	7/8	225.8	4067.3	7/8	228.9	4171.0	7/8	232.0	4286.3
74	232.4	4300.8	75	235.6	4417.8	77	241.9	4666.6	79	248.1	4901.6	81	254.4	5153.0
1/8	232.8	4315.3	1/4	236.4	4447.3	1/4	242.6	4686.9	1/4	248.9	4932.7	1/4	255.2	5184.8
1/4	233.2	4329.9	1/2	237.1	4476.9	1/2	243.4	4717.3	1/2	249.7	4963.9	1/2	256.0	5216.8
3/8	233.6	4344.5	3/4	237.9	4506.6	3/4	244.2	4747.7	3/4	250.5	4995.1	3/4	256.8	5248.8
1/2	234.0	4359.1	76	238.7	4536.4	78	245.0	4778.3	80	251.3	5026.5	82	257.6	5281.0
5/8	234.4	4378.8	1/4	239.5	4566.3	1/4	245.8	4809.0	1/4	252.1	5058.0	1/4	258.3	5313.2
3/4	234.8	4388.4	1/2	240.3	4596.3	1/2	246.6	4839.8	1/2	252.8	5089.5	1/2	259.1	5345.6
7/8	235.2	4403.1	3/4	241.1	4626.4	3/4	247.4	4870.7	3/4	253.6	5121.2	3/4	259.9	5378.0







FASTENER DETAILS

Grade Mark	Bolt Spec.	Bolt Grade	Material	Nut Spec.	Suggested Nut Grade	Temperature Ratings	Service Environment	Nominal Stud Size (in)	Mechanical Properties				
									Proof Load	Yield Strength		Tensile Strength	
										KSI (Mpa)	KSI	Mpa	KSI
 B5	ASTM A193	B5	AISI 501	ASTM A194	Any	-50 to 1200°F (-45 to 649°C)	High Temperature Service	1/4 thru 4	-	80	550	100	125
		B6	AISI 410		Any	1/4 thru 4		-	85	585	110	758	
		B7	CrMo Alloy Steel AISI 4140, 4142, or 4105		2H, 4, 7, or 8	1/4 thru 2 1/2		-	105	720	125	862	
 B8	ASTM A193	B7M	CrMo Alloy Steel AISI 4140, 4142, or 4105	ASTM A194	2HM, 4M, 7M, 19, 8M	-50 to 900°F (-45 to 482°C)	High Temperature Service	Over 2 1/2 thru 4	-	95	655	115	793
		B8 Class 1	AISI 304		8	Cryogenic to 1500°F (815°C)		Over 4 thru 7	-	75	515	100	690
		B8 Class 2	AISI 304		8	Cryogenic to 1500°F (815°C)		All	-	30	205	75	515
		B8M Class 1	AISI 316		4, 7, or 8	-50 to 1100°F (-45 to 593°C)		to 3/4	-	100	690	125	862
		B16	CrMoVa Alloy Steel		4, 7, or 8	-50 to 1100°F (-45 to 593°C)		Over 3/4 to 1	-	80	550	115	793
								Over 1 to 1 1/2	-	50	345	100	690
								All	-	30	205	75	515
 B16	ASTM A307	Grade A	Carbon Steel Grades	ASTM A563	A, B, C, D, DH, DH3	Amb. to 450°F (232°C)	60 KSI (414 Mpa) Tensile Strength	1/4 thru 2 1/2	-	-	-	60	414
		Grade B	Carbon Steel Grades		4 or 7	4 or 7		-	36	248	60-100	414-690	
		L7	CrMo Alloy Steel AISI 4140, 4142, or 4105		7M	1/4 thru 2 1/2		-	80	550	100	690	
 L7	ASTM A320	L43	NiCrMo Alloy Steel AISI 4340	ASTM A194	4 or 7	-50 to 1100°F (-45 to 593°C)	Low Temperature Service	1/4 thru 4	-	105	720	125	862
		L1	Low Carbon Boron		4 or 7	1/4 thru 2 1/2		-	105	720	125	862	
		B8 Class 1 B8 Class 1A	AISI 304		8	Cryogenic to 1500°F (815°C)		All	-	30	205	75	515
 L43		B8 Class 1A	AISI 304		8	Cryogenic to 1500°F (815°C)		All	-	30	205	75	515
										All	-	30	205

FASTENER DETAILS (CONT.)

Grade Mark	Bolt Spec.	Bolt Grade	Material	Nut Spec.	Suggested Nut Grade	Temperature Ratings	Service Environment	Nominal Stud Size (in)	Mechanical Properties				
									Proof Load KSI (Mpa)	Yield Strength		Tensile Strength	
										KSI	Mpa	KSI	Mpa
	ASTM A320	B8 Class 2	AISI 304	ASTM A194	8	Cryogenic to 1500°F (815°C)	Low Temperature Service	3/4 and under		100	690	125	862
								Over 3/4 to 1		80	550	115	793
		B8M Class 2	AISI 316					Over 1 to 1 1/4		65	450	105	720
								1 1/4 to 1 1/2		50	345	100	690
								3/4 and under		95	655	110	758
								Over 3/4 to 1		80	550	100	690
								Over 1 to 1 1/4		65	450	95	655
								Over 1 1/4 to 1 1/2		50	345	90	620
	ASTM A325	Type 1, 2, 3		A194 or A563	2 or 2H/C3, D, DH, DH3	120/105 KSI Min. Tensile		1/2 to 1	85 (585)	92	634	120	827
	A354	Grade BC		A563	C3, D, DH, DH3	Amb. to 650°F (343°C)	Quenched and Tempered	Over 1 to 1 1/2	74 (510)	81	558	105	720
		Grade BD						1/4 to 2 1/2		109	752	125	862
	A449	Type 1				Amb. to 650°F (343°C)		Over 2 1/2		99	683	115	793
										1/4 to 1		130	896
						Amb. to 700°F (371°C)		Over 2 1/2		115	793	140	965
						Amb. to 650°F (343°C)		1/4 to 1		92	634	120	827
						Amb. to 650°F (343°C)		Over 1 to 1 1/2		81	558	105	720
								Over 1 1/2 to 3		58	400	90	620
		Grade 660						A, B, and C		85	585	130	896
		Grade 651		A453		-50 to 1000°F (-45 to 538°C)	High Temperature Service	Class A (3 and Under)		70	483	100	690
					Over 3				60	414	100	690	
		Grade 662						Class B (3 and Under)		60	414	95	655
				Over 3		50	345	95	655				
		Grade 665						Class A		85	585	130	896
				Class B		80	550	125	862				
								Class A		120	827	170	1172
								Class B		120	827	155	1069

FASTENER DETAILS (CONT.)

Grade Mark	Bolt Spec.	Bolt Grade	Material	Nut Spec.	Suggested Nut Grade	Temperature Ratings	Service Environment	Nominal Stud Size (in)	Mechanical Properties					
									Proof Load	Yield Strength		Tensile Strength		
									KSI	Mpa	KSI	Mpa		
	A490	Grade 1		A563 or A194	DH, DH3, 2H			1/2 to 1 1/2		130	896	150-170	1034-1172	
		Grade 2						1/2 to 1		130	896	150-170	1034-1172	
		Grade 3						1/2 to 1 1/2		130	896	150-170	1034-1172	
	A540	B21, 23 & 24 CL1		A540		Amb. to 700 °F (371 °C)	Special Applications	1/4 to 4		150	1034			
		B21, 23 & 24 CL2			1/4 to 4				140	965				
		B21-24 CL3			1/4 to 6				130	896				
		B21, 23 & 24 CL4			1/4 to 6				120	827		115-165	793-1138	
		B21, 23 & 24 CL5			1/4 to 2				105	720				
					2 1/8 to 8				100	690				
		Grade 1		SAE J995	2			1/4 to 1 1/2	33 (228)	36	248	60	414	
		Grade 2			2			1/4 to 3/4	55 (379)	57	393	74	510	
	SAE J429	Grade 4			2, 5		Bolts, Screws, Studs	1/4 to 1 1/2	33 (228)	100	690	115	793	
		Grade 5			5, 8									
		Grade 7			5, 8									
		Grade 8			8									
	Metric Materials													
			4.6			4				35	241	58	40	
			4.8			4				49	338	61	420	
			5.8			5				61	420	75	517	
			8.8			8				96	662	120	827	
			9.8			9				104	717	131	903	
	SAE	10.9			12					136	938	151	1041	
		12.9			12					160	1103	177	1220	

General Notes:
 1. The Data that are listed is for general reference only. The properties of bolts can differ from the norm.
 2. Consult Lamons Engineering Department for further technical questions.
 3. Blank data indicates that no sufficient information at this time is available for such material.

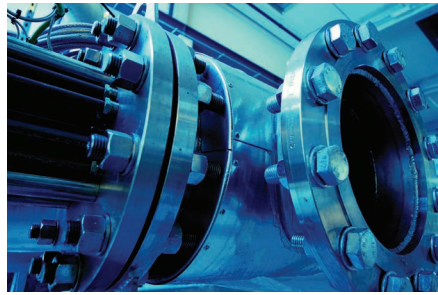
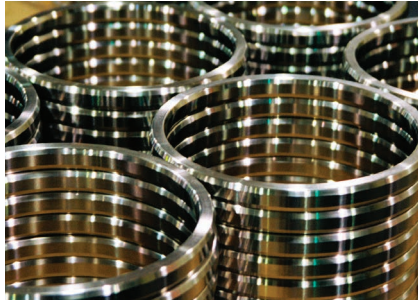

www.lamons.com



Sealing Global - Servicing Local

LAMONS CORPORATE HEADQUARTERS

7300 AIRPORT BLVD.
HOUSTON, TEXAS 77061
UNITED STATES
PHONE: +1 713 222 0284
TOLL FREE: 1 800 231 6906

w w w . l a m o n s . c o m