



Gas Connectors & Accessories

2017/2018 Wholesale Distribution Catalog

Superior Quality



Superior Service



Superior Selection



Effective Date July 7th 2017



www.hubbell.com



For over 125 years Hubbell has been a manufacturer and innovator of best-in-class electrical and electronic products serving the residential, non-residential, construction , industrial and utility markets. The Hubbell Gas Connectors & Accessories group (HGCA) now brings that same business expertise and spirit of innovation to the natural gas market.

- Gas Distribution (LDC)
- Gas Transmission
- **Wholesale Plumbing & LP**
- Gas Transmission & Midstream

Be sure to visit hubbell.com where you can find out more about Hubbell Gas Connectors & Accessories as well as visit each individual company website.

www.conind.com

www.gasbreaker.com

www.rwlyall.com

www.advengcorp.com

2017 Wholesale Distribution Catalog

Pricing Effective 07/07/2017

Table Of Contents

Con-Stab ID Seal® Fittings	
Con-Stab ID Seal® Full Couplings.....	4
Con-Stab ID Seal® End Caps.....	4
Con-Stab ID Seal® Cap-N-Go Couplings.....	4
Con-Stab ID Seal® 3-Way Tees.....	5
Con-Stab ID Seal® 90° Elbows.....	5
Con-Stab ID Seal® PE x Copper Transition Coupling.....	5
Con-Stab ID Seal® Reducer Couplings.....	6
Con-Stab ID Seal® Reducing 3-Way Tees.....	7
Con-Stab ID Seal® Eliminator Saddles.....	16
Con-Stab ID Seal® HVT Eliminator Saddles.....	17
Con-Stab ID Seal® Transition Fittings.....	21-22
LycοFit® Mechanical Fittings	
LycοFit® Mechanical Couplings.....	8
LycοFit® Mechanical End Caps.....	8
LycοFit® Mechanical 3-Way Tees.....	8
LycοFit® 90° Elbows.....	9
LycοFit® Reducer Couplings.....	9
LycοFit® Steel to PE Transition Fittings.....	9
LycοFit® P.E. x Copper Tubing Adapter.....	10
Compression Fittings	
Lyll Mechanical Compression Couplings.....	12
Lyll Mechanical Compression Tees.....	12
Lyll Mechanical Compression Male Adapters.....	12
Continental Industries PA Full Couplings.....	13
Continental Industries PA End Caps.....	13
Continental Industries PA 3-Way Tees.....	13
Continental Industries PA 90° Elbows.....	14
Continental Industries PA Reducer Couplings.....	14
Continental Industries Eliminator Saddles.....	18
Continental Industries HVT (High Volume Tee) Saddles.....	19
Lyll PE Gas Pipe and Fittings.....	15
Transition Fittings	
Lyll Threaded Transition Fittings.....	20
Con-Stab ID Seal® Transition Fittings.....	21-22
Continental Industries Transition Fittings.....	21
Meter Risers	
Lyll Anodeless Meter Risers.....	24
Continental Industries Anodeless Meter Risers.....	25
Lyll Flexible Service Head Adapter Risers.....	26
Continental Industries Conflex Risers.....	27
Lyll Compression (ANODE) Risers.....	28
Lyll Transition (ANODE) Risers.....	29
Riser Brackets.....	30-31
PolyTec Ball Valves	
PolyTec Medium Density PE Valve.....	32
PolyTec Hibh Density PE Valve.....	33
Tools & Accessories	
LycοFit® Assembly Tools.....	10
Con-Stab® Chamfer Tools.....	11
Accessories for Eliminator Saddles.....	11
Tracer Wire.....	34



Gas Connectors & Accessories

CON STAB ID SEAL® FITTINGS

CON STAB ID SEAL® FULL COUPLINGS



CON-STAB ID SEAL® Full Couplings			
PE SIZE	WALL	PART NUMBER (3408/4710)	LIST PRICE
1/2" CTS (5/8" OD)	.090	3259-52-1004-00	\$14.96
3/4" CTS (7/8" OD)	.090	3259-52-1006-00	\$42.49
1" CTS (1 1/8" OD)	.099/.101	3259-52-1008-00	\$28.05
	.090	3259-52-1008-AA	\$28.05
1 1/4" CTS (1 3/8" OD)	.090	3259-52-1039-AA	\$60.00
1/2" IPS	SDR-9.33 (.090)	3259-52-1012-00	\$37.31
3/4" IPS	SDR-11 (.095)	3259-52-1013-00	\$25.92
1" IPS	SDR-11 (.119)	3259-52-1014-00	\$38.48
1 1/4" IPS	SDR-10 (.166)	3259-52-1015-00	\$84.72
	SDR-11 (.151)	3259-52-1015-AA	\$91.58
1 1/2" IPS	SDR-11 (.173)	3259-52-1016-00	\$97.74
2" IPS	SDR-11 (.216)	3259-52-1017-00	\$112.26

• For sizes not listed, contact Continental Industries.

CON STAB ID SEAL® END CAPS



CON-STAB ID SEAL® End Caps			
PE SIZE	WALL	PART NUMBER (3408/4710)	LIST PRICE
1/2" CTS (5/8" OD)	.090	3259-53-1004-00	\$14.96
3/4" CTS (7/8" OD)	.090	3259-53-1006-00	\$48.58
1" CTS (1 1/8" OD)	.099/.101	3259-53-1008-00	\$22.59
	.090	3259-53-1008-0A	\$22.59
1 1/4" CTS (1 3/8" OD)	.090	3259-53-1039-0A	\$52.28
1/2" IPS	SDR-9.33 (.090)	3259-53-1012-00	\$27.67
3/4" IPS	SDR-11 (.095)	3259-53-1013-00	\$22.26
1" IPS	SDR-11 (.119)	3259-53-1014-00	\$26.29
1 1/4" IPS	SDR-10 (.166)	3259-53-1015-00	\$96.58
	SDR-11 (.151)	3259-53-1015-0A	\$103.47
1 1/2" IPS	SDR-11 (.173)	3259-53-1016-00	\$110.78
2" IPS	SDR-11 (.216)	3259-53-1017-00	\$124.78

• For sizes not listed, contact Continental Industries.

CON STAB ID SEAL® CAP-N-GO COUPLINGS



CON-STAB ID SEAL® Cap-N-Go Couplings			
PE SIZE	WALL	PART NUMBER (3408/4710)	LIST PRICE
1/2" CTS (5/8" OD)	.090	3259-57-1004-00	\$23.24
1" CTS (1 1/8" OD)	.099/.101	3259-57-1008-00	\$36.45
	.090	3259-57-1008-AA	\$36.76
1/2" IPS	SDR-9.33 (.090)	3259-57-1012-00	\$45.60
3/4" IPS	SDR-11 (.095)	3259-57-1013-00	\$56.54
1" IPS	SDR-11 (.119)	3259-57-1014-00	\$40.63
1 1/4" IPS	SDR-10 (.166)	3259-57-1015-00	\$122.93
	SDR-11 (.151)	3259-57-1015-AA	\$122.93
2" IPS	SDR-11 (.216)	3259-57-1017-00	\$244.26

• For sizes not listed, contact Continental Industries.

CON STAB ID SEAL® FITTINGS



Gas Connectors & Accessories

CON STAB ID SEAL® 3 WAY TEES

CON-STAB ID SEAL® 3-Way Tees			
PE SIZE	WALL	PART NUMBER (3408/4710)	LIST PRICE
1/2" CTS (5/8" OD)	.090	3259-50-1004-00	\$51.69
3/4" CTS (7/8" OD)	.090	3259-50-1006-00	\$79.69
1" CTS (1 1/8" OD)	.099/.101	3259-50-1008-00	\$66.48
	.090	3259-50-1008-AA	\$66.48
1 1/4" CTS (1 3/8" OD)	.090	3259-50-1039-AA	\$136.35
1/2" IPS	SDR-9.33 (.090)	3259-50-1012-00	\$71.49
3/4" IPS	SDR-11 (.095)	3259-50-1013-00	\$70.04
1" IPS	SDR-11 (.119)	3259-50-1014-00	\$77.30
1 1/4" IPS	SDR-10 (.166)	3369-50-1015-00*	\$157.03
	SDR-11 (.151)	3259-50-1015-AA	\$166.22
1 1/2" IPS	SDR-11 (.173)	3259-50-1016-00	\$253.69
2" IPS	SDR-11 (.216)	3259-50-1017-00	\$229.36



- For sizes not listed, contact Continental Industries.
- * = 1 1/4" IPS SDR-10 Fitting is only available in PE 2406 yellow.

CON STAB ID SEAL® 90° ELBOWS

CON-STAB ID SEAL® 90° Elbows			
PE SIZE	WALL	PART NUMBER (3408/4710)	LIST PRICE
1/2" CTS (5/8" OD)	.090	3259-51-1004-00	\$23.06
3/4" CTS (7/8" OD)	.090	3259-51-1006-00	\$35.88
1" CTS (1 1/8" OD)	.099/.101	3259-51-1008-00	\$35.60
	.090	3259-51-1008-AA	\$35.60
1 1/4" CTS (1 3/8" OD)	.090	3259-51-1039-AA	\$100.92
1/2" IPS	SDR-9.33 (.090)	3259-51-1012-00	\$49.08
3/4" IPS	SDR-11 (.095)	3259-51-1013-00	\$30.19
1" IPS	SDR-11 (.119)	3259-51-1014-00	\$34.49
1 1/4" IPS	SDR-10 (.166)	3369-51-1015-00	\$116.04
	SDR-11 (.151)	3259-51-1015-AA	\$121.03
1 1/2" IPS	SDR-11 (.173)	3259-51-1016-00	\$170.04
2" IPS	SDR-11 (.216)	3259-51-1017-00	\$147.21



- For sizes not listed, contact Continental Industries.

CON STAB ID SEAL® P.E. X COPPER TRANSITION COUPLING

CON-STAB ID SEAL® P.E. x Copper Transition Couplings				
PE SIZE	WALL	COPPER SIZE	PART NUMBER (3408/4710)	LIST PRICE
1/2" CTS (5/8" OD)	.090	1/4" OD	9943-99-0062-00	\$44.38
		3/8" OD	9943-99-0063-00	\$45.17
		1/2" OD	9943-99-0064-00	\$46.69
		5/8" OD	9943-99-0065-00	\$47.34
3/4" IPS	SDR-11 (.095)	5/8" OD	9943-99-0066-00	\$70.96



- For sizes not listed, contact Continental Industries.



Gas Connectors & Accessories

CON STAB ID SEAL® FITTINGS

CON STAB ID SEAL® REDUCER COUPLING



CON-STAB ID SEAL® Reducer Couplings						
PE SIZE	WALL	PE SIZE	WALL	PART NUMBER (3408/4710)	LIST PRICE	
3/4" CTS (7/8" OD)	.090	1/2" CTS (5/8" OD)	.090	3259-54-0604-00	\$80.99	
1" CTS (1 1/8" OD)	.099/.101	3/4" IPS	SDR-11 (.095)	3259-54-0813-00	\$68.37	
	.090			3259-54-0813-A0	\$68.37	
	.099/.101	3/4" CTS (7/8" OD)	.090	3259-54-0806-00	\$70.93	
	.090			3259-54-0806-A0	\$70.93	
	.099/.101	1/2" IPS	SDR-9.33 (.090)	3259-54-0812-00	\$49.08	
	.090			3259-54-0812-A0	\$49.08	
	1 1/4" CTS (1 3/8" OD)	.090	1/2" CTS (5/8" OD)	.090	3259-54-0804-00	\$64.88
3259-54-0804-A0					\$64.88	
1" IPS			SDR-11	3259-54-3914-A0	\$87.78	
1 1/4" CTS (1 3/8" OD)	.090	1" CTS (1 1/8" OD)	.099/.101	3259-54-3908-A0	\$90.76	
			.090	3259-54-3908-AA	\$90.76	
1/2" IPS	SDR-9.33 (.090)	1/2" CTS (5/8" OD)	.090	3259-54-1204-00	\$81.59	
3/4" IPS	SDR-11 (.095)	1/2" IPS	SDR-9.33 (.090)	3259-54-1312-00	\$74.34	
		3/4" CTS (7/8" OD)	.090	3259-54-1306-00	\$66.47	
		1/2" CTS (5/8" OD)	.090	3259-54-1304-00	\$64.77	
1" IPS	SDR-11 (.119)	1" CTS (1 1/8" OD)	.099/.101	3259-54-1408-00	\$72.52	
			.090	3259-54-1408-OA	\$72.52	
		3/4" IPS	SDR-11 (.095)	3259-54-1413-00	\$72.31	
		3/4" CTS (7/8" OD)	.090	3259-54-1406-00	\$88.42	
		1/2" IPS	SDR-9.33 (.090)	3259-54-1412-00	\$78.86	
1 1/4" IPS	SDR-10 (.166) SDR-11 (.151)	1/2" CTS	.090	3259-54-1404-00	\$72.32	
		1 1/4" IPS	SDR-11 (.151)	3259-54-1515-0A	\$91.63	
		1 1/4" CTS (1 3/8" OD)	.090	3259-54-1539-AA	\$124.26	
		1" IPS	SDR-11 (.119)	3259-54-1514-00	\$123.87	
				3259-54-1514-A0	\$123.87	
		1" CTS (1 1/8" OD)	SDR-10 (.166) SDR-11 (.151)	.099/.101	3259-54-1508-00	\$97.73
					.090	3259-54-1508-OA
				.099/.101	3259-54-1508-A0	\$97.73
					.090	3259-54-1508-AA
		3/4" IPS	SDR-10 (.166) SDR-11 (.151)	SDR-11 (.095)	3259-54-1513-00	\$98.60
3259-54-1513-A0	\$98.60					
1 1/2" IPS	SDR-11 (.173)	3/4" IPS	SDR-11 (.095)	3259-54-1613-00	\$116.84	
		1" IPS	SDR-11 (.119)	3259-54-1614-00	\$120.43	
		1 1/4" IPS	SDR-10 (.166)	3369-54-1615-00	\$151.17	
			SDR-11 (.151)	3259-54-1615-0A	\$151.17	
2" IPS	SDR-11	1 1/2" IPS	SDR-11 (.173)	3259-54-1716-00	\$158.48	
		1 1/4" IPS	SDR-10 (.166)	3369-54-1715-00	\$126.80	
			SDR-11 (.151)	3259-54-1715-0A	\$130.18	
		1" IPS	SDR-11 (.119)	3259-54-1714-00	\$126.15	
		1" CTS (1 1/8" OD)	.099/.101	3259-54-1708-00	\$121.83	
.090	3259-54-1708-OA			\$121.83		

• For sizes not listed, contact Continental Industries.

CON STAB ID SEAL® FITTINGS



Gas Connectors & Accessories

CON STAB ID SEAL® 3 WAY REDUCING TEES



CON-STAB ID SEAL® 3-Way Reducing Tees							
PE SIZE (Run)	WALL	PE SIZE (Branch)	WALL	PART NUMBER (3408/4710) HDPE	LIST PRICE	PART NUMBER (2406) MDPE	LIST PRICE
1/2" CTS (5/8" OD)	.090	1" CTS (1 1/8" OD)	.099/.101	3259-49-0408-00	\$135.06	3369-49-0408-00	\$135.06
		1" CTS (1 1/8" OD)	.090	3259-49-0408-0A	\$137.18	3369-49-0408-0A	\$135.06
3/4" CTS (7/8" OD)	.090	1/2" CTS (5/8" OD)	.090	3259-49-0604-00	\$184.46	3369-49-0604-00	\$184.46
1" CTS (1 1/8" OD)	.099/.101	1/2" CTS (5/8" OD)	.090	3259-49-0804-00	\$100.21	3369-49-0804-00	\$100.21
	.090			3259-49-0804-A0	\$100.21	3369-49-0804-A0	\$100.21
1 1/4" CTS (1 3/8" OD)	.090	1/2" CTS (5/8" OD)	.090	3259-49-3904-A0	\$136.16	3369-49-3904-A0	\$136.16
1/2" IPS	SDR-9.33 (.090)	1/2" CTS (5/8" OD)	.090	3259-49-1204-00	\$175.76	3369-49-1204-00	\$175.76
3/4" IPS	SDR-11 (.095)	1/2" CTS (5/8" OD)	.090	3259-49-1304-00	\$108.92	3369-49-1304-00	\$108.92
1" IPS	SDR-11 (.119)	1" CTS (1 1/8" OD)	.099/.101	3259-49-1408-00	\$228.00	3369-49-1408-00	\$228.00
			.090	3259-49-1408-0A	\$228.00	3369-49-1408-0A	\$228.00
		3/4" IPS	SDR-11 (.095)	3259-49-1413-00	\$229.61	3369-49-1413-00	\$229.61
		1/2" CTS	.090	3259-49-1404-00	\$228.00	3369-49-1404-00	\$228.00
		1/2" IPS	SDR-9.33 (.090)	3259-49-1412-00	\$228.79	3369-49-1412-00	\$228.79
1 1/4" IPS	SDR-10 (.166)	1" CTS (1 1/8" OD)	.099/.101	Not Available		3369-49-1508-00	\$200.97
			.090	Not Available		3369-49-1508-0A	\$200.97
	SDR-11 (.151)	1" CTS (1 1/8" OD)	.099/.101	3259-49-1508-A0	\$203.54	Not Available	
			.090	3259-49-1508-AA	\$203.54	Not Available	
	SDR-10 (.166)	1" IPS	SDR-11 (.119)	3259-49-1514-00	\$202.94	3369-49-1514-00	\$202.94
				3259-49-1514-A0	\$208.38	3369-49-1514-A0	\$208.38
SDR-10 (.166)	SDR-11 (.151)	3/4" IPS	SDR-11 (.095)	Not Available		3369-49-1513-00	\$201.79
				3259-49-1513-A0	\$204.34	Not Available	
1 1/2" IPS	SDR-11 (.173)	1 1/4" IPS	SDR-10 (.166)	3259-49-1615-00	\$213.33	3369-49-1615-00	\$213.33
			SDR-11 (.151)	3259-49-1615-0A	\$215.91	3369-49-1615-0A	\$215.91
		1" IPS	SDR-11 (.119)	3259-49-1614-00	\$212.28	3369-49-1614-00	\$212.28
		3/4" IPS	SDR-11 (.095)	3259-49-1613-00	\$208.68	3369-49-1613-00	\$208.68
2" IPS	SDR-11	1 1/2" IPS	SDR-11 (.173)	3259-49-1716-00	\$226.83	3369-49-1716-00	\$226.83
		1 1/4" IPS	SDR-10 (.166)	Not Available		3369-49-1715-00	\$420.98
			SDR-11 (.151)	3259-49-1715-0A	\$358.79	3369-49-1715-0A	\$358.79
		1" IPS	SDR-11 (.119)	3259-49-1714-00	\$244.47	3369-49-1714-00	\$244.47
		3/4" IPS	SDR-11 (.095)	3259-49-1713-00	\$238.22	3369-49-1713-00	\$238.22
		1" CTS (1 1/8" OD)	.099/.101	3259-49-1708-00	\$399.91	3369-49-1708-00	\$399.91
.090	3259-49-1708-0A		\$338.40	3369-49-1708-0A	\$338.40		

• For sizes not listed, contact Continental Industries.



Gas Connectors & Accessories

LYCOFIT[®] MECHANICAL FITTINGS



LYCOFIT[®] MECHANICAL COUPLINGS



LYCOFIT [®] MECHANICAL Couplings				
PE SIZE	WALL	MINIMUM QTY.	PART NUMBER	LIST PRICE
1/2" CTS	DR7	3	LC010B-DER	\$23.32
3/4" IPS	DR11	3	LC060Y-DER	\$42.63
1" IPS	DR11	3	LC070Y-DER	\$48.84
1 1/4" IPS	DR10/11	3	LC080X-DESR	\$104.20
1 1/2" IPS	DR11	2	LC090Y-DESR	\$129.15
2" IPS	DR11	2	LC200Y-DESR	\$169.42

LYCOFIT[®] MECHANICAL END CAPS



LYCOFIT [®] MECHANICAL End Caps				
PE SIZE	WALL	MINIMUM QTY.	PART NUMBER	LIST PRICE
3/4" IPS	DR11	3	LC060Y-ECR	\$41.01
1" IPS	DR11	3	LC070Y-ECR	\$44.64
1 1/4" IPS	DR10/11	3	LC080X-ECR	\$89.12
1 1/2" IPS	DR11	3	LC090Y-ECR	\$112.10
2 IPS	DR11	3	LC200Y-ECR	\$192.92

LYCOFIT[®] MECHANICAL 3-WAY TEES



LYCOFIT [®] MECHANICAL 3-Way Tees				
PE SIZE	WALL	MINIMUM QTY.	PART NUMBER	LIST PRICE
1/2" CTS	DR7	3	LC010B-3TR	\$103.17
3/4" IPS	DR11	3	LC060Y-3TR	\$110.75
1 IPS	DR11	3	LC070Y-3TR	\$127.70
1 1/4" IPS	DR10/11	3	LC080X-3TR	\$270.41
1 1/2" IPS	DR11	2	LC090Y-3TR	\$273.84
2" IPS	DR11	2	LC200Y-3TR	\$318.48

LYCOFIT® MECHANICAL FITTINGS



Gas Connectors & Accessories

90° ELBOWS

LYCOFIT® MECHANICAL 90° ELBOWS				
PE Pipe Size	Wall Thickness	Min. Qty	Product Code	List Price
½ CTS	DR7	3	LC010B-ELR	\$90.29
¾ IPS	DR11	3	LC060Y-ELR	\$91.78
1 IPS	DR11	3	LC070Y-ELR	\$95.24
1 ¼ IPS	DR10/11	3	LC080X-ELR	\$223.45
1 ½ IPS	DR11	2	LC090Y-ELR	\$248.77
2 IPS	DR11	2	LC200Y-ELR	\$286.98



REDUCER COUPLINGS

LYCOFIT® MECHANICAL REDUCER COUPLING				
Coupling Size	Wall Thickness	Min. Qty	Product Code	List Price
1 X ¾ IPS	DR11	3	LC070Y060Y-RR	\$144.03
1 ¼ X ¾ IPS	DR10/11	3	LC080X060Y-RR	\$147.55
1 ¼ X 1 IPS	DR10/11	3	LC080X070Y-RR	\$147.55
1 ½ X 1 ¼ IPS	DR11	3	LC090Y080X-RR	\$240.46
1 ½ X ¾ IPS	DR11	3	LC090Y060Y-RR	\$240.46
1 ½ X 1 IPS	DR11	3	LC090Y070Y-RR	\$240.46
2 X ¾ IPS	DR11	3	LC200Y060Y-RR	\$266.77
2 X 1 IPS	DR11	3	LC200Y070Y-RR	\$266.77
2 X 1 ¼ IPS	DR11	3	LC200Y080X-RR	\$266.77
2 X 1 ½ IPS	DR11	3	LC200Y090Y-RR	\$266.77



Note: Listed above are standard sizes available from Lyall. We can manufacture couplings in almost any configuration. If you don't see what you need listed, please contact Lyall customer service or your authorized sales representative for technical support and pricing information.

STEEL TO PE TRANSITION FITTINGS

STEEL TO PE TRANSITION FITTINGS				
Steel Pipe Size	PE Pipe Size	Min. Qty	Product Code	List Price
½ NPT SCH40	1/2 CTS .090/DR7	3	LC050S010B-SPB	\$44.86
¾ NPT SCH40	3/4 IPS DR11	3	LC060S060Y-SPB	\$51.59
1 NPT SCH40	1 IPS DR11	3	LC070S070Y-SPB	\$76.38
1 ¼ NPT SCH40	1-1/4 IPS DR10/11	3	LC080S080X-SPB	\$133.63
1 ½ NPT SCH40	1-1/2 IPS DR11	3	LC090S090Y-SPB	\$128.22
2 NPT SCH40	2 IPS DR11	3	LC200S200Y-SPB	\$409.01





Gas Connectors & Accessories

LYCOFIT[®] MECHANICAL FITTINGS

LYCOFIT[®] P.E. X COPPER TUBING ADAPTER

LYCOFIT [®] P.E. x Copper Tubing Adapter (Grill Adapter)				
PE SIZE	WALL	COPPER SIZE	PART NUMBER (3408/4710)	LIST PRICE
1/2" CTS	.090	3/8" OD GGS	LC375010B-GCR	\$94.27
		1/2" OD	LC500010B-GCR	\$78.51



LYCOFIT[®] ASSEMBLY TOOLS

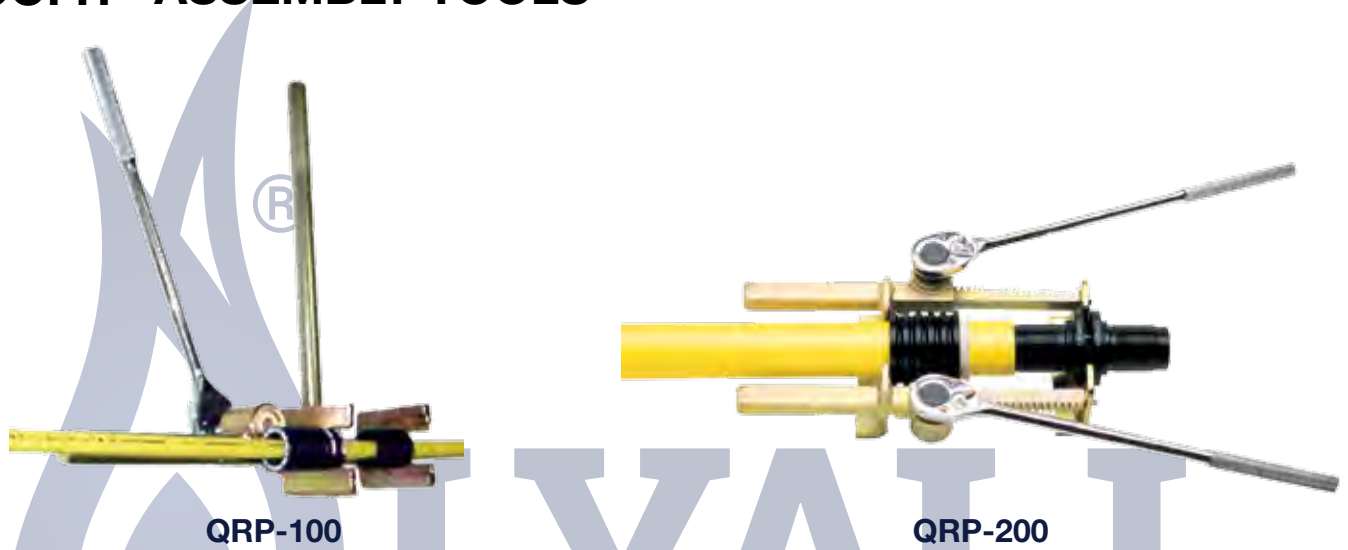

LYCOFIT [®] QUICK RATCHET PRESS (QRP) ASSEMBLY TOOL				
Tool	Fitting Sizes	Min. Qty	Product Code	List Price
QRP-100	1/2 CTS through 1 IPS	1	QRP-100	\$368.54
QRP-200	1/2 CTS through 2 IPS	1	QRP-200	\$979.53

Note:

The QRP-100 tool requires one (1) long handled, 1/2" drive ratchet wrench to operate.
 The QRP-200 tool requires two (2) long handled, 1/2" drive ratchet wrenches to operate.

LYCOFIT [®] ASSEMBLY TOOL INSTALLATION CHART										
Tool Model	1/2 CTS	3/4 CTS	1 CTS	1-1/4 CTS	1/2 IPS	3/4 IPS	1 IPS	1-1/4 IPS	1-1/2 IPS	2 IPS
QRP-100	YES	YES	YES		YES	YES	YES			
QRP-200	YES*	YES*	YES*	YES*	YES*	YES*	YES*	YES*	YES*	YES*
LHP-200								YES	YES	YES

* Installs the coupling/fitting size indicated when using the appropriate adapter plates.

CON STAB ID SEAL® FITTINGS



CHAMFER TOOL



DOUBLE ENDED ID CHAMFER TOOLS		
PART NUMBER	DESCRIPTION	LIST PRICE
0000-33-5647-00	1/2" IPS X 1/2" CTS (5/8" OD)	\$38.20
0000-33-5481-00	3/4" IPS X 1/2" CTS (5/8" OD)	\$38.20
0000-33-5652-00	3/4" IPS X 1/2" IPS	\$38.20
0000-33-5651-00	3/4" CTS (7/8" OD) X 1/2" CTS (5/8" OD)	\$38.20
0000-33-5609-00	3/4" CTS (7/8" OD) X 1/2" IPS	\$38.20
0000-33-5480-00	1" CTS (1 1/8" OD) X 1/2" CTS (5/8" OD)	\$38.20
0000-33-5963-00	1" CTS (1 1/8" OD) X 1/2" IPS	\$38.20
0000-33-5763-00	1" CTS (1 1/8" OD) X 3/4" CTS (7/8" OD)	\$38.20
0000-33-5589-00	1" CTS (1 1/8" OD) X 3/4" IPS	\$38.20
0000-33-5514-00	1" IPS X 1/2" CTS (5/8" OD)	\$38.20
0000-33-5516-00	1" IPS X 3/4" IPS	\$38.20
0000-33-5606-00	1" IPS X 1" CTS (1 1/8" OD)	\$38.20
0000-33-5515-00	1 1/4" CTS (1 3/8" OD) X 1/2" CTS (5/8" OD)	\$38.20
0000-33-5798-00	1 1/4" CTS (1 3/8" OD) X 3/4" IPS	\$38.20
0000-33-5631-00	1 1/4" CTS (1 3/8" OD) X 1" CTS (1 1/8" OD)	\$38.20
0000-33-6572-00	1 1/4" CTS (1 3/8" OD) X 1" IPS	\$38.20

ID CHAMFER TOOLS WITH GAUGE		
PART NUMBER	DESCRIPTION	LIST PRICE
0000-33-6580-04	1/2" CTS (5/8" OD) .090 WALL	\$38.20
0000-33-6580-06	3/4" CTS (7/8" OD) .090 WALL	\$38.20
0000-33-6580-02	1" CTS (1 1/8" OD) .090 WALL	\$38.20
0000-33-6580-08	1" CTS (1 1/8" OD) .099/.101 WALL	\$38.20
0000-33-6580-12	1/2" IPS SDR-9.3	\$38.20
0000-33-6580-13	3/4" IPS SDR-11	\$38.20
0000-33-6580-14	1" IPS SDR-11	\$38.20
0000-33-6580-03	1 1/4" CTS (1 3/8" OD) .090 WALL	\$38.20
0000-33-6580-10	1 1/4" IPS SDR-11 (.151 WALL)	\$38.20
0000-33-6580-15	1 1/4" IPS SDR-10 (.166 WALL)	\$38.20
0000-33-6580-09	1 1/4" IPS SDR-9.3 (.178 WALL)	\$38.20
0000-33-6580-16	1 1/2" IPS SDR-11	\$38.20
0000-33-6580-17	2" IPS SDR-11	\$38.20

ACCESSORIES FOR ELIMINATORS



33-5505-00 ~ Combination Tapping Tool & Saddle Bolt "T" Wrench for 1 1/4" thru 6" IPS Con-Stab ID Seal® Eliminators (List Price \$75.46)

33-5505-01 ~ Combination Tapping Tool & Saddle Bolt "T" Wrench for 3" thru 8" IPS Con-Stab ID Seal® Eliminators (List Price \$93.69)



33-5508-00 ~ Test Plug Cap for Eliminator Saddles with 1/4" FPT for attachment of quick connect coupling (List Price \$83.50)

33-6290-00 ~ Test Plug Cap for HVT Saddles with 1/4" FPT for attachment of quick connect coupling (List Price \$156.05)



33-4363-00 ~ 1/2" Square Drive Key, Bushing & Socket Adapter Ass'y for HVT Eliminator Saddles (List Price \$204.93)



Gas Connectors & Accessories

MECHANICAL COMPRESSION FITTINGS

MECHANICAL COMPRESSION FITTINGS (EPOXY COATED)

Pressure rating: 10 psi

COMPRESSION COUPLINGS

COMPRESSION COUPLINGS					
PE SIZE	DR	Min. Order Qty	Product Code	NOTES	List Price
¾ IPS X ¾ IPS	11	5	361051050800	‡	\$66.96
1 IPS X 1 IPS	11	5	361321320800	‡	\$80.01
1 ¼ IPS X 1 ¼ IPS	10	3	361661660700	‡	\$87.58
1 ½ IPS X 1 ½ IPS	11	3	361901900800	‡	\$150.92
2 IPS X 2 IPS	11	3	362382380800	‡	\$212.94

‡ = IAPMO/UPC Listed

Includes built-in stiffener



COMPRESSION TEES

COMPRESSION TEES					
PE SIZE	DR	Min. Order Qty	Product Code	NOTES	List Price
¾ IPS X ¾ IPS	11	5	381051050800	‡	\$113.02
1 IPS X 1 IPS	11	5	381321320800	‡	\$136.43
1 ¼ IPS X 1 ¼ IPS	10	3	381661660700	‡	\$156.46

‡ = IAPMO/UPC Listed

Includes built-in stiffener



COMPRESSION MALE ADAPTERS

COMPRESSION MALE ADAPTERS					
Steel X PE	DR	Min. Order Qty	Product Code	NOTES	List Price
¾ NPT X ¾ IPS	11	5	341051050800	‡	\$38.50
1 NPT X 1 IPS	11	5	341321320800	‡	\$43.65
1 ¼ NPT X 1 ¼ IPS	10	3	341661660700	‡	\$54.03
1 ½ NPT X 1 ½ IPS	11	3	341901900800	‡	\$100.99
2 IPS X 2 IPS	11	3	342382380800	‡	\$117.53

‡ = IAPMO/UPC Listed

Includes built-in stiffener



COMPRESSION FITTINGS



Gas Connectors & Accessories

PA COMPRESSION

PA COMPRESSION FULL COUPLINGS			
PE SIZE	WALL	PART NUMBER	LIST PRICE
1/2" CTS (5/8" OD)	.090	5657-52-1004-00	\$25.24
	.062	5657-52-1004-AA	\$25.24
1" CTS (1 1/8" OD)	.099/.101	5657-52-1008-00	\$38.37
	.090	5657-52-1008-AA	\$46.22
3/4" IPS	SDR-11 (.095)	5657-52-1013-00	\$38.37
1" IPS	SDR-11 (.119)	5657-52-1014-00	\$64.55
1 1/4" IPS	SDR-10 (.166)	5657-52-1015-00	\$127.22
	SDR-11 (.151)	5657-52-1015-AA	\$127.22
2" IPS	SDR-11 (.216)	5657-52-1017-00	\$177.38



• For sizes not listed, contact Continental Industries.

PA COMPRESSION END CAPS			
PE SIZE	WALL	PART NUMBER	LIST PRICE
1/2" CTS (5/8" OD)	.090	5657-53-1004-00	\$14.42
	.062	5657-53-1004-OA	\$14.42
1" CTS (1 1/8" OD)	.099/.101	5657-53-1008-00	\$23.96
	.090	5657-53-1008-OA	\$23.96
3/4" IPS	SDR-11 (.095)	5657-53-1013-00	\$23.96
1" IPS	SDR-11 (.119)	5657-53-1014-00	\$63.82
1 1/4" IPS	SDR-10 (.166)	5657-53-1015-00	\$100.59
	SDR-11 (.151)	5657-53-1015-OA	\$100.59
2" IPS	SDR-11 (.216)	5657-53-1017-00	\$108.02



• For sizes not listed, contact Continental Industries.

PA COMPRESSION 3-WAY TEES			
PE SIZE	WALL	PART NUMBER	LIST PRICE
1/2" CTS (5/8" OD)	.090	5657-50-1004-00	\$44.30
	.062	5657-50-1004-AA	\$44.30
1" CTS (1 1/8" OD)	.099/.101	5657-50-1008-00	\$58.95
	.090	5657-50-1008-AA	\$58.95
3/4" IPS	SDR-11 (.095)	5657-50-1013-00	\$58.95



• For sizes not listed, contact Continental Industries.



Gas Connectors & Accessories

COMPRESSION FITTINGS

PA COMPRESSION

PA COMPRESSION 90° ELBOWS			
PE SIZE	WALL	PART NUMBER	LIST PRICE
1/2" CTS (5/8" OD)	.090	5657-51-1004-00	\$35.30
	.062	5657-51-1004-AA	\$35.94
1" CTS (1 1/8" OD)	.099/.101	5657-51-1008-00	\$46.73
	.090	5657-51-1008-AA	\$46.73
3/4" IPS	SDR-11 (.095)	5657-51-1013-00	\$46.73

• For sizes not listed, contact Continental Industries.



PA COMPRESSION REDUCER COUPLINGS					
PE SIZE	WALL	PE SIZE	WALL	PART NUMBER	LIST PRICE
1/2" CTS (5/8" OD)	.090	1/2" CTS (5/8" OD)	.062	5657-54-0404-0A	\$25.24
		1/4" CTS (3/8" OD)	.062	5657-54-0402-00	\$29.57
	.062				5657-54-0402-A0
1" CTS (1 1/8" OD)	.099/.101	3/4" IPS	SDR-11 (.095)	5657-54-0813-00	\$49.18
	.090			5657-54-0813-A0	\$49.18
	.099/.101	1/2" CTS (5/8" OD)	.062	5657-54-0804-0A	\$32.01
	.090			5657-54-0804-AA	\$32.01
	.099/.101			5657-54-0804-00	\$32.01
	.090			5657-54-0804-A0	\$32.01
3/4" IPS	SDR-11 (.095)	1/2" CTS (5/8" OD)	.090	5657-54-1304-00	\$33.92
			.062	5657-54-1304-0A	\$33.92
1" IPS	SDR-11 (.119)	1" CTS (1 1/8" OD)	.099/.101	5657-54-1408-00	\$60.96
			.090	5657-54-1408-0A	\$60.96
		3/4" IPS	SDR-11 (.095)	5657-54-1413-00	\$60.96
		1/2" CTS	.090	5657-54-1404-00	\$49.82
			.062	5657-54-1404-0A	\$49.82
1 1/4" IPS	SDR-10 (.166)	1 1/4" IPS	SDR-11 (.151)	5657-54-1015-0A	\$127.23

• For sizes not listed, contact Continental Industries.

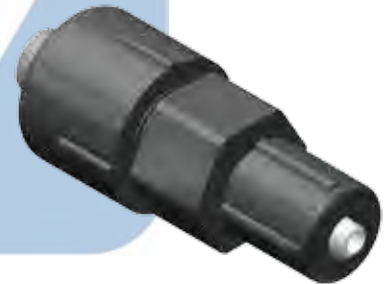

PE GAS PIPE AND FITTINGS



Gas Connectors & Accessories

POLYETHYLENE (PE) PIPE

POLYETHYLENE (PE) PIPE					
Size	Description	Coil Qty. (Feet)	Pallet Qty. (Feet)	Product Code	List Price Per Foot
½ CTS	DR7 / PE2406	1000	10,000	PE010B-T-PC	\$1.02
¾ IPS	DR11 / PE2406	250	3,500	PE060Y-T-PC	\$1.17
1 IPS	DR11 / PE2406	250	2,750	PE070Y-T-PC	\$1.83
1 ¼ IPS	DR10 / PE2406	250	3,000	PE080X-T-PC	\$3.03
1 ½ IPS	DR11 / PE2406	250	2,500	PE090Y-T-PC	\$3.76
2 IPS	DR11 / PE2406	250	2,500	PE200Y-T-PC	\$4.12

POLYETHYLENE (PE) SOCKET FITTINGS

POLYETHYLENE (PE) SOCKET COUPLINGS					
Size	Description	Bag Qty.	Min. Order Qty.	Product Code	List Price
¾ IPS	PE Socket Coupling	10	Multi. of Bag Qty	SFC060T	\$4.54
1 IPS	PE Socket Coupling	10	Multi. of Bag Qty	SFC070T	\$4.63
1 ¼ IPS	PE Socket Coupling	10	Multi. of Bag Qty	SFC080T	\$5.51
1 ½ IPS	PE Socket Coupling	10	Multi. of Bag Qty	SFC090T	\$9.73
2 IPS	PE Socket Coupling	10	Multi. of Bag Qty	SFC200T	\$7.88
1 IPS X ¾ IPS	PE Reducer Coupling	10	Multi. of Bag Qty	SFR070060T	\$14.15
1 ¼ IPS X ¾ IPS	PE Reducer Coupling	10	Multi. of Bag Qty	SFR080060T	\$23.53
1 ¼ IPS X 1 IPS	PE Reducer Coupling	10	Multi. of Bag Qty	SFR080070T	\$26.22
1 ½ IPS X 1 ¼ IPS	PE Reducer Coupling	10	Multi. of Bag Qty	SFR090080T	\$30.12
1 ½ IPS X 1 IPS	PE Reducer Coupling	10	Multi. of Bag Qty	SFR090070T	\$52.11
1 ½ IPS X ¾ IPS	PE Reducer Coupling	10	Multi. of Bag Qty	SFR090060T	\$26.24
¾"	PE Socket Ell	10	Multi. of Bag Qty	SFE060T	\$9.49
1"	PE Socket Ell	10	Multi. of Bag Qty	SFE070T	\$10.10
1 ¼"	PE Socket Ell	10	Multi. of Bag Qty	SFE080T	\$12.37
1 ½"	PE Socket Ell	10	Multi. of Bag Qty	SFE090T	\$34.72
¾"	PE Socket Tee	10	Multi. of Bag Qty	SFT060T	\$7.74
1"	PE Socket Tee	10	Multi. of Bag Qty	SFT070T	\$9.72
1 ¼"	PE Socket Tee	10	Multi. of Bag Qty	SFT080T	\$13.70
1 ½"	PE Socket Tee	10	Multi. of Bag Qty	SFT090T	\$26.52
2"	PE Socket Tee	10	Multi. of Bag Qty	SFT200T	\$27.60
¾"	PE End Cap	10	Multi. of Bag Qty	SFEC060T	\$7.53
1"	PE End Cap	10	Multi. of Bag Qty	SFEC070T	\$9.28
1 ¼"	PE End Cap	10	Multi. of Bag Qty	SFEC080T	\$9.41
1 ½"	PE End Cap	10	Multi. of Bag Qty	SFEC090T	\$15.44



Gas Connectors & Accessories

CON STAB ID SEAL® ELIMINATOR



33-5508-00 ~ Test Plug Cap for Eliminator Saddles
page 11



33-5505-00 ~ Combination Tapping Tool & Saddle Bolt "T"
Wrench for 1 1/4" thru 6" IPS Con-Stab ID
Seal® Eliminators page 11

33-5505-01 ~ Combination Tapping Tool & Saddle Bolt "T"
Wrench for 3" thru 8" IPS Con-Stab ID
Seal® Eliminators page 11

CON-STAB ID SEAL® ELIMINATORS						
OUTLET (PE SIZE)	WALL	MAIN SIZE	PART NUMBER 5864 1/2" CR PUNCH	LIST PRICE	PART NUMBER 5764 13/16" CR PUNCH	LIST PRICE
1/2" CTS (5/8" OD)	.090	1 1/4"	5864-15-1604-00	\$74.00	N/A	
		1 1/2"	5864-16-1604-00	\$120.43	N/A	
		2"	5864-17-1604-00	\$66.79	5764-17-1604-00†	\$74.42
		3"	5864-19-1604-00	\$79.52	5764-19-1604-00†	\$88.74
		4"	5864-21-1604-00	\$97.10	5764-21-1604-00†	\$98.29
		6"	5864-24-1604-00	\$100.39	5764-24-1604-00†	\$110.04
3/4" CTS (7/8" OD)	.090	1 1/4"	5864-15-1606-00	\$100.59	N/A	
		2"	5864-17-1606-00	\$104.83	5764-17-1606-00	\$107.71
		3"	5864-19-1606-00	\$107.92	5764-19-1606-00	\$116.61
		4"	5864-21-1606-00	\$125.52	5764-21-1606-00	\$127.11
		6"	5864-24-1606-00	\$143.96	5764-24-1606-00	\$143.33
		8"	N/A		5764-26-1606-00	\$241.59
1" CTS (1 1/8" OD)	.099/.101	1 1/4"	5864-15-1608-00	\$80.67	N/A	
		2"	5864-17-1608-00	\$75.07	5764-17-1608-00	\$79.09
		3"	5864-19-1608-00	\$86.50	5764-19-1608-00	\$93.41
		4"	5864-21-1608-00	\$100.49	5764-21-1608-00	\$101.77
		6"	5864-24-1608-00	\$115.33	5764-24-1608-00	\$114.81
		8"	N/A		5764-26-1608-00	\$217.38
	.090	1 1/4"	5864-15-1608-0A	\$80.67	N/A	\$79.09
		2"	5864-17-1608-0A	\$75.07	5764-17-1608-0A	\$93.41
		3"	5864-19-1608-0A	\$86.50	5764-19-1608-0A	\$101.77
		4"	5864-21-1608-0A	\$100.49	5764-21-1608-0A	\$114.81
		6"	5864-24-1608-0A	\$115.33	5764-24-1608-0A	\$114.81
		8"	N/A		5764-26-1608-0A	\$217.38
1/2" IPS	SDR-9.33 (.090)	1 1/4"	5864-15-1612-00	\$100.59	N/A	
		2"	5864-17-1612-00	\$93.82	5764-17-1612-00	\$98.82
		3"	5864-19-1612-00	\$107.92	5764-19-1612-00	\$116.61
		4"	5864-21-1612-00	\$125.52	5764-21-1612-00	\$127.11
		6"	5864-24-1612-00	\$143.96	5764-24-1612-00	\$143.33
		8"	N/A		5764-26-1612-00	\$241.59
3/4" IPS	SDR-11 (.095)	1 1/4"	5864-15-1613-00	\$80.67	N/A	
		1 1/2"	5864-16-1613-00	\$130.00	5764-16-1613-00	\$130.23
		2"	5864-17-1613-00	\$74.96	5764-17-1613-00†	\$78.99
		3"	5864-19-1613-00	\$86.39	5764-19-1613-00†	\$93.28
		4"	5864-21-1613-00	\$100.39	5764-21-1613-00†	\$101.67
		6"	5864-24-1613-00	\$115.13	5764-24-1613-00†	\$114.70
1" IPS	SDR-11 (.119)	1 1/4"	5864-15-1614-00	\$85.57	N/A	
		1 1/2"	5864-16-1614-00	\$134.97	5764-16-1614-00	\$131.12
		2"	5864-17-1614-00	\$79.93	5764-17-1614-00†	\$83.97
		3"	5864-19-1614-00	\$91.39	5764-19-1614-00†	\$98.16
		4"	5864-21-1614-00	\$105.37	5764-21-1614-00†	\$106.66
		6"	5864-24-1614-00	\$120.02	5764-24-1614-00†	\$119.59
8"	N/A		5764-26-1614-00	\$221.32		

CON STAB ID SEAL® HVT ELIMINATOR



CON-STAB ID SEAL® HVT ELIMINATORS				
OUTLET (PE SIZE)	WALL	MAIN SIZE	PART NUMBER	LIST PRICE
1 1/4" IPS	SDR-10 (.166)	2"	5664-17-1615-00	\$290.87
		3"	5664-19-1615-00	\$309.13
		4"	5664-21-1615-00	\$309.13
		6"	5664-24-1615-00	\$328.52
	SDR-11 (.151)	2"	5664-17-1615-0A	\$290.87
		3"	5664-19-1615-0A	\$309.13
		4"	5664-21-1615-0A	\$309.13
		6"	5664-24-1615-0A	\$328.52
2" IPS	SDR-11 (.216)	2"	5664-17-1617-00	\$296.74
		3"	5664-19-1617-00	\$316.44
		4"	5664-21-1617-00	\$316.44
		6"	5664-24-1617-00	\$336.59

• For sizes not listed, contact Continental Industries.



33-4363-00
1/2" Square Drive Key, Bushing and
Socket Adapter
page 11



Gas Connectors & Accessories

PA COMPRESSION ELIMINATORS

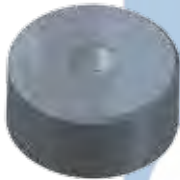

33-5508-00 ~ Test Plug Cap for Eliminator Saddles
page 11



33-5505-00 ~ Combination Tapping Tool & Saddle Bolt "T"
Wrench for 1 1/4" thru 6" IPS Con-Stab ID
Seal® Eliminators page 11

33-5505-01 ~ Combination Tapping Tool & Saddle Bolt "T"
Wrench for 3" thru 8" IPS Con-Stab ID
Seal® Eliminators page 11

PA ELIMINATORS W/ COMPRESSION OUTLETS							
OUTLET (PE SIZE)	WALL	MAIN SIZE	PART NUMBER 5864 1/2" CR PUNCH	LIST PRICE	PART NUMBER 5764 13/16" CR PUNCH	LIST PRICE	
1/2" CTS (5/8" OD)	.090	1 1/4"	5864-15-1004-00	\$77.27	N/A		
		1 1/2"	5864-16-1004-00	\$139.60	N/A		
		2"	5864-17-1004-00	\$68.37	5764-17-1004-00	\$77.81	
		3"	5864-19-1004-00	\$84.19	5764-19-1004-00	\$95.09	
		4"	5864-21-1004-00	\$104.95	5764-21-1004-00	\$106.66	
		6"	5864-24-1004-00	\$109.17	5764-24-1004-00	\$120.96	
	.062	8"	N/A			5764-26-1004-00	\$204.58
		1 1/4"	5864-15-1004-0A	\$77.27	N/A		
		2"	5864-17-1004-0A	\$68.37	5764-17-1004-0A	\$77.81	
		3"	5864-19-1004-0A	\$84.19	5764-19-1004-0A	\$95.09	
		4"	5864-21-1004-0A	\$104.95	5764-21-1004-0A	\$106.66	
		6"	5864-24-1004-0A	\$109.17	5764-24-1004-0A	\$120.96	
1" CTS (1 1/8" OD)	.099/.101	8"	N/A		5764-26-1004-0A	\$204.58	
		1 1/4"	5864-15-1008-00	\$84.72	N/A		
		2"	5864-17-1008-00	\$75.49	5764-17-1008-00	\$82.17	
		3"	5864-19-1008-00	\$90.85	5764-19-1008-00	\$99.35	
		4"	5864-21-1008-00	\$107.80	5764-21-1008-00	\$109.52	
		6"	5864-24-1008-00	\$125.73	5764-24-1008-00	\$124.99	
	.090	8"	N/A			5764-26-1008-00	\$216.03
		1 1/4"	5864-15-1008-0A	\$83.64	N/A		
		2"	5864-17-1008-0A	\$75.49	5764-17-1008-0A	\$82.17	
		3"	5864-19-1008-0A	\$90.85	5764-19-1008-0A	\$99.35	
		4"	5864-21-1008-0A	\$107.80	5764-21-1008-0A	\$109.52	
		6"	5864-24-1008-0A	\$125.73	5764-24-1008-0A	\$124.99	
3/4" IPS	SDR-11 (.095)	8"	N/A		5764-26-1008-0A	\$216.03	
		1 1/4"	5864-15-1013-00	\$90.64	N/A		
		1 1/2"	5864-16-1013-00	\$146.94	5764-16-1013-00	\$146.94	
		2"	5864-17-1013-00	\$75.49	5764-17-1013-00	\$82.17	
		3"	5864-19-1013-00	\$90.85	5764-19-1013-00	\$99.35	
		4"	5864-21-1013-00	\$107.80	5764-21-1013-00	\$109.52	
		6"	5864-24-1013-00	\$125.73	5764-24-1013-00	\$124.99	
1" IPS	SDR-11 (.119)	8"	N/A		5764-26-1013-00	\$217.18	
		1 1/4"	5864-15-1014-00	\$100.18	N/A		
		1 1/2"	5864-16-1014-00	\$154.50	5764-16-1014-00	\$154.50	
		2"	5864-17-1014-00	\$91.68	5764-17-1014-00	\$101.13	
		3"	5864-19-1014-00	\$139.72	5764-19-1014-00	\$153.09	
		4"	5864-21-1014-00	\$128.17	5764-21-1014-00	\$137.27	
		6"	5864-24-1014-00	\$177.68	5764-24-1014-00	\$187.43	
8"	N/A			5764-26-1014-00	\$221.32		

• For sizes not listed, contact Continental Industries.

PA HVT COMPRESSION ELIMINATORS



Gas Connectors & Accessories



PA HVT ELIMINATORS W/ COMPRESSION OUTLETS

OUTLET (PE SIZE)	WALL	MAIN SIZE	PART NUMBER 1 1/2" CR PUNCH	LIST PRICE
1 1/4" IPS	SDR-10 (.166)	2"	5664-17-1015-00	\$290.87
		3"	5664-19-1015-00	\$309.13
		4"	5664-21-1015-00	\$309.13
		6"	5664-24-1015-00	\$328.52
	SDR-11 (.151)	2"	5664-17-1015-0A	\$290.87
		3"	5664-19-1015-0A	\$309.13
		4"	5664-21-1015-0A	\$309.13
		6"	5664-24-1015-0A	\$328.52
2" IPS	SDR-11 (.216)	2"	5664-17-1017-00	\$296.74
		3"	5664-19-1017-00	\$316.44
		4"	5664-21-1017-00	\$316.44
		6"	5664-24-1017-00	\$336.59

• For sizes not listed, contact Continental Industries.



33-4363-00
1/2" Square Drive Key, Bushing and
Socket Adapter
page 11



Gas Connectors & Accessories

TRANSITION FITTINGS

STEEL TO POLYETHYLENE (PE) TRANSITION FITTINGS

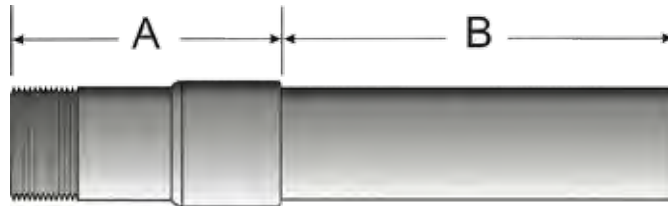

THREADED TRANSITION FITTINGS

SIZE STEEL X PE	PE TYPE	STEEL LENGTH "A"	PE LENGTH "B"	MIN. ORDER QTY	THD TRAN PRODUCT CODE	NOTES	LIST PRICE
3/4 NPT X 3/4 IPS DR11	PE2406/PE2708	5"	12"	6	101051050800	††	\$28.83
1 NPT X 1 IPS DR11	PE2406/PE2708	5"	12"	3	101321320800	††	\$33.37
1 1/4 NPT X 1 1/4 IPS DR10	PE2406/PE2708	5 1/2"	12"	2	101661660700	††	\$42.60
1 1/2 NPT X 1 1/2 IPS DR11	PE2406/PE2708	5 1/2"	12"	2	101901900800	‡	\$48.70
2 NPT X 2 IPS DR11	PE2406/PE2708	5 3/4"	12"	2	102382380800	††	\$59.52

† = CSA Approved / ‡ = IAPMO/UPC Listed

Recommended accessories: socket fusion couplings, wire lugs, protector sleeves

Notes:

- A Fusion Bonded Epoxy (FBE) coating is applied to the external surface on all sizes up to 8 IPS
- An internal epoxy coating is available upon request on sizes under 4".

In addition to threaded transition fittings, Lyall offers several other types of transition connections. Please contact us for pricing and technical information on the following configurations:



Beveled for Welding



Victaulic Groove



Flanged

TRANSITION FITTINGS



Gas Connectors & Accessories

CON STAB ID SEAL® STEEL TRANSITION FITTINGS



CON-STAB ID SEAL® STEEL TRANSITION FITTINGS						
OUTLET (PE SIZE)	WALL	INLET	PART NUMBER 2406 MDPE	LIST PRICE	PART NUMBER 3408/4710 HDPE	LIST PRICE
1/2" CTS (5/8" OD)	.090	1/2" MPT	4646-00-1904-25	\$45.08	4949-00-1904-25	\$46.26
1" CTS (1 1/8" OD)	.099/.101	1" MPT	4646-00-1908-25	\$54.19	4949-00-1908-25	\$55.24
1/2" IPS	SDR-9.33 (.090)	3/4" MPT	4646-00-1912-25	\$79.04	4949-00-1912-25	\$51.00
3/4" IPS	SDR-11 (.095)	3/4" MPT	4646-00-1913-25	\$44.38	4949-00-1913-25	\$45.25
1" IPS	SDR-11 (.119)	1" MPT	4646-00-1914-25	\$60.88	4949-00-1914-25	\$62.08
1 1/4" IPS	SDR-10 (.166)	1 1/4" MPT	4646-00-1915-25	\$103.09	4949-00-1915-25	\$105.10
1 1/4" IPS	SDR-11 (.151)	1 1/4" MPT	9946-00-0058-25	\$139.69	9949-00-0001-25	\$136.42
1 1/2" IPS	SDR-11 (.171)	1 1/2" MPT	4646-00-1916-25	\$146.97	4949-00-1916-25	\$149.73
2" IPS	SDR-11 (.166)	2" MPT	4646-00-1917-25	\$142.16	4949-00-1917-25	\$138.03

• For sizes not listed, contact Continental Industries.



TRANSITION FITTINGS						
OUTLET (PE SIZE)	WALL	INLET	PART NUMBER 2406 MDPE	LIST PRICE	PART NUMBER 3408/4710 HDPE	LIST PRICE
1/2" CTS (5/8" OD)	.090	1/2" MPT	4646-00-1904-00	\$28.48	4949-00-1904-00	\$32.85
1" CTS (1 1/8" OD)	.099/.101	1" MPT	4646-00-1908-00	\$34.40	4949-00-1908-00	\$25.19
1/2" IPS	SDR-9.33 (.090)	3/4" MPT	4646-00-1912-00	\$41.75	4949-00-1912-00	\$43.82
3/4" IPS	SDR-11 (.095)	3/4" MPT	4646-00-1913-00	\$20.95	4949-00-1913-00	\$20.96
1" IPS	SDR-11 (.119)	1" MPT	4646-00-1914-00	\$25.72	4949-00-1914-00	\$27.26
1 1/4" IPS	SDR-10 (.166)	1 1/4" MPT	4646-00-1915-00	\$37.79	4949-00-1915-00	\$41.06
1 1/4" IPS	SDR-11 (.151)	1 1/4" MPT	4646-00-1915-0A	\$48.11	4949-00-1915-0A	\$44.84
1 1/2" IPS	SDR-11 (.171)	1 1/2" MPT	4646-00-1916-00	\$49.25	4949-00-1916-00	\$51.99
2" IPS	SDR-11 (.166)	2" MPT	4646-00-1917-00	\$56.29	4949-00-1917-00	\$59.73

• For sizes not listed, contact Continental Industries.



Gas Connectors & Accessories

TRANSITION FITTINGS

CON STAB ID SEAL® BRASS TRANSITION FITTINGS



CON-STAB ID SEAL® BRASS TRANSITION FITTINGS				
OUTLET (PE SIZE)	WALL	INLET	PART NUMBER (3408/4710)	LIST PRICE
1/2" CTS (5/8" OD)	.090	1/2" MPT	9932-00-0002-00	\$71.19
		1/2" FPT	9932-00-0019-00	\$95.62
1" CTS (1 1/8" OD)	.099/.101	3/4" MPT	9932-00-0008-00	\$88.26
		3/4" FPT	9932-00-0025-00	\$90.74
	.090	3/4" MPT	9932-00-0007-00	\$88.26
		3/4" FPT	9932-00-0024-00	\$90.74
3/4" IPS	SDR-11 (.095)	3/4" MPT	9932-00-0015-00	\$83.07
		3/4" FPT	9932-00-0032-00	\$85.52

• For sizes not listed, contact Continental Industries.

STEEL TRANSITION FITTINGS



CON-STAB ID SEAL® STEEL TRANSITION FITTINGS				
OUTLET (PE SIZE)	WALL	INLET	PART NUMBER (3408/4710) HDPE	LIST PRICE
1/2" CTS (5/8" OD)	.090	1/2" MPT	0432-00-0912-00	\$68.53
		1/2" FPT	0432-00-1512-00	\$70.10
		3/4" MPT	0432-00-0913-00	\$68.53
		3/4" FPT	0432-00-1513-00	\$70.10
		3/4" BUTT WELD	0432-00-0613-00	\$75.87
1" CTS (1 1/8" OD)	.099/.101	3/4" MPT	0832-00-0913-00	\$72.56
		3/4" FPT	0832-00-1513-00	\$74.34
		1" MPT	0832-00-0914-00	\$75.28
		1" FPT	0832-00-1514-00	\$77.64
	.090	3/4" BUTT WELD	0832-00-0613-00	\$80.23
		3/4" MPT	0832-00-0913-A0	\$72.56
		3/4" FPT	0832-00-1513-A0	\$74.34
1/2" IPS	SDR-9.33 (.090)	1" MPT	0832-00-0914-A0	\$75.28
		1" FPT	0832-00-1514-A0	\$77.64
		3/4" BUTT WELD	0832-00-0613-A0	\$80.23
		3/4" MPT	0832-00-0913-00	\$88.73
3/4" IPS	SDR-11 (.095)	1/2" MPT	1232-00-0912-00	\$88.73
		1/2" FPT	1232-00-1512-00	\$90.98
		3/4" MPT	1232-00-0913-00	\$88.73
		3/4" FPT	1232-00-1513-00	\$90.98
		3/4" MPT	1332-00-0913-00	\$95.98
3/4" FPT	1332-00-1513-00	\$72.81		
1" MPT	1332-00-0914-00	\$97.62		
1" FPT	1332-00-1514-00	\$75.87		
3/4" BUTT WELD	1332-00-0613-00	\$78.46		

• For sizes not listed, contact Continental Industries.

SERVICE RISERS



ANODELESS SERVICE RISERS

The positive transition joint between the polyethylene (PE) pipe and the gas carrying steel pipe is made above ground and does not require cathodic (anode) protection.

RIGID ANODELESS RISERS

Pre-bent anodeless meter risers have a wide range of different designs and dimensions. While the most common connection is male pipe threads at the meter set connection, other styles such as flanges, beveled end for welding and bypass nipples are also available. For protection, these riser casings are coated with an electrostatically applied thin film epoxy coating. Standard configurations include various vertical and horizontal dimensions.

FLEXIBLE ANODELESS RISERS

Flexible anodeless service risers offer many of the features of the pre-bent design with an added feature utilizing gas tubing armour flexible metal hose. The flexible tubing is attached to the steel portion of the riser with a transition that is stronger in tensile than the flex tubing itself. Flexible Risers are ideal for variable ground level depths and eliminates the need for purchasing risers with various vertical lengths.



FLEXIBLE SERVICE HEAD ADAPTER RISERS

Flexible service head adapter risers offer many of the features that the pre-bent service head adapter riser offer, with an added feature utilizing gas tubing armour flexible hose. The flexible hose is attached to the steel portion of the riser with a transition that is stronger in tensile than the flex hose itself. Using flexible hose provides the user with a design that permits variable ground level depths and eliminates the need for purchasing risers with various vertical lengths.



TRANSITION (ANODE) SERVICE RISERS

The positive transition joint between the polyethylene (PE) pipe and gas carrying steel casing is made below ground. Field installation of an anode is recommended.

TRANSITION (ANODE) RISERS

Lyall Transition Risers are manufactured using schedule 40 steel pipe with a transition fitting as an integral part of riser. Each riser has an external thin film epoxy coating to protect against corrosion.



COMPRESSION (ANODE) RISERS

Lyall Compression Risers are manufactured using schedule 40 steel pipe welded to a compression fitting with a built in stiffener and gasket. Compression risers can be installed with conventional and tools eliminating the need for fusion equipment.





Gas Connectors & Accessories

ANODELESS SERVICE RISERS

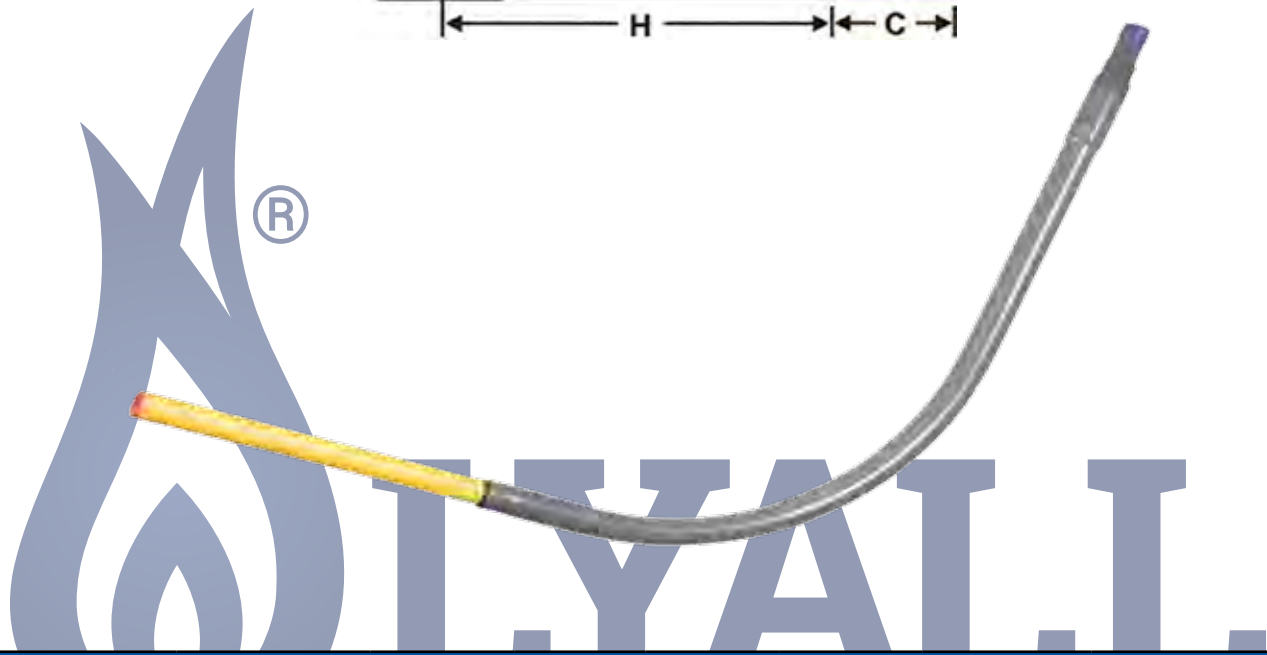
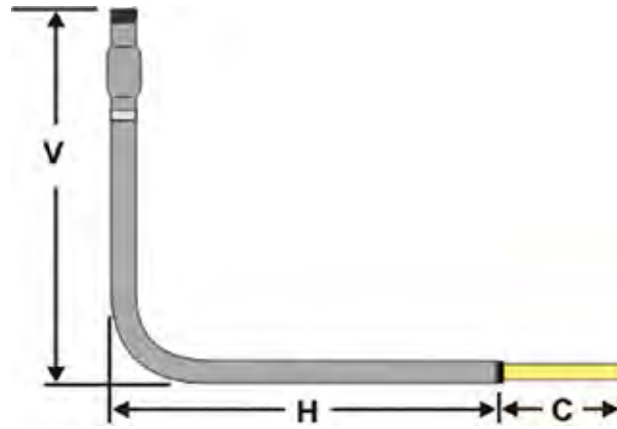

LYALL ANODELESS SERVICE RISER

SIZE STEEL X PE	PE TYPE	VERTICAL LENGTH "V"	HORIZONTAL LENGTH "H"	PE LENGTH "C"	BUNDLE/MIN. ORDER QTY.	PART NUMBER	NOTES	LIST PRICE
3/4 NPT X 1/2 CTS .090	PE2406/PE2708	30"	16"	10"	12	241050630130	†‡	\$45.11
3/4 NPT X 3/4 IPS DR11	PE2406/PE2708	30"	16"	10"	9	241051050830	†‡	\$54.53
1 NPT X 1 IPS DR11	PE2406/PE2708	30"	16"	10"	6	241321320830	†‡	\$63.12
1 1/4 NPT X 1 1/4 IPS DR10	PE2406/PE2708	30"	22"	10"	4	241661660760	†‡	\$103.12
1 1/2 NPT X 1 1/2 IPS DR11	PE2406/PE2708	30"	32"	10"	4	241901900830	‡	\$165.21
2 NPT X 2 IPS DR11	PE2406/PE2708	30"	30"	10"	2	242382380840	†‡	\$206.84

For sizes or PE Type not listed, please contact Lyall Customer Service.

† = CSA Approved / ‡ = IAPMO/UPC Listed

RISERS MUST BE ORDERED IN MULTIPLES OF BUNDLE QUANTITY LISTED

ANODELESS SERVICE RISERS



Gas Connectors & Accessories

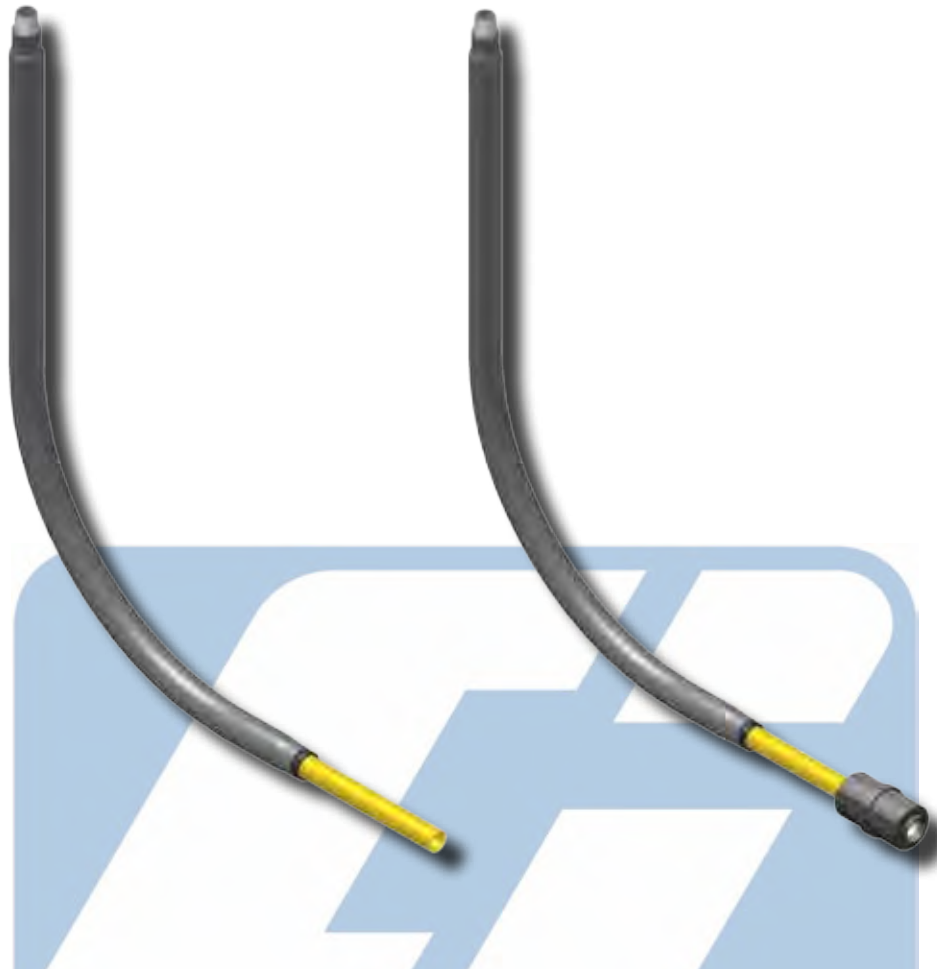

CONTINENTAL INDUSTRIES ANODELESS METER RISER

SIZE (MPT X PE)	WALL	VERTICAL LENGTH	HORIZONTAL LENGTH	PART NUMBER	LIST PRICE	PART NUMBER with Con-Stab	LIST PRICE
1/2" MPT X 1/2" CTS (5/8" OD) PE	0.090	30"	15"	1253-91-4604-00	\$46.57	1253-91-4604-25	\$65.50
3/4" MPT X 1/2" CTS (5/8" OD) PE	0.090	18"	19"	9953-99-0520-00	\$47.96	9953-99-0521-00	\$64.77
3/4" MPT X 1/2" CTS (5/8" OD) PE	0.090	30"	17"	1353-91-4604-00	\$36.44	1353-91-4604-25	\$53.25
3/4" MPT X 1/2" IPS PE	SDR-9.3 (.090)	30"	17"	1353-91-4612-00	\$38.65	1353-91-4612-25	\$69.15
3/4" MPT X 3/4" IPS PE	SDR-11 (.095)	30"	16"	1353-91-4613-00	\$53.45	1353-91-4613-25	\$85.75
3/4" MPT X 1" CTS (1 1/8" OD) PE	099/.101	30"	16"	1353-91-4608-00	\$59.05	1353-91-4608-25	\$87.40
1" MPT X 1" IPS PE	SDR-11 (.119)	30"	16"	1453-91-4614-00	\$61.32	1453-91-4614-25	\$96.23
1 1/4" MPT X 1 1/4" IPS PE	SDR-10 (.166)	30"	22"	1553-91-4615-00	\$105.32	1553-91-4615-25	\$213.32
1 1/4" MPT X 1 1/4" IPS PE	SDR-11 (.151)	30"	22"	1553-91-4615-0A	\$105.33	9953-99-0503-25	\$213.33
1 1/2" MPT X 1 1/2" IPS PE	SDR-11 (.173)	36"	26"	1652-91-4616-00	\$148.59	1652-91-4616-25	\$243.13
2" MPT X 2" IPS PE	SDR-11 (.216)	36"	30"	1752-91-4617-00	\$192.96	1752-91-4617-25	\$320.72

• For sizes not listed, contact Continental Industries.



FLEXIBLE SERVICE HEAD ADAPTER RISERS

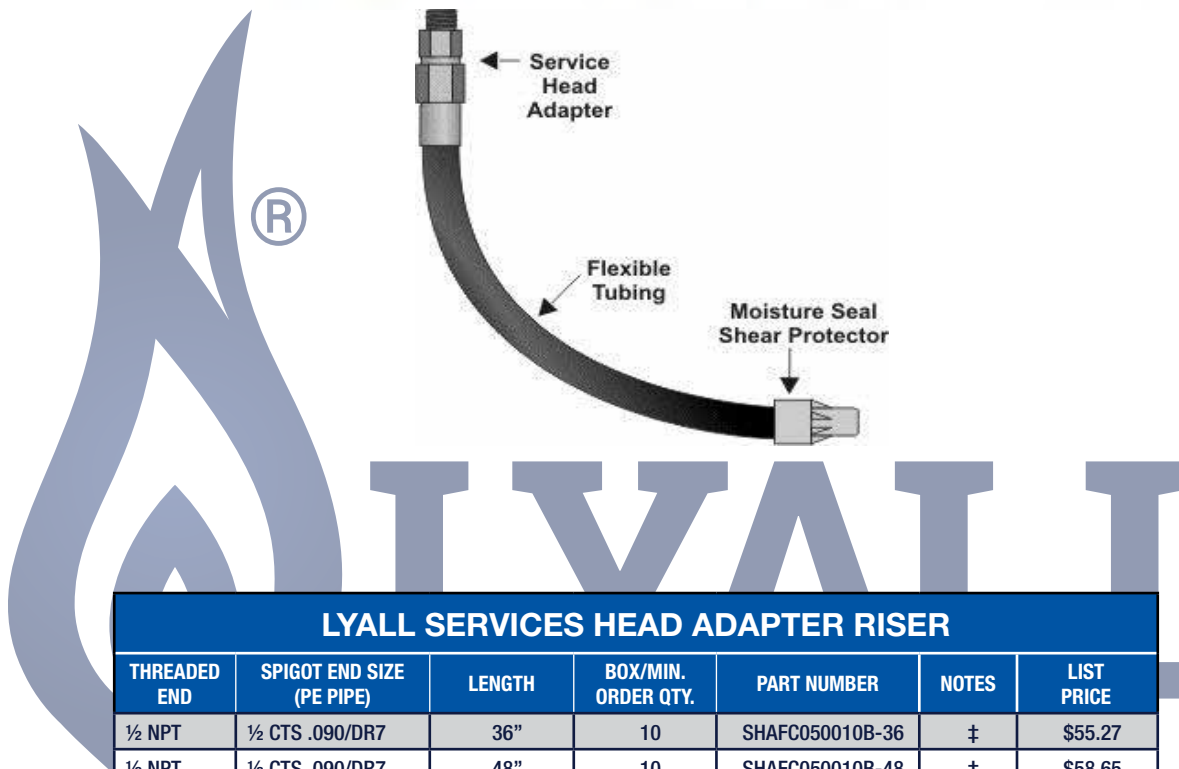

LYALL SERVICES HEAD ADAPTER RISER						
THREADED END	SPIGOT END SIZE (PE PIPE)	LENGTH	BOX/MIN. ORDER QTY.	PART NUMBER	NOTES	LIST PRICE
½ NPT	½ CTS .090/DR7	36"	10	SH AFC050010B-36	‡	\$55.27
½ NPT	½ CTS .090/DR7	48"	10	SH AFC050010B-48	‡	\$58.65
½ NPT	½ CTS .090/DR7	84"	10	SH AFC050010B-84	‡	\$62.87
½ NPT	½ IPS DR9.3	36"	10	SH AFC050050W-36	‡	\$96.82
½ NPT	½ IPS DR9.3	48"	10	SH AFC050050W-48	‡	\$103.62
½ NPT	½ IPS DR9.3	84"	10	SH AFC050050W-84	‡	\$110.44
¾ NPT	½ CTS .090/DR7	36"	10	SH AFC060010B-36	†‡	\$54.45
¾ NPT	½ CTS .090/DR7	48"	10	SH AFC060010B-48	†‡	\$57.87
¾ NPT	½ CTS .090/DR7	84"	10	SH AFC060010B-84	†‡	\$62.40
¾ NPT	¾ IPS DR11	36"	10	SH AFC060060Y-36	‡	\$100.70
¾ NPT	¾ IPS DR11	48"	10	SH AFC060060Y-48	‡	\$108.99
¾ NPT	¾ IPS DR11	84"	10	SH AFC060060Y-84	‡	\$122.62

† = CSA Approved / ‡ = IAPMO/UPC Listed

Recommended accessories: riser brackets, stakes, anodes

RISERS MUST BE ORDERED IN MULTIPLES OF BUNDLE OR BOX QUANTITY LISTED

CONFLEX RISERS



Gas Connectors & Accessories

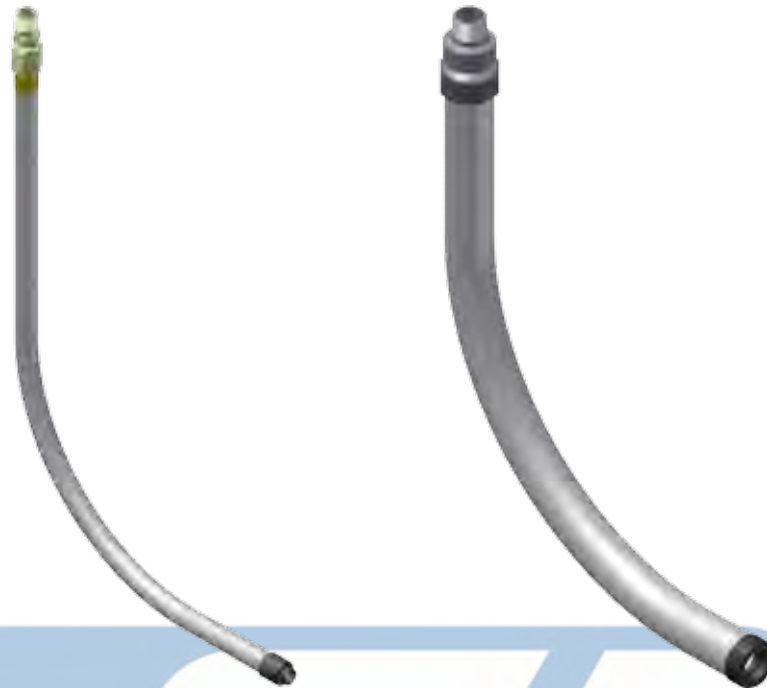

CONTINENTAL INDUSTRIES CONFLEX RISERS

SIZE (MPT X PE)	WALL	LENGTH	PART NUMBER	LIST PRICE
1/2" MPT X 1/2" CTS (5/8" OD) PE	.090	36"	1253-92-1004-36	\$33.71
		48"	1253-92-1004-48	\$36.14
		60"	1253-92-1004-60	\$38.54
		72"	1253-92-1004-72	\$39.22
		84"	1253-92-1004-84	\$50.06
		96"	1253-92-1004-96	\$47.68
3/4" MPT X 1/2" CTS (5/8" OD) PE	.090	36"	1353-92-1004-36	\$31.65
		48"	1353-92-1004-48	\$34.06
		60"	1353-92-1004-60	\$36.45
		72"	1353-92-1004-72	\$37.00
		84"	1353-92-1004-84	\$45.63
		96"	1353-92-1004-96	\$46.31
3/4" MPT X 3/4" IPS PE	SDR-11 (.095)	36"	1353-92-1013-36	\$51.09
		48"	1353-92-1013-48	\$55.92
		60"	1353-92-1013-60	\$60.71
		72"	1353-92-1013-72	\$63.95
		84"	1353-92-1013-84	\$73.54
		96"	1353-92-1013-96	\$79.85
1" MPT X 1" CTS (1 1/8" OD) PE	.099/.101	36"	1453-92-1008-36	\$73.06
		60"	1453-92-1008-60	\$77.10
		72"	1453-92-1008-72	\$86.23
		84"	1453-92-1008-84	\$91.99
		96"	1453-92-1008-96	\$95.77
1" MPT X 1" IPS PE	SDR-11 (.119)	36"	1453-92-1014-36	\$98.75
		60"	1453-92-1014-60	\$133.74
1 1/4" MPT X 1 1/4" IPS PE	SDR-10 (.116)	36"	1553-96-1015-36	\$153.66
	SDR-11 (.151)	36"	9953-99-0445-00	\$139.34
1 1/2" MPT X 1 1/2" IPS PE	SDR-11 (.173)	36"	1653-96-1016-36	\$209.39
2" MPT X 2" IPS PE	SDR-11 (.216)	36"	1753-96-1017-36	\$212.23

• For sizes not listed, contact Continental Industries.



Gas Connectors & Accessories

COMPRESSION (ANODE) RISERS

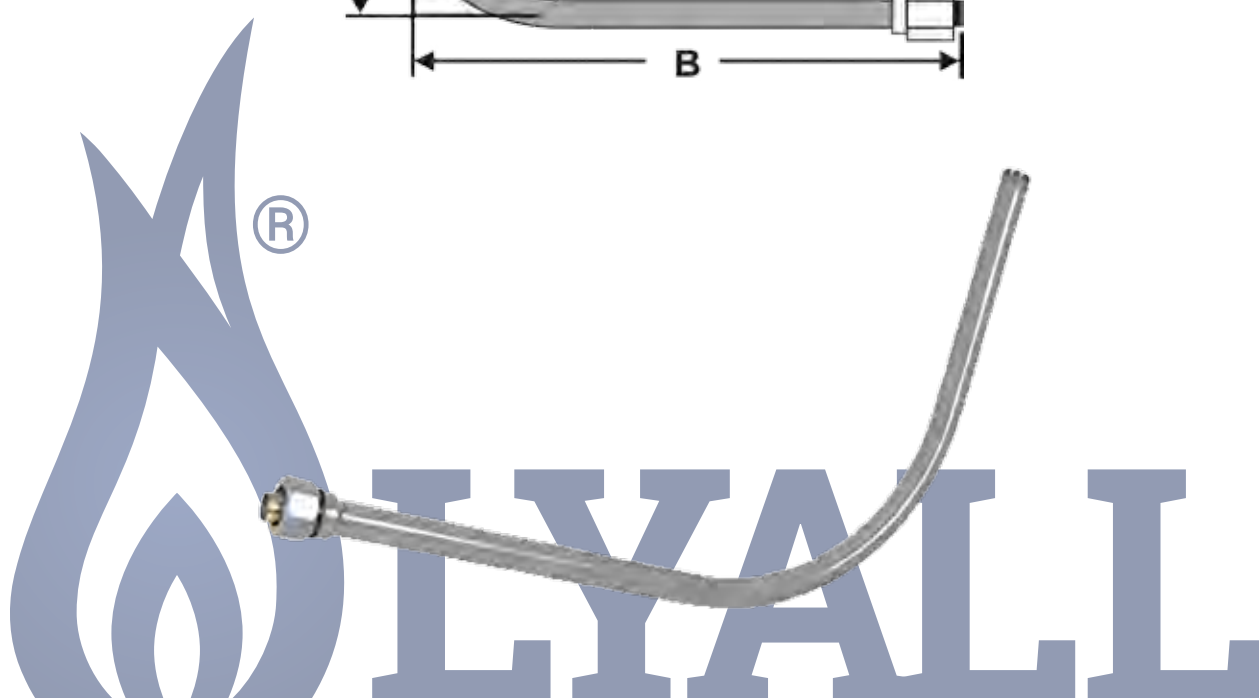
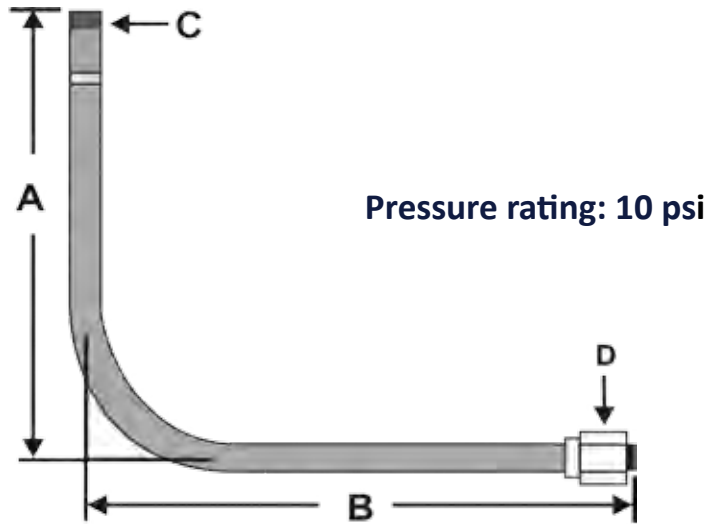

LYALL COMPRESSION (ANODE) RISERS							
THREAD END "C"	COMPRESSION END "D"	VERTICAL LENGTH "A"	HORIZONTAL LENGTH "B"	BUNDLE/MIN. ORDER QTY.	PART NUMBER	NOTES	LIST PRICE
3/4 NPT	3/4 IPS DR11	30"	30"	12	221051050830	‡	\$71.22
1 NPT	1 IPS DR11	30"	30"	6	221321320830	‡	\$79.07
1 1/4 NPT	1 1/4 IPS DR10	30"	30"	6	221661660730	‡	\$103.08
1 1/2 NPT	1 1/2 IPS DR11	30"	30"	4	221901900830	‡	\$147.40
2 NPT	2 IPS DR11	30"	30"	2	222382380830	‡	\$195.27

‡ = IAPMO/UPC Listed

Recommended accessories: riser brackets, stakes, anodes

RISERS MUST BE ORDERED IN MULTIPLES OF BUNDLE OR BOX QUANTITY LISTED

TRANSITION (ANODE) RISERS



Gas Connectors & Accessories

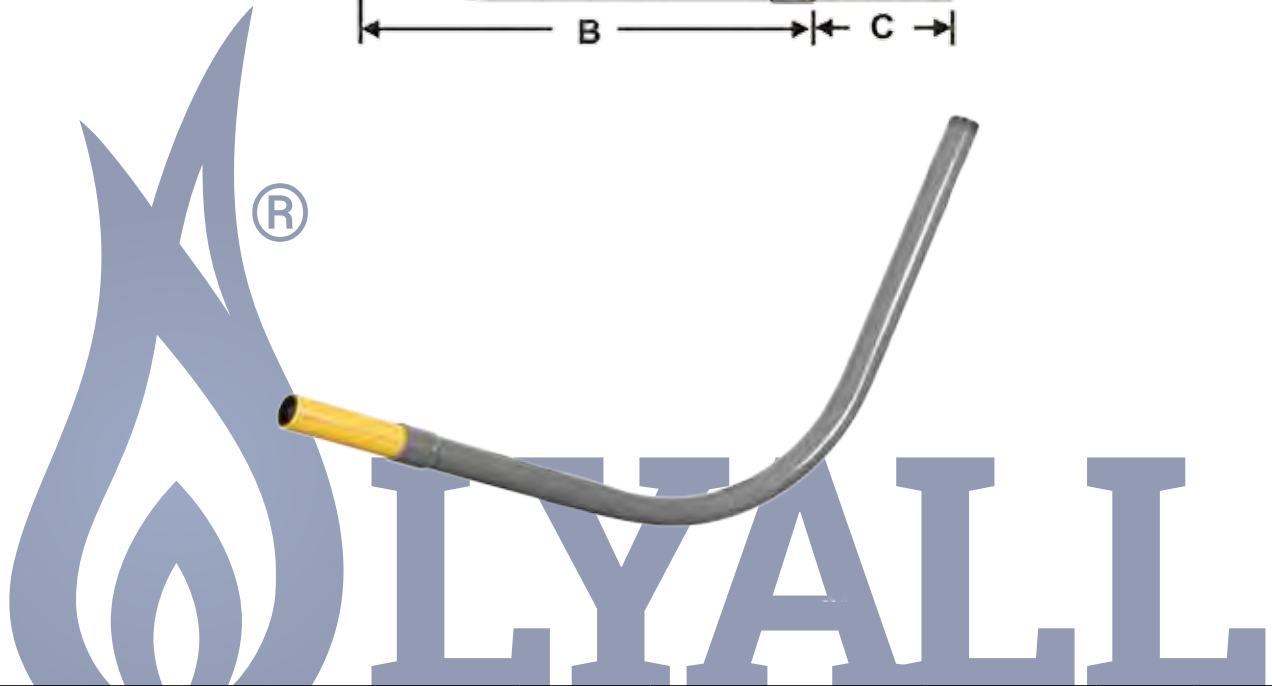
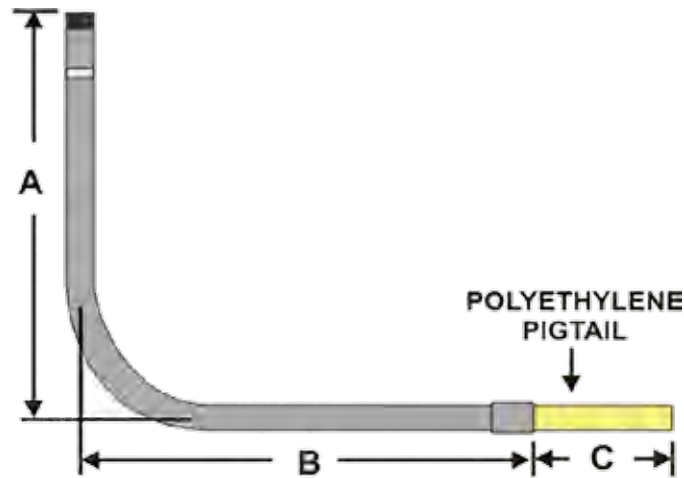

LYALL TRANSITION (ANODE) RISERS

SIZE STEEL X PE	PE TYPE	VERTICAL LENGTH "A"	HORIZONTAL LENGTH "B"	PE LENGTH "C"	BUNDLE/MIN. ORDER QTY.	PART NUMBER	NOTES	LIST PRICE
¾ NPT X ¾ IPS DR11	PE2406/PE2708	30"	30"	6"	9	201051050830	‡	\$52.43
1 NPT X 1 IPS DR11	PE2406/PE2708	30"	30"	6"	6	201321320830	‡	\$69.86
1 ¼ NPT X 1 ¼ IPS DR10	PE2406/PE2708	30"	30"	6"	4	201661660730	‡	\$80.08
1 ½ NPT X 1 ½ IPS DR11	PE2406/PE2708	30"	30"	6"	4	201901900830	‡	\$93.13
2 NPT X 2 IPS DR11	PE2406/PE2708	30"	30"	6"	2	202382380830	‡	\$121.46

‡ = IAPMO/UPC Listed

Recommended accessories: riser brackets, stakes, anodes

RISERS MUST BE ORDERED IN MULTIPLES OF BUNDLE OR BOX QUANTITY LISTED



Gas Connectors & Accessories

BRACKETS & SUPPORT STAKES



Riser Wall Bracket



Offset Adjustable Riser Wall Bracket



Adjustable Riser Wall Bracket



Riser Support Stake



Y A

BRACKETS & SUPPORT STAKES				
PRODUCT DESCRIPTION	PRODUCT SUPPORT	BUNDLE/MIN. ORDER QTY.	PART NUMBER	LIST PRICE
Wall Bracket - 9"	Riser	10	BRK9H	\$44.38
Offset Adjustable Wall Bracket - 14"	Riser	10	BRK38-01	\$43.29
Support Stake - 48"	Riser	20	BRK32	\$43.73

RISER BRACKETS



Gas Connectors & Accessories



17-6133-00
6" Stand-Off
(List Price \$37.19)

- (2) 3/8" wide x 2" long angular mounting slots
- Accommodates 1/2" thru 1 1/4" flex risers
- Powder coated finish
- Mounting hardware included



17-6134-00
9" Stand-Off
(List Price \$38.76)

- (2) 3/8" wide x 2" long angular mounting slots
- Accommodates 1/2" thru 1 1/4" flex risers
- Powder coated finish
- Mounting hardware included



17-6134-01
9" Stand-Off
(List Price \$38.76)

- Accommodates 1/2" thru 1 1/4" flex risers
- Powder coated finish
- Mounting hardware included



17-6135-00
Universal Riser Bracket
(List Price \$60.26)

- Can be used for virtually any mounting situation
- Foundation, single or double remote installations
- Accommodates 1/2" thru 2" risers
- Carriage bolts supplied for ease of assembly
- Powder coated finish
- Foundation mounting hardware included
- (2) 3/8 wide x 1-5/8 straight mounting slots (Drivepost shown sold separately)





Gas Connectors & Accessories

POLYTEC BALL VALVES

BALL VALVES - MEDIUM DENSITY PE 2406/2708



BALL VALVES - MEDIUM DENSITY PE 2406/2708					
PE Pipe Size	Wall Thickness	Port	Box Qty.	Product Code	List Price
½	.090	Full	5	BV0010B-TFNO-000	\$61.07
1 CTS	.099-.102	Full	5	BV0030D-TFNO-000	\$61.07
1 ¼	.090	Standard	5	BV0040B-TSNO-000	\$61.07
½ IPS	DR9.3	Full	5	BV0050W-TFNO-000	\$64.39
¾ IPS	DR11	Full	5	BV0060Y-TFNO-000	\$64.39
1 IPS	DR11	Full	5	BV0070Y-TFNO-000	\$64.39
1 ¼	DR10	Standard	5	BV0080X-TSNO-000	\$64.39
1 ¼	DR11	Standard	5	BV0080Y-TSNO-000	\$64.39
1 ½	DR11	Standard	5	BV0090Y-TSNO-000	\$64.39
2 IPS	DR11	Standard	1	BV0200Y-TSNO-000	\$83.94
2 IPS	DR11	Full	1	BV0200Y-TFNO-000	\$136.01
3 IPS	DR11	Full	1	BV0300Y-TFNO-000	\$174.57
4 IPS	DR11	Standard	1	BV0400Y-TSNO-000	\$444.81
4 IPS	DR11	Full	1	BV0400Y-TFNO-000	\$502.04
6 IPS	DR11	Standard	1	BV0600Y-TSNO-000	\$552.69
6 IPS	DR11	Full	1	BV0600Y-TFNO-000	\$1,073.52
8 IPS	DR11	Full	1	BV0800Y-TFNO-000	\$1,257.25
10 IPS	DR11	Full	1	BV1000Y-TFNO-000	\$2,294.60
12 IPS	DR11	Standard	1	BV1200Y-TSNO-000	\$7,000.96
12 IPS	DR11	Full	1	BV1200Y-TFNO-000	Call for Pricing
14 IPS	DR11	Full	1	BV1400Y-TFNO-000	Call for Pricing
16 IPS	DR11	Full	1	BV1600Y-TFNO-000	Call for Pricing

BALL VALVES MUST BE ORDERED IN MULTIPLES OF BUNDLE OR BOX QUANTITY LISTED

POLYTEC BALL VALVES



Gas Connectors & Accessories

BALL VALVES - HIGH DENSITY PE 3408/4710



BALL VALVES - HIGH DENSITY PE 3408/4710

PE Pipe Size	Wall Thickness	Port	Box Qty.	Product Code	List Price
1/2	.090	Full	5	BV0010B-MFN0-000	\$61.07
1 CTS	.099-.102	Full	5	BV0030D-MFN0-000	\$61.07
3/4 IPS	DR11	Full	5	BV0060Y-MFN0-000	\$64.39
1 IPS	DR11	Full	5	BV0070Y-MFN0-000	\$64.39
1 1/4	DR11	Standard	5	BV0080Y-MSN0-000	\$64.39
1 1/2	DR11	Standard	5	BV0090Y-MSN0-000	\$83.94
2 IPS	DR11	Standard	1	BV0200Y-MSN0-000	\$136.01
2 IPS	DR11	Full	1	BV0200Y-MFN0-000	\$174.57
3 IPS	DR11	Full	1	BV0300Y-MFN0-000	\$444.89
4 IPS	DR11	Standard	1	BV0400Y-MSN0-000	\$552.69
4 IPS	DR11	Full	1	BV0400Y-MFN0-000	\$502.04
6 IPS	DR11	Standard	1	BV0600Y-MSN0-000	\$1,073.52
6 IPS	DR11	Full	1	BV0600Y-MFN0-000	\$1,257.25
8 IPS	DR11	Full	1	BV0800Y-MFN0-000	\$2,294.60
10 IPS	DR11	Full	1	BV1000Y-MFN0-000	\$7,000.96
12 IPS	DR11	Standard	1	BV1200Y-MSN0-000	\$9,294.83
12 IPS	DR11	Full	1	BV1200Y-MFN0-000	\$16,334.15
14 IPS	DR11	Full	1	BV1400Y-MFN0-000	Call for Pricing
16 IPS	DR11	Full	1	BV1600Y-MFN0-000	Call for Pricing

BALL VALVES MUST BE ORDERED IN MULTIPLES OF BUNDLE OR BOX QUANTITY LISTED



Gas Connectors & Accessories

TRACER WIRE



SOLID COPPER TRACER WIRE



COPPER CLAD STEEL TRACER WIRE

TRACER WIRE										
CONDUCTOR SIZE	STRANDING	INSULATING MATERIAL	INSULATING THICKNESS NOMINAL	FINISHED O.D. NOMINAL	WEIGHT (PER 1000 FT.)	TEMP. RATING	OPERATING VOLTAGE	INSULATION COLOR	ITEM NO. (500' Reels)	LIST PRICE
10 AWG Copper	Solid	HMWPE	0.030"	0.164"	36.59 lbs.	-20°C to 80°C	30v	Yellow-Gas	33-7778-01	Contact Continental Industries Customer Services for Pricing
12 AWG Copper				0.142"	24.03 lbs.				33-7699-01	
14 AWG Copper				0.126"	16.11 lbs.				33-7692-01	
18 AWG Copper				0.102"	7.67 lbs.				33-7744-01	
10 AWG Copper Clad Steel				0.164"	33.93 lbs.				33-7807-01	
12 AWG Copper Clad Steel				0.142"	22.03 lbs.				33-7701-01	
14 AWG Copper Clad Steel				0.126"	14.85 lbs.				33-7700-01	
18 AWG Copper Clad Steel				0.102"	7.22 lbs.				33-7809-01	

Other insulating colors are available; Red, Blue, and Green.

SPECIAL ORDER PRODUCTS



Gas Connectors & Accessories

The products listed on the previous pages represent the most commonly used sizes and configurations. Additional sizes, custom configurations and options for these products are available as Special Orders. In addition, the following products and services are also available as Special Orders. Contact your Lyall sales representative or customer service for pricing, minimum order quantities and lead times for these products.

LYCOFIT® REDUCER TEES



INSULATED UNIONS



COPO COPPER TO PE FITTINGS



FIELD ASSEMBLED SERVICE RISERS



FACTORY ASSEMBLED RISER OPTIONS



Anodeless Riser with factory assembled valve, LYCOFIT® coupling and support stake options.



Gas Connectors & Accessories

OTHER AVAILABLE PRODUCTS

PVC WATER SADDLES

FASTTAP



- Full wrap around saddle design eliminates stress points being applied to main.
- Tapping process uses simple combination tapping tool eliminating cumbersome tapping machines.
- Tapping cutter retains the coupon then functions as a cut-off valve eliminating corporation stops.
- Manufactured from non-corrosive materials.
 - PVC with PPI HDB Listing
 - 316 Stainless Steel Bolts
 - Brass Cutter
- Available to work with 4"-10" AWWA C-900 and 1 1/4"-12" iron pipe size mains.
- Compression, solvent-weld and threaded outlets for 3/4" to 1" PVC, PE, PB and copper tubing.
- Application may be for wet or dry taps.
- See www.nsf.org for Continental's NSF Listing to Standard 61.
- Reduces time involved with installation by 50%!

FASTTHRED



- PVC saddles for IPS mains.
- Excellent for dry taps and irrigation systems.
- Available in 1 1/4" thru 8" iron pipe size mains.
- Compression, solvent-weld and threaded outlets for 3/4" to 1" PVC, PE, PB and copper tubing.



SUPER FASTTAP



- Full wrap around saddle design eliminates stress points being applied to main.
- Tapping process uses simple combination tapping tool eliminating cumbersome tapping machines.
- Tapping cutter retains the coupon then functions as a cut-off valve eliminating corporation stops
- Manufactured from non-corrosive materials.
 - PVC with PPI HDB Listing
 - 316 Stainless Steel Bolts
- Available to work with 2"-6" iron pipe size mains.
- Compression and solvent-weld outlets to work with 1 1/4" and 2" PVC, PE, PB tubing.
- Application may be for wet or dry taps.
- See www.nsf.org for Continental's NSF Listing to Standard 61.
- Reduces time involved with installation by 50%!

STANDARD CONDITIONS OF SALE



STANDARD CONDITIONS OF SALE

All orders are accepted and all sales are made subject only to the provisions of the written contract between us under which the order is placed, or if no such contract exists, subject only to the terms on the face hereof including the following provisions. The terms of the contract take precedence over the terms and conditions herein. If the terms of a purchase order, oral representation or proposal are inconsistent with the terms on this document, the terms on the document take precedence.

1. ACCEPTANCE OF ORDERS

Orders are binding upon Seller only upon written acceptance at Seller's office, evidenced by an order confirmation furnished to the Buyer.

2. PRICES AND QUOTATIONS

All prices, whether shown in the Price List or in order confirmations or otherwise quoted or agreed upon, are in U.S. dollars and are subject to change without notice at any time prior to actual shipment of the goods. Price increases will not, however, be applied to (a) goods covered by an order confirmation stipulating a shipment date within 30 days after the effective date of the increase, or (b) charges on goods sold under a 90-Day Firm Order accepted by Seller prior to the effective date of the increase.

Written quotations automatically expire unless accepted within thirty (30) days from date quoted and are subject to termination by notice within that period.

Verbal quotations expire, unless accepted, the same day they are made.

Prices shown in published literature are maintained as general source of information and are not quotations or offers to sell.

Seller reserves the right to make correction due to typographical, clerical or engineering errors, or because of incomplete or inaccurate information from Buyer.

3. MINIMUM BILLING CHARGE

Orders amounting to less than \$50.00 will be billed at \$50.00 Net.

4. PENALTY CLAUSE

No penalty clause of any description, in any specification or order will be effective unless specifically approved in writing by a principal officer of the company.

5. CANCELLATION

An order once placed with and accepted by the company can be canceled only with the company's consent and upon terms that indemnify the company against loss.

6. TAXES

In the absence of proper evidence of exemption supplied to us if any Sales Use or similar tax is payable in connection with any transaction or part thereof, between the purchaser and Continental Industries with respect to the goods delivered, the purchaser will, upon demand of Continental Industries pay to it the amount of any such tax.

7. TERMS OF PAYMENT

All products are Net thirty days from date of invoice. Overdue accounts are subject to a charge as slated on Invoice or the maximum legal contractual rate between corporations, whichever is the lesser.

8. CONTRACT

Our contract in regard to the goods identified on the face hereof consists in its entirety of the terms and conditions of your order and the terms and conditions appearing on the face and back of this instrument, excluding all usages of trade and all terms and conditions of your order which are in conflict with or which are in addition to the terms and conditions appearing hereon. Each delivery is a separate contract. No changes in or additions to this contract shall be of any effect unless

contained in a writing signed by the party claimed to be bound thereby and no changes or additions shall be effected by the return to you signed or unsigned, of tearoff or other forms attached to or accompanying your order which you require us to return. No written or oral understandings, representations, or warranties shall of any effect, nor shall any written or oral communication from us to you be deemed an acceptance of your order or to impose contractual obligations on us with respect to it. The interpretation and effect hereof shall be governed by the laws of the state in which the first shipment of goods hereunder originates.

9. RETURNED MATERIAL

No product may be returned without the written. Permission and specific shipping instructions of the company.

Special products built to purchaser's specifications will not be accepted for return.

Only material as currently manufactured will be considered for return unless otherwise agreed upon and approved by the company. Products must be securely packaged so as to reach us without damage.

Any cost incurred by the company to put products in first-class condition either for resale or with any modifications to be made by purchaser's request for return use will be charged to the purchaser.

Material accepted for return is subject to a restocking charge of 25% of the billing invoice or a minimum service charge of \$25.00 plus all transportation charges incurred by the company.

10. SHIPPING AND DELIVERY

Delivery Shipping promises are made in good faith, shipping dates appearing on acknowledgments of orders, or given the customer in any other manner are approximate. Where the customer delays in supplying information necessary to proceeding with the order, the date of shipment may be extended accordingly, and determined by conditions at the Company's factory at the time when the specifications were completed.

The Company shall not be liable for delay in delivery due to causes beyond its reasonable control, or due to acts of God, acts of purchaser, fire, strikes, floods, epidemics, quarantine restrictions, war, insurrection, or riots, civil or military authority, freight, embargoes, car wrecks, delays or shortages in transportation, unusually severe weather or inability to obtain necessary labor, materials, or manufacturing facilities due to such causes, and in the event of any such delay the date of delivery shall be extended for a length of time equal to the period of the delay.

All products are carefully packed for shipment, and the Company will assume no responsibility for delay, breakage or damage after delivery in good order has been made to the carrier.

All claims for loss, damage, or delay must be made to the carrier by the purchaser.

Claims for shortages or other errors must be made in writing to the Company within 10 days after receipt of shipment. Failure to give such notice shall constitute unqualified acceptance and a waiver of all such claims by the purchaser.

11. TRANSPORTATION EXPENSE

All products are sold F.O.B. point of shipment. All shipments will be shipped collect unless specified otherwise. The company will determine the point of origin of shipment, the method of transportation and routing.

If the purchaser requires shipment by method of routing other than that selected, the purchaser shall pay any additional transportation charges or other costs resulting from its requirement.



Gas Connectors & Accessories

STANDARD CONDITIONS OF SALE

STANDARD CONDITIONS OF SALE (Continued)

Cartage, stevedoring, insurance and other special cost shall be paid by the purchaser. These terms also apply where land routes are available but water transportation is specified by the purchaser.

No allowance will be made in lieu of transportation if the purchaser accepts shipment at the factory, freight station or otherwise supplies his own transportation.

Freight Allowance Policy: Orders over \$3600.00 Net, shipping within the contiguous United States, will meet our freight allowance policy and receive free freight. Continental Industries and RW Lyall products CANNOT be combined to reach freight Allowed minimum.

12. WARRANTY

Hubbell Gas Connectors & Accessories' products are fully warranted against defective material and workmanship as follows:

Any product found to be defective and with prior written notice and return of the product, a replacement will be sent at no charge, freight prepaid, without any further expense to Continental Industries. This warranty covers the products only to the extent and purpose for which they are intended. Any misuse or abuse of the product voids this warranty.

No claims for labor or other expenses necessary to replace or repair damages caused by defective products will be allowed.

THE FOREGOING WARRANTY IS EXCLUSIVE AND IN LIEU OF ALL OTHER WARRANTIES OF QUALITY WHETHER WRITTEN, ORAL, OR IMPLIED, INCLUDING BUT NOT LIMITED TO ANY WARRANTY OR MERCHANTABILITY OR FITNESS FOR A PARTICULAR PURPOSE.

13. CONSEQUENTIAL DAMAGES

The company shall not be liable for any consequential, contingent, special or incidental damages whatsoever.

14. NON-STANDARD JOBS

Any design of an extra complex nature requiring unusual production techniques or reduced operations speeds will be charged for extra. Such jobs will be estimated and priced at the home office.

15. QUANTITY TOLERANCE

Over-runs and under-runs of 10% of special goods built to purchaser's specifications will constitute fulfillment of an order.

16. SPECIAL TOOLING

All tooling required for initial order are to be billed to and paid for by Buyer.

17. CURTAILMENT OF PRODUCTION

If the Seller's production is curtailed or suspended for any reason, deliveries may, at its option, be canceled or may be pro-rated during the period of curtailed production and thereafter resumed until delivery is made in full.

18. CREDIT

Shipments and deliveries shall, at all times, be subject to the approval and limitations set by Seller's credit department. If Buyer shall fail to make any payments in accordance with the terms and provisions hereof, or if Seller at any time has any doubt as to Buyer's financial responsibility, Seller in addition to its other rights and remedies, but not in limitation thereof, may at its option and without notice defer shipments or deliveries hereunder, or under any other contract with Buyer, except upon receipt of satisfactory security or of cash before shipment.

19. GENERAL

This contract is not assignable or transferable voluntarily or by operation of law. This invoice date hereon shall be prime facie evidence of the date on which this instrument was mailed.

The provision of any contract resulting from this order are for the benefit of the parties thereto and not for any other reason.

No Waiver, alteration, or modification of any of the provisions hereof shall be binding unless in writing and signed by a duly authorized representative of the Seller.



Gas Connectors & Accessories

Hubbell Gas Connectors & Accessories



Locations
Tulsa OK
Broken Arrow OK
Corona CA
New Berlin WI
Elgin IL

0000-99-8002-00 06/17



www.hubbell.com