

OWNER'S MANUAL

R-410A 2-Stage Package Heat Pump

PHR524-60

1 & 3 Phase



Figure 1 - Unit PHR5

NOTE TO EQUIPMENT OWNER:

For your convenience, please record the model and serial numbers of your new equipment in the spaces provided. This information, along with the installation data and dealer contact information, will be helpful should your system require maintenance or service.

UNIT INFORMATION

Model # _____

Serial # _____

ACCESSORIES (List type and model #)

INSTALLATION INFORMATION

Date Installed _____

DEALERSHIP CONTACT INFORMATION

Company Name _____

Address _____

Phone Number _____

Technician Name _____

NOTE TO INSTALLER:

This manual must be left with the equipment owner.

SAFETY CONSIDERATIONS

Improper installation, adjustment, alteration, service, maintenance, or use can cause explosion, fire, electrical shock, or other conditions which may cause death, personal injury, or property damage. Consult a qualified installer, service agency, or your distributor or branch for information or assistance. The qualified installer or agency must use factory-authorized kits or accessories when modifying this product. Refer to the individual instructions packaged with the kits or accessories when installing.

Follow all safety codes. Wear safety glasses, protective clothing, and work gloves. Use quenching cloth for brazing operations. Have a fire extinguisher available. Read these instructions thoroughly and follow all warnings or cautions included in literature and attached to the unit. Consult local building codes, the current editions of the National Electrical Code (NEC) NFPA 70.

In Canada refer to the current editions of the Canadian electrical Code CSA C22.1.

Recognize safety information. This is the safety-alert symbol

. When you see this symbol on the unit and in instructions or manuals, be alert to the potential for personal injury. Understand these signal words; DANGER, WARNING, and CAUTION. These words are used with the safety-alert symbol. DANGER identifies the most serious hazards which **will** result in severe personal injury or death. WARNING signifies hazards which **could** result in personal injury or death. CAUTION is used to identify unsafe practices which **may** result in minor personal injury or product and property damage. NOTE is used to highlight suggestions which **will** result in enhanced installation, reliability, or operation.

NOTE: Installer: This manual should be left with the equipment user.

 **WARNING**

FIRE, EXPLOSION, ELECTRICAL SHOCK HAZARD

Failure to follow this warning could result in personal injury, death, and/or property damage. Installation and servicing of this equipment can be hazardous due to mechanical and electrical components. Only trained and qualified personnel should install, repair, or service this equipment.

 **WARNING**

FIRE, EXPLOSION HAZARD

Failure to follow this warning could result in personal injury, death, and/or property damage.

Do not store or use combustible materials, gasoline, or other flammable vapors and liquids in the vicinity of this or any other appliance.

 **WARNING**

ELECTRICAL SHOCK HAZARD

Failure to follow this warning could result in personal injury and/or death.

Before performing recommended maintenance, be sure the main power switch to unit is turned off and lock-out tag is installed.

 **CAUTION**

CUT HAZARD

Failure to follow this caution may result in personal injury.

When removing access panels or performing maintenance functions inside your unit, be aware of sharp sheet metal parts and screws. Although special care is taken to reduce sharp edges to a minimum, be extremely careful and wear appropriate protective clothing, safety glasses and gloves when handling parts or reaching into the unit.

 **WARNING**

FIRE, EXPLOSION, ELECTRICAL SHOCK HAZARD

Failure to follow this warning could result in personal injury, death or property damage.

Do not use this unit if any part has been under water. Immediately call a qualified service technician to inspect the unit and to replace any part of the control system which has been under water.

Starting or Shutting Unit Off

To start the unit:

1. Turn on the electrical power supply to unit.
2. Select temperature and set MODE control to desired mode.

To shut unit off:

NOTE: If the unit is being shut down because of a malfunction, call your dealer as soon as possible.

1. Set system MODE control to OFF.
2. Turn off the electrical power supply to unit.

OPERATING YOUR UNIT

The operation of your unit is controlled by indoor thermostat. You simply adjust the thermostat and it maintains the indoor temperature at the level you select. Most thermostats of cooling systems have 3 controls: a temperature control selector, a FAN control, and a SYSTEM or MODE control. Refer to your thermostat owner's manual for more information.

To better protect your investment and to eliminate unnecessary service calls, familiarize yourself with the following facts:

Cooling Mode

With the SYSTEM or MODE control set to COOL, your unit will run in cooling mode until the indoor temperature is lowered to the level you have selected. On extremely hot days, your unit will run for longer periods at a time and have shorter "off" periods than on moderate days.

Heating Mode

With the SYSTEM or MODE control set to HEAT, your unit will run in heating mode until the room temperature is raised to the level you have selected. Of course, your unit will run for longer periods to maintain a comfortable environment on cooler days and nights than on moderate ones.

Supplemental Heat

Your unit is your primary heating source. Your system may also be equipped with a supplemental heating source such as electric heat. On cold days and nights, your system will automatically turn on the supplemental heat, as needed, in order to maintain the level of comfort you have selected.

When your heat pump needs additional heat to keep you comfortable your thermostat will turn on the supplemental heat (if equipped).

Defrost Mode

When your unit is providing heat to your home or office and the outdoor temperature drops below 45°F (7.2°C), moisture may begin to freeze on the surface of the coil. If allowed to build up, this ice would impede airflow across the coil and reduce the amount of heat absorbed from the outside air. So, to maintain energy-efficient operation, your unit has an automatic defrost mode.

The defrost mode starts at a preset time interval of 60 minutes, although, it may be reset to 30, 90 or 120 minutes. Defrost will start at the preset time only if the ice is sufficient to interfere with normal heating operation.

After the ice is melted from the coil, or after a maximum of 10 minutes in defrost mode, the unit automatically switches back to normal heating operation.

Do not be alarmed if steam or fog appears at the outdoor unit during defrost mode. Water vapor from the melting ice may condense into a mist in the cold outside air.

During certain weather conditions such as heavy snow and freezing rain it is not uncommon for ice to build up on the unit grille. This is normal for these weather conditions. Do not attempt to remove the ice from the unit grille. This condition will not affect the proper function of the unit and will clear within a few days.

Emergency Heating Mode

In the event of primary unit heat failure, the emergency heat mode allows your supplemental heating source to keep your home or office warm until your unit can be serviced. Contact your dealer in the event of primary unit heat failure.

⚠ WARNING

FIRE, EXPLOSION, ELECTRICAL SHOCK AND CUT HAZARD

Failure to follow this warning could result in personal injury, death or property damage.

1. TURN OFF ELECTRICAL POWER TO YOUR UNIT BEFORE SERVICING OR PERFORMING MAINTENANCE. Lock out and tag switch with a suitable warning label.
2. When removing access panels or performing maintenance functions inside your unit, be aware of sharp sheet metal parts and screws. Although special care is taken to reduce sharp edges to a minimum, be extremely careful when handling parts or reaching into the unit. Wear safety glasses, glove, and appropriate protective clothing.

MAINTENANCE AND SERVICE

This section discusses maintenance that should be performed on your system. Most maintenance should be performed by your dealer. You, as the owner, may wish to handle some minor maintenance for your new unit.

Routine Maintenance

All routine maintenance should be handled by skilled, experienced personnel. Your dealer can help you establish a standard procedure.

To assure proper functioning of the unit, flow of condenser air must not be obstructed from reaching the unit. Clearance from the top of the unit is 48 in. (1219 mm). Clearance of at least 36 in. (914 mm) is required on sides except the power entry side (42 in. [1067 mm] clearance) and the duct side (12 in. [305 mm] minimum clearance).

Maintenance and Care for the Equipment Owner

Before proceeding with those things you might want to maintain yourself, please carefully consider the following:

⚠ WARNING

FIRE, EXPLOSION, ELECTRICAL SHOCK AND CUT HAZARD

Failure to follow this warning could result in personal injury, death or property damage.

1. TURN OFF ELECTRICAL POWER TO YOUR UNIT BEFORE SERVICING OR PERFORMING MAINTENANCE. Lock out and tag switch with a suitable warning label.
2. When removing access panels or performing maintenance functions inside your unit, be aware of sharp sheet metal parts and screws. Although special care is taken to reduce sharp edges to a minimum, be extremely careful when handling parts or reaching into the unit. Wear safety glasses, glove, and appropriate protective clothing.

Air Filters

The air filter(s) should be checked every 3 or 4 weeks and changed or cleaned whenever it becomes dirty. Dirty filters produce excessive stress on the blower motor and can cause the motor to overheat and shut down.

This unit must have air filters in place before it can be operated. These filters can be located in one of at least two places. In many applications, the installer will provide return air filter grilles mounted on the wall or ceiling of the conditioned structure. In the instance of filter grilles, the filters can simply be removed from the grille and replaced.

The other typical application is an accessory filter rack installed inside the unit itself. The following information is given to assist in changing filters used in these internal filter racks.

Table 1 indicates the correct indoor filter size for your unit. Refer to **Figure 2** to access filters installed in the accessory filter rack. If using an Accessory Filter Rack, refer to the Installation Instructions provided with it for correct filter sizes and quantities.

Table 1 – Indoor Air Filter Data

| Unit Size | Filter Size in. (mm) |
|-----------|----------------------|
| 24 | 20x20x1 (508x508x25) |
| 30 | 20x24x1 (508x610x25) |
| 36–42 | 24x30x1 (610x762x25) |
| 48–60 | 24x36x1 (610x914x25) |

To replace or inspect filters in accessory filter rack (See **Figure 2**):

1. Remove the filter access panel using a 5/16-in. nut driver.
 2. Remove the filter(s) by pulling it out of the unit. If the filter(s) is dirty, clean or replace with a new one.
- When installing the new filter(s), note the direction of the airflow arrows on the filter frame, which should be pointed at the indoor coil.
3. Reinstall filter access panel ensuring opening is air and water tight.

If you have difficulty locating your air filter(s) or have questions concerning proper filter maintenance, contact your dealer for instructions. When replacing filters, always use the same size and type of filter that was supplied originally by the installer.

⚠ CAUTION

UNIT OPERATION HAZARD

Failure to follow this caution may result in property damage.

Never operate your unit without filters in place. An accumulation of dust and lint on internal parts of your unit can cause loss of efficiency and blower motor and/or compressor damage.

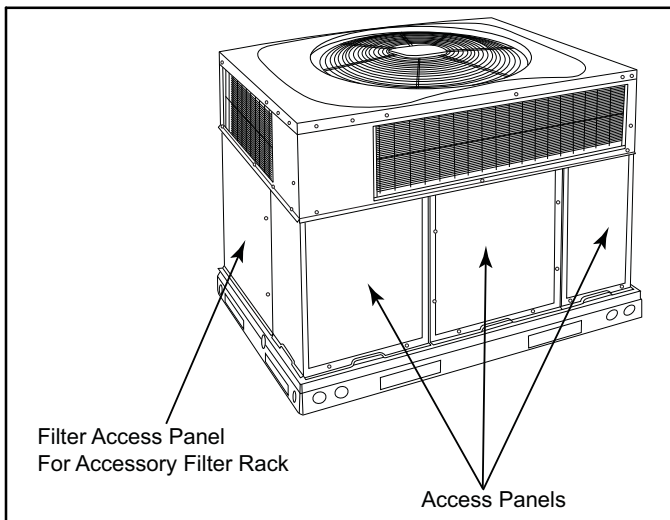

A09044

Figure 2 – Unit Access Panel

Fans and Fan Motors

Periodically check the condition of fan wheels and housings and fan-motor shaft bearings. Contact your dealer for the required annual maintenance.

Indoor and Outdoor Coils

Cleaning of the coils should only be done by qualified service personnel. Contact your dealer for the required annual maintenance.

Condensate Drain

The drain pan and condensate drain line should be checked and cleaned at the same time the cooling coils are checked by your dealer.

Compressor

All compressors are factory shipped with a normal charge of the correct type of refrigeration grade oil. A compressor should rarely require additional oil.

Condenser Fan



WARNING

PERSONAL INJURY AND UNIT DAMAGE HAZARD

Failure to follow this warning could result in personal injury, death or property damage.

Do not poke sticks, screwdrivers, or any other object into revolving fan blades.

The fan must be kept free of all obstructions to ensure proper cooling. Contact your dealer for any required service.

Electrical Controls and Wiring

Electrical controls are difficult to check without proper instrumentation. If there are any discrepancies in the operating cycle, contact your local dealer and request service.



WARNING

EXPLOSION, BURN AND ENVIRONMENTAL HAZARD

Failure to follow this warning could result in personal injury, death or property damage.

System under pressure. Relieve pressure and recover all refrigerant before system repair or final unit disposal. Use all service ports and open all flow-control devices, including solenoid valves.

Refrigerant Circuit

The refrigerant circuit is difficult to check for leaks without the proper equipment. If inadequate cooling is suspected, contact your local dealer for service.

Unit Panels

After performing any maintenance or service on the unit, be sure all panels are fastened securely in place to prevent rain from entering unit cabinet and to prevent disruption of the correct unit airflow pattern.

Regular Dealer Maintenance

In addition to the type of routine maintenance you might be willing to perform, your unit should be inspected regularly by a properly trained service technician. An inspection (preferably each year, but at least every other year) should include the following:

1. Inspection and, if required, cleaning of the outdoor and indoor coils.
2. Inspection and, if required, cleaning of the indoor coil drain pan.
3. Inspection and cleaning of blower wheel housing and motor.
4. Inspection of all supply-air and return-air ducts for leaks, obstructions, and insulation integrity. Any problems found should be resolved at this time.
5. Inspection of the unit base to ensure that no cracks, gaps, etc., exist which may cause a hazardous condition.
6. Inspection of the unit casing for signs of deterioration.
7. Inspection of all electrical wiring and components to assure proper connection.
8. Inspection for leaks in the refrigerant circuit. Pressure check to determine appropriate refrigerant charge.
9. Inspection of compressor oil level by service person to ensure proper oil level is maintained in the compressor when it is installed and running.
10. Operational check of the unit to determine working conditions. Repair or adjustment should be made at this time.

Your servicing dealer may offer an economical service contract that covers seasonal inspections. Ask for further details.

Complete service instructions can be found in the unit Installation, Start-up and Service Instructions.

Warranty Certificate

Your unit has a limited warranty. Be sure to read the warranty carefully to determine the coverage for your unit.

Before you call for service...

...check for several easily-solved problems.

1. **If insufficient heating or cooling is suspected:**
 - a. Check for sufficient airflow. Check the air filter for dirt. Check for blocked return-air or supply-air grilles. Be sure they are open and unobstructed. If these checks do not reveal the cause, call your servicing dealer.
2. **If your unit is not operating at all, check the following list for easy solutions:**
 - a. Check to be sure that the temperature specified by your thermostat is set below the indoor temperature during the cooling season or above the indoor temperature during heating season. Be sure the thermostat is set to COOL or HEAT and not OFF.
 - b. If your unit still fails to operate, call your servicing dealer for troubleshooting and repairs. Specify the model and serial numbers of your unit. (Record them in this manual in the space provided.) If the dealer knows exactly which unit you have, he may be able to offer suggestions over the phone, or save valuable time through knowledgeable preparation for the service call.

In Case of Trouble

If you perform the steps above and unit performance is still unsatisfactory, shut off the unit and call your dealer.