



Whitehaven®
32-3/4" undermount single-bowl farmhouse kitchen
sink
K-5827

Features

- Fits minimum 33" (838 mm) apron sink base cabinet
- Single bowl
- 9" (229 mm) depth provides generous workspace
- Self-Trimming® apron overlaps cabinet face for easy installation and beautiful results
- Bowl slopes toward drain to minimize water pooling
- Offset drain increases workspace in the sink and storage space underneath

Material

- KOHLER® enameled cast iron

Installation

- Cutout templates included
- Undermount

Required Products/Accessories

For under-mount installation

11352

6449

8799

8801

Recommended Products/Accessories

23726

23725

Optional Products/Accessories

9000



Codes/Standards







ASME A112.19.1/CSA B45.2

KOHLER® Enameled Cast Iron Kitchen and Bathroom Sink Lifetime Limited Warranty

See website for detailed warranty information.

Available Colors/Finishes

Color tiles intended for reference only.

Color	Code	Description
	0	White
	FF	Sea Salt™
	96	Biscuit
	NY	Dune
	95	Ice™ Grey
	58	Thunder™ Grey
	7	Black Black™
	DGB	

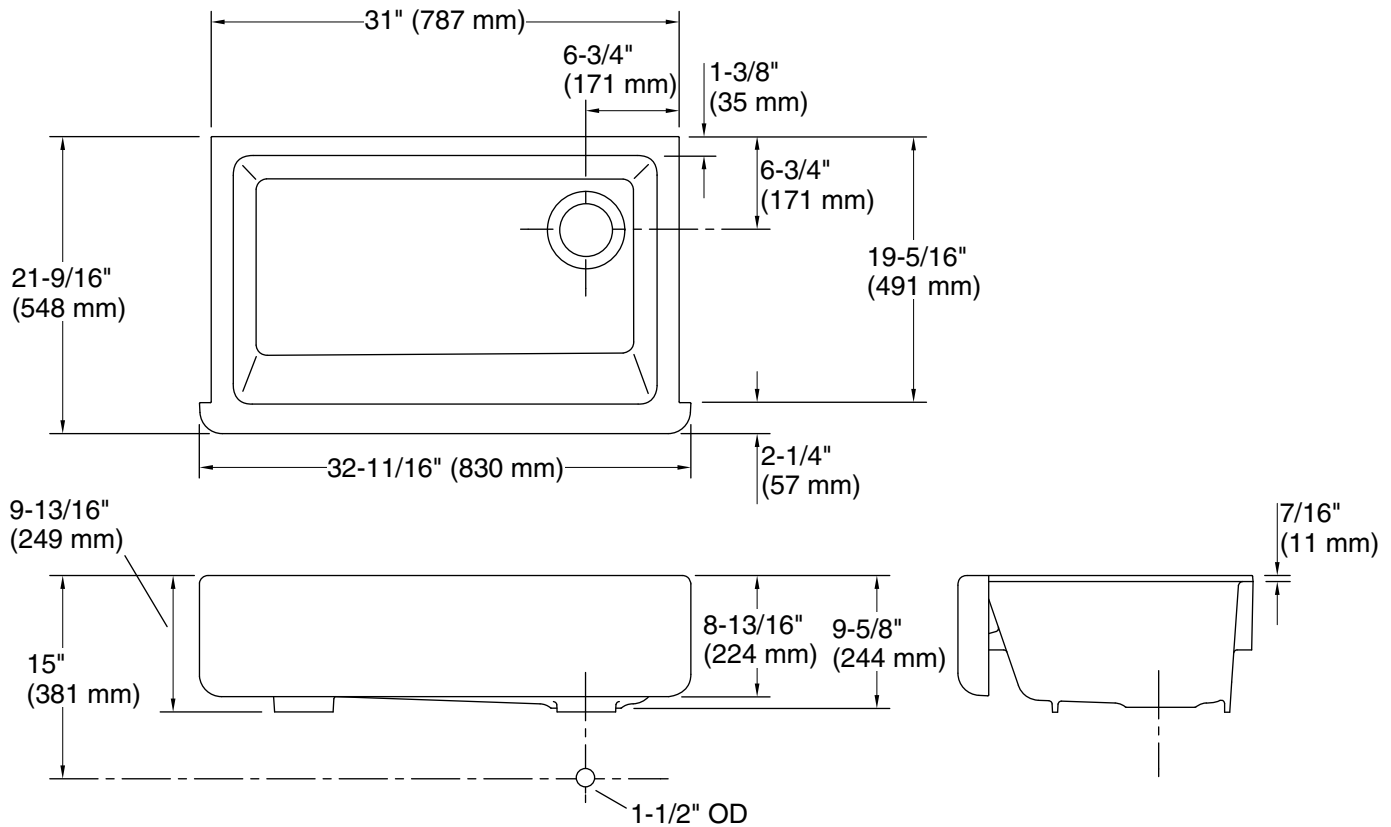

Technical Information

All product dimensions are nominal.

Bowl configuration: Single

Min. base cabinet width: 33" (838 mm)

Bowl area: Length: 27-3/4" (705 mm)
 Width: 18-1/16" (459 mm)
 Bowl depth: 8-13/16" (224 mm)
 Water depth: 9" (229 mm)

Drain hole: 3-5/8" (92 mm)

Template: 1214395-7, required, included
 1217812, required, included

Notes

Install this product according to the installation instructions.

NOTICE: Countertop manufacturer or cutter must use the current product template available at www.kohler.com, or by calling 1-800-4KOHLER. Kohler Co. is not responsible for cutout errors when the incorrect cutout template is used.

IMPORTANT! The distance from the top edge of the cabinet to the top of the cabinet door must be at least 9" (229 mm) to install this sink.