

User's Manual for

NEOTHERM[®]

with the Touchscreen Display

Modulating Boiler

Model NTH

Sizes 285–850 MBTU/h

Water Heater

Model NTV

Sizes 150-850 MBTU/h

FOR YOUR SAFETY: This product must be installed and serviced by a professional service technician, qualified in hot water boiler and heater installation and maintenance. Improper installation and/or operation could create carbon monoxide gas in flue gases which could cause serious injury, property damage, or death. Improper installation and/or operation will void the warranty.

⚠ WARNING

If the information in this manual is not followed exactly, a fire or explosion may result causing property damage, personal injury or loss of life.

Do not store or use gasoline or other flammable vapors and liquids in the vicinity of this or any other appliance.

WHAT TO DO IF YOU SMELL GAS

- Do not try to light any appliance.
- Do not touch any electrical switch; do not use any phone in your building.
- Immediately call your gas supplier from a nearby phone. Follow the gas supplier's instructions.
- If you cannot reach your gas supplier, call the fire department.

Installation and service must be performed by a qualified installer, service agency, or gas supplier.

⚠ AVERTISSEMENT

Assurez-vous de bien suivre les instructions données dans cette notice pour réduire au minimum le risque d'incendie ou d'explosion ou pour éviter tout dommage matériel, toute blessure ou la mort.

Ne pas entreposer ni utiliser d'essence ni d'autres vapeurs ou liquides inflammables dans le voisinage de cet appareil ou de tout autre appareil.

QUE FAIRE SI VOUS SENTEZ UNE ODEUR DE GAZ:

- Ne pas tenter d'allumer d'appareils.
- Ne touchez à aucun interrupteur. Ne pas vous servir des téléphones dans le bâtiment où vous vous trouvez.
- Appelez immédiatement votre fournisseur de gaz depuis un voisin. Suivez les instructions du fournisseur.
- Si vous ne pouvez rejoindre le fournisseur de gaz, appelez le service des incendies.

L'installation et l'entretien doivent être assurés par un installateur ou un service d'entretien qualifié ou par le fournisseur de gaz.

CONTENTS

Familiarizing yourself to the Laars NeoTherm..... 1

FOR YOUR SAFETY,
PLEASE READ THIS BEFORE OPERATING..... 2

What to Do If You Smell Gas 2

POUR VOTRE SÉCURITÉ,
LISEZ AVANT DE METTRE EN MARCHÉ..... 2

Que Faire si Vous Sentez une Odeur de Gaz 2

Lighting the Unit..... 3

Turning Off the Gas to the Unit 3

Instructions de Mise en Marche..... 4

Fermeture de l’Alimentation en Gaz..... 4

Shutting Down the NeoTherm 5

Restarting the NeoTherm 5

In the Event of Power Failure 5

THE USER INTERFACE AND ON/OFF SWITCH..... 6

About Lockouts, Holds, and Alerts 10

Care, Inspection, and Service..... 11



FAMILIARIZING YOURSELF TO THE *NEOTHERM*[®]

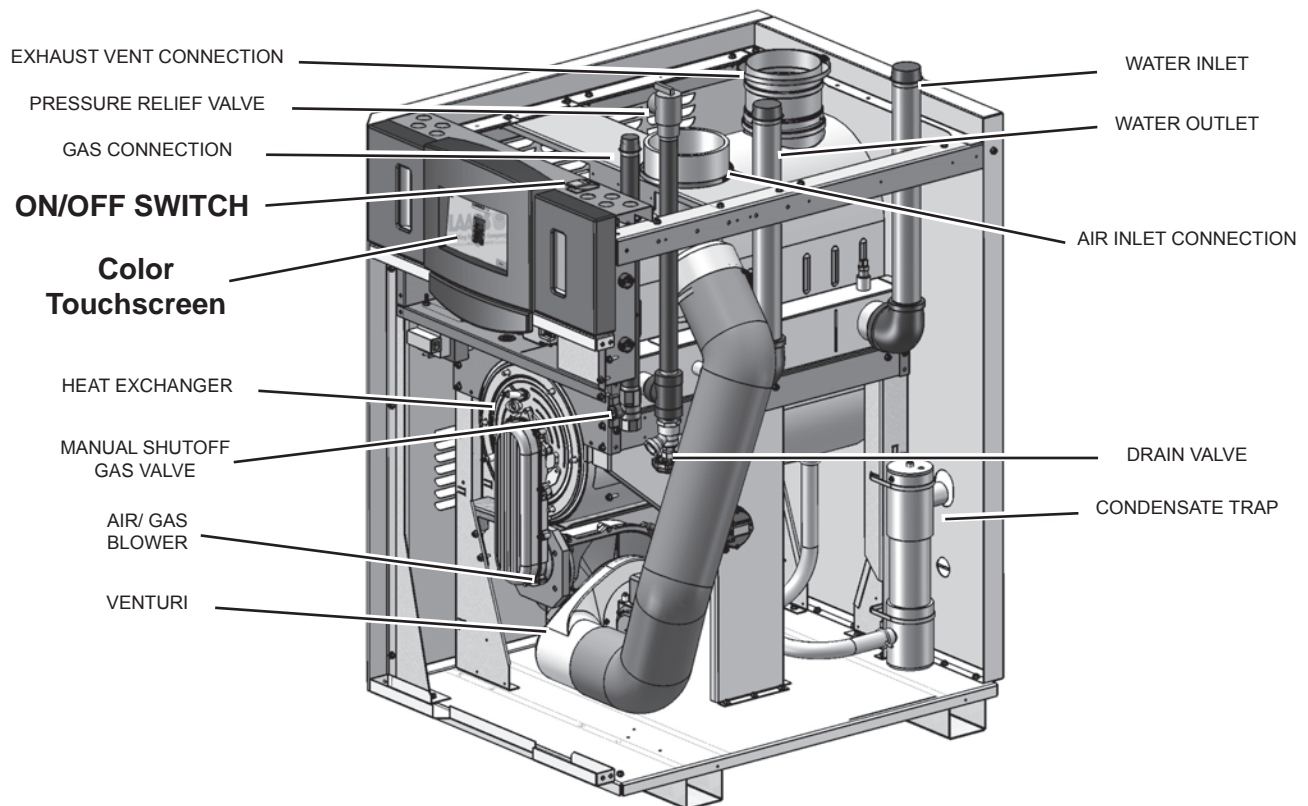

Sizes available are 199-850 MBTU/h. This illustration is of the 399 MBTU/h

Shown without jacket. Internal components will vary slightly between sizes, but the Touch Screen & On/Off Switch remain the same.

**FOR YOUR SAFETY -
PLEASE READ THIS BEFORE OPERATING****WARNING**

If you do not follow these instructions exactly, a fire or explosion may result, causing property damage, personal injury or loss of life.

- A. This unit does not have a pilot. It is equipped with an ignition device which automatically lights the burner. Do not try to light the burner by hand.
- B. **Before operating the unit**, check for any smell of gas in the area around it. Be sure to smell next to the floor, because some gas is heavier than air and will settle near the floor.
- C. Use only your hand to turn the handle on the gas valve. Never use tools. If the valve handle will not turn by hand, don't try to repair it. Call a qualified service technician. If you force the valve or try to repair it, this may result in a fire or explosion.
- D. Do not use this unit if any part has been under water. Immediately call a qualified service technician to inspect the unit. Any part of the control system or any gas control which has been under water must be replaced.

WHAT TO DO IF YOU SMELL GAS

- Do not try to light any appliance or device that uses gas.
- Do not touch any electrical switch. Do not use any phone in your building.
- Immediately call your gas supplier from a neighbor's phone. Follow the gas supplier's instructions.
- If you cannot reach your gas supplier, call the fire department.

**POUR VOTRE SÉCURITÉ,
LISEZ AVANT DE METTRE EN MARCHÉ****AVERTISSEMENT**

Quiconque ne respecte pas à la lettre les instructions dans la présente notice risque un début d'incendie ou une explosion entraînant des dommages, des blessures ou la mort.

- A. Cet appareil est muni d'un dispositif d'allumage qui allume automatiquement la veilleuse. Ne tentez pas d'allumer la veilleuse manuellement.
- B. **Avant de faire fonctionner**, reniflez tout autour de l'appareil pour déceler une odeur de gaz. Reniflez près du plancher, car certains gaz sont plus lourds que l'air et peuvent s'accumuler au niveau du sol.
- C. N'utilisez que votre main pour fermer la soupape d'arrêt de gaz. N'utilisez jamais d'outils. Si la poignée de la valve ne tourne pas manuellement, ne tentez pas de la réparer. Communiquez avec un technicien de service qualifié. Le fait de forcer ou de tenter de réparer la poignée pourrait causer un incendie ou une explosion.
- D. N'utilisez pas cet appareil s'il a été plongé dans l'eau, même partiellement. Faites inspecter l'appareil par un technicien qualifié et remplacez toute partie du système de contrôle et toute commande qui ont été plongées dans l'eau.

QUE FAIRE SI VOUS SENTEZ UNE ODEUR DE GAZ

- Ne pas tenter d'allumer d'appareil.
- Ne toucher à aucun interrupteur; ne pas vous servir des téléphones se trouvant dans le bâtiment.
- Appelez immédiatement votre fournisseur de gaz depuis un voisin. Suivez les instructions du fournisseur.
- Si vous ne pouvez rejoindre le fournisseur, appelez le service des incendies.

LIGHTING THE UNIT

1. STOP! Read the safety information listed above.
2. Set the thermostat to the lowest setting.
3. Turn off all electric power to the unit.
4. This unit is equipped with an ignition device which automatically lights the burner. Do not try to light the burner by hand.
5. Remove the front access panel.
6. Turn off the manual gas valve. The valve is off when the valve handle is at a right angle to the gas pipe.
7. Wait five minutes to allow any gas to clear. Smell for gas, including the area near the floor. If you do smell gas, STOP! Follow Step B in the safety information listed above. If you don't smell gas, go to the next step.
8. Slowly turn the manual gas valve to "ON." The handle on the valve will be parallel to the gas pipe.
9. Replace the front panel.
10. Turn on the electric power to the unit.
11. Set the thermostat to the desired setting.
12. If the unit will not operate, follow the instructions in "Turning Off the Gas to the Unit" and call your service technician or gas supplier.

TURNING OFF THE GAS TO THE UNIT

1. Before doing any service work, turn off all electric power to the unit.
2. Set the thermostat to the lowest setting.
3. Remove the front access panel.
4. Turn off the manual gas valve. The valve is off when the valve handle is at a right angle to the gas pipe.
5. Replace the front panel.

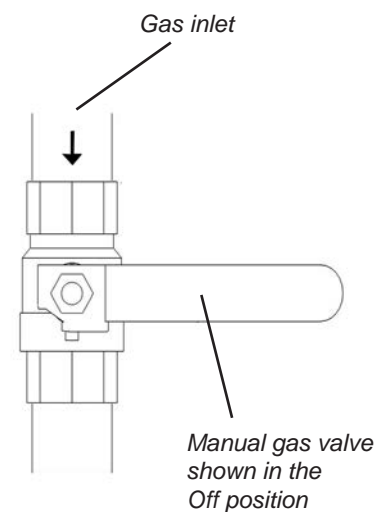

Manual Gas Valve

INSTRUCTIONS DE MISE EN MARCHÉ

1. ARRÊTEZ ! Lisez les instructions de sécurité sur la portion supérieure.
2. Réglez le thermostat à la température la plus basse.
3. Coupez l'alimentation électrique de l'appareil.
4. Cet appareil est doté d'un dispositif d'allumage qui allumera automatiquement le brûleur. Ne tentez pas d'allumer le brûleur manuellement.
5. Retirez le couvercle avant.
6. Mettez la soupape d'arrêt de gaz à „OFF”. La valve est en position „OFF” lorsque la poignée se trouve à angle droit du tuyau de gaz.
7. Attendez cinq minutes afin que le gaz se dissipe. Si vous croyez sentir une odeur de gaz, ARRÊTEZ ! Reportez-vous aux instructions B ci-dessus, sur cette étiquette. S'il n'y a pas d'odeur de gaz, passez à la prochaine étape.
8. Remettez lentement la soupape d'arrêt de gaz en position „ON”. La poignée sera parallèle au tuyau de gaz.
9. Remplacez le couvercle avant.
10. Rétablissez l'alimentation électrique à l'appareil.
11. Réglez le thermostat à la température désirée.
12. Si l'appareil ne fonctionne pas, suivez les directives relatives à la fermeture de l'alimentation en gaz et communiquez avec votre technicien de service ou le fournisseur de gaz.

FERMETURE DE L'ALIMENTATION EN GAZ

1. Coupez toute alimentation électrique à l'appareil si celui-ci doit faire l'objet d'un entretien.
2. Réglez le thermostat au réglage le plus bas.
3. Retirez le couvercle d'accès au panneau de commande.
4. Mettez la soupape d'arrêt de gaz à „OFF”. La valve est en position „OFF” lorsque la poignée se trouve à angle droit du tuyau de gaz.
5. Remplacez le couvercle d'accès au panneau de commande.

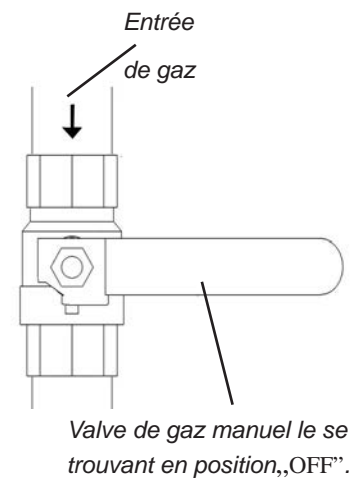
*Valve de Gaz Manuel*

SHUTTING DOWN THE NEOTHERM

It may sometimes be necessary to shut down the NeoTherm. Here are the steps required to do this:

1. Switch off the main electrical disconnect switch.
2. Open the front cover and close the main manual gas valve.
3. If freezing is anticipated, drain the NeoTherm. (Also be sure to protect the piping in the building from freezing.)

The steps listed above may require qualified service personnel.

RESTARTING THE NEOTHERM

It may be necessary to restart the NeoTherm – for example, after a power interruption. Here are the steps required to do this:

1. Reset any errors using the Touchscreen Display. See the section on “About Lockouts, Holds, and Alerts.”
2. Turn up the thermostat to call for heat.
3. In approximately 2 seconds, the blower will operate. Ignition should occur after 35-40 seconds. It may take as long as 2-1/2 minutes.
4. If ignition does not occur, wait 5 minutes and then repeat steps 1 through 3.
5. If, after three attempts, the unit still does not light, shut down the boiler and call your service technician.

If the unit has been drained, follow these steps:

1. See the “Installation and Operation Manual” for instructions on filling and purging the unit.
2. Remove the front door. Turn on the gas shutoff valve.
3. Switch on the main electrical disconnect switch. The pump and blower will start, and the igniter will be energized. After 35 seconds the gas valve will be energized, and ignition will occur. If ignition does not occur within 2-1/2 minutes switch “off” the main disconnect switch, wait 5 minutes and switch it “on” again. If after three attempts ignition does not occur, shut down the unit and call for service.

IN THE EVENT OF POWER FAILURE

The NeoTherm will not operate during an electrical power outage. If there is an extended power outage with danger of freezing, then the NeoTherm (and all other water systems) should be completely drained. Before draining the unit, turn off the gas and turn off the main power switch. When you replace the unit in service, refer to the “Installation and Operation Manual” for instructions on filling and purging.

Navigating the Touch Screen



Figure 32. NeoTherm with Touch Screen

The Touch Screen

The Touch Screen is located front and center on the NeoTherm and allows you to navigate into all of the functionality and control that is available to setup and customize your heating and/or hotwater system.

Using the Touch Screen

A screen saver is programmed into the display. Simply touch the screen to wake it up.

While under normal operation, the Touch Screen will automatically present this Home screen. See Menu 1



Menu 1. Home Screen

The home screen shows a picture of the NeoTherm controller. The color of the controller depends on the status of the NeoTherm, as shown below.

Color	Status	Control Icon
Blue	Normal operation	
Red	Lockout	
Gray	Standby mode (Burner switch off)	
Gray and crossed out	Communication problem	
Yellow	Hold state. This could be Anti short cycle, fan speed transitions, etc.	

Figure 33. Boiler Status Colors

To check the operation of the appliance, press the large Control Icon on the Home screen. The system will present a Status Summary screen for the appliance:

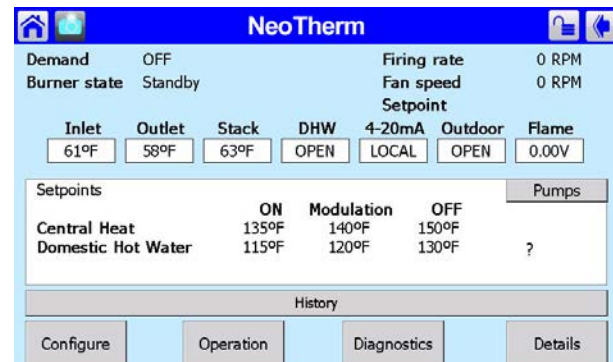

Menu 2. Status Summary

Screen Menu Icons

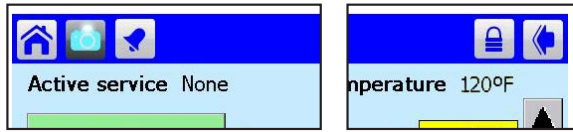

There are several icons at the top of the Touch Screen Menus (and most of the other screens) that will help you move around the system:

Home	Upper left-hand corner	Return to Home page
Camera	Upper left-hand corner	Screen-shot of current menu as a JPG file
Bell	Upper left-hand corner	System in Lockout, Reset required
Padlock	Upper right-hand corner	Shows whether a password has been entered so parameters can be changed
Back	Upper right-hand corner	Return to previous screen

Sometimes a screen is used to present a list, and often the list is too long to present on a single screen view. To see the rest of the list, pull down on the bar on the right side of the screen, or use the up- and down-arrows.

To make a change, or to get more information about one of the items on the list, press on the line for that item.

To change some parameters, a password is required. The control system includes three levels of password protection:

OEM Password	Setup and parameter changes available only to the factory.
Installer Password	Setup and parameter changes made when the system is installed, and some diagnostic and troubleshooting functions. The installer level password is “Int” (lower case “LNT.”)

User Level (no password required)
Non-critical adjustments and functions, including adjusting the Central Heat and Domestic Hot Water setpoints, monitoring the input and output variables, reading parameters from the controller, and reading the error

log

(For some special safety-related functions, besides entering the correct password, the system will ask you to go through an additional “verification” process. For more information, see the section on “Configuration.”)

When a password is necessary, the system will present the keyboard screen. See Menu 3.

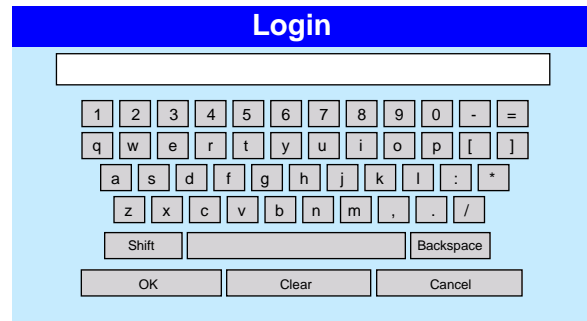

Menu 3. Keyboard Screen

The passwords used by this system are “case sensitive” – it matters whether a letter in the password is capitalized or not. Pressing the Shift key toggles between capital and lower case letters. “BS” stands for “Back Space,” and also works as a Delete key.

Anyone can view all of the parameters. However, to change most of the parameters, you will need a password.

At the bottom of the screen, the system indicates that you need to enter a password.



Menu 4. Login Required

The screen used to Login is similar to the Keyboard screen.

It may be difficult for some operators to press the keys on this screen. In this case, use the back of a plastic pen, or a stylus, or a pencil eraser. (Do not use sharp metal tools – these may damage the plastic

surface of the screen.)

Each time you press a key, the system will respond with a beep. If you are entering a password, an asterisk (*) will appear for each character you enter. The beeps and asterisks will help you enter the correct number of characters for your password.

When changing a numerical value, the system presents a numerical entry screen, as shown below.



Menu 5. Numeric Entry Screen

Verification Process for Safety-Related Parameters

The verification process allows the user to confirm that all the changes made are correct and that there have not been any inadvertent changes made.

1. When you start to change a parameter that is related to safety, the system will present a warning which looks like this:

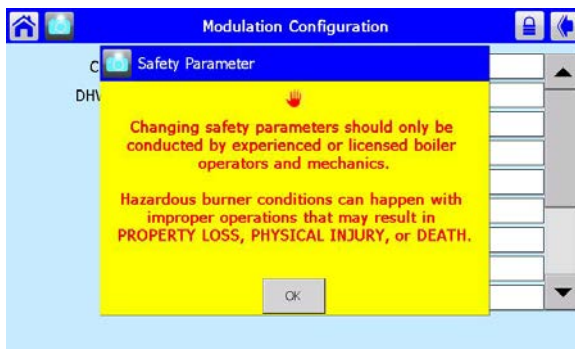

Menu 6. Parameter Safety Warning

⚠WARNING

Changing safety parameters should only be conducted by experienced, licensed boiler operators and mechanics. Hazardous burner conditions can happen with improper operations that may result in PROPERTY LOSS, PHYSICAL INJURY, or DEATH.

Press OK to continue. The system will ask you to login before you make a change. (For more information on logging in, see Section 8.2.)

2. If you make a change in any group that could affect the safe operation of the unit, the control system will ask you to “verify” the change before it is accepted.
3. Once all parameters have been changed, return to the configure menu. In the lower right hand corner of the screen you will see ‘VERIFY’ Press VERIFY, then press BEGIN to start verification.

Notes –

- Once you change one of these safety-related parameters, you **must** finish the verification process for the group that includes the parameter, **or the control system will not let the boiler operate**. You can wait to do the verification until you have changed parameters in other groups, but before you return the boiler to service, you must complete the verification process for all groups that have been changed.
- At the end of the verification process, you must press the Reset button on the front of the controller. See Figure 34. You have to do this within 30 seconds, or the verification will be cancelled. To make it easy to reach the Reset button, open the door on the front of the boiler and slide out the control panel **before** beginning the verification.



Figure 34. Reset Button on Controller

4. The system will present a listing for each group of parameters that need verification See Menu 7.



Menu 7. Safety Parameter Confirmation

- For each group, check the list carefully. Press Yes if all of the parameters in the group have been entered correctly. For each group, you are given 30 seconds to select Yes/No. A count-down timer is shown at the bottom of the screen.
If you made changes in other safety-related groups, verify the entries in those groups in the same way. Do this until the following screen shows



Menu 8. Safety Parameter Reset

- When the process is complete, the system will tell you to reset the control system. The Reset button is located on the front of the controller. You must press the Reset button within 30 seconds, or the verification will be cancelled. A count-down timer is shown at the bottom of the screen.

Checking Individual Parameters

- From the 'Home' screen (Menu 9), press the icon for the controller.



Menu 9. 'Home' screen

- The Status Summary page for the controller will appear. This shows the current operating condition of the controller, and also shows some of the configuration settings. See Menu 10

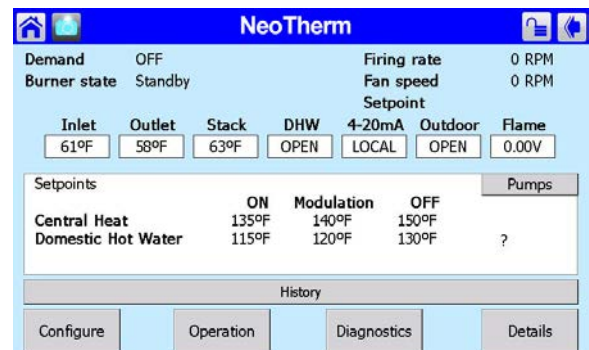

Menu 10. Status Summary Screen

Notice the four buttons at the bottom of each Status Summary screen:

- Configure – Allows an installer to change some of the setup parameters used by the system. A password may be required.
- Operation – Used to adjust the setpoints, change the fan speed, turn a burner on or off, or turn the pumps on or off.
- Diagnostics – Allows you to run diagnostic tests, or check the inputs and outputs used by the system.
- Details – Allows you to check the status of all of the setup parameters on the control system.

Configuring Parameters

In this section, we will give you a quick explanation of how to change parameters on the controller.

1. From the Home Page screen (Menu 11), press the icon for the controller.



Menu 11. Home Page Screen

2. The Status Summary page for that controller will appear. See Menu 12

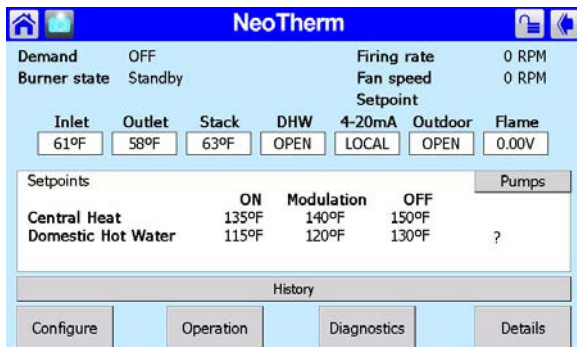

Menu 12. Status Summary Screen

3. Press the Configure button to start a configuration session for the controller.



Menu 13. Configuration Screen

This screen lists all of the configuration groups that will be outlined in Section 9.

Setting the Date and Time on the System Display

The display includes an internal clock, which keeps track of the date and time. This setting is important, because log entries for Lockouts and Alerts include time listings. If the Date and Time setting for the boiler is not correct, the listings in the Lockout and Alert logs will be incorrect.

To set the clock:

1. Start at the 'Home' screen.



Menu 14. 'Home' screen

2. Press the Setup button on the lower right corner of the screen. The system will present the Setup screen.

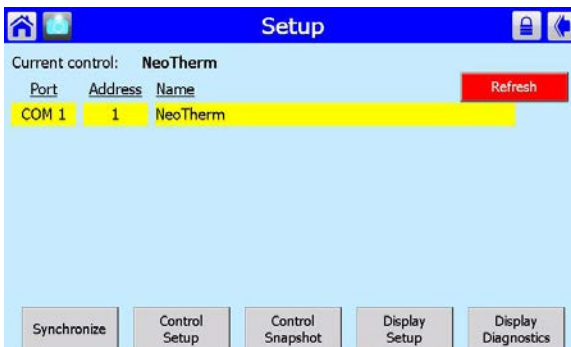

Menu 15. Setup Screen

3. Press the Display Setup button at the bottom of the screen.

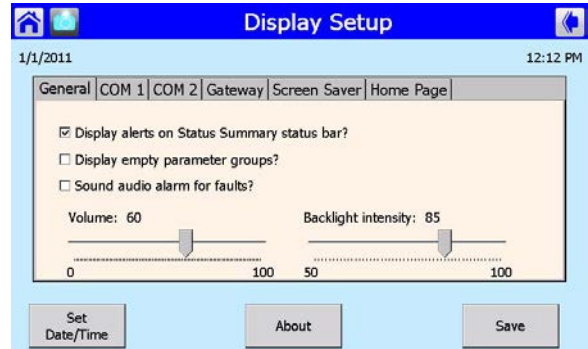

Menu 16. Display Setup Screen

4. Press 'Set Date/Time' button.

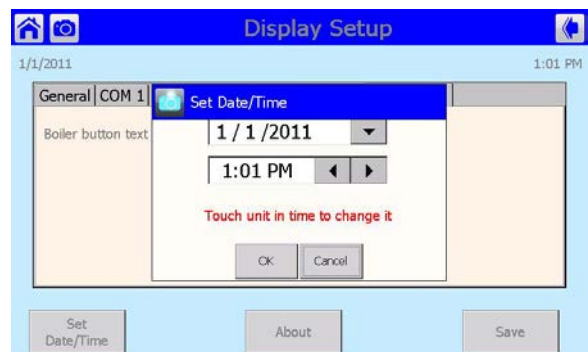

Menu 17. Date and Time

5. Use the arrows to change the date and time, and then press the OK button.

Battery

The display has a removable battery (CR2032) to store time, date, lockout, and alerts in the event of a power failure. It has an expected lifetime of 10 years. The battery can be accessed from the back of the Touchscreen display.

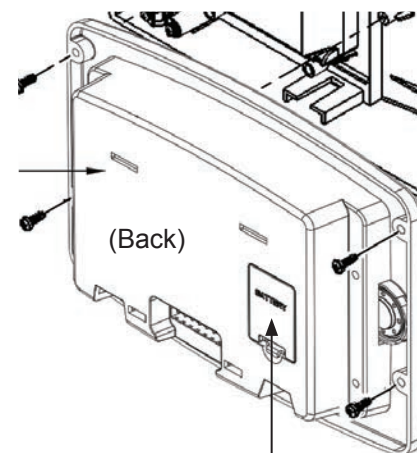

Battery (CR2032)

Configuration Sub-Menus (ALL)



Menu 18. Home Screen

To navigate to the Configuration Menu Screen, first touch the controller icon on the home screen to access the Status Summary screen,

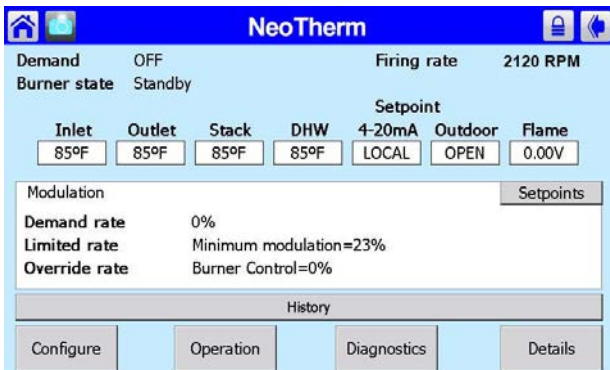

Menu 19. Status Summary Screen

From the Status Summary Screen, touch the 'Configure' button on the bottom left, to access the Configuration Menu.

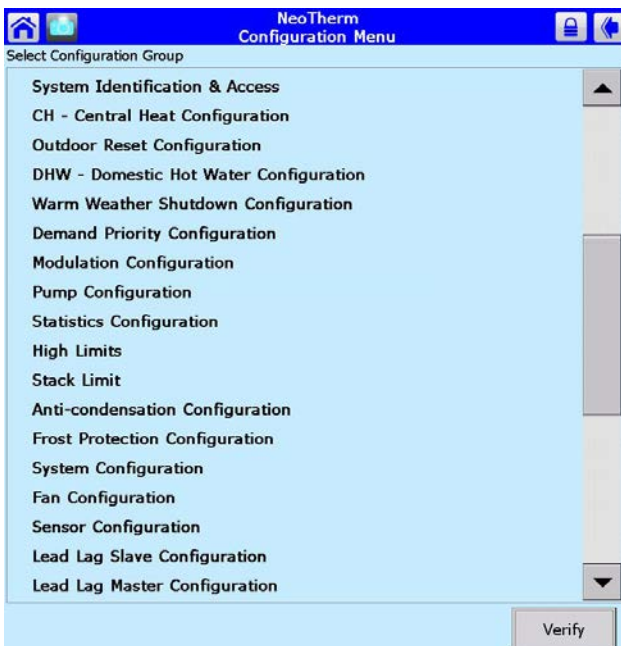

Menu 20. Configuration Menu

System Identification & Access

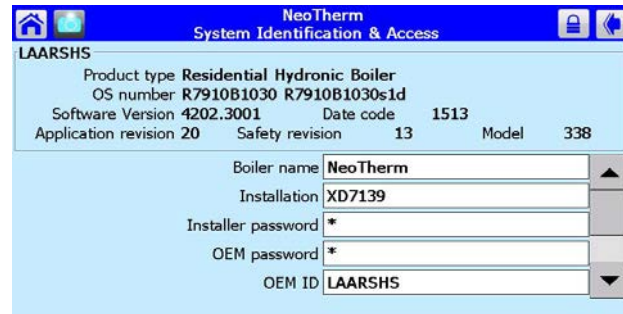

This sub-menu will display information regarding software, date codes, model numbers and program name, as well as giving the installer access to re-name the boiler and to change the modbus addresses for lead lag operation.

CH - Central Heat Configuration

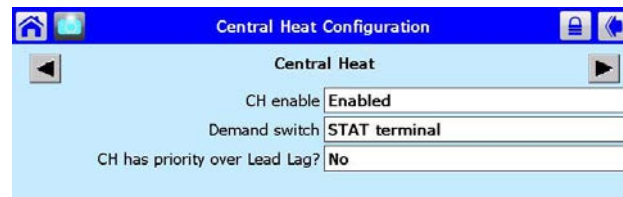

When using the NeoTherm for hydronic heating, a call for heat must be supplied to the "T-T" terminals found on TB7 labeled "T-T or Interlock". Once a call for heat is established, the control will start the appropriate (selected) pumps, and begin the ignition process. From the "Home" screen touch the Sola icon, then press "Configure". Choose 'CH-Central Heat Configuration to make adjustments to setpoint, and modulation for a single boiler CH demand.

Outdoor Reset Configuration

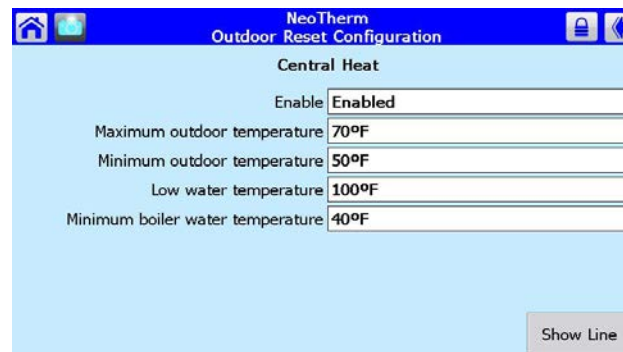

Description of Outdoor Sensor

DHW - Domestic Hot Water Configuration

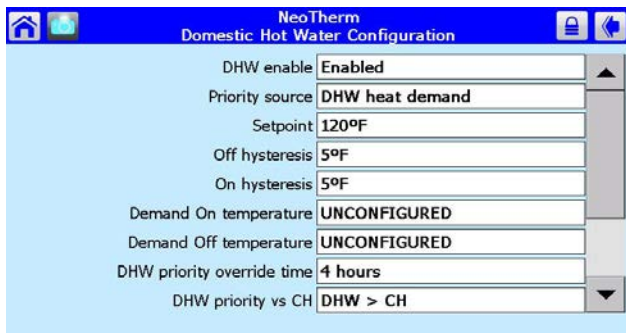

DHW - Domestic Hot Water is used to configure the DHW temperature parameters for water heaters (NTV) and for indirect water heaters that are used with boiler (NTH) systems.

Warm Weather Shutdown Configuration

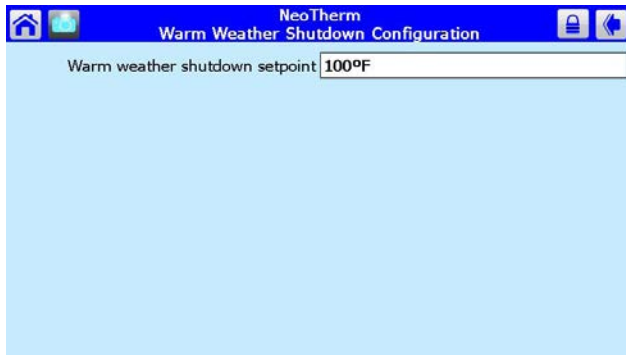

From this sub-menu you will be able to enable/disable the Warm Weather Shutdown feature and adjust the set point.

Demand Priority Configuration

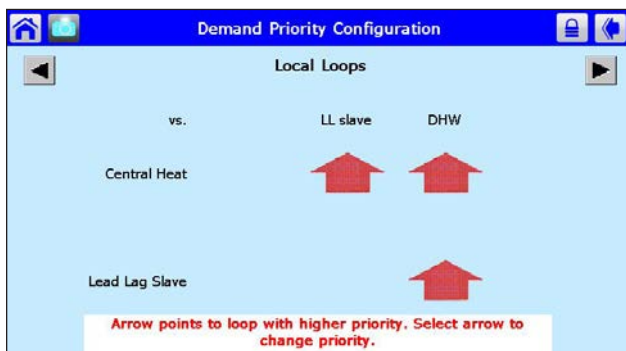

From the Demand Priority Configuration, the installer can adjust the priority of the different demand types.

- Central Heat
- Domestic Hot Water
- Lead Lag

The control uses arrows as indicators to point to the loop with higher priority.

Modulation Configuration



From this sub-menu the installer has the ability to adjust the range of modulation for the CH, and DHW demands. NeoTherm is designed with a 5:1 turn down ratio. Any change to the minimum and maximum modulation rates will affect the overall ratio of the boiler. The installer level password will allow changes to these parameters. Consult the factory if an adjustment is needed to any of these parameters.

Pump Connections

The controller in the NeoTherm energizes the pump contacts when it receives a call for heat. Once the call for heat is satisfied, the pump will remain on for the defined pump overrun time.

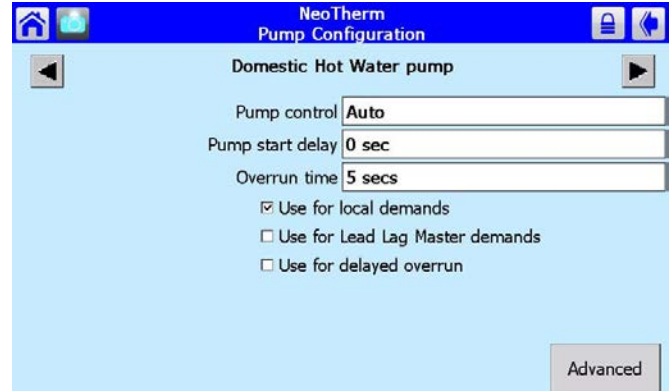

The Boiler Pump terminals (TB5 - max 7.4 FLA) are fed by 120V (violet wire) internally from the main power feed. The System and DHW contacts are dry contacts. Appropriate voltage must be supplied to the System and DHW pumps for proper operation.

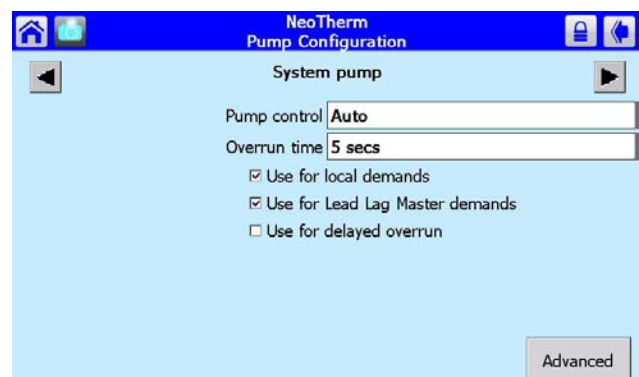

Pump Connections (cont)

The System pump connections are located on terminal block 5 (TB5) in the control panel. The System pump contacts are rated for 120Vac, 7.4 Amps. To use the contacts, power must be supplied on one terminal with the other terminal wired to the pump or a relay controlling the pump.

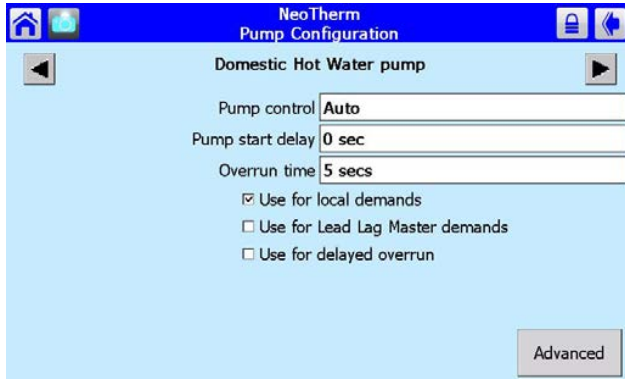

The DHW pump connections are located on terminal block 5 (TB5) in the control panel and are rated for 120Vac, 7.4 Amps. To use the contacts, power must be supplied on one terminal, and the other terminal wired to the pump or a relay controlling the pump.

Additional 120VAC circuits may be required for the pumps.

Statistics Configuration

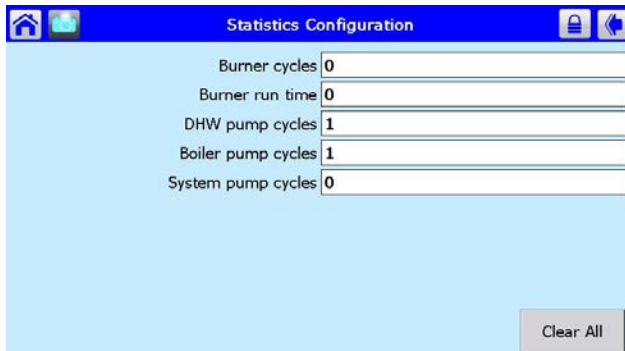

The statistics configuration sub-menu allows the installer to view Burner Cycles, Burner Run Time, DHW Pump Cycles, Boiler Pump Cycles, and System Pump Cycles.

This sub-menu is 'Read-Only'

High Limits

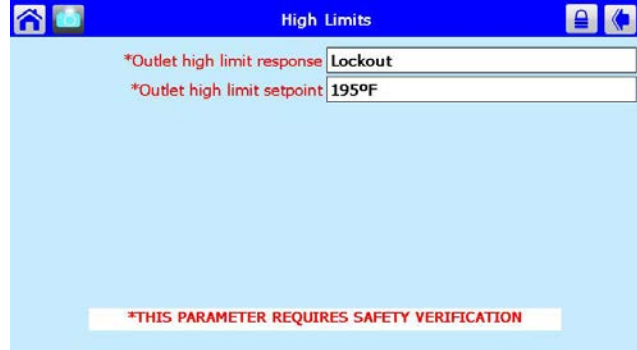

The outlet High limit can be adjusted using the installer password. After a change is made, the control will lockout and require a Safety Verification (see Section 9.3 for more details on Safety Verification).

Stack Limits

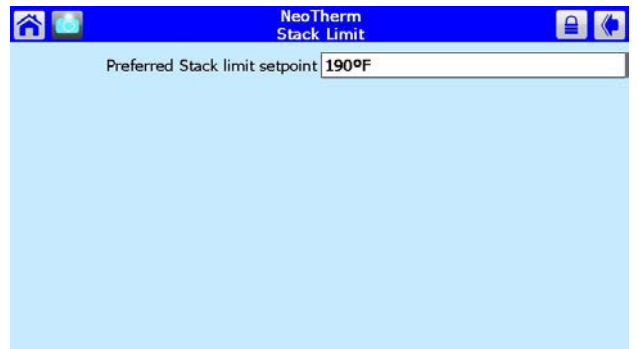

Anti-Condensation Configuration

Anti-condensation (frost protection) is enabled/disabled on this screen

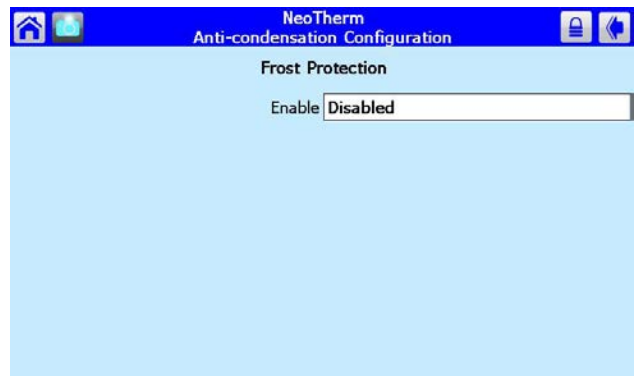



H2374200-