

## Instructions for Models:

### SI-F002

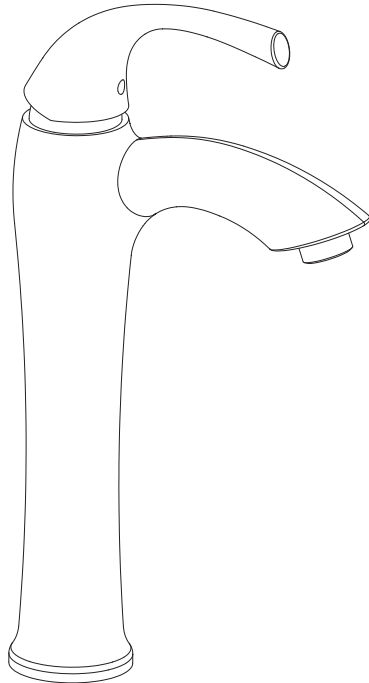

### Need Help?

For additional assistance or service call:

**SPEAKMAN** Company  
400 Anchor Mill Road  
New Castle, DE 19720

PHONE: 800-537-2107  
EMAIL: [customerservice@speakmancompany.com](mailto:customerservice@speakmancompany.com)  
WEB: [www.speakmancompany.com](http://www.speakmancompany.com)

92-SI-F002-R1

## What You Need To Know:

### Tools: Required:

\*Adjustable  
Wrench



\*Groove Joint  
Pliers

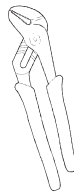

\*Phillips  
Screwdriver

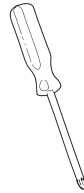

\*Teflon Tape



### Helpful:

\*Supply Lines



\*Basin Wrench

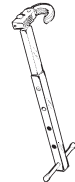

\*Pipe Wrench



\*Hacksaw

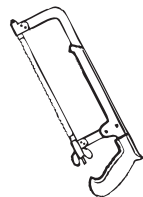

\*Tubing Cutter

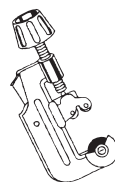

\*Utility Knife



\*Eye Protection



### Important Notes:

Be sure to read instructions thoroughly before beginning installation. Do not overtighten any connections or damage may occur. This faucet has an operating range of 20-80 psi.

### Safety Tips:

Cover your drain to prevent loss of parts.  
Be sure to wear eye protection while cutting pipe.

### Maintenance:

Your new Lavatory Faucet is designed for years of trouble-free performance. Keep it looking new by cleaning it periodically with a soft cloth. Avoid abrasive cleaners, steel wool, and harsh chemicals as these will dull the finish and void your warranty.

③ Make connections to water lines. Use 1/2" IPS faucet connections (1), or use 3/8" O.D. ball nose risers (2) with coupling nuts (3). Use wrenches to tighten connections. Take care to not overtighten.

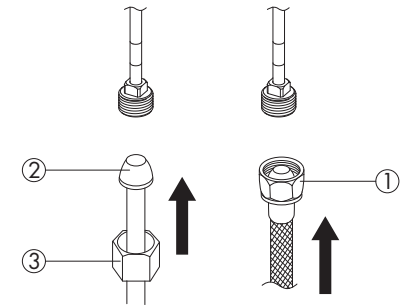

① Shut off water supplies. Remove old faucet. Clean sink surface in preparation for installation of new faucet. Place Faucet Body (1) and Slip Ring (2) as shown below.

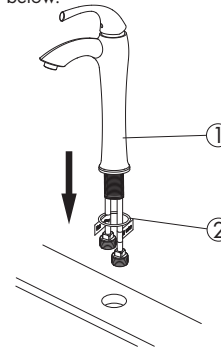

④ Insert Drain Body (1) into drain hole of sink from above. From underneath install Rubber Gasket (2), Red Fiber Washer (3), and Lock Nut (4) in the order shown below. Secure Lock Nut with Groove Joint Pliers. Take care to not overtighten.

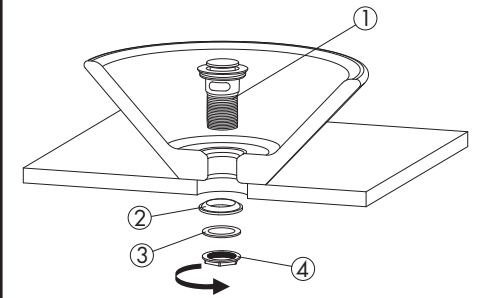

② Slide Rubber Washer (1), and Metal Washer (2) onto threaded shank of faucet. Thread Mounting Nut (3) onto faucet shank until hand tight. Use phillips screwdriver to tighten Mounting Screws (4), securing the faucet to the sink.

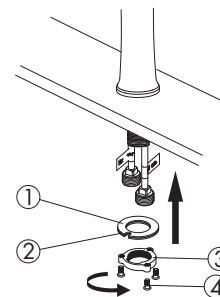

⑤ Install Rubber Washer (2) between Lower Drain Pipe (3) and Drain Body (1). Thread Lower Drain Pipe (3) onto Drain Body (1).

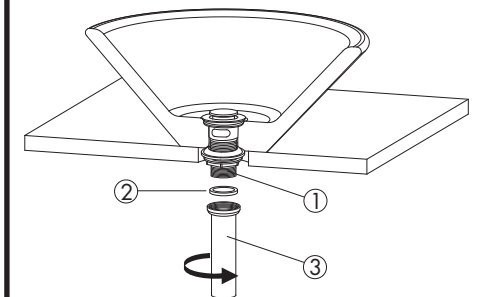

6

**IMPORTANT:**

After installation is completed, remove aerator. Turn on water supply and allow both hot and cold water to run for at least one minute each to remove the debris. While water is running, check for leaks. Replace aerator.

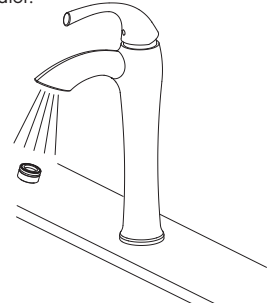

- ① RPG04-0417
- ② RPG05-0917
- ③ RPG05-0915
- ④ RPG45-0058

