

INSTALLATION

CAUTION

1. Installer must be a trained, experienced serviceman.
2. Disconnect power supply before making wiring connections to prevent electrical shock and equipment damage.
3. All wiring must comply with applicable codes and ordinances.
4. Do not exceed the ratings given in the Specifications section.
5. Always conduct a thorough checkout when installation is complete.

ORDERING INFORMATION

WHEN ORDERING REFER TO THE TRADELINE CATALOG OR PRICE SHEETS FOR COMPLETE ORDERING SPECIFICATION NUMBER, OR . . .

SPECIFY—

1. MODEL NUMBER.
2. ADDITIVE OR SUBTRACTIVE DIFFERENTIAL (PA404A) SEE TABLE I.
3. ACCESSORY, IF DESIRED.

ORDER FROM—

1. YOUR USUAL SOURCE, OR
2. HONEYWELL
1885 DOUGLAS DRIVE, NORTH
MINNEAPOLIS, MINNESOTA 55422
(IN CANADA—HONEYWELL CONTROLS LIMITED
740 ELLESMERE ROAD
SCARBOROUGH, ONTARIO)
INTERNATIONAL SALES AND SERVICE OFFICES
IN ALL PRINCIPAL CITIES OF THE WORLD.

MOUNTING

The PA404A must be located above the water line in a steam boiler, either adjacent to a pressure gauge or in another location recommended by the boiler manufacturer. See Fig. 1.

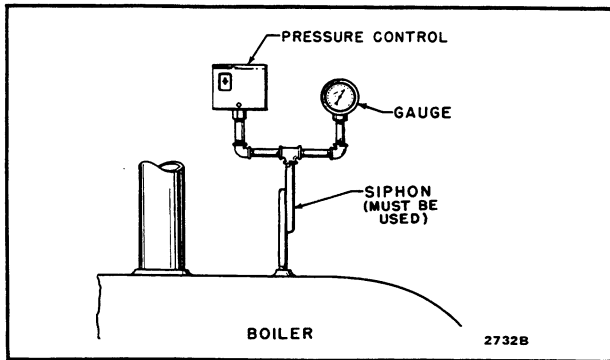

FIG. 1—TYPICAL INSTALLATION OF THE PA404A, MOUNTED WITH A GAUGE ON A BOILER.

The PA404B must be mounted in the steam line ahead of the unit heater. See Fig. 2.

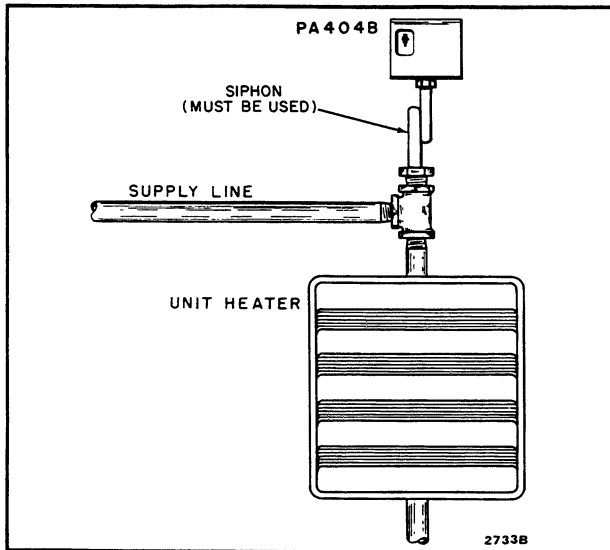

FIG. 2—TYPICAL INSTALLATION OF THE PA404B, MOUNTED ON THE SUPPLY LINE OF A UNIT HEATER.

A siphon must always be connected between the unit and the boiler or steam line. The siphon acts as a trap to prevent corrosive vapors or scale, resulting from the use of boiler compounds, from damaging the control.

WIRING

CAUTION

Disconnect power supply before making wiring connections to avoid electrical shock or equipment damage.

All models are equipped with 2 terminals located on the switch, inside the cover. A wiring hole is provided for 1/2-inch rigid or flexible conduit. All wiring must comply with local electrical codes. See Figs. 3, 4, and 5 for typical wiring connections.

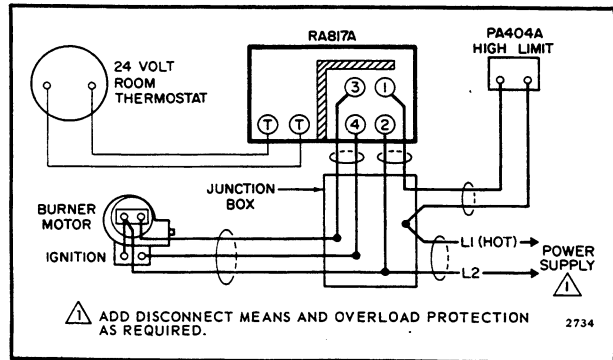

FIG. 3—TYPICAL CONNECTIONS FOR A PA404A USED AS A HIGH LIMIT IN AN OIL-FIRED STEAM SYSTEM.

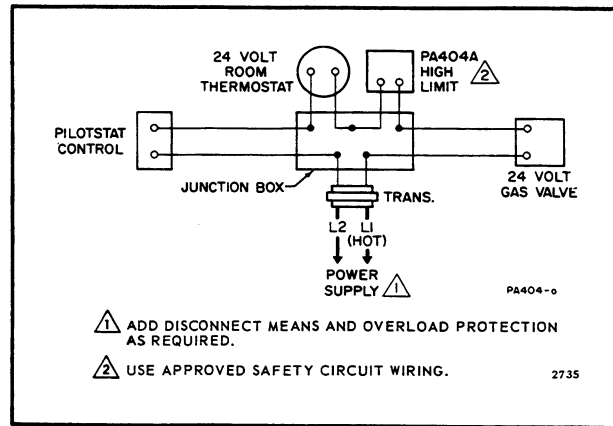

FIG. 4—TYPICAL CONNECTIONS FOR A PA404A USED AS A HIGH LIMIT IN A GAS-FIRED STEAM SYSTEM.

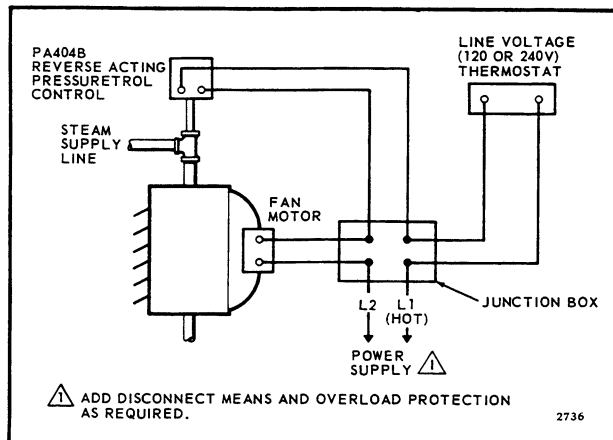

FIG. 5—TYPICAL CONNECTIONS FOR A PA404B USED IN A UNIT HEATER INSTALLATION.

SETTINGS

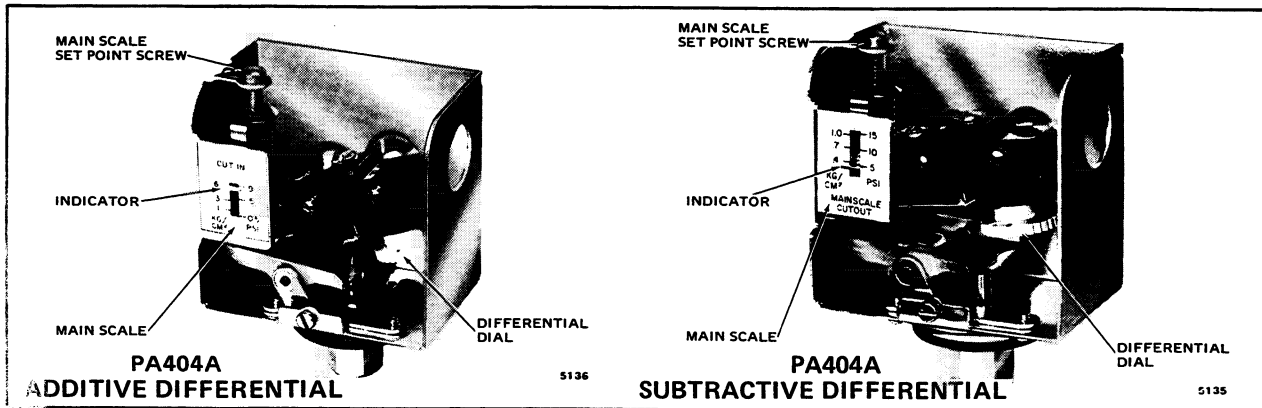

FIG. 6—COVER-OFF VIEW OF PA404, SHOWING ADJUSTMENT SCREWS.

See "Switch Action" in Table 1.

TO SET THE PA404A WITH SUBTRACTIVE DIFFERENTIAL

1. Set main scale indicator at desired cutout point by turning main scale set point screw until indicator (see Fig. 6) corresponds to pressure at which electric circuit should break. The recommended minimum set point is the differential setting plus 1-1/2 psi.

2. Set the differential adjustment dial to the number of pounds that pressure should fall below the main scale cutout point before the circuit makes.

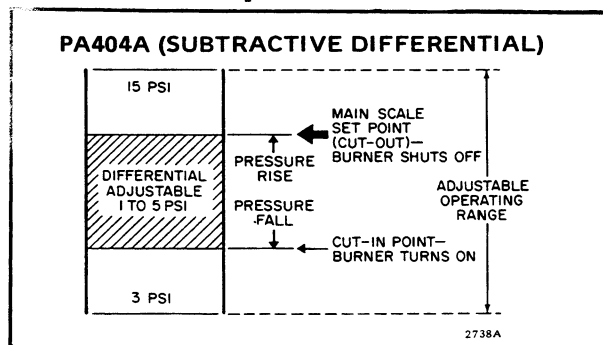
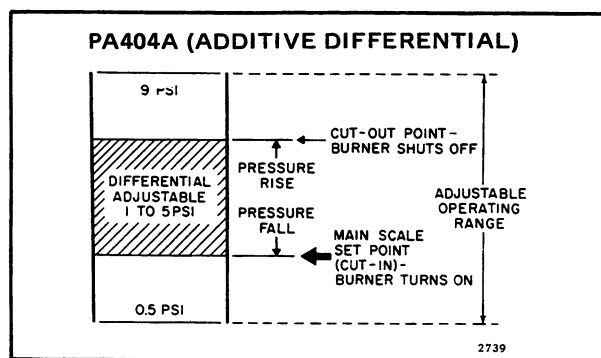

TO SET THE PA404A WITH ADDITIVE DIFFERENTIAL

1. Set main scale indicator at desired cut-in point by turning main scale set point screw until indicator (see Fig. 6) corresponds to pressure at which electric circuit should make.

2. Set differential adjustment dial to number of pounds that pressure should rise above main scale cut-in point before the electric circuit breaks.

TO SET THE PA404B WITH ADDITIVE DIFFERENTIAL

1. Set main scale indicator at desired cutout point by turning main scale set point screw until indicator (see illustration below) corresponds to pressure at which electric circuit should break.

2. Set differential adjustment dial to number of pounds that pressure should rise above main scale cutout point before electric circuit makes.

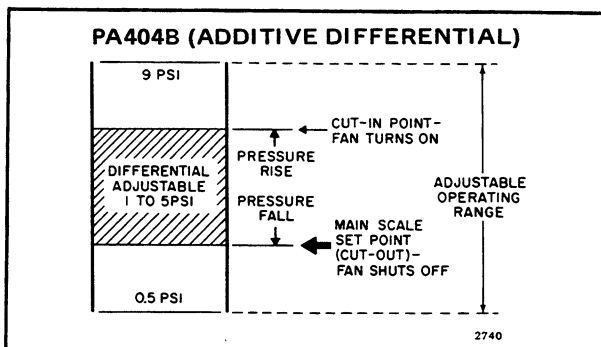

CHECKOUT

Operate equipment through at least 1 complete cycle to make certain equipment is controlled as intended.