



SECTION 2

FOOT & CHECK VALVES

YARD HYDRANTS



PRODUCT LINE	PAGE
Check Valves	
NL Brass, Brass, Bronze, Stainless Steel	1-4
Clayton Mark	7-9
Plastic	15
Simmons	11-12
Foot Valves	
NL Brass, Brass, Bronze, Stainless Steel	5-6
Cast Iron, Steel Suction Strainer	16
Clayton Mark	10
Plastic	15
Simmons	13
Yard Hydrants	17-20





Check Valves - NO LEAD Brass, Bronze, Stainless Steel

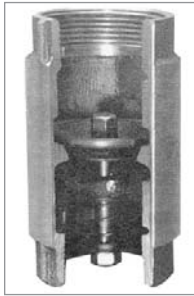

CHECK VALVE Features:

- NO LEAD cast brass, bronze body & poppet.
- Buna-N o-ring.
- Stainless steel springs, washers, locknuts.
- Delrin poppet stem guide.
- 200 psi WOG working pressure.
- 300 lb. max hang weight (down pull) tension.
- For use in water well systems.
- Individually cartoned.
- Third party certified to NSF/ANSI 372.

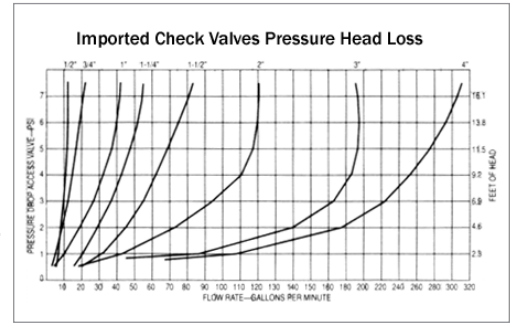

CVNL-BS Series

CVNL-BS Series NO LEAD BRASS Check Valves

- Rough body finish.
- For cold water applications only.

Part Number	Size	Ctn Qty	List Price
CVNL50BS	1/2"	100	\$ 12.46
CVNL75BS	3/4"	80	16.89
CVNL100BS	1"	60	24.46
CVNL125BS	1 1/4"	40	33.39
CVNL150BS	1 1/2"	30	44.46
CVNL200BS	2"	20	73.04
CVNL300BS	3"	6	334.82
CVNL400BS	4"	3	631.61



CVNL-B Series

CVNL-B Series NO LEAD BRONZE Check Valves

- Machined body finish.
- For cold water applications only.

Part Number	Size	Ctn Qty	List Price
CVNL50B	1/2"	100	\$ 17.32
CVNL75B	3/4"	80	23.04
CVNL100B	1"	60	33.75
CVNL125B	1 1/4"	40	44.11
CVNL150B	1 1/2"	30	64.11
CVNL200B	2"	20	105.54
CVNL300B	3"	6	396.25



SSCV Series

SSCV Series STAINLESS STEEL Check Valves

- 304 cast stainless steel casting, springs, washers, lock nut.
- Viton o-ring.
- For cold water applications only.

Part Number	Size	Ctn Qty	List Price
SSCV50	1/2"	100	\$ 22.32
SSCV75	3/4"	80	30.18
SSCV100	1"	60	40.36
SSCV125	1 1/4"	40	53.39
SSCV150	1 1/2"	30	74.82
SSCV200	2"	20	128.39
SSCV300	3"	6	493.39
SSCV400	4"	3	910.54
SSCV1025	1" fpt x 1 1/4" mpt	60	55.89



Check Valves - NO LEAD Brass

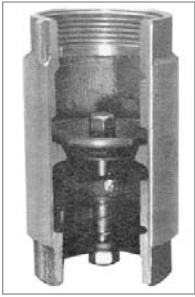

CHECK VALVE Features:

- NO LEAD cast brass or stainless steel body & poppet.
- Buna-N o-ring.
- Stainless steel springs, washers, locknuts.
- Delrin poppet stem guide.
- 200 psi WOG working pressure.
- 300 lb. max hang weight (down pull) tension.
- For use in water well systems.
- Individually cartoned.
- Third party certified to NSF/ANSI 372.

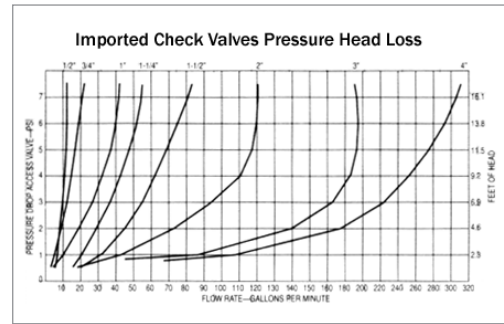

CVXLDNL Series

CVXLDNL Series NO LEAD BRASS Check Valves

- Rough body finish.
- Extra long at discharge end.
- For cold water applications only.

Part Number	Size	Ctn Qty	List Price
CVXLDNL100BS	1" x 1"	60	\$ 42.68
CVXLDNL125BS	1 1/4" x 1 1/4"	40	49.04



CVMNL-BS Series

CVMNL-BS Series NO LEAD BRASS Submersible Check Valves

- Rough body finish.
- FPT x MPT
- For cold water applications only.

Part Number	Size (FPT X MPT)	Ctn Qty	List Price
CVMNL100BS	1" x 1"	60	\$ 41.43
CVMNL125BS	1" x 1 1/4"	40	44.11
CVMNL1252BS	1 1/4" x 1 1/4"	60	47.68



CVMXLNL Series

CVMXLNL Series NO LEAD BRASS Submersible Check Valves

- Rough body finish.
- Extra long body.
- For cold water applications only.

Part Number	Size (M X F)	Ctn Qty	List Price
CVMXLNL100BS	1" x 1"	60	\$ 38.39
CVMXLNL125BS	1 1/4" x 1 1/4"	40	48.75





Check Valves - NO LEAD Brass



CHECK VALVE Features:

- NO LEAD cast brass body & poppet.
- Buna-N o-ring.
- Stainless steel springs, washers, locknuts.
- Delrin poppet stem guide.
- 200 psi WOG working pressure.
- 300 lb. max hang weight (down pull) tension.
- For use in water well systems.
- Individually cartoned.
- Third party certified to NSF/ANSI 372.

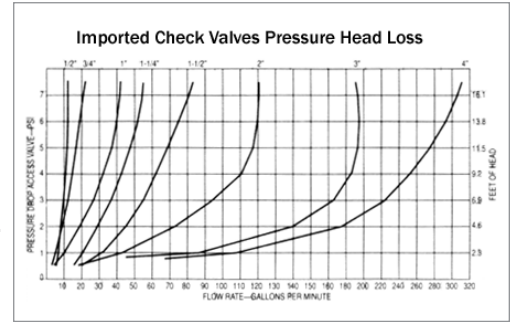

CVTNL-1B Series

CVTNL-1B Series NO LEAD BRASS Single Tap Check Valves

- 1/8" inlet tap.
- For cold water applications only.

Part Number	Size	Ctn Qty	List Price
CVTNL1001BS	1"	60	\$ 37.32
CVTNL1251BS	1 1/4"	40	50.36



CVTNL-2BS Series

CVTNL-2BS Series NO LEAD BRASS Double Tap Check Valves

- One 1/8" inlet tap.
- One 1/4" outlet tap.
- For cold water applications only.

Part Number	Size	Ctn Qty	List Price
CVTNL1002BS	1"	60	\$ 34.11
CVTNL1252BS	1 1/4"	40	49.82
CVTNL1502BS	1 1/2"	30	74.50
CVTNL2002BS	2"	20	123.00



CVTNL-3BS Series

CVTNL-3BS Series NO LEAD BRASS Control Center Check Valves

- One 1/8" inlet tap.
- One 1/8" and one 1/4" outlet taps.
- For cold water applications only.

Part Number	Size	Ctn Qty	List Price
CVTNL1003BS	1"	60	\$ 46.25
CVTNL1253BS	1 1/4"	40	60.54



CVCNL-B Series

CVCNL-B Series NO LEAD BRASS Control Center Check Valves

- One 1/8" inlet tap.
- One 1/8" and two 1/4" outlet taps.
- For cold water applications only.

Part Number	Size	Ctn Qty	List Price
CVCNL100BS	1"	60	\$ 42.68
CVCNL125BS	1 1/4"	40	58.93



Check Valves - LEADED Brass

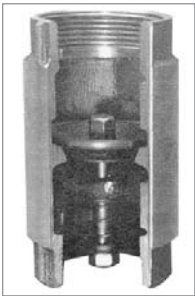

CHECK VALVE Features:

- Cast brass, bronze body & poppet.
- Buna-N o-ring.
- Stainless steel springs, washers, locknuts.
- Delrin poppet stem guide.
- 200 psi WOG working pressure.
- 300 lb. max hang weight (down pull) tension.
- For use in water well systems.
- Individually cartoned.
- Imported.

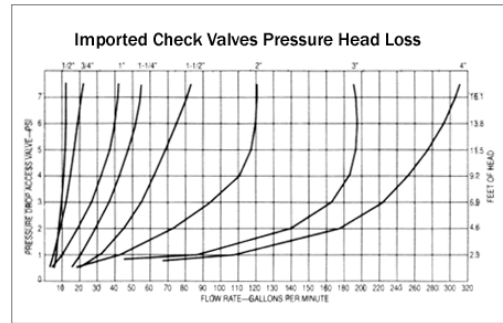

CV-BS Series

CV-BS Series LEADED BRASS Check Valves

- Rough body finish.
- For cold water applications only.

Part Number	Size	Ctn Qty	List Price
CV50BS	1/2"	100	\$ 7.79
CV75BS	3/4"	80	10.50
CV100BS	1"	60	14.14
CV125BS	1 1/4"	40	21.96
CV150BS	1 1/2"	30	34.82
CV200BS	2"	20	59.67



CAUTION
DO NOT USE WITH
POTABLE WATER



Foot Valves - NO LEAD Brass, Bronze, Stainless Steel



FOOT VALVE Features:

- NO LEAD Cast Brass, bronze or stainless steel body & poppet.
- Buna-N o-ring (Viton on stainless steel).
- Stainless steel springs, washers, locknuts and strainers.
- 200 psi WOG working pressure.
- For use in water well systems.
- Individually cartoned.
- Third party certified to NSF/ANSI 372.

FVNL Series LEAD FREE BRASS Foot Valves

- Rough body finish.
- For cold water applications only.

Part Number	Size	Enters Pipe	Ctn Qty	List Price
FVNL50BS	1/2"	1 1/4"	100	\$ 13.39
FVNL75BS	3/4"	1 1/2"	80	14.93
FVNL100BS	1"	2"	60	23.04
FVNL125BS	1 1/4"	2 1/2"	40	28.29
FVNL150BS	1 1/2"	3"	30	42.68
FVNL200BS	2"	3 1/2"	20	67.32
FVNL300BS	3"	5"	8	256.96
FVNL400BS	4"	-	4	462.50



FVNL-BS Series



FVNL-B Series

FV-B Series NO LEAD BRONZE Foot Valves

- For cold water applications only.

Part Number	Size	Enters Pipe	Ctn Qty	List Price
FVNL50B	1/2"	1 1/4"	100	\$ 15.18
FVNL75B	3/4"	1 1/2"	80	19.11
FVNL100B	1"	2"	60	26.96
FVNL125B	1 1/4"	2 1/2"	40	38.75
FVNL1251B	1 1/4"	2"	50	37.32
FVNL150B	1 1/2"	3"	30	55.89
FVNL200B	2"	3 1/2"	20	89.11
FVNL300B	3"	5"	8	328.39
FVNL400B	4"	-	4	567.86



FVNL-B Series

FV-B Series NO LEAD BRONZE Dual Purpose Foot Valves

- For cold water applications only.

Part Number	Size	Enters Pipe	Ctn Qty	List Price
FVNL100125B	1" FPT x 1 1/4"MPT	2"	60	\$ 36.61



SSFV Series

SSFV Series STAINLESS STEEL Foot Valve Features:

- 304 Stainless steel casting, spring, washer, locknut, strainer
- Viton o-ring.
- For cold water applications only.

Part Number	Size	Enters Pipe	Ctn Qty	List Price
SSFV50	1/2"	1 1/4"	100	\$ 17.96
SSFV75	3/4"	1 1/2"	80	30.18
SSFV100	1"	2"	60	43.74
SSFV125	1 1/4"	2 1/2"	40	54.97
SSFV150	1 1/2"	3"	30	67.68
SSFV200	2"	3 1/2"	20	120.54
SSFV300	3"	5"	8	511.32
SSFV400	4"	-	4	1038.73



Foot Valves - LEADED Brass



FOOT VALVE Features:

- Cast Brass, bronze body & poppet.
- Buna-N o-ring (Viton on stainless steel).
- Stainless steel springs, washers, locknuts and strainers.
- 200 psi WOG working pressure.
- For use in water well systems.
- Individually cartoned.
- Imported.



CAUTION
DO NOT USE WITH
POTABLE WATER



FVR-BS Series

FVR-BS Series LEADED BRASS Foot Valves

- Rough body finish.
- For cold water applications only. ☺ Limited Quantities Available

Part Number	Size	Enters Pipe	Ctn Qty	List Price
FVR50BS ☺	1/2"	1 1/4"	100	\$ 8.09
FVR75BS ☺	3/4"	1 1/2"	80	10.32
FVR100BS ☺	1"	2"	60	13.57
FVR125BS ☺	1 1/4"	2 1/2"	40	18.56

FVSC, CVSP Series Stainless Screen, Endcap, Screw, Spring

- Spring replacement for all imported check and foot valves



FVSC & CVSP Series

Screen/Cap/Screw Part Number	Spring Part Number	Size	FVSC List Price	CVSP List Price
FVSC50	CVSP50	1/2"	\$ 6.36	\$ 2.68
FVSC75	CVSP75	3/4"	6.71	2.68
FVSC100	CVSP100	1"	7.36	2.68
FVSC125	CVSP125	1 1/4"	8.86	3.36
FVSC150	CVSP150	1 1/2"	9.11	3.36
FVSC200	CVSP200	2"	12.04	3.75
FVSC300	CVSP300	3"	43.75	4.43
FVSC400	CVSP400	4"	62.50	4.79



No Lead Check Valves - Clayton Mark

- FOR USE IN WATER WELL SYSTEMS
- Third party certified to NSF/ANSI 372.



6300 No Lead Brass Check Valve

Features:

- The Buna-N rubber coated poppet seals under high & low pressure applications.
- Delrin Stem Guide to improve flow.
- Self locking nut is vibration proof.
- Stainless steel spring.
- 400 PSI rated (WOG).
- For cold water applications only.
- Hex ends for easy installation.

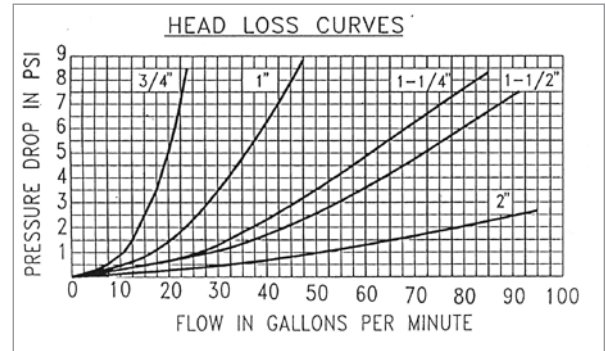

Part Number	Size	Enters Casing	Ctn Qty	List Price
6300-3/4	3/4"	1-1/2"	48	\$ 40.44
6300-1	1"	2"	35	44.03
6300-11/4	1-1/4"	2-1/2"	24	60.38
6300-11/2	1-1/2"	3"	20	88.62
6300-2	2"	3-1/2"	12	138.83



5300 No Lead Brass Check Valve Features:

- Highly finished no lead brass body with a flat seated poppet to withstand increased water pressure for a continuous period of time.
- 400 PSI (W.O.G.)
- For cold water applications only.
- Corrosion resistant, stainless steel poppet core on 5300-1/2".
- No Lead Brass poppet on 5300-2 1/2, 3 & 4".
- Not suitable for all types of oil and gas.
- Heavy hex ends for easy installation.

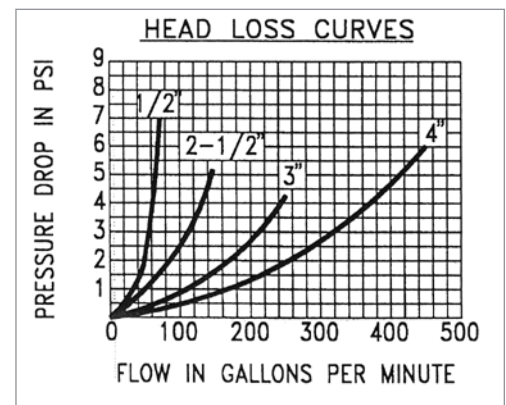

NO LEAD Part Number	Leaded Part Number	Size	Enters Casing	Ctn Qty	NO LEAD List Price	Leaded List Price
5300-1/2		1/2"	1-1/2"	48	\$ 41.30	
5300-21/2		2-1/2"	5"	1	570.18	
5300-3		3"	6"	1	788.32	
5300-4	L5300-4 *	4"	8"	1	1370.45	309.53

* Valve is leaded bronze. Do not use for potable water.



www.americangranby.com

8/21/18

In the United States: Phone (800) 776-2266 Fax (800) 729-3299
 In Canada: Phone (800) 268-7570 Fax (905) 629-3204

No Lead Check Valves - Clayton Mark



- FOR USE IN WATER WELL SYSTEMS
- Third party certified to NSF/ANSI 372.



CLAYTON MARK®



6300-1 No Lead Brass One Hole Control Center

- 1/8"-27NPS tapping on inlet side for snifter valve.
- NOTE: 2-1/2 inch size has the 5300 poppet design.

Part Number	Size	Ctn Qty	List Price
63001-1	1"	35	\$ 59.46
63001-11/4	1-1/4"	30	78.54
63001-11/2	1-1/2"	20	104.10
63001-2	2"	12	164.84



6300-2 No Lead Brass Two Hole Control Center

- 1/8"-27NPS tapping on inlet side for snifter valve.
- 1/4"-18NPS tapping on outlet side for pressure switch.
- NOTE: 4 inch has the 5300 poppet design.

Part Number	Size	Ctn Qty	List Price
63002-1	1"	35	\$ 60.23
63002-11/4	1-1/4"	30	83.17
63002-11/2	1-1/2"	20	107.97
63002-2	2"	12	167.34



63000218 No Lead Brass Two Hole Control Center

- Two 1/4"-18NPS tappings on outlet side.

Part Number	Size	Ctn Qty	List Price
6300218-1	1"	35	\$ 60.51
6300218-11/4	1-1/4"	30	87.88



6300-3 No Lead Brass Three Hole Control Center

- 1/8"-27NPS tapping on inlet side for snifter valve.
- 1/4"-18NPS tapping on outlet side for pressure switch.
- 1/4"-18NPS tapping on outlet side for pressure gauge.

Part Number	Size	Ctn Qty	List Price
63003-1	1"	35	\$ 56.55
63003-11/4	1-1/4"	30	91.74



No Lead Check Valves - Clayton Mark

- FOR USE IN WATER WELL SYSTEMS
- Third party certified to NSF/ANSI 372.



CLAYTON MARK®



6300-4 No Lead Brass Four Hole Control Center

- 1/8"-27NPS tapping on inlet side for snifter valve.
- 1/4"-18NPS tapping on outlet side for pressure gauge.
- 1/4"-18NPS tapping on outlet side for pressure switch.
- 1/8" tapping on outlet side for drain(1/8" brass plug furnished).

Part Number	Size	Ctn Qty	List Price
63004-1	1"	35	\$ 60.41
63004-11/4	1-1/4"	30	82.95



6302 No Lead Brass Submersible Check Valves

- Fits directly on pump discharge.

Part Number	Size (mpt x fpt)	Ctn Qty	List Price
6302-11/4x1	1-1/4" x 1"	30	\$ 44.33
6302-11/4x11/4	1-1/4" x 1-1/4"	30	59.00
6302-2x2	2" x 2"	12	162.04
6302-3x3	3" x 3"	1	670.67
6302-4x4	4" x 4"	1	1093.62



479 No Lead Brass BREMER CHECK VALVES

- Non corrosive no lead brass with tapered seat and poppet with Perma-Kleen facing for positive seal.
- Uses a tapered rubber packer to seal in the well bore.

Part Number	Size	Ctn Qty	List Price
8669A	2"	12	\$ 68.23
8034C	2" Rubber Check Packer		11.17

No Lead Foot Valves - Clayton Mark



- FOR USE IN WATER WELL SYSTEMS
- Third party certified to NSF/ANSI 372.



CLAYTON MARK®

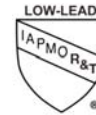

6340 SERIES No Lead Brass Foot Valves

- 400 PSI rating. (W.O.G.)
- Tapered ABS strainer.
- Corrosion resistant, stainless steel core with exclusive cup shape.
- For cold water applications only.
- Jam proof delrin stem guide.

Part Number	Size	Enters Casing	Ctn Qty	List Price
6340-3/4	3/4"	1-1/2"	48	\$ 36.83
6340-1	1"	2"	35	40.94
6340-11/4	1-1/4"	2"	30	49.38
6340-11/2	1-1/2"	3"	20	79.72
6340-2	2"	3-1/2"	12	126.48



5340 SERIES No Lead Brass Foot Valves

- No. 8 perforated stainless steel screen strainer.
- 400 PSI rating.
- Corrosion resistant, stainless steel core with exclusive cup shape.
- For cold water applications only.

Part Number	Size	Enters Casing	Ctn Qty	List Price
5340-3/4	3/4"	1 1/4"	48	\$ 40.54
5340-1	1"	1 1/2"	35	45.06
5340-11/4	1 1/4"	2"	24	54.45
5340-11/2	1 1/2"	2 1/2"	20	99.61
5340-2	2"	3 1/2"	12	141.33



5330 Series No Lead Brass Foot Valves

- No 8 perforated stainless steel strainer.
- Heavy hex end.

NO LEAD Part Number	Leaded Part Number	Size	Enters Casing	Ctn Qty	NO LEAD List Price
5330-21/2		2-1/2"	5"	1	\$ 463.50
5330-3		3"	6"	1	662.14
5330-4		4"	6"	1	1050.07

* Valve is leaded bronze. Do not use for potable water.



No Lead Check Valves - Simmons

- FOR USE IN WATER WELL SYSTEMS

* Silicon bronze components contain less than 0.05% (1/20 of 1%) lead.

Simmons



LF5100 Series Silicon Bronze LEAD FREE* check valves

- Silicon bronze cast body and poppet..
- Buna-N o-ring, stainless steel spring, washer and lock nut.
- 400 PSI (WOG working pressure).
- Made in U.S.A.



Part Number	Simmons	Size	Ctn Qty	List Price
LF5100-1/2	501SB	1/2"	50	\$ 55.36
LF5100-3/4	502SB	3/4"	50	56.04
LF5100-1	503SB	1"	50	59.01
LF5100-1LT	513SB	1" w/ Longer Threads	50	61.55
LF5100-11/4	504SB	1 1/4"	36	80.89
LF5100-11/2	505SB	1 1/2"	24	114.45
LF5100-2	506SB	2"	16	182.87
LF5100-21/2	507SB	2 1/2"	1	780.36
LF5100-3	508SB	3"	1	940.47
LF5100-4	509SB	4"	1	1634.95
LF5100-5	510SB	5" w/ MPT both ends	1	2198.65
LF5100-6	511SB	6"	1	2987.97



LF5100A Series Silicon Bronze LEAD FREE* check valves

- Same as 5100 Series plus:
- 1/8" single inlet tapping.
- Made in U.S.A.



Part Number	Simmons	Size	Ctn Qty	List Price
LF5100A1	522SB	1"	50	\$ 75.27
LF5100A11/4	523SB	1 1/4"	36	100.41
LF5100A11/2	524SB	1 1/2"	24	124.21
LF5100A2	525SB	2"	16	196.63



LF5100B Series Silicon Bronze LEAD FREE* Check Valves

- Same as 5100 Series plus:
- With 1/8" Inlet Tapping, 1/4" Outlet Tapplings.
- Made in U.S.A.



Part Number	Simmons	Size	Ctn Qty	List Price
LF5100B3/4	541SB	3/4"	50	\$ 67.29
LF5100B1	542SB	1"	50	80.81
LF5100B11/4	543SB	1 1/4"	36	99.44
LF5100B11/2	544SB	1 1/2"	24	128.78
LF5100B2	545SB	2"	16	199.61
LF5100B3	547SB	3"	1	1377.01

No Lead Check Valves - Simmons



- FOR USE IN WATER WELL SYSTEMS
- * Silicon bronze components contain less than 0.05% (1/20 of 1%) lead.



LF5100C Series Silicon Bronze LEAD FREE* Control Center

- Made in U.S.A.



Part Number	Simmons	Size	Inlet Tap	Outlet Tap	Ctn Qty	List Price
LF5100C1	601SB	1"	1/8" (1)	1/4" (2)	1	\$ 80.98
LF5100C11/4	602SB	1 1/4"	1/8" (1)	1/4" (2)	1	104.87
LF5100C11/2	603SB	1 1/2"	1/8" (1)	1/4" (2)	1	133.61
LF5101C1	606SB	1"	-	1/4" (2)	1	80.98
LF5101C11/4	607SB	1 1/4"	-	1/4" (2)	1	104.87



LF5100D Series Silicon Bronze LEAD FREE* submersible Check Valves

- Installation between pump and column pipe.
- Made in U.S.A.



Part Number	Simmons	Size (FxM)	Ctn Qty	List Price
LF5100D1x1	616SB	1"x1"	1	\$ 59.87
LF5100D1x1LT	610SB	1"x1" w/ longer threads	1	64.33
LF5100D1x11/4	617SB	1"x1 1/4"	1	57.86
LF5100D11/4x11/4	618SB	1 1/4"x1 1/4"	1	82.37



LF6700 Series DUCTILE IRON LEAD FREE* Check Valve

- Ductile iron body - STEMMED
- Silicon bronze poppet and stainless steel spring and nut.
- Non toxic paint.
- For use with large submersible pumps.
- Made in U.S.A.



Part Number	Simmons	Size	Pipe	Ctn Qty	List Price
LF6700-1	653SB	1"	1 7/8"	1	\$ 34.03
LF6700-11/4	654SB	1 1/4"	2 5/16"	1	54.66
LF6700-11/2	655SB	1 1/2"	2 5/8"	1	68.01
LF6700-2	680SB	2"	3 1/4"	1	106.13
LF6700-3	670SB	3"	4 1/8"	1	402.80
LF6700-4	671SB	4"	5 5/8"	1	629.87
LF6700-6	672SB	6"	7 5/8"	1	1142.78
LF6700-8	673SB	8"	9 5/8"	1	2892.95



LF7000 Series Silicone Bronze LEAD FREE* Pressure Regulator Valve

- Silicon bronze cast body.
- Adjustable bronze cylinder control
- For deep well pumps.
- Positive o-ring seat.
- PT series with pressure line tapping.
- Made in U.S.A.



Part Number	Simmons	Size	Line Tap	Ctn Qty	List Price
LF7000-3/4	730SB	3/4 x 3/4 x 3/4"	-	1	\$ 93.58
LF7000PT1	731SB	1 x 1 x 1"	1/8"	1	106.48



No Lead Foot Valves - Simmons

• FOR USE IN WATER WELL SYSTEMS

* Silicon bronze components contain less than 0.05% (1/20 of 1%) lead.

Simmons



5000S Series Silicone Bronze Foot Valve Features:

- Silicon bronze cast body and poppet.
- Stainless steel perforated screen.
- Specify LFN5000S 1-1/4 special valve for 2" ID casing.
- 400 PSI working pressure
- Made in U.S.A.



Part Number	Simmons	Size	Ctn Qty	List Price
LF5000S3/4	452SB	3/4"	60	\$ 49.36
LF5000S1	453SB	1"	60	54.84
LFN5000S11/4	404SB	1 1/4"	36	64.33
LF5000S11/4	455SB	1 1/4"	36	66.17
LFS5000S11/4	454SB	1 1/4"	36	59.92
LF5000S11/2	456SB	1 1/2"	24	106.83
LF5000S2	457SB	2"	12	169.47
LF5000S21/2	458SB	2 1/2"	1	563.54
LF5000S3	459SB	3"	1	774.33
LF5000S4	460SB	4"	1	1288.41



LF4000 Series SILICON BRONZE Dual Purpose Foot Valve Features:

- Same as LF5000S Series plus:
- Dual purpose foot valve. Threaded inside and outside.
- Made in U.S.A.



Part Number	Simmons	Size (F x M)	Ctn Qty	List Price
LF4000-1 x 11/4	466SB	1" x 1 1/4"	1	\$ 61.53
LF4000-11/4 x 11/2	467SB	1 1/4" x 1 1/2"	1	73.24



LF50S Series SILICON BRONZE Suction Strainer Features:

- Same as LF5000S Series plus:
- Full flow suction strainer.
- Made in U.S.A.



Part Number	Simmons	Size	Diameter	Length	Ctn Qty	List Price
LF50S1	491SB	1"	1 3/4"	4 3/4"	1	\$ 57.15
LF50S11/4	492SB	1 1/4"	2 5/16"	5 1/4"	1	76.12
LF50S11/2	493SB	1 1/2"	2 1/2"	6 5/16"	1	107.09
LF50S2	494SB	2"	3 1/8"	7 3/16"	1	164.18
LF50S21/2	495SB	2-1/2"	4"	9 3/8"	1	394.61

Check Valves - LF5100 Series Pressure, Head Loss



Applies to all Simmons LF5100 Series check valves on previous pages

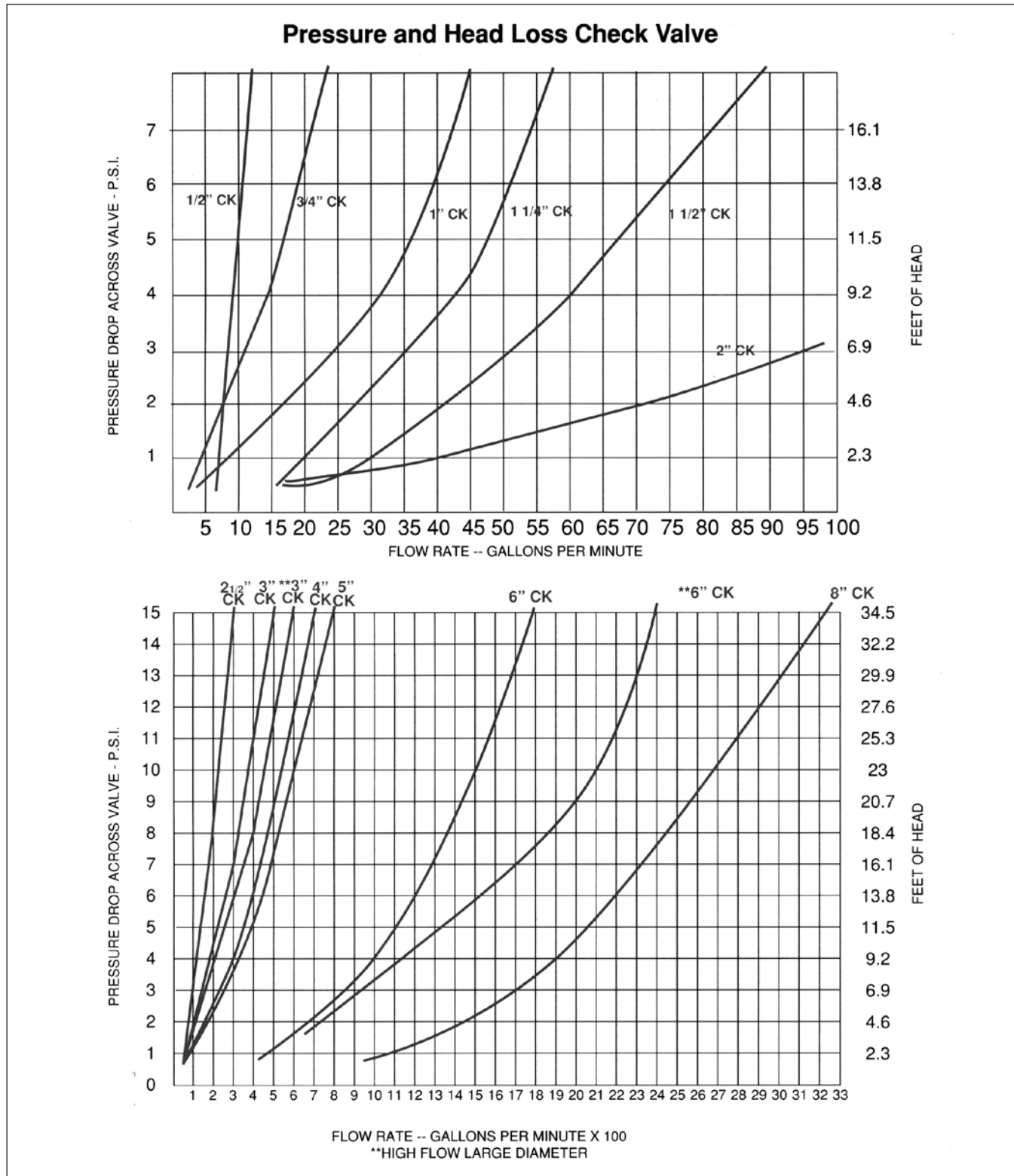



Foot & Check - Plastic



FV441

HARVARD Four in One Plastic Foot Valve

- Positive sealing - spring loaded valve poppet closes against a smooth tapered seat.
- Corrosion resistant nylon body and internals.
- Self cleaning design for continuous positive sealing.
- Large screen designed to assure smooth water passage and better suction.
- Tapered screen eliminates pipe joint hang-ups during installation.
- Fits four pipe sizes., 3/4" through 1 1/2".
- Third party certified to NSF/ANSI 372.



Part Number	Size	Ctn Qty	List Price
FV441	3/4" through 1 1/2"	100	\$ 15.54



FV Series



LC Series



FV SN Series

Brady Plastic Foot & Check Valve Features:

- "Nose Cone" diffuser reduces friction.
- 50% greater water flow.
- Acetal copolymer construction.
- Non-electrolytic, non-corrosive.
- Spring loaded, 316 stainless steel
- BUNA-N seal
- Pressure max: 175 psi
- Temperature max: 180 F
- LC check valve, FPT x FPT
- Third party certified to NSF/ANSI 372.



Part Number	Size	Ctn Qty	List Price
Brady Foot Valve - Spring Loaded			
FV75	3/4"	12	\$ 26.73
FV100	1"	30	30.66
FV125	1-1/4"	32	43.61
FV150	1-1/2"	21	52.95
Brady Check Valve- Spring Loaded			
LC75	3/4"	24	23.03
LC100	1"	24	25.45
LC125	1-1/4"	24	37.45
LC150	1-1/2"	12	44.84
Brady Foot Valve Strainer			
FV75SN	3/4"	50	2.44
FV100SN	1"	50	3.35
FV125SN	1-1/4"	50	3.90
FV150SN	1-1/2"	50	3.76

Foot Valves - Cast Iron, Steel Suction Strainer



5400 Series

Cast Iron Foot Valve Features:

- Painted red finish.
- Includes neoprene flapper check to maintain prime.
- For use in drainage on construction sites, irrigation projects, pumping from ponds or streams.



CLAYTON MARK®



Part Number	Valve Size	Flapper OD Size	List Price
5400-1	1"	2 1/2"	\$ 26.82
5400-11/4	1-1/4"	2 3/4"	40.95
5400-11/2	1-1/2"	3 1/4"	49.18
5400-21/2	2-1/2"	5"	89.80
5400-4	4"	7"	190.00
5400-6	6"	10 1/8"	480.13
5400-8	8"	12 7/8"	912.24

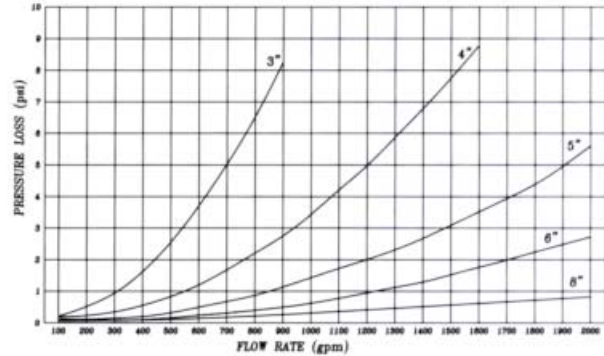
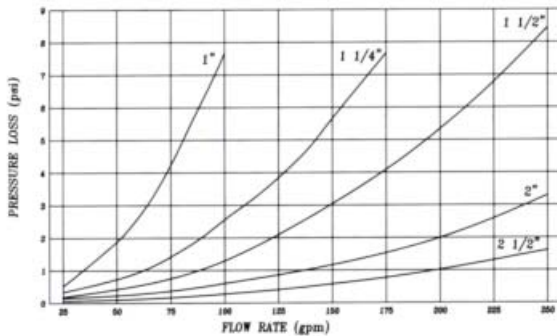

CIRK Series

5400 Series Complete Repair Kits

- Contains all components required to replace inner flapper assembly.
- Includes valve weight, neoprene flapper, sealing washer, bolt, washer & nut.



Valve Size	LEATHER FLAPPER ONLY		NEOPRENE FLAPPER ONLY		COMPLETE REPAIR KIT (w/ neoprene flapper)	
	Part No.	List Price	Part No.	List Price	Part No.	List Price
1"	5400-1LR	\$ 7.52				
1 1/4"	5400-11/4LR	8.79			CIRK125	28.08
1 1/2"	5400-11/2LR	9.51	8367C	6.65	CIRK150	32.01
2"	5400-2LR	13.56	8367D	9.51		
2 1/2"	5400-21/2LR	14.39	8367E	10.11	CIRK250	53.23
3"	5400-3LR	20.32	8367F	24.00		
4"	5400-4LR	50.09	8367G	34.87	CIRK400	88.31
5"	5400-5LR	66.78	-	-		
6"	5400-6LR	82.16	8367J	57.50	CIRK600	187.56
8"	5400-8LR	128.62	8367K	79.03	CIRK800	271.58



5400-LR Series



NO LEAD Yard Hydrants - Frost Proof



5451NL Series



HVBAD75NL



NLRBHE Series



NLRBHT Series



SSHE Series



SSHT Series

NO LEAD Series Frost Proof Yard Hydrant

Features:

- Fully frost proof, shut-off valve below frost line.
- Heavy cast iron head with 3/4" brass discharge connection and bucket hook.
- Can be padlocked.
- Heavy, galvanized steel, corrosion resistant, 1" stand-pipe.
- Galvanized carbon steel connecting rod. Stainless steel operating rod.
- Long lasting Buna-N rubber plunger with solid brass core.
- Integral valve seat cast into brass valve body. 3/4" FPT connection with double bypass bottom valve for superior flow, less risk of debris blockage.
- 1/8" FPT back drain hole.
- Rated to 80 PSI, adjustable. See page 2.18 for adjustment procedure.
- Packed securely in individual heavy weight carton.
- Independent lab tested.
- Lead Free. **Third party certified to NSF/ANSI 372.**



CLAYTON MARK[®]

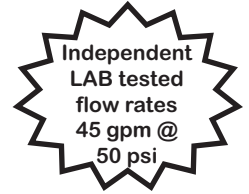

Part Number	Bury Depth	Overall Length	Weight (Pounds)	List Price
54511NL	1	42"	12.4	\$ 124.52
54512NL	2	54"	15.2	132.01
54513NL	3	66"	17.8	142.83
54514NL	4	78"	21.0	153.11
54515NL	5	90"	22.3	163.93
54516NL	6	102"	26.2	170.96
54518NL	8	126"	30.7	195.85

Part Number	Description	Ctn/Case Qty	List Price
NO LEAD Vacuum Breaker Meets ASSE 1011			
HVBAD75NL	3/4"NL Brass w/ auto back drain fght x mght	10/100	\$ 15.54

Part Number	Size	# Barbs	Ctn/Case Qty	List Price
No Lead Cast Bronze Hydrant Elbow (INSxMIP)				
NLRBHE3/4	3/4" x 3/4"	5	10/100	\$ 13.75
NLRBHE1X3/4	1" x 3/4"	5	10/100	16.43
NLRBHE1	1" x 1"	5	10/100	19.14
NLRBHE11/4	1 1/4" x 1 1/4"	5	5/50	32.32
No Lead Cast Bronze Extra Long Hydrant Elbow (INS x MIP)				
NLXLRBHE1	1" x 1"	8	10/100	23.39
NLXLRBHE1X3/4	1" x 3/4"	10	10/100	23.04
No Lead Cast Bronze Hydrant Tee (INS x MIP)				
NLRBHT3/4	3/4" x 3/4"	4	10/100	20.54
NLRBHT1x3/4	1" x 3/4"	6	10/100	24.25
NLRBHT1	1" x 1"	4	10/100	27.68
Stainless Steel Hydrant Elbow (INSxMIP)				
SSHE3/4	3/4" x 3/4"	5	10/100	20.94
SSHE1X3/4	1" x 3/4"	5	10/100	23.21
SSHE1	1" x 1"	5	10/100	31.01
SSHE11/4	1 1/4" x 1 1/4"	5	10/50	40.38
Stainless Steel Hydrant Tee (INS x MIP)				
SSHT3/4	3/4" x 3/4"	4	10/100	24.32
SSHT1x3/4	1" x 3/4"	6	10/100	30.41
SSHT1	1" x 1"	4	10/100	33.25



www.americangranby.com
 In the United States: Phone (800) 776-2266 Fax (800) 729-3299
 In Canada: Phone (800) 268-7570 Fax (905) 629-3204

6/3/19

2.17

Yard Hydrants - Replacement Parts

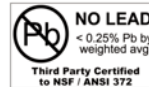

CLAYTON MARK®

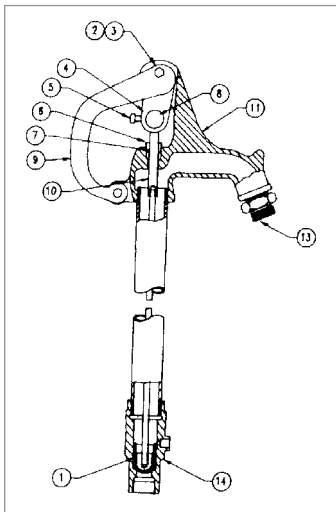

3/4" 5451NL Hydrant Flow Rates

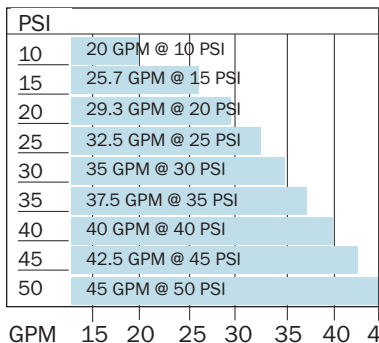

5451NL Series Hydrant Replacement Parts

Part Number	Item Number	Description	List Price
YRK1		Repair Kit (Items 1-8)	\$ 17.33
9175B	1	Plunger - BUNA N rubber/brass	6.37
9023B	2	Fulcrum Bolt - zinc plated steel	0.36
9023C	3	Fulcrum Nut - zinc plated steel	0.27
9023D	4	Links (set of 2) - zinc plated steel	2.38
9023E	5	Set Screw square head - zinc plated steel	0.47
9023A	6	Packing Nut - brass	3.18
29609G	7	Packing - graphite (2 - 1 old, 1 new style)	4.03
9023G	8	Connector - brass	5.79
2506K	9	Handle - painted cast iron	10.14
2222AHSS	10	Clevis Rod - SS NEW STYLE (for double bypass)	11.77
2500K	11	Head only - painted cast iron	34.19
382914	13	Hose Adapter - brass	7.31
381504	14	Valve Body - brass	45.00
2575K		Complete Head Assembly (Items 2-13)	56.18

STEEL ROD (use with double bypass valve 5451 Series)

TA7100099NS	54511 Rod (32.4")	11.89
TA7100100NS	54512 Rod (44.4")	15.46
TA7100101NS	54513 Rod (56.4")	19.03
TA7100102NS	54514 Rod (68.4")	20.60
TA7100103NS	54515 Rod (80.4")	26.17
TA7100104NS	54516 Rod (92.4")	29.74
TA7100105NS	54518 Rod (116.4")	36.89

NOTE: All 5451NL Series Hydrants are preset at factory. There should be no need for any adjustment on initial installation. Adjust only if water does not shut off or hydrant does not operate properly.

5451NL HYDRANT ADJUSTMENT PROCEDURE

- Turn water supply OFF.
- Open hydrant to relieve pressure.
- Loosen set screw. (Item 1)
- Push brass rod down as far as it will go by hand to be sure the plunger is touching the seat.
- Open handle (Item 2) approximately 30° from closed position.
- Tighten set screw snugly.
- Turn water supply ON.
- Operate hydrant and make sure the hydrant is shutting off properly and flowing properly.
- If hydrant still does not shut off, repeat steps 1 through 8.**
- Flow water through hydrant and then close completely to check for proper drainage by:
 - listening for water draining down pipe or
 - putting your hand over the hose connection to feel for a vacuum.
 If hydrant does not drain, see step 11.
- To clear drain hole blockage, close off hydrant spout by using hose cap or by attaching and kinking a hose. Open and close hydrant to allow water pressure to clear blockage. Repeat step 10 to verify proper drainage. If hydrant still does not drain, repeat steps 1 through 10 to fully uncover drain hole.

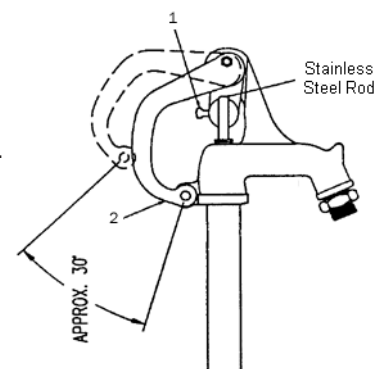

CAUTION: Do not try to make the shutoff adjustment in one attempt or you may overadjust and cause damage to the plunger and rods. For this reason adjust in multiple small increments.



NO LEAD Yard Hydrants - Frost Proof



Deluxe NO LEAD Frost Proof Yard Hydrant Features:

- FROST-PROOF - Shut-off valve operates below the frost line.
- Pistol type handle eliminates pinching.
- Can be padlocked.
- Wheel handle controls water flow at rate desired.
- Stainless steel extension rod will not rust or cut into packing.
- Water in standpipe drains out when hydrant is off.
- Aluminum nozzle threaded for standard 3/4" hose coupling.
- Inner parts removable without digging.
- 120 PSI maximum pressure.
- Individually boxed.

Simmons



NL Series is Lead Free and certified to NSF/ANSI 372 <0.25% Pb by weighted average.

NOT FOR SALE IN CALIFORNIA.
Does NOT meet CA Prop 65.

NO LEAD Part No.	Bury Depth	Pipe Length	Overall Length	Ctn Qty	List Price
H800NL	1 ft	30"	40"	1	\$ 182.93
H801NL	1.5 ft	38"	48"	1	187.71
H802NL	2 ft	44"	54"	1	192.84
H803NL	3 ft	56"	66"	1	203.01
H804NL	4 ft	68.5"	78.5"	1	216.68
H805NL	5 ft	80.5"	90.5"	1	230.43
H806NL	6 ft	92.25"	102.25"	1	247.70
H807NL	7 ft	104"	114"	1	261.37
H808NL	8 ft	116"	126"	1	279.17



HVBAD75NL



Part Number	Description	Ctn/Case Qty	List Price
NO LEAD Vacuum Breaker Meets ASSE 1011			
HVBAD75NL	3/4"NL Brass w/ auto back drain fght x mght10/100		\$ 15.54



NLRBHE Series



NLRBHT Series



SSHE Series



SSHT Series

Part Number	Size	# Barbs	Ctn/Case Qty	List Price
No Lead Cast Bronze Hydrant Elbow (INSxMIP)				
NLRBHE3/4	3/4" x 3/4"	5	10/100	\$ 13.75
NLRBHE1X3/4	1" x 3/4"	5	10/100	16.43
NLRBHE1	1" x 1"	5	10/100	19.14
NLRBHE11/4	1 1/4" x 1 1/4"	5	5/50	32.32
No Lead Cast Bronze Extra Long Hydrant Elbow (INS x MIP)				
NLXLRBHE1	1" x 1"	8	10/100	23.39
NLXLRBHE1X3/4	1" x 3/4"	10	10/100	23.04
No Lead Cast Bronze Hydrant Tee (INS x MIP)				
NLRBHT3/4	3/4" x 3/4"	4	10/100	20.54
NLRBHT1x3/4	1" x 3/4"	6	10/100	24.25
NLRBHT1	1" x 1"	4	10/100	27.68
Stainless Steel Hydrant Elbow (INSxMIP)				
SSHE3/4	3/4" x 3/4"	5	10/100	20.94
SSHE1X3/4	1" x 3/4"	5	10/100	23.21
SSHE1	1" x 1"	5	10/100	31.01
SSHE11/4	1 1/4" x 1 1/4"	5	10/50	40.38
Stainless Steel Hydrant Tee (INS x MIP)				
SSHT3/4	3/4" x 3/4"	4	10/100	24.32
SSHT1x3/4	1" x 3/4"	6	10/100	30.41
SSHT1	1" x 1"	4	10/100	33.25



www.americangranby.com
 In the United States: Phone (800) 776-2266 Fax (800) 729-3299
 In Canada: Phone (800) 268-7570 Fax (905) 629-3204

6/3/19

2.19

Yard Hydrants - Replacement Parts

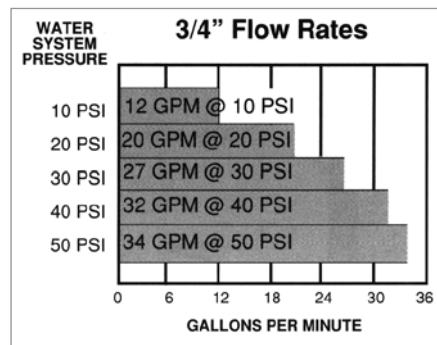
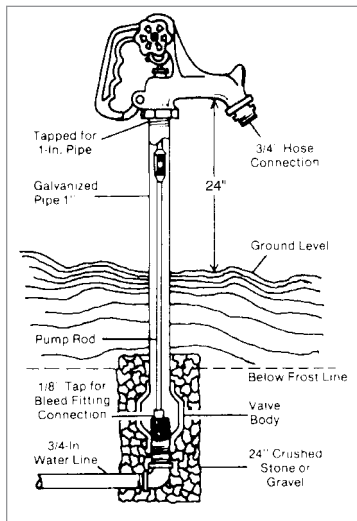

Replacement Parts For H800 Series Hydrants

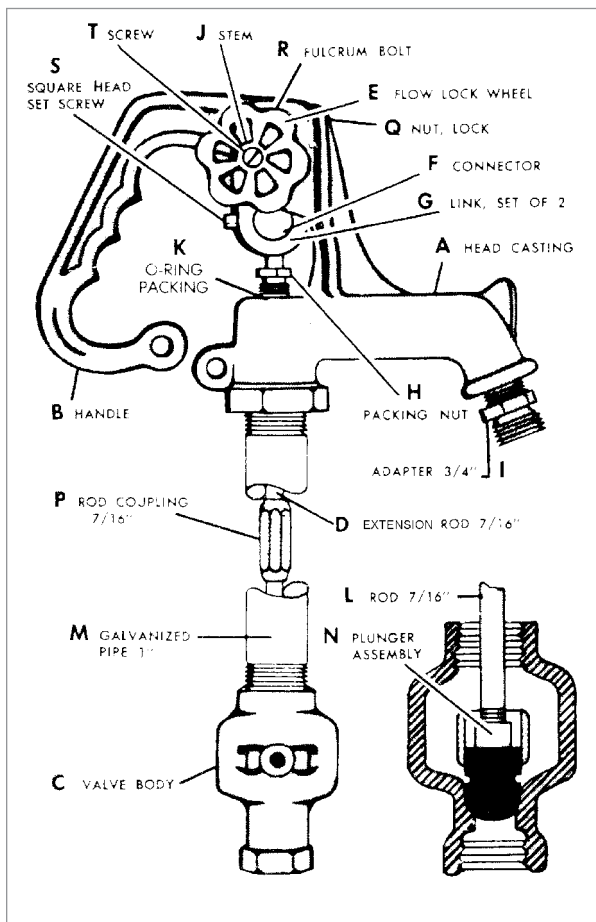

Part Number	Reference Number	Name of Part	List Price
8820	A	Head	\$ 60.04
8821	B	Handle	19.51
8822SB	C	Valve Body NL	73.07
8843	D	Stainless Steel Extension Rod 7/16" NL	13.42
8824	E	Hand Wheel	3.43
8825 *	F	Connector - brass	32.96
8826 *	G	Links(pair) - brass	17.47
8827 *	H	Packing Nut - brass	11.58
8844	I	Aluminum Hose Adapter NL	12.09
8829	J	Brass Stem, Square head	4.75
8839 *	K	O-Ring Packing, BUNA-N (pair)	3.28
8814-0	L	7/16" Pump Rod for H800NL	29.08
8814-1		7/16" Pump Rod for H801NL	36.48
8814-2		7/16" Pump Rod for H802NL	43.91
8814-3		7/16" Pump Rod for H803NL	56.08
8814-4		7/16" Pump Rod for H804NL	67.94
8814-5		7/16" Pump Rod for H805NL	79.87
8814-6		7/16" Pump Rod for H806NL	91.58
8814-7		7/16" Pump Rod for H807NL	103.50
8814-8		7/16" Pump Rod for H808NL	115.23
8815-0	M	Pipe Casing for H800NL	33.37
8815-1		Pipe Casing for H801NL	44.42
8815-2		Pipe Casing for H802NL	52.88
8815-3		Pipe Casing for H803NL	66.99
8815-4		Pipe Casing for H804NL	81.05
8815-5		Pipe Casing for H805NL	95.10
8842 *	N	Plunger - one piece NL	19.05
8834	P	Rod Coupling, 7/16"	5.34
8301 *	Q	Lock Nut - stainless steel	1.06
8836 *	R	Fulcrum Bolt - stainless steel	4.23
8837 *	S	Square Head Set Screw - stainless steel	2.06
8610	T	Screw for Hand Wheel	1.72
840SB		Head, Complete NL	97.74
850SB		Parts Kit NL (* Included)	53.05