

Simmons

Manufacturing Company

McDONOUGH, GEORGIA



**Water Well Supplies
December 2013**

Made in the U.S.A.

Warranty (Back Cover)..... 48
Product Certification (Back Cover)... 48
Air Valves..... 38
Air Volume Controls..... 37
Bleeder Orifice (Import)..... 41
Cable Guard..... 39
Caps, Drive..... 34
Check Valves: PARTS..... 10
 STAINLESS STEEL..... 4
 BRONZE:
 Dual Purpose..... 4A
 500SB Series..... 5
 2500SB Series..... 5
 Submersible..... 5
 Tapped..... 6
 Control Center..... 6
 Import Check Valves..... 41
 DUCTILE IRON..... 7
 With Break-Off Plug..... 7
 With Stabilizer for VFD..... 9
 Submersible..... 9
 Tapped..... 8
 PLASTIC Check Valves..... 38
 DIMENSIONS, Check Valves 44
 PRESSURE DATA, Check Valves..... 45
Couplings, Standard, Drive & Turned... 34
Foot Valves: PARTS..... 10
 BRONZE 400SB Series..... 3
 With ABS Strainer..... 3
 Suction Strainer..... 3
 Import Foot Valves..... 41
 CAST IRON..... 10
 Leather Flappers..... 10
 PLASTIC Foot Valves..... 38
 STAINLESS STEEL..... 4
 Stemless..... 4
 DIMENSIONS, Foot Valves..... 44
Frost Proof Yard Hydrants & Parts:
 800LF Series Deluxe 23
 Models 808LF - 818LF..... 23
 Models 820LF - 828LF..... 23A
 4800LF Series Premier 24
 800SB Series Deluxe..... 25
 6800LF Series Sanitary..... 26
 6800LF Specifications..... 47
 5800LF Series Landscape..... 27
 900 Series Import..... 43
 DIMENSIONS, Yard Hydrants..... 46

Index

Insert Fittings: Adapters, Reducers,
 Adapters w/Lug, Rope Adapters 35
 Venturi Adapters, Couplings,
 Reducers, Nipples, Well Seal Ells 36
Lighting Arrestor 39
Pitcher Pump & Parts (Import)..... 42
Pitless Adapters: 11
 1800SB Series..... 11
 Import 41
Pressure Gauges (Import)..... 38
Pressure Regulator Valve..... 4
Pressure Switches..... 40
 Import 41
Relief Valves..... 39
 Import..... 41
Splicing Kits 39
Submersible Rope 38
Tank Crosses & Tees: Cast..... 28
 Fabricated, w/ Union..... 29
 Elevated, w/ Union 30 & 31
 Cast (Import)..... 42
 Tank Manifold (Import)..... 42
Tank Packages..... 31
Torque Arrestor..... 39
Well Points: 32, 33 & 34
 DIMENSIONS, Well Points 32
Well Screens 33
Well Caps: CAST IRON..... 12
 THERMOPLASTIC 12
Well Seals:
 ABS 16
 CAST Split Top Single Pipe..... 13
 CAST Solid Top Single Pipe..... 14
 CAST Split & Solid Top Double Pipe... 14
 CAST Single Pipe, w/Cable Slot..... 15
 CAST Split Top, w/Eye Bolt..... 15
 STEEL Single Pipe..... 17 & 18
 STEEL with FLUSH bolts 19 & 20
 STEEL Blank..... 21
 STEEL Double Pipe & Bottomless..... 22
 Well Seal Vents and Top Guides 22
 Well Seal Vent Pipe (Import)..... 41

CERTIFIED LEAD FREE 400 SB Series



Foot Valve

- Silicon bronze cast body.
- Silicon bronze cast poppet.
- Stainless Steel Perforated Strainer.
- Female threads.



NSF/ANSI 372

Part No.	Size	Weight Each lbs.	Carton Quantity
452SB	3/4	.5	1
453SB	1	.8	1
404SB**	1 1/4	1.0	1
454SB	1 1/4	1.1	1
455SB	1 1/4	1.3	1
456SB	1 1/2	1.7	1
457SB	2	3.0	1
458SB	2 1/2	7.0	1
459SB	3	9.2	1
460SB	4	18.7	1
461SB	6	33.5	1

**404SB enters 2" pipe



CERTIFIED LEAD FREE

- Silicon bronze cast body.
- Silicon bronze cast poppet.
- Stainless Steel Perforated Strainer.
- Dual purpose threads.



NSF/ANSI 372

Part No.	Size FxM	Weight Each lbs.	Carton Quantity
465SB	3/4 x 1	.4	1
466SB	1 x 1 1/4	.8	1
467SB	1 1/4 x 1 1/2	.9	1



CERTIFIED LEAD FREE

- Silicon bronze cast body.
- Silicon bronze cast poppet.
- ABS plastic strainer.
- Female threads.
- Dual threads on 487SB.



NSF/ANSI 372

Part No.	Size	Weight Each lbs.	Carton Quantity
483SB	1	.8	1
487SB	1 x 1 1/4	.8	1



CERTIFIED LEAD FREE Suction Strainer

- Silicon bronze cast body.
- Stainless Steel Perforated Strainer.
- Female threads.



NSF/ANSI 372

Part No.	Size	Weight Each lbs.	Carton Quantity
490SB	3/4	.5	1
491SB	1	.6	1
492SB	1 1/4	1.1	1
493SB	1 1/2	1.5	1
494SB	2	2.6	1
495SB	2 1/2	6.2	1
496SB	3	8.1	1
497SB	4	14.7	1
489SB	6	32.0	1

*Silicon bronze components contain less than .05% (1/20 of 1%) Lead.

All foot valves furnished with Buna-N O-Ring, stainless steel spring and stainless steel locknut.
All valves 3/4" through 1-1/2" have a working pressure of 400 psi. All valves 2" and larger have a working pressure of 600 psi.
190° Maximum Temperature Rating

MADE IN U.S.A.



Stainless Steel Series

CERTIFIED LEAD FREE

Foot Valve



- Stainless Steel cast body.
- Stainless Steel cast poppet.
- Stainless Steel perforated strainer.
- Female threads.

Part No.	Size	Weight Each lbs.	Carton Quantity
454SS	1 1/4	1.0	1

CERTIFIED LEAD FREE Stemless Foot Valve



- Stainless Steel cast body.
- Stainless Steel cast poppet.
- Stainless Steel perforated strainer.
- Female threads.
- Fits in 2" diameter pipe.

Part No.	Size	Weight Each lbs.	Carton Quantity
2404SS	1 1/4	1.0	1

CERTIFIED LEAD FREE Check Valve



- 304 Stainless Steel cast body.
- 304 Stainless Steel cast poppet.
- Female threads.

Part No.	Size	Weight Each lbs.	Carton Quantity
513SS	1	1.2	1
514SS	1 1/4	1.7	1
505SS	1 1/2	2.1	1
506SS	2	3.7	1

CERTIFIED LEAD FREE Single Tapped Check Valve



- 304 Stainless Steel cast body.
- 304 Stainless Steel cast poppet.
- Female threads.

Part No. Stemmed	Size	Tapped Inlet	Tapped Outlet	Wt.Ea. lbs.	Carton Quantity
522SS	1	1/8		1.2	1
553SS	1	1/4		1.2	1
554SS	1		1/8	1.2	1
555SS	1		1/8	1.2	1
523SS	1 1/4	1/8		1.7	1
556SS	1 1/4	1/4		1.7	1
558SS	1 1/4		1/4	1.7	1
524SS	1 1/2	1/8		2.0	1
559SS	1 1/2	1/4		2.0	1
560SS	1 1/2		1/8	2.0	1
561SS	1 1/2		1/4	2.0	1
525SS	2	1/8		3.7	1
562SS	2	1/4		3.7	1
563SS	2		1/8	3.7	1
564SS	2		1/4	3.7	1

*Silicon bronze components contain less than .05% (1/20 of 1%) Lead.

Check Valves furnished with Buna-N O-Ring, stainless steel spring, stainless steel washer, and stainless steel locknut. All valves 3/4" through 1-1/2" have a working pressure of 400 psi. All valves 2" and larger have a working pressure of 600 psi.

190° Maximum Temperature Rating

MADE IN U.S.A.

Stainless Steel Series



NSF/ANSI 372



CERTIFIED LEAD FREE Double Tapped Check Valve

- 304 Stainless Steel cast body.
- 304 Stainless Steel cast poppet.
- Female threads.

Part No. Stemmed	Size	Tapped		Wt.Ea. lbs.	Carton Quantity
		Inlet	Outlet		
542SS	1	1/8	1/4	1.2	1
581SS	1	1/4	1/4	1.2	1
588SS	1	1/8	1/8	1.2	1
543SS	1 1/4	1/8	1/4	1.7	1
582SS	1 1/4	1/4	1/4	1.7	1
589SS	1 1/4	1/8	1/8	1.7	1
544SS	1 1/2	1/8	1/4	2.0	1
583SS	1 1/2	1/4	1/4	2.0	1
533SS	1 1/2	1/8	1/8	2.0	1
545SS	2	1/8	1/4	3.7	1
584SS	2	1/4	1/4	3.7	1



CERTIFIED LEAD FREE Submersible Check Valve

- 304 Stainless Steel cast body.
- 304 Stainless Steel cast poppet.
- Female/Male Threads.



NSF/ANSI 372

Part No.	Size FxM	Weight Each lbs.	Carton Quantity
617SS	1 x 1 1/4	1.3	1
618SS	1 1/4 x 1 1/4	1.8	1



CERTIFIED LEAD FREE Dual Purpose Check Valve

- Silicon bronze cast body.
- Silicon bronze cast poppet.
- Female-Male threads both ends.



NSF/ANSI 372

NOTE: For plastic foot valves and check valves, see page 38.

Part No.	Size FxM	Size FxM	Weight Each lbs.	Carton Quantity
641SB	1 x 1 1/4	1 x 1 1/4	1.2	1



CERTIFIED LEAD FREE Pressure Regulator Valve

- Silicon bronze cast body.
- Adjustable bronze cylinder control.
- For deep well pumps.
- Positive O-Ring seat.



NSF/ANSI 372

Part No.	Size	Pressure Line Tapping	Weight Each lbs.	Carton Quantity
729SB	3/4 x 3/4 x 3/4	1/4	.8	1
730SB	3/4 x 3/4 x 3/4	-	.8	1
731SB	1 x 1 x 1	1/8	1.2	1
732SB	1 x 1 x 1	1/4	1.2	1

*Silicon bronze components contain less than .05% (1/20 of 1%) Lead.

Check Valves furnished with Buna-N O-Ring, stainless steel spring, stainless steel washer, and stainless steel locknut. All valves 3/4" through 1-1/2" have a working pressure of 400 psi. All valves 2" and larger have a working pressure of 600 psi.

190° Maximum Temperature Rating

MADE IN U.S.A.

CERTIFIED LEAD FREE
500 SB Series



CERTIFIED LEAD FREE
Check Valve

- Silicon bronze cast body.
- Silicon bronze cast poppet.
- Female threads.

Part No.	Size	Weight Each lbs.	Carton Quantity
501SB	1/2	.6	1
502SB	3/4	.8	1
503SB	1	1.1	1
513SB*	1	1.2	1
504SB	1 1/4	1.6	1
514SB**	1 1/4	1.7	1
505SB	1 1/2	2.1	1
506SB	2	3.7	1
507SB	2 1/2	9.8	1
508SB	3	10.8	1
509SB	4	23.6	1
510SB***	5	25.1	1
511SB	6	41.5	1

513SB* has longer threads.
514SB** has longer threads.
510SB*** has 5" male threads both ends.

CERTIFIED LEAD FREE
2500 SB Series



CERTIFIED LEAD FREE
Stemless Check Valve

- Silicon bronze cast body.
- Silicon bronze stemless poppet.
- Female threads.

Part No.	Size	Weight Each lbs.	Carton Quantity
2503SB	1	1.3	1
2504SB	1 1/4	1.8	1
2505SB	1 1/2	2.1	1
2506SB	2	3.7	1



CERTIFIED LEAD FREE
Submersible Check Valve



- Silicon bronze cast body.
- Silicon bronze cast poppet.
- Female-Male threads.

Part No.	Size FxM	Weight Each lbs.	Carton Quantity
610SB**	1 x 1 Long	1.4	1
611SB**	1 1/4 x 1 1/4 Long	2.0	1
616SB	1 x 1	1.4	1
617SB	1 x 1 1/4	1.4	1
618SB	1 1/4 x 1 1/4	1.8	1
622SB	2 x 2	3.9	1
623SB	3 x 3	10.4	1
624SB	4 x 4	22.6	1
625SB	6 x 6	41.4	1

** Extended male and female threads

*Silicon bronze components contain less than .05% (1/20 of 1%) Lead.

Check Valves furnished with Buna-N O-Ring, stainless steel spring, stainless steel washer, and stainless steel locknut.
All valves 1/2" through 1-1/2" have a working pressure of 400 psi. All valves 2" and larger have a working pressure of 600 psi.
190° Maximum Temperature Rating

MADE IN U.S.A.



NSF/ANSI 372

CERTIFIED LEAD FREE Single Tap

- Silicon bronze cast body.
- Silicon bronze cast poppet.
- Female threads.



NSF/ANSI 372

CERTIFIED LEAD FREE Double Tapped

- Silicon bronze cast body.
- Silicon bronze cast poppet.
- Female threads.

Control Center



NSF/ANSI 372

CERTIFIED LEAD FREE Check Valve

- Silicon bronze cast body.
- Silicon bronze cast poppet.
- Four tappings. • Female threads.



601-604 tappings:
One 1/8" inlet,
Two 1/4" outlets,
One 1/8" outlet.

606-607 tappings: Two 1/4" outlets.

Part No. Stemmed	Part No. Stemless	Size	Tapped		Wt.Ea. lbs.	Carton Quantity
			Inlet	Outlet		
521SB	-	3/4	1/8		.8	1
550SB	-	3/4	1/4		.8	1
551SB	-	3/4		1/8	.8	1
552SB	-	3/4		1/4	.8	1
522SB	2522SB	1	1/8		1.2	1
553SB	2553SB	1	1/4		1.2	1
554SB	2554SB	1		1/8	1.2	1
555SB	2555SB	1		1/4	1.2	1
523SB	2523SB	1 1/4	1/8		1.7	1
556SB	2556SB	1 1/4	1/4		1.7	1
558SB	2558SB	1 1/4		1/4	1.7	1
524SB	2524SB	1 1/2	1/8		2.0	1
559SB	2559SB	1 1/2	1/4		2.0	1
560SB	2560SB	1 1/2		1/8	2.0	1
561SB	2561SB	1 1/2		1/4	2.0	1
525SB	2525SB	2	1/8		3.7	1
562SB	2562SB	2	1/4		3.7	1
563SB	2563SB	2		1/8	3.7	1
564SB	2564SB	2		1/4	3.7	1
526SB	-	2 1/2	1/8		9.8	1
527SB	-	3	1/8		10.1	1
528SB	-	4	1/8		23.5	1

Part No. Stemmed	Part No. Stemless	Size	Tapped		Wt.Ea. lbs.	Carton Quantity
			Inlet	Outlet		
541SB	-	3/4	1/8	1/4	.8	1
580SB	-	3/4	1/4	1/4	.8	1
542SB	2542SB	1	1/8	1/4	1.2	1
581SB	2581SB	1	1/4	1/4	1.2	1
588SB	2588SB	1	1/8	1/8	1.2	1
543SB	2543SB	1 1/4	1/8	1/4	1.7	1
582SB	2582SB	1 1/4	1/4	1/4	1.7	1
589SB	2589SB	1 1/4	1/8	1/8	1.7	1
544SB	2544SB	1 1/2	1/8	1/4	2.0	1
583SB	2583SB	1 1/2	1/4	1/4	2.0	1
533SB	2533SB	1 1/2	1/8	1/8	2.0	1
545SB	2545SB	2	1/8	1/4	3.7	1
584SB	2584SB	2	1/4	1/4	3.7	1
546SB	-	2 1/2	1/8	1/4	9.8	1
547SB	-	3	1/8	1/4	10.1	1
548SB	-	4	1/8	1/4	23.5	1

Part No.	Size	Wt. Ea. lbs.	Carton Quantity
601SB	1	1.3	1
602SB	1 1/4	1.7	1
603SB	1 1/2	2.1	1
604SB	2	3.6	1
606SB	1	1.3	1
607SB	1 1/4	1.7	1

*Silicon bronze components contain less than .05% (1/20 of 1%) Lead.

Check Valves furnished with Buna-N O-Ring, stainless steel spring, stainless steel washer, and stainless steel locknut.
All valves 3/4" through 1-1/2" have a working pressure of 400 psi. All valves 2" and larger have a working pressure of 600 psi.
190° Maximum Temperature Rating

MADE IN U.S.A.



NSF/ANSI 372

CERTIFIED LEAD FREE Ductile Iron Check Valve

- ASTM A536 Ductile iron body. • Silicon bronze poppet.
- Stainless steel spring and nut. • Non-toxic polyester powder coat paint.



Standard Stemmed Poppet Check Valve

Stemmed Part No.	Size	Wt.Ea. lbs.	Ctn Qty
653SB	1	1.3	1
654SB	1-1/4	1.7	1
655SB	1-1/2	2.1	1
680SB	2	3.5	1
669SB	2-1/2	15.3	1
670SB	3	11.7	1
681SB	3*	13.1	1
671SB	4	21.5	1
674SB	5	33.7	1
672SB	6	44.5	1
683SB	6*	60.2	1
673SB	8	63.7	1
689SB	10	110.0	1

* High Flow Design



Stemless Poppet Check Valve

Stemless Part No.	Size	Wt.Ea. lbs.	Ctn Qty
2653SB	1	1.3	1
2654SB	1-1/4	1.7	1
2655SB	1-1/2	2.1	1
2680SB	2	3.5	1
-	2-1/2	15.3	1
-	3	11.7	1
2681SB	3*	13.1	1
2671SB	4	21.5	1
2674SB	5	33.7	1
-	6	44.5	1
2683SB	6*	60.2	1
-	8	63.7	1
-	10	110.0	1

* High Flow Design

CERTIFIED LEAD FREE Ductile Iron Check Valve with Break-off Plug

- 1/2" Break-off plug standard. • 3/8" Break-off plug optional.



NSF/ANSI 372



Check Valve (with Break-off Plug)

Stemmed Part No.	Size	Wt.Ea. lbs.	Ctn Qty
668SB	2-1/2	15.3	1
675SB	3	12.3	1
685SB	3*	13.4	1
676SB	4	21.3	1
679SB	5	34.0	1
677SB	6	44.7	1
687SB	6*	60.4	1
678SB	8	64.0	1
690SB	10	110.3	1

* High Flow Design



Stemless Check Valve (with Break-off Plug)

Stemless Part No.	Size	Wt.Ea. lbs.	Ctn Qty
-	2-1/2	15.3	1
-	3	12.3	1
2685SB	3*	13.4	1
2676SB	4	21.3	1
2679SB	5	34.0	1
-	6	44.7	1
2687SB	6*	60.4	1
-	8	64.0	1
-	10	110.3	1

* High Flow Design

CERTIFIED LEAD FREE Break-off Plug Only



- 303 Stainless steel.
- The break-off plug, when manually broken, allows water to drain from drop pipe before removal of pump.

Part No.	Size	Total Length	Wt.Ea. lbs.	Carton Quantity
4061	1/2	3.12	.5	1
4068	3/8	3.0	.4	1
4069**	1/2	6.0	.8	1

** For 8 & 10" Valves

*Silicon bronze components contain less than .05% (1/20 of 1%) Lead.

Check Valves furnished with Buna-N O-Ring, stainless steel spring, stainless steel washer, and stainless steel locknut. All valves 3/4" through 1-1/2" have a working pressure of 400 psi. All valves 2" and larger have a working pressure of 600 psi. 190° Maximum Temperature Rating

MADE IN U.S.A.



NSF/ANSI 372



CERTIFIED LEAD FREE Ductile Iron Single Tap Check Valve

- Powder coated ASTM A536 Ductile iron cast body.
- Silicon bronze cast poppet.
- Female threads.



Standard Stemmed
Poppet Check Valve



Stemless Poppet
Check Valve

Part No. Stemmed	Part No. Stemless	Size	Tapped		Wt.Ea. lbs.	Carton Quantity
			Inlet	Outlet		
6022SB	26022SB	1	1/8		1.3	1
6053SB	26053SB	1	1/4		1.3	1
6054SB	26054SB	1		1/8	1.3	1
6055SB	26055SB	1		1/4	1.3	1
6023SB	26023SB	1 1/4	1/8		1.7	1
6056SB	26056SB	1 1/4	1/4		1.7	1
6058SB	26058SB	1 1/4		1/4	1.7	1
6024SB	26024SB	1 1/2	1/8		2.1	1
6059SB	26059SB	1 1/2	1/4		2.1	1
6060SB	26060SB	1 1/2		1/8	2.1	1
6061SB	26061SB	1 1/2		1/4	2.1	1
6025SB	26025SB	2	1/8		3.5	1
6062SB	26062SB	2	1/4		3.5	1
6063SB	26063SB	2		1/8	3.5	1
6064SB	26064SB	2		1/4	3.5	1
6027SB	-	3	1/8		11.7	1
6028SB	-	4	1/8		21.5	1



NSF/ANSI 372



CERTIFIED LEAD FREE Ductile Iron Double Tap Check Valve

- Powder coated ASTM A536 Ductile iron cast body.
- Silicon bronze cast poppet.
- Female threads.

Part No. Stemmed	Part No. Stemless	Size	Tapped		Wt.Ea. lbs.	Carton Quantity
			Inlet	Outlet		
6042SB	26042SB	1	1/8	1/4	1.3	1
6081SB	26081SB	1	1/4	1/4	1.3	1
6088SB	26088SB	1	1/8	1/8	1.3	1
6043SB	26043SB	1 1/4	1/8	1/4	1.7	1
6082SB	26082SB	1 1/4	1/4	1/4	1.7	1
6089SB	26089SB	1 1/4	1/8	1/8	1.7	1
6044SB	26044SB	1 1/2	1/8	1/4	2.1	1
6083SB	26083SB	1 1/2	1/4	1/4	2.1	1
6033SB	26033SB	1 1/2	1/8	1/8	2.1	1
6045SB	26045SB	2	1/8	1/4	3.50	1
6084SB	26084SB	2	1/4	1/4	3.50	1
6047SB	-	3	1/8	1/4	11.7	1
6048SB	-	4	1/8	1/4	21.50	1

*Silicon bronze components contain less than .05% (1/20 of 1%) Lead.

Check Valves furnished with Buna-N O-Ring, stainless steel spring, stainless steel washer, and stainless steel locknut.
All valves 3/4" through 1-1/2" have a working pressure of 400 psi. All valves 2" and larger have a working pressure of 600 psi.
190° Maximum Temperature Rating

MADE IN U.S.A.

CERTIFIED LEAD FREE Ductile Iron Check Valve with Stabilizer for VFD Systems



NSF/ANSI 372



Part No.	Size	Wt.Ea. lbs.	Ctn Qty
630SB	2-1/2	15.2	1
631SB	3	11.7	1
632SB	3*	13.1	1
633SB	4	21.5	1
634SB	5	33.7	1
635SB	6	44.5	1

* High Flow Design

With Optional Break-off Plug



Part No.	Size	Wt.Ea. lbs.	Ctn Qty
691SB	2-1/2	15.2	1
692SB	3	11.7	1
693SB	3*	13.1	1
694SB	4	21.5	1
695SB	5	33.7	1
696SB	6	44.5	1

* High Flow Design

Simmons time-proven dependable Ductile Iron Check Valve design with stabilizer sleeve added. Provides added reliability for constant pressure variable speed systems.

Pressed-in silicon bronze sleeve increases contact area of poppet stem for added stability. The smaller diameter hole provides closer tolerance. Sleeve is fluted to allow flushing of any foreign debris. Sleeve and poppet are of identical material, reducing electrolysis worries.

- ASTM A536 Ductile iron body.
- Silicon bronze poppet.
- Buna-N O-Ring.
- Working pressure of 600 psi.
- Stainless Steel spring & nut.
- Heavy duty silicon bronze washer.
- Non-toxic polyester powder coat paint.



CERTIFIED LEAD FREE Ductile Iron Submersible Check Valve

- ASTM A536 Ductile iron body.
- Silicon bronze poppet.
- Stainless steel spring and nut.
- Non-toxic polyester powder coat paint.
- Female-Male threads.
- Working pressure of 600 psi.



NSF/ANSI 372

Part No.	Size FxM	Weight Each lbs.	Carton Quantity
658SB	2 x 2	3.9	1
660SB	3 x 3	9.6	1
661SB	4 x 4	21.4	1
662SB	6 x 6	40.5	1

*Silicon bronze components contain less than .05% (1/20 of 1%) Lead.

Check Valves furnished with Buna-N O-Ring, stainless steel spring, stainless steel washer, and stainless steel locknut.

MADE IN U.S.A.



CERTIFIED LEAD FREE Cast Iron Foot Valve

- Powder coated cast iron.
- Weighted leather flapper.
- Max Pressure 20 PSI



NSF/ANSI 372

Part No.	Size	Weight Each lbs.	Carton Quantity
471	1 1/4	3.4	1
472	1 1/2	3.3	1
473	2	6.5	1
475	3	12.3	1
476	4	20.5	1
478	6	44.7	1
479	8	95.0	1

Cast Iron Foot Valve Parts

- Leather flapper replacements.



Part No.	Valve Size
192460	1 1/4" - 1 1/2"
192470	2"
192480	2 1/2" - 3"
192490	4"
192500	5"
192510	6"
192525	8"

MADE IN U.S.A.

Valve Parts



NSF/ANSI 372



Complete Poppet, FOOT VALVE

Part No.	Size
981SB	3/4"
982SB	1"
983SB	1 1/4"
984SB	1 1/2"
985SB	2"
986SB	2 1/2"
987SB	3"
988SB	4"
989SB	6"

* High Flow Design Poppet

Complete Poppet, CHECK VALVE

Part No.	Size
959SB	1/2"
960SB	3/4"
961SB	1"
962SB	1 1/4"
963SB	1 1/2"
964SB	2"
965SB	2 1/2"
966SB	3"
967SB	4"
968SB	5"
969SB	6"
990SB	8"
987SB	3" *
992SB	6" *

Strainer with Bottom Plate & Screw for Foot Valve

Part No.	Size
951SB	3/4"
952SB	1"
953SB	1 1/4"
954SB	1 1/2"
955SB	2"
956SB	2 1/2"
957SB	3"
958SB	4"
999SB	6"

O Ring, CHECK VALVE and FOOT VALVE

Part No.	Size
8100	1/2"
8101	3/4"
8102	1"
8103	1 1/4"
8104	1 1/2"
8105	2"
8106	2 1/2"
8107	3" F.V. & C.V. *
8108	4" F.V.
8109	4" - 5" C.V.
8110	6"
8106	3" check only
8112	8" check only
8113	6" High Flow C.V.

* For 3" High Flow Design Poppet

Poppet Spring, FOOT VALVE

Part No.	Size
8201	3/4"
8202	1"
8206	1 1/4"
8208	1 1/2" & 2"
8204	2 1/2" & 3"
8205	4"
8209	6"

Poppet Spring, CHECK VALVE

Part No.	Size
8211	1/2"
8202	3/4"
8206	1" & 1 1/4"
8207	1 1/2" & 2"
8204	2 1/2" & 3"
8210	4" & 5"
8209	6"
8212	8"

Stainless Poppets available upon request.

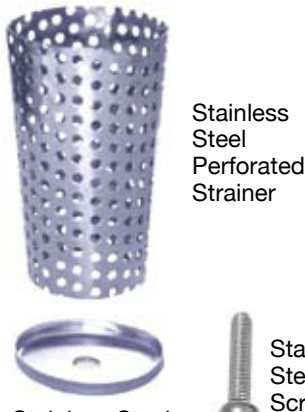

MADE IN U.S.A.

All Simmons Pitless Adapters CERTIFIED WATER TIGHT by the Water Systems Council Pitless Adapter Division.



CERTIFIED LEAD FREE Pitless Adapter

- Silicon bronze body.
- Buna-N O-Ring.
- Vertical position indicator.



NSF/ANSI 372



Part No.	Size	Hole Size Required	Fits Casing Size	Supports lbs.	Weight Each lbs.	Carton Quantity
1820SB	<i>Not available. See 1840SB</i>					
1822SB	1 1/4	2 1/8	5"-12"	5,000	6.0	6



CERTIFIED LEAD FREE Pitless Adapter

- Silicon bronze body.
- Buna-N O-Ring.
- Vertical position indicator.



NSF/ANSI 372



Part No.	Size	Hole Size Required	Fits Casing Size	Supports lbs.	Weight Each lbs.	Carton Quantity
1840SB	1	1 5/8	5"-12"	5,000	3.1	6

Leak tested at 12,922 pounds



CERTIFIED LEAD FREE Pitless Adapter

- Bronze body.
- Buna-N O-Ring.
- Vertical position indicator.
- 150 PSI



Part No.	Size	Hole Size Required	Fits Casing Size	Supports lbs.	Weight Each lbs.	Carton Quantity
1825SB	2	3 1/8	5 5/8"-12"	5,000	10.8	6

MADE IN U.S.A.

*Silicon bronze components contain less than .05% (1/20 of 1%) Lead.

Well Cap --- Painted

- Powder coated polyester finish.
- Conduit type.
- Individually boxed.
- Non Toxic Lead Free Paint.



751-755



760-1

Part No.	Well Casing I.D.	Weight Each lbs.	Carton Quantity
751	4	2.3	1
753	5 5/8	3.8	1
754	6 - 6 1/4	5.2	1
760-1	5 5/8 - 6 1/4	5.5	1

Well Cap --- Galvanized

- Galvanized cast iron.
- Conduit type.
- Individually boxed.



762,763

Part No.	Well Casing I.D.	Weight Each lbs.	Carton Quantity
762	5 5/8	3.8	1
763	6 - 6 1/4	5.2	1

Watertight Well Cap

- Heavy Duty Cast Iron.
- 5 Bolt Construction.
- 1/4" Grounding Lug.
- 9/16" Screened Vent.
- Powder coated polyester finish.
- Individually boxed.
- 1" NPT Conduit Connection.



Part No.	Casing I.D.	Conduit Connection	Weight Each lbs.	Ctn Qty
759	6" & 6 1/4"	1"	9.1	1
759	6" & 6 1/4"	1 1/4"	9.3	1

Watertight Well Caps

- 1" NPT conduit connection.
- Stainless Steel Screened vents.
- Stainless steel nuts and bolts.
- Place under cap to write well and pump reference data.
- Water Systems Council approved.

Part No.	Well Casing I.D./O.D.	Weight Each lbs.	Carton Quantity
SCP4	4 / 4 1/2	.9	1
SCP5	5 / 5 9/16	1.3	1
SCP6	6 / 6 5/8	1.5	1
WCP6	6 / 6 5/8	2.0	1
SCPC6	6 / 6 5/8	1.2	1

SCP4, SCP5, SCP6

Thermoplastic/ABS...2-part

- Injection molded thermoplastic top and ABS bottom, can be solvent welded to PVC well casing.



SCP5



WCP6

WCP6

Thermoplastic/Aluminum...3 part

- For use on steel or plastic casing.
- Thermoplastic top, aluminum middle and bottom rings.



SCPC6

SCPC6

Thermoplastic...2 part

- For use on steel or plastic casing.
- Thermoplastic top with clamp-on bottom rings.

MADE IN U.S.A.

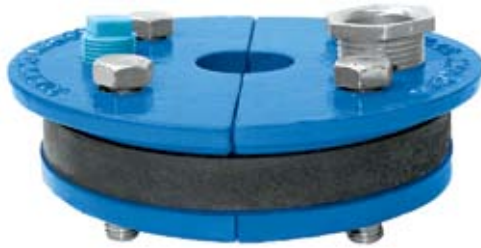

Well Seal

Single Drop Pipe - Split Top Plate - Submersible Pump

- Class 25 Non-toxic lead free painted cast iron.
- Zinc plated steel bolts.
- Single hole.
- 3/4" molded rubber, 50 Durometer.

SIMMONS SUPERIOR PACKAGING

Packaging - All Seals



All well seals are individually boxed...

...then packed 6 per master carton.



6 5/8," 10" and 12" cast iron well seals and all heavy duty cast iron well seals have been replaced by steel well seals.

See pages 17 - 22.

Part No.	Well Size I.D.	Drop Pipe Size	Cable Hole Tapping	Vent Tapping	Weight Each lbs.	Carton Quantity
108	3	1	3/8	1/8	2.1	6
109	3	1 1/4	5/16**	1/8*	2.0	6
111	4	1	3/4	1/2	3.4	6
047	4	1 Offset	3/4	1/2	3.5	6
112	4	1 1/4 Offset	3/4	1/2	3.3	6
105***	4	1 1/4 Offset	3/4	1/2	3.3	6
113	4	1 1/2 Offset	3/4	1/2	2.9	6
114	4	2 Offset	1/2	1/2	2.7	6
116	4 1/4	1	3/4	1/2	3.6	6
117	4 1/4	1 1/4 Offset	3/4	1/2	3.5	6
118	4 1/4	1 1/2 Offset	3/4	1/2	3.1	6
119	4 1/4	2 Offset	1/2	1/2	2.8	6
165	4 1/2	1	3/4	1/2	3.8	6
166	4 1/2	1 1/4	3/4	1/2	3.7	6
167	4 1/2	1 1/2	3/4	1/2	3.5	6
121	5	1	1	1/2	5.6	6
122	5	1 1/4	1	1/2	5.2	6
123	5	1 1/2	3/4	1/2	5.0	6
124	5	2	3/4	1/2	4.3	6
131	5 5/8	1	3/4	1/2	7.3	6
132	5 5/8	1 1/4	3/4	1/2	7.2	6
133	5 5/8	1 1/2	3/4	1/2	6.9	6
134	5 5/8	2	3/4	1/2	6.4	6
136	6	1	1	1/2	7.5	6
137	6	1 1/4	1	1/2	7.1	6
138	6	1 1/2	1	1/2	7.2	6
139	6	2	1	1/2	7.3	6
141	6 1/4	1	1	1/2	7.5	6
142	6 1/4	1 1/4	1	1/2	7.1	6
143	6 1/4	1 1/2	1	1/2	7.4	6
144	6 1/4	2	1	1/2	7.6	6
196	8	1	1	1/2	16.5	1
197	8	1 1/4	1	1/2	16.3	1
198	8	1 1/2	1	1/2	16.0	1
199	8	2	1	1/2	15.2	1
041	8	3	1	1/2	13.4	1
042	8	4	1	1/2	10.9	1

* One 1/8" Drilled hole - no threads.

** Two 5/16" Drilled holes - no threads.

*** Extra Offset

MADE IN U.S.A.

Well Seal

Single Drop Pipe - Solid Top Plate - Submersible Pump

- Class 25 Non-toxic lead free painted cast iron.
- Zinc plated steel bolts.
- Single hole.
- 3/4" molded rubber, 50 Durometer.



Part No.	Well Size I.D.	Drop Pipe Size	Cable Hole Tapping	Vent Tapping	Weight Each lbs.	Carton Quantity
106	2	3/4	1/8	1/8	.7	1
107	2	1	1/8*	1/8*	.7	1
301	4	1	3/4	1/2	3.4	6
301B	4	Blank	-	-	3.6	6
048	4	1 Offset	3/4	1/2	3.3	6
049	4	1 1/4 Offset	3/4	1/2	3.2	6
306	4 1/4	1	3/4	1/2	3.7	6
323	5	1	3/4	1/2	5.6	6
327	5 5/8	1	3/4	1/2	7.3	6
328	5 5/8	1 1/4	3/4	1/2	7.9	6
329	5 5/8	1 1/2	3/4	1/2	7.5	6
313A	6	Blank	1	1/2	8.6	6
313B	6	Blank	-	-	8.9	6
313	6	1	1	1/2	8.1	6
314	6	1 1/4	1	1/2	7.7	6
315	6	1 1/2	1	1/2	7.8	6
316	6	2	1	1/2	7.2	6
021*	6	3 Offset	1	1/2	5.1	6
318	6 1/4	1	1	1/2	8.1	6
319	6 1/4	1 1/4	1	1/2	8.0	6
320	6 1/4	1 1/2	1	1/2	7.8	6
321	6 1/4	2	1	1/2	7.5	6

* One 1/8" Drilled hole - no threads.
Blank Well Seals available upon request.

- Designed to fit outside of well casing.



Part No.	Well Size I.D.	Drop Pipe Size	Vent Tapping	Weight Each lbs.	Carton Quantity
045	2	1 1/4	1/8	3.1	6
046	3	1 1/2	1/8	5.3	6
050	3	2	1/8	4.7	6

Well Seal

Double Drop Pipe - Split Top Plate - Jet Pump

- Class 25 Non-toxic lead free painted cast iron.
- Zinc plated steel bolts.
- Double hole.
- 3/4" molded rubber, 50 Durometer.



Part No.	Well Size I.D.	Drop Pipe Size	Vent Tapping	Weight Each lbs.	Carton Quantity
149	3	1 x 3/4	1/4	1.7	1
152	4	1 1/4 x 1	1/2	2.9	6
333*	4	1 1/4 x 1	1/2	2.9	6
153	4	1 1/4 x 1 1/4	1/2	2.8	6
156	4 1/4	1 1/4 x 1	1/2	3.0	6
157	4 1/4	1 1/4 x 1 1/4	1/2	2.8	6
161	5	1 1/4 x 1	1/2	4.8	6
171	5 5/8	1 1/4 x 1	1/2	6.3	6
172	5 5/8	1 1/4 x 1 1/4	1/2	6.2	6
177	6	1 1/4 x 1	1/2	7.1	6
178	6	1 1/4 x 1 1/4	1/2	7.1	6
183	6 1/4	1 1/4 x 1	1/2	7.3	6
184	6 1/4	1 1/4 x 1 1/4	1/2	7.3	6

* 333 has solid top plate.

MADE IN U.S.A.

Well Seal - Single Drop Pipe - Slotted Cable Hole



- Class 25 Non-toxic lead free painted cast iron.
- Zinc plated steel bolts.
- Single Hole.
- 3/4" molded rubber, 50 Durometer.
- 3/8" x 1 1/8" slotted cable hole.

Part No.	Well Size I.D.	Drop Pipe Size	Vent Tapping	Weight Each lbs.	Carton Quantity
111-S	4	1	1/2	3.5	6
112-S	4	1 1/4	1/4	3.2	6
113-S	4	1 1/2	1/4	3.2	6
114-S	4	2	1/4	2.4	6

Well Seal

Single Drop Pipe - Split Top Plate

- Class 25 Non-toxic lead free painted cast iron.
- Zinc plated steel bolts.
- Single hole.
- 3/4" molded rubber, 50 Durometer.
- **With eye bolt.**



Part No.	Well Size I.D.	Drop Pipe Size	Cable Hole Tapping	Vent Tapping	Weight Each lbs.	Carton Quantity
208	3	1	3/8	1/8	2.1	1
211	4	1	3/4	1/2	3.5	6
212	4	1 1/4	3/4	1/4	3.4	6
216	4 1/4	1	3/4	1/2	3.6	6
217	4 1/4	1 1/4	3/4	1/4	3.5	6
221	5	1	1	1/2	5.5	6
222	5	1 1/4	1	1/2	5.1	6
223	5	1 1/2	1	1/2	5.0	6
224	5	2	3/4	1/2	4.3	6
231	5 5/8	1	3/4	1/2	7.6	6
232	5 5/8	1 1/4	3/4	1/2	7.3	6
233	5 5/8	1 1/2	3/4	1/2	7.2	6
234	5 5/8	2	3/4	1/2	6.8	6
236	6	1	1	1/2	7.5	6
237	6	1 1/4	1	1/2	7.1	6
238	6	1 1/2	1	1/2	7.0	6
239	6	2	1	1/2	6.9	6
241	6 1/4	1	1	1/2	7.5	6
242	6 1/4	1 1/4	1	1/2	7.1	6
243	6 1/4	1 1/2	1	1/2	7.0	6
244	6 1/4	2	1	1/2	6.9	6
296	8	1	1	1/2	16.5	1
297	8	1 1/4	1	1/2	16.3	1
298	8	1 1/2	1	1/2	16.0	1
299	8	2	1	1/2	15.2	1

MADE IN U.S.A.



ABS Well Seals

- Single Hole - Solid Top

- ABS material.
- Zinc plated steel bolts.
- 3/4" molded rubber, 50 Durometer.
- Individually boxed.

Part No.	Well Size I.D.	Drop Pipe Size	Cable Hole Tapping	Vent Tapping	Wgt. Ea. lbs.	Carton Qty.
1900	4	3/4	3/4	1/2	1.4	6
1901	4	1	3/4	1/2	1.4	6
1902	4	1 1/4	3/4	1/2	1.4	6
1903	4	1 1/2	3/4	1/2	1.3	6
1904*	4	2	1/2	1/4	1.2	6
1906**	4	2	3/4	1/2	1.2	6
1910	4 1/4	3/4	3/4	1/2	1.5	6
1911	4 1/4	1	3/4	1/2	1.5	6
1912	4 1/4	1 1/4	3/4	1/2	1.5	6
1913	4 1/4	1 1/2	3/4	1/2	1.4	6
1914*	4 1/4	2	1/2	1/4	1.4	6
1921	5	1	3/4	1/2	2.5	6
1922	5	1 1/4	3/4	1/2	2.3	6
1923	5	1 1/2	3/4	1/4	2.3	6
1924	5	2	3/4	1/4	2.1	6
1931	5 5/8	1	3/4	1/2	2.7	6
1932	5 5/8	1 1/4	3/4	1/2	2.7	6
1933	5 5/8	1 1/2	3/4	1/4	2.6	6
1934	5 5/8	2	3/4	1/4	2.5	6
1939	6	Blank	1	1/2	2.8	6
1940	6	3/4	1	1/2	2.7	6
1941	6	1	1	1/2	2.7	6
1942	6	1 1/4	1	1/2	2.6	6
1943	6	1 1/2	1	1/2	2.5	6
1944	6	2	3/4	1/2	2.4	6
1949	6 1/4	Blank	1	1/2	2.8	6
1950	6 1/4	3/4	1	1/2	2.7	6
1951	6 1/4	1	1	1/2	2.7	6
1952	6 1/4	1 1/4	1	1/2	2.6	6
1953	6 1/4	1 1/2	1	1/2	2.5	6
1954	6 1/4	2	3/4	1/2	2.4	6

*1/2" cable hole.

** with raised fitting support.

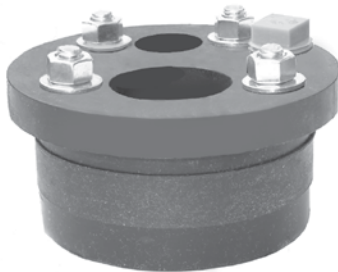

ABS Well Seals

- Double Hole - Solid Top

- ABS material.
- Zinc plated steel bolts.
- 3/4" molded rubber, 50 Durometer.
- Individually boxed.

Part No.	Well Size I.D.	Drop Pipe Size	Vent Tapping	Wgt. Ea. lbs.	Carton Qty.
1905	4	1 1/4 x 1	1/2	1.5	6
1915	4 1/4	1 1/4 x 1	1/2	1.5	6
1925	5	1 1/4 x 1	1/2	2.0	6
1935	5 5/8	1 1/4 x 1	1/2	2.2	6
1936	5 5/8	1 1/4 x 1 1/4	1/2	2.2	6
1945	6	1 1/4 x 1	1/2	2.6	6
1946	6	1 1/4 x 1 1/4	1/2	2.6	6
1955	6 1/4	1 1/4 x 1	1/2	2.8	6
1956	6 1/4	1 1/4 x 1 1/4	1/2	2.8	6

MADE IN U.S.A.

Steel Well Seals *Single Drop Pipe - Solid Top - Submersible Pump*

- A36 hot roll steel.
- Zinc plated steel bolts.
- Single Hole.
- 3/4" molded rubber, 35 Durometer.
- Powder coated polyester finish.
- Individually boxed.



Nominal Casing Size	Standard Gasket O.D.	Smaller Gasket O.D.
4	3.95	-
4 1/4 - 4 1/2	4.20	-
5	4.95	4.76
6	5.95	5.72
6 1/4	6.20	5.95

Standard Gasket Part No.	Smaller Gasket Part No.	Well Size I.D.	Drop Pipe Size	Cable Hole Tapping	Vent Tapping	Top Plate	Max. Load	Weight Each Lbs.	Carton Quantity
3841	-	3	Offset 1 1/4	1/2	1/2	3/16	2,100	1.5	6
3501	-	4	1	3/4	1/2	3/16	2,100	2.1	6
3502	-	4	1 1/4	3/4	1/2	3/16	2,100	1.9	6
3503	-	4	Offset 1 1/4	1	1/2	3/16	2,100	1.8	6
3504	-	4	1 1/2	3/4	1/2	3/16	2,100	1.9	6
3505	-	4	2	1/2	1/2	3/16	2,100	1.7	6
3506	-	4	Offset 1	1	1/2	3/8	9,000	3.0	6
3507	-	4	1 1/4	3/4	1/2	3/8	9,000	2.7	6
3508	-	4	Offset 1 1/4	1	1/2	3/8	9,000	2.6	6
3509	-	4	1 1/2	3/4	1/2	3/8	9,000	2.4	6
3510	-	4	2	1/2	1/2	3/8	9,000	2.3	6
<hr/>									
3511	-	4 1/4 - 4 1/2	1	3/4	1/2	3/16	2,100	2.2	6
3512	-	4 1/4 - 4 1/2	1 1/4	3/4	1/2	3/16	2,100	2.0	6
3513	-	4 1/4 - 4 1/2	Offset 1 1/4	1	1/2	3/16	2,100	2.0	6
3514	-	4 1/4 - 4 1/2	1 1/2	3/4	1/2	3/16	2,100	1.9	6
3515	-	4 1/4 - 4 1/2	2	1/2	1/2	3/16	2,100	1.8	6
3843	-	4 1/4 - 4 1/2	Offset 1	1	1/2	3/8	9,000	3.0	6
3844	-	4 1/4 - 4 1/2	1 1/4	3/4	1/2	3/8	9,000	2.7	6
3845	-	4 1/4 - 4 1/2	Offset 1 1/4	1	1/2	3/8	9,000	2.6	6
3846	-	4 1/4 - 4 1/2	1 1/2	3/4	1/2	3/8	9,000	2.4	6
3847	-	4 1/4 - 4 1/2	2	1/2	1/2	3/8	9,000	2.3	6
<hr/>									
3521	3521-T	5	1	1	1/2	3/16	1,500	2.9	6
3522	3522-T	5	1 1/4	1	1/2	3/16	1,500	2.7	6
3523	3523-T	5	1 1/2	3/4	1/2	3/16	1,500	2.7	6
3524	3524-T	5	2	3/4	1/2	3/16	1,500	2.5	6
3525	3525-T	5	Offset 1	1	1/2	3/8	9,000	4.0	6
3526	3526-T	5	Offset 1 1/4	1	1/2	3/8	9,000	3.9	6
3527	3527-T	5	Offset 1 1/2	3/4	1/2	3/8	9,000	3.8	6
3528	3528-T	5	2	3/4	1/2	3/8	9,000	3.4	6
<hr/>									
3531	3531-T	6	1	1	1/2	3/16	1,100	4.2	6
3532	3532-T	6	1 1/4	1	1/2	3/16	1,100	3.9	6
3533	3533-T	6	1 1/2	1	1/2	3/16	1,100	4.0	6
3530	3530-T	6	2	1	1/2	3/16	1,100	3.7	6
3534	3534-T	6	1	1	1/2	3/8	9,000	5.9	6
3535	3535-T	6	1 1/4	1	1/2	3/8	9,000	5.8	6
3536	3536-T	6	1 1/2	1	1/2	3/8	9,000	5.7	6
3537	3537-T	6	2	1	1/2	3/8	9,000	5.4	6
3550	3550-T	6	Offset 2 1/2	1	1/2	3/8	9,000	4.7	6
3538	3538-T	6	Offset 3	1	1/2	3/8	9,000	4.0	6
3539	-	6	Offset 4	2 - 1/2	1/2	3/8	9,000	3.0	6
<hr/>									
3541	3541-T	6 1/4	1	1	1/2	3/16	1,100	4.3	6
3542	3542-T	6 1/4	1 1/4	1	1/2	3/16	1,100	4.1	6
3543	3543-T	6 1/4	1 1/2	1	1/2	3/16	1,100	4.2	6
3540	3540-T	6 1/4	2	1	1/2	3/16	1,100	3.7	6
3544	3544-T	6 1/4	1	1	1/2	3/8	9,000	5.9	6
3545	3545-T	6 1/4	1 1/4	1	1/2	3/8	9,000	5.8	6
3546	3546-T	6 1/4	1 1/2	1	1/2	3/8	9,000	5.8	6
3547	3547-T	6 1/4	2	1	1/2	3/8	9,000	5.6	6
3560	3560-T	6 1/4	Offset 2 1/2	1	1/2	3/8	9,000	4.7	6
3548	3548-T	6 1/4	Offset 3	1	1/2	3/8	9,000	4.1	6
3549	3549-T	6 1/4	Offset 4	2 - 1/2	1/2	3/8	9,000	3.1	6

MADE IN U.S.A. *Special drop pipe sizes, special tappings and eye-bolts available upon request.*

Steel Well Seals

Single Drop Pipe - Solid Top - Submersible Pump

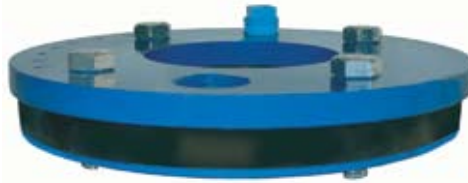

- A36 hot roll steel.
- 3/4" molded rubber, 35 Durometer.
- Single Hole.
- Zinc plated steel bolts.
- Powder coated polyester finish.
- Individually boxed.

Nominal Casing Size	Standard Gasket O.D.	Smaller Gasket O.D.
7	6.625	-
8	7.95	7.60
10	9.95	9.75
12	11.95	11.63
14	13.20	-
16	15.20	-

Standard Gasket Part No.	Smaller Gasket Part No.	Well Size I.D.	Drop Pipe Size	Cable Hole Tapping	Vent Tapping	Top Plate	Max. Load	Weight Each Lbs.	Carton Quantity
3591	-	6 5/8	1	1	1/2	1/4	2,000	6.8	6
3592	-	6 5/8	1 1/4	1	1/2	1/4	2,000	6.6	6
3595	-	6 5/8	1 1/2	1	1/2	3/8	9,000	6.4	6
3596	-	6 5/8	2	1	1/2	3/8	9,000	6.2	6
3597	-	6 5/8	3	1	1/2	3/8	9,000	6.0	6
<hr/>									
3551	3551-T	8	1	1	1/2	3/8	6,900	10.6	1
3552	3552-T	8	1 1/4	1	1/2	3/8	6,900	10.6	1
3553	3553-T	8	1 1/2	1	1/2	3/8	6,900	10.5	1
3554	3554-T	8	2	1	1/2	3/8	6,900	10.4	1
3559	3559-T	8	2 1/2	1	1/2	3/8	6,900	10.1	1
3555	3555-T	8	3	1	1/2	1/2	12,000	10.9	1
3556	3556-T	8	4	1	1/2	5/8	27,000	11.1	1
3558	3558-T	8	5	3/4 (2)	1/2	5/8	27,000	8.9	1
<hr/>									
3561	3561-T	10	1	1	1/2	3/8	3,800	17.4	1
3562	3562-T	10	1 1/4	1	1/2	3/8	3,800	17.1	1
3563	3563-T	10	1 1/2	1	1/2	3/8	3,800	17.0	1
3564	3564-T	10	2	1	1/2	3/8	3,800	16.9	1
3569	3569-T	10	2 1/2	1	1/2	5/8	16,500	22.5	1
3565	3565-T	10	3	1	1/2	5/8	16,500	21.5	1
3566	3566-T	10	4	1 1/4	1/2	5/8	16,500	19.7	1
3567	3567-T	10	5	1 1/4	1/2	3/4	32,000	19.6	1
3568	3568-T	10	6	1	1/2	3/4	34,000	15.9	1
<hr/>									
3571	3571-T	12	1	1	1/2	3/8	2,800	24.9	1
3572	3572-T	12	1 1/4	1	1/2	3/8	2,800	24.0	1
3573	3573-T	12	1 1/2	1	1/2	3/8	2,800	24.0	1
3574	3574-T	12	2	1	1/2	1/2	6,600	29.9	1
3850	3850-T	12	2 1/2	1	1/2	5/8	12,000	31.6	1
3575	3575-T	12	3	1	1/2	5/8	12,000	30.6	1
3576	3576-T	12	4	1 1/4	1/2	5/8	12,000	29.6	1
3577	3577-T	12	5	1 1/4	1/2	3/4	22,000	30.7	1
3578	3578-T	12	6	1 1/4	1/2	3/4	22,000	27.1	1
3594	3594-T	12	8	1/2 (2)	1/2	3/4	22,000	20.6	1
<hr/>									
3802	-	14	2	1 1/4	1/2	3/4	16,000	47.3	1
3804	-	14	4	1 1/4	1/2	3/4	16,000	43.4	1
3806	-	14	6	1 1/4	1/2	1	40,000	45.1	1
3807	-	14	8	1 1/4	1/2	1	40,000	42.0	1
<hr/>									
3814	-	16	4	1 1/4	1/2	3/4	12,500	60.0	1
3815	-	16	5	1 1/4	1/2	3/4	12,500	59.0	1
3816	-	16	6	1 1/4	1/2	1	30,000	62.7	1
3818	-	16	8	1 1/4	1/2	1	30,000	53.9	1
3820	-	16	10	1 1/4	1/2	1	30,000	47.0	1

MADE IN U.S.A. Special drop pipe sizes, special tappings and eye-bolts available upon request.

Steel Well Seals with Flush Bolts

Single Drop Pipe - Solid Top - Submersible Pump

- A36 hot roll steel.
- Stainless steel FLUSH bolts.
- Single Hole.
- 3/4" molded rubber, 35 Durometer.
- Powder coated polyester finish.
- Individually boxed.



Nominal Casing Size	Standard Gasket O.D.	Smaller Gasket O.D.
4	3.95	-
4 1/4 - 4 1/2	4.20	-
5	4.95	4.76
6	5.95	5.72
6 1/4	6.20	5.95

Flush Bolts		Well Size I.D.	Drop Pipe Size	Cable Hole Tapping	Vent Tapping	Top Plate	Max. Load	Weight Each Lbs.	Carton Quantity
Standard Gasket Part No.	Smaller Gasket Part No.								
3501-F	-	4	1	3/4	1/2	3/16	2,100	2.1	6
3502-F	-	4	1 1/4	3/4	1/2	3/16	2,100	1.9	6
3503-F	-	4	Offset 1 1/4	1	1/2	3/16	2,100	1.8	6
3504-F	-	4	1 1/2	3/4	1/2	3/16	2,100	1.9	6
3505-F	-	4	2	1/2	1/2	3/16	2,100	1.7	6
3506-F	-	4	Offset 1	1	1/2	3/8	9,000	3.0	6
3507-F	-	4	1 1/4	3/4	1/4	3/8	9,000	2.7	6
3508-F	-	4	Offset 1 1/4	1	1/2	3/8	9,000	2.6	6
3509-F	-	4	1 1/2	3/4	1/2	3/8	9,000	2.4	6
3510-F	-	4	2	1/2	1/2	3/8	9,000	2.3	6
<hr/>									
3511-F	-	4 1/4 - 4 1/2	1	3/4	1/2	3/16	2,100	2.2	6
3512-F	-	4 1/4 - 4 1/2	1 1/4	3/4	1/4	3/16	2,100	2.0	6
3513-F	-	4 1/4 - 4 1/2	Offset 1 1/4	1	1/2	3/16	2,100	2.0	6
3514-F	-	4 1/4 - 4 1/2	1 1/2	3/4	1/2	3/16	2,100	1.9	6
3515-F	-	4 1/4 - 4 1/2	2	1/2	1/2	3/16	2,100	1.8	6
<hr/>									
3521-F	3521-T-F	5	1	1	1/2	3/16	1,500	2.9	6
3522-F	3522-T-F	5	1 1/4	1	1/2	3/16	1,500	2.7	6
3523-F	3523-T-F	5	1 1/2	3/4	1/2	3/16	1,500	2.7	6
3524-F	3524-T-F	5	2	3/4	1/2	3/16	1,500	2.5	6
3525-F	3525-T-F	5	Offset 1	1	1/2	3/8	9,000	4.0	6
3526-F	3526-T-F	5	Offset 1 1/4	1	1/2	3/8	9,000	3.9	6
3527-F	3527-T-F	5	Offset 1 1/2	3/4	1/2	3/8	9,000	3.8	6
3528-F	3528-T-F	5	2	3/4	1/2	3/8	9,000	3.4	6
<hr/>									
3531-F	3531-T-F	6	1	1	1/2	3/16	1,100	4.2	6
3532-F	3532-T-F	6	1 1/4	1	1/2	3/16	1,100	3.9	6
3533-F	3533-T-F	6	1 1/2	1	1/2	3/16	1,100	4.0	6
3530-F	3530-T-F	6	2	1	1/2	3/16	1,100	3.7	6
3534-F	3534-T-F	6	1	1	1/2	3/8	9,000	5.9	6
3535-F	3535-T-F	6	1 1/4	1	1/2	3/8	9,000	5.8	6
3536-F	3536-T-F	6	1 1/2	1	1/2	3/8	9,000	5.7	6
3537-F	3537-T-F	6	2	1	1/2	3/8	9,000	5.4	6
3550-F	3550-T-F	6	Offset 2 1/2	1	1/2	3/8	9,000	4.7	6
3538-F	3538-T-F	6	Offset 3	1	1/2	3/8	9,000	4.0	6
3539-F	-	6	Offset 4	1/2 (2)	1/2	3/8	9,000	3.0	6
<hr/>									
3541-F	3541-T-F	6 1/4	1	1	1/2	3/16	1,100	4.3	6
3542-F	3542-T-F	6 1/4	1 1/4	1	1/2	3/16	1,100	4.1	6
3543-F	3543-T-F	6 1/4	1 1/2	1	1/2	3/16	1,100	4.2	6
3540-F	3540-T-F	6 1/4	2	1	1/2	3/16	1,100	3.7	6
3544-F	3544-T-F	6 1/4	1	1	1/2	3/8	9,000	5.9	6
3545-F	3545-T-F	6 1/4	1 1/4	1	1/2	3/8	9,000	5.8	6
3546-F	3546-T-F	6 1/4	1 1/2	1	1/2	3/8	9,000	5.8	6
3547-F	3547-T-F	6 1/4	2	1	1/2	3/8	9,000	5.6	6
3548-F	3548-T-F	6 1/4	Offset 3	1	1/2	3/8	9,000	4.1	6
3549-F	3549-T-F	6 1/4	Offset 4	1/2 (2)	1/2	3/8	9,000	3.1	6

MADE IN U.S.A. Special drop pipe sizes, special tappings and eye-bolts available upon request.

Steel Well Seals with Flush Bolts

Single Drop Pipe - Solid Top - Submersible Pump

- A36 hot roll steel.
- Stainless steel FLUSH bolts.
- Single Hole.
- 3/4" molded rubber, 35 Durometer.
- Powder coated polyester finish.
- Individually boxed.



Nominal Casing Size	Standard Gasket O.D.	Smaller Gasket O.D.
7	6.625	-
8	7.95	7.60
10	9.95	9.75
12	11.95	11.63
14	13.20	-
16	15.20	-

Flush Bolts

Standard Gasket Part No.	Smaller Gasket Part No.	Well Size I.D.	Drop Pipe Size	Cable Hole Tapping	Vent Tapping	Top Plate	Max. Load	Weight Each Lbs.	Carton Quantity
3591-F	-	6 5/8	1	1	1/2	1/4	2,000	6.8	6
3592-F	-	6 5/8	1 1/4	1	1/2	1/4	2,000	6.6	6
3595-F	-	6 5/8	1 1/2	1	1/2	3/8	9,000	6.4	6
3596-F	-	6 5/8	2	1	1/2	3/8	9,000	6.2	6
3597-F	-	6 5/8	3	1	1/2	3/8	9,000	6.0	6
<hr/>									
3551-F	3551-T-F	8	1	1	1/2	3/8	6,900	10.6	1
3552-F	3552-T-F	8	1 1/4	1	1/2	3/8	6,900	10.6	1
3553-F	3553-T-F	8	1 1/2	1	1/2	3/8	6,900	10.5	1
3554-F	3554-T-F	8	2	1	1/2	3/8	6,900	10.4	1
3559-F	3559-T-F	8	2 1/2	1	1/2	3/8	6,900	10.1	1
3555-F	3555-T-F	8	3	1	1/2	1/2	12,000	10.9	1
3556-F	3556-T-F	8	4	1	1/2	5/8	27,000	11.1	1
3558-F	-	8	5	3/4 (2)	1/2	5/8	27,000	8.9	1
<hr/>									
3561-F	3561-T-F	10	1	1	1/2	3/8	3,800	17.4	1
3562-F	3562-T-F	10	1 1/4	1	1/2	3/8	3,800	17.1	1
3563-F	3563-T-F	10	1 1/2	1	1/2	3/8	3,800	17.0	1
3564-F	3564-T-F	10	2	1	1/2	3/8	3,800	16.9	1
3569-F	3569-T-F	10	2 1/2	1	1/2	5/8	16,500	22.5	1
3565-F	3565-T-F	10	3	1	1/2	5/8	16,500	21.5	1
3566-F	3566-T-F	10	4	1 1/4	1/2	5/8	16,500	19.7	1
3567-F	3567-T-F	10	5	1 1/4	1/2	3/4	32,000	19.6	1
3568-F	3568-T-F	10	6	1	1/2	3/4	34,000	15.9	1
<hr/>									
3571-F	3571-T-F	12	1	1	1/2	3/8	2,800	24.9	1
3572-F	3572-T-F	12	1 1/4	1	1/2	3/8	2,800	24.0	1
3573-F	3573-T-F	12	1 1/2	1	1/2	3/8	2,800	24.0	1
3574-F	3574-T-F	12	2	1	1/2	1/2	6,600	29.9	1
3575-F	3575-T-F	12	3	1	1/2	5/8	12,000	30.6	1
3576-F	3576-T-F	12	4	1 1/4	1/2	5/8	12,000	29.6	1
3577-F	3577-T-F	12	5	1 1/4	1/2	3/4	22,000	30.7	1
3578-F	3578-T-F	12	6	1 1/4	1/2	3/4	22,000	27.1	1
3594-F	3594-T-F	12	8	1/2 (2)	1/2	3/4	22,000	20.6	1

MADE IN U.S.A. Special drop pipe sizes, special tappings and eye-bolts available upon request.

Steel Well Seals

Blank - No Tappings - Solid Top

- A36 hot roll steel.
- 3/4" molded rubber, 35 Durometer.
- Zinc plated steel bolts.
- Powder coated polyester finish.
- Individually boxed.



Nominal Casing Size	Standard Gasket O.D.	Smaller Gasket O.D.
4	3.95	-
4 1/4 - 4 1/2	4.20	-
5	4.95	4.76
6	5.95	5.72
6 1/4	6.20	5.95
7	6.625	-
8	7.95	7.60
10	9.95	9.75
12	11.95	11.63
14	13.20	-
16	15.20	-

Standard Gasket Part No.	Smaller Gasket Part No.	Well Size I.D.	Cable Hole Tapping	Vent Tapping	Top Plate	Max. Load	Weight Each Lbs.	Carton Quantity
3580A	-	4	3/4	1/2	3/16	2,100	2.2	6
3580B	-	4	-	-	3/16	2,100	2.3	6
3581A	-	4 1/4 - 4 1/2	3/4	1/2	3/16	2,100	2.3	6
3581B	-	4 1/4 - 4 1/2-	-	3/16	2,100	2.4	6	6
3582A	3582A-T	5	1	1/2	3/16	1,500	3.0	6
3582B	3582B-T	5	-	-	3/16	1,500	3.1	6
3583A	3583A-T	6	1	1/2	3/16	1,100	4.3	6
3583B	3583B-T	6	-	-	3/16	1,100	4.4	6
3584A	3584A-T	6	1	1/2	3/8	9,000	6.1	6
3584B	3584B-T	6	-	-	3/8	9,000	6.3	6
3585A	3585A-T	6 1/4	1	1/2	3/16	1,100	4.3	6
3585B	3585B-T	6 1/4	-	-	3/16	1,100	4.4	6
3586A	3586A-T	6 1/4	1	1/2	3/8	9,000	6.1	6
3586B	3586B-T	6 1/4	-	-	3/8	9,000	6.3	6
3599B	3599B-T	6 5/8	-	-	3/8	9,000	7.2	1
3587A	3587A-T	8	1	1/2	3/8	6,900	10.8	1
3587B	3587B-T	8	-	-	3/8	6,900	11.0	1
3821A	3821A-T	8	1	1/2	5/8	27,000	12.8	1
3821B	3821B-T	8	-	-	5/8	27,000	13.1	1
3588A	3588A-T	10	1	1/2	3/8	3,800	17.6	1
3588B	3588B-T	10	-	-	3/8	3,800	17.8	1
3822A	3822A-T	10	1	1/2	3/4	32,000	20.6	1
3822B	3822B-T	10	-	-	3/4	32,000	21.0	1
3589A	3589A-T	12	1	1/2	3/8	2,800	25.3	1
3589B	3589B-T	12	-	-	3/8	2,800	25.6	1
3823A	3823A-T	12	1	1/2	3/4	22,000	29.3	1
3823B	3823B-T	12	-	-	3/4	22,000	29.8	1
3809A	-	14	1 1/4	1/2	3/4	16,000	49.3	1
3819A	-	16	1 1/4	1/2	3/4	12,500	65.0	1

MADE IN U.S.A. Special drop pipe sizes, special tappings and eye-bolts available upon request.

Steel Well Seals

Double Hole - Solid Top

- A36 hot roll steel.
- 3/4" molded rubber, 35 Durometer.
- Zinc plated steel bolts.
- Powder coated polyester finish.
- Individually boxed.

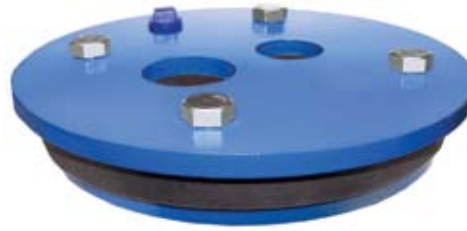

Part No.	Well Size I.D.	Drop Pipe Sizes	Vent Tapping	Top Plate	Max. Load	Weight Each Lbs.	Carton Quantity
3598	6	1 1/4 x 1	1/2	3/16	1,100	5.1	6
3833	6	1 1/2 x 1 1/4	1/2	3/16	1,100	4.7	6
3832	6	2 x 1 1/2	1/2	3/16	1,100	4.5	6
3593	6 1/4	1 1/4 x 1	1/2	3/16	1,100	5.1	6
3834	6 1/4	1 1/2 x 1 1/4	1/2	3/16	1,100	4.7	6
3837	6 1/4	2 x 1 1/2	1/2	3/16	1,100	4.5	6
3557	8	1 1/4 x 1	1/2	1/4	1,800	6.8	1

Steel Well Seals

Bottomless - Solid Top

- A36 hot roll steel.
- One-piece molded rubber gasket with inset.
- Powder coated polyester finish.
- Individually boxed.

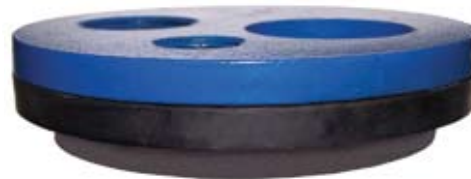

Part No.	Well Size I.D.	Drop Pipe Size	Cable Hole Tapping	Vent Tapping	Top Plate	Max. Load	Weight Each Lbs.	Carton Quantity
3517	4 1/4 - 4 1/2	1	1	1/2	3/8	9,000	2.4	6
3518	4 1/4 - 4 1/2	1 1/4	1	1/2	3/8	9,000	2.3	6
3519	4 1/4 - 4 1/2	1 1/2	1	1/2	3/8	9,000	2.3	6

Well Seal Vent

- PVC.



Part No.	Thread Size	Wgt Each lbs.
750	1/2	.10

Top Guide

- 3/4" molded rubber.
- 50 Durometer.



Well I.D.

2
3
4
4 1/4
4 1/2
5
5 5/8
6
6 1/4
6 5/8
8
10
12

Specify Drop Pipe Size

MADE IN U.S.A.

CERTIFIED LEAD FREE - MODELS 800LF - 818LF 800LF Series Deluxe Frost-Proof Yard Hydrant



- 3/4" or 1" NPT Female Inlet
- 3/4" Male Hose Thread Outlet
- Cast Iron Head and Handle with Blue Polyester Powder Coated Finish.
- Max. Pressure 120 PSI
- Many Parts and Accessories are common for all Models.
- Yard hydrant accessories...See page 27.



Certified by Truesdail Laboratories. Meets all Federal and state Safe Drinking Water Acts and requirements. **Does not meet California Prop. 65 (Environmental Law)**

3/4" Inlet Part No.	1" Inlet Part No.	Bury Depth	Weight Each lbs.
800LF	810LF	1	11.9
801LF	811LF	1 1/2	13.5
802LF	812LF	2	14.5
803LF	813LF	3	16.8
804LF	814LF	4	18.9
805LF	815LF	5	21.2
806LF	816LF	6	23.4
807LF	817LF	7	25.7
808LF	818LF	8	28.2

All Simmons Yard Hydrants are Individually Boxed.

Flow Rates:

(For All Simmons Yard Hydrant Models except 6800 Series)

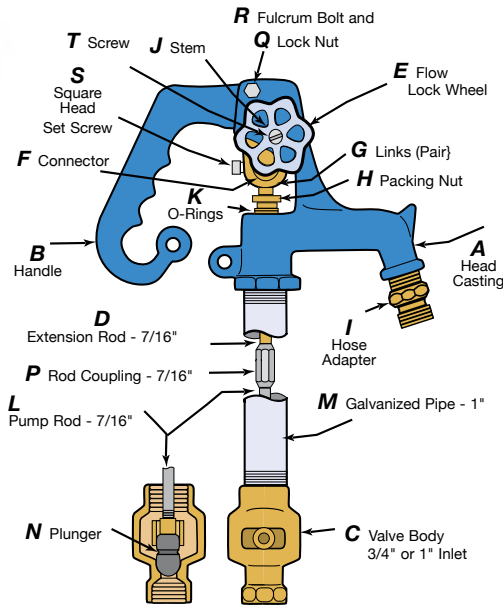
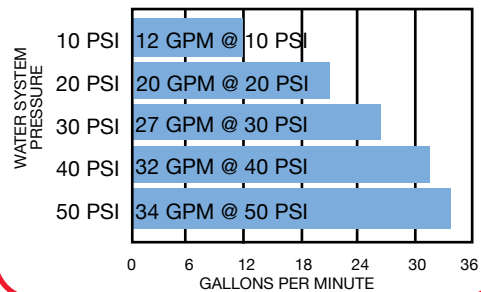

Parts Kit



CERTIFIED LEAD FREE 800LF Series Yard Hydrant Parts

Ref. No.	Name of Part
850SB	Parts Kit
840	Head Complete
A 8820	Head
B 8821	Handle
C 8822SB	Valve Body (3/4")
8832A	Valve Body (1")
D 8845	Extension Rod, 7/16"
E 8824*	Flow Lock Wheel
F 8825•	Brass Connector
G 8826•	Brass Links (Price per Pair)
H 8847•	Brass Packing Nut
I 8844	Hose Adapter
J 8829*	Brass Stem, Square Head
K 8839•	Buna-N "O" Rings (Price per Pair)
L 8814	Pump Rod, 7/16"
M 8815	Galvanized Pipe Casing, 1"
N 8842•	Plunger (One Piece)
P 8834	Rod Coupling, 7/16"
Q 8301•	Stainless Steel Lock Nut
R 8836•	Fulcrum Bolt Stainless Steel
S 8837•	Square Head Set Screw Stainless
T 8610*	Screw for Flow Lock Wheel

•Included in Parts Kit. Refer to Parts Kit photo at left.
*These parts make up the flow lock wheel assembly.

MADE IN U.S.A.

CERTIFIED LEAD FREE - MODELS 820LF - 828LF 800LF Series Deluxe Frost-Proof Yard Hydrant with STAINLESS STEEL PIPE and OPERATING ROD



Recommended for Use in Highly Corrosive Applications

- 3/4" NPT Female Inlet
- 3/4" Male Hose Thread Outlet
- Cast Iron Head and Handle with Blue Polyester Powder Coated Finish.
- Max. Pressure 120 PSI
- Many Parts and Accessories are common for all Models.
- Yard hydrant accessories...See page 27.

Part No.	Bury Depth	Weight Each lbs.
820LF	1	11.9
821LF	1 1/2	13.5
822LF	2	14.5
823LF	3	16.8
824LF	4	18.9
825LF	5	21.2
826LF	6	23.4
827LF	7	25.7
828LF	8	28.2



NSF/ANSI 372

Certified by Truesdail Laboratories. Meets all Federal and state Safe Drinking Water Acts and requirements. **Does not meet California Prop. 65 (Environmental Law)**

All Simmons Yard Hydrants are Individually Boxed.

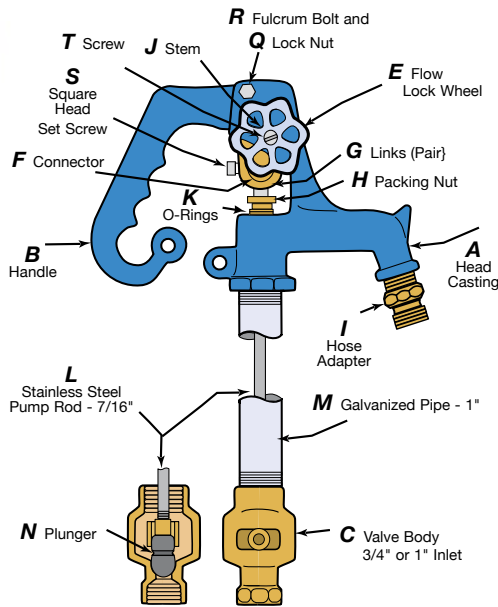

Parts Kit



CERTIFIED LEAD FREE 800LF Series Yard Hydrant Parts MODELS 820LF - 828LF

Ref. No.	Name of Part
850SB	Parts Kit
840	Head Complete
A 8820	Head
B 8821	Handle
C 8822SB	Valve Body (3/4")
8822A	Valve Body (1")
E 8824*	Flow Lock Wheel
F 8825•	Brass Connector
G 8826•	Brass Links (Price per Pair)
H 8847•	Brass Packing Nut
I 8844	Hose Adapter
J 8829*	Brass Stem, Square Head
K 8839•	Buna-N "O" Rings (Price per Pair)
L 8845	Stainless Steel Pump Rod, 7/16"
M 8813	Stainless Steel Pipe, 1"
N 8842•	Plunger (One Piece)
Q 8301•	Stainless Steel Lock Nut
R 8836•	Fulcrum Bolt Stainless Steel
S 8837•	Square Head Set Screw Stainless
T 8610*	Screw for Flow Lock Wheel

*Included in Parts Kit. Refer to Parts Kit photo at left.
*These parts make up the flow lock wheel assembly.

MADE IN U.S.A.

Simmons



CERTIFIED LEAD FREE 4800LF Series Premier Frost-Proof Yard Hydrant

- 3/4" NPT Female Inlet
- 3/4" Male Hose Thread Outlet
- All components are identical to 800LF Series except head casting and handle are smaller. Does not have flow lock wheel.
- Polyester powder coated finish.
- Max. Pressure: 120 PSI
- Individually boxed.
- Refer to 3/4" Flow Rate Chart...Page 23.
- Yard hydrant accessories... See page 27.

Part No.	Bury Depth	Weight Each lbs.
4800LF	1	11.2
4801LF	1 1/2	12.6
4802LF	2	13.6
4803LF	3	15.9
4804LF	4	18.1
4805LF	5	20.6
4806LF	6	23.0
4807LF	7	25.4
4808LF	8	27.8



Certified by Truesdail Laboratories. Meets all Federal and state Safe Drinking Water Acts and requirements. **Does not meet California Prop. 65 (Environmental Law)**

NSF/ANSI 372

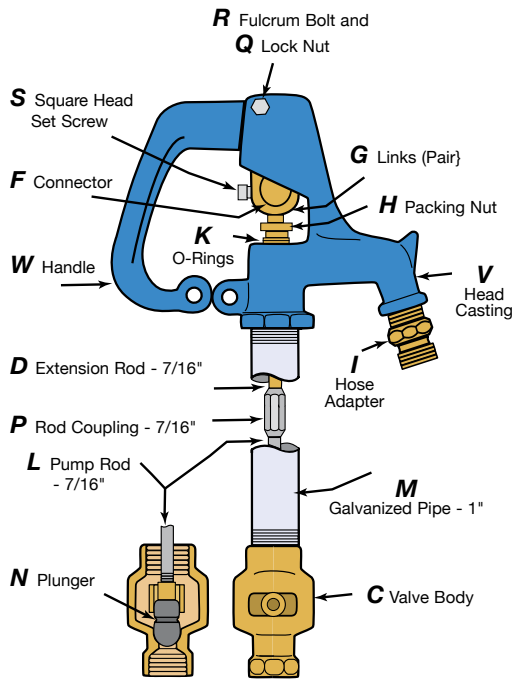

CERTIFIED LEAD FREE 4800LF Series Yard Hydrant Parts

Part Ref. No.	Name of Part
850SB	Parts Kit
890	Head Complete
V 8891	Head
W 8892	Handle
C 8822SB	Valve Body
D 8843	Extension Rod 7/16"
F 8825•	Brass Connector
G 8826•	Brass Links (Price per Pair)
H 8847•	Brass Packing Nut
I 8844	Hose Adapter
K 8839•	Buna-N "O" Rings (Price per Pair)
L 8814	Pump Rod, 7/16"
M 8815	Galvanized Pipe Casing, 1"
N 8842•	Plunger (One Piece)
P 8834	Rod Coupling, 7/16"
Q 8301•	Stainless Steel Lock Nut
R 8836•	Fulcrum Bolt Stainless Steel
S 8837•	Square Head Set Screw Stainless

•Included in Parts Kit.



**Simmons
Superior
Packaging**



Parts Kit

MADE IN U.S.A.

HYDRANTS

CERTIFIED LEAD FREE 800SB Deluxe Frost-Proof Yard Hydrant



- 3/4" NPT Female Inlet
- 3/4" Male Hose Thread Outlet
- Cast iron head and handle.
- Galvanized pipe.
- Stainless steel extension rod.
- Aluminum hose adapter.
- Polyester powder coated finish.
- Max. Pressure: 120 PSI
- Individually Boxed.



NSF/ANSI 372

Certified by Truesdail Laboratories. Meets all Federal and state Safe Drinking Water Acts and requirements including **California Prop. 65**

Part No.	Bury Depth	Weight Each lbs.
800SB	1	12.1
801SB	1 1/2	13.5
802SB	2	14.5
803SB	3	16.5
804SB	4	19.2
805SB	5	21.2
806SB	6	22.8
807SB	7	25.9
808SB	8	28.3



SIMMONS SUPERIOR PACKAGING

CERTIFIED LEAD FREE 800SB Series Yard Hydrant Parts

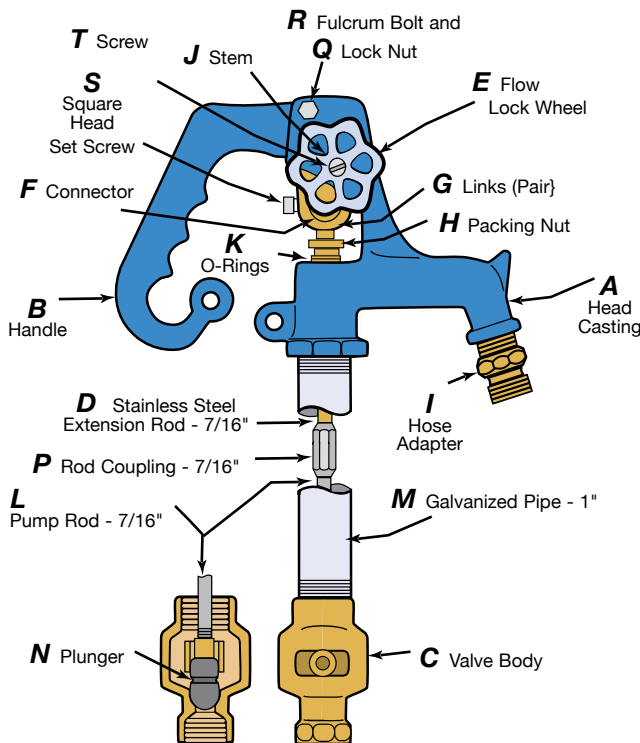

Ref.	Part No.	Name of Part
	850SB	Parts Kit
	840SB	Head Complete
A	8820	Head
B	8821	Handle
C	8822SB	Silicon Bronze Valve Body
D	8843	Stainless Steel Extension Rod 7/16"
E	8824*	Flow Lock Wheel
F	8825•	Brass Connector
G	8826•	Brass Links (Price per Pair)
H	8847•	Brass Packing Nut
I	8844	Aluminum Hose Adapter
J	8829*	Brass Stem, Square Head
K	8839•	Buna-N "O" Rings (Price per Pair)
L	8814	Pump Rod, 7/16"
M	8815	Galvanized Pipe Casing, 1"
N	8842•	Plunger (One Piece)
P	8834	Rod Coupling, 7/16"
Q	8301•	Stainless Steel Lock Nut
R	8836•	Fulcrum Bolt Stainless Steel
S	8837•	Square Head Set Screw St. Steel
T	8610*	Screw for Flow Lock Wheel

- Included in Parts Kit.
- * These parts make up the flow lock wheel assembly.

Parts Kit



Components that come in contact with water supply contain less than .05% (1/20 of 1%) Lead.

MADE IN U.S.A.

LEAD FREE 6800LF Series Sanitary Frost-Proof Yard Hydrant

Not for sale in California or Louisiana



- 3/4" NPT Female Inlet
- 3/4" Male Hose Thread Outlet
- Cast Iron Head & Handle.
- Stainless Steel Cannister.
- Fully Self-Contained.
- Sanitary - Prevents Cross Contamination.
- Individually Boxed.

See Page 47 for additional Sanitary Yard Hydrant specifications and details.

Part No.	Bury Depth	Weight Ea. Lbs.
6800LF	1 ft.	20.5
6801LF	1 1/2 ft.	21.7
6802LF	2 ft.	22.9
6803LF	3 ft.	26.3
6804LF	4 ft.	28.7
6805LF	5 ft.	31.1
6806LF	6 ft.	33.5

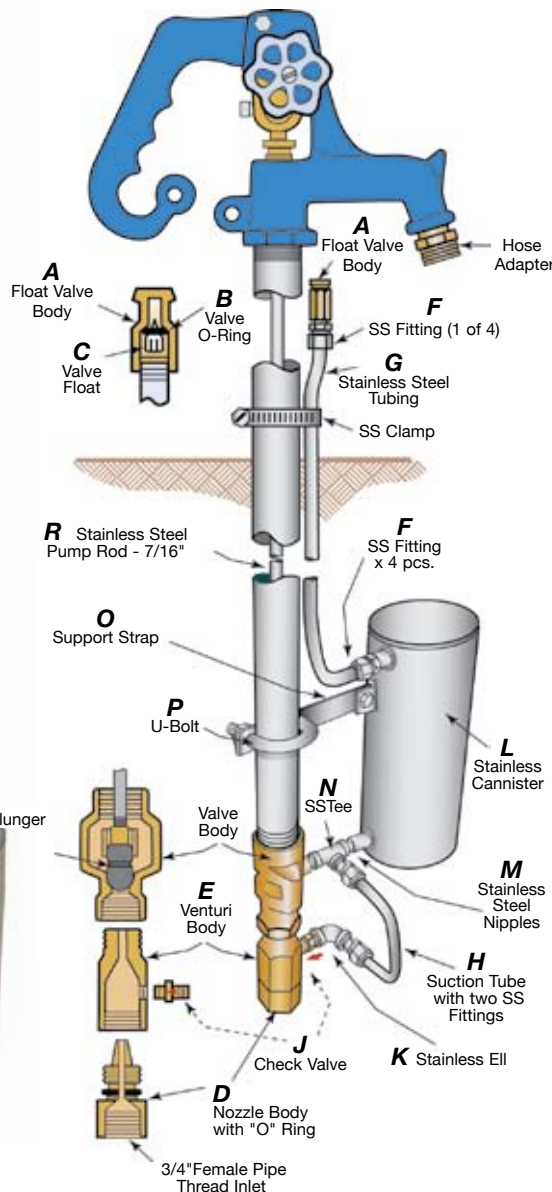
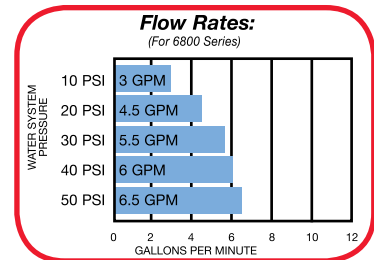

LEAD FREE 6800LF Series Yard Hydrant Parts

Ref.	Part No.	Name of Part
A	6830	Valve Float Body
B	6831	O-Ring for Valve
C	6832	Valve Float
D	6845	Nozzle
E	6846	Venturi
F	6835	3/8 x 1/8 NPT x 4 Fittings 3-Pc. Compression Fitting
G	6836	3/8" Stainless Steel Tubing
R	6851	7/16" Stainless Steel Pump Rod
H	6847	Suction Tube
J	6848	Check Valve
K	6839	1/8" Stainless Steel Ell
L	6840	Stainless Steel Cannister
M	6841	1/8" Stainless Steel Nipple
N	6842	1/8" Stainless Steel Tee
O	6849	Support Strap
P	6852	U-Bolt

MADE IN U.S.A.

Consult 800 Series parts list for any parts not listed in the diagram above.

CERTIFIED LEAD FREE

5800LF Series Designer Series Landscape Hydrant



- 3/4" NPT Female Inlet
- 3/4" Male Hose Thread Outlet
- Series 5800 Landscape Hydrant has floral styling and green color, sure to be the preferred choice of homeowners who take extra pride in their lawns and gardens.
- All components, other than head casting and handle, are identical to 800 Series (page 23).
- Green polyester powder coated finish.
- Max Pressure 120 PSI
- Individually boxed with sales features and installation instructions printed on each box.
- Refer to 3/4" Flow Rate Chart...Page 23.
- See Page 23 for Repair Parts Kit #850SB.
- Refer to Hydrant Lengths, page 46.

Part No.	Bury Depth	Weight Each lbs.
5800LF	1	11.2
5801LF	1 1/2	12.6
5802LF	2	13.6
5803LF	3	15.9
5804LF	4	18.1
5805LF	5	20.6
5806LF	6	23.0



Certified by Truesdail Laboratories. Meets all Federal and state Safe Drinking Water Acts and requirements. **Does not meet California Prop. 65 (Environmental Law)**

Simmons Superior Packaging

CERTIFIED LEAD FREE 5800LF Series Yard Hydrant Parts

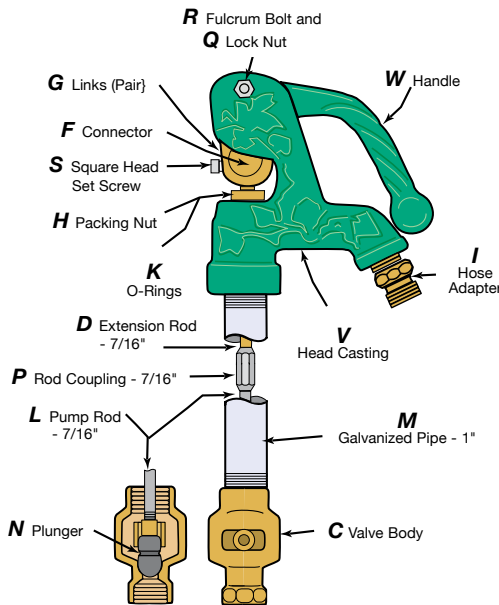

Ref. No.	Part No.	Name of Part
	850SB	Parts Kit
	895	Head Complete
V	8893	Head
W	8894	Handle
C	8822SB	Valve Body
D	8843	Extension Rod 7/16"
F	8825•	Brass Connector
G	8826•	Brass Links (Price per Pair)
H	8847•	Brass Packing Nut
I	8844	Hose Adapter
K	8839•	Buna-N "O" Rings (Price per Pair)
L	8814	Pump Rod, 7/16"
M	8815	Galvanized Pipe Casing, 1"
N	8842•	Plunger (One Piece)
P	8834	Rod Coupling, 7/16"
Q	8301•	Stainless Steel Lock Nut
R	8836•	Fulcrum Bolt Stainless Steel
S	8837•	Square Head Set Screw Stainless

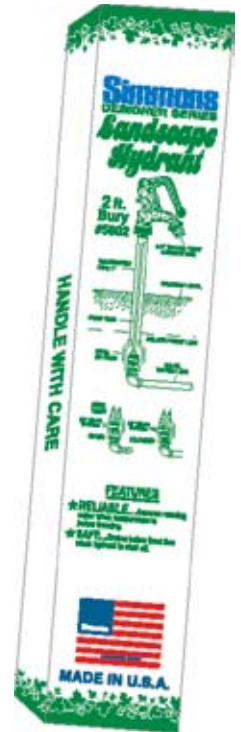

MADE IN U.S.A.

- Included in Parts Kit.

Yard Hydrant Accessories (All models)



860

872

Part No.	Size	Description	Name of Part
860	-	-	Support Bar
872	3/4"	F2030-75	Brass 90° Ell 3/4" MPT x 3/4" Insert
873	3/4" x 1"	F2030-1075	Brass 90° Ell 3/4" MPT x 1" Insert

Certified Lead Free

702SB



CERTIFIED LEAD FREE Tank Tee



- Silicon Bronze.

Part No.	Tank Leg Length Inches	Tapping Each Leg FxM	Tank Connection Tapping FxM	Female Tapping Top of Cross	Three Female Tappings on Side	Weight Each lbs.	Carton Quantity
702SB	3	1x1 1/4	1x1 1/4	-	1/4 each	1.7	12

700SB



CERTIFIED LEAD FREE Tank Cross



- Silicon Bronze.

Part No.	Tank Leg Length Inches	Tapping Each Leg FxM	Tank Connection Tapping FxM	Female Tapping Top of Cross	Female Tappings on Side	Weight Each lbs.	Carton Quantity
700SB	3	3/4x1	1x1 1/4	one-1/2	three-1/4	1.3	12
701SB	3	1x1 1/4	1x1 1/4	one-3/4	three-1/4	1.8	12
710SB	4	3/4x1	1	two-1/2	two-1/4	1.6	12
711SB	4	1x1 1/4	1x1 1/4	two-3/4	two-1/4	2.1	12
712SB	4	3/4x1	1x1 1/4	two-3/4	two-1/4	1.9	12

710SB



712SB



CERTIFIED LEAD FREE Short Tank Cross - Cast



- Silicon Bronze.

Part No.	Tank Leg Length Inches	Tapping Each Leg FxM	Tank Connection Tapping FxM	Female Tapping Top of Cross	Two Female Tappings on Side	Weight Each lbs.	Carton Quantity
735SB	1	3/4x1	1x-	one-1/2	1/4	1.2	12
736SB	1	3/4x1	1x-	two-1/2	1/4	1.3	12

735SB



703SB



CERTIFIED LEAD FREE Long Tank Cross - Cast



- Silicon Bronze.

Part No.	Tank Leg Length Inches	Tapping Each Leg FxM	Tank Connection Tapping FxM	Female Tapping Top of Cross	Two Female Tappings on Side	Weight Each lbs.	Carton Quantity
703SB	10	3/4x1	-x1	one-1/2	1/4	2.1	12
708SB	10	3/4x1	-x1	two-1/2	1/4	2.2	12

708SB



MADE IN U.S.A.

Silicon Bronze components contain less than .05% (1/20th of 1%) of Lead.



NSF/ANSI 372

CERTIFIED LEAD FREE

Long Tank Cross - Fabricated

- Silicon Bronze. • Copper pipe. • Lead-free solder.

709SB



Part No.	Tank Leg Length	Tapping Each Leg FxM	Tank Connection Tapping FxM	Female Tapping Top of Cross	Two Female Tappings on Side	Weight Each lbs.	Carton Quantity
705SB	10	3/4 x 1	-x 1	one-1/2	1/4	1.7	12
709SB	10	3/4 x 1	-x 1	two-1/2	1/4	1.7	12
717SB	13	3/4 x 1	-x 1	one-1/2	1/4	1.9	12
707SB	13	3/4 x 1	-x 1	two-1/2	1/4	1.9	12
7000SB	16	3/4 x 1	-x 1 1/4	two-1/2	1/4	2.1	6
7001SB	13	3/4 x 1	-x 1 1/4	two-1/2	1/4	2.0	12
704SB	13	1 x 1 1/4	-x 1 1/4	one-3/4	1/4	2.4	12
713SB	13	1 x 1 1/4	-x 1 1/4	two-3/4	1/4	2.5	12
706SB	16	1 x 1 1/4	-x 1 1/4	one-3/4	1/4	2.6	6
714SB	16	1 x 1 1/4	-x 1 1/4	two-3/4	1/4	2.6	6

704SB



715SB*	5 1/4	3/4 x 1	1 x-	two-1/2	1/4	1.6	12
7002SB*	4 3/4	3/4 x 1	1 1/4 x-	two-1/2	1/4	1.9	12
716SB*	5 1/4	3/4 x 1	1 x-	one-1/2	1/4	1.6	12
719SB*	4 1/2	1 x 1 1/4	1 1/4 x-	two-3/4	1/4	2.0	12
737SB*	2 1/2	1 x 1 1/4	1 1/4 x-	one-3/4	1/4	2.0	12
738SB*	2 1/2	1 x 1 1/4	1 1/4 x-	two-3/4	1/4	2.0	12

*Female fitting at tank connection

CERTIFIED LEAD FREE

Tank Cross - Cast

- Tank head only. • Sweat connection on tank side. • Silicon Bronze.

715SB



Part No.	Tank Leg Length	Tapping Each Leg FxM	Tank Connection Tapping FxM	Female Tapping Top of Cross	Two Female Tappings on Side	Weight Each lbs.	Carton Quantity
4711SB	1	3/4 x 1	1 Sweat	one-1/2	1/4	.8	1
4713SB	1	1 x 1 1/4	1 1/4 Sweat	one-3/4	1/4	1.3	1
4716SB	1	3/4 x 1	1 Sweat	two-1/2	1/4	.8	1
4717SB	1	1 x 1 1/4	1 1/4 Sweat	two-3/4	1/4	1.3	1

4711SB



CERTIFIED LEAD FREE

Tank Cross - Fabricated - with Union

- Silicon Bronze. • Copper pipe. • Lead-free solder.

745SB



Part No.	Tank Leg Length	Tapping Each Leg FxM	Tank Connection Tapping FxM	Female Tapping Top of Cross	Two Female Tappings on Side	Weight Each lbs.	Carton Quantity
748SB	13	3/4 x 1	-x1	one-1/2	1/4	2.4	12
745SB	13	3/4 x 1	-x1	two-1/2	1/4	2.4	12
749SB	13	1 x 1 1/4	-x1 1/4	one-3/4	1/4	3.1	6
746SB	13	1 x 1 1/4	-x1 1/4	two-3/4	1/4	3.1	6
7040SB	16	1 x 1 1/4	-x1 1/4	one-3/4	1/4	3.2	6
747SB	16	1 x 1 1/4	-x1 1/4	two-3/4	1/4	3.2	6

Silicon Bronze components contain less than .05% (1/20th of 1%) of Lead.

MADE IN U.S.A.

Modifications Available Upon Request

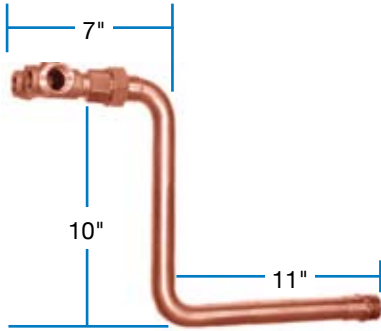

740SB

CERTIFIED LEAD FREE Elevated Tank Cross Fabricated - with Union

- Silicon Bronze. • Copper pipe. • Lead-free solder.



NSF/ANSI 372

Part No.	Tank Leg Length	Height	Tapping Each Leg FxM	Tank Connection Tapping FxM	Female Tapping Top of Cross	Two Female Tappings on Side	Weight Each lbs.	Carton Qty
790SB	11	10	3/4 x 1	-x1	one-1/2	1/4	3.1	6
740SB	11	10	3/4 x 1	-x1	two-1/2	1/4	3.1	6
794SB	8	10	3/4 x 1	-x1	one-1/2	1/4	3.1	6
797SB	11	12	3/4 x 1	-x1	one-1/2	1/4	3.2	6
796SB	11	12	3/4 x 1	-x1	two-1/2	1/4	3.2	6
791SB	11	10	1 x 1 1/4	-x1 1/4	one-3/4	1/4	4.2	6
798SB	11	12	1 x 1 1/4	-x1 1/4	one-3/4	1/4	4.2	3
741SB	11	10	1 x 1 1/4	-x1 1/4	two-3/4	1/4	4.2	6
799SB	11	12	1 x 1 1/4	-x1 1/4	two-3/4	1/4	4.2	3
744SB	14	10	1 x 1 1/4	-x1 1/4	two-3/4	1/4	4.3	3

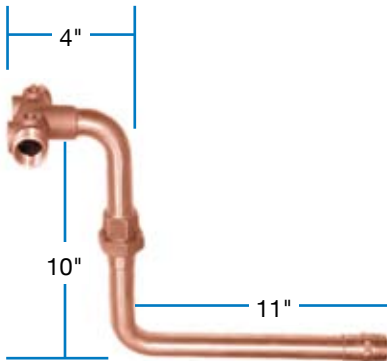

780SB

CERTIFIED LEAD FREE Elevated Tank Cross Fabricated - with Union on Rise

- Silicon Bronze. • Copper pipe. • Lead-free solder.



NSF/ANSI 372

Part No.	Tank Leg Length	Height	Tapping Each Leg FxM	Tank Connection Tapping FxM	Female Tapping Top of Cross	Two Female Tappings on Side	Weight Each lbs.	Carton Qty
784SB	11	10	3/4 x 1	-x1	one-1/2	1/4	3.1	9
789SB	9	10	3/4 x 1	-x1	one-1/2	1/4	2.9	9
780SB	11	10	3/4 x 1	-x1	two-1/2	1/4	3.1	9
788SB	7 1/2	10	3/4 x 1	-x1	two-1/2	1/4	2.9	9
7081SB	11	12	3/4 x 1	-x1	two-1/2	1/4	3.0	9
7892SB	9	10	3/4 x 1	-x1	two-1/2	1/4	2.9	9
785SB	11	10	1 x 1 1/4	-x1 1/4	one-3/4	1/4	4.1	6
7080SB	14	10	1 x 1 1/4	-x1 1/4	one-3/4	1/4	4.2	3
781SB	11	10	1 x 1 1/4	-x1 1/4	two-3/4	1/4	4.1	6



CERTIFIED LEAD FREE Short Elevated Tank Cross - Fabricated - for Flexcon On-line Tank

- Silicon Bronze. • Copper pipe. • Lead-free solder.

Part No.	Tank Leg Length	Height	Tapping Each Leg FxM	Tank Connection Tapping FxM	Female Tapping Top of Cross	Two Female Tappings on Side	Weight Each lbs.	Carton Qty
7012SB*	3 7/8	12 3/8	3/4 x 1	1	two-1/2	1/4	2.7	9
7013SB**	3 7/8	12 3/8	1 x 1 1/4	1 1/4	two-3/4	1/4	3.7	9

* Fits 1" Flexcon on-line Tank.

** Fits 1 1/4" Flexcon on-line Tank.

Silicon Bronze components contain less than .05% (1/20th of 1%) of Lead.

Modifications Available Upon Request

MADE IN U.S.A.

CERTIFIED LEAD FREE Short Elevated Tank Cross - Fabricated - with Union on Rise



NSF/ANSI 372

- Silicon Bronze. • Copper pipe. • Lead-free solder.

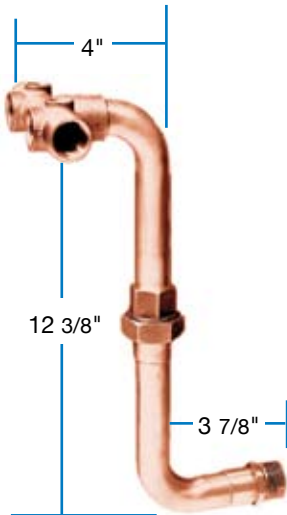

774SB

Part No.	Tank Leg Length	Height	Tapping Each Leg FxM	Tank Connection Tapping FxM	Female Tapping Top of Cross	Two Female Tappings on Side	Weight Each lbs.	Carton Qty
772SB*	3 7/8	12 3/8	3/4 x 1	1x-	one-1/2	1/4	2.8	9
770SB*	3 7/8	12 3/8	3/4 x 1	1x-	two-1/2	1/4	2.8	9
770-125SB*	3 7/8	12 3/8	3/4 x 1	1 1/4x-	two-1/2	1/4	2.8	9
795SB*	3 7/8	10	3/4 x 1	1x-	two-1/2	1/4	2.7	9
773SB*	3 7/8	12 3/8	1 x 1 1/4	1 1/4x-	one-3/4	1/4	3.7	6
771SB*	3 7/8	12 3/8	1 x 1 1/4	1 1/4x-	two-3/4	1/4	3.7	6
775SB	3 7/8	12 3/8	3/4 x 1	-x1	one-1/2	1/4	2.8	9
774SB	3 7/8	12 3/8	3/4 x 1	-x1	two-1/2	1/4	2.8	9
7070SB	3 7/8	10	3/4 x 1	-x1	two-1/2	1/4	2.7	9

* Female fitting at tank connection.



709SBTP

CERTIFIED LEAD FREE Tank Packages

Package Part No.	Tee	0-100 2" Pressure Gauge	1/2" Boiler Drain	3/4" Boiler Drain	1/4x3 Brass Nipple	30-50* FSG-2 Switch	Relief Valve	Weight Each lbs.
703SB TP	703SB	•	•		•	•		4.0
704SB TP	704SB	•		•	•	•		4.4
705SB TP	705SB	•	•		•	•		3.6
708SB TP	708SB	•	•		•	•	•	4.2
709SB TP	709SB	•	•		•	•	•	3.9
710SB TP	710SB	•	•		•	•	•	3.6
712SB TP	712SB	•		•	•	•	•	4.0
735SB TP	735SB	•	•		•	•		3.4
736SB TP	736SB	•	•		•	•	•	3.4
707SB TP	707SB	•	•		•	•	•	4.2
713SB TP	713SB	•		•	•	•	•	4.7
706SB TP	706SB	•		•	•	•		4.7
701SB TP	701SB	•		•	•	•		3.2
738SB TP	738SB	•		•	•	•	•	4.4

• Included in each package



608SB

Package Part No.	Check Valve Included	0-100 2" Gauge	1/4x3 Brass Nipple	1/8" Air Valve	Sq.D* 30-50 Switch	Weight Each lbs.
608SB	601-1"	•	•	•	•	2.7
609SB	602-1 1/4"	•	•	•	•	3.2

* 20/40 pressure switches available on request. Packages come unassembled.

MADE IN U.S.A.

CERTIFIED LEAD FREE Drive Well Point

- Heavy duty galvanized inner pipe.
- Cast iron point.
- Stainless steel gauze and screen.
- Individually Boxed.



Well Point Dimensions

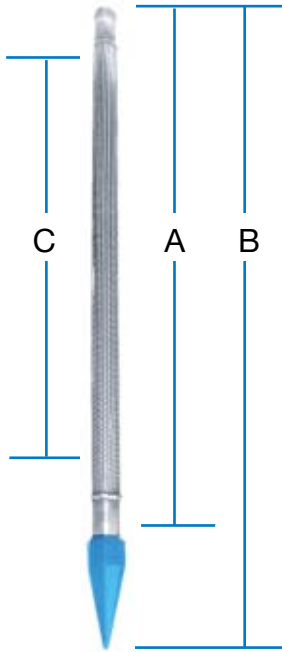

Well Point Lengths

A Pipe Length	B Overall Length	C Jacket Length
24"	30"	18 7/8"
30"	36"	23 7/8"
36"	42"	30 1/4"
42"	48"	35 3/8"
48"	54"	41 1/8"
60"	66"	52 7/8"
66"	72"	59 3/4"
96"	102"	88 3/4"

Slot Size

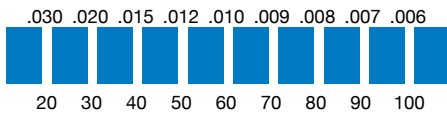

Gauze/Mesh Equivalent

	Stainless Steel Part No.	Gauze	Pipe Length	Pipe Size	Weight Each lbs.
1"	1710-1	60	24	1	4.8
	1711-1	60	30	1	5.7
	1712-1	60	36	1	6.4
	1713-1	80	24	1	4.8
	1714-1	80	30	1	5.7
	1715-1	80	36	1	6.4
1 1/4"	1720-1	60	24	1 1/4	6.6
	1721-1	60	30	1 1/4	8.4
	1722-1	60	36	1 1/4	9.4
	1723-1	60	42	1 1/4	9.9
	1724-1	60	48	1 1/4	11.8
	1725-1	60	60	1 1/4	14.6
	1726-1	80	24	1 1/4	6.6
	1727-1	80	30	1 1/4	8.4
	1728-1	80	36	1 1/4	9.4
	1729-1	80	42	1 1/4	9.9
	1730-1	80	48	1 1/4	11.8
	1731-1	80	60	1 1/4	14.6
1 1/2"	1732-1	100	24	1 1/4	6.6
	1733-1	100	30	1 1/4	8.4
	1734-1	100	36	1 1/4	9.4
	1735-1	100	42	1 1/4	9.9
	1736-1	100	48	1 1/4	11.8
	1737-1	100	60	1 1/4	14.6
2"	1740-1	60	24	1 1/2	7.8
	1741-1	60	30	1 1/2	9.5
	1742-1	60	36	1 1/2	11.0
	1770-1	60	48	1 1/2	14.0
	1775-1	60	60	1 1/2	17.0
	1745-1	80	24	1 1/2	7.8
1746-1	80	30	1 1/2	9.5	
1747-1	80	36	1 1/2	11.0	
2"	1750-1	60	24	2	12.0
	1751-1	60	30	2	14.0
	1752-1	60	36	2	16.3
	1753-1	60	48	2	20.1
	1754-1	60	60	2	23.8
	1756-1	80	24	2	12.0
1757-1	80	30	2	14.0	
1758-1	80	36	2	16.3	
2"	1759-1	80	48	2	20.1
	1760-1	80	60	2	23.8

40, 50, 90, and 100 gauze available upon request

MADE IN U.S.A.



NSF/ANSI 372



CERTIFIED LEAD FREE
Flush Well Point

	Stainless Steel Part No.	Gauze	Pipe Length	Pipe Size	Weight Each lbs.
1 1/4"	1720-2	60	24	1 1/4	6.0
	1721-2	60	30	1 1/4	8.0
	1722-2	60	36	1 1/4	9.0
	1723-2	60	42	1 1/4	10.0
	1724-2	60	48	1 1/4	11.0
	1725-2	60	60	1 1/4	14.0
	1726-2	80	24	1 1/4	6.0
	1727-2	80	30	1 1/4	8.0
	1728-2	80	36	1 1/4	9.0
	1729-2	80	42	1 1/4	10.0
	1730-2	80	48	1 1/4	11.0
	1731-2	80	60	1 1/4	14.0

40, 50, 90, and 100 gauze available upon request.



NSF/ANSI 372



CERTIFIED LEAD FREE
Well Screen

	Stainless Steel Part No.	Gauze	Pipe Length	Pipe Size	Weight Each lbs.
1 1/4"	1720-3	60	24	1 1/4	4.0
	1721-3	60	30	1 1/4	6.0
	1722-3	60	36	1 1/4	7.0
	1723-3	60	42	1 1/4	8.0
	1724-3	60	48	1 1/4	9.0
	1725-3	60	60	1 1/4	12.0
	1726-3	80	24	1 1/4	4.0
	1727-3	80	30	1 1/4	6.0
	1728-3	80	36	1 1/4	7.0
	1729-3	80	42	1 1/4	8.0
	1730-3	80	48	1 1/4	9.0
	1731-3	80	60	1 1/4	12.0
1 1/2"	1742-3	60	36	1 1/2	8.0
	1770-3	60	48	1 1/2	12.0
	1775-3	60	60	1 1/2	15.0
2"	1750-3	60	24	2	9.0
	1751-3	60	30	2	9.5
	1752-3	60	36	2	12.5
	1753-3	60	48	2	15.0
	1754-3	60	60	2	18.0
	1756-3	80	24	2	9.0
	1757-3	80	30	2	9.5
	1758-3	80	36	2	12.5
	1759-3	80	48	2	15.0
	1760-3	80	60	2	18.0

40, 50, 90, and 100 gauze available upon request

MADE IN U.S.A.



CERTIFIED LEAD FREE Drive Well Point - Inside Gauze

Stainless Part No.	Gauze	Length	Size	Weight lbs.		
1 1/4"	1721	60	30	1 1/4	8.0	
	1722	60	36	1 1/4	10.0	
	1724	60	48	1 1/4	11.0	
	1725	60	60	1 1/4	14.0	
	1727	80	30	1 1/4	8.0	
	1728	80	36	1 1/4	10.0	
	1730	80	48	1 1/4	11.0	
	1731	80	60	1 1/4	14.0	
	2"	1752	60	36	2	16.5
		1753	60	48	2	19.3
1754		60	60	2	21.0	
1758		80	36	2	16.5	
1759		80	48	2	19.3	
1760		80	60	2	21.0	



LEAD FREE Drive Point Head Female Thread

Part No.	Size	Weight Each lbs.
1690	1 1/4	1.5
1693	1 1/2	1.9
1694	2	3.7



LEAD FREE Flush Point Head Male Thread

1692	1	1.2
1691	1 1/4	1.5



Drive Cap

1695	1 1/4	1.3
1697	2	3.0

MADE IN U.S.A.



CERTIFIED LEAD FREE Galvanized Steel Coupling - Standard



NSF/ANSI 372

Part No.	Pipe Size Ins.	Outside Diameter Ins.	Wgt Each lbs.
941	1 1/4	1.937	.5



CERTIFIED LEAD FREE Galvanized Steel Coupling - Turned O.D.



NSF/ANSI 372

Part No.	Pipe Size Ins.	Outside Diameter Ins.	Wgt Each lbs.
*942	1 1/4	1.812	.5
*942 enters 2" Pipe.			



CERTIFIED LEAD FREE Galvanized Steel Coupling Drive



NSF/ANSI 372

Part No.	Pipe Size Ins.	Outside Diameter Ins.	Wgt Each lbs.
946	1 1/4	2.07	.9
947	1 1/2	2.21	1.3
948	2	2.75	1.4

IMPORT



MAS

Male Adapter

- Galvanized Steel.



FAS

Female Adapter

- Galvanized Steel.



XS

Long Adapter

- Galvanized Steel.



RAS

Reducing Adapter

- Galvanized Steel.



ZAB

Venturi Male Adapter w/Lug

- Bronze.



ZBB

Male Adapter w/Lug

- Bronze.

MADE IN U.S.A.

Certified Lead Free.



9486

Rope Adapter - Import

- Bronze.

Galvanized Steel Part No.	Red Brass Part No.	Size Inches	Carton Quantity	Weight Each lbs.
MAS-2	MAB-2	1/2	25	.15
MAS-3	MAB-3	3/4	25	.2
MAS-4	MAB-4	1	20	.3
MAS-5	MAB-5	1 1/4	20	.5
MAS-6	MAB-6	1 1/2	10	.7
MAS-8	MAB-8	2	10	.9
MAS-10	----	2 1/2	Bulk	1.6
MAS-12	----	3	Bulk	2.8
MAS-16	----	4	Bulk	4.7

Galvanized Steel Part No.	Red Brass Part No.	Size Inches	Carton Quantity	Weight Each lbs.
----	FAB-2	1/2	Bulk	.25
FAS-3	FAB-3	3/4	Bulk	.4
FAS-4	FAB-4	1	Bulk	.5
FAS-5	FAB-5	1 1/4	Bulk	.7

Galvanized Steel Part No.	Red Brass Part No.	Size Inches	Carton Quantity	Weight Each lbs.
XS-4	XB-4	1	Bulk	.5
XS-5	XB-5	1 1/4	Bulk	.8

Galvanized Steel Part No.	Red Brass Part No.	NPT x Insert Size Inches	Carton Quantity	Weight Each lbs.
RAS-3-2	----	3/4 x 1/2	Bulk	.3
RAS-4-3	----	1 x 3/4	Bulk	.4
RAS-5-4	RAB-5-4	1 1/4 x 1	Bulk	.6

All Steel Fittings are A53 Galvanized Grade B Hot Roll Electric Weld.

Part No.	Size Inches	Carton Quantity	Weight Each lbs.
ZAB-4	1	Bulk	1.0

Part No.	Size Inches	Carton Quantity	Weight Each lbs.
ZBB-4	1	Bulk	.7

Part No.	Description	Size Inches	Carton Quantity	Weight Each lbs.
9486*	F2070BZ-100	1	1	1.0

Certified Lead Free

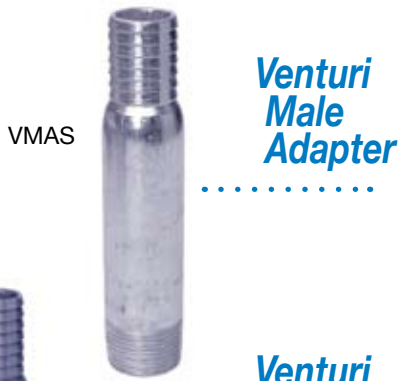

Venturi Male Adapter



Venturi Female Adapter

- Bronze.



Coupling



Reducing Coupling

- Galvanized Steel



Swaged Nipple



Well Seal Ell

- Insert X Insert

Galvanized Steel Part No.	Red Brass Part No.	Size Inches	Carton Quantity	Weight Each lbs.
VMAS-4x6	VMAB-4x6	1	Bulk	.7
VMAS-4x8	VMAB-4x8	1	Bulk	.9
VMAS-4x10	-----	1	Bulk	1.2
VMAS-5x6	VMAB-5x6	1 1/4	Bulk	.9
VMAS-5x8	VMAB-5x8	1 1/4	Bulk	1.3
VMAS-5x10	-----	1 1/4	Bulk	1.6

Galvanized Steel Part No.	Red Brass Part No.	Size Inches	Carton Quantity	Weight Each lbs.
----	VFAB-4x6	1	Bulk	.9
----	VFAB-5x6	1 1/4	Bulk	1.3

Galvanized Steel Part No.	Red Brass Part No.	Size Inches	Carton Quantity	Weight Each lbs.
CS-2	CB-2	1/2	25	.1
CS-3	CB-3	3/4	25	.2
CS-4	CB-4	1	20	.2
CS-5	CB-5	1 1/4	20	.5
CS-6	----	1 1/2	10	.5
CS-8	----	2	10	1.0
CS-10	----	2 1/2	Bulk	1.6
CS-12	----	3	Bulk	2.5

Part No.	Size Inches	Carton Quantity	Weight Each lbs.
RCS-3-2	3/4 x 1/2	Bulk	.2
RCS-4-3	1 x 3/4	Bulk	.5
RCS-5-4	1 1/4 x 1	Bulk	.6

Galvanized Steel Part No.	Red Brass Part No.	Size Inches	Carton Quantity	Weight Each lbs.
NS-3-2	----	3/4 x 1/2	Bulk	.3
NS-4-3	----	1 x 3/4	Bulk	.4
NS-5-4	----	1 1/4 x 1	Bulk	.5
NS-6-5	----	1 1/2 x 1 1/4	Bulk	.6

Galvanized Steel Part No.	Red Brass Part No.	Size Inches	Carton Quantity	Weight Each lbs.
WSL-3A	----	3/4	Bulk	1.1
WSL-4A	----	1	Bulk	1.9
WSL-5A	----	1 1/4	Bulk	2.8

MADE IN U.S.A.

Certified Lead Free.

Air Volume Controls



1223 *Lead free; not for sale in CA or LA*



1231 **Certified Lead Free.**

- Deep well.
- Steel case.

Part No.	Type	Description	Wgt Each lbs.
1223	WJ	Deep Well	1.0
1231	F93B	Deep Well	1.0



- Optional Fittings Package includes: 1/4" compression fitting for plastic tube and tubing.

Lead free; not for sale in CA or LA

1236

1236	Jet Pump	Plastic	.25
1237	Kit	see note	.1
1239	Package	Includes 1236 and 1237	1.0



CERTIFIED LEAD FREE

- Brady.

1234

1234	Deep Well	Plastic	.50
------	-----------	---------	-----



CERTIFIED LEAD FREE

- Brady.
- Non-Repairable.

1184

Part No.	Model No.	Maximum Tank Size	Weight Each lbs
1184	AV 45	thru 80	.75
1185	AV 100	thru 100	.75
1186*	AV 45F	thru 80	.75
1187*	AV 100F	thru 100	.75

*Female threads

1190	AV 30	42	.5
1191	AV 42	70	.75
1192	AV 80	120	1.5
1193	AV 120	220	2.0



CERTIFIED LEAD FREE

- Brady.
- Repairable.
- With 1/4" Gauge Tap.

1190

Repair Kits

Part No.	Model No.	Description
1196	AV - 30 - 3A	repair kits
1197	AV - 42 - 3A	repair kits
1198	AV - 80 - 3A	repair kits
1199	AV-120 - 3A	repair kits



PLASTIC SERIES VALVES

Brady Foot Valve

- Sizes -- 3/4" through 1 1/2."
- Spring loaded.
- Acetal polymer material.

Part No.	Size	Weight Each lbs.	Carton Quantity
445	3/4	.2	1
446	1	.2	1
447	1 1/4	.3	1
448	1 1/2	.6	1



Brady Check Valve

- Sizes -- 3/4" through 1 1/2."
- Spring loaded.
- Acetal polymer material.

Part No.	Size	Weight Each lbs.	Carton Quantity
645	3/4	.1	1
646	1	.2	1
647	1 1/4	.3	1
648	1 1/2	.4	1

MADE IN U.S.A.

Brady valves have a working pressure of 175 psi.

Certified Lead Free.



1243



1244

Air Valves

- 1/8" Steel.
- 1/4" Brass.

Part No.	Size Inches	Description	Weight Each lbs.
1243	1/8	Shallow and Deep Well Pumps	.10
1244	1/4	Shallow and Deep Well Pumps	.12
1242	-	Core Only	-

Certified Lead Free.



1300

Pressure Gauges - Import

- Steel case.
- Glass face.
- Brass mount.

Part No.	Size Inches	Range	Connection	Weight Each lbs.
1300	2	0-100 lbs.	1/4 L.M.	.25
1301	2	0-200 lbs.	1/4 L.M.	.25
1302	2	0-100 lbs.	1/8 C.B.M.	.25

Packaged 100 per carton.

Contains Lead, for export only.



1305

CERTIFIED LEAD FREE Pressure Gauges - Import

- Steel case.
- Glass face.
- Brass mount.

Part No.	Sub Part No.	Size Inches	Range	Connection	Weight Each lbs.
1305	Y50T-100	2	0-100 lbs.	1/4 L.M.	.25
1306	Y50T-200	2	0-200 lbs.	1/4 L.M.	.25
1307	Y50Z-100	2	0-100 lbs.	1/8 C.B.M.	.25

Packaged 100 per carton.

Certified Lead Free.



1360

Submersible Rope

- Rated in excess of 1000 pounds.
- Individually boxed.
- Hollowbraid.



NSF/ANSI 372

Part No.	Size	Material	Weight Each lbs.
1360	500'	Polypropylene fibre	4.7
1361	1000'	Polypropylene fibre	9.6
1362	3000'	Polypropylene fibre	29.0

Certified Lead Free.

MADE IN U.S.A.



Torque Arrestor

- Fits 4-8" well casing.
- Supplied with two stainless steel clamps.
- Packed 18 per carton.



Part No.	Size	Material	Weight Each lbs.
1350	Fits 1" or 1 1/4" Drop Pipe	Rubber	2.2

Certified Lead Free.

MADE IN U.S.A.



Cable Guard

- Plastic.
- 1" - 1 1/4" pipe size.



Part No.	Description	Carton Quantity	Weight Ea. 100 lbs.
1358	With Split Wire Hole	100	1.6

Certified Lead Free.

MADE IN U.S.A.



Lightning Arrestor

- 500 volt surge protection.
- 16GA wire.

Part No.	Description	Carton Quantity
1365	Lightning Protection	1

MADE IN U.S.A.



Splicing Kits

- Individually packaged.
- With crimp connectors.

Part No.	Sleeve Size Inches	Material	Tubes Per Kit	Weight lbs. per 100
1370	3/8" x 3"	2-wire, 10-12-14	2	2.0
1371	3/8" x 3"	3-wire, 10-12-14	3	3.0
1372	3/8" x 3"	4-wire, 10-12-14	4	4.0
1373	3/4" x 6"	#8	3	4.0

Certified Lead Free.

MADE IN U.S.A.



Solderless Crimp Connectors

Part No.	Wire Sizes	Quantity per bag	Weight lbs. per bag
1376	10-12-14	50	.25
1377	8	25	.25

Certified Lead Free.

MADE IN U.S.A.



Compression Splicing Kits

- Import **

- Individually packaged.
- With crimp connectors.

Part No.	Sleeve Size Inches	Material	Tubes Per Kit	Weight lbs. per 100
1225	Compression	2-wire, 10-12-14	2	10.0
1235	Compression	3-wire, 10-12-14	3	12.0

Certified Lead Free.



CERTIFIED LEAD FREE Pressure Switches

- Square D.
- Class 9013.
- Individually Boxed.



Part No.	Type	Pressure Connection IPS	Pressure Range	Weight Each lbs.
1001	FSG1	1/8	20-65	1.0
1002	FSG2	1/4	20-65	1.0
1004	FSG2P	1/4	20-65	1.0
1006	FSG2M1	1/4	20-65	1.0
1007	FSG2M1P	1/4	20-65	1.0
1008	FSG2M4	1/4	20-65	1.0
1009	FYG2	1/4	20-80	1.0
1010	FYG2P	1/4	20-80	1.0
1032	PC-241 repair kit for FSG-2 switch			0.5

The "P" at the end of the switch type designates that it is equipped with a pulsation plug. M1 has manual cut out. M4 has automatic low pressure cutoff.

Above switches available in 20 Pound increments.



Part No.	Type	Pressure Connection IPS	Pressure Range	Weight Each lbs.
1011	GSG1	1/8	20-60	2.00
1012	GSG2	1/4	20-60	2.00
1013	GSG3	3/8	20-60	2.00
1016	GHG1	1/8	60-200	2.25
1017	GHG2	1/4	60-200	2.25
1018	GHG3	3/8	60-200	2.25



Important: Specify pressure setting when ordering.

Foot Valve - Certified Lead Free - Import*

- Brass.



Part No.	Size	Wgt lbs.	Ctn Qty
7402	3/4	.4	1
7403	1	.6	1
7405	1 1/4	1.1	1
7406	1 1/2	1.3	1
7407	2	2.1	1

*Brass components contain less than .10% (1/10 of 1%) Lead.

Check Valve - Certified Lead Free - Import*

- Brass.



Part No.	Size	Wgt lbs.	Ctn Qty
7501	1/2	.4	1
7502	3/4	.6	1
7503	1	.8	1
7504	1 1/4	1.2	1
7505	1 1/2	1.4	1
7506	2	2.4	1



Pitless Adapter - Import

- Bronze body.
- Buna-N O-Ring.
- Vertical position indicator.



Part No.	Description	Size	Hole Size Required	Wgt Each lbs.	Carton Quantity
1850LF	F-2220-100	1	1 5/8	3.0	6
1851LF	F-2220-125	1 1/4	2 1/8	4.5	6

Certified Lead Free.



Pressure Switch - Import

- Individually boxed.

Part No.	Pressure Connection IPS	Pressure Setting	Weight Each lbs.
1040	1/4	20-40	1.0
1041	1/4	30-50	1.0
1042	1/4	40-60	1.0

Lead Free, Not for sale in CA or LA.



LEAD FREE Brass Relief Valve - Import

- Cast brass finish.
- Pressure only relief valve.
- Factory preset at 75 psi.

Part No	Size Inches	Wgt Each lbs.	Carton Quantity	Master Ctn Qty
450-5	1/2	.35	1	50
450-75	3/4	.35	1	50

Certified Lead Free.



Vent Pipe - Import

- 1/2" zinc plated steel pipe.
- Stainless steel bug screen.
- For ventilating wells to atmosphere.
- Individually boxed.

Part No	Size Inches	Wgt Each lbs.	Carton Quantity
1238	1/2	.35	1



Bleeder Orifice - Import

- One piece.

Part No.	Size	Description	Wgt. Ea. Lbs
1353	1" MPT	Rubber	.25

Lead Free, Not for sale in CA or LA.

Tank Cross - Cast - Import

• Bronze.

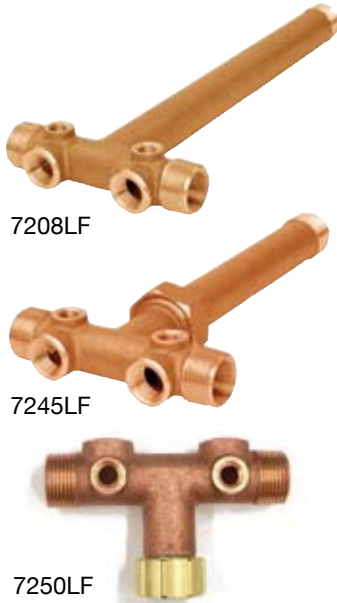

Part No.	Description	Overall Length Inches	Tapping Each Leg FxM	Tank Connection Tapping FxM	Female Tapping Top of Cross	Two Female Tappings on Side	Weight Each lbs.	Carton Qty
7208LF	F2121C-1L11	11	3/4 x 1	-x1	one-1/2	1/4	2.0	24
7204LF	F2172-125L14	14	1 x 1 1/4	-x1 1/4	two-3/4	1/4	3.5	16
7207LF	F2172C-1L14	14	3/4 x 1	-x1	two-1/2	1/4	2.0	20
7208LF	F2172C-1L11	11	3/4 x 1	-x1	two-1/2	1/4	2.0	24
7210LF	F2130C-100	4 1/2	3/4 x 1	3/4 x 1	two-1/2	1/4	1.1	40
7245LF*	F2172UC-1L11	11	3/4 x 1	-x1	two-1/2	1/4	2.0	20
7247LF*	F2172UC-125L14	14	1 x 1 1/4	-x1 1/4	two-3/4	1/4	4.0	12
7250LF	F2600C-100	4	3/4 x 1	1" FPT Union	two-1/2	1/4	1.2	32
7251LF	F2600C-125	4	1 x 1 3/4	1 1/4" FPT Union	two-3/4	1/4	1.5	24

* With Union

7250LF uses 212 O-Ring. 7251LF uses 320 O-Ring.

Certified Lead Free

Tank Cross - Cast Iron - Import

• Galvanized.



Part No.	Galvanized Nipple	Female Tapping Each Leg	Female Tapping Top of Cross	Two Female Tappings on Side	Weight Each lbs.	Carton Quantity
720	none	1	3/4	1/4	1.5	1
725	none	1 1/4	3/4	1/4	2.0	1
721	1 x 8 & 1/4 x 3	1	3/4	1/4	3.0	1
726	1 1/4 x 11 & 1/4 x 3	1 1/4	3/4	1/4	2.5	1

Certified Lead Free



Tank Manifold - Cast - Import

- Lead-free bronze.
- For constant pressure applications.
- 12" long, 1 1/4 M and 1" F threads at both ends.
- Mounting kit available.

Part No.	Tank Leg Length Inches	Tapping Each End (F x M)	Tank Connection Tappings Inches	Female Tappings Front of Manifold	Weight Each lbs.	Carton Quantity
7020	1	1 x 1 1/4	1" Female (two)	Two 3/4" One 1/4"	2.6	12

Lead Free, not for sale in CA and LA.

CERTIFIED LEAD FREE Pitcher Pump and Parts - Import

- 25' Max Suction Lift.
- Painted Cast Iron.
- Leather plunger cup.
- Individually boxed.



Part No.	Pipe Connection Description	Weight Each lbs.
1160	1 1/4	15.2
1161	Complete Plunger Assembly including leather	-
1162	Flat Leather for Base Valve	-
1163	Weight and Screw for Flat Leather	-
1164	Pump Base with Bolts	-
1165	Pump Cylinder	-
1166	Pump Top with Set Screw	-
1167	Pump Handle with Bolts	-
1168	Flat Valve Leather and Weight	-
1169	Plunger Cup Leather	-



LEAD FREE

900 Series Frost -Proof Yard Hydrant - Import

Not for sale in CA or LA.



- 3/4" NPT Female Inlet
- 3/4" Male Hose Thread Outlet
- Cast Iron Head and Handle, with Blue Polyester Powder Coated Finish.
- Individually Boxed.
- Max Pressure 70 PSI
- Refer to 3/4" Flow Rate Chart...Page 23.

Part No.	Bury Depth	Weight Each lbs.
900	1	11.2
902	2	13.5
903	3	15.6
904	4	17.7
905	5	19.9
906	6	22.0

851 Parts Kit... for Simmons Series 900 Yard Hydrants).

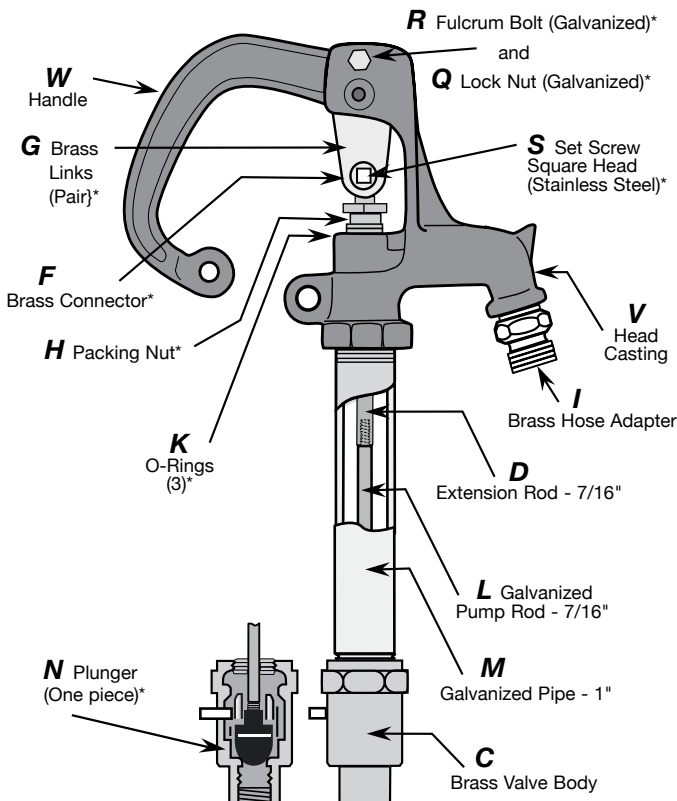

900 Series Yard Hydrant Parts

Ref. No.	Name of Part
841	Complete Head
851	Parts Kit
V 8860	Head
W 8861	Handle
C 8862	Valve Body
D 8863	Extension Rod, 7/16"
F 8864•	Brass Connector
G 8865•	Brass Links (Price per Pair)
H 8869•	Brass Packing Nut
I 8872	Brass Hose Adapter
K 8870•	Buna-N "O" Rings (Price per Pair)
L 8814	Galvanized Pump Rod, 7/16"
M 8815	Galvanized Pipe Casing, 1"
N 8871•	Plunger (One Piece)
Q 8867•	Lock Nut (Galvanized)
R 8866•	Fulcrum Bolt (Galvanized)
S 8868•	Square Head Set Screw St. Steel

- Included in Parts Kit.
- Refer to 851 Parts Kit photo above.

Dimensions

Foot Valves

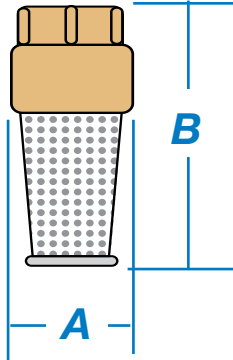

Part No.	A Diameter Inches	B Length Inches
404SB	1 15/16	5
452SB	1 3/8	3 3/4
453SB	1 3/4	4 3/4
454SB	2 1/16	5
455SB	2 5/16	5 1/4
456SB	2 5/8	6 5/16
457SB	3 1/2	7 3/16
458SB	4	9 3/8
459SB	4 5/8	9 1/2
460SB	6	13 7/8
461SB	7 1/2	15 3/4
465SB	1 5/16	3 3/4
466SB	1 5/8	5
467SB	1 15/16	5

IMPORT VALVES

7402	1 1/2	3 1/2
7403	1 7/8	4 1/2
7405	2 1/16	4 7/8
7406	2 3/8	6
7407	3 1/16	6 3/8

Cast Iron Foot Valves

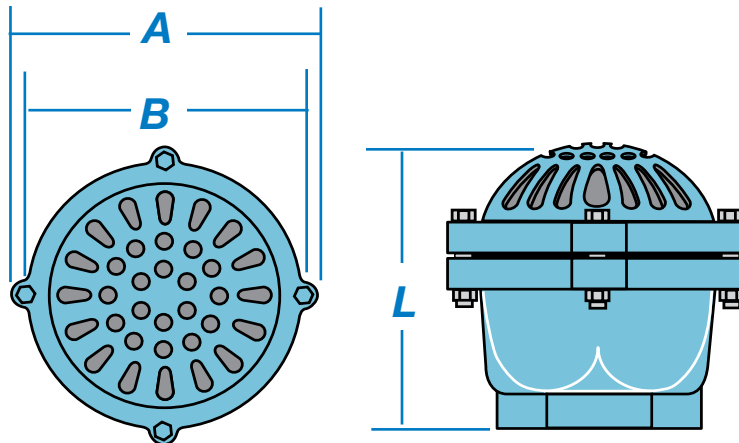

Part No.	Size	A	B	L	Hex Size
471	1 1/4 NPT	3 3/8"	4 5/8"	4 1/8"	2 5/8"
472	1 1/2 NPT	3 3/8"	4 5/8"	4 1/8"	2 5/8"
473	2 NPT	5 1/4"	5 3/4"	5 1/4"	3 5/16"
475	3 NPT	6 1/4"	7 5/8"	7 3/16"	4 9/16"
476	4 NPT	7 11/16"	9 1/16"	8 7/8"	5 9/16"
478	6 NPT	10 1/16"	11 7/16"	12"	7 3/4"
479	8 NPT	13 3/4"	15 1/8"	15 1/2"	10 1/8"

Check Valves

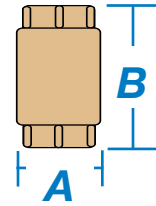

Part No.	Part No.	A Diameter	B Length
501SB		1 7/16	2 5/8
502SB		1 5/8	3 3/8
503SB		1 7/8	3 5/8
504SB		2 1/4	3 3/4
505SB	2505SB	2 5/8	4 1/8
506SB	2506SB	3 1/4	5 1/8
507SB		4	7 3/8
508SB		4 1/16	7 1/4
509SB		5 1/2	10 1/2
510SB		5 5/8	10 5/8
511SB		7 5/8	10 5/8
513SB	2503SB	1 7/8	3 7/8
514SB	2504SB	2 1/4	4 1/8
601SB		2 3/16	3 5/8
602SB		2 1/4	4 1/4
603SB		2 9/16	4 1/16
604SB		3 3/16	5 1/16
610SB		1 15/16	4 3/4
611SB		2 1/4	4 15/16
613SB		1 15/16	4 5/8
616SB		2	3 7/8
617SB		1 7/8	3 3/4
618SB		2 1/4	4 3/8
622SB		3 1/4	5
623SB		4 1/8	7 3/8
624SB		5 9/16	10 1/2
625SB		7 3/4	11
630SB		4 1/16	8 3/4
641SB		1 3/4	4 3/4
653SB	2653SB	1 7/8	3 7/8
654SB	2654SB	2 1/4	4 1/8
655SB	2655SB	2 5/8	4 3/8
658SB		3 1/4	5
660SB		4 1/8	7 3/8
661SB		5 9/16	10 1/2
662SB		7 3/4	11
669SB		4 1/16	8 3/4
670SB	675SB	4 1/16	8 7/8
671SB	2671SB	5 5/8	11 1/2
676SB	2676SB	5 5/8	11 1/2
672SB	677SB	7 5/8	11 1/2
673SB	678SB	9 5/8	12
674SB	2674SB	6 3/4	11 3/4
679SB	2679SB	6 3/4	11
680SB	2680SB	3 3/16	5 1/16
681SB	2681SB	4 7/8	8
685SB	2685SB	4 7/8	8
683SB	2683SB	9 1/4	12
687SB	2687SB	9 1/4	12
689SB	690SB	12 1/8	14

IMPORT VALVES

7501		1 1/4	2 3/8
7502		1 5/8	2 3/4
7503		1 7/8	3 1/8
7504		2 1/8	3 5/8
7505		2 3/8	4 1/16
7506		3 1/16	5

Silicon Bronze and Ductile Iron Foot Valves and Check Valves Pressure and Head Loss

2500 SB Series Check Valves Pressure and Head Loss

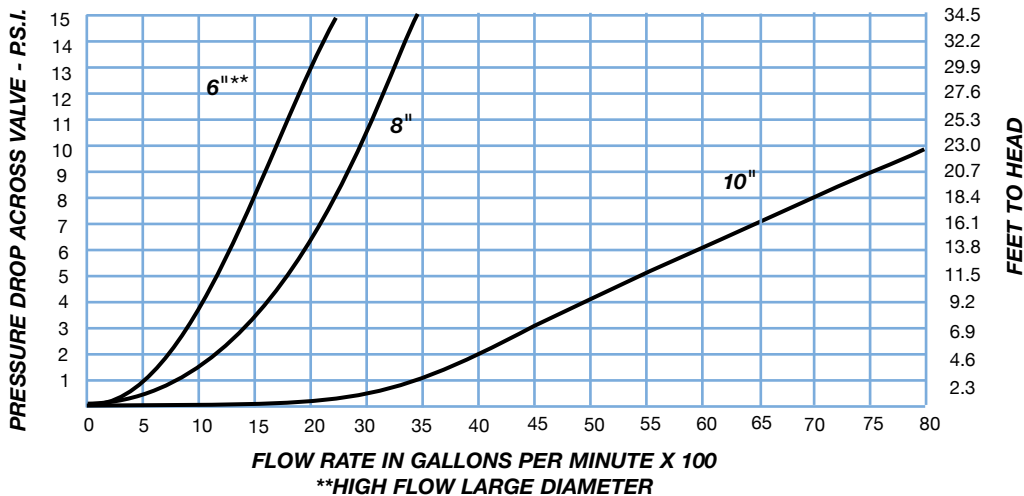
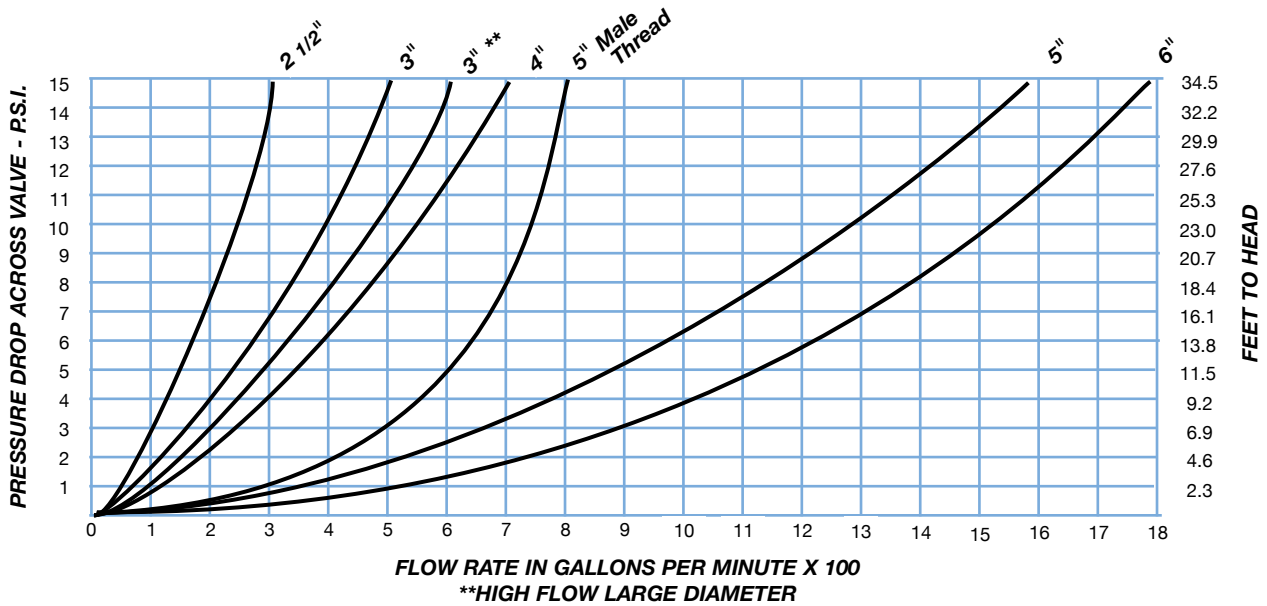
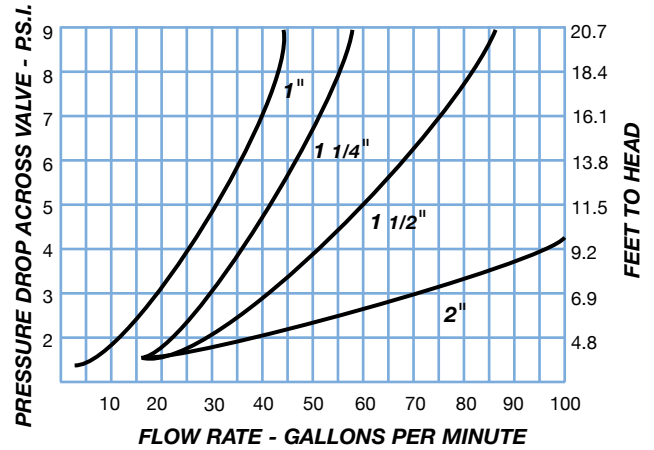
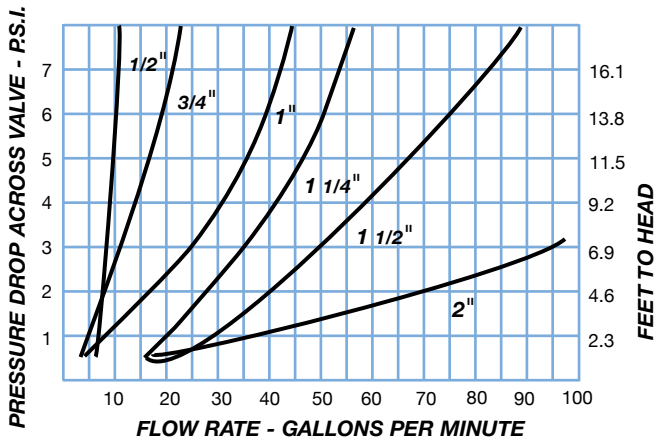

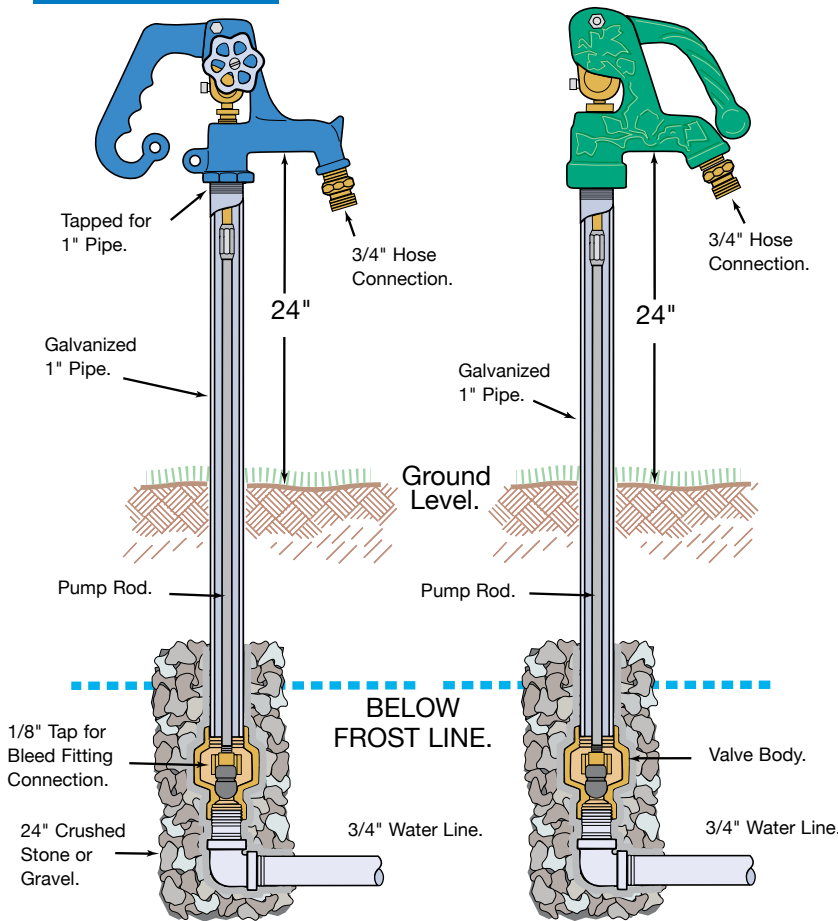

SPECIAL INSTRUCTIONS

The Brass Packing Nut located on the head of the Simmons Frost-Proof Yard Hydrant has been factory adjusted. If leakage should occur upon installation or after usage, you may find it necessary to slightly tighten the Brass Packing Nut.

CAUTION: Do not over-tighten Brass Packing Nut. Damage will occur to inner O rings. Do not leave hose attached in freezing temperature as it may prevent proper drainage of the riser pipe via shut-off valve drain hole.

Yard Hydrants - LENGTHS

Bury Depth	Rod & Pipe Length	800LF Series		4800LF, 5800LF & 900 Series			Overall Length
		Model	Overall Length	Model	Model	Model	
1 ft.	30"	800LF	40"	4800LF	5800LF	900	39 1/4"
1 1/2 ft.	38"	801LF	48"	4801LF	5801LF	-	47 1/4"
2 ft.	44"	802LF	54"	4802LF	5802LF	902	53 1/4"
3 ft.	56"	803LF	66"	4803LF	5803LF	903	65 1/4"
4 ft.	68 1/2"	804LF	78 1/2"	4804LF	5804LF	904	77 3/4"
5 ft.	80 1/2"	805LF	90 1/2"	4805LF	5805LF	905	89 3/4"
6 ft.	92 1/4"	806LF	102 1/4"	4806LF	5806LF	906	101 1/2"
7 ft.	104"	807LF	114"	4807LF	--	--	113 1/4"
8 ft.	116"	808LF	126"	4808LF	--	--	125 1/4"

If hydrant will not shut off completely, the plunger in the bottom of the hydrant can be lowered by raising the point of contact of the square head set screw on the brass rod.

To prevent unauthorized use, handle on 800LF, 900, 4800LF and 6800LF Series can be padlocked by inserting padlock into holes provided in handle and head.

The Frost Proof Yard Hydrant provides running water for lawn and garden and livestock all year even in sub-zero temperatures. The shut-off valve operates below the frost line. Hydrant cannot freeze because when it is closed, all water in the standpipe drains out a hole in the valve which is set in the

ground below the frost line. Hydrant spout operates at a convenient height (24 inches) from the ground level so that it can spill into a stock tank. Adapter (No. 8828) is threaded for 3/4" hose. Hydrant can be easily installed anywhere water is supplied under pressure.

Sanitary Yard Hydrants - Specifications

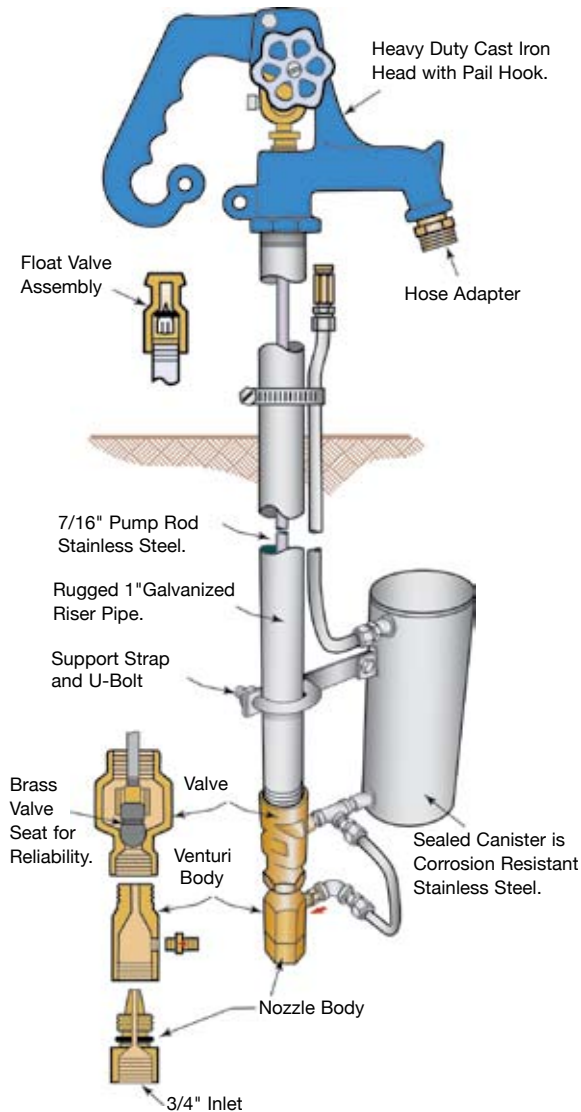

The Brass Packing Nut located on the head of the Simmons Sanitary Yard Hydrant has been factory adjusted. If leakage should occur upon installation or after usage, you may find it necessary to slightly tighten the Brass Packing Nut.

CAUTION: Do not overtighten Brass Packing Nut. Damage will occur to inner O rings. Do not leave hose attached in freezing temperatures as it may prevent proper drainage of the riser pipe water into the canister.

To prevent unauthorized use, handle can be padlocked by inserting padlock into holes provided in handle and head.

Sanitary Hydrant Part No.	Bury Depth	Overall Length	Weight
6800LF	1 ft.	45 in.	16 lb.
6802LF	2 ft.	57 in.	18 lb.
6803LF	3 ft.	69 in.	20 lb.
6804LF	4 ft.	81 in.	22 lb.
6805LF	5 ft.	93 in.	24 lb.
6806LF	6 ft.	105 in.	26 lb.

The SIMMONS SANITARY YARD HYDRANT is engineered to be fully self-contained and easily serviced in the field. It permits water flow year-around, even in freezing weather, yet there is no ground contamination nor contamination of the water supply. This hydrant drains back into the stainless steel canister.

FUNCTION

Simmons Sanitary Hydrant incorporates a nozzle-venturi adapter, and a stainless steel underground canister with the time proved, dependable, basic Simmons yard hydrant design. When the hydrant is off, plunger seals against the valve seat and stops the flow. Water remaining in riser pipe drains back into the canister which is buried below the frost level.

When the hydrant is on, flow through the nozzle creates a vacuum which empties the canister through the hose bibb.

Because the hydrant drains into a sealed canister and not into the ground through a "drain outlet," the water never comes in contact with the soil. This conserves water and avoids possible contamination of your water supply.

Limited Warranty

Simmons Manufacturing Company will replace or refund purchase price to the original purchaser of this product if it is determined that the same is defective.

This warranty is limited to replacement of the product or refund of the purchase price.

LIMITED WARRANTY - IMPORT PRODUCTS: Simmons Manufacturing Company will replace or refund purchase price to the original purchaser of this product if it is determined that the same is defective up to a **maximum of one year** from the date of purchase. This warranty is limited to replacement of the product or refund of the purchase price.

EXCLUSIONS OF WARRANTY: Simmons makes no warranty, express or implied,--with respect to its products,

other than the limited warranty described above. Implied warranties of merchant-ability and fitness for a particular purpose are hereby disclaimed by Simmons unless such disclaimers are prohibited by applicable state law. There are no warranties that extend beyond the description on the face hereof.

EXCLUSION OF INCIDENTAL AND CONSEQUENTIAL DAMAGES: In no event shall Simmons be liable for incidental or consequential damages, including, but without limitation, damages for personal injury or property damage, it being intended that purchaser's exclusive remedy is limited to replacement of defective products or refund of purchase price.

EXCLUSIONS FOR IMPROPER USE OR INSTALLATION BY UNQUALIFIED PERSONS: The limited warranty provided by Simmons will not apply if a Simmons product is used for a purpose other than the purpose for which it was manufactured, which is as a component in cold water systems only. The limited warranty provided

by Simmons also will not apply if a Simmons product is improperly installed or is installed by an unqualified person. Simmons products should be installed only by licensed contractors or by persons having proper training and experience in the installation of water systems and water system components. Simmons products should not be used in water systems which may exceed the maximum working pressure indicated on the product or product literature. It is the installers responsibility to make sure the product and product installation meet all local, state, and federal code regulations.

WARNINGS: Improper use or installation of Simmons products may cause property damage or personal injury. Simmons products should be used in cold water systems only. Simmons -products should not be used in water systems which may exceed the maximum pressure indicated on the product. Simmons products should be installed only by licensed and qualified persons.

Product Certification

Quality Assurance is Top Priority at Simmons.

With the increasing concern for the environment and changing regulations, we rely on the experience and state-of-the-art testing of Truesdail Laboratories to certify that Simmons products are in compliance with important standards. The following regulations/acts/laws limit the lead content allowed in plumbing products:

- California 116875 (AB1953) and Prop 65
- Vermont Act 193
- Maryland Chapter 407, House Bill 372
- Louisiana House Bill 471
- Federal Public Law 111-380 (Effective January 2014)

Truesdail Laboratories Product Certification mark is shown with the Simmons products that meet these regulations.

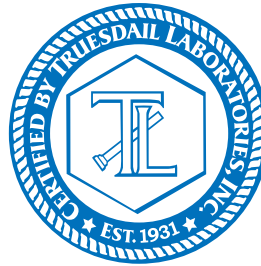

NSF/ANSI 372

The Truesdail certification program is accredited by ANSI. This mark indicates certified Simmons products throughout this catalog.

For products Simmons purchases or imports (not manufactured by Simmons) that have certification by independent laboratories, the certifications are noted with products in this catalog.

Be sure with Simmons. You can rely on Simmons with confidence. If you have any questions on this, call us.

Mailing Address:

P.O. Box 1509
McDonough, Georgia 30253

Physical Address:

1608 Highway 20 East
McDonough, Georgia 30252



Sales Order Desk:
800-241-1935

770-957-3976
Fax: 770-957-3979

www.simmonsmfg.com
simmonssales@simmonsmfg.com