



A MUNCH'S SUPPLY COMPANY

American Standard[®]
HEATING & AIR CONDITIONING



**2018-
2019
PRODUCT
CATALOG**

tommark.com



A MUNCH'S SUPPLY COMPANY

tommark.com



Equipment

Air Conditioners	1, 55
Heat Pumps	7
Geothermal	11
Gas Furnaces	12, 57
Air Handlers	28, 64
Coils	40, 60
Commercial Packaged Units	44
Roof Curbs	50
Commercial Air Conditioners	52, 59
Fan Coils	65
Unit Heaters	66, 70
Tube Heaters	72
Baseboard/Kickspace Heaters	68
Spacepak High Velocity Systems	74
Space Heaters	79
“Thru-the-Wall” Package Units	80
VRF	82

Manufactured Housing

Guardian Manufactured Housing	83
-------------------------------------	----

Ductless

Mini-Splits	84
Ductless Installation Accessories	91

Nexia

Thermostats	100
Accessories	103

Indoor Air Quality

Thermostats	107
Air Cleaners	122, 128, 131
Air Filters	127, 129, 133
Air Treatment Systems	135
Humidifiers	138
Dehumidifiers	151
Fresh Air	153
Zoning	157

Sheet Metal, Registers, Venting

Rectangular Duct & Fittings	169
Round Duct & Fittings	174
Sheet Metal Register Boots	181
Oval Duct & Fittings	182
Wall Stack & Fittings	184
Misc. Sheet Metal Products	186
PVC Coated Spiral Pipe & Fittings	189
Galvanized Spiral Pipe & Fittings	190
Aluminum Duct & Fittings	191
B-Vent	192
Sheet Metal Products	195
Poly Venting	197

Sheet Metal, Registers, Venting (cont.)

Roof Flashing	201
Registers & Grilles	202
Chimney Liner Kits	208
Duct Installation	209
Flex Duct	210
Ventilation	213

Hydronics

Boilers	221
Indirect Water Heaters	231
Circulator Pumps	232
Pump Flanges	236
B&G Pumps & Parts	239
Air Elimination	241
Fill/Expansion	243
Relief Valves	247
Mixing Valves & Gauges	248
Radiator Valves/Fittings/Flow Controls	249
Zone Controls/Valves	251
Hydronic Controls	255
Aquastats & Aquastat Controls	260
Radiant Systems	263

Plumbing

Rheem Residential Water Heaters	273
Commercial Gas Water Heaters	278
Commercial Storage Tanks/Mixing Valves	279
Navien Residential Gas Water Heaters	281
Copper Pipe Fittings	285
Copper Press Fittings	288
PVC Pipe & Fittings	292
Steel Pipe & Fittings	296
Black Fittings	297
Black Nipples	301
Galvanized Fittings	303
Galvanized Nipples	304
Brass Valves & Fittings	304
Gas Connectors, Pipe & Fittings	306

Electrical

Electrical Conduit & Fittings	307
Switches & Receptacles	309
Electrical Boxes & Covers	310
Wire & Cable	311
Pipe Hangers & Supports	312
Breakers	313
Fuses	315
Disconnects	316

Table of Contents



Tools

Meters & Instruments.....	317
Test Leads & Probes.....	322
Air & Pressure Measurement.....	323
Thermometers/Leak Detection.....	324
Refrigerant Recovery/Vacuum Pumps/Oil.....	326
Manifolds & Accessories.....	328
Access Fittings & Accessories.....	332
Hand Tools.....	334
Blades.....	356
Hole Saws & Accessories.....	357
Brushes.....	358
Torches & Accessories.....	359

Supplies

Furnace & A/C Installation Supplies.....	362
Line Sets & Insulation.....	363
Duct, Pipe Hangers & Supports.....	364
Refrigeration Tubing & Fittings.....	366
Brazing & Soldering.....	368
Condensate Pumps & Accessories.....	370
Leak Detection & Repair.....	373
Sealants.....	374
Duct Sealants, Adhesives & Fasteners.....	376
PVC Cleaners, Mortar & Cement.....	378
Hydronic Supplies.....	379
Coil Cleaners & Sprayers.....	380
Refrigeration Flush & Oil.....	382
Screws & Fasteners.....	384
Misc. Supplies.....	386
Gloves, Kneepads & Tape.....	388

Parts

Gas Valves.....	391
Pressure Regulators.....	396
Furnace Controls.....	397
Ignition Modules & Accessories.....	400
Igniters.....	403
Flame Sensors.....	406
Pilot Burners.....	407
Fan & Limit Controls.....	409
Pressure Switches.....	413
Inducer Venter Motors.....	414
Relays.....	415
Thermocouples.....	417
Transformers.....	419

Parts (cont.)

Air Conditioner Controls.....	421
Contactors.....	422
Heat Sequencers.....	423
Filter-Driers.....	424
Capacitors.....	425
Direct Drive Blower Motors.....	427
Condenser Fan Motors.....	432
Motor Accessories.....	435
Hard Starts/Time Relays.....	436

Fireplaces

Fireplaces.....	437
Fireplace Accessories.....	440

Index

Model Number.....	441
Part Number.....	460

Reference Guide

Reference.....	474
----------------	-----

Air Conditioners

AccuComfort™ Variable Speed Cooling Single Phase, 2-5 Tons

Platinum 20, Variable-Speed, R-410A, Split Cooling Air Conditioner with AccuLink™

Part #	Model #	Tons	Nominal Cooling BTUH	Electrical	Line Sets Liq, Suc	Dimensions H x W x D	Ship Weight
131385	4A7V0024A1000B	2.0	24,000	208/230-1-60	3/8", 5/8"	41" x 33" x 30"	217 lbs
146398	4A7V0036B1000B	3.0	36,000	208/230-1-60	3/8", 3/4"	41" x 37" x 34"	228 lbs
131387	4A7V0048A1000B	4.0	48,000	208/230-1-60	3/8", 7/8"	41" x 37" x 34"	270 lbs
131388	4A7V0060A1000B	5.0	60,000	208/230-1-60	3/8", 1-1/8"	45" x 37" x 34"	284 lbs

Must use ACONT850 or AZON1050 control, see pg 101

Platinum 18, Variable-Speed, R-410A, Split Cooling Air Conditioner with AccuLink™

Part #	Model #	Tons	Nominal Cooling BTUH	Electrical	Line Sets Liq, Suc	Dimensions H x W x D	Ship Weight
131381	4A7V8024A1000B	2.0	24,000	208/230-1-60	3/8", 5/8"	41" x 33" x 30"	217 lbs
131382	4A7V8036A1000B	3.0	36,000	208/230-1-60	3/8", 3/4"	41" x 33" x 30"	228 lbs
131383	4A7V8048A1000B	4.0	48,000	208/230-1-60	3/8", 7/8"	41" x 37" x 34"	270 lbs
131384	4A7V8060A1000B	5.0	60,000	208/230-1-60	3/8", 1-1/8"	45" x 37" x 34"	284 lbs

Must use ACONT850 or AZON1050 control, see pg 101



Platinum 20/18

Features	Platinum 20 4A7V0	Platinum 18 4A7V8
SEER up to	22.00	18.00
Duration compressor	1	1
Comfort-R™ mode approved	✓	✓
AccuLink™ communication system	✓	✓
Durabase™ base, fast complete drain, weatherproof	✓	✓
Easy-Sess™ cabinet service access	✓	✓
Spine Fin™ coil	✓	✓
Compressor sound enclosure	✓	✓
Compressor sump heat	✓	✓
High and low switches	✓	✓
Liquid line filter-drier - factory installed or factory supplied	✓	✓
12-Year registered limited warranty on compressor, 10-year on outdoor coil and all other functional parts (residential use)	✓	✓
Warranty terms require registration within 60 days of installation; Extended warranties available	✓	✓

Options

Part #	Model #	Description	Ship Weight	Platinum 20 4A7V0	Platinum 18 4A7V8
107910	BAYECMT023	Extreme Conditions Mounting Kit (Base 2/3)	2	2	2
79957	BAYECMT004	Extreme Conditions Mounting Kit (Base 4)	2	3-5	3-5
38197	BAYISLT101	Rubber Isolators	1	✓	✓
188172	BAYLEGS007	Snow Legs - Base and Cap 6" High (Black)	1	✓	✓
188173	BAYLEGS004	4" Extension (Black)	1	✓	✓

Air Conditioners

Gold Split System Air Conditioners

Gold 17, 2-Stage, R-410A, Split Cooling Air Conditioner

Part #	Model #	Tons	Nominal Cooling BTUH	Electrical	Line Sets Liq, Suc	Dimensions H x W x D	Ship Weight
125928	4A7A7024A1000B	2.0	24,000	208/230-1-60	3/8", 5/8"	41" x 37" x 34"	276 lbs
125929	4A7A7036A1000B	3.0	36,000	208/230-1-60	3/8", 3/4"	45" x 37" x 34"	283 lbs
125930	4A7A7048A1000B	4.0	48,000	208/230-1-60	3/8", 7/8"	45" x 37" x 34"	308 lbs
125931	4A7A7060A1000B	5.0	60,000	208/230-1-60	3/8", 1-1/8"	45" x 37" x 34"	312 lbs

Silver Split System Air Conditioners

Silver 16, Single-Stage, R-410A, Split Cooling Air Conditioner

Part #	Model #	Tons	Nominal Cooling BTUH	Electrical	Line Sets Liq, Suc	Dimensions H x W x D	Ship Weight
172774	4A7A6018J1000A	1.5	18,000	208/230-1-60	3/8", 3/4"	29" x 33" x 30"	200 lbs
172777	4A7A6024J1000A	2.0	24,000	208/230-1-60	3/8", 3/4"	29" x 33" x 30"	201 lbs
172778	4A7A6030J1000A	2.5	30,000	208/230-1-60	3/8", 3/4"	33" x 37" x 34"	234 lbs
172780	4A7A6036J1000A	3.0	36,000	208/230-1-60	3/8", 7/8"	37" x 37" x 34"	228 lbs
172782	4A7A6042J1000A	3.5	42,000	208/230-1-60	3/8", 7/8"	41" x 37" x 34"	272 lbs
172783	4A7A6048J1000A	4.0	48,000	208/230-1-60	3/8", 7/8"	45" x 37" x 34"	282 lbs
172786	4A7A6049J1000A	4.0	48,000	208/230-1-60	3/8", 7/8"	45" x 37" x 34"	304 lbs
172787	4A7A6060J1000A	5.0	57,500	208/230/1-60	3/8", 1-1/8"	45" x 37" x 34"	327 lbs
142608	4A7A6061C1000A	5.0	60,000	208/230-1-60	3/8", 1-1/8"	45" x 37" x 34"	327 lbs

Silver 14, Single-Stage, R-410A, Split Cooling Air Conditioner

Part #	Model #	Tons	Nominal Cooling BTUH	Electrical	Line Sets Liq, Suc	Dimensions H x W x D	Ship Weight
144128	4A7A4018L1000A	1.5	17,000	208/230-1-60	3/8", 3/4"	29" x 29" x 26"	153 lbs
144129	4A7A4024L1000A	2.0	23,600	208/230-1-60	3/8", 3/4"	29" x 29" x 26"	153 lbs
144130	4A7A4030L1000A	2.5	28,400	208/230-1-60	3/8", 3/4"	29" x 33" x 30"	183 lbs
144131	4A7A4036L1000A	3.0	34,000	208/230-1-60	3/8", 3/4"	33" x 33" x 30"	183 lbs
144132	4A7A4042L1000A	3.5	40,500	208/230-1-60	3/8", 7/8"	29" x 37" x 34"	216 lbs
144133	4A7A4048L1000A	4.0	47,000	208/230-1-60	3/8", 7/8"	29" x 37" x 34"	212 lbs
144134	4A7A4060L1000A	5.0	56,000	208/230-1-60	3/8", 7/8"	37" x 37" x 34"	246 lbs

Silver 13, Single-Stage, R-410A, Split Cooling Air Conditioner

Part #	Model #	Tons	Nominal Cooling BTUH	Electrical	Line Sets Liq, Suc	Dimensions H x W x D	Ship Weight
147105	4A7A3018H1000N	1.5	17,000	208/230-1-60	3/8", 5/8"	29" x 29" x 26"	153 lbs
147106	4A7A3024H1000N	2.0	23,000	208/230-1-60	3/8", 5/8"	29" x 29" x 26"	150 lbs
186242	4A7A3030H1000N	2.5	28,500	208/230-1-60	3/8", 3/4"	29" x 33" x 30"	180 lbs
186243	4A7A3036H1000N	3.0	34,500	208/230-1-60	3/8", 3/4"	33" x 33" x 30"	197 lbs
186244	4A7A3042E1000N	3.5	40,500	208/230-1-60	3/8", 3/4"	29" x 37" x 34"	228 lbs
186245	4A7A3048E1000N	4.0	46,500	208/230-1-60	3/8", 7/8"	29" x 37" x 34"	235 lbs
186246	4A7A3060D1000P	5.0	58,500	208/230-1-60	3/8", 7/8"	37" x 37" x 34"	261 lbs

Air Conditioners



Gold 17/Silver 16/14/13

Features	Gold 17 4A747	Silver 16 4A746-J	Silver 14 4A7A4	Silver 13 4A7A3
SEER up to	18.00	17.00	16.00	14.75
Duration compressor	1	1	1	1
Number of stages	2	1	1	1
Comfort-R™ mode approved	✓	✓	✓	✓
Durabase™ base, fast complete drain, weatherproof	✓	✓	✓	✓
Easy-Sess™ cabinet service access	✓	✓	✓	✓
Spine Fin™ coil	✓	✓	✓	✓
High and low pressure switches	✓	high only	✓	high only
Liquid line filter-drier - factory installed or factory supplied	✓	✓	✓	✓
12-Year registered limited warranty on compressor, 10-year on outdoor coil and all other functional parts (residential use)	-	✓	✓	✓
Warranty terms require registration within 60 days of installation; Extended warranties available	✓	✓	✓	✓

Options

Part #	Model #	Description	Ship Weight	Gold 17 4A747	Silver 16 4A746-J	Silver 14 4A7A4	Silver 13 4A7A3
2828	AY28X079	Evaporator Defrost Control	1	✓	✓	✓	✓
37132	BAYCCHT300	Crankcase Heater Kit (Reciprocating)	1	-	-	-	1½-3
38028	BAYCCHT301	Crankcase Heater Kit (Scroll)	1	✓	3½-5	3½-5	3½-5
141462	BAYCCHT302RES	Crankcase Heater Kit (Scroll)	1	-	1½-3	1½-3	3½-5
68950	BAYKSKT263	Start Kit	1	2-3	2½-5	2½-5	2-5
140499	BAYKSKT266	Start Kit	1	4-5	-	-	-
35099	BAYLOAM103	Low Ambient Kit	1	-	✓	✓	✓
73676	BAYSDEN003	Small Scroll Compressor Enclosures	8	2-3	1½-3	-	-
73677	BAYSDEN004	Small Scroll Compressor Enclosures	8	4-5	3½-5	-	-
32971	TAYASCT501A ^{1,2}	Anti-Short Cycle Timer	2	✓	✓	✓	✓
10013	TAYPLUS103A	Heat Pump Control Kit	3	-	-	✓	✓

1: Not for use with programmable thermostats.

2: Activated on power off.

Heat Pumps

Platinum Split System Heat Pumps

Platinum 20, Variable Speed, R-410A, Split System Heat Pump with Acculink™

Part #	Model #	Tons	Electrical	Line Sets Liq, Suc	Dimensions H x W x D	Ship Weight
131395	4A6V0024A1000B	2.0	208/230-1-60	3/8", 5/8"	41" x 33" x 30"	216 lbs
131396	4A6V0036A1000B	3.0	208/230-1-60	3/8", 3/4"	41" x 37" x 34"	254 lbs
131397	4A6V0048A1000B	4.0	208/230-1-60	3/8", 7/8"	41" x 37" x 34"	266 lbs
131398	4A6V0060A1000B	5.0	208/230-1-60	3/8", 1-1/8"	45" x 37" x 34"	276 lbs

Must use ACONT850 or AZON1050 control, see pg 101

Platinum 18, Variable Speed, R-410A, Split System Heat Pump with Acculink™

Part #	Model #	Tons	Electrical	Line Sets Liq, Suc	Dimensions H x W x D	Ship Weight
131389	4A6V8024A1000B	2.0	208/230-1-60	3/8", 5/8"	41" x 33" x 30"	216 lbs
131390	4A6V8036A1000B	3.0	208/230-1-60	3/8", 3/4"	41" x 33" x 30"	229 lbs
131391	4A6V8037A1000B	3.0	208/230-1-60	3/8", 3/4"	41" x 37" x 34"	256 lbs
131392	4A6V8048A1000B	4.0	208/230-1-60	3/8", 7/8"	41" x 37" x 34"	259 lbs
131393	4A6V8049A1000B	4.0	208/230-1-60	3/8", 7/8"	41" x 37" x 34"	266 lbs
131394	4A6V8060A1000B	5.0	208/230-1-60	3/8", 1-1/8"	45" x 37" x 34"	276 lbs

Must Use ACONT850 or AZON1050 control, see pg 101



Platinum 20/18

Features	Platinum 20	Platinum 18
SEER up to	21.00	18.00
HSPF up to	10.00	10.00
AccuLink™ communication system	✓	✓
Comfort-R™ mode approved	✓	✓
Durabase™ base, fast complete drain, weatherproof	✓	✓
Easy-Sess™ cabinet service access	✓	✓
Spine Fin™ coil	✓	✓
Compressor sound enclosure	✓	✓
Compressor sump heat	✓	✓
High pressure switch	✓	✓
Liquid line filter-drier - factory installed or factory supplied	✓	✓
12-Year registered limited warranty on compressor, 10-year on outdoor coil and all other functional parts (residential use)	✓	✓
Warranty terms require registration within 60 days of installation; Extended warranties available	✓	✓

Options					
Part #	Model #	Description	Ship Weight	Platinum 20	Platinum 18
107910	BAYECMT023	Extreme Conditions Mounting Kit (Base 2/3)	2	2	2-3
79957	BAYECMT004	Extreme Conditions Mounting Kit (Base 4)	2	3-5	037-060
188172	BAYLEGS007	Snow Legs - 7" High (Black)	1	✓	✓
188173	BAYLEGS004	Snow Legs - 4" High (Black)	1	✓	✓

Models and Specifications are Subject to Change Without Notice

Heat Pumps

Gold Split System Heat Pumps

Gold 17, 2-Stage, R-410A, Split Heat Pump

Part #	Model #	Tons	Nominal Cooling BTUH	Electrical	Line Sets Liq, Suc	Dimensions H x W x D	Ship Weight
125941	4A6H7024A1000C	2.0	24,000	208/230-1-60	3/8", 5/8"	41" x 37" x 34"	272 lbs
125942	4A6H7036B1000C	3.0	36,000	208/230-1-60	3/8", 3/4"	41" x 37" x 34"	274 lbs
125943	4A6H7048A1000C	4.0	48,000	208/230-1-60	3/8", 7/8"	45" x 37" x 34"	329 lbs
125944	4A6H7060A1000C	5.0	60,000	208/230-1-60	3/8", 1-1/8"	45" x 37" x 34"	330 lbs

Silver Split System Heat Pumps

Silver 16, Single-Stage, R-410A, Split Heat Pump

Part #	Model #	Tons	Nominal Cooling BTUH	Electrical	Line Sets Liq, Suc	Dimensions H x W x D	Ship Weight
147408	4A6H6024H1000A	2.0	24,200	208/230-1-60	3/8", 3/4"	33" x 33" x 30"	208 lbs
147410	4A6H6030H1000A	2.5	28,600	208/230-1-60	3/8", 3/4"	37" x 37" x 34"	245 lbs
147411	4A6H6036H1000A	3.0	34,800	208/230-1-60	3/8", 7/8"	37" x 37" x 34"	246 lbs
147412	4A6H6042H1000A	3.5	41,000	208/230-1-60	3/8", 7/8"	45" x 37" x 34"	277 lbs
147413	4A6H6048H1000A	4.0	47,000	208/230-1-60	3/8", 7/8"	45" x 37" x 34"	300 lbs
147415	4A6H6060H1000A	5.0	55,000	208/230-1-60	3/8", 1-1/8"	45" x 37" x 34"	301 lbs

Silver 14, Single-Stage, R-410A, Split Heat Pump

Part #	Model #	Tons	Nominal Cooling BTUH	Electrical	Line Sets Liq, Suc	Dimensions H x W x D	Ship Weight
178837	4A6H4024G1000A	2.0	23,600	208/230-1-60	3/8", 5/8"	29" x 33" x 30"	191 lbs
178838	4A6H4030G1000A	2.5	28,200	208/230-1-60	3/8", 3/4"	29" x 37" x 34"	248 lbs
190854	4A6H4036G1000A	3.0	34,000	208/230-1-60	3/8", 3/4"	29" x 37" x 34"	229 lbs
178839	4A6H4042G1000A	3.5	41,000	208/230-1-60	3/8", 3/4"	29" x 37" x 34"	248 lbs
178840	4A6H4048G1000A	4.0	46,500	208/230-1-60	3/8", 7/8"	33" x 37" x 34"	300 lbs
178841	4A6H4060G1000A	5.0	56,000	208/230-1-60	3/8", 1-1/8"	45" x 37" x 34"	315 lbs

Features and options next page



A MUNCH'S SUPPLY COMPANY

Let us be your source for quality products
from leading manufacturers.

Heat Pumps

Equipment



Gold 17/Silver 16/14

Features	Gold 17 4A6H7	Silver 16 4A6H6	Silver 14 4A6H4
SEER up to	17.25	17.00	14.50
HSPF up to	9.60	9.60	8.50
Number of stages	2	1	1
Duration™ compressor	1	1	1
Comfort-R™ mode approved	✓	✓	✓
Durabase™ base, fast complete drain, weatherproof	✓	✓	✓
Easy-Sess™ cabinet service access	✓	✓	✓
Spine Fin™ coil	✓	✓	✓
Demand Defrost Control with Lite Port™ Stored Diagnostics	-	-	✓
Electronic Expansion Valve (EEV)	✓	-	-
Compressor sump heat - factory installed	✓	-	-
High and low pressure switches	✓	✓	✓
Liquid line filter-drier - factory installed or factory supplied	✓	✓	✓
12-Year registered limited warranty on compressor, 10-year on outdoor coil and all other functional parts (residential use)	-	✓	✓
Warranty terms require registration within 60 days of installation; Extended warranties available	✓	✓	✓

Options

Part #	Model #	Description	Ship Weight	Gold 17 4A6H7	Silver 16 4A6H6	Silver 14 4A6H4
2879	AY28X084	Evaporator Defrost Control	1	-	-	✓
38028	BAYCCHT301RES	Crankcase Heater Kit (Scroll)	1	-	3½-5	3½-5
141462	BAYCCHT302RES	Crankcase Heater Kit (Scroll)	1	-	1½-3	1½-3
68950	BAYKSKT263	Start Kit (Scroll)	1	2-3	✓	✓
140499	BAYKSKT266	Start Kit (Scroll)	1	4-5	-	-
188172	BAYLEGS007	Snow Legs - Base and Cap 6" High (Black)	1	✓	✓	✓
188173	BAYLEGS004	4" Extension (Black)	1	✓	✓	✓
35099	BAYLOAM103	Low Ambient Kit	1	✓	-	✓
161275	BAYLOAM107	Low Ambient Kit	1	-	✓	-
32971	TAYASCT501A ^{1, 2}	Anti-Short Cycle Timer	2	✓	✓	✓
73676	BAYSDEN003	Small Scroll Compressor Enclosures	8	2-3	1½-3	1½-3
73577	BAYSDEN004	Small Scroll Compressor Enclosures	8	4-5	3½-5	3½-5
147406	AAYSVPANL3343AA	Service Valve Panel Cover Kit	2	2-3	1½-2	3-4
147405	AAYSVPANL0044AA	Service Valve Panel Cover Kit	2	4-5	2½-3	-
147407	AAYSVPANL0046AA	Service Valve Panel Cover Kit	2	-	3½-5	5
10013	TAYPLUS103A	Heat Pump Control Kit	3	-	-	✓

1: Not for use with programmable thermostats.

2: Activated on power off.

Models and Specifications are Subject to Change Without Notice

Geothermal

Hardworking, Ultra Efficient Systems That Can Change Comfort Forever

When you think smart, efficient comfort solutions, you think American Standard Heating & Air Conditioning. In fact, you've trusted us to provide perfectly heated, cooled and cleaned air for over 100 years. Now, we're bringing home new thinking about home comfort with the impressive efficiency of geothermal heating and cooling. And our systems are every bit as comfortable as you'd expect. So relax and enjoy a whole new standard of energy awareness with EnviroWise™ Geothermal Systems from American Standard Heating & Air Conditioning.



Equipment



Platinum Packaged System

Inside your American Standard EnviroWise™ Geothermal System, you'll find tough, dependable components like vibrator-dampened scroll Duration™ compressors and specially coated air coils. Everything is built to last, because comfort is nothing without peace of mind.

1) Duration™ Compressor

State-of-the-art technology provides world class efficiency and reliability. Specially designed vibration damping mounts deliver near silent operation.

2) Variable-Speed Blower

Operates quietly and efficiently to deliver just the right amount of air to keep your home at the perfect temperature.

3) All Aluminum Air Coil

A large transfer area enhances operating efficiency and humidity control. All Aluminum Air Coils are more durable than conventional copper coils and resist corrosion that causes refrigerant leaking into the atmosphere.

4) Controls

Micro-processor technology combined with on-board diagnostics ensures reliability and long-lasting comfort.

5) Hot Water Option

Uses excess system capacity to help heat the water you need for bathing and laundry.

6) Drain Pan

Made of tough, durable polymer to ward off corrosion and bacterial growth. Integrated electronic overflow protection keeps system components safe.

7) Cabinet

Fully insulated to reduce noise levels. Foil-backed insulation is easy to clean, while the durable powder painted surface stays attractive for years.

Geothermal

American Standard EnviroWise™ Geothermal Systems

Packaged systems

These systems circulate fluid through the earth and through a coil that absorbs or dissipates heat depending on the season.

Equipment



Platinum 2-stage T2GX/T1GX

This packaged geothermal solution from American Standard offers up to 32.1 EER efficiency and is available in single and 2-stage. A variable speed blower motor provides up to 12 airflow selections for efficient comfort. Optional hot water heating is available.



Platinum Hybrid T2GY

With up to 27.3 EER and single-stage heating and cooling, enjoy constant comfort and efficiency from a combination of forced air heating, forced air cooling, radiant heat and a dedicated hot water heater. Variable speed airflow offers 12 different settings, and optional hot water heating.



Platinum Variable Speed TVGX

Utilizing a true variable-capacity compressor and a variable-speed blower with a fully-communicating control package, this system provides our highest level of comfort, efficiency, and ultimate performance with an EER of up to 40 and a COP of up to 5.



Gold Water to Air T2GC

Energy savings up to 22 EER and environmentally-friendly comfort meet Energy Star™ performance requirements. This mid-efficiency 2-stage system utilizes a new cabinet design, all aluminum air coil, 5-speed ECM motor, Duration™ compressor, optional hot water heating, and on-board diagnostics making this a sound investment.

Trane EnviroWise™ Geothermal Systems circulate fluid through the earth and a coil that absorbs or dissipates heat depending on the season. They include:

- *State-of-the-art technology, including uniquely designed vibration damping mounts for near silent operation.*
- *Operates quietly and efficiently to deliver just the right amount of air to keep your home at the perfect temperature.*
- *A large surface area provides exceptional efficiency and humidity control. Specially coated to prevent formicary corrosion, enhancing long life and reliability.*
- *Precision control of the geothermal water heater system combined with on-board diagnostics ensures reliability and long-lasting comfort.*
- *Optional water heating collects and concentrates extra system heat, providing the hot water you need every day for bathing, dishes and laundry.*
- *Tough, durable and specially designed to ward off corrosion and bacteria. Includes electronic overflow protection.*
- *Includes cleanable, foil-backed insulation and an attractive outer surface that looks new for years.*

Geothermal

American Standard EnviroWise™ Geothermal Systems

Split systems

These systems use a ground loop connected to a loop of refrigerant to transfer heat using an air handler or furnace to circulate air.



Platinum Indoor T2GN

This 2-stage system offers up to 33.1 EER and works in conjunction with an air handler or furnace for enhanced indoor comfort. The small footprint saves space and the indoor product can be located up to 60 feet from the air handler. Optional hot water heating is available.

Platinum Indoor Air Handler TAMG

The Platinum Air Handler's unique cabinet design allows less moisture and fewer dust particles to be drawn in from garages, attics, or crawl spaces. This double-wall cabinet design also helps prevent energy loss and virtually eliminates condensation. Select models have been specifically engineered to match EnviroWise geothermal heat pumps.

Platinum Outdoor T2GE

Similar to the Platinum Indoor model, this system offers the comfort of 2-stage heating and cooling and works in conjunction with an indoor air handler or furnace to provide comfortable temperatures from two different sources. In this application, all geothermal components of the system reside in a weatherized cabinet outside your home that minimizes space requirements inside.

Water heating and cooling systems

These systems circulate fluid through the earth, transferring heat to and from another fluid loop built into your home. That means radiant heating and cooling without fans or duct work. They are ideal for radiant floor heating applications and can be used with select models of the Platinum Air Handler with water coil to deliver heated and cooled air through a ducted air system.



Platinum Water to Water A1GW

Offers up to 23.4 EER and up to 15 tons capacity with the flexibility of 2-stage radiant heating and cooling.

Platinum Water to Water A2GW

Offers up to 24.5 EER and single-stage heating and cooling. Radiant heating and cooling maintain comfortable temperatures throughout the home while providing hot water for daily use.



Geothermal Heating and Cooling

Geothermal heat pumps are great for your family and your home. By tapping into temperatures deep beneath the earth's surface, geothermal HVAC systems heat and cool the home while producing no carbon emissions. These systems are also energy-efficient which can help save energy and provide your family with the comfort they deserve.

Take a moment to learn more about the geothermal heating and cooling systems offered by American Standard. Configurations and prices will vary based on your comfort needs.

Available for purchase in the U.S. and Canada only.

Gas Furnaces

Comfort And Efficiency. It's the Best of Both Worlds.

Experiencing a higher standard of comfort in your home doesn't mean you have to sacrifice efficiency, reliability or durability. That's because no matter the furnace, the same American Standard Heating & Air Conditioning craftsmanship goes into every gas furnace we make. No matter if it's our high quality Platinum Series, our reliable and efficient Gold Series, or the durable Silver Series. You can be sure that, not only will they give you a higher standard of performance, but also deliver a higher standard of comfort to your home.

Perfectly Balanced, Perfectly Comfortable.

In a matched system, everything works together to do more.

A matched system from American Standard Heating & Air Conditioning is a system that combines components that have been designed to work with one another. The result is a perfectly balanced system tuned for efficiency and substantial comfort, producing air unlike anything you've felt before.



Gas Furnace

Keeps your home cozy with 2 highly efficient gas during the winter and circulates cooled air in the summer to keep you comfortable, no matter the season.



Heat Pump or Air Conditioner

Keep your home comfortable year round with a versatile heat pump. Or enjoy cool, reliable comfort during the summer with our durable air conditioners.



AccuClean™

A new definition of whole-home filtration, AccuClean removes up to an incredible 99.98% of particles down to .1 micron.



Comfort Control

Available as programmable or non-programmable, American Standard controls are smart, clear and intuitive.



Coil

All-aluminum construction and fewer brazed joints mean corrosion resistance and long-term reliability.



Humidifier

Carefully controls moisture levels in your air during dry weather to reduce static electricity and help preserve furniture and valuables.

Gas Furnaces

The Secret Behind Our Reliability? It Starts With Quality.

At American Standard Heating & Air Conditioning, reliability begins with quality. That means each innovative feature on every furnace we make must first meet our high standards before bearing our name. It's this focus that gives you the comfort, efficiency and reliability you expect from American Standard.



Platinum 80

- 1 AccuLink™ communicating capability with user interface**
Enables your system to communicate to the Comfort 2 Control; gives you the ability to monitor remotely and even relays diagnostics for responsive maintenance.
- 2 Three-wire connection**
Simplified connection to the Comfort Control enables faster, easier installation that is less invasive to your home.
- 3 Variable-speed blower motor with Comfort-RTM**
Operates at a lower, more efficient speed than conventional blower motors, while our exclusive Comfort-RTM feature ensures greater humidity control during cooling.
- 4 Induced draft venting**
Quietly draws hot combustion gas through the heat exchanger, maximizing the heat transfer efficiencies of the exchanger design.
- 5 Durable silicon nitride hot surface igniter**
Starts burner electronically for safe, efficient operation, eliminating the need for a fuel-burning pilot light.
- 6 Two-stage gas valve**
Results in greater efficiency by providing just the right amount of fuel for each stage.
- 7 Multi-port in-shot burners**
Perfectly shape the flame cone to maximize heating while using less fuel.
- 8 Aluminized steel heat exchanger**
Crimped, not welded, to prevent cracks from heat stress. Stamped serpentine channel offers the greatest efficiency in less space.
- 9 Heavy steel insulated cabinet**
Holds more heat in the furnace to be delivered throughout your home. Helps ensure quiet operation.
- 10 Self-diagnostic controls**
Manage every function with digital accuracy. Includes safety features and a built-in troubleshooting system.
- 11 Sound-insulated blower compartment**
Ensures the quietest possible operation.
- 12 Dual door latches (Upflow models only)**
Allow easy access to the filter for cleaning or changing.
- 13 Cleanable filter (Select models)**
Means you can rinse or vacuum it without buying replacements each time.

Gas Furnaces

S9V2, 2-Stage, Non-Communicating, ECM Variable-Speed Motor Gas Furnaces S9V2, ECM Variable-Speed Blower Upflow/Horizontal Left/Right Gas Furnace

Part #	Model #	Nominal Heating BTUH	Output BTUH High/Low	AFUE	Airflow in Tons	Dimensions H x W x D	Flue Size	Ship Weight
194712	S9V2B040U3PSBA	40,000	38,800/25,220	96%	3.0	34" x 17-1/2" x 28-3/4"	2", 3", 4"	122 lbs
194713	S9V2B060U3PSBA	60,000	58,200/37,830	96%	3.0	34" x 17-1/2" x 28-3/4"	2", 3", 4"	127 lbs
194714	S9V2B060U4PSBA	60,000	58,200/37,830	96%	4.0	34" x 17-1/2" x 28-3/4"	2", 3", 4"	130 lbs
194715	S9V2B080U3PSBA	80,000	77,600/50,440	96%	3.0	34" x 17-1/2" x 28-3/4"	2", 3", 4"	132 lbs
194717	S9V2B080U4PSBA	80,000	77,600/50,440	96%	4.0	34" x 17-1/2" x 28-3/4"	2", 3", 4"	135 lbs
194719	S9V2C080U5PSBA	80,000	77,600/50,440	96%	5.0	34" x 21" x 28-3/4"	2", 3", 4"	149 lbs
194720	S9V2C100U4PSBA	100,000	97,000/63,050	96%	4.0	34" x 21" x 28-3/4"	2", 3", 4"	154 lbs
194721	S9V2C100U5PSBA	100,000	97,000/63,050	96%	5.0	34" x 21" x 28-3/4"	2", 3", 4"	155 lbs
194723	S9V2D120U5PSBA	120,000	116,400/75,660	96%	5.0	34" x 24-1/2" x 28-3/4"	3", 4"	167 lbs

Note: Variable speed furnaces should not be twinned and are not approved for twinning applications.

S9V2, ECM Variable-Speed Blower Downflow Gas Furnace

Part #	Model #	Nominal Heating BTUH	Output BTUH High/Low	AFUE	Airflow in Tons	Dimensions H x W x D	Flue Size	Ship Weight
194724	S9V2B040D3PSBA	40,000	38,800/25,220	96%	3.0	34" x 17-1/2" x 28-3/4"	2", 3", 4"	122 lbs
194726	S9V2B060D3PSBA	60,000	58,200/37,830	96%	3.0	34" x 17-1/2" x 28-3/4"	2", 3", 4"	127 lbs
194728	S9V2B080D3PSBA	80,000	77,600/50,440	96%	3.0	34" x 17-1/2" x 28-3/4"	2", 3", 4"	132 lbs
194729	S9V2B080D4PSBA	80,000	77,600/50,440	96%	4.0	34" x 17-1/2" x 28-3/4"	2", 3", 4"	135 lbs
194732	S9V2C100D4PSBA	100,000	97,000/63,050	96%	4.0	34" x 21" x 28-3/4"	2", 3", 4"	154 lbs
194734	S9V2C100D5PSBA	100,000	97,000/63,050	96%	5.0	34" x 21" x 28-3/4"	2", 3", 4"	155 lbs
194735	S9V2D120D5PSBA	120,000	116,400/75,660	96%	5.0	34" x 24-1/2" x 28-3/4"	3", 4"	167 lbs

Note: Variable speed furnaces should not be twinned and are not approved for twinning applications.

S9X2, 2-Stage, 5-Speed High Efficiency, ECM Motor Gas Furnaces S9X2, Upflow/Horizontal Left/Horizontal Right Condensing Gas Furnace

Part #	Model #	Nominal Heating BTUH	Output BTUH High/Low	AFUE	Airflow in Tons	Dimensions H x W x D	Flue Size	Ship Weight
188892	S9X2B040U2PSA	40,000	38,800/25,220	95%	2.0	34" x 17-1/2" x 28-3/4"	2", 3", 4"	122 lbs
188893	S9X2B040U3PSA	40,000	38,800/25,220	96%	3.0	34" x 17-1/2" x 28-3/4"	2", 3", 4"	122 lbs
188894	S9X2B060U3PSA	60,000	58,200/37,830	95%	3.0	34" x 17-1/2" x 28-3/4"	2", 3", 4"	127 lbs
188895	S9X2B060U4PSA	60,000	58,200/37,830	95%	4.0	34" x 17-1/2" x 28-3/4"	2", 3", 4"	130 lbs
188896	S9X2B080U3PSA	80,000	77,600/50,440	95%	3.0	34" x 17-1/2" x 28-3/4"	2", 3", 4"	132 lbs
188897	S9X2B080U4PSA	80,000	77,600/50,440	95%	4.0	34" x 17-1/2" x 28-3/4"	2", 3", 4"	135 lbs
188898	S9X2C080U4PSA	80,000	77,600/50,440	96%	4.0	34" x 21" x 28-3/4"	2", 3", 4"	149 lbs
188899	S9X2C080U5PSA	80,000	77,600/50,440	96%	5.0	34" x 21" x 28-3/4"	2", 3", 4"	149 lbs
188911	S9X2C100U4PSA	100,000	97,000/63,050	95%	4.0	34" x 21" x 28-3/4"	2", 3", 4"	154 lbs
188910	S9X2C100U5PSA	100,000	97,000/63,050	95%	5.0	34" x 21" x 28-3/4"	2", 3", 4"	155 lbs
188909	S9X2D120U5PSA	120,000	116,400/75,660	95%	5.0	34" x 24-1/2" x 28-3/4"	2", 3", 4"	167 lbs

Gas Furnaces

S9X2, Downflow Condensing Gas Furnace

Part #	Model #	Nominal Heating BTUH	Output BTUH High/Low	AFUE	Airflow in Tons	Dimensions H x W x D	Flue Size	Ship Weight
188908	S9X2B040D2PSAA	40,000	38,800/25,220	96%	2	34" x 17-1/2" x 28-3/4"	2", 3", 4"	122 lbs
188907	S9X2B060D3PSAA	60,000	58,200/37,830	95%	3	34" x 17-1/2" x 28-3/4"	2", 3", 4"	127 lbs
188906	S9X2B080D4PSAA	80,000	77,600/50,440	95%	4	34" x 17-1/2" x 28-3/4"	2", 3", 4"	135 lbs
188905	S9X2C100D5PSAA	100,000	97,000/63,050	95%	5	34" x 17-1/2" x 28-3/4"	2", 3", 4"	155 lbs
188900	S9X2D120D5PSAA	120,000	116,400/75,660	95%	5	34" x 21" x 28-3/4"	3", 4"	167 lbs



S9V2/S9X2

Features	S9V2 Variable Speed	S9X2 Multi-Speed
Comfort-R™ enhanced mode (cooling)	✓	✓
Gas can enter either side of cabinet	✓	✓
Condensate can exit either side of cabinet in Upflow orientation	✓	✓
Multiple venting options - every model, every size will offer two venting options	✓	✓
Dry contact Humidifier/EAC hook-up credibility	✓	✓
Stainless steel primary and secondary heat exchanger tubes	✓	✓
Bottom panel	✓	✓
Direct drive, multi speed ECM blower motor - constant torque ECM (electronically commutated motor)	-	✓
Dual PVC pipe venting (1 or 2 pipe option)	✓	✓
Two stage combination gas valve and regulator	✓	✓
Gasketed inner and outer door	✓	✓
Insulated blower compartment	✓	✓
Mobile home approved and mobile home kit	✓	✓
Meets requirements for 2% or less air leakage	✓	✓
10-Year registered limited lifetime heat exchanger warranty and all other functional parts (residential use)	✓	✓
Warranty terms require registration within 60 days of installation; Extended warranties available	✓	✓

Options

Part #	Model Number	Description	Ship Weight	S9V2	S9X2
195560	BAYLPSS400B	LP Kit with stainless steel burners	3	✓	✓
5387	BAYVENT200B	Sidewall vent termination kit for direct vent furnaces	2	✓	✓
48393	BAYAIR30AVENTA	Concentric vent kit for 3" vent system	11	✓	✓
180086	BAYMFGH200A	Manufactured mobile home kit	1	✓	✓
91687	BAYBASE205	Downflow sub-base	8	✓	✓

Gas Furnaces

Platinum 95, Silver 95, Silver 95h, and American Standard 92 Convertible Gas Furnace Airflow Directions

Equipment

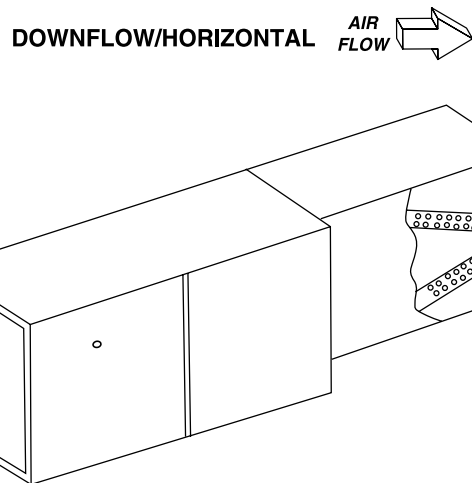
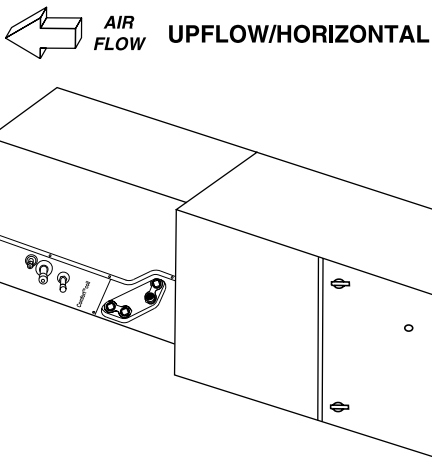
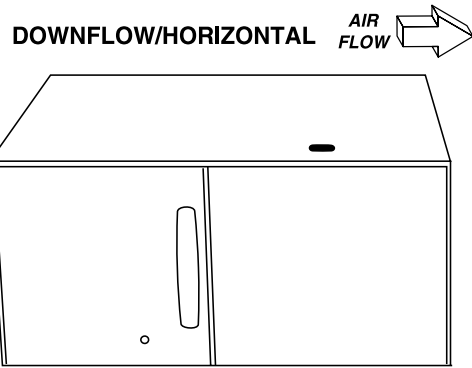
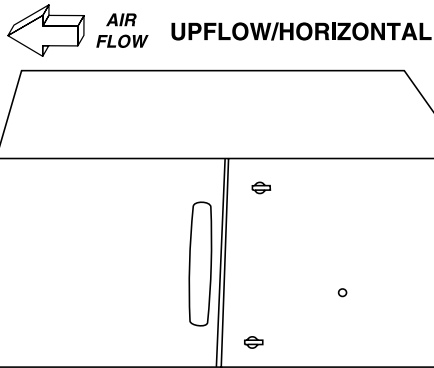
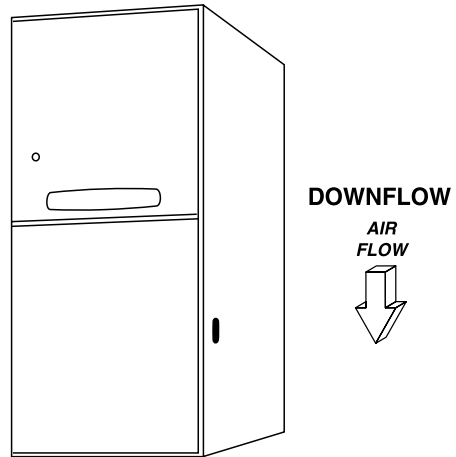
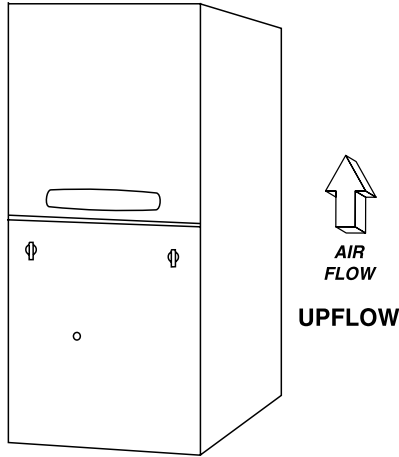

Note: The forty inch (40") height condensing downflow/horizontal and upflow/horizontal furnaces may only be rotated onto their left side. Connection brackets for coil/furnace alignment are included with the furnaces. The apex of the coil may point into or away from the airflow.

Gas Furnaces

Platinum 95, Silver 95, Silver 95h, and American Standard 92 Convertible Gas Furnaces

Platinum 95, Modulating, Communicating, ECM Variable-Speed Blower Gas Furnaces Platinum 95, Upflow/Horizontal Left Gas Furnace⁴

Part #	Model #	Nominal Heating BTUH	Output BTUH High/Low ³	AFUE Upflow/Horiz	Airflow in Tons	Dimensions H x W x D	Flue Size	Ship Weight
62794	AUHMB060ACV3VB	60,000	57,000/23,000	97.3 ² /96.5	3.0	40" x 17-1/2" x 28"	2", 2-1/2", 3"	158 lbs
62795	AUHMB080ACV3VB	80,000	76,000/31,000	97.0 ² /96.2	3.0	40" x 17-1/2" x 28"	2", 2-1/2", 3"	168 lbs
62796	AUHMC100ACV4VB	100,000	95,000/39,000	96.0/95.2	4.0	40" x 21" x 28"	2-1/2", 3"	197 lbs
62797	AUHMD120ACV5VB	120,000	114,000/52,000	97.0 ² /96.2	5.0	40" x 24-1/2" x 28"	3"	206 lbs

Must use communicating thermostat with AccuLink™ II Control, see pages 157-158

Note: Variable speed furnaces should not be twinned and are not approved for twinning applications.

2: Energy Star.

3: Low stage is equal to 45% for AUHMD120 model.

4: Furnace use in 24, non-communicating mode.

Platinum 95, Downflow/Horizontal Right Gas Furnace⁴

Part #	Model #	Nominal Heating BTUH	Output BTUH High/Low	AFUE	Airflow in Tons	Dimensions H x W x D	Flue Size	Ship Weight
62798	ADHMB060BCV3VB	60,000	57,000/22,800	95% ²	3.0	40" x 17-1/2" x 28"	2", 2-1/2", 3"	160 lbs
62799	ADHMB080ACV3VB	80,000	76,000/30,400	96% ²	3.0	40" x 17-1/2" x 28"	2", 2-1/2", 3"	168 lbs
62800	ADHMC100ACV4VB	100,000	96,000/38,400	96%	4.0	40" x 21" x 28"	2-1/2", 3"	185 lbs
62801	ADHMD120BCV5VB	120,000	114,000/51,300	95% ²	5.0	40" x 24-1/2" x 28"	3"	206 lbs

Must use communicating thermostat with AccuLink™ II Control, see pages 157-158

Note: Variable speed furnaces should not be twinned and are not approved for twinning applications.

2: Energy Star.

4: Furnace use in 24, non-communicating mode.

Silver 95, Single-Stage, Non-Communicating, PSC Blower, Upflow/Horizontal Gas Furnaces

Silver 95, Upflow/Horizontal Left Gas Furnaces

Part #	Model #	Nominal Heating BTUH	Output BTUH High/Low	AFUE Upflow/Horiz	Airflow in Tons	Dimensions H x W x D	Flue Size	Ship Weight
60598	AUH1B040A9241C	40,000	40,000/38,000	95.0/94.2	2.0	40" x 17-1/2" x 28"	2", 2-1/2", 3"	139 lbs
60599	AUH1B060A9361C	60,000	60,000/ 57,000	95.0/94.2	3.0	40" x 17-1/2" x 28"	2", 2-1/2", 3"	150 lbs
63655	AUH1C080A9601C	80,000	80,000/76,000	95.0/94.2	5.0	40" x 21" x 28"	3"	171 lbs
63657	AUH1D100A9601C	100,000	100,000/92,150	95.0/94.2	5.0	40" x 24-1/2" x 28"	3"	197 lbs
60602	AUH1D120A9601C	120,000	120,000/104,500	95.0/94.2	5.0	40" x 24-1/2" x 28"	3"	205 lbs

Silver 95, Downflow/Horizontal Right Gas Furnace

Part #	Model #	Nominal Heating BTUH	Output BTUH High/Low	AFUE	Airflow in Tons	Dimensions H x W x D	Flue Size	Ship Weight
64204	ADH1B040A9241A	40,000	40,000/38,000	95%	2.0	40" x 17-1/2" x 28"	2", 2-1/2", 3"	155 lbs
64205	ADH1B065A9421A	65,000	60,000/57,000	95%	3.5	40" x 17-1/2" x 28"	2", 2-1/2", 3"	168 lbs
64206	ADH1C085A9481A	85,000	80,000/76,000	95%	4.0	40" x 21" x 28"	2-1/2", 3"	185 lbs
64207	ADH1D110A9601A	110,000	110,000/104,500	95%	5.0	40" x 24-1/2" x 28"	2-1/2", 3"	206 lbs

Gas Furnaces

Platinum 95, Silver 95, Silver 95h, and American Standard 92 Convertible Gas Furnaces (cont.)

Silver 95h, Single-Stage, Non-Communicating, ECM Blower Gas Furnaces Silver 95h, Upflow/Horizontal Left Gas Furnaces

Part #	Model #	Nominal Heating BTUH	Output BTUH High/Low	AFUE	Airflow in Tons	Dimensions H x W x D	Flue Size	Ship Weight
76989	AUH1B040A9H21B	40,000	40,000/38,000	95%	2.0	40" x 17-1/2" x 28"	2", 2-1/2", 3"	139 lbs
76990	AUH1B060A9H31B	60,000	60,000/57,000	95%	3.0	40" x 17-1/2" x 28"	2", 2-1/2", 3"	150 lbs
76991	AUH1B080A9H31C	80,000	80,000/76,000	95%	3.5	40" x 17-1/2" x 28"	2", 2-1/2", 3"	158 lbs
76992	AUH1C100A9H41B	100,000	100,000/92,105	95%	4.0	40" x 21" x 28"	2-1/2", 3"	171 lbs

Silver 95h, Downflow/Horizontal Right Gas Furnaces

Part #	Model #	Nominal Heating BTUH	Output BTUH High/Low	AFUE	Airflow in Tons	Dimensions H x W x D	Flue Size	Ship Weight
77923	ADH1B065A9H31A	65,000	60,000/57,000	95%	2.0	40" x 17-1/2" x 28"	2", 2-1/2", 3"	158 lbs
77924	ADH1C085A9H41A	85,000	80,000/76,000	95%	4.0	40" x 21" x 28"	2-1/2", 3"	171 lbs

American Standard 92, Single-Stage, Non-Communicating, PSC Blower Gas Furnaces American Standard 92, Upflow/Horizontal Left Gas Furnaces

Part #	Model #	Nominal Heating BTUH	Output BTUH High/Low	AFUE Upflow/Horiz	Airflow in Tons	Dimensions H x W x D	Flue Size	Ship Weight
47080	AUC1B040A9241A	40,000	40,000/37,000	92.1/91.3	2.0	40" x 17-1/2" x 28"	2", 2-1/2", 3"	139 lbs
47081	AUC1B060A9361A	60,000	60,000/56,000	92.1/91.3	3.0	40" x 17-1/2" x 28"	2", 2-1/2", 3"	150 lbs
47082	AUC1B080A9421A	80,000	80,000/74,000	92.1/91.3	3.5	40" x 17-1/2" x 28"	2", 2-1/2", 3"	158 lbs
47083	AUC1C100A9481A	100,000	100,000/94,000	92.1/91.3	4.0	40" x 21" x 28"	2-1/2", 3"	171 lbs
47084	AUC1D100A9601A	100,000	100,000/93,000	92.1/91.3	5.0	40" x 24-1/2" x 28"	2-1/2", 3"	197 lbs
47085	AUC1D120A9601A	120,000	120,000/113,000	92.1/91.3	5.0	40" x 24-1/2" x 28"	2-1/2", 3"	205 lbs

American Standard 92, Downflow/Horizontal Right Gas Furnaces

Part #	Model #	Nominal Heating BTUH	Output BTUH High/Low	AFUE	Airflow in Tons	Dimensions H x W x D	Flue Size	Ship Weight
47086	ADC1B040A9241A	40,000	40,000/37,000	92.1%	2.0	40" x 17-1/2" x 28"	2-1/2", 3"	145 lbs
47088	ADC1B060A9361A	60,000	60,000/56,000	92.1%	3.0	40" x 17-1/2" x 28"	2-1/2", 3"	155 lbs
47089	ADC1B080A9421A	80,000	80,000/74,000	92.1%	3.5	40" x 17-1/2" x 28"	2-1/2", 3"	168 lbs
47090	ADC1C100A9481A	100,000	100,000/93,000	92.1%	4.0	40" x 21" x 28"	2-1/2", 3"	185 lbs
47091	ADC1D120A9601A	120,000	120,000/112,000	92.1%	5.0	40" x 24-1/2" x 28"	2-1/2", 3"	206 lbs

Models and Specifications are Subject to Change Without Notice

Gas Furnaces

Platinum 95, Silver 95, Silver 95h, and American Standard 92 Convertible Gas Furnaces (cont.)



Platinum 95/Silver 95/95h



American Standard 92

Features	Platinum 95 AUHM/ADHM Modulating 1 or 2 Pipe Variable Speed	Silver 95 AUH1/ADH1 1 Stage 1 or 2 Pipe	Silver 95h AUH1-H/ADH1-H 1 Stage 1 or 2 Pipe Variable Speed	American Standard 92 AUC1/ADC1 1 Stage 1 or 2 Pipe
Comfort-R™ enhanced mode (cooling)	✓	-	-	-
AccuLink™ system*	✓	-	-	-
Meets requirements for 2% or less air leakage	✓	✓	✓	-
Cleanable/reusable high velocity filters	✓	-	✓	-
Direct drive, multi-speed PSC blower motor	-	✓	-	✓
Direct drive, multi-speed ECM blower motor (high efficiency) constant torque ECM (electronically commutated motor)	-	-	✓	-
Direct drive, variable speed ECM blower motor constant airflow ECM (electronically commutated motor)	✓	-	-	-
Modulating gas valve and regulator	✓	-	-	-
Humidifier/EAC hook-up capability	✓	✓	✓	-
Insulated blower compartment 4 sides	✓	✓	✓	-
Left/right condensate drain capability in vertical application	✓	✓	✓	✓
Silicone Nitride hot surface igniter	✓	✓	✓	✓
Multiple heating blower speeds	✓	-	✓	-
20 Gauge aluminized steel heat exchanger	✓	✓	✓	✓
Type 29-4C™ stainless steel secondary heat exchanger	✓	✓	✓	✓
Variable speed venter motor	✓	-	-	-
Registered limited lifetime heat exchanger warranty and 10-year on all other functional parts (residential use)	✓	✓	✓	✓
Warranty terms require registration within 60 days of installation; Extended warranties available	✓	✓	✓	✓

*Field configurable to 24 V non-communicating mode.

Gas Furnaces

Platinum 95, Silver 95, Silver 95h, and American Standard 92 Convertible Gas Furnaces (cont.)

Options							
Part #	Model Number	Description	Ship Weight	Platinum 95 AUHM/ADHM Modulating 1 or 2 Pipe Variable Speed	Silver 95 AUH1/ADH1 1 Stage 1 or 2 Pipe	Silver 95h AUH1-H/ADH1-H 1 Stage 1 or 2 Pipe Variable Speed	American Standard 92 AUC1/ADC1 1 Stage 1 or 2 Pipe
91687	BAYBASE205	Downflow subbase for downflow models only	8	✓	✓	✓	✓
5401	BAYFLTR200	External side filter rack	5	✓	✓	✓	✓
5429	BAYFLTR203	Filter kit horiz conversion for 17.5" cabinet	3	✓	✓	✓	✓
5435	BAYFLTR204	Filter kit horiz conversion for 21" cabinet	3	✓	✓	✓	✓
5443	BAYFLTR205	Filter kit horiz conversion for 24.5" cabinet	3	✓	✓	✓	✓
5451	BAYFLTR206	Filter access door kit (Downflow only)	2	-	✓	-	✓
33043	BAYFLTR321*	Cleanable filter for 21" cabinet upflow only	2	✓	✓	-	-
33044	BAYFLTR324*	Cleanable filter for 24.5" cabinet upflow only	2	✓	✓	✓	-
10677	BAYLPKT210B	Propane conversion kit	1	-	✓	✓	-
163017	BAYLPKT220C	Propane conversion kit	2	✓	-	-	-
76645	BAYLPSS210B	LP Kit with stainless steel burners	1	-	✓	✓	✓
175704	BAYLPSS220B	LP Kit with stainless steel burners	2	✓	-	-	-
23496	BAYMFGH100A	Manufactured/mobile home kit	2	-	✓	✓	✓
40097	BAYRACK960A	Filter rack kit for upflow models only (internal)**	5	✓	✓	✓	-
48393	BAYAIR30AVENTA	Concentric vent kit for 2, 2½, and 3" vent system	11	✓	✓	✓	✓
5387	BAYVENT200B	Sidewall vent termination kit for direct vent furnaces	2	✓	✓	✓	✓
69661	BAYVENT500A	Side vent kit for downflow models only	3	✓	✓	✓	✓

*Contains one (1) high velocity filter.

**Internal filter rack for side or bottom return air. Includes 17 x 25" cleanable filter for use in side return applications. Bottom return applications require different sizes of filters which are not included. Airflow requirements over 1800 CFM require filters on both sides or a side and bottom or bottom only.

Gas Furnaces

Platinum 80, Gold 80v, Gold 80, Silver 80, and American Standard 80 Gas Furnaces Airflow Directions

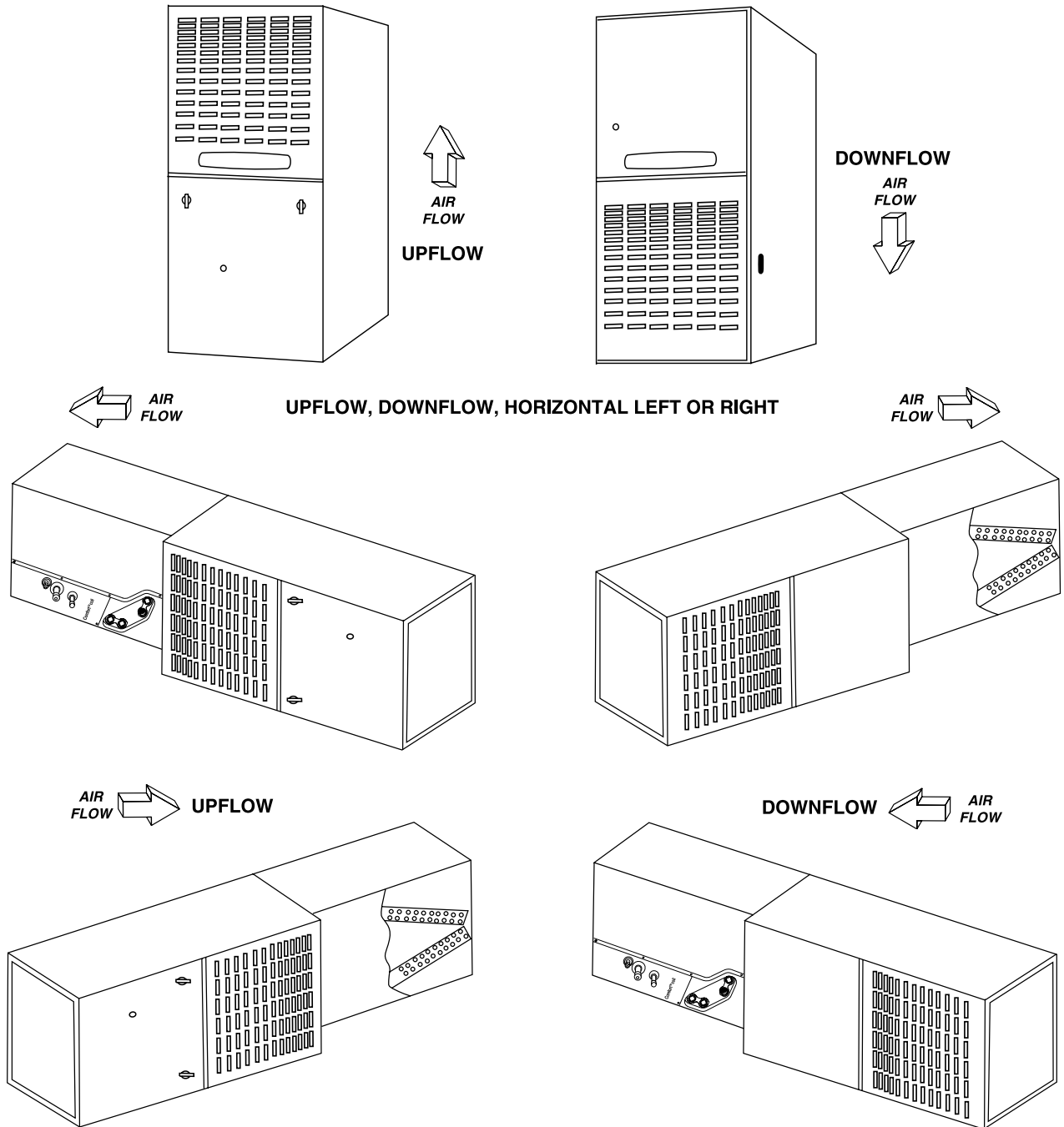

Note: The non-condensing, forty inch (40") height furnaces may be laid on either side for horizontal application. Connection brackets for coil/furnace alignment are included with the furnaces. The apex of the coil may point into or away from the airflow.

Gas Furnaces

Platinum 80, Gold 80v, Gold 80, Silver 80, and American Standard 80 Gas Furnaces

Platinum 80 2-Stage, Communicating, ECM Variable-Speed Blower Gas Furnaces Platinum 80 Induced Draft Upflow/Horizontal Left or Right Gas Furnaces

Part #	Model #	Nominal Heating BTUH	Output BTUH	AFUE	Airflow in Tons	Dimensions H x W x D	Flue Size	Ship Weight
58013	AUD2B060ACV32B	60,000	48,000/31,200	80%	3.0	40" x 17-1/2" x 28"	4"	136 lbs
58014	AUD2B080ACV32B	80,000	64,000/41,600	80%	3.0	40" x 17-1/2" x 28"	4"	142 lbs
59139	AUD2C080ACV42B	80,000	64,000/41,600	80%	4.0	40" x 21" x 28"	4"	155 lbs
58016	AUD2B100ACV32B	100,000	80,000/52,000	80%	3.0	40" x 17-1/2" x 28"	4"	148 lbs
58017	AUD2C100ACV52B	100,000	79,000/52,000	80%	5.0	40" x 21" x 28"	4"	175 lbs
58018	AUD2D120ACV52B	120,000	97,000/62,400	80%	5.0	40" x 24-1/2" x 28"	4"	193 lbs
58019	AUD2D140ACV52B	140,000	111,000/72,800	80%	5.0	40" x 24-1/2" x 28"	4"	197 lbs

Platinum 80 Induced Draft Downflow/Horizontal Left or Right Gas Furnaces

Part #	Model #	Nominal Heating BTUH	Output BTUH	AFUE	Airflow in Tons	Dimensions H x W x D	Flue Size	Ship Weight
58020	ADD2B060ACV32B	60,000	48,000/31,200	80.00%	3.0	40" x 17-1/2" x 28"	4"	140 lbs
58021	ADD2B080ACV32B	80,000	63,000/41,600	80.00%	3.0	40" x 17-1/2" x 28"	4"	146 lbs
59138	ADD2C100ACV52B	100,000	81,000/52,000	80.00%	5.0	40" x 21" x 28"	4"	166 lbs
58022	ADD2D120ACV52B	120,000	95,000/62,400	80.00%	5.0	40" x 24-1/2" x 28"	4"	197 lbs

Gold 80v, 2-Stage, Non-Communicating, ECM Variable-Speed Blower Gas Furnaces Gold 80v, Upflow/Horizontal Left or Right Gas Furnaces

Part #	Model #	Nominal Heating BTUH	Output BTUH	AFUE	Airflow in Tons	Dimensions H x W x D	Flue Size	Ship Weight
68724	AUD2B060A9V3VB	60,000	48,000/31,200	80%	3.0	40" x 17-1/2" x 28"	4"	136 lbs
68731	AUD2B080A9V3VB	80,000	64,000/41,600	80%	3.0	40" x 17-1/2" x 28"	4"	142 lbs
68743	AUD2B100A9V3VB	100,000	80,000/52,000	80%	3.0	40" x 17-1/2" x 28"	4"	142 lbs
68746	AUD2C100A9V5VB	100,000	79,000/52,000	80%	5.0	40" x 21" x 28"	4"	166 lbs
68747	AUD2D120A9V5VB	120,000	97,000/62,400	80%	5.0	40" x 24-1/2" x 28"	4"	193.0 lbs
68749	AUD2D140A9V5VB	140,000	111,000/72,800	80%	5.0	40" x 24-1/2" x 28"	4"	197 lbs

Gold 80v, Downflow/Horizontal Left or Right Gas Furnaces

Part #	Model #	Nominal Heating BTUH	Output BTUH	AFUE	Airflow in Tons	Dimensions H x W x D	Flue Size	Ship Weight
68752	ADD2B060A9V3VA	60,000	48,000/31,200	80%	3.0	40" x 17-1/2" x 28"	4"	140 lbs
68753	ADD2B080A9V3VA	80,000	63,000/41,600	80%	3.0	40" x 17-1/2" x 28"	4"	146 lbs
68755	ADD2C100A9V5VA	100,000	81,000/52,000	80%	5.0	40" x 21" x 28"	4"	166 lbs
68757	ADD2D120A9V5VA	120,000	95,000/62,400	80%	5.0	40" x 24-1/2" x 28"	4"	197 lbs

Models and Specifications are Subject to Change Without Notice

Gas Furnaces

Platinum 80, Gold 80v, Gold 80, Silver 80, and American Standard 80 Gas Furnaces (cont.)

Gold 80, 2-Stage, Non-Communicating, PSC Blower Gas Furnaces Gold 80, Upflow/Horizontal Left or Right Gas Furnaces

Part #	Model #	Nominal Heating BTUH	Output BTUH	AFUE	Airflow in Tons	Dimensions H x W x D	Flue Size	Ship Weight
3762	AUD2A040A9242A	40,000	32,000/20,800	80%	2.0	40" x 14-1/2" x 28"	4"	119 lbs
12385	AUD2A060A9362A	60,000	47,000/31,200	80%	3.0	40" x 14-1/2" x 28"	4"	127 lbs
2128	AUD2B080A9362A	80,000	63,000/41,600	80%	3.0	40" x 17-1/2" x 28"	4"	142 lbs
10639	AUD2B100A9362A	100,000	79,000/52,000	80%	3.0	40" x 17-1/2" x 28"	4"	151 lbs
10766	AUD2C100A9482A	100,000	79,000/52,000	80%	4.0	40" x 21" x 28"	4"	162 lbs
663	AUD2C120A9542A	120,000	95,000/62,400	80%	4.5	40" x 21" x 28"	4"	176 lbs
718	AUD2D120A9602A	120,000	95,000/62,400	80%	5.0	40" x 24-1/2" x 28"	4"	186 lbs
9168	AUD2D140A9602A	140,000	112,000/72,800	80%	5.0	40" x 24-1/2" x 28"	4"	192 lbs

Gold 80, Downflow/Horizontal Left or Right Gas Furnaces

Part #	Model #	Nominal Heating BTUH	Stg 2/Stg 1 Output BTUH	AFUE	Airflow in Tons	Dimensions H x W x D	Flue Size	Ship Weight
3270	ADD2A040A9242A	40,000	32,000/20,800	80%	2.0	40" x 14-1/2" x 28"	4"	125 lbs
11962	ADD2A060A9362A	60,000	47,000/31,200	80%	3.0	40" x 14-1/2" x 28"	4"	135 lbs
1733	ADD2B080A9362A	80,000	64,000/41,600	80%	3.0	40" x 17-1/2" x 28"	4"	152 lbs
10281	ADD2B100A9482A	100,000	79,000/52,000	80%	4.0	40" x 17-1/2" x 28"	4"	157 lbs
10307	ADD2C100A9482A	100,000	79,000/52,000	80%	4.0	40" x 21" x 28"	4"	166 lbs
267	ADD2D120A9602A	120,000	94,000/62,400	80%	5.0	40" x 24-1/2" x 28"	4"	189 lbs

Silver 80, Single-Stage, Non-Communicating, PSC Blower Gas Furnaces Silver 80, Upflow/Horizontal Left or Right Gas Furnaces

Part #	Model #	Nominal Heating BTUH	Output BTUH	AFUE	Airflow in Tons	Dimensions H x W x D	Flue Size	Ship Weight
13932	AUD1A040A9241B	40,000	32,000	80%	2.0	40" x 14-1/2" x 28"	4"	119 lbs
3628	AUD1A060A9241B	60,000	32,000	80%	2.0	40" x 14-1/2" x 28"	4"	124 lbs
3763	AUD1A060A9361B	60,000	32,000	80%	3.0	40" x 14-1/2" x 28"	4"	127 lbs
45600	AUD1B060A9361B	60,000	47,000	80%	3.0	40" x 17-1/2" x 28"	4"	132 lbs
12194	AUD1B080A9241B	80,000	64,000	80%	2.0	40" x 17-1/2" x 28"	4"	139 lbs
12291	AUD1B080A9361B	80,000	63,000	80%	3.0	40" x 17-1/2" x 28"	4"	142 lbs
2044	AUD1B100A9361B	100,000	79,000	80%	3.0	40" x 17-1/2" x 28"	4"	151 lbs
2103	AUD1B100A9451B	100,000	80,000	80%	4.0	40" x 17-1/2" x 28"	4"	153 lbs
2129	AUD1C100A9481B	100,000	79,000	80%	4.0	40" x 21" x 28"	4"	162 lbs
10702	AUD1C120A9541B	120,000	96,000	80%	5.0	40" x 21" x 28"	4"	176 lbs
10767	AUD1D120A9601B	120,000	96,000	80%	5.0	40" x 24-1/2" x 28"	4"	186 lbs
617	AUD1D140A9601B	140,000	111,000	80%	5.0	40" x 24-1/2" x 28"	4"	193 lbs

Gas Furnaces

Platinum 80, Gold 80v, Gold 80, Silver 80, and American Standard 80 Gas Furnaces (cont.)

Silver 80, Downflow/Horizontal Left or Right Gas Furnaces

Part #	Model #	Nominal Heating BTUH	Output BTUH	AFUE	Airflow in Tons	Dimensions H x W x D	Flue Size	Ship Weight
3158	ADD1A060A9241B	60,000	48,000	80%	2.0	40" x 14-1/2" x 28"	4"	129 lbs
3271	ADD1A060A9361B	60,000	48,000	80%	3.0	40" x 14-1/2" x 28"	4"	129 lbs
45598	ADD1B060A9361B	60,000	48,000	80%	3.0	40" x 17-1/2" x 28"	4"	134 lbs
11868	ADD1B080A9361B	80,000	64,000	80%	3.0	40" x 17-1/2" x 28"	4"	146 lbs
1697	ADD1B100A9451B	100,000	80,000	80%	4.0	40" x 17-1/2" x 28"	4"	156 lbs
1734	ADD1C100A9481B	100,000	80,000	80%	4.0	40" x 21" x 28"	4"	166 lbs
20525	ADD1C120A9541B	120,000	96,000	80%	5.0	40" x 21" x 28"	4"	177 lbs

American Standard 80, Single-Stage, Non-Communicating, PSC Blower Gas Furnaces American Standard 80, Upflow/Horizontal Left or Right Gas Furnaces

Part #	Model #	Nominal Heating BTUH	Output BTUH	AFUE	Airflow in Tons	Dimensions H x W x D	Flue Size	Ship Weight
46865	AUE1A040A9241A	40,000	31,000	80%	2.0	40" x 14-1/2" x 28"	4"	119 lbs
46866	AUE1A060A9241A	60,000	47,000	80%	2.0	40" x 14-1/2" x 28"	4"	124 lbs
46867	AUE1A060A9361A	60,000	47,000	80%	3.0	40" x 14-1/2" x 28"	4"	127 lbs
46868	AUE1B060A9361A	60,000	47,000	80%	3.0	40" x 17-1/2" x 28"	4"	132 lbs
46869	AUE1B080A9361A	80,000	63,000	80%	3.0	40" x 17-1/2" x 28"	4"	142 lbs
46870	AUE1B080A9481A	80,000	64,000	80%	4.0	40" x 17-1/2" x 28"	4"	142 lbs
46871	AUE1B100A9361A	100,000	79,000	80%	3.0	40" x 17-1/2" x 28"	4"	151 lbs
46872	AUE1C100A9481A	100,000	79,000	80%	4.0	40" x 21" x 28"	4"	162 lbs
46874	AUE1D120A9601A	120,000	96,000	80%	5.0	40" x 24-1/2" x 28"	4"	186 lbs
46875	AUE1D140A9601A	140,000	111,000	80%	5.0	40" x 24-1/2" x 28"	4"	193 lbs



A MUNCH'S SUPPLY COMPANY

WE APPRECIATE YOUR BUSINESS!

Gas Furnaces

Platinum 80, Gold 80v, Gold 80, Silver 80, and American Standard 80 Gas Furnaces (cont.)

American Standard 80, Downflow/Horizontal Left or Right Gas Furnaces

Part #	Model #	Nominal Heating BTUH	Output BTUH	AFUE	Airflow in Tons	Dimensions H x W x D	Flue Size	Ship Weight
46859	ADE1A060A9361A	60,000	48,000	80%	3.0	40" x 14-1/2" x 28"	4"	129 lbs
46860	ADE1B060A9361A	60,000	48,000	80%	3.0	40" x 17-1/2" x 28"	4"	134 lbs
46861	ADE1B080A9451A	80,000	64,000	80%	4.0	40" x 17-1/2" x 28"	4"	146 lbs
46862	ADE1B100A9451A	100,000	80,000	80%	4.0	40" x 17-1/2" x 28"	4"	156 lbs
46864	ADE1D120A9601A	120,000	96,000	80%	5.0	40" x 24-1/2" x 28"	4"	189 lbs



Platinum 80



Gold 80



Silver 80



American Standard 80

Gas Furnaces

Platinum 80, Gold 80v, Gold 80, Silver 80, and American Standard 80 Gas Furnaces (cont.)

Equipment

Features	Platinum 80 AUD2-ACV ADD2-ACV 2-Stage 1 or 2 Pipe Variable Speed	Gold 80v AUD2-9V ADD2-9V 2-Stage Variable Speed	Gold 80 AUD2 ADD2 2-Stage	Silver 80 AUD1 ADD1 1-Stage	American Standard 80 AUE1 ADE1 1-Stage
Comfort-R™ enhanced mode (cooling)	✓	✓	-	-	-
AccuLink™ system*	✓	-	-	-	-
Can be connected in communicating or 24 V non-communicating modes	✓	-	-	-	-
Easy to use navigation buttons and plain text for clear descriptions of features	✓	✓	-	✓	-
Meets requirements for 2% or less air leakage	✓	-	-	✓	-
Bottom panel (upflow models only)	✓	✓	✓	✓	-
Cleanable/reusable high velocity filters	✓	✓	-	-	-
Common vent capability	✓	✓	✓	✓	✓
Direct drive, multi-speed PSC blower motor	-	-	✓	✓	✓
Direct drive, multi-speed ECM blower motor (high efficiency) - constant torque ECM (electronically commutated motor)	-	-	-	-	-
Direct drive, variable speed ECM blower motor - constant airflow ECM (electronically commutated motor)	✓	✓	-	-	-
Gasketed blower door	✓	✓	✓	✓	✓
Horizontal left/right without conversion required	✓	✓	✓	✓	✓
Humidifier/EAC hook-up capability	✓	✓	✓	✓	-
Insulated blower compartment 4 sides (upflow models only)	✓	✓	✓	✓	-
Integrated solid state control with self diagnostics	✓	✓	✓	✓	✓
Masonry chimney venting with BAYVENT800B	✓	✓	✓	✓	✓
Silicone Nitride hot surface igniter with adaptive heat up	✓	✓	✓	✓	✓
Multiple heating blower speeds	✓	✓	✓	-	-
Two-speed venter motor	✓	✓	✓	-	-
Two-stage gas valve	✓	✓	✓	-	-
Registered limited lifetime heat exchanger warranty and 10-year on all other functional parts (residential use)	✓	✓	-	-	-
Registered 20-year heat exchanger limited warranty and 10-year on all other functional parts (residential use)	-	-	✓	✓	✓
Warranty terms require registration within 60 days of installation; Extended warranties available	✓	✓	✓	✓	✓

Gas Furnaces

Platinum 80, Gold 80v, Gold 80, Silver 80h, Silver 80, and American Standard 80 Gas Furnaces (cont.)

Options								
Part #	Model Number	Description	Ship Weight	Platinum 80 AUD2-ACV ADD2-ACV 2-Stage Variable Speed	Gold 80v AUD2-9V ADD2-9V 2-Stage Variable Speed	Gold 80 AUD2 ADD2 2-Stage	Silver 80 AUD1 ADD1 1-Stage	American Standard 80 AUE1 ADE1 1-Stage
91687	BAYBASE205	Downflow subbase for downflow models only	8	✓	✓	✓	✓	✓
5401	BAYFLTR200	External side filter rack	5	✓	✓	✓	✓	✓
5429	BAYFLTR203	Filter kit horiz conversion for 17.5" cabinet	3	✓	✓	✓	✓	✓
5435	BAYFLTR204	Filter kit horiz conversion for 21" cabinet	3	✓	✓	✓	✓	✓
5443	BAYFLTR205	Filter kit horiz conversion for 24.5" cabinet	3	✓	✓	✓	✓	✓
5451	BAYFLTR206	Filter access door kit (downflow only)	2	✓	✓	✓	✓	✓
104593	BAYFLTR317*	Cleanable filter for 14.5" and 17.5" cabinet upflow only	2	-	-	-	-	-
33043	BAYFLTR321*	Cleanable filter for 21" cabinet upflow only	2	✓	✓	✓	✓	✓
33044	BAYFLTR324*	Cleanable filter for 24.5" cabinet upflow only	2	✓	✓	✓	✓	✓
10677	BAYLPKT210B	Propane conversion kit	1	✓	✓	✓	✓	✓
76645	BAYLPSS210B	LP Kit with stainless steel burners	1	✓	✓	✓	✓	✓
40097	BAYRACK960A	Filter rack kit for upflow models only (internal)**	5	✓	✓	✓	✓	✓
23145	BAYVENT800B	Sidewall vent termination kit for direct vent furnaces	2	✓	✓	✓	✓	✓

*Contains one (1) high velocity filter.

**Internal filter rack for side or bottom return air. Includes 17 x 25" cleanable filter for use in side return applications. Bottom return applications require different sizes of filters which are not included. Airflow requirements over 1800 CFM require filters on both sides or a side and bottom or bottom only.



A MUNCH'S SUPPLY COMPANY

We maintain well-stocked and conveniently located warehouses. Please visit us at the branch nearest you.

Oil Furnaces

American Standard and Trane Oil Furnaces. Warmth, comfort and efficiency with American Standard and Trane reliability.

Configured to fit your home.

No matter what your size requirements, our oil furnace family has an option that will fit your home perfectly. And you can count on your American Standard and Trane dealer to assist you in selecting the right model for your home.

- Lowboy: a short, 41-1/2" vertical configuration, perfect for tight spaces.
- Low Profile Highboy: a 45" vertical cabinet for THVIC models.
- Highboy: a 50-1/8" vertical cabinet for THVIM models.
- Downflow/Horizontal: designed to be installed either on its side in crawl spaces or vertically in closets, basements, utility rooms.

When winter sends its worst, you'll be glad you have an American Standard or Trane.

When winds are howling and the temperature drops, let a hard working, dependable American Standard and Trane oil furnace keep you warm and comfortable. American Standard and Trane oil furnaces are built tough for substantial reliability. And they're built to perform, providing efficiency and warmth through even the most brutal winters.

Stay warm. Stay smart.

The efficiency of any furnace is measured in AFUE, or Annual Fuel Utilization Efficiency. AFUE measures how much of the fuel you pay for is actually turned into usable heat. Because of their smart design, American Standard and Trane oil furnaces have an AFUE of 85%, meaning 85% of your fuel is converted to heat. With that kind of efficiency, you can keep your home the way you like it while still using energy wisely.

A new American Standard or Trane furnace with a higher AFUE can save you money every month.

If you have an older furnace, you may be spending more on fuel than you need to.



Oil Furnaces

American Standard and Trane oil furnaces provide efficient, dependable comfort you can rely on.



TLF/TLR Series with ECM Blower Motor

With a highly-efficient ECM blower for quieter operation and more even, steady heat, the TLF/TLR offers an AFUE of 85%, meaning up to 85% of your fuel is turned into usable heat. During summer, Comfort-Rtm helps control humidity.

TLF/TLR Series with PSC Blower Motor

An innovative design delivers an AFUE of up to 85%. A four-speed blower motor helps fine-tune your comfort while lowering noise levels and boosting efficiency.

- 1. Heat Exchanger.** Made of rugged steel, the heat exchanger is where the cool air of your home is warmed by the furnace. American Standard and Trane builds them to last.
- 2. Combustion Chamber.** Designed for extremely quiet operation, the ceramic fiber combustion chamber is where fuel is burned to generate heat.
- 3. Oil Burner.** The heart of the furnace. Time tested and proven Beckett burners deliver long life while stretching every fuel dollar.
- 4. Variable-Speed Blower Motor with Comfort-Rtm.** Quieter and more efficient than conventional blowers, variable-speed blowers deliver a more consistent, even flow of heat throughout your home to eliminate hot and cold spots. During the summer, Comfort-Rtm humidity control regulates moisture levels for more energy-efficient comfort. ECM motor program will not support Trane Zone System.
- 5. Insulated Cabinet And Blower Compartment.** Well-insulated cabinet greatly reduces energy loss and operating noise.
- 6. Durable Steel Cabinet.** Powder painted heavy gauge steel is strong and durable.
- 7. Cleanable Filter (Not Shown) Included with most models.**

Air Handlers

Variable-Speed Multi-Position Air Handlers, 2-5 Tons

Series 9 TAM9 Variable-Speed Air Handler with AccuLink™/ComfortLink™ and Smart Fan Options

Part #	Model #	Tons	Nom Cool BTUH	Electrical	Line Set Liq, Suc	Dimensions H x W x D	Ship Weight
190623	TAM9A0A24V21DA	2	24,000	200/230-1-60	3/8", 3/4"	49-7/8" x 17-1/2" x 21-3/4"	126 lbs
190624	TAM9A0B30V31DA	2½	30,000	200/230-1-60	3/8", 3/4"	55-3/4" x 21-1/2" x 21-3/4"	150 lbs
190625	TAM9A0C36V31DA	3	36,000	200/230-1-60	3/8", 7/8"	56-7/8" x 23-1/2" x 21-3/4"	157 lbs
190626	TAM9A0C42V41DA	3½	42,000	200/230-1-60	3/8", 7/8"	56-7/8" x 23-1/2" x 21-3/4"	162 lbs
190627	TAM9A0C48V41DA	4	48,000	200/230-1-60	3/8", 7/8"	61-3/4" x 23-1/2" x 21-3/4"	174 lbs
190628	TAM9A0C60V51DA	5	60,000	200/230-1-60	3/8", 7/8"	61-3/4" x 23-1/2" x 21-3/4"	175 lbs



Series 9/TAM9



Series 9/TAM9

Features	Series 9 TAM9
R-410A refrigerant	✓
AccuLink™ II or 24 V control	✓
Meets requirements for 2% or less air leakage	✓
Multi-position up/down flow horizontal left/right	✓
Side return option (sold separately)	✓
Control board protection built into cabinet wall	✓
Alert code notification	✓
Low voltage terminal connection point	✓
Vortica® blower with polarized plug connections and integrated slide deck for easy removal	✓
Aluminum coil with integrated slide deck for easy removal and polarized plug connections on coil EEV	✓
Labeled panels and connections	✓
Molded in 1" standard filter rail	✓
Electronic Expansion Valve (EEV) with low ambient and low superheat compressor protection	✓
Dual refrigerant compatible as shipped	✓
Direct drive, variable speed ECM blower motor - constant airflow ECM (electronically commutated motor)	✓
Comfort R™ mode and built-in fan delay modes	✓
5-year base limited warranty and 10-year registered limited warranty	✓
Warranty terms require registration within 60 days of installation; Extended warranties available.	✓

Models and Specifications are Subject to Change Without Notice

Air Handlers

Series 9 TAM9 Variable-Speed Air Handler with AccuLink™/ComfortLink™ and Smart Fan Options (cont.)

Options				
Part #	Model Number	Description	Matches Cabinet Size ¹	Series 9 TAM9
71519	BAYCC24VK01A	Compressor Module Kit		✓
144058	BAYWAAA05SC1AA	Hydronic Heater, 40,000 BTUH, Nominal ³	17.5"	✓
84842	BAYWABB07SC1AA	Hydronic Heater, 50,000 BTUH, Nominal ³	21.5"	✓
84843	BAYWACC08SC1AA	Hydronic Heater, 65,000 BTUH, Nominal ³	23.5"	✓
79828	BAYWACC11SC1AA	Hydronic Heater, 100,000 BTUH, Nominal, External, No Control ³	23.5"	✓
192188	BAYWAKIT24VAC	Hydronic Heater Relay Kit	23.5"	✓
71499	BAYSUPFLGAA	Supply Duct Flange A - 17.5"	17.5"	✓
71500	BAYSUPFLGBA	Supply Duct Flange B - 21.5"	21.5"	✓
71501	BAYSUPFLGCA	Supply Duct Flange C - 23.5"	23.5"	✓
71502	BAYRETFLGAA	Return Duct Flange A - 17.5"	17.5"	✓
71503	BAYRETFLGBA	Return Duct Flange B - 21.5"	21.5"	✓
71504	BAYRETFLGCA	Return Duct Flange C - 23.5"	23.5"	✓
189693	BAYFLR2220A	Washable high velocity filter, 22" x 20" x 1" (10 filters)	23.5"	✓
186769	MTISRKIT1620 ²	Side Return Kit with 16" x 20" Filter	17.5", 23.5"	✓
80736	BAYSPEKT200	Single Power Entry Kit		✓
71511	BAYICSKIT01	Internal Condensate Switch Kit		✓
71512	BAYHHKIT001	Horizontal Hanger Kit		✓
71518	BAYLVKIT100	Low Voltage Conduit Entry Kit		✓

1. A Cabinet is 17.5" wide, B Cabinet is 21.5" wide, C Cabinet is 23.5" wide.
2. Contact Tommark for information.

**QUALITY.
SERVICE.
TOMMARK.**

Air Handlers

Single Phase Multi-Position Air Handlers, 1½-5 Tons

Series 5 GAM5 Multi-Speed Air Handler with High Efficiency Motor

Part #	Model #	Tons	Nom Cool BTUH	Electrical	Line Set Liq, Suc	Dimensions H x W x D	Ship Weight
69113	GAM5B0A18M11EA	1.5	18,000	200/230-1-60	3/8", 3/4"	49.9" x 17.5" x 21.8"	126 lbs
69114	GAM5B0A24M21EA	2.0	24,000	200/230-1-60	3/8", 3/4"	49.9" x 17.5" x 21.8"	126 lbs
69115	GAM5B0B30M21EA	2.5	30,000	200/230-1-60	3/8", 3/4"	51.5" x 21.5" x 21.8"	140 lbs
69116	GAM5B0B36M31EA	3.0	36,000	200/230-1-60	3/8", 7/8"	55.7" x 21.5" x 21.8"	150 lbs
69117	GAM5B0C42M31EA	3.5	42,000	200/230-1-60	3/8", 7/8"	56.9" x 23.5" x 21.8"	163 lbs
69118	GAM5B0C48M41EA	4.0	48,000	200/230-1-60	3/8", 7/8"	61.7" x 23.5" x 21.8"	176 lbs
69120	GAM5B0C60M51EA	5.0	60,000	200/230-1-60	3/8", 7/8"	61.7" x 23.5" x 21.8"	180 lbs

Series 4 TAM4 Multi-Speed PSC Motor Air Handler

Part #	Model #	Tons	Nom Cool BTUH	Electrical	Line Set Liq, Suc	Dimensions H x W x D	Ship Weight
71482	TAM4A0A18S11ED	1.5	18,000	200/230-1-60	3/8", 3/4"	49.9" x 17.5" x 21.8"	123 lbs
71483	TAM4A0A24S21ED	2.0	24,000	200/230-1-60	3/8", 3/4"	49.9" x 17.5" x 21.8"	126 lbs
71484	TAM4A0A30S21ED	2.5	30,000	200/230-1-60	3/8", 7/8"	49.9" x 17.5" x 21.8"	127 lbs
71485	TAM4A0A36S31ED	3.0	36,000	200/230-1-60	3/8", 7/8"	49.9" x 17.5" x 21.8"	130 lbs
71486	TAM4A0B42S31ED	3.5	42,000	200/230-1-60	3/8", 7/8"	55.7" x 21.3" x 21.8"	144 lbs
71487	TAM4A0C48S41ED	4.0	48,000	200/230-1-60	3/8", 7/8"	56.9" x 23.5" x 21.8"	155 lbs
71488	TAM4A0C60S51ED*	5.0	60,000	200/230-1-60	3/8", 7/8"	61.7" x 23.5" x 21.8"	171 lbs



GAM/TAM



GAM/TAM

Features	Series 5 GAM5	Series 4 TAM4
Meets requirements for 2% or less air leakage	✓	✓
Multi-position up/down flow horizontal left/right	✓	✓
Side return option (sold separately)	✓	✓
Alert code notification	-	✓
Low voltage pigtail connections	✓	✓
Vortica® blower with polarized plug connections and integrated slide deck for easy removal	✓	✓
Aluminum coil with integrated slide deck for easy removal	✓	✓
Labeled panels and connections	✓	✓
Molded in 1" standard filter rail	✓	✓
Electronic Expansion Valve (EEV) with low ambient and low superheat compressor protection	-	✓
Dual refrigerant compatible as shipped	-	✓
Safety door switch	✓	✓
Patented enhanced coil fin	✓	✓
Fused 24 V power	✓	✓
PSC 3-speed motor	-	1½-4
Direct drive, multi speed ECM blower motor - Constant torque ECM (electronically commutated motor)	✓	5
5-year base limited warranty and 10-year registered limited warranty	✓	✓
Warranty terms require registration within 60 days of installation; Extended warranties available.	✓	✓

Air Handlers

Series 5 GAM5 and Series 4 TAM4 Air Handler Options

Options					
Part #	Model Number	Description	Matches Cabinet Size(s) ¹	Series 5 GAM5	Series 4 TAM4
144058	BAYWAAA05SC1AA	Hydronic Heater, 40,000 BTUH, Nominal, Slide-in, No Control	17.5"	✓	-
84842	BAYWABB07SC1AA	Hydronic Heater, 50,000 BTUH, Nominal, Slide-in, No Control	21.5"	✓	-
84843	BAYWACC08SC1AA	Hydronic Heater, 65,000 BTUH, Nominal, Slide-in, No Control	23.5"	✓	-
79828	BAYWACC11SC1AA	Hydronic Heater, 100,000 BTUH, Nominal, Slide-in, No Control	23.5"	✓	-
71499	BAYSUPFLGAA	Supply Duct Flange A - 17.5"	17.5"	✓	✓
71500	BAYSUPFLGBA	Supply Duct Flange B - 21.5"	21.5"	✓	✓
71501	BAYSUPFLGCA	Supply Duct Flange C - 23.5"	23.5"	✓	✓
71502	BAYRETLGAA	Return Duct Flange A - 17.5"	17.5"	✓	✓
71503	BAYRETLGGBA	Return Duct Flange B - 21.5"	21.5"	✓	✓
71504	BAYRETLGCA	Return Duct Flange C - 23.5"	23.5"	✓	✓
189693	BAYFLR2220A	Washable high velocity filter, 22" x 20" x 1" (10 filters)	23.5"	✓	✓
186769	MTISRKIT1620 ²	Side Return Kit with 16" x 20" Filter	17.5", 23.5"	✓	✓
80736	BAYSPEKT200	Single Power Entry Kit		✓	✓
71510	BAYSRKIT100	Side Return Kit	17.5", 23.5"	✓	✓
71511	BAYICKIT01	Internal Condensate Switch Kit		✓	✓
71512	BAYHHKIT001	Horizontal Hanger Kit		✓	✓
71518	BAYLVKIT100A	Low Voltage Conduit Entry Kit		✓	✓

1. A Cabinet is 17.5" wide, B Cabinet is 21.5" wide, C Cabinet is 23.5" wide.
2. Contact Tommark for information.

Air Handlers

Series 2 Single Phase Split System Air Handlers, 1½-3 Tons

GAF2 Multi-Speed PSC Air Handlers

Part #	Model #	Tons	Nom Cool BTUH	Electrical	Line Set Liq, Suc	Dimensions H x W x D	Ship Weight
81702	GAF2A0A18S1IEE	1.5	18,000	200/230-1-60	3/8", 3/4"	39.5" x 17.5" x 21.8"	117 lbs
81703	GAF2A0A24S2IEE	2.0	24,000	200/230-1-60	3/8", 3/4"	39.5" x 17.5" x 21.8"	120 lbs
81704	GAF2A0A30S2IEE	2.5	30,000	200/230-1-60	3/8", 3/4"	39.5" x 17.5" x 21.8"	121 lbs
81705	GAF2A0A36S3IEE	3.0	36,000	200/230-1-60	3/8", 3/4"	39.5" x 17.5" x 21.8"	122 lbs

GAF2 Multi-Speed High Efficiency ECM Air Handler

Part #	Model #	Tons	Nom Cool BTUH	Electrical	Line Set Liq, Suc	Dimensions H x W x D	Ship Weight
81709	GAF2A0A36M3IEC	3.0	36,000	200/230-1-60	3/8", 3/4"	39.5" x 17.5" x 21.8"	118 lbs



Series 2/GAF2



Series 2/GAF2

Features	Series 2 GAF2
Meets requirements for 2% or less air leakage	✓
3 way conversion up flow/horizontal left/right	✓
Front return option	✓
Low voltage pigtail connections	✓
Vortica® blower with polarized plug connections and integrated slide deck for easy removal	✓
Patented enhanced coil fin	✓
Labeled panels and connections	✓
Fused 24 V power	✓
PSC 3-speed motor	✓
Direct drive, multi speed ECM blower motor - Constant torque ECM (electronically commutated motor) (GAF2A0A36M31)	3
5-year base limited warranty and 10-year registered limited warranty	✓
Warranty terms require registration within 60 days of installation; Extended warranties available.	✓

Options

Part #	Model Number	Description	Series 2 GAF2
129343	BAYATXV1836B	R-22 TXV conversion kit 1½ to 3 ton	✓
108198	BAYBRFBX100	Bottom Return Filter Box	✓
81963	BAYFRKIT100	Front Return Kit	✓
71511	BAYICKIT01	Internal Condensate Switch Kit (GAF2A0A36M31ISA)	3
71518	BAYLVKIT100	Low Voltage Conduit Entry Kit	✓
71502	BAYRETFLGAA	Return Duct Flange A, A1	✓
71510	BAYSRKIT100	Side Return Kit	✓
186769	MTISRKIT1620 ²	Side Return Kit with 16"x20" Filter	✓

1. A and A1 Cabinets are 17.5" wide, B Cabinet is 21.5" wide, C Cabinet is 23.5" wide. The A1 cabinet is used on the GAF2 air handlers only.

2. Contact your distributor for information.

Heaters for Multi-Position Air Handlers

Heaters for Multi-Position Air Handlers

BAYEA - Heater, Standard, for Series 9, Series 5, and Series 4 Air Handlers

Part #	Model Number	Capacity @ 240 V		Capacity @ 208 V		Rated Voltage	Control Stages	# of Heater Racks	# of Circuits	Heater Amps per Circuit		Contains Circuit Breakers
		kW	BTUH	kW	BTUH					208 V	240 V	
70747	BAYEAAC05BK1BA	4.8	16400	3.6	12300	208/240/1/60	1	1	1	17.3	20	Yes
70748	BAYEAAC08BK1BA	7.68	26200	5.76	19700	208/240/1/60	2	2	1	27.7	32	Yes
70749	BAYEAAC10BK1BA	9.6	32800	7.2	24600	208/240/1/60	2	2	1	34.6	40	Yes
70750	BAYEABC15BK1BA	14.4	49200	10.8	36900	208/240/1/60	3	3	2	34.6/17.3	40/20	Yes
70751	BAYEABC20BK1BA	19.2	65600	14.4	49200	208/240/1/60	3	4	2	34.6/34.6	40/40	Yes
70752	BAYEACC25BK1BA	24	82000	18	61500	208/240/1/60	3	5	3	34.6/34.6/17.3	40/40/20	Yes

BK = Contains circuit breakers

BAYEC - Heater, Compact, with Lugs, for GAF2 Air Handlers

Part #	Model Number	Capacity @ 240 V		Capacity @ 208 V		Rated Voltage	Control Stages	# of Heater Racks	# of Circuits	Heater Amps per Circuit		Contains Circuit Breakers
		kW	BTUH	kW	BTUH					208 V	240 V	
188217	BAYECAA10LG1BA	9.6	32800	7.2	24600	208/240/1/60	2	2	1	34.6	40	No

BAYECPDKIT1 - Optional pull disconnect used with BAYEC heaters only

**QUALITY.
SERVICE.
TOMMARK.**

Heaters for Multi-Position Air Handlers

Equipment

AIR HANDLER

Model Number	BAYEAA05BK1BA 4.80 Kw BK	BAYEAA08BK1BA 7.68 Kw BK	BAYEAA08LG1BA 7.68 Kw LG	BAYEAA10BK1BA 9.60 Kw BK	BAYEAA10LG1BA 9.60 Kw LG	BC15BK1BA 14.40 Kw BK	BC20BK1BA 19.20 Kw BK	CC25BK1BA 24.00 Kw BK	BAYEAA10LG3BA 9.60 Kw LG	BC15LG3BA 9.60 Kw LG
TAM9A0A24V21	Y	Y	Y	Y	Y	-	-	-	Y	-
TAM9A0B30V31	Y	Y	Y	Y	Y	Y	-	-	Y	Y
TAM9A0C36V31	Y	Y	Y	Y	Y	Y	Y	-	Y	Y
TAM9A0C42V41	Y	Y	Y	Y	Y	Y	Y	-	Y	Y
TAM9A0C48V41	Y	Y	Y	Y	Y	Y	Y	Y	Y	Y
TAM9A0C60V51	Y	Y	Y	Y	Y	Y	Y	Y	Y	Y
GAM5B0A18M11	Y	Y	Y	Y	Y	-	-	-	Y	-
GAM5B0A24M21	Y	Y	Y	Y	Y	-	-	-	Y	-
GAM5B0B30M21	Y	Y	Y	Y	Y	Y	-	-	Y	Y
GAM5B0B36M31	Y	Y	Y	Y	Y	Y	-	-	Y	Y
GAM5B0C42M31	Y	Y	Y	Y	Y	Y	-	-	Y	Y
GAM5B0C48M41	Y	Y	Y	Y	Y	Y	Y	Y	Y	Y
GAM5B0C60M51	Y	Y	Y	Y	Y	Y	Y	Y	Y	Y
TAM4A0A18S11	Y	Y	Y	Y	Y	-	-	-	Y	-
TAM4A0A24S21	Y	Y	Y	Y	Y	-	-	-	Y	-
TAM4A0A30S21	Y	Y	Y	Y	Y	Y	-	-	Y	Y
TAM4A0A36S31	Y	Y	Y	Y	Y	Y	-	-	Y	Y
TAM4A0B42S31	Y	Y	Y	Y	Y	Y	Y	-	Y	Y
TAM4A0C48S41	Y	Y	Y	Y	Y	Y	Y	Y	Y	Y
TAM4A0C60S51	Y	Y	Y	Y	Y	Y	Y	Y	Y	Y

BK = Contains circuit breakers
LG = Contains lug connections

AIR HANDLER	HEATER MODEL NUMBER BAYEC-
Model Number	AA10LG1BA 9.60 Kw LG
GAF2A0A18S11	Y
GAF2A0A24S21	Y
GAF2A0A30S21	Y
GAF2A0A36M31	Y
GAF2A0A36S31	Y
GAF2A0A36S3A	Y

Air Handlers

TEM Single Phase Split System Air Handlers, 1½-5 Tons

TEM8 R-410A Communicating or 24 V Variable Speed Air Handler

Part #	Model #	Tons	Nom Cool BTUH	Electrical	Line Set Liq, Suc	Dimensions H x W x D	Ship Weight
190629	TEM8A0B24V21DA	2.0	24,000	208/230-1-60	3/8", 3/4"	46.75" x 18.5" x 21.13"	126 lbs
190630	TEM8A0B30V31DA	2.5	30,000	208/230-1-60	3/8", 3/4"	46.75" x 18.5" x 21.13"	126 lbs
190631	TEM8A0C36V31DA	3.0	36,000	208/230-1-60	3/8", 7/8"	51.27" x 23.5" x 21.13"	155 lbs
190632	TEM8A0C42V41DA	3.5	42,000	208/230-1-60	3/8", 7/8"	51.27" x 23.5" x 21.13"	155 lbs
190633	TEM8A0C48V41DA	4.0	48,000	208/230-1-60	3/8", 7/8"	55.75" x 23.5" x 21.13"	185 lbs
190634	TEM8A0D48V41DA	4.0	48,000	208/230-1-60	3/8", 7/8"	53.87" x 26.5" x 21.13"	181 lbs
190635	TEM8A0C60V51DA	5.0	60,000	208/230-1-60	3/8", 7/8"	55.75" x 23.5" x 21.13"	185 lbs
190636	TEM8A0D60V51DA	5.0	60,000	208/230-1-60	3/8", 7/8"	53.87" x 26.5" x 21.13"	181 lbs

TEM6 R-410A Convertible Variable Speed Air Handler

Part #	Model #	Tons	Nom Cool BTUH	Electrical	Line Set Liq, Suc	Dimensions H x W x D	Ship Weight
147369	TEM6A0B24H21SA	2.0	24,000	208/230-1-60	3/8", 3/4"	46.75" x 18.5" x 21.13"	126 lbs
147370	TEM6A0B30H21SA	2.5	30,000	208/230-1-60	3/8", 3/4"	46.75" x 18.5" x 21.13"	126 lbs
147371	TEM6A0C36H31SA	3.0	36,000	208/230-1-60	3/8", 7/8"	51.27" x 23.5" x 21.13"	155 lbs
147372	TEM6A0C42H41SA	3.5	42,000	208/230-1-60	3/8", 7/8"	51.27" x 23.5" x 21.13"	155 lbs
147373	TEM6A0D48H41SA	4.0	48,000	208/230-1-60	3/8", 7/8"	53.87" x 26.5" x 21.13"	181 lbs
147375	TEM6A0D60H51SA	5.0	60,000	208/230-1-60	3/8", 7/8"	53.87" x 26.5" x 21.13"	181 lbs

TEM4 R-410A Convertible Air Handler

Part #	Model #	Tons	Nom Cool BTUH	Electrical	Line Set Liq, Suc	Dimensions H x W x D	Ship Weight
142763	TEM4A0B18S21SA	1.5	18,000	208/230-1-60	3/8", 3/4"	45.02" x 18.5" x 21.13"	116 lbs
142764	TEM4A0B24S21SA	2.0	24,000	208/230-1-60	3/8", 3/4"	45.02" x 18.5" x 21.13"	116 lbs
142765	TEM4A0B30S31SA	2.5	30,000	208/230-1-60	3/8", 3/4"	45.02" x 18.5" x 21.13"	116 lbs
142766	TEM4A0C36S41SA	3.0	36,000	208/230-1-60	3/8", 7/8"	51.27" x 23.5" x 21.13"	145 lbs
142767	TEM4A0C42S41SA	3.5	42,000	208/230-1-60	3/8", 7/8"	51.27" x 23.5" x 21.13"	145 lbs
142768	TEM4A0C48S41SA	4.0	48,000	208/230-1-60	3/8", 7/8"	51.27" x 23.5" x 21.13"	145 lbs
142769	TEM4A0C60S51SA	5.0	60,000	208/230-1-60	3/8", 7/8"	51.27" x 23.5" x 21.13"	145 lbs

Air Handlers

TEM Air Handler Features and Options



TEM8/6/4/3

TEM8/6/4/3

Features	TEM8 2-5 Tons	TEM6 2-5 Tons	TEM4 1½-5	TEM3 1½-5
Meets requirements for 2% or less air leakage	✓	✓	✓	✓
AccuLink™ / ComfortLink™ II or 24V operation	✓	-	-	-
Direct drive, variable speed ECM blower motor - Constant airflow ECM (electronically commutated motor)	✓	✓	-	-
Direct drive, multi speed ECM blower motor - Constant torque ECM	-	-	3½-5	5
PSC Motor	-	-	1½-3	1½-4
Multi-Position Up/Down Flow*, Horizontal Left /Right	✓	✓	✓	✓
ALL Aluminum Coil with Enhanced Patented Coil Fin	✓	✓	✓	✓
R-410A Thermal Expansion Valve	✓	✓	✓	✓
Low Voltage Pigtail Connections	✓	✓	✓	✓
Fused 24V Power	✓	✓	✓	✓
Comfort R Mode	✓	✓	-	-
Built in fan delay modes	✓	✓	-	-
Maximum Width 26.5"	✓	✓	-	-
Maximum Width 23.5"	-	-	✓	✓
Compact 22" depth	✓	✓	✓	✓
3-year base limited and 10-year registered limited warranty	✓	✓	✓	✓
Warranty terms require registration within 60 days of installation; Extended warranties available.	✓	✓	✓	✓

Options

Part #	Model Number	Description	Matches Cabinet Size	TEM8 2-5 Tons	TEM6 2-5 Tons	TEM4 1½-5	TEM3 1½-5
171322	BAYSPEKT201A	Single Point Power Entry Kit		✓	✓	✓	✓
11062	TAYBASE260 (TAYBASE102)	Air Handler Downflow Sub-Bases	26.5"	✓	✓	-	-
126977	BAYTEMDFKT1A ¹	Downflow Condensate Management Kit	23.5"	-	-	✓	✓
163250	BAYSF1185AAA	Slim Fit Filter Box Kit	18.5"	✓	✓	✓	✓
163251	BAYSF1235AAA	Slim Fit Filter Box Kit	23.5"	✓	✓	✓	✓
163252	BAYSF1265AAA	Slim Fit Filter Box Kit	26.5"	✓	✓	-	-
163256	FLRSF1185	1" Slim Fit Replacement Filter, 17.75"x19.75", Qty 12	18.5"	✓	✓	✓	✓
163257	FLRSF1235	1" Slim Fit Replacement Filter, 22.75"x19.75", Qty 12	23.5"	✓	✓	✓	✓
163258	FLRSF1265	1" Slim Fit Replacement Filter, 25.75"x19.75", Qty 12	26.5"	✓	✓	-	-
190710	BAY6TXV2442A	R-22 TXV conversion kit		2-3½	2-3½	-	-
190711	BAY6TXV4860A	R-22 TXV conversion kit		4-5 ²	4-5 ²	-	-
129343	BAYATXV1836B	R-22 TXV conversion kit		-	-	1½-2½	1½-3
147062	BAYATXV4248B	R-22 TXV conversion kit		-	-	3-4	3½-4
134093	BAYATXV6161B	R-22 TXV conversion kit		4-5 ³	4-5 ³	5	5

1. Downflow condensate management kit is required for 5 Ton downflow models.

2. TEM6A0D48, TEM6A0D60, TEM8A0D48, TEM8A0D60

3. TEM6A0C48, TEM6A0C60, TEM8A0C48, TEM8A0C60



Heaters for TEM Split System Air Handlers

Heaters for TEM Air Handlers

BAYHTR15 - Heater, Standard, for TEM Air Handlers

Part #	Model Number	Capacity @ 240 V		Capacity @ 208 V		Rated Voltage	Control Stages	# of Heater Racks	# of Circuits	Heater Amps per Circuit		Contains Circuit Breakers
		kW	BTUH	kW	BTUH					208 V	240 V	
125517	BAYHTR1505BRKC	4.80	16400	3.60	12300	208/240/1/60	1	1	1	17.3	20.0	Yes
163845	BAYHTR1508BRKC	7.68	26200	5.76	19700	208/240/1/60	1	1	1	27.7	32.0	Yes
125518	BAYHTR1510BRKC	9.60	32800	7.20	24600	208/240/1/60	1	2	1	34.6	40.0	Yes
125519	BAYHTR1515BRKB	14.4	49200	10.8	36900	208/240/1/60	2	3	2	51.9	60.0	Yes
190708	BAYHTR1516BRKB	14.4	49200	10.8	36900	208/240/1/60	2	3	2	51.9	60.0	Yes
134094	BAYHTR1519BRKB	19.2	65500	14.4	49200	208/240/1/60	2	4	2	69.2	80.0	Yes
134096	BAYHTR1520BRKB	19.2	65500	14.4	49200	208/240/1/60	2	4	2	69.2	80.0	Yes
195582	BAYHTR1521BRKB	19.2	65500	14.4	49200	208/240/1/60	2	4	2	69.2	80.0	Yes
190709	BAYHTR1522BRKA	19.2	65500	14.4	49200	208/240/1/60	2	4	2	69.2	80.0	Yes
192846	BAYHTR1525BRKA	24.0	81900	18.0	61600	208/240/1/60	2	4	2	86.4	100.0	Yes

BRK = Contains circuit breakers
PDC = Pull disconnects
LUG = Lug connections

Equipment

Heaters for TEM Split System Air Handlers

Air Handler/Heater Matrix

TEM8 and TEM6 Air Handler and Heater Matches

AIR HANDLER	HEATER MODEL NUMBER								
	BAYHTR1504BRK* BAYHTR1504LUG* 3.84 Kw	BAYHTR1505BRK* BAYHTR1505LUG* 4.80 Kw	BAYHTR1508BRK* BAYHTR1508LUG* 7.68 Kw	BAYHTR1510BRK* BAYHTR1510LUG* 9.60 Kw	BAYHTR1516BRK* 14.40 Kw	BAYHTR1522BRK* 19.20 Kw	BAYHTR1525BRK* 24.00 Kw	BAYHTR3510LUG* 9.60 Kw	BAYHTR3515LUG* 14.40 Kw
TEM8A0B24V21D* TEM8A0B30V31D* TEM6A0B24H21S* TEM6A0B30H21S*	Y	Y	Y	Y	Y	-	-	Y	Y
TEM8A0C36V31D* TEM8A0C42V41D* TEM6A0C36H31S* TEM6A0C42H41S*	Y	Y	Y	Y	Y	Y	-	Y	Y
TEM8A0C48V41D* TEM8A0C60V51D* TEM6A0C48H41S* TEM6A0C60H51S*	Y	Y	Y	Y	Y	Y	Y	Y	Y
TEM8A0D48V41D* TEM8A0D60V51D* TEM6A0D48H41S* TEM6A0D60H51S*	Y	Y	Y	Y	Y	Y	Y	Y	Y

*Followed by two digits

TEM3 and TEM4 Air Handler and Heater Matches

AIR HANDLER	HEATER MODEL NUMBER					
	BAYHTR1504BRK* BAYHTR1504PDC* BAYHTR1504LUG* 3.84 Kw BK BAYHTR1505BRK* BAYHTR1505PDC* BAYHTR1505LUG* 4.80 Kw BK	BAYHTR1508BRK* BAYHTR1508PDC* BAYHTR1508LUG* 7.68 Kw BK BAYHTR1510BRK* BAYHTR1510PDC* BAYHTR1510LUG* BAYHTR3510LUGB 9.60 Kw BK	BAYHTR1515BRK* BAYHTR-3515LUGB 14.40 Kw BK	BAYHTR1519BRK* 19.20 Kw BK	BAYHTR-1520BRK* 19.20 Kw BK	BAYHTR1521BRK* 19.20 Kw BK
TEM3A0B18S21S* TEM4A0B18S21S* TEM3A0B24S21S* TEM4A0B24S21S*	Y	Y	-	-	-	-
TEM3A0B30S31S* TEM4A0B30S31S* TEM3A0B36S31S*	Y	Y	Y	Y	-	-
TEM4A0C36S41S* TEM3A0C42S41S* TEM4A0C42S41S*	Y	Y	Y	-	Y	-
TEM3A0C48S41S*	Y	Y	Y	-	Y	-
TEM4A0C48S41S*	Y	Y	Y	-	-	Y
TEM3A0C60S51S* TEM4A0C60S51S*	Y	Y	Y	-	Y	-

*Followed by two digits

Models and Specifications are Subject to Change Without Notice

Air Handlers and Heaters

TMM Wall, Stud, or Over the Water Heater Mount Air Handlers Single Phase, 1½-3 Tons TMM5 R-410A ECM Motor Air Handler

Part #	Model #	Tons	Nom Cool BTUH	Electrical	Line Set Liq, Suc	Dimensions H x W x D	Ship Weight
163926	TMM5A0B24M21SA	2.0	24,000	208/230-1-60	3/8", 3/4"	39.5" x 22.0" x 19.0"	115 lbs
165135	TMM5A0B30M21SA	2.5	30,000	208/230-1-60	3/8", 3/4"	39.5" x 22.0" x 19.0"	117 lbs
193830	TMM5A0B36M31SA	3.0	36,000	208/230-1-60	3/8", 3/4"	51.27" x 23.5" x 21.13"	117 lbs

TMM4 R-410A ECM Motor Air Handler

Part #	Model #	Tons	Nom Cool BTUH	Electrical	Line Set Liq, Suc	Dimensions H x W x D	Ship Weight
178649	TMM4A0A18S21SA	1.5	18,000	208/230-1-60	3/8", 3/4"	36.5" x 20.5" x 15.0"	99 lbs
178650	TMM4A0A24S21SA	2.0	24,000	208/230-1-60	3/8", 3/4"	36.5" x 20.5" x 15.0"	99 lbs
178651	TMM4A0B30S21SA	2.5	30,000	208/230-1-60	3/8", 3/4"	39.5" x 22.0" x 19.0"	121 lbs



Features	TMM5 2-3	TMM4 1½-3
Meets requirements for 2% or less air leakage	✓	✓
Direct drive, variable speed ECM blower motor - constant torque ECM (electronically commutated motor) with fan-off time-delay programming	✓	-
PSC Motor	-	✓
Upflow Only	✓	✓
High Efficiency Copper/Aluminum Coil	✓	✓
R-410A Thermal Expansion Valve	✓	-
Low Voltage Pigtail Connections	✓	✓
Fused 24V Power	✓	✓
Optional R-22 and R-410A TXV kits (sold separately)	✓	✓
3-year base limited and 10-year registered limited warranty	✓	✓
Warranty terms require registration within 60 days of installation; Extended warranties available.	✓	✓

Options

Part #	Model Number	Description	TEM4 2-3	TEM3 1½-3
180427	4AYTXVH3G2436A	R-410A TXV kit 1-1/2 to 3 ton	-	✓
180430	2AYTXVH3G2436A	R-22 TXV conversion kit 1-1/2 to 3 ton	✓	✓
179296	BAYFRTLLOUPNL20	Front louver panel 20.5" width	-	✓
179298	BAYFRTLLOUPNL22	Front louver panel 22.0" width	✓	✓

Heaters for TMM Split System Air Handlers

Part #	Heater Model Number	Capacity @ 240 V		Capacity @ 208 V		Rated Voltage	Control Stages	# of Heater Racks	# of Cir- cuits	Heater Amps per Circuit		Contains Circuit Breakers
		kW	BTUH	kW	BTUH					208 V	240 V	
178653	BAYHTRM505BRK	5.0	17100	3.8	12800	208/240/1/60	1	1	1	18.0	20.8	Yes
172556	BAYHTRM508BRK	7.5	25600	5.6	19200	208/240/1/60	1	1	1	27.1	31.2	Yes
163946	BAYHTRM510BRK	10.0	34100	7.5	25600	208/240/1/60	1	2	1	36.1	41.7	Yes

Coils

Cased Comfort™ High Efficiency Split System Coils

4TXC-DS Cased Aluminum Convertible (Upflow/Downflow/Horizontal Left or Right) Coils

Part #	Model #	Refrigerant Type	Tons	Nom Cap Cooling BTUH	Dimensions H x W x D	Line Size Liq, Suc	Ship Weight
174881	4TXCA002DS3HCA	R-410A	2.0	24,000	17.5" x 14.5" x 21.5"	3/8", 3/4"	39 lbs
174882	4TXCB003DS3HCA	R-410A	2.5	30,000	17.5" x 17.5" x 21.5"	3/8", 3/4"	39 lbs
174883	4TXCB004DS3HCA	R-410A	3.0	36,000	22.5" x 17.5" x 21.5"	3/8", 7/8"	42 lbs
174884	4TXCC005DS3HCA	R-410A	3.0	36,000	22.5" x 21" x 21.5"	3/8", 7/8"	47 lbs
174885	4TXCB006DS3HCA	R-410A	4.0	48,000	26.9" x 17.5" x 21.5"	3/8", 7/8"	54 lbs
174886	4TXCC007DS3HCA	R-410A	4.0	48,000	26.9" x 21" x 21.5"	3/8", 7/8"	56 lbs
174887	4TXCD008DS3HCA	R-410A	4.0	48,000	26.9" x 24.5" x 21.5"	3/8", 7/8"	61 lbs
174888	4TXCC009DS3HCA	R-410A	5.0	60,000	30.7" x 21" x 21.5"	3/8", 7/8"	64 lbs
174889	4TXCD010DS3HCA	R-410A	5.0	60,000	30.7" x 24.5" x 21.5"	3/8", 7/8"	61 lbs

4PXC-U Cased Aluminum Upflow Convertible (Horizontal Left or Horizontal Right with Kit) Coils

Part #	Model #	Refrigerant Type	Tons	Nom Cap Cooling BTUH	Dimensions H x W x D	Line Size Liq, Suc	Ship Weight
174890	4PXCAU24BS3HAA	R-410A	2.0	24,000	17.5" x 14.5" x 21.5"	3/8", 3/4"	39 lbs
174891	4PXCBU24BS3HAA	R-410A	2.0	24,000	17.5" x 17.5" x 21.5"	3/8", 3/4"	42 lbs
174892	4PXCBU30BS3HAA	R-410A	2.5	30,000	17.5" x 17.5" x 21.5"	3/8", 3/4"	47 lbs
174893	4PXCCU30BS3HAA	R-410A	2.5	30,000	17.5" x 21" x 21.5"	3/8", 3/4"	49 lbs
174894	4PXCBU36BS3HAA	R-410A	3.0	36,000	22.5" x 17.5" x 21.5"	3/8", 7/8"	54 lbs
174895	4PXCCU36BS3HAA	R-410A	3.0	36,000	22.5" x 21" x 21.5"	3/8", 7/8"	56 lbs
174896	4PXCBU42BS3HAA	R-410A	3.5	42,000	26.9" x 17.5" x 21.5"	3/8", 7/8"	61 lbs
174897	4PXCCU42BS3HAA	R-410A	3.5	42,000	26.9" x 21" x 21.5"	3/8", 7/8"	64 lbs
174898	4PXCBU48BS3HAA	R-410A	4.0	48,000	26.9" x 17.5" x 21.5"	3/8", 7/8"	61 lbs
174899	4PXCCU48BS3HAA	R-410A	4.0	48,000	26.9" x 21" x 21.5"	3/8", 7/8"	64 lbs
174900	4PXCUD48BS3HAA	R-410A	4.0	48,000	26.9" x 24.5" x 21.5"	3/8", 7/8"	68 lbs
174901	4PXCCU60BS3HAA	R-410A	5.0	60,000	30.7" x 21" x 21.5"	3/8", 7/8"	73 lbs
174902	4PXCUD60BS3HAA	R-410A	5.0	60,000	30.7" x 24.5" x 21.5"	3/8", 7/8"	77 lbs

4PXC-D Cased Aluminum Downflow Convertible (Horizontal Right with Kit) Coils

Part #	Model #	Refrigerant Type	Tons	Nom Cap Cooling BTUH	Dimensions H x W x D	Line Size Liq, Suc	Ship Weight
174903	4PXCAD24BS3HDA	R-410A	2.0	24,000	17.5" x 14.5" x 21.5"	3/8", 3/4"	39 lbs
174904	4PXCBD24BS3HDA	R-410A	2.0	24,000	17.5" x 17.5" x 21.5"	3/8", 3/4"	42 lbs
174905	4PXCBD30BS3HDA	R-410A	2.5	30,000	17.5" x 17.5" x 21.5"	3/8", 3/4"	47 lbs
174906	4PXCCD30BS3HDA	R-410A	2.5	30,000	17.5" x 21" x 21.5"	3/8", 3/4"	49 lbs
174907	4PXCBD36BS3HDA	R-410A	3.0	36,000	22.5" x 17.5" x 21.5"	3/8", 7/8"	54 lbs
174908	4PXCCD36BS3HDA	R-410A	3.0	36,000	22.5" x 21" x 21.5"	3/8", 7/8"	56 lbs
174909	4PXCBD42BS3HDA	R-410A	3.5	42,000	26.9" x 17.5" x 21.5"	3/8", 7/8"	61 lbs
174910	4PXCCD42BS3HDA	R-410A	3.5	42,000	26.9" x 21" x 21.5"	3/8", 7/8"	64 lbs
174911	4PXCBD48BS3HDA	R-410A	4.0	48,000	26.9" x 17.5" x 21.5"	3/8", 7/8"	61 lbs
174912	4PXCCD48BS3HDA	R-410A	4.0	48,000	26.9" x 21" x 21.5"	3/8", 7/8"	64 lbs
174913	4PXCDD48BS3HDA	R-410A	4.0	48,000	26.9" x 24.5" x 21.5"	3/8", 7/8"	68 lbs
174914	4PXCCD60BS3HDA	R-410A	5.0	60,000	30.7" x 21" x 21.5"	3/8", 7/8"	73 lbs
174915	4PXCDD60BS3HDA	R-410A	5.0	60,000	30.7" x 24.5" x 21.5"	3/8", 7/8"	77 lbs

Models and Specifications are Subject to Change Without Notice

Coils



Cased



Uncased

Kits for 4PXC Coils

Part #	Model #	Use With
Horizontal Conversion Kits		
147079	BAYCONV18A	4PXCAU24, 4PXCBU24, 4PXCBU30, 4PXCCU30, 4PXCAD24, 4PXCBD24, 4PXCBD30, 4PXCCD30
147080	BAYCONV23A	4PXCBU36, 4PXCCU36, 4PXCBD36, 4PXCCD36
147082	BAYCONV27A	4PXCBU42, 4PXCCU42, 4PXCBU48, 4PXCCU48, 4PXC4U48, 4PXCBD42, 4PXCCD42, 4PXCBD48, 4PXCCD48, 4PXCCD48
147083	BAYCONV30A	4PXCCU60, 4PXC4U60, 4PXCCD60, 4PXCCD60

R-22 TXV Conversion TXV Kits for 4PXC, 4PXA, and 4TXC-D Coils

Part #	Model #	Coil Models Where Used	
180825	2AYTXVH3H1836A	4PX: 24 - 36	4TXC: 002DS - 005DS
181702	2AYTXVH3H4248A	4PX: 42 - 48	4TXC: 006DS - 008DS
182079	2AYTXVH3H6060A	4PX: 60	4TXC: 009DS - 010DS

13 SEER Split System - Uncased Coil Enclosures

Part #	Model #	Coils	Used with Furnaces Flush on Both Sides	Dimensions H x W x D	Ship Weight
60122	BAYCLE17A1722A	4TXAB025AS, 4PXABU24BS 4TXAB031AS, 4PXABU30BS 4TXAB036AS, 4PXABU36BS 4TXAB025BC, 4PXABU42BS 4TXAB031BC, 4PXABU48BS 4TXAB032BC 4TXAB036BC 4TXAB042BC 4TXAB048BC	17½" Wide Furnace	22⅝" x 17½" x 21½"	14 lbs
73529	BAYCLE21A2130A	4TXAC037AS, 4PXACU30BS 4TXAC054AS, 4PXACU36BS 4TXAC037BC, 4PXACU42BS 4TXAC043BC, 4PXACU48BS 4TXAC044BC, 4PXACU60BS 4TXAC049BC 4TXAC060BC	21" Wide Furnace	30" x 21" x 21½"	18 lbs

Coils

Uncased Comfort™ Split System Coils

4PXA-U Uncased Aluminum Upflow Coils

Part #	Model #	Refrigerant Type	Tons	Nom Cap Cooling BTUH	Dimensions H x W x D	Line Size Liq, Suc	Ship Weight
174916	4PXA AU24BS3HAA	R-410A	2.0	24,000	14.7" x 13.3" x 21.1"	3/8", 3/4"	24 lbs
174917	4PXABU24BS3HAA	R-410A	2.0	24,000	14.5" x 16.3" x 21.1"	3/8", 3/4"	24 lbs
174918	4PXABU30BS3HAA	R-410A	2.5	30,000	15.8" x 16.3" x 21.1"	3/8", 3/4"	32 lbs
174919	4PXACU30BS3HAA	R-410A	2.5	30,000	15.8" x 19.8" x 21.1"	3/8", 3/4"	32 lbs
174920	4PXABU36BS3HAA	R-410A	3.0	36,000	21.2" x 16.3" x 21.1"	3/8", 7/8"	33 lbs
174921	4PXACU36BS3HAA	R-410A	3.0	36,000	20.8" x 19.8" x 21.1"	3/8", 7/8"	32 lbs
174922	4PXABU42BS3HAA	R-410A	3.5	42,000	23.8" x 16.3" x 21.1"	3/8", 7/8"	33 lbs
174923	4PXACU42BS3HAA	R-410A	3.5	42,000	23.7" x 19.8" x 21.1"	3/8", 7/8"	38 lbs
174924	4PXABU48BS3HAA	R-410A	4.0	48,000	25.3" x 16.3" x 21.1"	3/8", 7/8"	36 lbs
174925	4PXACU48BS3HAA	R-410A	4.0	48,000	24.9" x 19.8" x 21.1"	3/8", 7/8"	38 lbs
174926	4PXADU48BS3HAA	R-410A	4.0	48,000	24.5" x 23.3" x 21.1"	3/8", 7/8"	39 lbs
174927	4PXACU60BS3HAA	R-410A	5.0	60,000	29.2" x 19.8" x 21.1"	3/8", 7/8"	44 lbs
174928	4PXADU60BS3HAA	R-410A	5.0	60,000	28.5" x 23.3" x 21.1"	3/8", 7/8"	45 lbs

Cased Split System Coils

4TXF Cased Aluminum Horizontal Flat Coils

Part #	Model #	Refrigerant Type	Tons	Nom Cap Cooling BTUH	Dimensions H x W x D	Line Size Liq, Suc	Ship Weight
97196	4TXFH024CZ3HHB	R-410A	2.0	24,000	22.7" x 10.2" x 37.5"	3/8", 5/8"	48 lbs
97363	4TXFH033CC3HHB	R-410A	2.5	24,000	22.7" x 10.2" x 28.2"	5/16", 3/4"	49 lbs
140265	4TXFH036CZ3HHB	R-410A	3.0	36,000	22.7" x 10.2" x 37.5"	3/8", 3/4"	53 lbs
97365	4TXFH041CC3HHB	R-410A	3.5	44,000	22.7" x 10.2" x 37.5"	3/8", 3/4"	57 lbs
81714	4TXFH054CC3HHB	R-410A	4.0	58,000	22.7" x 10.2" x 37.5"	3/8", 7/8"	55 lbs
193456	4TXFH064AZ3HHA	R-410A	5.0	61,000	28.6" x 10.2" x 37.5"	3/8", 7/8"	63 lbs

Features	4TXC-DS	4PXC-U	4PXC-D	4PXA-U	4TXF
All aluminum coil	✓	✓	✓	✓	✓
Enhanced Fin Surface	✓	✓	✓	✓	-
100% foil lined insulation	✓	✓	✓	-	✓
4 way application - Upflow/Downflow/Horizontal (left/right)	✓	-	-	-	-
Upflow application; convertible to Horizontal Left application with kit	-	✓	-	-	-
Upflow only application	-	-	-	✓	-
Downflow application; convertible to Horizontal Right application with kit	-	✓	✓	-	-
Horizontal application with Bi-Direction airflow	-	-	-	-	✓
Double sloped non-corrosive drain pan - UL rated 400°F	✓	✓	✓	✓	-
Sloped non-corrosive drain pan	-	-	-	-	✓
Optimized for high efficiency with staged systems	✓	✓	✓	-	-
5-year base limited warranty on coil and all other functional parts (Residential Use)	✓	✓	✓	✓	✓
10-year registered limited warranty on coil and all other functional parts (Residential Use)	✓	✓	✓	✓	✓
Warranty terms require registration within 60 days of installation; Extended warranties available.	✓	✓	✓	✓	✓

Models and Specifications are Subject to Change Without Notice

Coils

Cased Aluminum Coils

4GXC Cased Aluminum Single Stage Upflow/Downflow Coils

Part #	Model #	Refrigerant Type	Tons	Nom Cap Cooling Range BTUH	Dimensions H x W x D	Line Size Liq, Suc	Ship Weight
174659	4GXCA001AC6HUA	R-410A	1.5-2.5	18,000-30,000	20" x 14.5" x 21"	3/8", 3/4"	47 lbs
174663	4GXCB002AC6HUA	R-410A	1.5-2.5	18,000-30,000	20" x 17.5" x 21"	3/8", 3/4"	50 lbs
174662	4GXCA003AC6HUA	R-410A	2.0-3.0	24,000-36,000	20" x 14.5" x 21"	3/8", 3/4"	47 lbs
174664	4GXCB004AC6HUA	R-410A	2.0-3.0	24,000-36,000	20" x 17.5" x 21"	3/8", 3/4"	50 lbs
174666	4GXCC005AC6HUA	R-410A	2.5-3.0	30,000-36,000	20" x 21" x 21"	3/8", 7/8"	55 lbs
174665	4GXCB006AC6HUA	R-410A	3.0-3.5	36,000-48,000	26" x 17.5" x 21"	3/8", 7/8"	61 lbs
174667	4GXCC007AC6HUA	R-410A	3.5-4.0	36,000-48,000	26" x 21" x 21"	3/8", 7/8"	65 lbs
174672	4GXCD008AC6HUA	R-410A	3.5-4.0	42,000-48,000	26" x 24.5" x 21"	3/8", 7/8"	68 lbs
174668	4GXCC009AC6HUA	R-410A	3.5-5.0	42,000-60,000	30" x 21" x 21"	3/8", 7/8"	85 lbs
174674	4GXCD010AC6HUA	R-410A	4.0-5.0	48,000-60,000	30" x 24.5" x 21"	3/8", 7/8"	89 lbs

2: Enhanced models for use in heating.

4MXC Cased Aluminum Single Stage Upflow/Downflow/Horizontal Coils

Part #	Model #	Refrigerant Type	Tons	Nom Cap Cooling Range BTUH	Dimensions H x W x D	Line Size Liq, Suc	Ship Weight
191623	4MXCA001AC6HCA	R-410A	1.5-3.0	18,000-30,000	20" x 14.5" x 21"	3/8", 3/4"	51 lbs
191624	4MXCB002AC6HCA	R-410A	1.5-3.0	18,000-30,000	20" x 17.5" x 21"	3/8", 3/4"	55 lbs
191625	4MXCA003AC6HCA	R-410A	2.0-3.0	24,000-36,000	20" x 14.5" x 21"	3/8", 3/4"	51 lbs
191626	4MXCB004AC6HCA	R-410A	2.0-3.0	24,000-36,000	20" x 17.5" x 21"	3/8", 3/4"	55 lbs
191627	4MXCC005AC6HCA	R-410A	2.5-3.0	30,000-36,000	20" x 21" x 21"	3/8", 3/4"	59 lbs
191628	4MXCB006AC6HCA	R-410A	3.0-4.0	36,000-48,000	26" x 17.5" x 21"	3/8", 7/8"	66 lbs
191629	4MXCC007AC6HCA	R-410A	3.0-4.0	36,000-48,000	26" x 21" x 21"	3/8", 7/8"	70 lbs
191630	4MXCD008AC6HCA	R-410A	3.5-4.0	42,000-48,000	26" x 24.5" x 21"	3/8", 7/8"	74 lbs
191631	4MXCC009AC6HCA	R-410A	3.5-5.0	42,000-60,000	30" x 21" x 21"	3/8", 7/8"	91 lbs
191632	4MXCD010AC6HCA	R-410A	4.0-5.0	48,000-60,000	30" x 24.5" x 21"	3/8", 7/8"	95 lbs

2: Enhanced models for use in heating.

Features	4GXC	4MXC
All aluminum coil	✓	✓
100% foil lined insulation	✓	✓
Upflow/Downflow application	✓	-
4 way application - Upflow/Downflow/Horizontal (left/right)	-	✓
Horizontal application with Bi-Direction airflow	-	✓
Sloped non-corrosive drain pan - UL rated 275°F max	✓	✓
Dual side condensate drain options	✓	✓
Coils achieve 13-16 SEER with single stage outdoor units	✓	✓
3-year base limited warranty on coil and all other functional parts (Residential Use)	✓	✓
10-year registered limited warranty on coil and all other functional parts (Residential Use)	✓	✓
Warranty terms require registration within 60 days of installation; Extended warranties available.	✓	✓

TXV Kits for 4GXC and 4MXC Coils R-410A TXV Kit

Part #	Model #	Tons
180427	4AYTXVH3G2436A	1.5-3.0
180428	4AYTXVH3G4848A	3.5-4.0
180429	4AYTXVH3G6000A	5.0

TXV Kits for 4GXC and 4MXC Coils R-22 TXV Kit

Part #	Model #	Tons
180430	2AYTXVH3G2436A	1.5-3.0
180431	2AYTXVH3G4848A	3.5-4.0
180432	2AYTXVH3G6000A	5.0

Commercial Package Units

Silver 14 Convertible Single-Phase Packaged Air Conditioners with Gas Heat

- SEER up to 14
- Duration™ high efficiency compressor with internal overload protection
- Composite Vortica® blower
- Direct drive, multi-speed ECM blower motor (high efficiency)
- All aluminum Spine Fin™ outdoor coil
- All steel louvers
- Stainless steel burners and heat exchanger
- Factory installed liquid line drier
- Rugged steel basepan features deep drawn duct connections
- Steeply sloped composite drain pan
- Non-bleed expansion valves
- Direct drive 2 and 3 speed blower motors
- Pressure taps
- Certified to ANSI 221.47/CSA 2.3
- 20-Year registered limited warranty on heat exchanger (residential use)
- 10-Year registered limited warranty on compressor, coils, and functional parts (residential use)
- Warranty terms require registration within 60 days of installation
- Extended warranties available



Equipment

Up to 14 SEER 81% AFUE R-410A Convertible Packaged Air Conditioner with Gas Heat

Part #	Model #	Tons	Cooling Capacity BTUH	Heating Capacity Input/Output	Electrical	Dimensions H x W x D	Ship Weight
159555	4YCC4024A1060A	2.0	24,600	60,000/49,000	208/230-1-60	36" x 42" x 49"	481 lbs
159556	4YCC4030A1070A	2.5	28,200	70,000/57,000	208/230-1-60	36" x 42" x 49"	481 lbs
159557	4YCC4036A1090A	3.0	37,000	90,000/73,000	208/230-1-60	38" x 42" x 49"	493 lbs
159252	4YCC4042A1090A	3.5	40,500	90,000/73,000	208/230-1-60	36" x 45" x 59"	653 lbs
159559	4YCC4048A1090A	4.0	46,500	90,000/73,000	208/230-1-60	40" x 45" x 59"	653 lbs
162151	4YCC4060A1115A	5.0	58,000	115,000/93,000	208/230-1-60	40" x 45" x 59"	684 lbs

4YCC Series Accessories

Part #	Model #	Description	Use With	Ship Weight
46510	BAYCURB050A	Flat Roof Full Perimeter Curb	4YCC4 024-036	74 lbs
46511	BAYCURB051A	Flat Roof Full Perimeter Curb	4YCC4 048-060	74 lbs
46512	BAYECON101A	Economizer Downflow with Barometric Relief ^{1, 2, 3, 5, 6}	4YCC4 024-036	50 lbs
46579	BAYECON102A	Economizer Downflow with Barometric Relief ^{1, 2, 3, 5, 6}	4YCC4 048-060	65 lbs
46513	BAYECON200A	Economizer Horizontal ^{1, 2, 3, 4}	4YCC4 024-036	85 lbs
99989	BAYECON201A	Economizer Horizontal ^{1, 2, 3, 4}	4YCC4 048-060	85 lbs
62834	BAYFLTR101C	1"-2" Filter Frame ¹ (Uses (1) 20x25 filter not included)	4YCC4 024-036	6 lbs
46526	BAYFLTR201C	1"-2" Filter Frame ¹ (Uses (1) 18x20 and (1) 18x18 filter not included)	4YCC4 048-060	6 lbs
5847	BAYENTH001A	Enthalpy Control Kit ²	4YCC4 024-036	2 lbs
46514	BAYOSAH001A	Manual Fresh Air Damper ¹	4YCC4 024-036	6 lbs
46582	BAYOSAH002A	Manual Fresh Air Damper ¹	4YCC4 048-060	8 lbs

¹ Must use filter frame when economizer/fresh air kit is used.

² Dry bulb control standard with economizer.

³ 2-Stage cooling control required when using economizer.

⁴ Does not contain barometric relief.

⁵ It is the designer/engineer's responsibility to review product specifications.

⁶ Temperature of mixed air entering the heat exchanger is monitored and fresh air intake may be reduced under certain conditions.

Commercial Package Units

Convertible Commercial Precedent 3-Phase Packaged Air Conditioners with Gas Heat

- Electromechanical controls
- Built scroll compressors on all 3 to 10 ton units except standard efficiency model (reciprocating)
- Colored and numbered wiring
- Provisions for through the base gas and condensate drain connections
- Liquid line refrigerant drier
- IAQ Sloped drain pans
- Low ambient to 40°F
- Includes 2" throwaway filters
- 5-Year limited warranty on compressor
- 5-Year limited warranty on heat exchanger
- 1-Year limited warranty on parts



80% AFUE R-410A Packaged Air Conditioner with Gas Heat

Part #	Model #	Tons	Nom Cool/Heat BTUH	Electrical	Dimensions H x W x D	Ship Weight
183732	YSC036G3EHA0000	3.0	37,150/96,000	208/230-3-60	41" x 44" x 69"	577 lbs
183734	YSC036G4EHA0000	3.0	37,150/96,000	460-3-60	41" x 44" x 69"	577 lbs
180478	YSC048G3EHA0000	4.0	49,450/96,000	208/230-3-60	41" x 44" x 69"	598 lbs
183733	YSC048G4EHA0000	4.0	49,450/96,000	460-3-60	41" x 44" x 69"	598 lbs
181326	YSC060G3EHA0000	5.0	62,270/104,000	208/230-3-60	41" x 44" x 69"	627 lbs
185187	YSC060G4EHA0000	5.0	62,270/104,000	460-3-60	41" x 44" x 69"	627 lbs
51960	YSC072F3EMA0000	6.0	75,000/97,200	208/230-3-60	41" x 53" x 89"	936 lbs
87190	YSC072F4EHA0000	6.0	75,000/121,500	460-3-60	41" x 53" x 89"	936 lbs
55363	YSC092F3EHA0000*	7.5	94,000/162,000	208/230-3-60	47" x 53" x 89"	1,059 lbs
55599	YSC092F4EHA0000*	7.5	94,000/162,000	460-3-60	47" x 53" x 89"	1,059 lbs
55335	YSC102F3EHA0000*	8.5	102,000/162,000	208/230-3-60	47" x 53" x 89"	1,096 lbs
73745	YSC120F3EMA0000*	10.0	118,000/162,000	208/230-3-60	47" x 53" x 89"	1,156 lbs
74315	YSC120F3EHA0000*	10.0	118,000/205,500	208/230-3-60	47" x 53" x 89"	1,156 lbs
74250	YSC120F4EMA0000*	10.0	118,000/162,000	460-3-60	47" x 53" x 89"	1,156 lbs
74207	YSC120F4EHA0000*	10.0	118,000/205,500	460-3-60	47" x 53" x 89"	1,156 lbs

*Dual compressor

YSC Series Accessories

Part #	Model #	Description	Use With
50305	BAYCURB042A	14" Knock Down Flat Roof Curb	YSC036-060E
50306	BAYCURB043A	14" Knock Down Flat Roof Curb	YSC072-120E/YHC048-060
31101	BAYDMPR053A/B	0-50% Manual Outside Air Damper	YSC036-060E
31696	BAYDMPR056A	0-50% Manual Outside Air Damper	YSC072-120/YHC048-060
131406	BAYECON086B	0-100% Dry Bulb Economizer less Barometric Relief	YSC036-060 (ELECTRO MECH)
131495	BAYECON088B	0-100% Dry Bulb Economizer less Barometric Relief	YSC072-120/YHC048-060 (ELECTRO MECH)
170871	BAYENTH300	Reference Enthalpy Kit	All Precedents
170872	BAYENTH301	Comparative Enthalpy Kit	All Precedents

Commercial Package Units

Commercial Voyager™ 3-Phase Packaged Air Conditioners with Gas Heat Up to 11 EER 81% AFUE R-410A Voyager™ Downflow Packaged Electric Air Conditioner with Gas High Heat

- **Downflow configuration**
- ReliaTel™ microprocessor controls
- Belt drive motors
- Single point power
- Single side service
- Operating charge of R-410A
- Drum and tube heat exchanger
- 12.5 Ton dimensions: 50-1/8"H x 106-11/16"W x 70-13/16"D
- 15.0 and 25.0 ton dimensions: 54"H x 121-11/16"W x 84-3/16"D
- Liquid line filter-drier
- Factory installed options include:
 - Complete Coat™ condenser coil
 - Multi-speed indoor fans
 - Stainless steel heat exchanger
- 10-Year warranty on optional stainless steel heat exchanger
- 5-Year limited warranty on compressor
- 5-Year limited warranty on heat exchanger (12.5 to 17.5 ton)
- 1-Year limited warranty on heat exchanger (20 and 25 ton)
- 1-Year limited warranty on parts



Part #	Model #	Tons	Nom Cool/Heat BTUH	Nom Cooling CFM	Electrical	MOD (Amps)	Ship Weight
191524	YSD150G3RHA0000	12.5	150,000/250,000	5,000 CFM	208/230-3-60	80A	1,781 lbs
192815	YSD150G4RHA0000	12.5	150,000/250,000	5,000 CFM	460-3-60	40A	1,781 lbs
192470	YSD180G3RHA0000	15.0	186,000/350,000	6,000 CFM	208/230-3-60	100A	2,281 lbs
193970	YSD180G4RHA0000	15.0	186,000/350,000	6,000 CFM	460-3-60	50A	2,281 lbs
193412	YSD210G3RHA0000	17.5	193,000/350,000	9,000 CFM	208/230-3-60	125A	2,292 lbs
193971	YSD210G4RHA0000	17.5	193,000/350,000	9,000 CFM	460-3-60	60A	2,292 lbs
193942	YSD240G3RHA0000	20.0	259,000/400,000	8,000 CFM	208/230-3-60	125A	2,353 lbs
193973	YSD240G4RHA0000	20.0	259,000/400,000	8,000 CFM	460-3-60	70A	2,353 lbs
193974	YSD300G3RHA0000	25.0	296,400/400,000	10,000 CFM	208/230-3-60	150A	2,337 lbs
192540	YSD300G4RHA0000	25.0	296,400/400,000	10,000 CFM	460-3-60	70A	2,337 lbs

YSD Series Accessories

Part #	Model #	Description	Use With
13195	BAYCURB026B	Flat Roof Curb Downflow	YSD150G
13274	BAYCURB027B	Flat Roof Curb Downflow	YSD180-YSD300G
6690	BAYDMPR029C	Manual Outside Air Damper	All Voyagers
38720	BAYDMPR058A	Motorized Outside Air Damper 0-50 %	YSD180-YSD300G
38115	BAYECON089A	Downflow Economizer with Barometric Relief	YSD150G
38116	BAYECON090A	Downflow Economizer with Barometric Relief	YSD150-300G
38119	BAYENTH007A	Reference Enthalpy Kit	All BAYECON089-092A
31714	BAYPWRX029A	Power Exhaust 230V	Voyager 12.5T to 25.0T Downflow Only
38752	BAYPWRX029A	Power Exhaust 460V	Voyager 12.5T to 25.0T Downflow Only

Models and Specifications are Subject to Change Without Notice

Commercial Package Units

Up to 11 EER 81% AFUE R-410A Voyager™ Horizontal 3-Phase Packaged Electric Air Conditioner with Gas Heat

- **Horizontal configuration**
- ReliaTel™ microprocessor controls
- Belt drive motors
- Single point power
- Single side service
- Operating charge of R-410A
- Drum and tube heat exchanger
- 12.5 Ton dimensions: 50-1/8"H x 106-11/16"W x 70-13/16"D
- 15.0 to 25.0 ton dimensions: 54"H x 121-11/16"W x 84-3/16"D
- Liquid line filter-drier
- Factory installed options include
 - Complete Coat™ condenser coil
 - Multi-speed indoor fans
 - Stainless steel heat exchanger
- 10-Year warranty on optional stainless steel heat exchanger
- 5-Year limited warranty on compressor
- 5-Year limited warranty on heat exchanger (15.0 ton)
- 1-Year limited warranty on heat exchanger (20.0 and 25.0 ton)
- 1-Year limited warranty on parts



Part #	Model #	Tons	Nom Cool/Heat BTUH	Nom Cooling CFM	Electrical	MOD (Amps)	Ship Weight
191935	YSH150G3RHA0000	12.5	150,000/250,000	5,000 CFM	208/230-3-60	80A	1,820 lbs
193759	YSH150G4RHA0000	12.5	150,000/250,000	5,000 CFM	460-3-60	40A	1,820 lbs
191703	YSH180G3RHA0000	15.0	186,000/350,000	6,000 CFM	208/230-3-60	100A	2,475 lbs
192334	YSH180G4RHA0000	15.0	186,000/350,000	6,000 CFM	460-3-60	50A	2,475 lbs
191367	YSH210G3RHA0000	17.5	193,000/350,000	9,000 CFM	208/230-3-60	125A	2,292 lbs
192491	YSH210G4RHA0000	17.5	193,000/350,000	9,000 CFM	460-3-60	60A	2,292 lbs
193975	YSH240G3RHA0000	20.0	259,000/400,000	10,000 CFM	208/230-3-60	125A	2,469 lbs
191690	YSH240G4RHA0000	20.0	259,000/400,000	10,000 CFM	460-3-60	70A	2,469 lbs
193976	YSH300G3RHA0000	25.0	296,400/400,000	10,000 CFM	208/230-3-60	150A	2,480 lbs
191370	YSH300G4RHA0000	25.0	296,400/400,000	10,000 CFM	460-3-60	70A	2,480 lbs

YSH Series Accessories

Part #	Model #	Description	Use With
38117	BAYECON091A	Economizer Horizontal	YSH150G
38118	BAYECON092A	Economizer Horizontal	YSH180-300G
38119	BAYENTH007A	Reference Enthalpy Kit	All BAYECON089-092A

Commercial Package Units

Commercial Foundation™ 3-Phase Packaged Air Conditioners with Gas Heat Up to 12 EER 80% AFUE R-410A Foundation™ Packaged Electric Air Conditioner with Gas Heat

- Unique dual-footprint design ideally suited for replacement applications
- Allows compatibility with multiple roof curbs without expensive adapters or other modifications
- Direct replacement for many Carrier units dating back 20+ years
- Convertible airflow
- Electromechanical controls
- Belt drive motors
- Single point power
- Single side service
- Operating charge of R-410A
- Tubular aluminized steel heat exchanger
- Dimensions: 58"H x 123-1/8"W x 86-15/16"D
- Liquid line filter-drier
- Factory installed options include:
 - Complete Coat™ condenser coil
 - Multi-speed indoor fans
 - Stainless steel heat exchanger
- 10-Year warranty on optional stainless steel heat exchanger
- 5-Year limited warranty on compressor
- 5-Year limited warranty on heat exchanger (15 ton)
- 1-Year limited warranty on heat exchanger (20 ton)
- 1-Year limited warranty on parts

Part #	Model #	Tons	Nom Cool/Heat BTUH	Nom Cooling CFM	Electrical	MOD (Amps)	Ship Weight
189838	GBC036A3EMA0000	3.0	37,000/100,000	1,200 CFM	208/230-3-60	30A	574 lbs
189839	GBC036A4EMA0000	3.0	37,000/100,000	1,200 CFM	460-3-60	15A	574 lbs
189840	GBC048A3EMA0000	4.0	49,600/115,000	1,600 CFM	208/230-3-60	35A	616 lbs
189841	GBC048A4EMA0000	4.0	49,600/115,000	1,600 CFM	460-3-60	15A	616 lbs
189842	GBC060A3EMA0000	5.0	59,000/115,000	2,000 CFM	208/230-3-60	40A	636 lbs
189843	GBC060A4EMA0000	5.0	59,000/115,000	2,000 CFM	460-3-60	20A	636 lbs

Cooling Performance is rated at 95°F ambient, 80°F entering dry bulb, 67°F entering wet bulb.

GBC Series Accessories

Part #	Model #	Description	Use With
189845	BAYCURB320A	14" Roof Curb	GBC036-GBC060
189850	BAYDMPR321A	0-25% Manual Outside Air Damper	GBC036-GBC060
189847	BAYECON320A	0-100% Dry Bulb Economizer	GBC036-GBC060

Commercial Package Units

Commercial Foundation™ 3-Phase Packaged Air Conditioners with Gas Heat Up to 11 EER 80% AFUE R-410A Foundation™ Packaged Electric Air Conditioner with Gas Heat

- Downflow or horizontal field convertible
- Scroll compressors on all units
- Operating charge of R-410A
- Low ambient operation to 40° as standard
- Color coded and numbered wiring
- Single side service access
- Molded handles on service access doors
- Liquid line refrigerant drier
- Provisions for through the base connections
- Phase monitor on all units
- 2 inch throwaway filters as standard
- Non-corrosive and removable drain pan
- Separated high and low voltage compartments
- 5-Year limited warranty on compressor and heat exchanger (15-25 tons)

Tons	Trane Model #	Carrier Model #
15.0	YCD181B, YCD181C, YCD180E, YCD180F, YCD181E, YCD181F, YSD180F, YHD180F, TCD181B, TCD181C, TDC180E, TCD180F, TCD181E, TCD181F, YSD180F, THD180F	48TJD016, 48TJF016, 48TJE016, 48HJD017, 48HJF017, 48TMD016, 48TMF016, 50TJ016, 50HJ017
17.5	YCD210A, TCD210B, YCD211B, YCD211C, YCD210E, YCD210F, YSD210F, YHD210F, TCD210A, TCD210B, TCD211B, TCD211C, TCD210E, TCD210F, TSD210F, THD210F	48TJD020, 48TJF020, 48TMD020, 48TMF020
20.0	YCD240A, YCD240B, YCD241B, YCD241C, YCD240E, YCD241E, YCD240F, YCD241F, YSD240F, YHD240F, TCD240A, TCD240B, TCD241B, TCD241C, TCD240E, TCD241E, TCD240F, TCD241F, TSD240F, THD240F	48TJD024, 48TJF024, 48TMD025, 48TMF025, 50TJ024, 50TM025
25.0	YCD300B, YCD301C, YCD300E, YCD301E, YCD301F, YSD300F, YHD300F	48TJD028, 48TJE048, 48TJF028, 48TMD028, 48TMF028, 50TJ028

Part #	Model #	Tons	Nom Cool/Heat BTUH	Nom Cooling CFM	Electrical	MOD (Amps)	Ship Weight
134814	GAC180A3EMA000	15.0	183,000/256,000	6,000 CFM	208/230-3-60	100A	2,183 lbs
134815	GAC180A4EMA000	15.0	183,000/256,000	6,000 CFM	460-3-60	45A	2,183 lbs
134816	GAC210A3EMA000	17.5	212,000/256,000	7,000 CFM	208/230-3-60	125A	2,240 lbs
134817	GAC210A4EMA000	17.5	212,000/256,000	7,000 CFM	460-3-60	50A	2,240 lbs
134818	GAC240A3EMA000	20.0	252,000/256,000	8,000 CFM	208/230-3-60	150A	2,327 lbs
134819	GAC240A4EMA000	20.0	252,000/256,000	8,000 CFM	460-3-60	70A	2,327 lbs
134820	GAC300A3EMA000	25.0	290,000/256,000	10,000 CFM	208/230-3-60	150A	2,327 lbs
134821	GAC300A4EMA000	25.0	290,000/256,000	10,000 CFM	460-3-60	70A	2,327 lbs

GAC Series Accessories

Part #	Model #	Description	Use With
13274	BAYCURB027B	Flat Roof curb	GAC180A-GAC300A
137854	BAYHZRT001A	Horizontal Conversion Kit	GAC180A-GAC300A
137862	BAYCARR001A	Carrier Replacement Kit	GAC180A-GAC300A
142383	BAYDMPR301A	Manual Fresh Air Damper	GAC180A-GAC300A
136166	BAYECON300A	Economizer Downflow Dry Bulb	GAC180A-GAC300A
137855	BAYECON301A	Economizer Horizontal Dry Bulb	GAC180A-GAC300A
170871	BAYENTH300	Reference Enthalpy Kit	GAC180A-GAC300A
170872	BAYENTH301	Comparative Enthalpy Kit	GAC180A-GAC300A
137854	BAYHZRT001A	Horizontal Duct Conversion Kit	GAC180A-GAC300A

Custom Roof Top Curbs

Adjustable Pitch Roof Curbs

- Shipped knocked-down in a carton for field assembly
- Up to 1" in 12" per foot
- Includes:
 - Assembly hardware, gaskets, wood nailer, and brackets

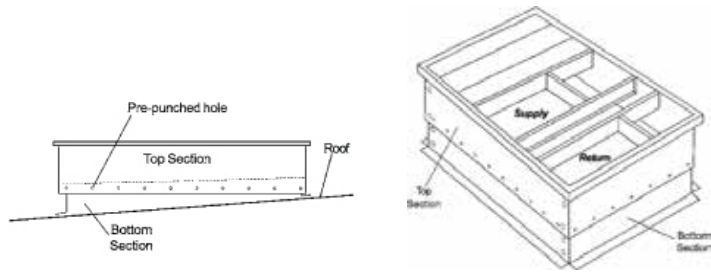

Part #	Model #	Fits Models	Dimensions H x W x D
37874	AP543-100	Precedent Series 6-10 Tons	80-1/2" x 46-3/8" x 14"-19"
37873	AP572-100	Precedent Series 3-5 Tons	61-49/64" x 37-27/64" x 14"-19"

Knocked-Down Roof Curbs

- Shipped knocked-down in a carton for field assembly
- Insulated deck pans
- Includes:
 - Assembly hardware, gaskets, wood nailer, brackets

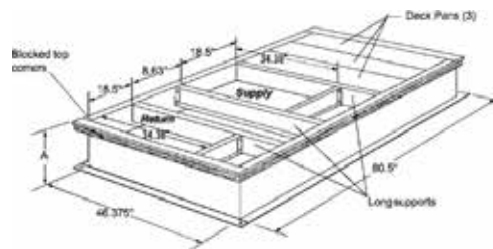

Part #	Model #	Description	MicroMetl #
50306	BAYCURB043A	14" Knocked Down Roof Curb 2-0(K)014-3105	MIC0543-014A
50305	BAYCURB042A	14" Knocked Down Roof Curb 2-0(K)014-3100	MIC0572-014A

Roof Curbs

Part #	Model #	Description	Use With
188746	MICECD-PRCOBCA-DYDB	Economizer Down Discharge, Low Leak Title 24, with FFD	Precedent 036-060
188747	MICECE-PRCOBCA-DYDB	Economizer Horizontal Discharge, Low Leak Title 24, with FFD	Precedent 036-060
188748	MICECD-PRCCECA-DYDB	Economizer Down Discharge, Low Leak Title 24, with FFD	Precedent 072-120
188749	MICECE-PRCCECA-DYDB	Economizer Horizontal Discharge, Low Leak Title 24, with FFD	Precedent 072-120
191546	MIC-9901-0364	Belimo Actuator Motor	
191780	MICROCOR 9901-1619	Discharge Sensor	
192760	MIC-9901-0345	Temp & Humidity Sensor	



Roof Curbs

Part #	Model #	Description	Use With
13195	BAYCURB026B	Downflow Only	YCD150E
13274	BAYCURB027B	Downflow Only	YCD151E-YCD301E, YCD180E-300E
63629	BAYCURB044A	Downflow Only	-
46510	BAYCURB050A	Full Perimeter Roof Curb (Flat Roof)	2/4YCC3018-036A
46511	BAYCURB051A	Full Perimeter Roof Curb (Flat Roof)	2/4YCC3042-060A

Models and Specifications are Subject to Change Without Notice

Custom Roof Top Curbs

Curb Adapters



Part #	Model #	Description
55894	CDI-1-2005-3100	Adapts New BAYCURB042 to Select Lennox GCS16, CHA16 & CHP16 Units
55745	CDI-1-2010-3105	Adapts New BAYCURB043 to Select Lennox GCS16, CHA16 & CHP16 Units
56058	CDI-1-3000-3100	Adapts New BAYCURB042 to Old Trane TCD/YCD BAYCURB021
55281	CDI-1-3005-3105	Adapts New BAYCURB043 to Old Trane TCD/YCD BAYCURB022
64155	CDI-1-3010-3105	Adapts New BAYCURB043 to Old Trane TCD/YCD BAYCURB025
76212	CDI-1-3015-3020	Adapts New BAYCURB027 to Old Trane TCD/YCD BAYCURB026
55663	CDI-1-3036-3100	Adapts New BAYCURB042 to Select Trane YCC, T/YCX, T/YCY, W/DCX & W/DCY Units Old Curb Size 62-1/16" x 43"
54291	CDI-1-3500-3105	Adapts New BAYCURB043 to Select Trane SACC & SFCB Units
55657	CDI-1-3505-3100	Adapts New BAYCURB042 to Select Trane SACA, SACC, SFCA & SFCB Units
55053	CDI-1-3510-3105	Adapts New BAYCURB043 to Select Trane SACA, SACC & SFCA/B/C/D Units
55277	CDI-1-3595-3105	RBO43 to Select rane SFCA, SFCB & SACA Units
56080	CDI-1-4000-3100	Adapts New BAYCURB042 to Select Carrier 48/50 TJ, HJ, GJ, LJ, QJ, HM and Bryant 580D Units
56099	CDI-1-4005-3105	Adapts New BAYCURB043 to Select Carrier 48/50 TJ, HJ, GJ and Bryant 580D Units
56059	CDI-1-4010-3020	Adapts New BAYCURB027 to Select Carrier 48/50 TJ, DP, DR, HJ and Bryant 542F, 559F, 579D/E, 599D/E & 581A Units
57814	CDI-1-4010-3105	Adapts New BAYCURB043 to Select Carrier 48/50 TJ, DP, DR, HJ and Bryant 542F, 559F, 579D/E, 599D/E & 581A Units
55167	CDI-1-4500-3100	Adapts New BAYCURB042 to Select Carrier 48/50 HD & LD Units
55925	CDI-1-4505-3105	Adapts New BAYCURB043 to Select Carrier 48/50 HD, LD, HZ, LZ, HV, HDD, LDD and Bryant 579D Units
55630	CDI-1-4510-3100	Adapts New BAYCURB042 to Select Carrier 48/50 HD, HDT, LD, LDT and Bryant 579D Units
54561	CDI-1-5005-3100	Adapts New BAYCURB042 to Select York DCG, DJ, 1RC & ZE Units
55923	CDI-1-5005-3105	Adapts New BAYCURB043 to Select York DCG, DJ, 1RC & ZE Units
79807	CDI-1-5010-3105	Adapts New BAYCURB043 to Select York DCG & CH Units
56153	CDI-1-7540-3100	Adapts New BAYCURB042 to Select tmaker RGD, RGH, PGDA & PGMB Units

Curb Adapters

Part #	Model #	Description
56552	CDI-1-2015-3105	Adapts New BAYCURB043 to Select Lennox GCS16/24 120/150
57985	CDI-1-3010-3015	Adapts Trane BAYCURB025 to BAYCURB026
60453	CDI-1-3100-3105	Adapts Trane BAYCURB042 to BAYCURB043
56152	CDI-1-4000-3105	Adapts Trane BAYCURB043 to Select 48 TF/TJ/HJ/LG/HM/QJ 004/005/006/007
60205	CDI-1-5010-3015	Adapts Trane BAYCURB026 to Select York D*CG-090/150; DUC-090/150
141660	CDI-1-3000-3105	Adapts Trane YSC072F to old YCD606C curb

Commercial Air Conditioners

Split System Cooling Commercial Air Conditioners

- Single point power supply
- Compressor motor overload protection
- High and low pressure cut-out switches
- Liquid line filter-drier installed
- Service valves with pressure taps
- Control transformer
- Low ambient cooling to 50°F as shipped, low ambient cooling to 0°F with accessory head pressure control
- Mounting/lifting rails under base
- 5-Year warranty on compressor
- 1-Year limited warranty on parts
- Extended warranties available

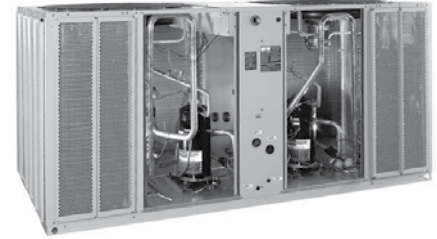

Up to 11.6 EER R-22 Single Compressor Split System Cooling Unit (Single Comp, Single Circuit)

- 12.5 to 20 Ton available through special order

Part #	Model #	Tons	Nom Cool BTUH	Electrical	Line Set Liq, Suc	Dimensions H x W x D	Ship Weight
2707	TTA090A300	7.5	90,000	208/230-3-60	5/8", 1-3/8"	39" x 36" x 42"	365 lbs
17929	TTA120A300	10.0	120,000	208/230-3-60	1/2", 1-3/8"	45" x 40" x 52"	467 lbs

Up to 11.6 EER R-410A Single Compressor Split System Cooling Unit (Single Comp, Single Circuit)

- Microchannel compressor
- 12.5 to 20 Ton available through special order

Part #	Model #	Tons	Nom Cool BTUH	Electrical	Line Set Liq, Suc	Dimensions H x W x D	Ship Weight
161357	TTA090G300	7.5.0	90,000	208/230-3-60	1/2", 1-3/8"	39" x 34" x 41"	365 lbs
62946	TTA090G400	7.5.0	90,000	460-3-60	1/2", 1-3/8"	39" x 34" x 41"	365 lbs
161358	TTA120G300	10.0	120,000	208/230-3-60	1/2", 1-3/8"	39" x 36" x 42"	467 lbs

Up to 11.5 EER R-410A Dual Compressor Split System Cooling Unit (Dual Circuit)

Part #	Model #	Tons	Nom Cool BTUH	Electrical	Line Set Liq, Suc	Dimensions H x W x D	Ship Weight
63061	TTA120E300	10.0	120,000	208/230-3-60	3/8", 1-1/8"	39" x 38" x 51"	481 lbs
63461	TTA180E300	15.0	180,000	208/230-3-60	1/2", 1-3/8"	39" x 34" x 88"	764 lbs

Commercial Air Conditioners

Split System Commercial Air Conditioner Up to 14.5 SEER R-410A 4TTA3 3-Phase Air Conditioner

- Quick-Sess™ cabinet with full coil protection
- Climatuff™ compressor
- Comfort-R™ mode approved
- Glossy polyslate gray corrosion resistant finish
- All-aluminum Spine-Fin™ coil
- Weatherproof Duratuff™ base
- Internal high/low pressure and temperature protection
- Factory installed liquid line filter-drier
- 5-Year limited warranty on compressor, outdoor coil and all other functional parts (residential use) (with registration)
- 5-Year limited warranty on compressor and outdoor coil (commercial use) (with registration)
- 1-Year warranty on all other functional parts (commercial use) (with registration)
- Optional extended warranties available



American Standard

Part #	Model #	Tons	Nom Cool BTUH	Electrical	Line Set Liq, Suc	Dimensions	Ship Weight
69842	4TTA3036A3000C	3.0	36,000	208/230/3/60	3/8", 3/4"	29" x 33" x 30"	228 lbs
69843	4TTA3036B4000A	3.0	36,000	460/3/60	3/8", 3/4"	29" x 33" x 30"	176 lbs
69846	4TTA3048D3000C	4.0	48,000	200/230/3/60	3/8", 3/4"	29" x 37" x 34"	235 lbs
69847	4TTA3048D4000C	4.0	48,000	460/3/60	3/8", 3/4"	33" x 37" x 34"	235 lbs
69848	4TTA3060D3000C	5.0	60,000	200/230/3/60	3/8", 7/8"	37" x 37" x 34"	261 lbs
81107	4TTA3060D4000C	5.0	60,000	460/3/60	3/8", 7/8"	41" x 37" x 34"	261 lbs

Trane

Part #	Model #	Power supply	Nom Cap Cooling (BTUH)	Dimensions H x W x D	Shipping Weight (lbs.)	Sound** Rating	MCA*	Max Fuse*	Line Size (in.)	
									OD Gas	OD Liquid
187867	4TTA3036B3000B	208/230/3/60	36,000	29" x 33" x 30"	176	78	14	20	3/4"	3/8"
187880	4TTA3036B3000B	208/230/3/60	48,000	29" x 37" x 34"	235	79	18	30	7/8"	3/8"
187885	4TTA3036B3000B	208/230/3/60	60,000	37" x 37" x 34"	261	80	21	35	7/8"	3/8"
187869	4TTA3036B3000B	460/3/60	36,000	29" x 33" x 30"	176	78	8	15	3/4"	3/8"
187882	4TTA3036B3000B	460/3/60	48,000	33" x 37" x 34"	235	79	8	15	7/8"	3/8"
187886	4TTA3036B3000B	460/3/60	60,000	41" x 37" x 34"	261	80	10	15	7/8"	3/8"

Commercial Air Conditioners

Split System Convertible Air Handlers

- Ships in horizontal configuration, but easily converts to upflow
- Check valves for heat pump applications
- Belt drive blower
- Captive screws remain on the panels for easy service
- Sloped/free draining pan prevents standing water
- Supplemental heaters (electric, water, steam) fit directly on unit discharge
- Single point power entry
- Fully assembled
- Compact design with low service clearance
- Brazed refrigerant piping connections
- Factory installed motor, belt, sheaves, contactor, expansion valve, low voltage terminal board, and evaporator defrost control (EDC)
- 1" Filters (rack convertible for field supplied 2")
- UL Listed fan relay
- CSA Certified fan relay
- 5-Year limited warranty on compressor
- 1-Year limited warranty on parts
- Extended warranties available



Part #	Model #	Tons	Nom Capacity BTUH	Electrical	Line Set Liq, Suc	Dimensions H x W x D	Ship Weight
63466	TWE061D300A	5.0	60,000	208/230-3-60	1/2", 1-1/8"	48" x 39" x 23"	263 lbs
63202	TWE090D300	7.5	90,000	208/230-3-60	1/2", 1-3/8"	54" x 49" x 26"	360 lbs
63200	TWE120D300	10.0	120,000	208/230-3-60	1/2", 1-3/8"	54" x 65" x 26"	429 lbs
63060	TWE120E300A*	10.0	120,000	208/230-3-60	1/2", 1-3/8"	54" x 65" x 26"	429 lbs

*Dual Circuit

Air Conditioners

Ameristar Air Conditioners

M4AC3 13 SEER, Single-Stage, R410A, - Split Cooling, A/C

Part #	Model #	Tons	Nom Cooling Capacity BTUH	Sound Rating	Dimensions H x W x D
80252	M4AC3018B1000N	1.5	18,000	74	24.94" x 21.88" x 21.88"
80253	M4AC3024B1000N	2.0	24,000	74	24.94" x 23.63" x 23.63"
80254	M4AC3030B1000N	2.5	30,000	74	24.94" x 28" x 28"
80255	M4AC3036B1000N	3.0	36,000	74	24.94" x 23.63" x 23.63"
80256	M4AC3042B1000N	3.5	42,000	76	29.88" x 28" x 28"
80257	M4AC3048B1000N	4.0	48,000	76	33.19" x 28" x 28"
80258	M4AC3060B1000N	5.0	60,000	76	33.19" x 29.13" x 29.13"



M4AC3

Features	M4AC3
SEER up to	13.00
# of stages	1
R410A Refrigerant	✓
Compact design and small footprint for minimal yard space	✓
Designed for quiet operation	✓
Painted, galvanized steel cabinet	✓
Scroll compressor	✓
5-year base limited warranty	✓
10-year registered limited warranty	✓
Warranty terms require registration within 60 days of installation	✓

Air Conditioners

Affordable, Dependable Heating and Cooling Systems from a Brand You Can Trust



Ameristar's product lineup includes a full range of air conditioning units, heat pumps, furnaces, ductless systems, packaged units, and indoor coils.

Ameristar heating and cooling systems deliver maximum flexibility, affordability, and reliability—making them an ideal solution for budget-conscious residential homeowners as well as property owners and managers, homebuilders, and developers who want to keep their residents comfortable year-round. Whether you need to replace an old unit for a homeowner or property manager or complete an install on a new construction project, we have the systems and components to fit every configuration and budget.

Ameristar is a brand of Ingersoll Rand (NYSE:IR), a \$14 billion global leader in creating and sustaining safe, comfortable, and efficient indoor environments. Ameristar products are designed, tested, and supported by the same Ingersoll Rand HVAC teams that have been delivering quality construction and solid performance for more than 100 years.

The Ameristar Advantage

Value: Equipped with the power and features you need, Ameristar heating and cooling systems can fit any budget

Efficiency: Ameristar air conditioning units, heat pumps and packaged units all achieve high-efficiency SEER ratings

Quiet operation: Ameristar HVAC products operate quietly, thanks to high-efficiency compressors and fully insulated construction.

Durability: Our architecturally compatible, anti-rust cabinets endure a 500-hour salt test to make sure they hold up to time and weather.

Safety: Internal safeguards protect compressors against high and low pressure, coil temperatures, and power surges.

Compact design: The small footprint of our HVAC products make them ideal for properties with limited yard or installation space.



Gas Furnaces

M952V 2-Stage 95% Variable Speed Gas Furnaces

M952V Upflow Gas Furnace

Part #	Model #	BTU Input	AFUE	Tons	Dimensions H x W x D
138647	M952V060BU36AB	60,000	95	3.0	40" x 17.5" x 28"
138648	M952V080BU36AB	80,000	95	3.0	40" x 17.5" x 28"
138649	M952V100CU48AB	100,000	95	4.0	40" x 21" x 28"
138650	M952V120DU60AB	120,000	95	5.0	40" x 24.5" x 28"

M952V Downflow Gas Furnace

Part #	Model #	BTU Input	AFUE	Tons	Dimensions H x W x D
138651	M952V060BD36AB	60,000	95	3.0	40" x 17.5" x 28"
138652	M952V080BD36AA	80,000	95	3.0	40" x 17.5" x 28"
138653	M952V100CD48AA	100,000	95	4.0	40" x 21" x 28"
138654	M952V120DD60AA	120,000	95	5.0	40" x 24.5" x 28"

M951P 95% Single-Stage Gas Furnaces

M951P Upflow Gas Furnace

Part #	Model #	BTU Input	AFUE	Tons	Dimensions H x W x D
80293	M951P040BU24AA	40,000	95	2.0	40" x 17.5" x 28"
80294	M951P060BU36AA	60,000	95	3.0	40" x 17.5" x 28"
80295	M951P080BU42AB	80,000	95	3.5	40" x 17.5" x 28"
80296	M951P100CU48AA	97,000	95	4.0	40" x 21" x 28"
80297	M951P100DU60AA	97,000	95	5.0	40" x 24.5" x 28"
80298	M951P120DU60AA	110,000	95	5.0	40" x 24.5" x 28"

M951P Downflow Gas Furnace

Part #	Model #	BTU Input	AFUE	Tons	Dimensions H x W x D
80299	M951P040BD24AA	40,000	95	2.0	40" x 17.5" x 28"
80300	M951P065BD42AA	60,000	95	3.5	40" x 17.5" x 28"
80301	M951P085CD48AA	80,000	95	4.0	40" x 21" x 28"
80302	M951P110DD60AA	110,000	95	5.0	40" x 24.5" x 28"

Features and options on next page



We maintain well-stocked and conveniently located warehouses. Please visit us at the branch nearest you.

Gas Furnaces

Equipment

M801P 80% Single-Stage Gas Furnaces

M801P Upflow Gas Furnace

Part #	Model #	BTU Input	AFUE	Airflow in Tons	Dimensions H x W x D
80276	M801P040AU24AA	40,000	80	2.0	40" x 14" x 28"
80277	M801P060AU24AA	60,000	80	2.0	40" x 14" x 28"
80278	M801P060AU36AA	60,000	80	3.0	40" x 14" x 28"
81938	M801P080BU36AA	80,000	80	3.0	40" x 17.5" x 28"
80279	M801P080BU48AA	80,000	80	4.0	40" x 17.5" x 28"
80280	M801P100BU36AA	100,000	80	3.0	40" x 17.5" x 28"
80281	M801P100CU48AA	100,000	80	4.0	40" x 21" x 28"
80282	M801P100CU60AA	100,000	80	5.0	40" x 21" x 28"
80283	M801P120DU60AA	120,000	80	5.0	40" x 24.5" x 28"
80284	M801P140DU60AA	140,000	80	5.0	40" x 24.5" x 28"

M801P Downflow Gas Furnace

Part #	Model #	BTU Input	AFUE	Airflow in Tons	Dimensions H x W x D
80286	M801P060AD24AA	60,000	80	2.0	40" x 14" x 28"
80287	M801P060AD36AA	60,000	80	3.0	40" x 14" x 28"
80288	M801P080BD45AA	80,000	80	4.0	40" x 17.5" x 28"
80289	M801P100CD48AA	100,000	80	4.0	40" x 21" x 28"
80290	M801P100CD60AA	100,000	80	5.0	40" x 21" x 28"
80291	M801P120DD60AA	120,000	80	5.0	40" x 24.5" x 28"
80292	M801P140DD60AA	140,000	80	5.0	40" x 24.5" x 28"



Features	M952V	M951P	M801P
AFUE	95%	95%	80%
# of stages	2	1	1
Variable speed	✓	-	-
Gas or propane heating	✓	✓	✓
Aluminized steel heat exchangers	✓	✓	✓
Galvanized steel cabinet	✓	✓	✓
5-year base limited warranty	✓	✓	✓
10-year registered limited warranty	✓	✓	✓
20-year limited heat exchanger limited warranty	✓	✓	✓
Warranty terms require registration within 60 days of installation	✓	✓	✓

Models and Specifications are Subject to Change Without Notice

Commercial Air Conditioners

Ameristar Single-Phase Packaged Air Conditioners with Gas Heat
14 SEER R-410A Single-Phase Packaged, Cooling/Gas Heat,
Convertible, 14 SEER Air Conditioners with Gas Heat

- 14 SEER/11 EER
- 81% AFUE
- Architecturally compatible to fit a small footprint
- Painted, anti-rust steel cabinets
- 5-Year limited warranty on compressor
- 5-Year limited warranty on parts
- 10-Year limited warranty on heat exchanger
- Extended warranties available



Equipment

Part #	Model #	Tons	Nom Cool/Heat BTUH	Nom Cooling CFM	Electrical
171008	M4PG4024A1060A	2	24,000/48,600	800 CFM	208/230-1-60
171009	M4PG4030A1060A	2.5	30,000/48,600	1,000 CFM	208/230-1-60
171010	M4PG4036A1090A	3	36,000/72,900	1,200 CFM	208/230-1-60
171011	M4PG4042A1090A	3.5	42,000/72,900	1,400 CFM	208/230-1-60
171012	M4PG4048A1090A	4	48,000/72,900	1,600 CFM	208/230-1-60
171013	M4PG4060A1130A	5	60,000/105,300	2,000 CFM	208/230-1-60



A MUNCH'S SUPPLY COMPANY

**WE APPRECIATE
YOUR BUSINESS!**

Coils

Cased Evaporator Coils

- High-efficiency lanced fin design
- HydroTEC™ drain pan is corrosion-proof, UV-resistant polymer with Microban® antimicrobial additive that prevents mold and mildew
- Optional painted cabinets
- Corrosion resistant coil header plates
- Fully lined with 5/8" foil-backed insulation
- Foam drain seal for reduced air leakage
- Dual 3/4" FPT condensate drains on front-left and front-right sides
- 5-Year no-hassle warranty



Painted Cased, TXV, Upflow/Downflow, A/C, A-Coil

Part #	Model #	Airflow Tons*		Metering Device	Line Set Liq, Suc	Dimensions W x H x D
		Upflow	Downflow**			
71211	TE31630D145	1.5 - 2.5	1.5 - 2.0	AC TXV	3/8" x 3/4"	14-1/2" x 16-1/2" x 21"
71212	TE31630D175	1.5 - 2.5	1.5 - 2.0	AC TXV	3/8" x 3/4"	17-1/2" x 16-1/2" x 21"
71342	TE32636D145	1.5 - 3.0	1.5 - 2.5	AC TXV	3/8" x 3/4"	14-1/2" x 16-1/2" x 21"
71215	TE32636D175	1.5 - 3.0	1.5 - 2.5	AC TXV	3/8" x 3/4"	17-1/2" x 16-1/2" x 21"
71216	TE32636D210	1.5 - 3.0	1.5 - 2.5	AC TXV	3/8" x 3/4"	21" x 16-1/2" x 21"
71343	TE33636D175	1.5 - 3.0	1.5 - 3.0	AC TXV	3/8" x 3/4"	17-1/2" x 18-1/2" x 21"
71344	TE33636D210	1.5 - 3.0	1.5 - 3.0	AC TXV	3/8" x 3/4"	21" x 18-1/2" x 21"
81764	TE36636D175	1.5 - 3.0	1.5 - 3.0	AC TXV	3/8" x 3/4"	17-1/2" x 25-1/2" x 21"
81903	TE36636D210	1.5 - 3.0	1.5 - 3.0	AC TXV	3/8" x 3/4"	21" x 25-1/2" x 21"
182626	TE47636D175	1.5 - 3.0	1.5 - 3.0	AC TXV	3/8" x 3/4"	17-1/2" x 29-1/2" x 21"
182627	TE47636D210	1.5 - 3.0	1.5 - 3.0	AC TXV	3/8" x 3/4"	21" x 29-1/2" x 21"
190510	TE1K642D175	3.5	3.5	AC TXV	3/8" x 7/8"	17-1/2" x 25-1/2" x 21"
190511	TE1K642D210	3.5	3.5	AC TXV	3/8" x 7/8"	21" x 25-1/2" x 21"
190512	TE2K648D175	3.5 - 4.0	3.5 - 4.0	AC TXV	3/8" x 7/8"	17-1/2" x 25-1/2" x 21"
190513	TE2K648D210	3.5 - 4.0	3.5 - 4.0	AC TXV	3/8" x 7/8"	21" x 25-1/2" x 21"
190514	TE2K648D245	3.5 - 4.0	3.5 - 4.0	AC TXV	3/8" x 7/8"	24-1/2" x 25-1/2" x 21"
137422	TE48660D210	3.5 - 5.0	3.5 - 5.0	AC TXV	3/8" x 7/8"	21" x 27-1/2" x 21"
71221	TE48660D245	3.5 - 5.0	3.5 - 5.0	AC TXV	3/8" x 7/8"	24-1/2" x 27-1/2" x 21"
138635	TE50660D210	3.5 - 5.0	3.5 - 5.0	AC TXV	3/8" x 7/8"	21" x 27-1/2" x 21"

*Refers to airflow rating only, consult AHRI for SEER ratings and approved matches.

**Requires 172640 for downflow applications, see pg 63.

Painted, Cased, TXV, Upflow/Downflow/Hort, A/C, A-Coil

Part #	Model #	Up, Down, Horizontal	Metering Device	Line Set Liq, Suc	Dimensions W x H x D
82572	TE32636D175B1622AP	1.5 - 3.0	AC TXV	3/8" x 3/4"	17-1/2" x 16-1/2" x 21"
82574	TE32636D210B1622AP	1.5 - 3.0	AC TXV	3/8" x 3/4"	21" x 16-1/2" x 21"
190515	TE1K642D175B2522AP	3.5	AC TXV	3/8" x 7/8"	17-1/2" x 25-1/2" x 21"
190516	TE2K648D210B2522AP	3.5 - 4.0	AC TXV	3/8" x 7/8"	21" x 25-1/2" x 21"
82577	TE48660D245B2722AP	3.5 - 5.0	AC TXV	3/8" x 7/8"	24-1/2" x 27-1/2" x 21"

*Refers to airflow rating only, consult AHRI for SEER ratings and approved matches.

Coils

Painted, Cased, All Aluminum, TXV, Upflow/Downflow/Horizontal Heat Pump A-Coil

- High-efficiency lanced fin design
- HydroTEC™ drain pan is corrosion-proof, UV-resistant polymer with Microban® antimicrobial additive that prevents mold and mildew
- Dual 3/4" FPT condensate drains on front-left and front-right sides
- 5-Year no-hassle warranty



Part #	Model #	Airflow Tons*		Metering Device	Line Set Liq, Suc	Dimensions H x W x D
		Upflow	Downflow**			
182182	TG30924D175	1.5 - 2.0	1.5	HP TXV	3/8" x 3/4"	17-1/2" x 12-1/2" x 21"
182183	TG31930D175	1.5 - 2.5	1.5 - 2.0	HP TXV	3/8" x 3/4"	17-1/2" x 16-1/2" x 21"
182184	TG32936D175	1.5 - 3.0	1.5 - 2.5	HP TXV	3/8" x 7/8"	17-1/2" x 16-1/2" x 21"
182339	TG36960D210B250	3.5 - 5.0	3.5 - 4.0	HP TXV	3/8" x 7/8"	21" x 25-1/2" x 21"

*Refers to airflow rating only, consult AHRI for SEER ratings and approved matches.

**Requires 172640 for downflow applications, see pg 63.

Unpainted, Cased, Piston, Upflow/Downflow, A/C, A-Coil

Part #	Model #	Airflow Tons*		Metering Device	Installed Orifice	Line Set Liq, Suc	Dimensions H x W x D
		Upflow	Downflow**				
190497	HE32136D145B	1.5 - 3.0	1.5 - 2.5	Piston	3.0 T #67	3/8" x 3/4"	14-1/2" x 16-1/2" x 21"
190499	HE32136D175B	1.5 - 3.0	1.5 - 2.5	Piston	3.0 T #67	3/8" x 3/4"	17-1/2" x 16-1/2" x 21"
190500	HE1K142D210B	3.5	3.5	Piston	3.5 T #73	3/8" x 7/8"	21" x 25-1/2" x 21"
190501	HE2K148D210B	3.5 - 4.0	3.5 - 4.0	Piston	4.0 T #76	3/8" x 7/8"	21" x 25-1/2" x 21"
190502	HE48160D210B	3.5 - 5.0	3.5 - 5.0	Piston	5.0 T #93	3/8" x 7/8"	21" x 27-1/2" x 21"
190503	HE48160D245B	3.5 - 5.0	3.5 - 5.0	Piston	5.0 T #93	3/8" x 7/8"	24-1/2" x 27-1/2" x 21"

*Refers to airflow rating only, consult AHRI for SEER ratings and approved matches.

**Requires 172640 for downflow applications, see pg 63.

Coils

Uncased Evaporator Coils

- High-efficiency lanced fin design
- Foam packed with barcoding on label
- Air pressure tested at 500 psi, leak tested with helium, sealed with rubber plugs, then charged with dry air
- 5-Year no-hassle warranty



Uncased, TXV, Upflow/Downflow, A/C, A-Coil

Part #	Model #	Airflow Tons*		Metering Device	Line Set Liq, Suc	Dimensions W x H x D
		Upflow	Downflow**			
49642	HE30624A130	1.5 - 2.0	1.5	AC TXV	3/8" x 3/4"	13" x 11" x 21"
190504	HE32630A130	1.5 - 2.5	1.5 - 2.0	AC TXV	3/8" x 3/4"	13" x 19-1/2" x 15"
71157	HE32636A140	1.5 - 3.0	1.5 - 2.5	AC TXV	3/8" x 3/4"	14" x 15" x 21"
71206	HE32636A155	1.5 - 3.0	1.5 - 2.5	AC TXV	3/8" x 3/4"	15-1/2" x 15" x 21"
71207	HE32636A170	1.5 - 3.0	1.5 - 2.5	AC TXV	3/8" x 3/4"	17" x 15" x 21"
81758	HE33636A155	1.5 - 3.0	1.5 - 3.0	AC TXV	3/8" x 3/4"	15-1/2" x 17" x 21"
72524	HE33636A170	1.5 - 3.0	1.5 - 3.0	AC TXV	3/8" x 3/4"	17" x 17" x 21"
81759	HE36636A155	1.5 - 3.0	1.5 - 3.0	AC TXV	3/8" x 3/4"	15-1/2" x 23" x 21"
81760	HE36636A170	1.5 - 3.0	1.5 - 3.0	AC TXV	3/8" x 3/4"	17" x 23" x 21"
190505	HE1K642A155	3.5	3.5	AC TXV	3/8" x 7/8"	15-1/2" x 21" x 21"
190506	HE1K642A170	3.5	3.5	AC TXV	3/8" x 7/8"	17" x 21" x 21"
190507	HE1K642A200	3.5	3.5	AC TXV	3/8" x 7/8"	20" x 21" x 21"
190508	HE2K648A170	3.5 - 4.0	3.5	AC TXV	3/8" x 7/8"	17" x 23" x 21"
190509	HE2K648A200	3.5 - 4.0	3.5	AC TXV	3/8" x 7/8"	20" x 23" x 21"
82883	HE46660A235	3.5 - 5.0	3.5 - 5.0	AC TXV	3/8" x 1-1/8"	23-1/2" x 29" x 21"
43794	HE48660A200	3.5 - 5.0	3.5 - 5.0	AC TXV	3/8" x 7/8"	20" x 27" x 21"
81762	HE49660A205	3.5 - 5.0	3.5 - 4.0	AC TXV	3/8" x 7/8"	20-1/2" x 25" x 21"

*Tons refers to airflow only, consult AHRI for SEER rating.

Uncased, Piston, Upflow/Downflow, A/C, A-Coil

- Florators standard, field installed expansion valves available for R-22, R-410A, AC or HP

Part #	Model #	Airflow Tons*		Metering Device	Installed Orifice	Line Set Liq, Suc	Dimensions W x H x D
		Upflow	Downflow**				
73010	HE30124A130	1.5 - 2.0	1.5	Piston	2.0 T #53	3/8" x 3/4"	13" x 11" x 21"
190517	HE31130A130	1.5 - 2.0	1.5 - 2.0	Piston	2.5 T #59	3/8" x 3/4"	13" x 13" x 21"
190493	HE32136A155	1.5 - 3.0	1.5 - 2.5	Piston	3.0 T #67	3/8" x 3/4"	15-1/2" x 15" x 21"
190494	HE32136A170	1.5 - 3.0	1.5 - 2.5	Piston	3.0 T #67	3/8" x 3/4"	17" x 15" x 21"
190495	HE2K148A200	3.5 - 4.0	3.5 - 4.0	Piston	4.0 T #76	3/8" x 7/8"	20" x 23" x 21"
190496	HE48160A200	3.5 - 5.0	3.5 - 5.0	Piston	5.0 T #93	3/8" x 7/8"	20" x 28" x 21"

*Coil ships with R-410A piston as shown above. For other tonnages or R22, piston should be changed accordingly.

Coils

Unpainted, Cased, TXV, Horizontal, A/C, Slab-Coil

- Horizontal bi-directional airflow



Part #	Model #	Airflow Tons*	Metering Device	Line Set Liq, Suc	Dimensions W x H x D
49649	HH58636A225	1.5 - 3.0	AC TXV	3/8" x 3/4"	27" x 22-3/4" x 10"
49650	HH60660A305	3.5 - 5.0	AC TXV	3/8" x 7/8"	35" x 22-3/4" x 10"

Part #	Model #	Airflow Tons*	Metering Device	Installed Orifice	Line Set Liq, Suc	Dimensions W x H x D
182117	M30E311	2.5	Piston	2.5 T #59	3/8" x 3/4"	18" x 13" x 19-1/2"
182115	M36E221	3	Piston	3.0 T #67	3/8" x 3/4"	18" x 15" x 19-1/2"
182119	M42E341	3.5	Piston	3.5 T #73	3/8" x 7/8"	18" x 19" x 19-1/2"

ADP Kit

Part #	Model #	Description
172640	076701323	Inside Downflow Flange

ADP Piston Chart

		1.5 Ton	2.0 Ton	2.5 Ton	3.0 Ton	3.5 Ton	4.0 Ton	5.0 Ton
R-410A	Size	#49	#53	#59	#67	#73	#76	#93
	Part #	73541	15462	16050	16862	17424	73863	33737
R22	Size	#53	#59	#67	#73	#80	#84	#93
	Part #	15462	16050	16862	17424	18093	18491	33737



A MUNCH'S SUPPLY COMPANY

We welcome the opportunity to answer your questions regarding products.

Air Handlers

BC Series Multi-Position Air Handlers

- Upflow/horizontal left and right
- Constant speed blower
- Pre-painted heavy-gauge galvanized steel cabinet
- Dual drains, left and right connections with multiple knockouts
- Multiple electrical connection locations
- (2) Separate front panels
- Slide-out blower and coil assembly
- Filter rack door with tight seal, fiberglass air filter comes with air handler, easy to replace filters
- 5/8" Foil faced insulation
- Enhanced secure and tight grommets
- Quiet balanced blower motors
- ETL Listed
- 5-Year limited warranty



R-410A Multi-Position Piston 3-Speed Air Handler

- Piston metering

Part #	Model #	Tons	Nom BTUH	Electrical	Line Set Liq, Suc	Coil Type	Dimensions H x W x D	Unit Weight
74779	BCRMA3124-S001	2.0	24,000	208/240-1-60	3/8", 3/4"	Slant	44" x 15" x 22"	120 lbs
74784	BCRMA3124-S003	2.0	24,000	120-1-60	3/8", 3/4"	Slant	44" x 15" x 22"	120 lbs
74781	BCRMB6136-S001	3.0	36,000	208/240-1-60	3/8", 3/4"	Slant	48" x 18.5" x 22"	140 lbs
74785	BCRMB6136-S003	3.0	36,000	120-1-60	3/8", 3/4"	Slant	48" x 18.5" x 22"	140 lbs
74782	BCRMB9148-S001	4.0	48,000	208/240-1-60	3/8", 7/8"	A	49" x 20" x 26"	230 lbs
74787	BCRMB9148-S003	4.0	48,000	120-1-60	3/8", 7/8"	A	49" x 20" x 26"	230 lbs
74783	BCRMC4160-S001	5.0	60,000	208/240-1-60	3/8", 7/8"	A	53" x 22" x 26"	240 lbs
74788	BCRMC4160-S003	5.0	60,000	120-1-60	3/8", 7/8"	A	53" x 22" x 26"	240 lbs

*Unit weight not including Hot Water Coil or Heating Element

Air Handler Accessories

Part #	Model #	Description	Fits
36592	650264-01	R-410A TXV Kit AC Only 1.5-3 Ton	B Series 24,000 & 36,000
36591	650264-00	R-410A TXV Kit AC Only 3.5-5 Ton	B Series 24,000 & 36,000
23455	991675-01	R22 TXV Kit AC Only 1.5-3 Ton	B Series 48,000 & 60,000
41233	991675-02	R22 TXV Kit AC Only 3.5-5 Ton	B Series 48,000 & 60,000
60074	655009-03	5KW Electric Heat Kit with Breaker	B Series 24,000 & 36,000 (208/230V Units Only)
56082	655009-07	10KW Electric Heat Kit with Breaker	B Series 24,000 & 36,000 (208/230V Units Only)
35200	655009-08	12.5KW Electric Heat Kit with Breaker	B Series 30,000 & 36,000 (208/230V Units Only)
74684	655010-08	12.5KW Electric Heat Kit with Breaker	B Series 48,000 & 60,000 (208/230V Units Only)
35013	655009-09	15kW Electric Heat Kit with Breaker	B Series 30,000,36,000
74685	655010-09	15kW Electric Heat Kit with Breaker	B Series 48,000 & 60,000 (208/230V Units Only)
62577	65614156	3 Row Hydronic Coil Kit w/o Pump and Valve 120V	B Series 12,000, 18,000, 24,000
76297	65614162	3 Row Hydronic Coil Kit w/o Pump and Valve 120V	B Series 25,000, 30,000, 36,000
161882	65614168	4 Row Hydronic Coil Kit w/o Pump and Valve 120V	B Series 31,000, 37,000, 42,000, 48,000

Models and Specifications are Subject to Change Without Notice

Fan Coils

At Tommark, we're happy to special order items for our customers. Contact your local branch, Territory Manager, or our inside sales or commercial team to find out how we can help you get the job done! Not sure what you need? Let us know. We'll figure it out together.

Horizontal Ceiling Mount Fan Coils Available by Special Order Only

Cabinet Design

Low-Static, direct-drive fan coils range from 100 to 1,200 CFM. Units are constructed of heavy-gauge galvanized steel and insulated with ½" thick, over three-pound density, neoprene-coated fiberglass. Our low-static horizontal fan coils are a blow-through design. Drain pans are powder-coated epoxy with ⅛" thick-closed cell insulation featuring primary and secondary drain connections. The low-profile design is particularly effective above drop ceilings in closets and fits into spaces with tight vertical dimensions. They are designed for jobs where low-static pressure is required.



Basic LH-B

Basic - LH-B

The Basic fan coil consists of coil, blower assembly, motor quick-connect plug and insulated drain pan. Whether in hotels, motels or apartments, this fan coil is perfectly adaptable because of its low profile. This model has no exterior cabinet.



**Return-Air Plenum
LH-R**

Return-Air Plenum - LH-R

The return-air plenum is the same as our Basic unit with a galvanized rear return-air plenum (bottom return optional) insulated with a ½" neoprene-coated fiberglass. It is also effective for mounting above ceilings, in closets, hallways or bathroom areas. The plenum conceals the unit's blower motor, which is easily accessible for service by removing the bottom panel.



Deluxe LH-D

Deluxe - LH-D

Our Deluxe model is designed for a horizontal, exposed ceiling mount application. The Deluxe is a Basic fan coil with cabinet manufactured of cold-rolled steel, phosphate conversion-coated then finished in a soft-white, powder-coated epoxy. It is adaptable for remodel situations where the addition of ductwork is limited.

Unit Heaters

Residential/Light Commercial Unit Heaters (ADP)

- Electrical: 115-1-60
- Power exhaust system with sealed flue collector allows for vertical or horizontal venting up to 40'
- Direct spark ignition occurs only when thermostat calls for heat
- Hinged door with burner view port
- Easy to clean in-shot burners
- Self-diagnostic board with indicator lights
- Direct drive propeller fans dynamically balanced
- Includes hanging brackets
- 10-Year limited warranty on aluminum heat exchangers
- 2-Year limited warranty on parts



FSA Residential Cayenne™ Low-Profile Unit Heater

- Airfoil design air vanes
- Low-profile heating of residential garages
- Wire junction box inside cabinet
- 1/2" Gas connection

Part #	Model #	Gas Type	Input/Output BTUH	Efficiency	Max CFM	Vent Dia	Blower Fan Dia	Dimensions H x W x D	Ship Weight
27946	FSAN-30	NG	30,000/24,300	81%	535 CFM	3"	10"	12" x 25" x 24"	45 lbs
1391	FSAN-45	NG	45,000/36,500	81%	750 CFM	3"	10"	12" x 25" x 24"	50 lbs
9798	FSAP-45	LP	45,000/36,500	81%	750 CFM	3"	10"	12" x 25" x 24"	50 lbs
16813	FSAN-60	NG	60,000/48,000	80%	830 CFM	4"	14"	17" x 25" x 25"	87 lbs
20639	FSAN-75	NG	75,000/60,000	80%	950 CFM	4"	14"	17" x 25" x 25"	91 lbs
21040	FSAP-75	LP	75,000/60,000	80%	950 CFM	4"	14"	17" x 25" x 25"	91 lbs

FOA Residential/Light Commercial Separated Combustion Heater (ADP)

- 2-Pipe system to eliminate indoor contaminates from entering heat exchanger compartment
- Certified installation required
- Concentric vent contains all parts required for termination
- Wire junction box located outside cabinet
- 1/2" Gas connection



Part #	Model #	Gas Type	Input/Output BTUH	Efficiency	Max CFM	Vent Dia	Combustion Air Inlet	Blower Fan Dia	Dimensions H x W x D	Ship Weight
39187	FOAN-45	NG	45,000/36,225	81%	750 CFM	3"	3"	10"	12" x 26" x 24"	84 lbs

Unit Heaters

Commercial Unit Heaters (ADP)

SEP Unit Heater with Standard Aluminized Heat Exchanger

- Electrical: 115-1-60
- Power exhaust
- Aluminized tubular heat exchanger standard
- In-shot burners
- Direct spark ignition
- Direct-drive propeller fans
- 10-Year limited warranty on aluminum heat exchanger
- 15-Year warranty on optional stainless steel heat exchanger
- 2-Year limited warranty on all components
- 5-Year limited warranty



Part #	Model #	Gas Type	Input/Output BTUH	Efficiency	Max CFM	Vent Dia	Dimensions H x W x D	Ship Weight
51268	SEP100	NG	100,000/80,500	80%	1,900 CFM	4"	32-1/4" x 20-1/4" x 39-1/4"	150 lbs
8677	SEP115	NG	115,000/92,000	80%	1,900 CFM	4"	32-1/4" x 20-1/4" x 39-1/4"	150 lbs
8970	SEP145	NG	145,000/116,000	80%	1,900 CFM	4"	32-1/4" x 20-1/4" x 39-1/4"	165 lbs
9224	SEP175	NG	172,500/138,000	80%	2,200 CFM	5"	32-1/4" x 23-1/8" x 39-1/4"	185 lbs
9452	SEP200	NG	195,000/156,000	80%	2,200 CFM	5"	32-1/4" x 23-1/8" x 40"	185 lbs
9707	SEP230*	NG	230,000/184,000	80%	4,400 CFM	5"	32-1/4" x 41-1/8" x 40"	275 lbs
48361	SEP250	NG	250,000/201,250	80%	4,400 CFM	5"	39" x 36-1/2" x 39-5/8"	307 lbs
48362	SEP300*	NG	300,000/241,500	80%	4,400 CFM	5"	32-1/4" x 41-1/8" x 40"	280 lbs
21194	SEP400*	NG	390,000/312,000	80%	4,400 CFM	6"	32-1/4" x 41-1/8" x 41-1/8"	315 lbs

*Unit contains dual fans

NG to LP Conversion Kit for ADP SEP Unit Heaters

Part #	Model #	Description
63451	165296401	NG to LP Conversion Kit for SEP100
56433	165295202	NG to LP Conversion Kit for SEP115, SEP145, SEP175
57103	165295205	NG to LP Conversion Kit for SEP200

Baseboard / Kickspace Heaters

Baseboard Heaters

HBB Series Liquid Filled Electric Hydronic Heater

- For new home construction, remodeling, or room additions
- Sheathed electric heating element totally immersed in a heat-transfer liquid and sealed in a heater-length copper tube
- Mounts flush to any wall and flat on any floor
- Individual room control
- Maximum heat retention
- Large wiring compartment
- Heavy-duty welded steel louvered grilles
- Corrosion-resistant aluminum fins
- Heat temperature shutoff protection



Part #	Model #	BTUH	Length	Watts	Volts	Amps	Weight
6426	LF-1504/HBB1504	5,120/3,839	70"	1,500W	240/208V	6.3/5.4A	22 lbs

HBB Series Liquid Filled Electric Hydronic Heater

- Comes assembled
- For use with HBB series baseboard heaters

Part #	Model #	Volts	Amps	Description
1692	LFT2/HBBT2	120-277VAC	25A	Thermostat Assembly

2500 Series Electric, Standard Density Baseboard Heater

- For use in residential and commercial, industrial and institutional construction
- Quiet operation
- Built-in safety thermal cut-off protection
- Easy-out knockouts at each end
- Chimney fin element design for maximum air circulation
- Pre-notched mounting guide
- Built-in cable clamp in both wiring compartments
- Navajo white enamel finish
- Grounding wire pigtail in both junction boxes
- Rounded corners
- Thermostat required (sold separately)
- UL Listed



Part #	Model #	BTUH	Length	Watts	Volts	Amps	Weight
5339	BKO-2542W	1,365	2'	400W	240/208V	2.1/1.8A	5.2 lbs
5353	BKO-2543W	2,559	3'	750W	240/208V	3.1/2.7A	7.5 lbs
5362	BKO-2544W	3,412	4'	1,000W	240/208V	4.2/3.6A	10.0 lbs
5374	BKO-2545W	4,265	5'	1,250W	240/208V	5.2/4.5A	11.5 lbs
5390	BKO-2546W	5,118	6'	1,500W	240/208V	6.3/5.4A	14.0 lbs
5411	BKO-2548W	6,824	8'	2,000W	240/208V	8.3/7.2A	18.5 lbs
20866	BKO-25408W	8,530	8'	2,500W	240/208V	10.4/8.7A	18.5 lbs

Baseboard / Kickspace Heaters

Thermostat Kits

Snap-Action Baseboard Thermostat Assembly

- For use with 2500 series baseboard heaters



Part #	Model #	Description
12205	TA1AW	Baseboard Thermostat, SP 22 Ampere, 40° to 100°F
12294	TA2AW	Baseboard Thermostat, DP 22 Ampere, 40° to 100°F

Unit Heaters

Horizontal Unit Heater

- Single-phase
- Built-in single-pole thermostat adjusts from 45° to 90°F
- Field adjustable between (8) wattages and (2) voltages
- Automatic control delays fan action until heating element is warm
- High level cut-out automatically shuts off current if overheating and turns back on when cooled off
- Includes ceiling mounting bracket for horizontal or vertical flow mounting
- 5-Year warranty



Part #	Model #	BTUH	Volts	kW Capacity	Throw	Dimensions H x W x D	Ship Weight
17920	HUH524TA	8,533/17,065	240V	2.5 - 5.0	16'	12-1/2" x 14" x 11-1/4"	24 lbs



**Let us be your source for quality products
from leading manufacturers.**

Unit Heaters

Unit Heaters

- Sizes 30 to 125 are approved for residential application
- Tcore2® Design titanium stabilized aluminized steel heat exchanger and single burner combustion system with 1-piece burner assembly (patent pending)
- Electrical: 115-1-60
- Transformer for 24V controls
- Integrated circuit board with diagnostic indicator lights
- Multi-try direct spark ignition with timed lockout
- Full fan guard engineered for safety
- Includes fan relay on circuit board
- 1-Year limited warranty on materials and workmanship defect
- 9-Year non-prorated extended warranty on heat exchanger, burners, and flue collection box assembly
- 4-Year non-prorated warranty on electrical and mechanical operating components (with the exception of blower belts)



UDAP V3® Power-Vent Low-Static Axial Fan Unit Heaters

Part #	Model #	Gas Type	Input/Output BTUH	Efficiency	Max CFM	Vent Dia	Blower/Fan Dia	Dimensions H x W x D	Ship Weight
36579	UDAP30	NG	30,000/24,600	82%	456	4"	10"	12-1/8" x 26-5/8" x 26"	61 lbs
38401	UDAP45	NG	45,000/37,350	83%	629	4"	10"	12-1/8" x 26-5/8" x 26"	66 lbs
40609	UDAP60	NG	60,000/49,800	83%	769	4"	12"	15-1/8" x 26-5/8" x 27"	74 lbs
37294	UDAP75	NG	75,000/62,250	83%	961	4"	12"	15-1/8" x 26-5/8" x 27-5/8"	79 lbs
34686	UDAP100	NG	105,000/87,150	83%	1,345	4"	16"	23-1/8" x 26-5/8" x 28-5/8"	118 lbs
37655	UDAP125	NG	120,000/99,600	83%	1,537	4"	16"	23-1/8" x 26-5/8" x 29-3/8"	123 lbs
37660	UDAP150	NG	150,000/124,500	83%	1,921	5"	18"	20-1/8" x 38-3/16" x 42"	204 lbs
34966	UDAP175	NG	175,000/145,250	83%	2,242	5"	18"	20-1/8" x 38-3/16" x 42"	219 lbs
64255	UDAP200	NG	200,000/166,000	83%	2,562	5"	18"	20-1/8" x 38-3/16" x 42"	219 lbs
64256	UDAP225	NG	225,000/186,750	83%	2,882	5"	20"	26-1/8" x 38-3/16" x 42"	245 lbs
64257	UDAP250	NG	250,000/207,500	83%	3,202	5"	20"	26-1/8" x 38-3/16" x 42"	257 lbs
64258	UDAP300	NG	300,000/249,000	83%	3,843	6"	24"	34-1/8" x 41" x 42"	321 lbs
64259	UDAP350	NG	350,000/290,500	83%	4,483	6"	24"	34-1/8" x 41" x 42"	346 lbs
64260	UDAP400	NG	400,000/332,000	83%	5,123	6"	24"	34-1/8" x 41" x 42"	358 lbs

UDAS V3® Separated Combustion, Low-Static Unit Heaters

- Requires either CC2 vertical system or CC6 horizontal system for air inlet/outlet

Part #	Model #	Gas Type	Input/Output BTUH	Efficiency	Max CFM	Vent Dia	Combustion Air Intake	Blower/Fan Dia	Dimensions H x W x D	Ship Weight
64376	UDAS30	NG	30,000/24,600	82%	456	4"	4"	10"	12-1/8" x 26-5/8" x 26"	63 lbs
37217	UDAS45	NG	45,000/37,350	83%	629	4"	4"	10"	12-1/8" x 26-5/8" x 26"	68 lbs
36625	UDAS60	NG	60,000/49,800	83%	769	4"	4"	12"	15-1/8" x 26-5/8" x 27"	76 lbs
36626	UDAS75	NG	75,000/62,250	83%	961	4"	4"	12"	15-1/8" x 26-5/8" x 27-5/8"	81 lbs
64377	UDAS100	NG	105,000/87,150	83%	1,345	4"	4"	16"	23-1/8" x 26-5/8" x 28-5/8"	120 lbs
64346	UDAS125	NG	120,000/99,600	83%	1,537	4"	4"	16"	23-1/8" x 26-5/8" x 29-3/8"	125 lbs
64378	UDAS150	NG	150,000/124,500	83%	1,921	5"	5"	18"	20-1/8" x 38-3/16" x 42"	206 lbs
64379	UDAS175	NG	175,000/145,250	83%	2,242	5"	5"	18"	20-1/8" x 38-3/16" x 42"	221 lbs
64380	UDAS200	NG	200,000/166,000	83%	2,562	5"	5"	18"	20-1/8" x 38-3/16" x 42"	221 lbs
64384	UDAS300	NG	300,000/249,000	83%	3,843	6"	6"	24"	34-1/8" x 41" x 42"	323 lbs
64386	UDAS400	NG	400,000/332,000	83%	5,123	6"	6"	24"	34-1/8" x 41" x 42"	360 lbs

Models and Specifications are Subject to Change Without Notice

Unit Heaters

Vent Kits

- *Vertical kit includes:*
 - Complete vertical vent kit
 - Concentric adapter box assembly
 - Exhaust terminal
 - Combustion air inlet
 - Concentric adapter box bracket
 - Tube of high temperature silicone sealant
- *Horizontal kit includes:*
 - Concentric adapter box assembly
 - Screened exhaust assembly
 - Inlet guard
 - Concentric adapter box bracket



CC2 Vertical Vent Kit



Horizontal Vent Kit

Part #	Model #	Description
64264	205895-UDAS30	Vertical Vent Kit CC2 for UDAS 30 - 125
70723	205896-SDH	Vertical Vent Kit CC2 for UDAS 150 - 400
64263	211762	Horizontal Vent Kit CC6 for UDAS 30 - 125
78152	211763	Horizontal Vent Kit CC6 for UDAS 150 - 400

LP Conversion Kits



Part #	Model #	Description
88416	269835	LP Conversion Kit for Model UDAP/UDAS 30-45
87339	269836	LP Conversion Kit for Model UDAP/UDAS Size 60-75
125090	269853	LP Conversion Kit for Model UDAP/UDAS Size 100-125
130319	269838	LP Conversion Kit for Model UDAP/UDAS Size 150-175
123977	269839	LP Conversion Kit for Model UDAP/UDAS Size 200-250

Vent Caps



Part #	Model #	Size	For Use With
37293	111848	4"	CCI Standard Vent Cap for VPS VPT

Diversitech Quick Swivel Brackets

- Easy to assemble
- Holds up to 200 lbs.
- 360 degree rotation
- Powder coated steel



U-Mount



Flush Mount

Part #	Model #	Description
180543	QSW11000	U-Mount with H-Bracket, Fits UDAP/S 30-125 MBTU
180545	QSW13000	Flush Mount with H-Bracket, Fits UDAP/S 30-125 MBTU
180549	QSW15000	Flush Mount with H-Bracket, Fits UDAP/S 150-400 MBTU

Tube Heaters

Radiant Heaters

- Full input rate for elevations up to 2,000'
- Electrical: 115-1-60
- 24V Controls
- Multi-try direct spark ignition with soft lockout
- Differential air pressure switch to verify combustion air flow
- Diagnostic indicator lights (ignition circuit board)
- Operation indicator lights
 - Red light - power on
 - (1) Amber light - burner on (Model VPS)
 - (2) Amber lights - burner on hi/lo (Model VPT)
- Calcoat™ combustion chamber and 10' rolled steel heat exchanger tubes
- Compression coupling tube connections
- Wire form hangers
- 10' Aluminized steel reflectors that overlap for continuous reflector system
- Horizontal or vertical venting
- CSA Certified
- 5-Year limited warranty on box
- 10-Year limited warranty on tubes



VPS Tubular Radiant, Low Intensity, Gas-Fired Positive Pressure Single-Stage Heater

Part #	Model #	Gas Type	Input BTUH	Length Range	Recommended Mounting Height	Vent Dia	Burner Dimensions H x W x D	Burner Ship Weight
126391	VPS60-20	NG	60,000	20'	14'	4" or 6"	15-1/2" x 10" x 18-1/2"	25 lbs
126392	VPS60-30	NG	60,000	30'	14'	4" or 6"	15-1/2" x 10" x 18-1/2"	25 lbs
126393	VPS60-40	NG	60,000	40'	14'	4" or 6"	15-1/2" x 10" x 18-1/2"	25 lbs
126395	VPS80-30	NG	80,000	30'	14'	4" or 6"	15-1/2" x 10" x 18-1/2"	25 lbs
126396	VPS80-40	NG	80,000	40'	14'	4" or 6"	15-1/2" x 10" x 18-1/2"	25 lbs
126397	VPS100-30	NG	100,000	30'	16'	4" or 6"	15-1/2" x 10" x 18-1/2"	25 lbs
126398	VPS100-40	NG	100,000	40'	16'	4" or 6"	15-1/2" x 10" x 18-1/2"	25 lbs
126399	VPS100-50	NG	100,000	50'	16'	4" or 6"	15-1/2" x 10" x 18-1/2"	25 lbs
126400	VPS125-40	NG	125,000	40'	16'	4" or 6"	15-1/2" x 10" x 18-1/2"	25 lbs
126401	VPS125-50	NG	125,000	50'	16'	4" or 6"	15-1/2" x 10" x 18-1/2"	25 lbs
126415	VPS125-60	NG	125,000	60'	16'	4" or 6"	15-1/2" x 10" x 18-1/2"	25 lbs
126402	VPS150-40	NG	150,000	40'	18'	4" or 6"	15-1/2" x 10" x 18-1/2"	25 lbs
126403	VPS150-50	NG	150,000	50'	18'	4" or 6"	15-1/2" x 10" x 18-1/2"	25 lbs
126404	VPS150-60	NG	150,000	60'	18'	4" or 6"	15-1/2" x 10" x 18-1/2"	25 lbs
126405	VPS150-70	NG	150,000	70'	18'	4" or 6"	15-1/2" x 10" x 18-1/2"	25 lbs
126406	VPS170-50	NG	170,000	50'	18'	4" or 6"	15-1/2" x 10" x 18-1/2"	25 lbs
126407	VPS170-60	NG	170,000	60'	18'	4" or 6"	15-1/2" x 10" x 18-1/2"	25 lbs
126408	VPS170-70	NG	170,000	70'	18'	4" or 6"	15-1/2" x 10" x 18-1/2"	25 lbs
126409	VPS170-80	NG	170,000	80'	18'	4" or 6"	15-1/2" x 10" x 18-1/2"	25 lbs
126410	VPS200-50	NG	200,000	50'	20'	4" or 6"	15-1/2" x 10" x 18-1/2"	25 lbs
126411	VPS200-60	NG	200,000	60'	20'	4" or 6"	15-1/2" x 10" x 18-1/2"	25 lbs
126412	VPS200-70	NG	200,000	70'	20'	4" or 6"	15-1/2" x 10" x 18-1/2"	25 lbs
126413	VPS200-80	NG	200,000	80'	20'	4" or 6"	15-1/2" x 10" x 18-1/2"	25 lbs

Tube Heaters

VPT Tubular Radiant, Low Intensity, Gas-Fired Positive Pressure Two-Stage Heaters

Part #	Model #	Gas Type	Input BTU High - Low	Length Range	Recommended Mounting Height	Vent Dia	Burner Dimensions H x W x D	Burner Ship Weight
126417	VPT60-30	NG	45,000 - 60,000	30'	14'	4" or 6"	16-1/2" x 10" x 18-1/2"	29 lbs
126418	VPT60-40	NG	45,000 - 60,000	40'	14'	4" or 6"	16-1/2" x 10" x 18-1/2"	29 lbs
126419	VPT80-30	NG	60,000 - 80,000	30'	14'	4" or 6"	16-1/2" x 10" x 18-1/2"	29 lbs
126420	VPT80-40	NG	60,000 - 80,000	40'	14'	4" or 6"	16-1/2" x 10" x 18-1/2"	29 lbs
126421	VPT100-30	NG	65,000 - 100,000	30'	16'	4" or 6"	16-1/2" x 10" x 18-1/2"	29 lbs
126422	VPT100-40	NG	65,000 - 100,000	40'	16'	4" or 6"	16-1/2" x 10" x 18-1/2"	29 lbs
126414	VPT125-30	NG	95,000 - 125,000	30'	16'	4" or 6"	16-1/2" x 10" x 18-1/2"	29 lbs
126424	VPT125-40	NG	95,000 - 125,000	40'	16'	4" or 6"	16-1/2" x 10" x 18-1/2"	29 lbs
126425	VPT125-50	NG	95,000 - 125,000	50'	16'	4" or 6"	16-1/2" x 10" x 18-1/2"	29 lbs
126426	VPT150-40	NG	100,000 - 150,000	40'	18'	4" or 6"	16-1/2" x 10" x 18-1/2"	29 lbs
126427	VPT150-50	NG	100,000 - 150,000	50'	18'	4" or 6"	16-1/2" x 10" x 18-1/2"	29 lbs
126428	VPT150-60	NG	100,000 - 150,000	60'	18'	4" or 6"	16-1/2" x 10" x 18-1/2"	29 lbs
126429	VPT170-50	NG	125,000 - 170,000	50'	18'	4" or 6"	16-1/2" x 10" x 18-1/2"	29 lbs
126430	VPT170-60	NG	125,000 - 170,000	60'	18'	4" or 6"	16-1/2" x 10" x 18-1/2"	29 lbs
126431	VPT170-70	NG	125,000 - 170,000	70'	18'	4" or 6"	16-1/2" x 10" x 18-1/2"	29 lbs
126432	VPT200-50	NG	150,000 - 200,000	50'	20'	4" or 6"	16-1/2" x 10" x 18-1/2"	29 lbs
126433	VPT200-60	NG	150,000 - 200,000	60'	20'	4" or 6"	16-1/2" x 10" x 18-1/2"	29 lbs
126434	VPT200-70	NG	150,000 - 200,000	70'	20'	4" or 6"	16-1/2" x 10" x 18-1/2"	29 lbs

VP Tube Packages (Tube Only)

- Options: - 10' Calcoat™ combustion chamber(s) - 5' and 10' Rolled steel heat exchanger(s) - 5' and 10' Reflectors
- Tube coupler(s) - Reflector support bracket assemblies - Suspension bracket(s)

Part #	Model #	Package Includes
124703	VP-A	(1) 10' Calcoat™ Chamber, (1) 10' Rolled Steel Heat Exchanger, (2) 10' Reflectors, (1) Tube Coupler, (2) Suspension Brackets, (2) Reflector Support Brackets
124704	VP-B	(1) 10' Calcoat™ Chamber, (2) 10' Rolled Steel Heat Exchangers, (3) 10' Reflectors, (2) Tube Couplers, (3) Suspension Brackets, (3) Reflector Support Brackets
124705	VP-C	(2) 10' Calcoat™ Chambers, (1) 10' Rolled Steel Heat Exchangers, (3) 10' Reflectors, (2) Tube Couplers, (3) Suspension Brackets, (3) Reflector Support Brackets
124706	VP-D	(2) 10' Rolled Steel Heat Exchangers, (2) 10' Reflectors, (2) Tube Couplers, (2) Suspension Brackets, (2) Reflector Support Brackets
124707	VP-E	(3) 10' Rolled Steel Heat Exchangers, (3) 10' Reflectors, (3) Tube Couplers, (3) Suspension Brackets, (3) Reflector Support Brackets
124708	VP-H	(1) 5' Rolled Steel Heat Exchanger, (1) 5' Reflector, (1) Tube Coupler, (1) Suspension Bracket, (1) Reflector Support Bracket
124709	VP-U	(1) Rolled Steel "U" Tube, (2) Corner Reflectors, (1) Tube Coupler, (1) Suspension Bracket
124710	VP-L	(1) Rolled Steel "L" Tube, (2) Corner Reflectors, (1) Tube Coupler, (1) Suspension Bracket

Accessories

Part #	Model #	Description
124715	CK-11	Hanger Kit 50' Chain and 11 "S" Hooks

Parts

Part #	Model #	Description
185067	TB1	5' Burner Insert
172277	TB2	3' Burner Insert

SpacePak High Velocity Systems

Equipment

ESP-J Series Horizontal Fan Coil Units (Cooling/Heat Pump)

Standard Equipment

- EC Motor
- High efficiency integrated, motor/blower assembly
- Mode specific adjustable, speed control
- Heat pump compatible
- Thermal expansion valve
- Anti-frost control
- Integrated control board
- 6-Row copper/aluminum, evaporator coil
- Slide out blower
- Sweat-type refrigerant connections
- 24V Transformer
- Insulated grey cabinet
- Float switch
- Condensate trap
- Mold resistant primary drain pan
- Anti-vibration foam strips
- Chatleff fitting for easier installation



Part #	SP Model #	Product Description
176608	ESP-2430JH4	SPACEPAK ESP-2430JH4-R410
176607	ESP-3642JH4	SPACEPAK ESP-3642JH4-R410
176606	ESP-4860JH4	SPACEPAK ESP-4860JH4-R410

ESP-V Series Vertical Fan Coil Units with Float (Cooling/Heat Pump)

- Corrosion resistant cabinet with baked enamel finish, fully insulated with 1-1/2" insulation
- Six-row copper tube-aluminum fin evaporator coil
- Blower motor is factory-balanced for vibration-free operation
- Condensate drain connection in base pan for specially-designed, factory-supplied condensate drain assembly
- Factory-assembled, pre-wired control center with high and low voltage terminal blocks, blower relay and low voltage transformer
- Factory-installed anti-frost control and thermal expansion valve
- Standard factory-installed primary drain pan float switch
- Sweat type suction/liquid line connections
- All connections located on same side of unit
- Can be installed with a conventional outdoor condensing unit as long as capacity and refrigerant line connections meet SpacePak recommendations
- Shipped with Nitrogen holding charge
- Electrical 208/230-1-60



Part #	SP Model #	Product Description
192516	ESP-2430JV4M	SPACEPAK ESP-2430JV4M-R410A 2-2 1
192519	ESP-3642JV4M	SPACEPAK ESP-3642JV4M-R410A
192521	ESP-4860JV4M	SPACEPAK ESP-4860JV4M-R410A 4-5 T

SpacePak High Velocity Systems

SpacePak® Installation Components

Diagram of High Velocity Square Metal Plenum Duct - R8 Insulation Value

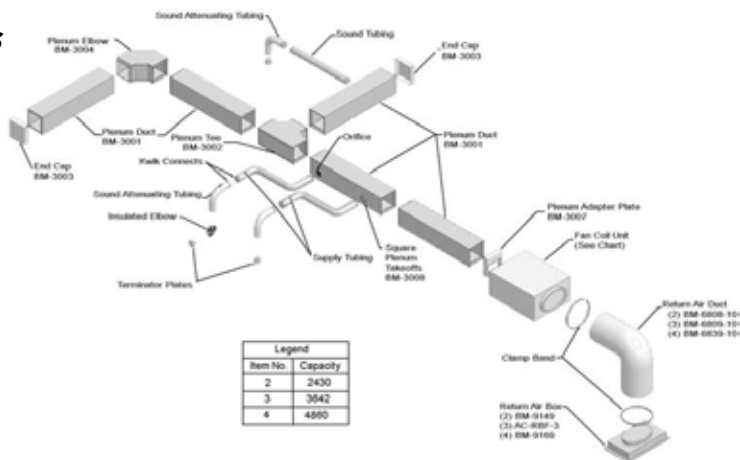

Jet Tubing and Kwik Connects

Part #	Model #	Description	Order Code
20694	AC-ST6-100	Supply Tubing 100' Roll, R-6 Insulation, 2" ID	AC-ST6-100
80325	AC-ST8-75	Supply Tubing 75' Roll, R-8 Insulation, 2" ID	AC-ST8-75
20692	BM-6818	Kiwik Connect (Sold Per piece)	SPC-38-10
41421	AC-KCWE	Kwik Connect Wall Elbow	AC-KCWE
25800	27-1130	Plenum Clip	

Square Ductboard

Part #	Model #	Description	Order Code
40008	BM-3002	Plenum Duct (4 ft lengths) 10"x10" Ductboard	SPS-T-4
40487	BM-3004	Plenum Elbow 90° 10"x10" Ductboard	SPS-90-4
40012	BM-3003	Plenum End Cap 10"x10" Ductboard	SPS-EC-10
40007	BM-3001	Plenum Tee 10"x10" Ductboard	SPS-PD-6

Plenum Adapters

Part #	Model #	Description	Order Code
40013	BM-3007	Plenum Adaptor (G Series) 10"x10" Ductboard	BM-3007
179331	AC-PAJSQ	Plenum Adaptor (J Series) 10"x10" Ductboard	SPS-PA
179302	AC-PAJ	Plenum Adaptor (J Series) 9" Round Sheetmetal	AC-PAJ

Return Air Boxes and Ducts

- Return air box includes filter grille with metal frame, permanent filter and (2) clamp bands
- Return air box is not used if PurePak Air Cleaner is installed

Part #	Model #	Description	Order Code
20799	BM-9149	2430 System Return Air Box w/Strap	BM-9159
41454	AC-RBF-3	3642 System Return Air Box w/Strap	BM-9149
20696	BM-9169	4860 System Return Air Box w/Strap	BM-9169

Direct Mount Filter Boxes "V" Series Only

Part #	Model #	Description	Order Code
36398	BM-2535	3642 Systems - all V models	SPC-4B
36399	BM-2536	4860 Systems - all V models	SPC-5B

SpacePak High Velocity Systems

Return Air Duct

- Special sound absorbing type

Part #	Model #	Description
20800	BM-6808-10	2430 System Return Air Duct (15" x 10')
24793	BM-6809-10	3642 System Return Air Duct (19" x 10')
20697	BM-6839-10	4860 System Return Air Duct (24" x 10')

Take-Off Kit

Part #	Model #	Description
40014	BM-3008	Take-Off Kit For Ductboard (1-Pack), Includes Take-off, Gasket, & Clips
43372	AC-TKFS-2	Take-Off Kit For Ductboard (2-Pack), Includes Take-off, Gasket, & Clips
43373	AC-TKFS-5	Take-Off Kit For Ductboard (5-Pack), Includes Take-off, Gasket, & Clips
40360	AC-TORD	Take-Off Kit For Round Sheetmetal (1-Pack), Includes Take-off, Gasket, & Clips
43374	AC-TKMR-2	Take-Off Kit For Round Sheetmetal (2-Pack), Includes Take-off, Gasket, & Clips
43376	AC-TKMR-5	Take-Off Kit For Round Sheetmetal (5-Pack), Includes Take-off, Gasket, & Clips

Air Control Module

- Ability to adjust supply air flow allowing for energy savings when operating in fan-only mode
- One size ACM can be used with all three SpacePak air handler sizes
- Stainless steel construction
- Insulated housing
- Mounted actuator
- Compatible with all plenum duct
- Simple plug-in wiring
- ETL Listed



Part #	Model #	Description
65209	AC-ACM	Air Control Module (G Series)
65373	AC-RMK-FACM	Remote Mount for Air Control Module

2-Outlet Installation Kit

Part #	Model #	Description
43366	AC-IKLT-2	Outlet Kit (2 Pack)
43378	BM-3020-KIT	Outlet Install Kit (2 Pack) Includes Outlet Kit and Take-Offs

5-Outlet Installation Kit

Part #	Model #	Description
43369	AC-IKLT-5	Outlet Kit (2 Pack)
43379	BM-3050-KIT	Outlet Install Kit (2 Pack) Includes Outlet Kit and Take-Offs

SpacePak High Velocity Systems

Installation Kits

Minimum and Recommended Number of Outlets		
Size	Nominal Tonnage	Recommended Outlets*
2430	2	12
2430	2½	15
3642	3	18
3642	3½	21
4860	4	24
4860	5	30

*The minimum or recommended number of outlets means fully open outlets. Any outlet having an orifice would be only a percentage of an outlet.

2-Outlet Installation Kit

- Order take-off kit separately

Part #	Model #	Description
43366	AC-IKLT-2	Space-Pak 2-Outlet Kit Includes (2) Sound Attenuators (w/Kwik Connects Installed) (2) Terminator Plates / Outlets (w/Clips & Screws) (2) Winter Supply Air Shut-Offs (1) 15% Balancing Orifice (1) 35% Balancing Orifice (1) 50% Balancing Orifice (4) Kwik Connects
43378	BM-3020-KIT	Space-Pak 2-Outlet Kit w/Take-Offs (2) Sound Attenuators (w/Kwik Connects Installed) (2) Terminator Plates / Outlets (w/Clips & Screws) (2) Winter Supply Air Shut-Offs (1) 15% Balancing Orifice (1) 35% Balancing Orifice (1) 50% Balancing Orifice (4) Kwik Connects (2) Plenum Take-Offs for Fiberglass Ductboard w/Gaskets & Clips

5-Outlet Installation Kit

- Order take-off kit separately

Part #	Model #	Description
43369	AC-IKLT-5	Space-Pak 5-Outlet Kit Includes (5) Sound Attenuators (w/Kwik Connects Installed) (5) Terminator Plates / Outlets (w/Clips & Screws) (5) Winter Supply Air Shut-Offs (2) 15% Balancing Orifices (2) 35% Balancing Orifices (2) 50% Balancing Orifices (10) Kwik Connects
43379	BM-3050-KIT	Space-Pak 5-Outlet Kit w/Take-Offs (5) Sound Attenuators (w/Kwik Connects Installed) (5) Terminator Plates / Outlets (w/Clips & Screws) (5) Winter Supply Air Shut-Offs (2) 15% Balancing Orifices (2) 35% Balancing Orifices (2) 50% Balancing Orifices (10) Kwik Connects (5) Plenum Take-Offs for Fiberglass Ductboard w/Gaskets & Clips

SpacePak High Velocity Systems

Architectural Outlet

- Install over standard white plastic terminators
- From the classic look of finished aluminum and brass, to Victorian elegance, to natural wood grain, these small, low-profile components blend seamlessly into any décor



Hole



Louvered

Part #	Model #	Outlet Type	Finish	Options
41925	AC-TRM-LS-UO	5-1/2" Dia Louvered	Oak	Surface Mount/Unfinished
41923	AC-TRM-OS-UO	5" Dia Open Hole	Oak	Surface Mount/Unfinished

PurPak™ Air Cleaning

PurePak™ Recessed Air Cleaner

- 97% Capture efficiency of contaminants down to .3 microns
- Safe, doesn't create ozone
- Filters with activated carbon center screens
- 5-Year powerhead warranty



Part #	Model #	Description
43997	AC-RBC-2	PurePak Recessed Air Cleaner 2430 All systems
43998	AC-RBC-3	PurePak Recessed Air Cleaner 3642 All systems
42841	AC-RBC-5	PurePak Recessed Air Cleaner 4860 All systems

PurePak™ Replacement Filter Media

- Activated carbon center screens



Part #	Model #	Description
43999	AC-RMED3P-2	PurePack Replacement Media 2430 All systems (14" x 25") 3-Pack
44000	AC-RMED3P-3	PurePack Replacement Media 3642 All systems (14" x 30") 3-Pack
42842	AC-RMED3P-5	PurePack Replacement Media 4860 All systems (14" x 36") 3-Pack

Tools

Part #	Model #	Description	Order Code
24801	BM-6822	Plenum Hole Cutter Ductboard	SPC-71-10
24802	BM-6898	Pliers (PTO Clip Spreader)	SPC-72

Space Heaters

Residential Gas Heaters

- Hydraulic thermostat control
- Standing pilot/Piezo ignition system
- Beige powder coated cabinet
- 10-Year limited warranty on combustion chamber
- 1-Year limited warranty on other parts

Console Vented Room Heater

- For medium to large rooms
- Add optional blower for added circulation
- Dimensions: 26" x 37" x 11-1/2"



Part #	Model #	Input BTUH	Gas Type	Ship Wt
16868	RH-25-NAT	25,000	NG	84 lbs
11530	RH-35-NAT	35,000	NG	88 lbs

Visual Flame Vented Room Heater

- Dimensions: 29-9/16" x 34" x 16"
- Includes automatic blower



Part #	Model #	Input BTUH	Gas Type	Ship Wt
13046	RH-50B-NAT	50,000	NG	124 lbs

Residential Wall Furnaces

- Beige cabinet and front panel
- Optional blower available on select models
- 10-Year limited warranty on combustion chamber
- 1-Year limited warranty on other parts

Direct Vent Wall Furnace with Vent Kit

- Millivolt wall thermostat control
- Matchless Piezo ignition system
- Includes standard vent kit through outside wall
- Dimensions: 24-7/8" x 20-1/4" x 9-3/8"



Part #	Model #	Input BTUH	Gas Type	Ship Wt
370	DV-215-SGX-NAT	15,000	NG	60 lbs

Direct Vent Wall Furnace

- Millivolt wall thermostat control
- Standing pilot/Piezo ignition system
- Dimensions: 27-1/4" x 37" x 11-1/2"



Part #	Model #	Input BTUH	Gas Type	Ship Wt
14792	DV-25-SG-NAT	25,000	NG	98 lbs
5368	DV-35-SG-NAT	35,000	NG	101 lbs

76% AFUE Direct Vent Counterflow Wall Furnace

- 24V Wall thermostat
- Standing pilot/Piezo ignition system
- DVC-35 May be recessed between standard wall studs
- Install on outside walls
- Front panels remove easily for cleaning and servicing
- DVC-35 dimensions: 72-1/2" x 14-1/8" x 10-3/8"
- DV-55 dimensions: 82-3/8" x 16" x 11-5/16"



Part #	Model #	Input BTUH	Gas Type	Ship Wt
9254	DVC-35-SPPX-NAT	35,000	NG	115 lbs
9492	DVC-55-SPPX-NAT	55,000	NG	140 lbs

76% AFUE Up-Vented Counterflow Wall Furnace

- 24V Wall thermostat control
- Standing pilot/Piezo ignition system
- FAW-40 may be recessed between standard wall studs
- Installs on inside or outside walls
- 4" Oval venting
- Front panels remove easily for cleaning and servicing
- FAW-40 Dimensions: 72-1/2" x 14-1/8" x 10-3/8"
- FAW-55 Dimensions: 82-3/8" x 16" x 11-5/16"



Part #	Model #	Input BTUH	Gas Type	Ship Wt
183222	FAW-40-SPPX	40,000	NG	110 lbs
9565	FAW-55-SPPX-NA	55,000	NG	135 lbs

Parts & Accessories

Floor Pad

Part #	Model #	Description
48549	DVP-1	36" x 14"

Single-Speed Motor for DV55-FAW55

Part #	Model #	Description
49703	R-619	2-Wire

Automatic Blower with Cord and Plug

Part #	Model #	Description
15847	DVB-1	DV-215
16067	DRB-1	DV-25 and DV-35

Vent Kit

Part #	Model #	Description
38177	DV600	DV55 and DV60

"Thru-the-Wall" Package Units

R-410A Heating & Cooling Packaged Units

- R-410A high efficiency compressor
- 80% AFUE serpentine design heat exchanger
- EER @ 82°=11.0, EER @ 95°=9.0
- Direct spark ignition
- Easy, reachable access ports
- Completely pre-charged and pre-wired
- Slide out chassis
- Totally polarized Molex electrical plug connections on cooling chassis
- Supplied with pre-painted stamped exterior grille
- Must be mounted a minimum of 8" above finished floor
- Includes 16" x 25" disposable filter
- 10-Year warranty on heat exchanger
- 5-Year warranty on compressor
- 5-Year warranty on parts

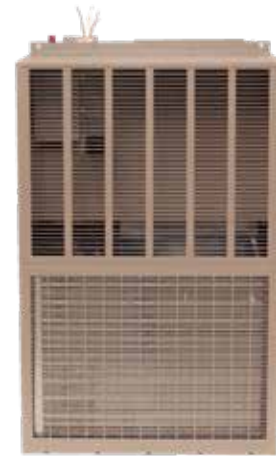

CPG C-Model Thru-the-Wall Comfort Pack Gas Heat/Electric Cooling

Part #	Model #	Tons	Nom Cool/Heat BTUH	Electrical	Dimensions H x W x D	Ship Wt
188539	CPG41838-U	1.5	18,000/38,000	208/230-1-60	43" x 28" x 31-7/16"	325 lbs
79167	CPG41851-C	1.5	18,000/51,000	208/230-1-60	43" x 28" x 31-7/16"	325 lbs
79169	CPG42438-C	2	24,000/38,000	208/230-1-60	43" x 28" x 31-7/16"	350 lbs
79170	CPG42451-C	2	24,000/51,000	208/230-1-60	43" x 28" x 31-7/16"	350 lbs
79171	CPG42464-U	2	24,000/64,000	208/230-1-60	43" x 28" x 31-7/16"	350 lbs
79172	CPG43051-C	2.5	27,400/51,000	208/230-1-60	43" x 28" x 31-7/16"	360 lbs
79173	CPG43064-C	2.5	27,400/64,000	208/230-1-60	43" x 28" x 31-7/16"	360 lbs

CPE C-Model Thru-the-Wall Comfort Pack Electric Heat/Electric Cooling

Part #	Model #	Tons	Nom Cool/Heat BTUH	Electrical	Dimensions H x W x D	Ship Wt
81947	CPE41815-C	1.5	18,000/51,182	208/230-1-60	43" x 28" x 31-7/16"	325 lbs
80822	CPE42410-C	2	23,600/23,600	208/230-1-60	43" x 28" x 31-7/16"	350 lbs
79876	CPE42415-C	2	23,600/51,182	208/230-1-60	43" x 28" x 31-7/16"	350 lbs

Optional Accessories



Part #	Model #	Description	Use With
79885	CPWS	Wall Sleeve (Unassembled)	Comfort Pack

“Thru-the-Wall” Package Units

NCPE Series 12 SEER Thru-the-Wall Air Conditioners

- Heavy-duty, water-resistant cabinet
- R-410A High efficiency compressor
- Easy access to blower and control box
- Long-life blower motor
- High-efficiency condenser coil
- Brass service valves



Series 1000



Series 3000

NCPE Series 1000 12 SEER Thru-the-Wall Air Conditioner

Part #	Model #	Tons	Nom Cooling BTUH	Electrical	Line Sets Liq, Suc	Dimensions H x W x D	Ship Wt
79706	NCPE-418-1010	1.5	18,000	208/230-1-60	3/8", 3/4"	28-5/8" x 26-1/4" x 18-1/2"	180 lbs
79369	NCPE-424-1010	2	24,000	208/230-1-60	3/8", 3/4"	28-5/8" x 26-1/4" x 18-1/2"	180 lbs
79708	NCPE-430-1010	2.5	27,200	208/230-1-60	3/8", 3/4"	28-5/8" x 26-1/4" x 18-1/2"	180 lbs

NCPD Series 3000 12 SEER Thru-the-Wall Air Conditioner

Part #	Model #	Tons	Nom Cooling BTUH	Electrical	Line Sets Liq, Suc	Dimensions H x W x D	Ship Wt
79617	NCPE-418-3010	1.5	18,000	208/230-1-60	3/8", 3/4"	32" x 24-1/8" x 18-1/2"	180 lbs
79709	NCPE-424-3010	2	24,000	208/230-1-60	3/8", 3/4"	32" x 24-1/8" x 18-1/2"	180 lbs
79710	NCPE-430-3010	2.5	27,200	208/230-1-60	3/8", 3/4"	32" x 24-1/8" x 18-1/2"	180 lbs



A MUNCH'S SUPPLY COMPANY

WE ARE A FULL LINE WHOLESALER.

For products not shown in this catalog,
contact us for complete information.

VRF

Moving refrigerant - not air

Ingersoll Rand VRF systems move heated or cooled refrigerant through the interior of a building using small diameter pipes. The refrigerant passes through coils in each room being served by a system; fans or blowers move air past the heated or cooled coils, warming or cooling the room.

More installation options

Ingersoll Rand VRF systems can fit in a wider variety of buildings.

Smaller footprint, no ductwork

With smaller equipment size and refrigerant pipes instead of ductwork, Ingersoll Rand VRF systems take up much less space than forced-air systems—a benefit that's especially important in existing structures.

More individual control

Ingersoll Rand VRF systems offer exceptional individual control with available simultaneous heating and cooling of different rooms in the same building.

More efficiency

With up to 38 IEER/34 SCHE efficiency ratings, an Ingersoll Rand VRF system can save more on energy costs than most other VRF systems.

Quiet operation

With sound levels as low as 23 dBA, quiet Ingersoll Rand VRF systems can improve the comfort and productivity of building occupants.

360-foot maximum pipe length

This maximum length exceeds the limitations of many competing systems; in many installations, an Ingersoll Rand VRF system can occupy the rooftop instead of a mid-floor's mechanical room, freeing up valuable interior floor space.

Outdoor Units

Single phase heat pumps
3-5 ton capacity and up to 9 indoor heads

Three phase heat pumps
6-44 ton capacity and up to 64 indoor heads

Three phase heat recovery units
6-44 tons and up to 64 indoor heads

Indoor Units

High wall air handler from 7,500-24,000

Slim one-way cassettes from 7,500-12,000

Min-4-way cassettes from 9,500-20,000

4-way cassettes from 9,500-48,000

Ceiling suspended units from 18,000-24,000

Concealed ducted units from 7,500-96,000

Multi-position ducted air handlers from 9,500-60,000

Multiple Control Options

- Zone level (individual indoor units)
- Building level (multiple VRF Systems)
- Centralized level (up to 256 total indoor units, up to 16 groups)
- Integrated building level (for control by building managers/owners)

VRF Support the Tommark Way

When you work with our Commercial design team, you receive full project management support.

Pre-sale

- Plan and spec quote (take off from print)
- Design build (phone and jobsite consultation)
- Sales presentation assistance
- Provide all required submittals

After the job is awarded

- Order equipment
- Contractor training from our factory certified trainer two days either at IR factory or at Munch training center
- Initial jobsite visit walk-thru to compare conditions to the print
- Produce piping and wiring diagrams

After the job starts

- One hour training review prior to construction with installers at jobsite or shop
- Review proper pipe installation
- Review job specific piping and wiring diagrams
- Review job specific equipment and installation manuals

Jobsite visits during construction

- Verify proper installation and answer questions before piping is concealed

After the job is installed

- Start-up and commissioning
- Contractor and building owner training



Manufactured Housing

Single Stage, Non-Communicating, PSC Blower, Manufactured Housing Furnace

- Zero clearance feature - allows these furnaces to be installed where space is a premium
- Fits standard manufactured housing space for ease of installation
- Built-in coil cabinet - provides ease of installation and highly efficient operating performance
- Air conditioner ready DGAA - models have blowers capable of handling up to 4 tons of air conditioning
- Aluminized steel heat exchanger - provides efficient operation and unmatched corrosion resistance
- Universal disposal filters - clean the air and are easy to replace
- Sealed combustion - design draws in combustion air directly from outside
- All models must vent with 4000 Series Roof Jack
- All models are provided with a convertible gas valve and gas orifices for both natural and propane gas
- 1 year limited labor warranty*, 2 year parts warranty*, 10 year heat exchanger warranty*, warranty terms require registration*



DGAA Series - Downflow

Part #	Model #	Input	Output	AFUE	Dimensions H x W x D
188003	DGAA056BDTD	56 MBTU	45 MBTU	80%	76" x 19.5" x 24.5"
188004	DGAA070BDTD	70 MBTU	56 MBTU	80%	76" x 19.5" x 24.5"
188005	DGAA077BDTD	77 MBTU	62 MBTU	80%	76" x 19.5" x 24.5"
188006	DGAA090BDTD	90 MBTU	72 MBTU	80%	76" x 19.5" x 24.5"

Manufactured Home Furnace Accessories

Part #	Model #	Description	
188037	4000-7121/C	MFG HOME ROOF JACK 91-102" FLOOR-FLANGE	DGAA Series M/H Furnaces
188038	4000-7141/C	MFG HOME ROOF JACK 99-120" FLOOR-FLANGE	DGAA Series M/H Furnaces
188039	4000-7151/C	MFG HOME ROOF JACK 106-132" FLOOR-FLANGE	DGAA Series M/H Furnaces
188048	7990-6261	MFG HOME DUCT CONECTR 6.5"FNDR TB5	DGAA Series M/H Furnaces
188049	7990-6281	MFG HOME DUCT CONECTR 8.5"FNDR TB5	DGAA Series M/H Furnaces
188047	S1-BOSS12503	MFG HOME ROOF JACK SEALANT	DGAA Series M/H Furnaces
188042	4000-8181/C	MFG HOME ROOF	
188043	7680B6541	MFG HOME ROOF JACK	
188044	7900A6111	MFG HOME ROOF JACK	
188045	7900A6171	MFG HOME ROOF JACK	

Manufactured Home Furnace Coils By ADP

Part #	Model #	Description	Dimensions H x W x D	Metering Dev
182117	M30E311	2.5 Ton Manufactured Home Furnace Coil	13" x 18" x 19.5"	2.5 T R410a Piston
182118	M36E221	3.0 Ton Manufactured Home Furnace Coil	15" x 18" x 19.5"	3.0 T R410a Piston
182119	M42E341	3.5 Ton Manufactured Home Furnace Coil	19" x 18" x 19.5"	3.5 T R410a Piston

TXV Kits For ADP MH Coils

Part #	Model #	Description
36592	650264-01	1.5 to 3.0 Ton AC TXV For R410a
36591	650264-00	3.5 to 5.0 Ton AC TXV For R410a
57103	656166-01	1.5 to 3.0 Ton HP TXV For R410a
56433	656166-02	1.5 to 3.0 Ton HP TXV For R410a

Mini-Splits

Mini-Split Single Zone System, Single-Phase, 3/4-3 Tons

Up to 38 SEER, R-410A, Single Zone Mini-Split System HP

Part #	Model #	Unit	SEER	Line Set	Rated Output	Low Amb Cooling	Low Amb Heating Output
188529	4MXW3809A10NUA	Indoor	38.0	1/4" x 1/2"	9,000 C	0°F	11,900 @ 0° F 11,800 @ -4° F
188530	4TXK3809A10NUA	Outdoor	38.0	100' max	9,000 H	0°F	9,200 @ -13° F 8,200 @ -22° F
189308	4MXW3812A10NUA	Indoor	30.5	1/4" x 1/2"	12,000 C	0°F	12,200 @ 0° F 12,200 @ -4° F
189306	4TXK3812A10NUA	Outdoor	30.5	100' max	12,200 H	0°F	9,700 @ -13° F 8,500 @ -22° F
185978	4MXW3818A10NUA	Indoor	24.5	1/4" x 5/8"	18,000 C	0°F	18,200 @ 0° F 17,300 @ -4° F
185981	4TXK3818A10NUA	Outdoor	24.5	100' max	18,000 H	0°F	13,400 @ -13° F 10,000 @ -22° F
189527	4MXW3824A10NUA	Indoor	21.5	1/4" x 5/8"	22,000 C	0°F	24,000 @ 0° F 23,200 @ -4° F
189526	4TXK3824A10NUA	Outdoor	21.5	100' max	24,000 H	0°F	18,700 @ -13° F 14,100 @ -22° F

Does not include controller.

Up to 22 SEER, R-410A, Single Zone Mini-Split System HP

Part #	Model #	Unit	SEER	Line Set	Rated Output	Low Amb Cooling	Low Amb Heating Output
139923	4MXW8509A10NOC	Indoor	22.0	1/4" x 3/8"	9,000 C	0°F	5,500 @ 17° F
83890	4TXK8509A10NOB	Outdoor	22.0	100' max	9,800 H	0 F	7,400 @ 5° F
139924	4MXW8512A10NOC	Indoor	20.0	1/4" x 3/8"	12,000 C	0°F	7,600 @ 17° F
164671	4TXK8512A10NOC	Outdoor	20.0	100' max	13,000 H	0°F	8,500 @ 5° F
139926	4MXW8518A10NOC	Indoor	18.0	1/4" x 1/2"	18,000 C	0°F	12,700 @ 17° F
164670	4TXK8518A10NOC	Outdoor	18.0	130' max	19,800 H	0°F	13,600 @ 5° F
139927	4MXW8524A10NOC	Indoor	18.0	1/4" x 5/8"	21,400 C	0°F	15,000 @ 17° F
160468	4TXK8524A10NOC	Outdoor	18.0	130' max	23,000 H	0°F	14,400 @ 5° F
139928	4MXW8536A10NOC	Indoor	16.0	1/4" x 5/8"	33,600 C	0°F	20,600 @ 17° F
160212	4TXK8536A10NOC	Outdoor	16.0	130' max	34,600 H	0°F	17,600 @ 5° F

Does not include controller.

16 SEER, R-410A, Single Zone Mini-Split System HP

Part #	Model #	Unit	SEER	Line Set	Rated Output	Low Amb Cooling	Low Amb Heating Output
180205	4MXW1609A10NOA	Indoor	16.0	1/4" x 3/8"	9,000 C	0°F	5,600 @ 5° F
180201	4TXK1609A10NOA	Outdoor	16.0	100' max	9,500 H	0°F	4,900 @ -4° F
180206	4MXW1612A10NOA	Indoor	16.0	1/4" x 3/8"	12,000 C	0°F	7,700 @ 5° F
180202	4TXK1612A10NOA	Outdoor	16.0	100' max	13,000 H	0°F	6,800 @ -4° F
180207	4MXW1618A10NOA	Indoor	16.0	1/4" x 1/2"	18,000 C	0°F	11,400 @ 5° F
180203	4TXK1618A10NOA	Outdoor	16.0	130' max	19,000 H	0°F	10,100 @ -4° F
180208	4MXW1624A10NOA	Indoor	16.0	1/4" x 5/8"	22,000 C	0°F	13,200 @ 5° F
180204	4TXK1624A10NOA	Outdoor	16.0	130' max	23,000 H	0°F	11,600 @ -4° F

Does not include controller.

Mini-Splits

Ductless Single Zone System, Single-Phase, 3/4-3 Tons



Features	4TXK38 Single Zone Up to 38 SEER	4TXK85 Single Zone HP Up to 22 SEER	4TXK16 Single Zone HP 16 SEER
R-410A refrigerant	✓	✓	✓
Charged for 25'	✓	✓	✓
Voltage 230/208V	✓	✓	✓
Nominal capacity 9-24 MBH	✓	-	✓
Nominal capacity 9-36 MBH	-	✓	-
Cooling efficiency 16 SEER	-	-	✓
Cooling efficiency range 16-22 SEER	-	✓	-
Cooling efficiency range up to 38 SEER	✓	-	-
Heating efficiency range 8.2-15 HSPF	✓	✓	✓
Heat Pump	✓	✓	✓
Crankcase heater	✓	-	✓
Pan heater	✓	-	✓
Low sound level	✓	✓	✓
Blue fin anti-corrosion treatment	✓	✓	✓
Energy Star qualified	✓	-	-
ETL and AHRI listed	✓	✓	✓
Sleep mode function	✓	✓	✓
Memory reset function	✓	✓	✓
Low ambient cooling to 0°F	✓	✓	✓
Low ambient heating to -4°F	✓	-	✓
Low ambient heating to -22°F	✓	-	-
Improved air quality with active carbon and catechin filters	✓	✓	✓
10-Year registered limited warranty on all other functional parts (residential use)	✓	✓	✓
Warranty terms require registration within 60 days of installation; Extended warranties available	✓	✓	✓

American Standard Accessories

Optional Indoor Unit Accessories					
Part #	Model #	Description	4MXW38 Single-Zone Indoor Up to 38 SEER	4MXW85 Single-Zone Indoor Up to 22 SEER	4MXW16 Single-Zone Indoor 16 SEER
160099	AREMOTE2AHANDAA	Wireless Controller	✓	✓	✓

Trane Accessories

144137	TREMOTE2AHANDAA	Wireless Controller	✓	✓	✓
138044	TREWIRE1AHANDAA	Wired Controller (not compatible with 4MXW85 14th digit B models)	✓	✓	✓
192793	TREPROG2AHANDAA	Programmable wired controller	✓	✓	✓

Mini-Splits

Ductless Multi-Zone System, Single-Phase, 1½-3½ Tons

16 SEER Multi-Zone System HP Outdoor Unit



Part #	Model #	Capacity Class	Low Amb	Min/Max ID Units	Charged For	Max Total Piping	Piping Connections	
							Liq	Gas
182005	4TXM6518A1020C	18,000	0°F	1/2	66'	66'	2 x 1/4"	2 x 3/8"
182006	4TXM6524A1030C	24,000	0°F	2/3	98'	230'	3 x 1/4"	3 x 3/8"
192674	4TXM6530A1040B	30,000	0°F	2/4	100'	230'	4 x 1/4"	4 x 3/8"
182007	4TXM6536A1040C	36,000	0°F	2/4	130'	230'	3 x 1/4" 1 x 3/8"	2 x 3/8" 1 x 1/2" 1 x 5/8"
182008	4TXM6542A1050C	42,000	0°F	2/5	165'	230'	4 x 1/4" 1 x 3/8"	2 x 3/8" 2 x 1/2" 1 x 5/8"

Does not include controller

Multi-Zone, High Wall System HP

Part #	Model #	SEER	Capacity Class	Style	Size (W x D x H)	Piping Connections	
						Liq	Gas
139923	4MXW8509A10NOC	18+	9,000	Std Wall Mount	33.3" x 7.1" x 10.8"	1/4"	3/8"
139924	4MXW8512A10NOC	18+	12,000	Std Wall Mount	33.3" x 7.1" x 10.8"	1/4"	3/8"
139926	4MXW8518A10NOC	18+	18,000	Std Wall Mount	37" x 7.9" x 11.7"	1/4"	1/2"
139927	4MXW8524A10NOC	18+	24,000	Std Wall Mount	39.6" x 8.6" x 12.4"	1/4"	5/8"

Does not include controller

Mini-Splits

Ductless Multi-Zone System, Single-Phase, 1½-3½ Tons



Features	4TXM65 Multi Zone 16 SEER
R-410A refrigerant	✓
Voltage 208/230V	-
Flexibility to accommodate to different applications	✓
Connect up to 5 indoor units to a single condensing unit	✓
Nominal capacity 18-42 MBH	✓
Cooling efficiency of 16 SEER	✓
Heating efficiency of 8.2 HSPF	✓
Heat Pump	✓
Low sound level	✓
Blue fin anti-corrosion treatment	✓
ETL and AHRI listed	✓
Sleep mode function	✓
Memory reset function	✓
Low ambient cooling to 0°F	✓
Low ambient heating to 5°F	✓
Improved air quality with active carbon and catechin filters	✓
10-Year registered limited warranty on all other functional parts (residential use)	✓
Warranty terms require registration within 60 days of installation; Extended warranties available	✓

American Standard Accessories

Optional Indoor Unit Accessories				
Part #	Model #	Description	4MXW85 Multi Zone Indoor Up to 22 SEER	4MXC85 Multi Zone Indoor Up to 22 SEER
160099	AREMOTE2AHANDAA	Wireless Controller	✓	✓

Trane Accessories

144137	TREMOTE2AHANDAA	Wireless Controller	✓	✓
138044	TREWIRE1AHANDAA	Wired Controller (not compatible with 4MXW85 14th digit B models)	✓	✓
192793	TREPROG2AHANDAA	Programmable wired controller	✓	✓

Mini-Splits

R-410A Multi-Zone System Cassette HP Single-Phase

- Quiet design - specially designed air vent efficiently reduces operation noise, as low as 26 dB
- Built-in drain pump to easily drain condensation from the unit
- Compact design and simple construction make the cassette model easy to install and maintain
- Washable filter rescues moisture on filter and provides fresh, healthy air into the room, clean filter regularly with water
- 208/230-1-60
- Remote sold separately
- 5-Year limited warranty on all other functional parts (with registration, residential use)
- Extended warranties available



Part #	Model #	Nom Cap Cooling BTUH	Uncrated Dimensions H x W x D	Approx Ship Wt	Sound Power Level	Sound Pressure Level*	Line Sets OD Gas, Liq
128581	4MXC8512A10N0A	12,000	9.1" x 22.4" x 22.4"	50.7 lbs	47 - 56	37 - 46	3/8", 1/4"
128733	4MXC8518A10N0A	14,400	9.1" x 22.4" x 22.4"	50.7 lbs	47 - 56	37 - 46	1/2", 1/4"
128734	4MXC8524A10N0A	22,800	9.5" x 33.1" x 33.1"	83.8 lbs	45 - 49	35 - 39	5/8", 3/8"

*Requires Face Plate (not included).

Cassette Covers

Part #	Model #	For Use With Models:
128735	4MXL8518A10N0A	Face Plate for 4MXC8512 and 4MXC8518
128736	4MXL8524A10N0A	Face Plate for 4MXC8524

American Standard Ductless Remote

Part #	Model #	Description
160099	AREMOTE2AHANDAA	Remote Control for Split System Units

Trane Ductless Remote

Part #	Model #	Description
144137	TREMOTE2AHANDAA	Remote Control for Split System Units



QUALITY. SERVICE. TOMMARK.

Mini-Splits

Ameristar 22 SEER, R-410A, Single Zone Mini-Split System HP

- 115V
- Charged for 25' of lineset
- Indoor remote control included with indoor unit
- Registered warranty - 10-year parts and 10-year compressor



Part #	Model #	Unit	Line Set	Rated Output	Low Amb Cooling	Low Amb* Heating Output
191394	M4MHW2209A9N0A	Indoor	1/4" x 3/8"	9,000 C	0°	5,500 @ 0° F
191392	M4THS2209A91NA	Outdoor	49' max	9,500 H	0°	5,100 @ -4° F
191395	M4MHW2212A9N0A	Indoor	1/4" x 3/8"	12,000 C	0°	7,300 @ 0° F
191393	M4THS2212A91NA	Outdoor	66' max	13,000 H	0°	6,800 @ -4° F

*Heating output at 65°F DB; see specification guide for details.

Ameristar 15 SEER, R-410A, Single Zone Mini-Split System HP

- 208/230V
- Charged for 25' of lineset
- Indoor remote control included with indoor unit
- Registered warranty - 10-year parts and 10-year compressor



Part #	Model #	Unit	Line Set	Rated Output	Low Amb Cooling	Low Amb Heating Output
191400	M4MHW1509A1N0A	Indoor	1/4" x 3/8"	9,000 C	0°F	7,650 @ 32°F, 5,850 @ 10° F
191396	M4THS1509A11NA	Outdoor	100' max	9,500 H	0°F	5,300 @ 0°F, 4,900 @ -4° F
191401	M4MHW1512A1N0A	Indoor	1/4" x 3/8"	12,000 C	0°F	10,550 @ 32°F, 8,100 @ 10° F
191397	M4THS1512A11NA	Outdoor	100' max	13,000 H	0°F	7,350 @ 0°F, 6,800 @ -4° F
191402	M4MHW1518A1N0A	Indoor	1/4" x 1/2"	18,000 C	0°F	17,100 @ 32°F, 13,200 @ 10° F
191398	M4THS1518A11NA	Outdoor	130' max	19,000 H	0°F	11,600 @ 0°F, 10,200 @ -4° F
191403	M4MHW1524A1N0A	Indoor	1/4" x 5/8"	22,000 C	0°F	19,300 @ 32°F, 15,000 @ 10° F
191399	M4THS1524A11NA	Outdoor	130' Max	23,000 H	0°F	12,750 @ 0°F, 11,750 @ -4° F



A MUNCH'S SUPPLY COMPANY

6 CONVENIENT LOCATIONS

ANN ARBOR

141 Jackson Industrial
Ann Arbor, MI 48103
P (800) 665-1452
F (734) 665-0679
M-F: 7:30 a.m. – 4:30 p.m.

COLDWATER

36 Mill Street
Coldwater, MI 49036
P (800) 922-5180
F (517) 279-7350
M-F: 7:30 a.m. – 4:30 p.m.

GRAND RAPIDS

130 Graham S.W.
Grand Rapids, MI 49503
P (800) 541-1144
F (616) 247-0283
M-F: 7:30 a.m. – 4:30 p.m.

JACKSON

1021 Belden Road
Jackson, MI 49203
P (800) 333-8005
F (517) 782-1155
M-F: 7:30 a.m. – 4:30 p.m.

LANSING

1115 S. Pennsylvania
Lansing, MI 48912
P (800) 487-4836
F (517) 487-1119
M-F: 7:30 a.m. – 4:30 p.m.

SAGINAW

219 Atwater
Saginaw, MI 48601
P (800) 292-0233
F (989) 754-4241
M-F: 7:30 a.m. – 4:30 p.m.

Ductless Installation Accessories

Equipment Pads

Ultralite® Lightweight Equipment Pad

- Concrete pad at weight of plastic
- EPS Core prevents warping and provides solid bottom to resist settling
- Vibration-absorbing
- Freeze/thaw resistant
- Limited lifetime warranty



Part #	Model #	Size
51738	UC 1636-2	16" x 36" x 2"

E-Lite® Plastic Equipment Pad

- Molded with size label and symbol representing content of recycled material
- Rounded edges and concrete gray color
- Limited lifetime warranty



Part #	Model #	Size
51739	EL1838-3	18" x 38" x 3"
192847	EL2448-3	24" x 48" x 3"

Disconnects

Pull-Out Disconnect Switch

- Side opening door
- Line, load, and ground terminals aligned
- Reversible door
- Full dead front
- Fused models have indicator lights for blown fuses
- UL Listed IRF9, NEMA Type 3R



DDS-60



DDS-60U

Part #	Model #	Description
79789	DDS-60	60A, Fused
78443	DDS-60U	60A, Non-Fused

A/C Whips

Whip Metallic Connector

- Liquid-tight flexible conduit system
- (3) Distinct wire colors
- (1) Straight and (1) 90° metallic connectors
- UL and cUL Listed



Part #	Description
11050	1/2" x 4', #10 THHN
9946	1/2" x 6', #10 THHN
4918	3/4" x 4', #8 THHN
23314	3/4" x 6', #8 THHN

QUALITY. SERVICE. TOMMARK.

Ductless

Ductless Installation Accessories

200 Series Standard Switched Cross

SmartTrap™ Kit

- Float switch overflow protection
- Clear cleanable trap
- Includes:
 - 3/4" Standard trap
 - 3/4" Cross
 - 3/4" Red cap
 - 1" x 3/4" Bushing
 - 3/4" Tee
 - 3/4" Black stub
 - 3/4" Male adapter
 - Float switch assembly
 - 48" Cable
- cULus Listed



Part #	Model #	Description
75510	EZT-210	3/4" with 1" Drop & Brush

Condensate Traps & Overflow Switches

- Easy maintenance and overflow protection
- SmartTrap™ (200 series) adds a float switch that warns of blockage and shuts down the AC unit
- Proven reliability and higher switching capacity with microswitch technology
- Transparent trap is easy to clean and easy to inspect
- Watertight red caps provide easy access to clean the trap and drain pan outlet
- Quality construction with durable sch 40 PVC fittings

EZT-626 Combination Pack Trap Kit

- Includes EZT-226:
 - (1) Float switch assembly
 - (1) Terminal cover
 - (1) 1" x 3/4" Slip street ell
 - (1) 3/4" Male threaded adapter
 - (1) 48" Cable
 - (1) Red/Blue label
- Includes EZT-113B:
 - (1) 3/4" Blow Molded EZ-Trap
 - (1) 3/4" Cross
 - (3) 3/4" Red caps
 - (1) 3/4" Tee
 - (1) Yellow cleaning label
 - (1) Cleaning brush



Part #	Model #	Description
55059	EZT-626	13B Trap Kit, ZT-226 Drain Pan Overflow Switch

UltraTrap™ Waterless Condensate Traps

- For negative and positive pressure systems up to 0.5" WG, capacity 2.7 gpm
- UltraTrap™ design retains no water and needs no priming
- Spring-assisted float eliminates standing water and freezing problems associated with conventional P-traps
- UltraTrap™ allows free flow of condensate while preventing back airflow in either direction
- Captive twist-off locking ring
- Transparent trap allows for easy cleaning and inspection
- Stainless steel spring

Ultra Waterless Trap Kit

- Waterless freeze protection
- Can be used with positive and negative pressure systems
- Includes:
 - 3/4" UltraTrap™
 - 3/4" Cross
 - 3/4" Male adapter
 - (2) 3/4" Red caps
 - 3/4" Coupler
 - Cleaning brush



Part #	Model #	Description
55057	EZT-150	Fits 3/4" or 1" Diameter

Wall Sleeves

- Used to provide a seal when penetrating walls



Part #	Model #	Description
162419	83017	NFP-75, 3" OD x 5" - 7-3/4" Telescoping



EZ Trap® Condensate Traps & Overflow Switches

100 Series ClearTrap™ Economy Trap Kit

- EZ Trap® Condensate Traps & Overflow Switches 100 Series ClearTrap™ Economy Trap Kit
- Includes:
 - 3/4" Trap
 - 3/4" Cross
 - 3/4" Tee
 - (3) 3/4" Red caps



Part #	Model #	Description
55056	EZT-113	3/4" with 1" Drop less Brush
75509	EZT-113B	3/4" with 1" Drop with Brush

Ductless Installation Accessories

Safety Switches

Safe-T-Switch® SS610E Electronic Condensate Overflow Switch

- Designed for ductless systems
- For installation directly on primary drain pan or clipped to coils above primary drain pan
- Multi-voltage
- Can be wired in both normally open and normally closed systems
- Sensor connects to indoor units
- Onboard LED indicator can be mounted to side of unit
- No batteries required
- cULus Listed



Part #	Model #	Description
170123	97622	SS610E Safe-T-Switch® Condensate Overflow Switch

Brass Flare Fittings

Brass Flare Coupling (Flr x Flr)

Part #	Model #	Description
130239	BRC-A42C	1/4" x 1/4"
130240	BRC-A42E	3/8" x 3/8"
130241	BRC-A42F	1/2" x 1/2"
130242	BRC-A42I	5/8" x 5/8"

Brass Flare Nut



Part #	Model #	Description
14274	BRC-A41C	1/4"
19744	BRC-A41E	3/8"
129817	BRC-A41F	1/2"
129818	BRC-A41I	5/8"

Thermostat Wire



Part #	Wire	Gauge	Length
57711	4 Stranded & Shielded	18 ga	50'

Ductless Cable

- Operating voltage: 600V
- UL Listed



Part #	AWG Cond	Length
79490	14/4	50'
126484	14/4	250'
161567	16/2	50'

Mounting Brackets

Mini-Split Condensor Wall Bracket

- Includes:
 - Attached level for accurate and easy mounting
 - (4) Sets of anchoring bolt screws
 - (4) Sets of anti-vibration rubber pads
- Maximum load: 450 lbs



Part #	Model #	Description
160844	MA-SB35	18" x 33-1/2" x 24"
180552	QSMS1201	Quick-Sling Mini Split Stad 12" Tall
180554	QSMS1801	Quick-Sling Mini Split Stad 18" Tall

Bolts

Anchor Bolt



Part #	Model #	Description
15038	ACB-AB	Anchor Bolt, Long Sleeve

Drain Hose & Accessories

Standard Drain Hose

- Non-insulated



Part #	Model #	Description
44681	DH16	5/8" x 164'
126667	DH16S	5/8" x 20'

Ductless Installation Accessories

Clear Vinyl Tubing

- Clear, tough, flexible tubing
- Nominal wall thickness: 1/16"
- Good for A/C condensate drains



Part #	Model #	Description
6865	5162	5/8" ID x 100' Roll

Mini-Split Line Set with 3/8" Insulation (Flare End)

- Flared ends with nuts
- Both lines insulated
- Standard insulation



Part #	Liquid Line	Suction Line	Length
55386	1/4"	3/8"	25'
50592	1/4"	3/8"	35'
51018	1/4"	3/8"	50'
64579	1/4"	1/2"	25'
50595	1/4"	1/2"	35'
50596	1/4"	1/2"	50'
126503	1/4"	5/8"	25'
51024	1/4"	5/8"	35'
51026	1/4"	5/8"	50'
126639	3/8"	5/8"	25'
50601	3/8"	5/8"	35'
51030	3/8"	5/8"	50'

Mini-Split Line Set with 1/2" EZ-Pull Insulation

- Extra durable coated 1/2" insulation
- Both lines insulated
- Flared ends with nuts

Part #	Item
192161	1/4" x 1/2" x 25' Lineset 1/2" EZ-Pull
192162	1/4" x 1/2" x 35' 1/2" Lineset EZ-Pull
192163	1/4" x 1/2" x 50' 1/2" Lineset EZ-Pull
192164	1/4" x 3/8" x 25' Lineset 1/2" EZ-Pull
192165	1/4" x 3/8" x 35' Lineset 1/2" EZ-Pull
192166	1/4" x 3/8" x 50' Lineset 1/2" EZ-Pull
192167	1/4" x 5/8" x 25' Lineset 1/2" EZ-Pull
192168	1/4" x 5/8" x 35' Lineset 1/2" EZ-Pull
192169	1/4" x 5/8" x 50' Lineset 1/2" EZ-Pull
192170	3/8" x 5/8" x 25' Lineset 1/2" EZ-Pull
192171	3/8" x 5/8" x 35' Lineset 1/2" EZ-Pull
192172	3/8" x 5/8" x 50' Lineset 1/2" EZ-Pull



6 CONVENIENT LOCATIONS

ANN ARBOR

141 Jackson Industrial
Ann Arbor, MI 48103
P (800) 665-1452
F (734) 665-0679
M-F: 7:30 a.m. - 4:30 p.m.

COLDWATER

36 Mill Street
Coldwater, MI 49036
P (800) 922-5180
F (517) 279-7350
M-F: 7:30 a.m. - 4:30 p.m.

GRAND RAPIDS

130 Graham S.W.
Grand Rapids, MI 49503
P (800) 541-1144
F (616) 247-0283
M-F: 7:30 a.m. - 4:30 p.m.

JACKSON

1021 Belden Road
Jackson, MI 49203
P (800) 333-8005
F (517) 782-1155
M-F: 7:30 a.m. - 4:30 p.m.

LANSING

1115 S. Pennsylvania
Lansing, MI 48912
P (800) 487-4836
F (517) 487-1119
M-F: 7:30 a.m. - 4:30 p.m.

SAGINAW

219 Atwater
Saginaw, MI 48601
P (800) 292-0233
F (989) 754-4241
M-F: 7:30 a.m. - 4:30 p.m.

Ductless Installation Accessories

Aspen Aqua Condensate Pump Kits

- Handles ductless units up to 30,000 BTUH duty cycle:
 - 50% 5 minutes on
 - 5 minutes off
- Capacity:
 - 3.2 gph @ Zero head
 - 0.8 gph @ 33' Head
- Maximum head: 33'
- Sound level: 24 dB(a)
- Suction lift: 5'
- cETL listed
- Ultra slim profile
- Fits inside evaporator or line set cover
- Integral hanging loop and separate reservoir facilitates attachment in vertical applications
- 3A NO/NC dry contacts rated @ 5A inductive at 230VAC
- Includes:
 - Pump
 - 1.5 m plug and play power cable
 - Reservoir with filter, float, and lid
 - 150 mm vinyl breather tube 6mm ID
 - Anti-siphon device
 - 1.5 m suction breather tube 6mm ID
 - 220 mm blue inlet hose 14mm ID
 - Drain connector kit
 - Fixing kit
 - Installation manual



Aspen Orange Condensate Pump Kits

- Handles ductless units up to 30,000 BTUH
- Duty cycle: continuous
- Capacity:
 - 3.2 gph @ Zero head
 - 0.8 gph @ 33' head
- Maximum head: 33'
- Noise level: 26 dB(a)
- cETL listed
- Pump installs remotely above ceiling or inside line set cover
- Pan mount or inline style reservoir options
- Modular terminals for fast connection
- Gravity inlet
- Potted electronics
- 3A NO/NC dry contacts rated @ 5A inductive at 230VAC
- Includes:
 - Pump
 - 1.5m plug and play power cable
 - Submersible reservoir lid with 1.5m sensor cable
 - Anti-siphon device
 - Float and filter
 - 1.5m suction tube 6mm ID
 - 220 mm orange inlet hose 14mm ID
 - 150 mm vinyl breather tube 6mm ID
 - Drain connector kit
 - Fixing kit
 - Installation manual



Part #	Model #	Description
67513	ASP-MA-UNI	250V, 0.07-0.13A, 16W Universal Voltage

Part #	Model #	Description
126665	ASP-MO-UNI	50V, 0.15-0.28A, 21W Universal Voltage

Ductless Installation Accessories

Aspen Lime Condensate Pump Kits

- Handles ductless units up to 30,000 BTUH
- Capacity:
 - 3.2 gph @ Zero head
 - 0.8 gph @ 33' head
- Maximum head: 33'
- Sound level: 27 dB(a)
- cETL listed
- Left or right install
- Easily accessed for filter cleaning
- (2) Line set cover styles available: Slimline or Fortress
- 3A NO/NC dry contacts rated @ 5A inductive at 230VAC
- Includes:
 - Monobloc condensate pump assembly
 - 20" x 5/8" ID inlet tube
 - 6" x 1/4" ID vinyl breather tube
 - 30" x 1/4" ID vinyl discharge tube
 - 6' Power cable assembly
 - Inline fuse
 - Line set cover elbow
 - Drain hose adapter
 - Anti-siphoning device
 - (4) Cable ties
 - Wall plugs and screws
 - Installation manual



Aspen White Condensate Pump Kits

- Handles up to 30,000 BTUH
- Surface mounts below evaporator at either end
- Crisp white color and slim profile (additional colors available)
- Resilient mounting
- Cleanable replaceable plastic filter cartridge accepts water treatment tablet
- Accepts standard 5/8" drain hose from any ductless unit
- Extra large reservoir capacity minimizes pump operation
- All components clip apart for easy disassembly without tools
- Push-in plug power cable
- No breather tube required
- No need to disturb evaporator to clean filter, reservoir clips out from front for easy removal and replacement
- 3A N/C dry contacts rated @ 5A inductive @ 230VAC
- Capacity:
 - 3.2 gph @ Zero head
 - 0.8 gph @ 33' head
- Maximum head: 33"
- Sound level 25 dB(a)
- Maximum water temperature: 104°F



Part #	Model #	Description
126666	ASP-ML-UNI	100-250V, Slimline Universal, 0.10-0.16A, 16W Line Set Cover

Part #	Model #	Description
125772	ASP-MW-UNI	-250V, .11-18A, 16W Universal Voltage

Ductless Installation Accessories

RectorSeal® NoKink™ Flexible Refrigerant Line Connector

- Kink-free connections between the refrigerant line and a wall-mount mini split evaporator
- Can be used when installing air conditioning units when connecting either the evaporator or condenser unit
- 3" Copper stubs for quick connection
- Allows for easy flaring
- Operating pressure rating: up to 800 psi
- 4/Case



Part #	Model #	Description
162414	66731	1/4" x 36"
162416	66733	3/8" x 36"
162417	66737	1/2" x 36"
162418	66735	5/8" x 36"



A MUNCH'S SUPPLY COMPANY

We are a full line wholesaler. Contact us for information about items not listed in this catalog.

Line Set Ducting System

- Perfect for mini splits, high velocity and conventional split A/C
- UV and weather resistant, strong rigid PVC
- Protects line sets, wiring and drain pipes
- Temperature range: 0° to 180°F
- Paintable



96" Length of PVC Ducting

- Includes (2) line set ducting clips

Part #	Model #	Model #	Duct Size	Color
65354	LD92W	84004	3-1/2"	White
68789	LD92B	84064	3-1/2"	Brown
65353	LD122W	84104	4-1/2"	White
66414	LD122B	84164	4-1/2"	Brown

Couplins

- Includes (2) #6 x 3/4" stainless steel screws



Part #	Model #	Model #	Duct Size	Color
65359	LJ92W	84010	3-1/2"	White
68790	LJ92B	84270	3-1/2"	Brown
65357	LJ122W	84110	4-1/2"	White

Wall Inlet

- Includes (4) #6 x 3/4" stainless steel screws



Part #	Model #	Model #	Duct Size	Color
65371	LW92W	84016	3-1/2"	White
68787	LW92B	84276	3-1/2"	Brown
65369	LW122W	84116	4-1/2"	White

Ductless Installation Accessories

Soffit Inlet

- Includes (2) #6 x 3/4" stainless steel screws



Part #	Model #	Model #	Duct Size	Color
65365	LP92W	84014	3-1/2"	White
75860	LP92B	84274	3-1/2"	Brown

45° Flat Elbow

- Includes (2) #6 x 3/4" stainless steel screws



Part #	Model #	Model #	Duct Size	Color
65363	LKF92W	84012	3-1/2"	White
76114	LKF92B	84272	3-1/2"	Brown
65362	LKF122W	84112	4-1/2"	White

End Fitting

- Includes (2) #6 x 3/4" stainless steel screws



Part #	Model #	Model #	Duct Size	Color
65356	LEN92W	84007	3-1/2"	White
68788	LEN92B	84267	3-1/2"	Brown
65355	LEN122W	84107	4-1/2"	White

90° Inside Vertical Elbow

- Includes (2) #6 x 3/4" stainless steel screws



Part #	Model #	Model #	Duct Size	Color
72957	LCI92W	84002	3-1/2"	White
67522	LCI122W	84102	4-1/2"	White

Tee

- Includes (4) #6 x 3/4" stainless steel screws



Part #	Model #	Model #	Duct Size	Color
65368	LT92W	84015	3-1/2"	White
65366	LT122W	84115	4-1/2"	White

90° Outside Vertical Elbow

- Includes (2) #6 x 3/4" stainless steel screws



Part #	Model #	Model #	Duct Size	Color
72958	LCO92W	84003	3-1/2"	White
69628	LCO122W	84103	4-1/2"	White

90° Flat Elbow

- Includes (2) #6 x 3/4" stainless steel screws



Part #	Model #	Model #	Duct Size	Color
65361	LK92W	84011	3-1/2"	White
68791	LK92B	84271	3-1/2"	Brown
65360	LK122W	84111	4-1/2"	White

**QUALITY.
SERVICE.
TOMMARK.**

Ductless Installation Accessories

Tools

45° Flare/Swage Tool Kit

- Flare: 1/8", 3/16", 1/4", 5/16", 3/8", 7/16", 1/2", 5/8" and 3/4"
- Nom flares: 1/8", 1/4", 1/2", 5/8"
- Swage: 3/16", 1/4", 5/16", 3/8", 1/2", 5/8" and 3/4"
- Nom swage: 1/8", 1/4", 3/8", 1/2", 5/8"
- Heavy-duty wide-range bar type flaring tool
- Rugged, forged steel slip-on self centering yoke has a hardened chrome plate swivel type cone to form quality flares
- Hardened bars provide positive clamping action with minimum distortion and are fully hinged with king-sized forged steel wing nuts for easy use
- Second bar extends flaring tool to 9 OD tube sizes



Part #	Model #	Description
13881	T20275	45° Flare/Swage Tool Kit

Charging Scales

Atlas Refrigerant Charging Scale

- Weight capacity: 220 lbs
- Solid state load cell, accurate to 0.25 oz
- All metal construction
- Heavy-duty plastic storage case
- Hand-held remote, auto shut-off after 30 minutes
- Large LCD screen that can be read from a distance and in direct sunlight
- Displays weight in decimal pounds, pounds and ounces, and kilograms
- Indoor/outdoor usage, not waterproof
- Operating temperature: 32° to 122°F
- Includes 9V battery
- 24-Month warranty



Part #	Model #	Description
55719	DS-20000	Refrigerant Charging Scale
190320	DS-20000S	Wireless Digital Scale with Case

ROBINAIR

Charging Scales

Robinair Refrigerant Charging Scale

- Three display models
- Auto zero
- Touch key controls
- Portable
- 2-Year warranty



Part #	Model #	Description
5441	TIF9010A	Slimline Refrigerant Charging Scale

CPS

Pro-Set® Torque Wrench Kit

- Ideal for R-410A ductless installation
- Ensures compliance with OEM torque specifications for ductless A/C systems
- Universal torque wrench body and multi-head jaw sizes
- 1-Year limited warranty



Part #	Model #	Description
126724	TLTWSAE	SAE 6-in-1 Torque Wrench



Access Port Adapter



Part #	Model #	Description
46337	QC-S5	5/16" QC x 1/4" SAE Straight

Nexia

Managing a home's energy use is simple with a Nexian Home Intelligence system.

Savvy customers are using the tools available to control lighting, raise or lower temperature, lock or unlock doors or take advantage of the latest in home surveillance. Understanding the business potential, dealers who are embracing this technology are enjoying increased market share because of it.

Take advantage of the opportunity to join high tech with high touch with a product line that successfully combines control, energy management and environmental responsibility. Want to learn more about this growing category, contact your Territory Manager for more information.

Nexia

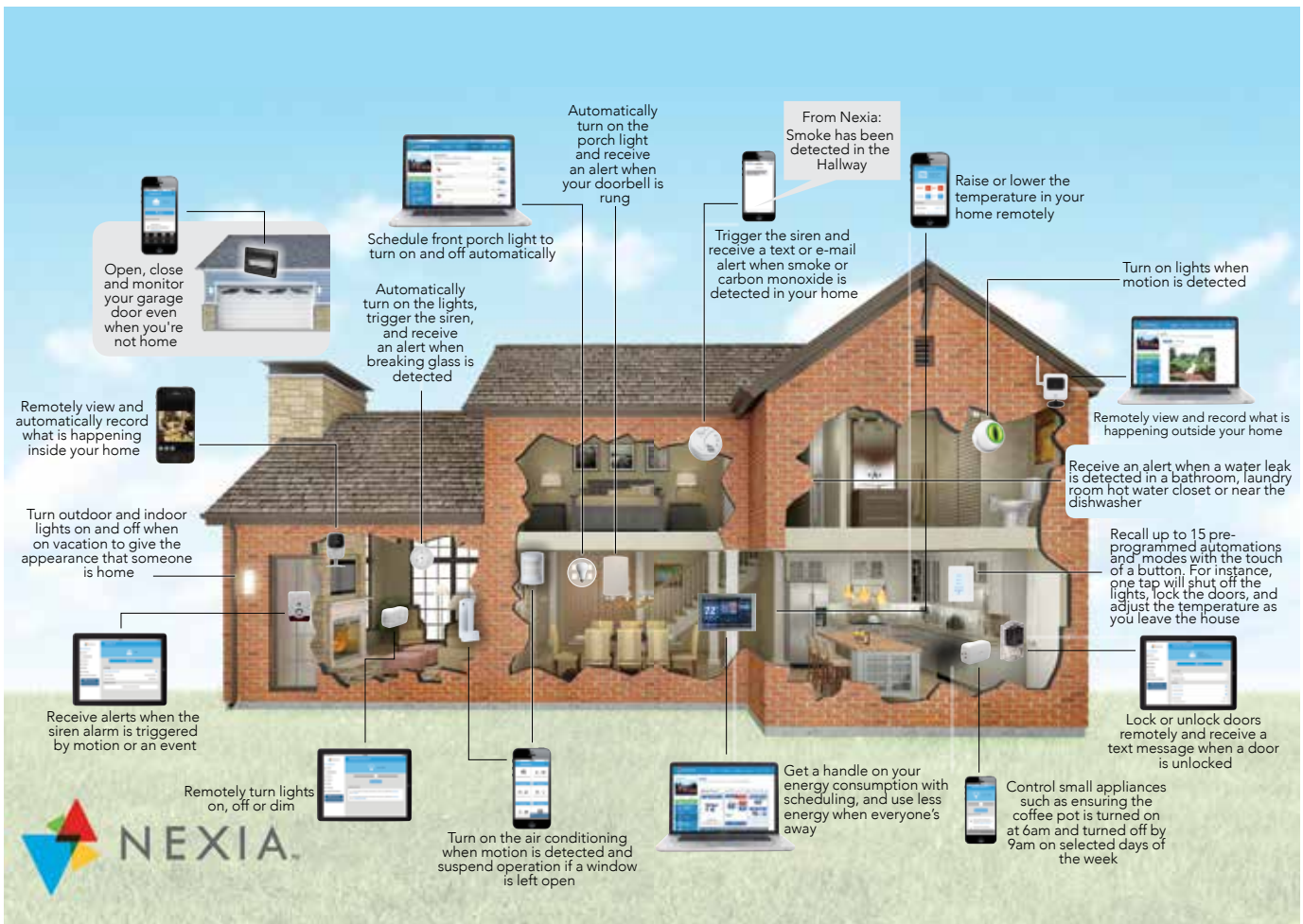

Nexia Thermostats

Nexia™ AccuLink™/ComfortLink™ Thermostats

- Nexia™ compatible
- WiFi connection
- Zoning capable
- Up-to-the-minute weather station
- Create up to six daily heating and cooling schedules
- Built-in humidity sensor
- Upgradable software
- Digital touchscreen display
- Maintenance and filter service reminder alerts
- Test modes and diagnostic screens
- Limited warranty: 5-year base, 10-year registered



American Standard Platinum 1050 Series AccuLink™ 7-Day Digital Programmable Control

- Compatible with AccuLink™ II communicating and variable-speed systems

Part #	Model #	Programmable	Misc
190337	AZON1050AC52ZA	7-Day	Nexia Z-Wave Bridge Inside

Trane XL1050 Series ComfortLink™ 7-Day Digital Programmable Control

- Compatible with ComfortLink™ II communicating and variable-speed systems



Part #	Model #	Programmable	Misc
190338	TZON1050AC52ZA	7-Day	Nexia Z-Wave Bridge Inside

American Standard Platinum 850 Series AccuLink™ II 7-Day Digital Programmable Control

- Compatible with AccuLink™ II communicating and variable-speed systems



Part #	Model #	Description	Misc
146057	ACONT850AC52UA	7 Day	Nexia Z-Wave Bridge Inside

Trane XL850 Series ComfortLink™ II 7-Day Programmable Control

- Compatible with ComfortLink™ II communicating and variable-speed systems



Part #	Model #	Programmable	Misc
146058	TCONT850AC52UA	7-Day	Nexia Z-Wave Bridge Inside

Nexia Thermostats

Nexia™ Thermostats

7-Day Programmable Nexia™ Comfort Control

- Digital touchscreen backlit display
- Auto changeover
- Inside and set temperature display
- Wireless and remote connectivity
- Includes Nexia™ home intelligence remote access
- 5-Year limited warranty on parts
- Optional extended warranties available



ACONT824



ACONT624



TCONT824



TCONT624

American Standard 7-Day Programmable Nexia™ Comfort Control

- ACONT624AS42DA requires Nexia™ bridge when connecting to Z-Wave enabled products

Part #	Model #	Programmable	Stages (Up To)	Misc
138066	ACONT824AS52DA	7 Day	2 Heat/2 Cool or 5 HP/2 Cool	Nexia Z-Wave Bridge Inside
127580	ACONT624AS42DA	7 Day	4 Heat/2 Cool or 4 HP/2 Cool	Requires Nexia Bridge for WiFi

Trane 7-Day Programmable Nexia™ Comfort Control

- TCONT624AS42DA requires Nexia™ bridge when connecting to Z-Wave enabled products

Part #	Model #	Programmable	Stages (Up To)	Misc
138064	TCONT824AS52DA	7 Day	2 Heat/2 Cool or 5 HP/2 Cool	Nexia Z-Wave Bridge Inside
127581	TCONT624AS42DA	7 Day	4 Heat/2 Cool or 4 HP/2 Cool	Requires Nexia Bridge for WiFi

Wall Cover Plate

Part #	Model #	For Use With
146070	BAYCOVR800A	T/ACONT624/824/850 Series

Temperature Sensor

Part #	Model #	Description	For Use With
47290	BAYSEN01A	Outdoor Temperature Sensor	
44461	BAYSEN02A	Programmable Outdoor Temperature Sensor	T/ACONT800, 802, and 803
55686	BAYSENS077A	Remote Room Sensor	

Thermostat Accessories

Add-A-Wire™

- Easy to install
- Use to add a wire to a thermostat
- Easier than running new wire
- Add a second Add-A-Wire to allow 5-wires to work like 7-wires



Part #	Model #	Description
170174	ACC-0410	Allows 5-Wire Thermostats to use 4-Wires & 5-Wires to Work Like 6-Wires

Nexia Accessories

Nexia™ Home Automation

- Allows remote access of Z-Wave enabled devices through your smart phone, tablet, or PC
- Secure connection with server for homeowner protection



Nexia™ Home Intelligence Bridge

- Includes: Nexia™ bridge (Z-Wave to broadband), Ethernet cable, and power supply

Part #	Model #	Description
127821	BR100	120VAC Nexia Home Bridge, 9V Backup, 4-3/4" x 5" x 1-3/8"

Nexia™ Home Intelligence Starter Bundle

- Includes: Nexia™ bridge (Z-Wave to broadband), one RP100BX home appliance module, Ethernet cable, and power supply



Part #	Model #	Description
127820	SK101	Starter Bundle, Includes Bridge and Appliance Module

Nexia™ Light Dimmer Module

- Dimmer light module and Z-Wave signal repeater
- Used to control and dim plug-in incandescent lighting



Part #	Model #	Description
72974	RP200RVNNSL	Light Dimmer Module

Nexia™ Home Appliance Module

- Home appliance module and Z-Wave signal repeater
- Used to control small appliances and plug-in incandescent, fluorescent, and LED lighting
- On/off control
- May be used to control/reduce standby loss from plug-in power supplies and small electronic loads



Part #	Model #	Description
72976	RP100BX	Signal Repeater, Appliance Module

Nexia Accessories

Nexia™ Lever Lock

- Remotely engage/release locking mechanism from a computer or compatible web enabled mobile device
- Confirm lock status from a computer or compatible web enabled mobile device
- Assign up to (19) personalized 4 digit codes
- Up to 3-year battery life
- Provides battery level status at the lock and remotely
- Class 2 rated door lock
- Lifetime limited mechanical and finish warranty
- 1-Year limited electronics warranty



Part #	Model #	Description
73255	BAY599ABALLFEA	Aged Bronze Lever Lock
72979	BAY599SNALLFEA	Satin Nickel Lever Lock

Nexia™ Century Touchscreen Deadbolt

- Motorized bolt automatically locks and unlocks when code is entered
- Anti-pick shield protects against tampering
- Built-in alarm technology
- Remotely lock/unlock from a computer or compatible web enabled mobile device
- Confirm lock status from a computer or compatible web enabled mobile device
- Assign up to (30) personalized 4-8 digit codes
- Up to 3-year battery life
- Provides battery level status at the lock and remotely
- Lifetime limited mechanical and finish warranty
- 1-Year limited electronics warranty



Part #	Model #	Description
123896	BAY469ABACAMEA	Aged Bronze Touchscreen Deadbolt

Nexia™ Deadbolt

- Remotely engage/release locking mechanism from a computer or compatible web enabled mobile device
- Confirm lock status from a computer or compatible web enabled mobile device
- Assign up to (19) personalized 4 digit codes
- Up to 3-year battery life
- Provides battery level status at the lock and remotely
- Class 2 rated door lock
- Lifetime limited mechanical and finish warranty
- 1-Year limited electronics warranty



Part #	Model #	Description
73256	BAY369BBADBEEA	Bright Brass Wireless Deadbolt

Nexia Accessories

Nexia™ Wireless Outdoor Web Camera

- Indoor, fixed camera (power supply included)
- Remotely view and monitor your home from a computer or compatible web enabled mobile device
- Secure connection with server for homeowner protection
- Plug and play with system infrared illumination for night vision



Part #	Model #	Description
190115	811097020419	Wireless Outdoor Camera

Nexia™ Wireless Indoor Web Camera

- Outdoor, fixed camera (power supply included)
- Built in motion sensor (trigger video when motion detected) and infrared illumination for night vision
- Remotely view and monitor your home from a computer or compatible web enabled mobile device
- Secure connection with server for homeowner protection
- Plug and play with system privacy button



Part #	Model #	Description
146638	WCW200	Wireless Indoor Camera HD

Nexia™ Door/Window Sensor

- Reports open/closed status of doors and windows
- Set Nexia™ to send notification when doors or windows are opened
- Set Nexia™ to change the thermostat setting when windows have been opened or closed
- Simple installation and set up
- Up to 3-year battery life for normal usage, no wiring required
- For indoor use



Part #	Model #	Description
90467	RS100	Door/Window Sensor

Nexia™ Motion Sensor

- Text or e-mail alert when activity is detected
- Trigger Nexia™ compatible cameras when motion is detected
- Set up to turn on lights when there is activity present
- Up to 3-year battery life
- For indoor use



Part #	Model #	Description
90471	RS200	Motion Sensor

Nexia Accessories

Nexia™ Garage Door Controller

- Fully supported by Nexia™ web and mobile applications
- Actuates a garage door opener remotely
- AC Line powered
- Includes battery-powered tilt sensor that is mounted on the garage door that reports door position
- Produces audible and visual signals for safety purposes
- Integrates with most existing multisection doors (after 1993) and suitable for installation on existing or new garage door opening systems of many brands
- Does not include garage door opener, or garage door
- Compatible with most garage door openers that accept a standard push button input. Not compatible with openers using a proprietary communication protocol to the wall switch such as Genie Series II and the MyQ system.
- ETL Certified



Part #	Model #	Description
142417	GD00Z-3	120VAC Garage Door Opener

Smoke Alarms

Combination Smoke and Carbon Monoxide Alarm

- Dual smoke and carbon monoxide sensing
- Photoelectric smoke sensor
- Electrochemical CO sensor
- Single button for test/silence
- Low battery signal mute up to 8 hours
- End of life timer
- 85 dB Alarm
- Includes mounting anchors and screws
- 7-Year limited warranty
- Listed to UL 217 and 2034 standards
- Lifetime limited mechanical and finish warranty
- 1-Year limited electronics warranty



Part #	Model #	Power Supply	Detection
145835	ZCOMBO-G	(2) AA Batteries	Photoelectric/Electrochemical

Thermostats

Comfort Thermostat Controls

7-Day Digital Programmable Ultimate Comfort Control

- Interactive touchscreen
- Effortless programming
- Large, backlit display
- Armchair programming
- Real time clock
- Visual reminder cues
- 10 Sq in display
- Includes: wall cover plate (BAYCOVR600A)
- 5-Year limited parts warranty
- Optional extended warranties



ACONT800/802/803



TCONT800/802/803

American Standard

- ACONT803A also includes dehumidification control and built-in humidity sensor

Part #	Model #	Programmable	Stage
43752	ACONT800AS11AA	7-Day	1 Heat / 1 Cool
43546	ACONT802AS32DA	7-Day	3 Heat / 2 Cool
43754	ACONT803AS32DA	7-Day	3 Heat / 2 Cool

Trane

- TCONTB03AS32DA also includes dehumidification control and built-in humidity sensor

Part #	Model #	Programmable	Stage
70027	TCONTB00AS11AA	7-Day	1 Heat / 1 Cool
70028	TCONTB02AS32DA	7-Day	3 Heat / 2 Cool
70029	TCONTB03AS32DA	7-Day	3 Heat / 2 Cool

5/2 Day Digital Programmable Premium Comfort Control

- Front wired (wires attach to wall plates)
- Standard wiring terminal block
- Easy to follow sequential programming
- Inside and set temperatures displayed simultaneously
- No auxiliary heat capability
- Plain language (no symbols)
- Easy battery access
- Easy to understand soft key controls
- 5 sq in display
- Includes: wall cover plate (BAYCOVR700A)
- 5-Year limited parts warranty
- Optional extended warranties



ACONT600



TCONT600

American Standard

Part #	Model #	Programmable	Stage
44791	ACONT600AF11MA	5/2 or 5/1/1	1 Heat / 1 Cool
44790	ACONT602AF22MA	5/2 or 5/1/1	2 Heat / 2 Cool

Trane

Part #	Model #	Programmable	Stage
70025	TCONT600AF11MA	5/2 or 5/1/1	1 Heat / 1 Cool
70026	TCONT602AF22MA	5/2 or 5/1/1	2 Heat / 2 Cool

Thermostats

Digital Non-Programmable Premium Comfort Control

- Auto changeover
- Backlit display and keypad
- Energy savings mode
- Outdoor temperature sensor included
- Filter change reminder
- Keypad lock
- 3 Sq in display
- 5-Year limited warranty on parts
- Optional extended warranties available



ACONT401/402



TCONT401/402

American Standard

- ACONT401 requires TAYPLUS103A for dual fuel applications

Part #	Model #	Programmable	Stage
47120	ACONT402AN32DA	Non-Programmable	3 Heat / 2 Cool
45207	ACONT401AN21MA	Non-Programmable	2 Heat / 1 Cool

Trane

- TCONT401AN21MA requires TAYPLUS103A for dual fuel applications

Part #	Model #	Programmable	Stage
70024	TCONT402AN32DA	Non-Programmable	3 Heat / 2 Cool
70023	TCONT401AN21MA	Non-Programmable	2 Heat / 1 Cool

Digital Non-Programmable Contemporary Comfort Control

- Auto changeover
- Backlit display and keypad
- Energy savings mode
- 3 Sq in display
- 5-Year limited warranty on parts
- Optional extended warranties available



ACONT200



TCONT200

American Standard

Part #	Model #	Programmable	Stage
41633	ACONT200AN11AA	Non-Programmable	1 Heat / 1 Cool

Trane

Part #	Model #	Programmable	Stage
70022	TCONT200AN11AA	Non-Programmable	1 Heat / 1 Cool

Thermostats

Lyric Round™ Wi-Fi Thermostats

- Remote access anywhere with smart phone or tablet, in English, French or Spanish
- Motion-sense illumination
- Simplified touchscreen interface
- Control from anywhere by smart phone or table
- Geofencing technology uses your smartphone's location to optimize savings and comfort
- Smart cues for system information and recommendations
- Display options: °C or °F temperature display, 12-Hour or 24-hour clock
- Automatic or manual selectable changeover
- Hardwire, battery back-up, power transformation
- Electrical ratings: 18 to 30VAC
- Dimensions: 3" diameter polished glass face, 1" beveled depth
- Includes decorative back plate
- UL Listed



Part #	Model #	Programmable	Stage
177768	TH8732WFH5002/U	Smart Thermostat	2 Heat / 2 Cool or 3 HP / 2 Cool

Lyric™ T6 Pro Wi-Fi

- Up to 3H/2C heat pump and 2H/2C conventional
- Geofencing, 7-day, 5-2, 5-1-1, 1-week or non-programmable
- Optional ventilation control for projects that need to meet the ASHRAE 62.2 standard
- Uses the UWP mounting system that's standard across all T Series thermostats
- Setup and scheduling can be done at the wall on the thermostat, or using the Lyric app
- Simple homeowner hand-off process enables customers to complete the Wi-Fi connection process on their own
- Integrates with smart home Apple® HomeKit™ and Amazon Alexa® for customers who want to control their smart home devices from a single app
- Customers can program a schedule or use location-based control with geofence technology, which uses their smartphone location to save energy
- Optional wired indoor/outdoor sensors
- Large touchscreen display
- 5-year warranty



Part #	Model #	Programmable	Stage
185536	TH6320WF2003/U	7 Day, 5-1-1, 5-2 or NP	2 Heat / 2 Cool or 3 HP / 2 Cool
185538	TH6220WF2006/U	7 Day, 5-1-1, 5-2 or NP	2 Heat / 2 Cool or 3 HP / 2 Cool

Thermostats

Prestige® IAQ Kit

- 60% smaller than Prestige 2.0 and available in 4 colors
- Diagnostics inform customers when their system is not operating as expected
- Residential or light commercial use
- User interaction log provides a searchable history of setting changes
- Assignable outputs for indoor air quality and staging control
- Selectable staging options
- Customizable service reminders
- Up to 4H/2C heat pump or 3H/2C conventional systems
- Works with integrators including IFTTT and link for enhanced comfort, control and an even greater connected home experience-for a complete list, visit our integrations page
- Smart schedule feature programs in seconds for any lifestyle
- Works with RedLINK accessories: RedLINK Internet Gateway / Total Connect, Wireless Outdoor Air Sensor, Wireless Indoor Air Sensor, Portable Comfort Control, Entry/Exit Remote, Vent and Filter Boost Remote, Wireless Adapter and TrueZONE Panels
- 5-year warranty



Includes EIM, RedLINK Internet Gateway, 2 Duct Sensors

Part #	Model #	Programmable	Stages (up to)	Color
142144	YTHX9421R5127WW	7 Day or NP	3 Heat / 2 Cool or 4 HP / 2 Cool	

Includes EIM, Wireless Outdoor Sensor, 2 Duct Sensors

Part #	Model #	Programmable	Stages (up to)	Color
124100	YTHX9421R5101WG/U	7 Day or NP	3 Heat / 2 Cool or 4 HP / 2 Cool	White / Gray
124085	YTHX9421R5101WW/U	7 Day or NP	3 Heat / 2 Cool or 4 HP / 2 Cool	White / White

Includes EIM, 2 Duct Sensors

Part #	Model #	Programmable	Stages (up to)	Color
124095	YTHX9421R5085WG/U	7 Day or NP	3 Heat / 2 Cool or 4 HP / 2 Cool	White / Gray
124081	YTHX9421R5085WW/U	7 Day or NP	3 Heat / 2 Cool or 4 HP / 2 Cool	White / White

RedLINK™ to Internet Gateway and Ethernet Cable and Power Cord

Part #	Model #	Description
195172	THM6000R7001/U	RedLINK™ To Internet Gateway and Ethernet Cable and Power Cord

Prestige® IAQ

- Smaller and sleeker – 60% smaller footprint
- Full-color display – Customizable and high-definition
- Frame options – Choice of high-gloss acrylic colors
- Easy remote management – Monitor and control multiple buildings from a computer, tablet or smartphone
- Self-monitoring diagnostics – System sends alerts for maintenance or service issues
- Intuitive install – Question-based setup eliminates the need for a manual
- Alerts log – Stores 25 alerts to help technicians easily determine what part of the system needs attention
- System performance log – Min/max indoor/outdoor temperatures, humidity, run time, Delta T and more organized by hour, day, week or month
- Provides alerts and diagnostics when system needs service
- Four assignable inputs – Connect wired sensors, remote setback or dry contacts
- Pre-populated dealer info – Contractor contact information available with the touch of a button, driving repeat business



Part #	Model #	Programmable	Stages (up to)	Color
124088	THX9421R5021WW/U	7 Day or NP	3 Heat / 2 Cool or 4 HP / 2 Cool	White / White
124106	THX9421R5021BB/U	7 Day or NP	3 Heat / 2 Cool or 4 HP / 2 Cool	Black / Black

Models and Specifications are Subject to Change Without Notice

Thermostats

Prestige Wall Cover Plates

Part #	Model #	Color
124082	THP2400A1027W	White
124108	THP2400A1027G	Gray
124109	THP2400A1027B	Black

Wi-Fi 9000

- Remote comfort control via web, tablet or smartphone by connecting with Honeywell's Total Connect Comfort services
- Universal application up to 3H/2C heat pump and 2H/2C conventional
- Contemporary design with customizable display color
- Tool-free wiring, manual-free install and setup
- On-screen Wi-Fi connection process (no separate device needed)
- Equipment check/change reminders help generate repeat business
- Works with integrators including IFTTT and Link for enhanced comfort, control and an even greater connected home experience — for a complete list, visit our integrations page



Part #	Model #	Programmable	Stage
130213	TH9320WF5003	7 Day or NP	3 Heat / 2 Cool or 4 HP / 2 Cool

VisionPRO® 8000

Includes RedLINK Gateway

- Dual powered: battery or hard wired
- 7-day programmable
- Residential or light commercial use
- Micro SD port for quick installer setup
- Plain language setup, no manual needed
- On screen dealer information
- Smart schedule feature programs in seconds for any lifestyle
- Up to 3 Heat/2 Cool Heat Pump or Up to 2 Heat/2 Cool Conventional systems when used standalone
- Up to 4 Heat/2 Cool Heat Pump or Up to 3 Heat/2 Cool Conventional systems when used with the Equipment Interface Module
- Works with RedLINK accessories: RedLINK Internet Gateway / Total Connect, Wireless Outdoor Air Sensor, Wireless Indoor Air Sensor, Portable Comfort Control, Entry/Exit Remote, Vent and Filter Boost Remote, Wireless Adapter and TrueZONE Panels
- 5 -year limited warranty



Part #	Model #	Programmable	Stage
125094	TH8110R1008	7 Day or NP	1 Heat / 1 Cool
125095	TH8320R1003	7 Day or NP	2 Heat / 2 Cool or 3 HP / 2 Cool
124998	TH8321R1001	7 Day or NP	2 Heat / 2 Cool or 3 HP / 2 Cool
142145	YTH8321R1002	7 Day or NP	2 Heat / 2 Cool or 3 HP / 2 Cool

Equipment Remote Module

- Suitable for outdoor use
- Temperature sensor terminals for outdoor temp sensors or indoor freeze protection

Part #	Model #	Description
176014	ERM 5220 R1018	Equipment Remote Module, Redlink
176015	YERM 5220 R832	For TH8321R1001
176016	YERM 5220 RVPEIM	For TH8321R1001 & EIM

Thermostats

Wi-Fi VisionPRO® 8000

- Easy, plain language setup, no manual needed
- Remote comfort control via computer, tablet or smartphone
- Compatible with many system types, up to 3H/2C heat pump and 2H/2C conventional including dual fuel
- Relay for IAQ control: indoor humidification, dehumidification or ventilation control without requiring an outdoor air sensor
- Equipment check/change reminders
- Built-in ventilation controller. Lockouts for temperature and humidity prevent pulling in hot or humid air. No extra ventilation controller or remote sensor needed
- Easy 4-wire installs can be completed using a WireSaver, THP9045A1023. Fan and compressor are controlled through a single wire to the K terminal
- Works with integrators including IFTTT and Link for enhanced comfort, control and an even greater connected home experience — for a complete list, visit our integrations page



Part #	Model #	Programmable	Stage
163455	TH8321WF1001/U	7 Day or NP	2 Heat / 2 Cool or 3 HP / 2 Cool

Wireless FocusPRO® Systems 6,000 Kit

- Everything you love about FocusPRO - now wireless
- Connects to the internet
- Relocate a thermostat or upgrade equipment without running new wires
- Available in programmable and non-programmable models
- RedLINK-enabled to work with the RedLINK Internet Gateway, Portable Comfort Control and Wireless Outdoor Sensor
- Displays outdoor temperature and humidity
- Universal application: 3 heat, 2 cool
- Equipment Interface Module easily wires to the equipment to communicate with the Wireless FocusPRO
- Return Air Sensor wires to the Equipment Interface Module for backup control if homeowners forget to change batteries (high and low temperature limits)
- Dual fuel enabled
- Works with integrators including IFTTT and Link for enhanced comfort, control and an even greater connected home experience — for a complete list, visit our integrations page



Includes GedLink Internet Gateway, Return Air Sensor

Part #	Model #	Programmable	Stage
76278	YTH6320R1114/U	5-1-1 or 5-2	2 Heat / 2 Cool or 3 HP / 2 Cool

Includes GedLink Internet Gateway

Part #	Model #	Programmable	Stage
57339	YTH6320R1001	5-1-1 or 5-2	2 Heat / 2 Cool or 3 HP / 2 Cool

Indoor Air Quality

Models and Specifications are Subject to Change Without Notice

Thermostats

T6 Pro

- Up to 3H/2C heat pump and 2H/2C conventional
- 7-day, 5-2, 5-1-1 or non-programmable
- Uses the UWP mounting system that's standard across all T Series thermostats
- Easy upsell to a connected Lyric T6 Pro Wi-Fi when your customer is ready for Wi-Fi (C-wire required)
- Optional dual fuel
- Optional wired indoor/outdoor sensors
- Simple push-button functionality
- Filter change reminders
- 5-year warranty
- Check out the full T Series lineup Premier White®



Part #	Model #	Programmable	Stage
185540	TH6220U2000/U	7 Day, 5-1-1, 5-2 or NP	2 Heat / 2 Cool or 2 HP / 1 Cool
185542	TH6210U2001/U	7 Day, 5-1-1, 5-2 or NP	2 Heat / 1 Cool or 2 HP / 1 Cool

Wi-Fi FocusPRO®

- Remote access to the thermostat through a smartphone, tablet or computer
- 7-day programmable or non-programmable
- Works with integrators including IFTTT and Link for enhanced comfort, control and an even greater connected home experience — for a complete list, visit our integrations page
- Up to 3H/2C heat pump and 2H/2C conventional
- Large, clear backlit digital display
- Real-time clock
- 5-year warranty



Part #	Model #	Programmable	Stage
88628	TH6320WFI005	7 Day OR NP	2 Heat / 2 Cool or 3 HP / 2 Cool

FocusPRO® 6000

- Easy-access battery replacement
- Built-in instructions
- Largest display in its class
- Up to 2H/2C - conventional and heat pump
- 5-year warranty



Part #	Model #	Programmable	Stage
57226	TH6320R1004	5-1-1	3 Heat / 2 Cool

Water Leak & Freeze Detector

Part #	Model #
180789	CHW3610W 1001
180791	CHWE5 41013
190899	YCHW4000W4004/U

Thermostats

T4 Pro

- 1H/1C heat pump and 1H/1C conventional
- 7-day, 5-2, 5-1-1 or non-programmable
- Uses the UWP mounting system that's standard across all T Series thermostats
- Easy upsell to a connected Lyric T6 Pro Wi-Fi when your customer is ready for Wi-Fi (C-wire required)
- Simple push-button functionality
- Filter change reminders
- 5-year warranty
- Check out the full T Series lineup



Part #	Model #	Programmable	Stage
190999	TH4110U2005	7 Day, 5-1-1, 5-2 or NP	1 Heat / 1 Cool

PRO 4000

- Built-in instructions
- Easy-to-read backlit, digital display
- Models available for 2H/1C heat pumps and 1H/1C applications
- Dual-powered (battery and/or hardwire)
- 5-year warranty



Part #	Model #	Programmable	Stage
45112	TH4110D1007	5-2	1 Heat / 1 Cool

PRO 3000

- Easy-to-read backlit, digital display
- Models available for 2H/1C heat pumps and 1H/1C applications
- Dual-powered (battery and/or hardwire)
- 5-year warranty



Part #	Model #	Programmable	Stage
45111	TH3110D1008	Non Programmable	1 Heat / 1 Cool

PRO 1000

- Fits popular horizontal footprint
- Budget price
- Basic operation
- Models available for 2H/1C heat pumps and 1H/1C applications
- Heat only model available
- Private-label eligible



Part #	Model #	Programmable	Stage
132641	TH1110DV1009	Non Programmable	1 Heat / 1 Cool
79274	TH1100DH1004/U	Non Programmable	1 Heat Only

Thermostats

The Digital Round™

- Digital display
- One-touch backlight
- Familiar twist-to-set operation
- Available in heat/cool and heat only models
- 5-year warranty



Part #	Model #	Programmable	Stage
38591	T8775C1005	Non Programmable	1 Heat / 1 Cool

The Round™

- World's most popular thermostat
- Available in heat/cool and heat only models
- Now mercury-free
- 5-year warranty



Part #	Model #	Programmable	Stage
46772	T87K1007	Non Programmable	1 Heat or 1 Cool
46773	T87N1000	Non Programmable	1 Heat / 1 Cool
46774	T87N1026	Non Programmable	1 Heat / 1 Cool

NOTE: EASY TO READ

Econostat

- Available in heat/cool and heat only models
- Budget price
- Meets mercury-free requirements
- 5-year warranty



Part #	Model #	Programmable	Stage
49345	T834N1002	Non-Programmable	1 Heat / 1 Cool
49344	T822K1018	Non-Programmable	1 Heat Only

Line VoltPRO™ 7000

- Economical
- Replace virtually any two-wire (T410A) or four-wire (T410B) line voltage wall-mounted electric heating thermostat
- Easy to install; 6 in. (150 mm) color-coded leads
- Include long-lasting Micro Switch™ mechanism
- Rugged, plastic mounting base and one-piece cover with vents
- Ideally suited to new construction applications



Part #	Model #	Programmable	Stage
594	T410B1004	Non-Programmable	DPST
5672	T410A1013	Non-Programmable	SPST

Thermostats

Aprilaire



8900 Series

Part #	Model #	Programmable	Stage	Description
175421	8920W	Smart Thermostat	3 Heat / 3 Cool or 4 HP / 2 Cool	WiFi
175420	8910W	7 Day, 5-1-1, 5-2 or NP	3 Heat / 3 Cool or 4 HP / 2 Cool	WiFi
79089	8910	7 Day, 5-1-1, 5-2 or NP	3 Heat / 3 Cool or 4 HP / 2 Cool	

8600 Series

Part #	Model #	Programmable	Stage	Description
176303	8620W	7 Day, 5-1-1, 5-2 or NP	2 Heat / 2 Cool or 4 HP / 2 Cool	WiFi
82142	8620	7 Day, 5-1-1, 5-2 or NP	2 Heat / 2 Cool or 4 HP / 2 Cool	
70118	8600	Non Programmable	2 Heat / 2 Cool or 4 HP / 2 Cool	

8400 Series

- Large backlit display
- Built-in dual fuel control
- Circulate fan mode for better IAQ
- Built-in user manual
- Maintenance reminders
- High & low balance point with outdoor temperature sensor and free custom imprinted covers



Part #	Model #	Programmable	Stage	Description
176305	8476W	7 Day, 5-1-1, 5-2 or NP	2 Heat / 2 Cool or 4 HP / 2 Cool	WiFi
79088	8476	7 Day, 5-1-1, 5-2 or NP	2 Heat / 2 Cool or 4 HP / 2 Cool	
164854	8465	5-1-1, 5-2	2 Heat / 1 Cool or 2HP / 1 Cool	
62915	8463	5-1-1, 5-2	1 Heat or 1 Cool	
67657	8448	Non-Programmable	2 Heat / 2 Cool or 4 HP / 2 Cool	
62912	8444	Non-Programmable	1 Heat or 1 Cool	

RedLink Accessories

Part #	Model #	Programmable
195172	THM6000R7001/U	RedLink Enabled Internet Gateway
57227	REM5000R1001	Portable Comfort Control
57228	C7089R1013	Wireless Outdoor Sensor
76277	C7189R1004	Wireless Indoor Sensor

Models and Specifications are Subject to Change Without Notice

Thermostats

Sensi™ Touch Wi-Fi Thermostat

- *Extensive compatibility: works with the HVAC equipment found in most homes - all system types require a common wire (c-wire).*
- *Easy to install: design features like illuminated easy-click terminals and step-by-step instructions with video tutorials available right in the app*
- *Energy saving features: with features like geofencing, flexible scheduling and remote access, you can save money without compromising your comfort*
- *Touchscreen color display: features easy-to-read temperatures, intuitive menus and back glow*
- *Smart home compatible: integrates directly with Apple HomeKit, Amazon Alexa and Wink*
- *Smart alerts: detects extreme temperatures and humidity levels to keep you informed*
- *Automatic upgrades: as features are enhanced and released, Sensi thermostat software is kept up-to-date automatically*
- *Control from anywhere: use the intuitive mobile app to set, change and program your home comfort from across the room or across the country*
- *Multi-thermostat control: using the Sensi online portal or mobile app, available on Apple and Android smart devices*
- *Indoor humidity sensor: for readings on the humidity levels in your home*
- *5 year limited warranty for professionals*
- *3 year limited warranty for DIY homeowners external electromechanic relay sold separately*



Part #	Model #	Programmable	Stage
193115	1F95U-42WF	Smart Thermostat	2 Heat / 2 Cool or 4 HP / 2 Cool
192722	1F87U-42WF	7 Day, or NP	3 Heat / 2 Cool or 4 HP / 2 Cool
193749	F61-2689	Wall plate for 1F87U-42WF	

80 Series™ Thermostats

- *Large display, bright backlight, high contrast screen*
- *Easy to install with built-in level, simple set-up menu and separate subbase*
- *Selectable programming, choice of 7 day, 5+1+1 day or off is standard on all programmable models*
- *Dual fuel control, no outdoor sensor required, standard on all staging models*
- *Auto changeover on all universal models*
- *Keypad lockout and adjustable heat/cool temperature limits*
- *5 year limited warranty for professionals*



Part #	Model #	Programmable	Stage
173344	1F85U-42PR	7 Day, 5-1-1, or NP	2 Heat / 2 Cool or 4 HP / 2 Cool
173347	1F83C-11PR	7 Day, 5-1-1, or NP	2 Heat / 1 Cool or 1HP / 1 Cool
173349	1F83C-11NP	Non-Programmable	2 Heat / 1 Cool or 1HP / 1 Cool

Thermostats

BLUE™ Universal Touchscreen Thermostats 12"

- Humidity control - 1F95-1291
- Dual fuel capable with Smart Fuel™ Logic Program or outdoor temperature sensor - 1F95-1291
- Dual fuel with outdoor temperature sensor - 1F97/95-1277
- Large, 12 square-inch display with 10-second backlight
- Exclusive Cool Savings™ feature saves energy during peak A/C demand periods
- Remote sensing indoor or outdoor and at the thermostat
- Programmable fan
- Automatic daylight savings option



Part #	Model #	Programmable	Stage
56752	1F95-1291	7 Day, 5-1-1, or NP	2 Heat / 2 Cool or 4 HP / 2 Cool
48512	1F95-1277	7 Day, 5-1-1, or NP	2 Heat / 2 Cool or 4 HP / 2 Cool
50087	1F97-1277	7 Day, 5-1-1, or NP	2 Heat / 1 Cool or 2HP / 1 Cool

Blue™ Easy Reader™ 6"

- Super-large numbers and letters
- Easy-to-use and easy-to-read
- Intuitive operating choices
- Simple one-button, one-function operation means nothing to learn
- Ships in non-programmable mode
- 7-day programming mode available
- Temperature setpoint limits
- Dual fuel capable with Smart Fuel™ Logic Program (no outdoor sensor required)
- 5-year limited warranty



Part #	Model #	Programmable	Stage
62499	1F95EZ-0671	7 Day, or NP	2 Heat / 2 Cool or 4 HP / 2 Cool

BLUE™ EASY SET™ Thermostats 2"

- Easy-to-read 2-square-inch Blue™ display
- Easy push-connect color-coded terminals
- Exclusive sleep timer
- Easy-to-change temperature pre-sets



Part #	Model #	Programmable	Stage
172272	1F86EZ-0251	Non-Programmable	1 Heat / 1 Cool
172274	1F89EZ-0251	Non-Programmable	2 HP / 1 Cool

Thermostats

Classic 80 Series™ Thermostats

- Battery power - mV to 30 VAC; Hardwire: 20 to 30 VAC; NEC Class II, 50/60 Hz
- Setpoint range 45 °F to 99 °F (7 °C to 37 °C)
- Terminal Load - 1.0 A per terminal, 1.5 A per maximum all terminals combined
- Display temperature range 32 °F to +99 °F (0 °C to 37 °C)
- Operating ambient 32 °F to +105 °F (0 °C to +41 °C)
- Operating humidity 90% non-condensing max
- Thermostat dimensions 3-7/8"H x 6"W x 1-3/16"D



Part #	Model #	Programmable	Stage
44768	1F86-344	Non-Programmable	1 Heat / 1 Cool or 1HP / 1 Cool

70 Series™ Thermostats

- Battery power - mV to 30 VAC; Hardwire: 20 to 30 VAC; NEC Class II, 50/60 Hz
- Setpoint range 45 °F to 90 °F (7 °C to 32 °C)
- Terminal load - 1.0 A per terminal, 1.5 A per maximum all terminals combined
- Operating ambient 32 °F to +105 °F (0 °C to +41 °C)
- Operating humidity 90% non-condensing max
- Thermostat dimensions 3-13/16"H x 5-1/8"W x 1-1/8"D (1F78); 5-5/16"H x 3-3/16"W x 1-1/8"D (1E78)



Part #	Model #	Programmable	Stage
31043	1F78-151	5-2	1 Heat / 1 Cool or 1HP / 1 Cool
31044	1F78-144	Non-Programmable	1 Heat / 1 Cool or 1HP / 1 Cool
62331	1E78-140	Non-Programmable	1 Heat
43894	1E78-151	5-2	1 Heat / 1 Cool or 1HP / 1 Cool

Thermostats

BLUE™ 4" Thermostats

- Easy-to-read 4-square-inch blue display
- Battery power monitor
- Millivolt and Hydronic Zone Valve Compatible
- Exclusive Cool Savings™



Part #	Model #	Programmable	Stage
56745	1F80ST-0471	5-1-1, 5-2 or NP	1 Heat / 1 Cool or 1HP / 1 Cool

Mechanical Thermostats

- Mercury free snap-action contacts with dust cover.
- Resistant to vibration.
- Mounts to wall or junction box.
- Built in bimetal thermometer.
- Classic White color.
- Horizontal and vertical models.
- 24 Volt, 750 mV and 3 - wire zone options. See table below.



Part #	Model #	Programmable	Stage
53598	1F56N-444	Non-Programmable	1 Heat / 1 Cool or 1HP / 1 Cool
32685	1C20-101	Non-Programmable	Heat Only
32686	1C26-101	Non-Programmable	1 Heat / 1 Cool

Ecobee Pro Thermostats



Part #	Model #	Programmable	Stage
192560	4 PRO	Smart Thermostat	4 Heat / 2 Cool or 2 HP / 2 Cool
192561	3 LITE PRO	Smart Thermostat	4 Heat / 2 Cool or 2 HP / 2 Cool
192565	E3-RSe3PK2-01	Remote Sensor	



We maintain well-stocked and conveniently located warehouses. Please visit us at the branch nearest you.

Thermostats

Nest 3rd Gen Learning Thermostat

- Auto-schedule
- Home/away assist
- Energy history
- Home report
- Nest leaf
- Nest app
- Farsight
- Airwave
- System match: Early-On, Heat Pump Balance, True Radiant
- Time-to-temperature
- Weather aware
- Advanced fan control
- Sunblock
- Cool to dry
- Thermostat lock
- Software updates over Wi-Fi
- Safety temperature alert
- Furnace heads-up
- Filter reminder
- System test
- Stainless steel ring



Part #	Model #	Programmable	Stage	Color
170763	T3008US	Smart Thermostat	3 Heat / 2 Cool	Stainless Steel
187899	T3016US	Smart Thermostat	3 Heat / 2 Cool	Black
187910	T3017US	Smart Thermostat	3 Heat / 2 Cool	White
187911	T3021US	Smart Thermostat	3 Heat / 2 Cool	Copper

Nest Thermostat E

- Can be controlled from anywhere with the Nestapp
- Proven energy-saving features
- Turns itself down after users leave the home
- Your customer can setup a simple schedule
- ENERGY STAR® certified
- Emergency heat support
- Frosted display blends into the background
- Warranty-3 years when installed with a Nest Pro ID



Part #	Model #	Programmable	Stage	Color
195125	T4001ES	Smart Thermostat	2 Heat / 1 Cool or 1 Heat / 2 Cool	White

Nest Protect

- Voice alarms with custom location
- Detects carbon monoxide
- 10-year product lifetime
- Wireless Interconnect
- Nest app



Part #	Model #	Programmable	Color
184389	S3004PWBUS	2nd Generation Smoke and CO Alarm (Battery)	White
184390	S3005PWLUS	2nd Generation Smoke and CO Alarm (Wired)	White

Nest Cam

- Easy 60-second setup
- Get alerts on your phone
- See your home in HD
- Zoom and enhance
- 2-year limited warranty



Part #	Model #	Programmable
164189	NC1103US	Indoor HD Security Camera 3rd Generation
183770	NC2100ES	Outdoor HD Security Camera 3rd Generation, WiFi

Air Cleaners

American Standard AccuClean™ Whole House Air Cleaner

- 24V power
- Removes up to 99.98% of allergens from filtered air
- Removes particles down to .1 microns in size
- Outperforms HEPA, and up to 100 times more effective than a standard 1" filter
- Power door features a filter-status display; auto shut down when door is opened
- Pre-filter traps large particles
- Fits flush on both sides and rear of cabinet
- Includes gaskets
- 10-Year registered limited warranty
- Warranty terms require registration within 60 days of installation



Upflow/Side Return Furnace - 24 Volt American Standard AccuClean™ Whole House Air Cleaner

Part #	Model #	Airflow Range	Furnace Width	Uncrated Dimensions H x W x D	Ship Wt
65023	AFD175CLFR000C	300 - 1,600	17-1/2"	7-1/2" x 17-1/2" x 27"	43 lbs
65025	AFD210CLFR000C	300 - 2,000	21"	7-1/2" x 21" x 27"	47 lbs
65027	AFD245CLFR000C	400 - 2,000	24-1/2"	7-1/2" x 24-1/2" x 27"	49 lbs

Downflow Furnace - 24 Volt American Standard AccuClean™ Whole House Air Cleaner

Part #	Model #	Airflow Range	Furnace Width	Uncrated Dimensions H x W x D	Ship Wt
65024	AFD17DCLFR000C	300 - 1,600	17-1/2"	7-1/2" x 17-1/2" x 21"	37 lbs
65026	AFD21DCLFR000C	300 - 2,000	21"	7-1/2" x 21" x 21"	41 lbs

Air Cleaners

Trane CleanEffects™ Whole House Air Cleaner

- Trane CleanEffects™ removes up to 99.98% of allergens from the filtered air
- Removes particles down to .01 micron in size
- Outperforms HEPA, and up to 100 times more effective than a standard 1" filter
- Constructed of heavy 18 gauge metal to protect the filter and internal electronics
- Power foot provides easy access to internal components and features a filter status display as well as safety interlocks that automatically shut down the power when the door is opened for maintenance or cleaning
- Designed for flush fit on both sides and rear of equipment cabinet
- No transitions required on Trane CleanEffects™ applications
- Gaskets included with the air cleaner
- ComfortLink II™ communicating or 24 volt capability
- Base limited warranty 5-years
- Registered limited warranty 10-years



Upflow/Side Return Furnace - 24 Volt Trane CleanEffects™ Whole House Air Cleaner

Part #	Model #	Airflow Range	Furnace Width	Uncrated Dimensions H x W x D	Ship Wt
70038	TFD175CLFR000C	300 - 1,600	17-1/2"	7-1/2" x 17-1/2" x 27"	43 lbs
70040	TFD210CLFR000C	300 - 2,000	21"	7-1/2" x 21" x 27"	47 lbs
70044	TFD245CLFR000C	400 - 2,000	24-1/2"	7-1/2" x 24-1/2" x 27"	49 lbs

Downflow Furnace - 24 Volt Trane CleanEffects™ Whole House Air Cleaner

Part #	Model #	Airflow Range	Furnace Width	Uncrated Dimensions H x W x D	Ship Wt
70039	TFD17DCLFR000C	300 - 1,600	17-1/2"	7-1/2" x 17-1/2" x 21"	37 lbs
70041	TFD21DCLFR000C	300 - 2,000	21"	7-1/2" x 21" x 21"	41 lbs

**QUALITY.
SERVICE.
TOMMARK.**

Air Cleaners

Perfect Fit™ High Efficiency Media Air Cleaners

- 5" Expandable media filter
- Air-Tite™ construction
- Fits in tight spaces and in virtually any position



Perfect Fit™ High Efficiency Air Handler Model Media Air Cleaner

- Three sizes to flush fit TWE/4TEE/4TEP 6-way convertible air handler return

Part #	Model #	Type	Airflow Range (CFM)	Uncrated Dimensions H x W x D	Ship Wt
70082	TFM215B0AH0	Air Handlers	300 - 1,400 CFM	7-1/2" x 21-1/2" x 21"	22 lbs
70083	TFM235B0AH0	Air Handlers	300 - 1,700 CFM	7-1/2" x 23-1/2" x 21"	24 lbs
70085	TFM260B0AH0	Air Handlers	400 - 2,100 CFM	7-1/2" x 26-1/2" x 21"	25 lbs

Perfect Fit™ High Efficiency Furnace Model Air Cleaner

Part #	Model #	Type	Airflow Range (CFM)	Uncrated Dimensions H x W x D	Ship Wt
70079	TFM145B0FR0	Furnaces	300 - 1,200 CFM	7-1/2" x 14-1/2" x 27"	18 lbs
47546	TFM175B0FR0	Furnaces	300 - 1,500 CFM	7-1/2" x 17-1/2" x 27"	21 lbs
70081	TFM210B0FR0	Furnaces	300 - 2,000 CFM	7-1/2" x 21" x 27"	24 lbs
70084	TFM245B0FR0	Furnaces	400 - 2,000 CFM	7-1/2" x 24-1/2" x 27"	27 lbs



A MUNCH'S SUPPLY COMPANY

Air Cleaners

Honeywell Air Cleaners

F300 Whole-House Electronic Air Cleaner

- Captures up to 98% of airborne particles passing through the system
- Media post-filter provides enhanced filtration on select models
- Solid state power supply is self-regulating and maintains peak efficiency during a wide range of cell dirt loading conditions
- Low-profile door with test button to check system operation
- Helps filter efficiency-robbing "gunk" before it coats critical system parts
- Very low pressure drop
- Rugged zinc-coated, roll-formed cabinet provides superior strength and corrosion protection
- 120VAC
- Includes high air flow post filter
- 10-year clean coil guarantee
- UL listed



Part #	Model #	Size	Max Rated Airflow
28777	F300E1001	16" x 20"	1,200 CFM
28776	F300E1019	16" x 25"	1,400 CFM
28779	F300E1035	20" x 25"	2000 CFM

Air Cleaner Accessories

Electronic Air Cleaner Parts

Part #	Model #	Description
28976	136434AA	20" Ionizer Wire
28975	136434BA	16" Ionizer Wire for F50A, F50E, F50F, F59A
30463	137266	Cell Handle for F50F and F58F
32856	4074EHG	FC37A Terminal Board Repair Kit, Contains (2) Connector Clips, (1) Terminal Board & Instruction Sheet

Replacement Power Supply Box

Part #	Model #	Description
84466	PS1201B25	120VAC Replacement Power Supply Box for F50/F300 Electronic Air Cleaners, 125" w/Cover
83682	PS1201A00/U	120VAC Replacement Power Supply for F50/F300 Electronic Air Cleaners, Board Only

Electronic Air Cleaner PreFilter

Part #	Model #	Size	For:
29951	203371	16" x 25"	F50, F300
29870	203372	20" x 25"/20" x 12-1/2"	F50, F300, F58C/F

Electronic Air Cleaner Post-Filter

Part #	Model #	Size	For:
39817	50000293-002	16" x 12-1/2"	16" x 25" F300 & F50F
39816	50000293-004	20" x 12-1/2"	20" x 25" & 20" x 12.5" F300 & F50F

Air Cleaners

F200F Duct Mount Media Air Cleaner

- High efficiency media filter captures particles as small as 0.3 microns of the airborne particles in the air circulated through the unit
- Recommended basic minimum media air quality product
- Applicable to all gas, oil and electric forced air furnaces and compressors up to 5 tons
- Includes: cabinet, access door and MERV 13 pleated filter
- Mounts in any position
- Integral pressure sensors signal when filter change is required
- Filter change status is transmitted to wall-mount RF Airwatch Indicator
- Rugged zinc-coated, roll-formed cabinet resists corrosion and can support weight of residential furnace and evaporator coil
- Requires no electrical connections
- Requires no maintenance except periodic media filter replacement
- Quick and easy media filter replacement
- Upgradable to higher performing media or electronic air cleaner
- Efficiency ranges are defined for small particles
 - E1 = 63% 0.3 to 1.0 Microns; medium particles
 - E2 = 91% 1.0 to 3.0 Microns; and large particles
 - E3 = 99% 3.0 to 10.0 Microns
- UL listed



Part #	Model #	Size	Max Rated Air Flow
197538	F200F1625/U	16" x 25" x 4"	1,400 CFM
197541	F200F2025/U	20" x 25" x 4"	2,000 CFM

F100F Duct-Mount Media Air Cleaner

- High efficiency media filter captures particles as small as 0.3 microns of the airborne particles in the air circulated through the unit
- Applicable to all gas, oil and electric forced air furnaces and compressors up to 5 tons
- Mounts in the return air duct
- Rugged zinc-coated, roll-formed cabinet resists corrosion and can support weight of residential furnace and evaporator coil
- Requires no electrical connections
- Requires no maintenance except periodic media filter replacement
- Quick and easy media filter replacement
- Upgradable to higher performing media or electronic air cleaner
- Efficiency ranges are defined for small particles
 - E1 = 32% 0.3 to 1.0 Microns; medium particles
 - E2 = 72% 1.0 to 3.0 Microns; and large particles
 - E3 = 96% 3.0 to 10.0 Microns
- Includes: MERV 11 filter
- UL listed



Part #	Model #	Size	Max Rated Airflow
197479	F100F1620/U	16" x 20"	1,200 CFM
197476	F100F1625/U	16" x 25"	1,400 CFM
197480	F100F2020/U	20" x 20"	1,400 CFM
197477	F100F2025/U	20" x 25"	2,000 CFM

Models and Specifications are Subject to Change Without Notice

Air Filters

Replacement Media Filters

MERV 15 TrueCLEAN™ Replacement Enhanced Media Air Filter

- Static pressure drop: 0.22"wc at 500 FPM
- Efficiency ranges are defined for small particles
 - E1 = 90% 0.3 to 1.0 Microns; medium particles
 - E2 = 96% 1.0 to 3.0 Microns; and large particles
 - E3 = 99% 3.0 to 10.0 Microns
- Tradeline



Part #	Model #	Size	Airflow (CFM)	Use with:
73967	FR8000F1625	16" x 25"	1,600 CFM	FH8000F1625
77820	FR8000F2025	20" x 25"	2,000 CFM	FH8000F2025

MERV 13 Residential Air Cleaner High Efficiency Media Filter

- Efficiency ranges are defined for small particles
 - E1 = 63% 0.3 to 1.0 Microns; medium particles
 - E2 = 90% 1.0 to 3.0 Microns; and large particles
 - E3 = 97% 3.0 to 10.0 Microns
- Efficiency ratings are based on American Society of Heating, Refrigerating and Air-Conditioning Engineers Standard 52.2 1999



Part #	Model #	Size	Use with:
28784	FC200E1029	16" x 25"	F100 and F200
28787	FC200E1037	20" x 25"	F100, F200, SpaceGard 2200

MERV 11 POPUP™ Residential Replacement Media Air Filter

- Efficiency ratings are defined for small particles:
 - E1 = 0.3 to 1.0 Microns; medium particles
 - E2 = 1.0 to 3.0 Microns; and large particles
 - E3 = 3.0 to 10.0 Microns
- Stores flat and pops into shape for installation
- So easy you can sell over-the-counter to homeowners without the worry of mistakes
- Compact shape makes POPUP™ easy to ship and saves space on the truck
- No combs, pleat spacers or end caps



Part #	Model #	Size	Use with:
48042	POPUP1625	16" x 25"	F100, F200
48041	POPUP2025	20" x 25"	F100, F200
48045	POPUP2200	20-1/4" x 24-1/4" x 5-7/8"	Space-Gard® 2200, 2120, 2250, Lennox PMAC20 & GeneralAire AC-1
48046	POPUP2400	16" x 27-1/8" x 5-7/8"	Space-Gard® 2400, 2140, Lennox PMAC12

*Tradeline

MERV 10 Residential Air Cleaner High Efficiency Media Filter

- Static pressure drop (in wc): 0.23 @ 500 fpm
- Efficiency ranges are defined for small particles
 - E1 = 25% 0.3 to 1.0 Microns; medium particles
 - E2 = 62% 1.0 to 3.0 Microns; and large particles
 - E3 = 85% 3.0 to 10.0 Microns
- Efficiency ratings are based on American Society of Heating, Refrigerating and Air-Conditioning Engineers Standard 52.2 1999



Part #	Model #	Size	Use with:
28795	FC100A1003	16" x 20"	F100, F200
28796	FC100A1011	20" x 20"	F100, F200
28794	FC100A1029	16" x 25"	F100, F200
28797	FC100A1037	20" x 25"	F100, F200, Space-Gard® 2200

Air Cleaners

Air Cleaners

Whole-House Central Electronic Air Cleaner with One-Touch Control™

- *MERV 16 comparable*
- *94% efficient at removing bacteria as small as 0.35 micron*
- *Traps viruses with an 80% efficiency*
- *Over 99% efficient on pollen and spores*
- *Includes 5' grounded plug with cord*
- *2-year limited warranty*



Part #	Model #	Dimensions	Nom Size	Power	Current	Weight
45513	5000	17-3/4" x 28-1/8" x 11-1/2"	16" x 25"	120VAC, 60Hz	0.3A	35 lbs

Whole-House Central Media MERV 13 Air Cleaner

- *Captures dust, pollen, fungi, mold and pet dander*
- *Traps virus particles 0.3 to 1 microns with 76% efficiency*
- *Traps dust 1 to 3 microns with 90% efficiency*
- *Traps pollen and mold spores 1 to 3 microns with 90% efficiency*
- *Maintenance-free*
- *5-year limited warranty*



Part #	Model #	Dimensions	Nom Size
56311	2210	22" x 6-3/4" x 27-3/8"	20" x 25"
56313	2410	17-3/4" x 6-3/4" x 30"	16" x 25"

Whole-House Central Media MERV 11 Air Cleaner

- *Captures dust, pollen, fungi, mold and pet dander*
- *Traps pollen and mold particles 3 to 10 microns with 94% efficiency*
- *Traps dust 1 to 3 microns with 56% efficiency*
- *Permanently traps indoor allergens that can lead to respiratory problems*
- *5-year limited warranty*



1210-1510



1610

Part #	Model #	Dimensions	Nom Size
79086	1210	22" x 27" x 6-3/4"	20" x 25"
82158	1310	20-3/8" x 6-3/4" x 22-1/16"	20" x 20"
79087	1410	17-3/4" x 30" x 6-3/4"	16" x 25"
129395	1510	31" x 6-3/4" x 30-1/16"	31" x 28"
136378	1610	17-51/64" x 15-45/64" x 30-3/32"	16" x 25"
163473	1110	17-3/4" x 22" x 6-3/4"	16" x 20"
192977	1620	22-1/8" x 15-11/16" x 27-5/8"	20" x 25"

Air Filters

Air Cleaner Replacement Media

- Renewed performance when replaced regularly
- Individually packaged with complete instructions



1210-1510



201



210, 510



213, 413



310, 410



401

Part #	Model #	Fits Models:	MERV
48418	102	2120	MERV 8
45503	201	2200 & 2250	MERV 10
72053	210	1210	MERV 11
54702	213	2210, 3210, 4200	MERV 13
84965	310	1310, 2310, 3310	MERV 11
45504	401	2400	MERV 10
70279	410	1410	MERV 11
54703	413	2410, 3310, 4400	MERV 13
45505	501	5000	MERV 10
129393	510	1510	MERV 11
79961	610	1610	MERV 11
79564	810	1210, 2210, 3210	MERV 10
163474	110	1110	MERV 11
163476	113	1110	MERV 13
182994	313	1310, 2310	MERV 11

Air Filters

Whole House Media Cartridges

Air Cleaner Upgrade Kit

- Upgrade existing air cleaner to MERV 13; No tools required to upgrade
- Replaces inner housing and eliminates need for pleat spacers to hold media together
- One time upgrade
- Use Aprilaire® 413 or 213 air filter media after kit is installed



Part #	Model #	Fits Models:
57285	1213	2200, 2120
56962	1413	2400, 2140

Pleat Spacer

Part #	Model #	Description
45592	4119	(6) Pleat Spacer for Models 2200, 2250
45588	4270	(6) Pleat Spacer for Models 2400, 5000

Air Cleaner Parts

Part #	Model #	Description
50344	4602	Ionizer Wire for 5000, 3/Pk
86981	4736	Motor Bridge
70280	4894	Filter Frame Kit
79960	4897	Filter Frame Kit for 810 Filter



Let us be your source for quality products from leading manufacturers.

Air Cleaners

Media Air Cleaners

Air Bear® Supreme Media Air Cleaner

- MERV 8
- Accepts 5" thick pleated
- Air Bear Media
- Mounts direct to heating and cooling systems
- Suitable for use with all types of central forced-air configurations
- Eliminates standard return filters
- 10-year limited warranty on cabinet



Air Bear® Supreme 2000

Part #	Model #	Outside Dimension Size (H x W x D)	Media Size (H x W x D)
5247	455602-025	20-1/4" x 24-7/8" x 7-1/8"	20" x 20" x 5"
43183	455602-125	16-1/4" x 24-7/8" x 7-1/8"	16" x 25" x 5"

Air Bear® Right Angle Media Air Cleaner

- MERV 8
- 2,000 CFM
- Universal right/left-hand installation
- For areas where a 90° duct adapter is required
- Typically saves 6" to 8" of space
- Ideal for basement applications
- Eliminates standard return filters
- Accepts media size:
- 20"H x 25"W x 5"D
- 10-year limited warranty on cabinet



Part #	Model #	Outside Dimension Size (H x W x D)
5380	447380-010	24-3/8" x 15-1/2" x 25-5/8"

Electronic Air Cleaners

HE Plus Electronic Air Cleaner

- Forever Filter® never needs replacing
- Aluminum mesh pre-filter
- Optional charcoal after-filter
- Electronic airflow sensor
- Built-in 24V internal fuse protection
- 3-year limited warranty on cabinet



Part #	Model #	Size (H x W x D)	CFM
36288	455600-025	24-1/4" x 24-7/8" x 7-1/8"	2,000 CFM
36287	455600-125	20-1/4" x 24-7/8" x 7-1/8"	1,400 CFM

Air Cleaners

Dynamic Electronic Air Cleaners

Part #	Model #	Outside Dimension Size (H x W x D)
27198	EDG-P1000-14X25X1	14" x 25" x 1"
27208	EDG-P1000-14X30X1	14" x 30" x 1"
32940	EDG-P1000-14X36X1	14" x 36" x 1"
27209	EDG-P1000-16X20X1	16" x 20" x 1"
25750	EDG-P1000-16X25X1	16" x 25" x 1"
27196	EDG-P1000-20X20X1	20" x 20" x 1"
27202	EDG-P1000-20X25X1	20" x 25" x 1"

Air Bear® Media Filters

- *MERV 11*
- *Filter Life: 6 months*
- *UL900 listed*



Part #	Model #	Size (H x W x D)
7706	255649-102	20" x 25" x 5"
40950	255649-105	16" x 25" x 5"

Air Bear® Cub Media Filter

Part #	Model #	Size (H x W x D)
7703	255649-101	16" x 25" x 3"

Air Cleaner Parts & Accessories

Part #	Model #	Description	Fits Models:
34152	220110-020	Ionizing Wire	HE1400 Plus
50895	348818-001A	Trion Power Supply w/AFS	HE1400 and HE2000
41835	455578-001C	Trion Power Pack, 120V	HE Plus
54418	G109	Solenoid Valve, 24V	TRI50
25410	12006-01	Spray Nozzle	Mister Style Humidifiers
54812	160	O-Ring	Mister 50, 50-1 Nozzle

Ionizing Collector Cell

Part #	Model #	Description	Fits Models:
16935	441729-101	20" x 12-3/8"	HE2000
16387	441730-101	16" x 12-1/4"	HE1400

Prefilter

Part #	Model #	Description	Fits Models:
11866	123324-004	20" x 15-5/16"	HE2000, IAQ2000, MAX52000
11870	123324-005	16" x 12-1/4"	HE1400

Models and Specifications are Subject to Change Without Notice

Air Filters

Filters

Standard Pre Pleat™ 40 LPD Industrial Pleated Disposable Filter

- *MERV 8*
- *Pleat count: 1" = 13, 2" = 10, 4" = 9*
- *MERV 8 per ASHRAE Standard 52.2-2007*
- *Classified UL 900 Class 2*



EZ Flow Box Frame Disposable Filters

- *For residential and light commercial applications*
- *Economic disposable panel furnace filter*
- *UL 900 Class 2*
- *Continuous filament spun glass media*



1" EZ Flow Air Filters

Part #	Model #	Size
73644	FLT9x11-3/8x1	9" x 11-3/8" x 1"
39153	FLT14x20x1-PLEAT	14" x 20" x 1"
24450	FLT14X25X1-PLEAT	14" x 25" x 1"
7144	FLT16X20X1-PLEAT	16" x 20" x 1"
17146	FLT16X25X1-PLEAT	16" x 25" x 1"
10270	FLT20X20X1-PLEAT	20" x 20" x 1"
76869	FLT20X22X1-PLEAT	20" x 22" x 1"
1375	FLT20X25X1-PLEAT	20" x 25" x 1"
39248	FLT20X30X1-PLEAT	20" x 30" x 1"
19648	FLT12X24X2-PLEAT	12" x 24" x 2"
11449	FLT14X20X2-PLEAT	14" x 20" x 2"
22901	FLT14X25X2-PLEAT	14" x 25" x 2"
29459	FLT15X20X2-PLEAT	15" x 20" x 2"
31219	FLT16X16X2-PLEAT	16" x 16" x 2"
12136	FLT16X20X2-PLEAT	16" x 20" x 2"
22900	FLT16X24X2-PLEAT	16" x 24" x 2"
3039	FLT16X25X2-PLEAT	16" x 25" x 2"
4540	FLT18X24X2-PLEAT	18" x 24" x 2"
15333	FLT20X20X2-PLEAT	20" x 20" x 2"
15702	FLT20X24X2-PLEAT	20" x 24" x 2"
6191	FLT20x25x2-PLEAT	20" x 25" x 2"
38821	FLT20x30x2-PLEAT	20" x 30" x 2"
54514	FLT30x36x2-PLEAT	30" x 36" x 2"
40	FLT24x24x2-PLEAT	24" x 24" x 2"
20029	FLT16x20x4-PLEAT	16" x 20" x 4"
27950	FLT16x25x4-PLEAT	16" x 25" x 4"
38281	FLT20x25x5-PLEAT	20" x 25" x 4"
90357	FLT24x24x4-PLEAT	24" x 24" x 4"

Part #	Model #	Size
7176	FLT10X20X1	10" x 20" x 1"
19270	FLT10X24X1	10" x 24" x 1"
11863	FLT10X25X1	10" x 25" x 1"
8228	FLT12X12X1	12" x 12" x 1"
20987	FLT12X20X1	12" x 20" x 1"
2822	FLT12X24X1	12" x 24" x 1"
1623	FLT12X25X1	12" x 25" x 1"
18858	FLT14X14X1	14" x 14" x 1"
5372	FLT14X20X1	14" x 20" x 1"
21174	FLT14X24X1	14" x 24" x 1"
10088	FLT14X25X1	14" x 25" x 1"
29710	FLT14X30X1	14" x 30" x 1"
403	FLT15X20X1	15" x 20" x 1"
22932	FLT16X16X1	16" x 16" x 1"
13875	FLT16X20X1	16" x 20" x 1"
67658	FLT16X22X1	16" x 22" x 1"
17882	FLT16X24X1	16" x 24" x 1"
18859	FLT16X25X1	16" x 25" x 1"
1811	FLT18X18X1	18" x 18" x 1"
8336	FLT18X25X1	18" x 25" x 1"
3583	FLT18X20X1	18" x 20" x 1"
12161	FLT20X20X1	20" x 20" x 1"
27434	FLT20X22X1	20" x 22" x 1"
26727	FLT20X24X1	20" x 24" x 1"
17045	FLT20X25X1	20" x 25" x 1"
19551	FLT20X30X1	20" x 30" x 1"
14099	FLT24X24X1	24" x 24" x 1"
15113	FLT24X25X1	24" x 25" x 1"
9907	FLT25X25X1	25" x 25" x 1"
182004	FLT20x35x2	20" x 35" x 2"



Air Filters

2" EZ Flow Air Filters

Part #	Model #	Size
23562	FLT12X24X2	12" x 24" x 2"
26490	FLT14X20X2	14" x 20" x 2"
20920	FLT14X25X2	14" x 25" x 2"
20919	FLT15X20X2	15" x 20" x 2"
10187	FLT16X16X2	16" x 16" x 2"
13888	FLT16X20X2	16" x 20" x 2"
20091	FLT16X24X2	16" x 24" x 2"
18868	FLT16X25X2	16" x 25" x 2"
37090	FLT18X18X2	18" x 18" x 2"
23434	FLT18X24X2	18" x 24" x 2"
12166	FLT20X20X2	20" x 20" x 2"
28623	FLT20X24X2	20" x 24" x 2"
17055	FLT20X25X2	20" x 25" x 2"
39914	FLT20X30X2	20" x 30" x 2"
32180	FLT24X24X2	24" x 24" x 2"

Fiberglass Filters

- Replaces Trane/American Standard BAYFFR17TD

Part #	Model #	Size
72679	FLT17-1/8X26-1/8X1	17-1/8" x 26-1/8" x 1"

Dynamic Electronic Media Air Cleaners Replacement Media

Part #	Model #	Size
27472	P1000	14" x 20" x 1"
27473	P1000	14" x 25" x 1"
32047	P1000	14" x 30" x 1"
32942	P1000	14" x 36" x 1"
27474	P1000	16" x 20" x 1"
27475	P1000	16" x 25" x 1"
27476	P1000	20" x 20" x 1"
27477	P1000	20" x 25" x 1"
28535	P1000	24" x 24" x 1"

Filter Media Replacement

Part #	Model #	Fits Models:
62772	SGMPR	201, 2200, 2250
62773	SG4PR	401, 2400



Filter Frames

Expandable Media Furnace Filter

Part #	Model #	Size
71784	BAYFRAME145	14-1/2"
71785	BAYFRAME175	17-1/2"
71786	BAYFRAME210	21"
71787	BAYFRAME245	24-1/2"

Air Scrubber Plus

Air Scrubber Plus Air Purifier

- Natural air system installed into the ductwork or directly above air handler
- Discreet or concealed installation
- 18-32 volt optional installation
- UV bulb monitoring indicator included
- Low maintenance – no cleaning required



Part #	Model #	Description
190821	9960009	Air Scrubber Plus Whole House Duct Mounted Air Purifier
190823	9960011	Air Scrubber Plus Whole House Duct Mounted Ozone Free Air Purifier
190830	9940040	Air Scrubber Plus AP3000 Portable Air Purifier

Air Scrubber Plus Replacement Cell

Part #	Model #	Description
190822	US70678	Air Scrubber Plus Replacement Cell
190824	US71088	Air Scrubber Plus Ozone Free Replacement Cell

Air Scrubber Plus Laundry



Part #	Model #	Description
190831	9970025	Air Scrubber Plus Laundry Pro Cleaning System
190832	49771	Air Scrubber Plus Laundry Pro Pre-Filter Kit

Indoor Air Quality

Air Treatment Systems

Air Purifiers

Cold Plasma Air Purifier

- Mounts inside of fan coils, heat pumps, and air handlers up to 2,400 CFM or 6 tons
- Kills viruses, bacteria and mold
- Produces positive and negative ions (cold plasma) in the air stream which treats the inside of the air conditioning equipment, duct work and then enters and purifies the entire home
- The cold plasma in the air keeps the equipment clean
- It then enters the home and purifies the air and surfaces offering many benefits as you take control of:
 - viruses, bacteria, mold, allergies, dust, odors and volatile organic compounds
- Reduce static electricity and smoke
- No maintenance required
- Low power consumption
- No ozone or other byproduct odors
- No glass bulbs or replacement parts
- Does not contain mercury
- Easily installs into any brand of equipment
- For use in any size home
- Power: 2.4VA
- Includes :
 - Carbon filter brushes
 - LED operation status
 - 3-year warranty
- Patent pending technology has been third party tested
- UL, cUL, and ETL listed



Part #	Model #	Input Voltage	Capacity	Dimensions
146964	GPS-2400-3	24VAC	100 - 2,400 CFM	1-7/10" x 2-2/5" x 1-1/5"
159668	GPS-2400-1	115VAC	100 - 2,400 CFM	1-7/10" x 2-2/5" x 1-1/5"
186661	GPS-ICLEAN	24-240VAC	0 - 4,800 CFM	4" x 7" x 7"

Nu-Calgon iWave-R Air Purifier

- Needle point ionization actively treats air in the living space
- For duct systems up to 6 tons (2400 CFM)
- Easily installs in minutes in A/C system
- Universal voltage input - 24VAC to 240VAC!
- Universal mounting with magnets
- Flexible design with no replacement parts
- Kills mold, bacteria and viruses
- Reduces allergens, odors, smoke, static electricity and other airborne particles
- Reduces ventilation requirements
- Keeps coil cleaner
- Programmable cleaning cycle
- Alarm contact option for secondary notification
- UL and cUL approved
- Three-year warranty



Part #	Model #	Description
190558	4900-20	IWAVE-R Resident

UV Air Treatment Systems

UV Air Treatment Systems

24 Volt UV Purifier with AirBRIGHT™ Odor Absorption

- Installed in the ductwork of your central air system
- Through the use of Advanced Photocatalytic Oxidation (PCO) technology,
- Honeywell's UV Air Purifier combines germicidal UV light and activated carbon cells to reduce volatile organic compounds (VOC's) in the air
- Lamp is always on
- Replace lamp annually
- AirBRIGHT Odor Absorber never needs replacing
- SnapLamp™ features replacement lamp handle with detachable replacement lamp
- Universal installation with a single product:
 - UV Only
 - UV + Odor removal
 - Internal mount
 - External mount
- Dark empire gray color



UV2400U1000



UV2400U5000

Part #	Model #	Description
128804	UV2400U1000	24V Surface Treatment UV Air Purifier
128935	UV2400U5000	24V Surface Treatment Plus AirBRIGHT™ VOC Reduction/Odor Absorption
128805	UV2400XPCO1	AirBRIGHT™ Odor Assembly for UV2400U

UV100 Ultra Violet Air Treatment System

- SnapLamp™ features replacement lamp handle with detachable replacement bulb, UC18W or UC36W, to make replacement more economical
- UV-C Light kills airborne bacteria or surface mold
- Continuously emits ultraviolet energy
- UV Lamp does not produce ozone
- Sealed unit design prevents accidental installer and homeowner contact with the voltage and with the ultraviolet rays
- Safe design prevents lamps from lighting unless the base is correctly mounted on the HVAC duct
- Lamp light indicator to safely view the lamp operation
- Power cord that plugs into electrical outlet
- Quick and easy bulb replacement
- Easy lamp maintenance
- Optional AIRWATCH™ indicator can be installed to remind customers when to change bulb
- Combine with a high-efficiency air filtration system that includes an electronic air cleaner to capture and minimize micro-organism pass-through
- Meets American Lung Association® Health House® guidelines
- 5-year warranty



Single Lamp Models



Dual Lamp Models

Part #	Model #	Description
45843	UV100A1059	120VAC 36W 1-Lamp UV Surface or Return Air Treatment, Coil Plus Model
33077	UV100E1043	120VAC 18W 1-Lamp Smart Lamp UV Return Air Treatment
33078	UV100E2009	120VAC 36W 2-Lamp Smart Lamp UV Return Air Treatment

Models and Specifications are Subject to Change Without Notice

UV Air Treatment Systems

UV Air Treatment Parts

UV100 Air Treatment Replacement Lamp



UC100E SnapLamp™



UC100E1030

Part #	Model #	Description
28803	UC100E1006	Replacement 18W SnapLamp™ for UV100E1001 and UV100E1043, Blue Handle
30636	UC100E1030	Replacement 36W SnapLamp™ for UV100A1018, UV100E3007, UV100E1035, UV100A2009, UV100A1059, UV100A2008
53258	UC18W1004	Replacement Bulb 18W SnapLamp™ Single Lamp, for UC100A1005, UC100E1006, UV100A1000, UV100E1043
53259	UC36W1006	Replacement Bulb 36W SnapLamp™ Dual Lamp, for UC100A1013, UC100A1054, UC100E1014, UC100E1030, UV100A1018, UV100A1059, UV100A2008, UV100E2009, UV100E3007
128938	UV2400XLAM1	Replacement Lamp for UV2400U

SANUVOX

UV Replacement Bulbs

T6 Replacement Lamp



Part #	Model #	Description	Use with:
59013	LMPRGPT160T5	P 16" Length, Straight UV Bulb, UVC Germicidal	Saber 16/24G & Saber Genius

T6 Dual Zone High Intensity Replacement Lamp

Part #	Model #	Description	Use with:
53903	LMPHGXJ105	10-1/2" Length, J-Shaped UV Bulb, UVC/UVV Germicidal/Oxidizing	R4000GX, S300HFX

Indoor Air Quality



A MUNCH'S SUPPLY COMPANY

WE CARE WHO YOU ARE
Big business or small, you can expect the best service and quality products at competitive prices.

Humidifiers

Flow Through Fan Powered Humidifier

- For use with all furnace models
- Front cover access for humidifier pad replacement
- UV-Resistant cabinet and scale control insert
- Aluminum humidifier pad treated with ceramic clay
- Brass solenoid valve with stainless steel valve seat
- Saddle valve
- 5-year limited warranty on parts
- Optional extended warranty
- Automatic humidifier control with O.D. sensor (duct mount only)
- Not for horizontal installations
- Includes 120V power cord



AHUMD500



THUMD500

American Standard

Part #	Model #	Type	Gal/Day	Area Covered	Ship Wt
41210	AHUMD500APA00A	Flow Through Fan Powered, Automatic	18	Up To 4,200 Sq ft	20 lbs

Trane

Part #	Model #	Type	Gal/Day	Area Covered	Ship Wt
70088	THUMD500APA00B	Flow Through Fan Powered, Automatic	18	Up To 4,200 Sq ft	20 lbs

Bypass Humidifier

- Built-in summer/winter damper
- Field convertible duct connection, left or right side
- Includes 120/240V transformer



AHUMD300/200



THUMD300/200

American Standard

Part #	Model #	Type	Gal/Day	Area Covered	Ship Wt
41211	AHUMD300ABA00B	Large Bypass, Automatic	17	Up To 4,000 Sq ft	15 lbs
41212	AHUMD200ABM00B	Small Bypass, Manual Control	12	Up To 3,000 Sq ft	14 lbs

Trane

Part #	Model #	Type	Gal/Day	Area Covered	Ship Wt
70087	THUMD300ABA00B	Large Bypass, Automatic	17	Up To 4,000 Sq ft	15 lbs
70086	THUMD200ABM00B	Small Bypass, Manual Control	12	Up To 3,000 Sq ft	14 lbs

Humidifier Accessories

Part #	Model #	Description
41218	BAYPLT01AMHCOA	Adapter Plate (PLT-3885) (Duct Mount)

Models and Specifications are Subject to Change Without Notice

Humidifiers

Electrode STEAM™ Humidifier

- Application flexibility: mount on wall and remotely up to 5' away from the system
- Humidity boost can be used to increase relative humidity by 5 or 10%
- Canister replaced every one or two humidification seasons
- Auto-adaptive technology adjusts for changes in the weather, water and voltage
- Dimensions: 21-7/16"H x 11-7/16"W x 6-15/16"D
- 110/120 for 11 gpd and 220/240 for 22 GPD
- 5-year warranty



Part #	Model #	Capacity	Includes
195303	HM750A1000/U	11 or 22 GPD	Includes Humidipro Humidistat

Honeywell Legacy

- Functional design - fits existing evaporative humidifier space for quick and easy installation.
- Application flexibility - easily change bypass direction.
- Replacement opportunity utilizes same standard and agion replacement pads.
- Simple installation includes transformer and control.
- 5-year warranty.



Part #	Model #	Capacity	Style
188347	HE105A1000/U	12 GPD	Small Basic Bypass
188348	HE205A1000/U	17 GPD	Large Basic Bypass

Humidifiers

Humidifiers

TrueEASE™ Flow-Through Humidifier

- Easy to install with quick snap bypass direction adjustment
- Advanced models save 30% to 50% of water
- Advanced models save energy by automatically closing the bypass when not in use
- Easy to replace pads
- Versatile fit designed for more jobs
- Operational efficiencies to drive higher margins with values homeowners understand
- Unintimidating, engaging maintenance to drive repeat business
- Includes HumidiPRO™ digital humidistat



Advanced Bypass

Fan-Powered

Part #	Model #	Capacity	Style
68297	HE100A1000	12 GPD	Bypass Small Basic
68298	HE150A1005	12 GPD	Bypass Small Advanced
68299	HE200A1000	17 GPD	Bypass Large Basic
68300	HE250A1005	17 GPD	Bypass Large Advanced
68301	HE300A1005	18 GPD	Fan-Powered Advanced

Digital IAQ Controls

HumidiPRO™ Digital Humidity Control

- Automatically adjusts settings for changes in outdoor temperature to ensure no condensation will appear in your home (window protection)
- Manual humidification/dehumidification control or automatic control with included outdoor sensor
- Automatically detects presence of outdoor sensor to set control to automatic or manual mode
- Dehumidifier compressor protection
- Large, digital backlit display
- Relative humidity% and outdoor temperature calibration
- Adjustable high and low range stops (10-90%)
- Mounting: return air duct mount (recommended), wall mount
- Premier White®



Part #	Model #	Application	Humidity Ratings	Terminals
133211	H6062A1000/U	24VAC IAQ Control	Manual:10-90% (Adj); Auto: 20-60% (35% Default)	C, R, U, U, S, S

Humidity Controllers

H8908 SPST Manual Humidistat

- Provides automatic low voltage control of humidifier or ventilators in central heating and air conditioning systems
- SPST, Snap-acting, dust-proof switch designed for wall or surface duct mounting
- Positive on and off settings
- Type: steam
- Mounting: duct or remote mount (up to 200')
- Dimensions: 19"H x 11-1/4"W x 9"D



Part #	Model #	Application	Color
52790	H8908ASPST	24VAC Humidification	White

Models and Specifications are Subject to Change Without Notice

Humidifiers

Sail Switches

S688 Sail Switch

- Activates an electronic air cleaner, a humidifier, or other equipment in response to airflow from the system fan
- Mounts in the return air duct where the sail will be in the direct path of an unrestricted air stream
- Simplified installations with multi-speed fans, in-accessible air handlers, fan motors with voltage or phase different from controlled equipment; eliminated wiring to system fan
- Polyester film sail mounted on a micro switch snap switch
- Removable spring counterbalances sail to allow mounting in either vertical (up or down) or horizontal air flow
- Top and bottom conduit knockouts for wiring convenience
- Low air velocity switch operation makes at 250 fpm and breaks at 75 fpm
- Maximum ambient temperature: 125°F at switches, 170°F at sail



Part #	Model #	Description
9190	S688A1007	5" Wide Sail, 26.2 sq in of Area, 10" Insertion Length

Humidifier Plumb In-Line Scale & Sediment Filter

- Includes quick-connect fittings

Part #	Model #	Description
56441	50028044-001	For All Steam/Evaporative Humidifiers

Humidifier Replacement Pads

Part #	Model #	Description
28995	HC22A1007	Pad for HE100, HE150, HE220, HE225, Aprilaire 110, 220, 550, 558
29030	HC26A1008	Pad for HE200, HE250, HE260, HE265, HE360, HE365, Aprilaire 350, 360, 560, 568, 600, 700, 760, 768
28811	HC22E1003	HE225 Pad with AgION™ Coating for HE100, HE150, HE220, HE225, Aprilaire 110, 220, 550, 558
28812	HC26E1004	HE265 Pad with AgION™ Coating for HE200, HE250, HE260, HE265, HE300, HE360, HE365, Aprilaire 350,360,560,568,600,700,760,788

Honeywell Humidifiers

Humidifier Parts (Honeywell)



50024917-001



50041883-001



50041883-002

Part #	Model #	Description	For:
28977	32001615-001	Drain Fitting	HE220, HE225, HE260, HE265, HE360, HE365
32401	32001630-001	Perfectflo™ Water Distribution Tray	HE260, HE265, HE360, HE365
32400	32001632-001	Humidifier Pad Frame	HE260, HE265, HE360, HE365
28978	32001639-002	Solenoid Valve Assembly w/Water Feed Tube & Nozzle	HE220, HE225, HE260, HE265
29219	32001676-001	Printed Wiring Board Assembly	HE360, HE365
28988	32001752-001	Humidifier Hardware Kit	HE220, HE225, HE260, HE265, HE360, HE365
28982	32001876-001	Solenoid Valve Assembly, Includes Water Feed Tube	HE360, HE365
35860	32005376-001	Fan Motor	HE365, HE365
52787	50024917-001	10' Remote Mount Kit	TrueSTEAM™ Humidifiers
57654	50027997-001	Solenoid Valve	TrueSTEAM™ Humidifiers
75675	50027998-002	Water Level Sensor	TrueSTEAM™ Humidifiers
56993	50028001-001	Remote-Mount Nozzles (2)	TrueSTEAM™ Humidifiers
69554	50041883-001	DC Solenoid Valve	TrueEASE™ Humidifier
69593	50041883-002	AC Solenoid Valve	TrueEASE™ Humidifier
77574	50041890-002/U	Large Bypass Duct with Automatic Damper	TrueEASE™ Humidifier
64373	50043683-001	Water Backflow Prevention Valve w/Manual Shutoff	TrueSTEAM™ Humidifiers
63643	50046086-001/U	Reverse Osmosis Bundled Replacement Filters for 50045947	TrueSTEAM™ Humidifiers
63649	50046089-001/U	Reverse Osmosis Replacement No 3 Staging Tank	TrueSTEAM™ Humidifiers

Indoor Air Quality

Humidifier Parts



Part #	Model #	Description
36568	3200161-001	Saddle Valve Assembly for HE120, HE225, HE 265, HE365, HE420
69596	50057547-001	Circuit Board for HE300
69594	50057547-002	Circuit Board for HE150
69595	50057547-003	Circuit Board for HE250

Models and Specifications are Subject to Change Without Notice

Humidifiers

Residential Humidifiers

- 5-year limited warranty

Model 865 Steam Humidifier Kit

- Proven design using electrode technology
- Remote or duct mount with no additional accessories
- Supply water pressure 25 - 120 psi, hardness 3 - 36 grain/gal
- Canister replacement once per humidifier season under normal conditions
- Steam dispersion technology, ensures proper dispersion into the air
- No water filtration needed
- Automatic control, can be installed in manual mode
- Complements non-forced air heating sources and other specialty heating systems
- Electrical (11.5A): 11.5 GPD @ 120V, 20.5 GPD @ 208V, 23.3 GPD @ 240V
- Electrical (16A): 16 GPD @ 120V, 30 GPD @ 208V, 34.6 GPD @ 240V
- Includes:
 - Model 800 humidifier
 - Control
 - Dispersion tube
 - Steam hose
 - Drain tube
 - Fan pack



Part #	Model #	Evap Cap	Sq Ft Cap	Dimensions
131017	865	11.5 - 34.6 GPD	6,200	20-7/8" x 10-1/8" x 7-1/8"

Model 800 Steam Humidifier

- Proven design using electrode technology
- Remote or duct mount with no additional accessories
- Supply water pressure 25 - 120 psi, hardness 3 - 36 grain/gal
- Canister replacement once per humidifier season under normal conditions
- Steam dispersion technology, ensures proper dispersion into the air
- No water filtration needed
- Automatic control, can be installed in manual mode
- Complements non-forced air heating sources and other specialty heating systems
- Electrical (11.5A): 11.5 GPD @ 120V, 20.5 GPD @ 208V, 23.3 GPD @ 240V
- Electrical (16A): 16 GPD @ 120V, 30 GPD @ 208V, 34.6 GPD @ 240V
- Includes:
 - Control
 - Dispersion tube
 - Steam hose
 - Drain tube



Part #	Model #	Evap Cap	Sq Ft Cap	Dimensions
68683	800	11.5 - 34.6 GPD	6,200	20-7/8" x 10-1/8" x 7-1/8"

Humidifiers

Model 700 Plenum Mounted Power Humidifier

- Built-in fan pulls heated air directly from furnace
- Outdoor temperature sensor monitors slightest changes
- High capacity
- Electrical: 120V, 60Hz, 0.8A



Part #	Model #	Mode	Evap Cap	Cu Ft Cap	Dimensions
52735	700	Auto	18 gpd	4200	18" x 15-29/32" x 10-11/32"
52738	700M	Manual	18 gpd	4200	18" x 15-29/32" x 10-11/32"

Model 600 Bypass Humidifier

- Built-in bypass damper
- Converts from automatic to manual where outdoor sensor is impossible
- Simple wiring with 24V power source
- Electrical: 24V, 60Hz, 0.5A
- 6" diameter round opening



Part #	Model #	Mode	Evap Cap	Cu Ft Cap	Dimensions
52734	600	Auto	17 gpd	1,000 to 4,000	15-3/4" x 15-3/8" x 10-1/4"
52737	600M	Manual	17 gpd	1,000 to 4,000	15-3/4" x 15-3/8" x 10-1/4"

Model 500 Duct Mounted Bypass Humidifier

- Built-in bypass damper
- Equipped with drain to flush minerals from the system
- Electrical: 24V, 60Hz, 0.5A
- 6" diameter round opening



Part #	Model #	Mode	Evap Cap	Cu Ft Cap	Dimensions
52733	500	Auto	12 gpd	Up to 3,000	13" x 15-5/8" x 10-1/4"
52736	500M	Manual	12 gpd	Up to 3,000	13" x 15-5/8" x 10-1/4"

Model 400 Bypass Humidifier

- Built-in bypass damper
- No tank to clean
- For use in homes with septic systems or where a floor drain is not available
- Electrical: 24V, 60Hz, 0.5A
- 6" Diameter round opening



Part #	Model #	Mode	Evap Cap	Cu Ft Cap	Dimensions
52732	400	Auto	17 gpd	Up to 4,000	15-3/4" x 15-3/8" x 10-1/4"
57401	400M	Manual	17 gpd	Up to 4,000	15-3/4" x 15-3/8" x 10-1/4"

Humidifiers

Model 350 Self-Contained Humidifier

- For homes with radiators or baseboard heat, also works equally well with central heating and cooling systems
- In-duct unit
- Designed for application in up to 4,500 sq ft tightly constructed homes
- Electrical: 120V, 60Hz, 0.5A



Part #	Model #	Evap Cap	Dimensions
45498	350	0.50 GPD	12-3/4" x 13-3/4" x 15-1/2"

Humidifier Parts & Accessories

Automatic Humidifier Control

- Fits plenum mounted humidifier



60

Part #	Model #	Description	Dimensions
71208	60	Digital Electronic Auto	4" x 6"
71183	62	Automatic Digital Humidistat	4" x 6"

Manual Humidistat

- Wall or duct-mounted
- Maintains optimum indoor relative humidity
- Low voltage



Part #	Model #	Description
53639	4655	Manual Analog Humidistat

Current Sensing Relay

- For interfacing Aprilaire® humidifiers or EAC's with multi-speed blower motors
- No need for line voltage wiring



50



51

Part #	Model #	Power
45506	50	240V
45507	51	120V

Fan Blade

Part #	Model #	Fits Models:
45586	4247	700, 760, 768

Humidifiers

Humidifier Parts & Accessories



4238



4184



80

Part #	Model #	Description
132718	4732	Base for Model 700 Humidifier
45585	4238	Circuit Board for 700, 760, 768
47897	4332	Damper Assembly, Includes Spring, Knob, and Damper Door
45573	4223	Drain Spud Kit for 550, 560
46794	4079	Feed Tube and Nozzle
46516	4335	Feed Tube Assembly for 400, 500, 600
45576	4004	Inline Strainer
71181	4981	Internal Control Circuit Board for 800
46142	4184	Nozzle for 350, 360, 550
45582	4232	Orifice (Blue) for 350, 360, 440, 700, 700A, 700M, 760, 760A, 768
45577	4231	Orifice (Yellow) for 400, 400A, 400M, 500, 500A, 500M, 550, 550A, 558, 560, 560A, 568, 600, 600A, 600M
57667	4740	Relay for 700, 700M, 700A
45578	4010	Remote Transformer, Converts 110V to 24V Required By Humidifier
71083	80	Replacement Canister/O-Ring for 800 Steam Humidifier
46660	4336	Resistor for #56 or #58 Digital Control
89516	5306	Transformer for Series 800 Humidifier
45847	4235	Tube and Nozzle for 700, 760, 760A, 768
46120	4226	Water Feed Tube with Compression Sleeve for all 500 or 600 Series
164850	4792	Maintenance Kit for 800, 500A, 500M
164851	4839	Maintenance Kit for 600, 600A, 600M
164852	4793	Maintenance Kit for 550, 550A, 558
164853	4750	Maintenance Kit for 700, 760, 768
165124	4837	Maintenance Kit for 560, 560A, 568

Replacement Motor for Powered Humidifiers

Part #	Model #	Fits Models:
45584	4237	700, 760, 768
57707	4670	700M, 700A

Models and Specifications are Subject to Change Without Notice

Humidifiers

Replacement Water Panel

- For interfacing Aprilaire® humidifiers or EAC's with multi-speed blower motors
- No need for line voltage wiring



Part #	Model #	Fits Models:
45500	10	110, 220, 500, 500A, 500M, 550, 550A, 558
45501	12	112, 224, 440, 445, 445A, 448
45502	35	350, 360, 560 Series, 600 Series, 700 Series
47011	45	400, 400A, 400M
188641	80LC	800

Scale Control Insert

- For use with:
 - Water panel (35)
 - Water distribution tray (4331)



Part #	Model #	Fits Models:
66100	4181	350, 360
45571	4330	600
45583	4236	560, 560A, 568, 700, 760, 760A, 768
58782	4640	500

Solenoid Valve



Part #	Model #	Fits Models:
45575	4040	All Models Except Commercial and 800, 330, 445, 110, 112, 350, 360
50138	4191	350, 360
45903	4005	110, 112

Saddle Valve

Part #	Model #	Description
52730	4001	Saddle Valve

Water Pan/Tray



Part #	Model #	Fits Models:
45904	4246	700, 760, 768
45572	4331	500, 600
45580	4218	550, 550A, 558

Humidifiers

Legacy Series Humidifiers

1042LH Legacy Flow-Through Drain Type Humidifier

- Patented water distribution system for maximum evaporative performance
- Bypass duct: 6" diameter (collar supplied)
- Plenum opening: 9-1/2"H x 10-1/4"W
- Coverage: up to 2,800 sq ft
- Vapor pad replacement: 990-13 (GFI #7002), replace once per year
- Includes:
 - Shut-off damper with 6" start collar
 - 15' of 5/8" diameter drain hose
 - Saddle & solenoid valves
 - Fittings
 - Transformer
 - MHX3 Manual control humidistat
- 5-year limited warranty



Part #	Model #	Description	Capacity 120° Plenum Temp	Unit Dimensions H x W x D	Electrical
14694	1042-LH	Bypass, MHX3 Manual Humidistat	17 gpd	11-1/2" x 15" x 9"	24V

1099LHS Legacy Series Humidifier

- 23 GPD (GPD shown is at 140° plenum temperature)
- For homes up to 3,000 Sq. Ft.
- Unit size: 16" W x 16" H x 11" D
- Plenum opening: 13-1/4" W x 9-1/4" H
- Bypass duct: 7" diameter (collar supplied)
- Replacement vapor pad GA23 (GFI #7923) or 1099-20 (GFI #7047), replace once per year



Part #	Model #	Description
2268	1099-LHS	Fan Powered Humidifier, MHX3 Humidistat

1137 Legacy Fan-Powered Humidifier

- Installs on vertical warm air supply plenum, no by-pass required
- Plenum opening: 9-1/2"H x 15"W
- Coverage: up to 3,000 sq ft
- Vapor pad replacement: 990-13 (GFI #7002), replace once per year
- Includes:
 - Built-in isolation relay
 - Humidistat
 - 120V power cord
 - 15' of 5/8" diameter drain hose
 - Saddle & solenoid valves
- 5-year limited warranty



Part #	Model #	Description	Capacity 120° Plenum Temp	Unit Dimensions H x W x D
16948	1137	Fan Power, MHX3 Manual Humidistat	18 gpd	14" x 16"

Humidifier Accessories

Current Sensing Relay

- Makes blower control isolation easy



Part #	Model #	Description
45297	GA50	24V Current Sensing Relay

Evaporator Pad Replacement

- Aluminum evaporator material enclosed in heavy wire frame and channeling
- Pad has super absorbent coating



990-13



1099-20

Part #	Model #	Description
17740	990-13	11-3/4"H x 9-3/4"W Evaporator Pad for Model SL-16, 1042, 1040, 1137
18696	1099-20	12"H x 14-1/4"W Evaporator Pad for Model 1099, 950

Models and Specifications are Subject to Change Without Notice

Humidifiers

Relay Assembly



Part #	Model #	Description
54532	GA4238	Relay Assembly for Legacy 1137, 1137R; Elite 1000, 1000A, 1000M, 1000XM

Solenoid Valve

- Low voltage solenoid valve assembly for whole house humidifiers



Part #	Model #	Description
18919	1099-42	24V Solenoid Valve for 1099L/LH/R

1042 Series Humidifier Parts

- 24 volt, AC electrically-operated valve that turns the water on and off to your humidifier



Part #	Model #	Description
18120	990-53	Solenoid Valve Assembly - 24V for 1042/1137 (Includes Fittings)

1137 Series Humidifier Parts



1137-8



1137-17

Part #	Model #	Description
5785	1137-8	Humidifier Fan Motor
16648	1137-17	Solenoid Valve Assembly

Humidifiers

Humidifiers

Mister Mini Humidifier

- Designed for use with fossil fuel fired furnaces
- Humidifies homes up to 2,000 sq ft
- Mechanical humidistat
- Mounts directly to the duct
- Required opening: 3.125" x 3.125"
- Push-to-lock fittings
- Tilt-out nozzle assembly
- Atomized water humidity
- Capacity:
 - @140°F Air: 12.5 gallons per day at 60 psi
 - @120°F Air: 12.5 gallons per day at 60 psi
 - @100°F Air : Not recommended for air temperatures <100°
- 5-year limited warranty



Part #	Model #	Size (H x W x D)
77620	265000-001	4-1/4" x 4-1/4" x 3-22/25"

Humidifiers

Model 250 Humidifier

- High capacity flow thru
- Can be used with any forced air furnace and mounted on either the warm air supply or the cold air return
- Includes:
 - 24V humidistat
 - Self-piercing saddle valve
 - Transformer
 - By-pass duct
 - Drain tube



Part #	Model #	Voltage	Electrical	Capacity	Plenum Opening	Unit Size	Square Footage
66803	250	24V	60Hz	.65 GPH	9-1/2" x 9-1/2"	13" x 11"	

Water Pad Replacements



Part #	Description
62774	Water Pad Replacement for 10, 110, 220, 550
62775	Water Pad Replacement for 12, 112, 224, 440, 445
62776	Water Pad Replacement for 35, 350, 360, 560, 760

Self-Tapping Water Valve

- Installs on copper tube lines from 3/8" OD to 1-1/8" OD without drilling or shutting off water



Part #	Model #	Description
16437	131	Self-Tapping Valve

Models and Specifications are Subject to Change Without Notice

Dehumidifiers

Honeywell Dehumidifier

DR Whole House Dehumidifier

- Recommended for 2 to 3 ton systems
- Can be centrally ducted for whole-house dehumidification or unducted for moisture control in attics or smaller crawl spaces
- MERV 11 media filtration improves performance life, efficiency and indoor air quality
- Onboard dehumidistat allows the unit to run without additional wiring
- Operates with R-410A refrigerant
- 5-year warranty



DR65A3000

Part #	Model #	Capacity
194807	DR65A3000	Up to 65 Pints per day

Humidity Controllers

H8908 SPST Manual Dehumidistat

- Provides automatic low voltage control of dehumidifiers or ventilators in central heating and air conditioning systems
- SPST, Snap-acting, dust-proof switch designed for wall or surface duct mounting
- Positive on and off settings
- Type: steam
- Mounting: duct or remote mount (up to 200')
- Dimensions: 19"H x 11-1/4"W x 9"D
- White



Part #	Model #	Application
57381	H8908DSPST	24VAC Dehumidification

Dehumidifiers

1800 Series Whole-House Dehumidifier

- No tanks to empty
- Automatically manages moisture based on changing conditions
- Settings from 40% - 80%
- MERV 8 Filter
- 1/2" EPS cabinet insulation
- Electrical: 120-1-60, 6.3A
- Energy Star® rated
- 5-year warranty



1800 Series



Part #	Model #	Capacity	Dimensions	CFM	Weight
132616	1830	8.75 gpd	14-1/2" x 12-1/2" x 25"	70-120	67 lbs
137564	1850	11.87 gpd	14-1/2" x 12-1/2" x 27-1/2"	200-265	75 lbs
164148	1870	16 gpd	19-1/2" x 18-3/4" x 30"	178-310	113 lbs

Indoor Air Quality



A MUNCH'S SUPPLY COMPANY

Let us be your source for quality products from leading manufacturers.

Fresh Air

Energy Recovery Ventilators (ERV)

- For all seasons and climates
- Static plate energy transfer core
- Passive defrost, condensate drain not required
- Balancing dampers not required
- Multi-position mounting
- Heavy-gauge, powder painted steel cabinet
- Permanently lubricated motor bearings
- Closed cell foam gasketing for insulation integrity
- 1" Duct board insulation with cleanable foil face
- May be installed in conditioned and unconditioned spaces
- Includes percent timer control



American Standard

Part #	Model #	Nominal Airflow CFM	Power Supply	Collar Connection	Uncrated Dimensions H x W x D	Ship Wt
191495	TERVR100A9P00A	130	120/1/60	6" & 8" Dbl	20-1/2" x 28-3/4" x 13"	65 lbs
191494	TERVR200A9P00A	200	120/1/60	6" & 8" Dbl	20-1/8" x 28-3/4" x 23-7/8"	85 lbs
70035	TERVR300A9P00A	300	120/1/60	8" Round	20-1/8" x 28-3/4" x 23-7/8"	95 lbs

Point of Use Pushbutton Control

American Standard

Part #	Model #	For use with:
65102	ACONTV10APBC0A	ERV Models 100, 200, and 300

Trane

Part #	Model #	For use with:
70032	TCONTV10APBC0A	ERV Models 100, 200, and 300

**QUALITY.
SERVICE.
TOMMARK.**

Fresh Air

Fresh Air Ventilators

TrueFRESH™ Balanced Ventilation System

- Eliminates the need for overhead ducting
- Removable duct collars
- Damperless balancing
- Adjustable hanging straps
- Centralized wiring and speed control
- Customizable
- Compact size
- Tradeline
- Meets ASHRAE 62.2 standards
- Energy Star® rated
- 5-year warranty



Part #	Model #	CFM	Electrical	Description
69098	VNT5150H1000	150	120VAC	150 CFM HRV
69100	VNT5200H1000	200	120VAC	200 CFM HRV

Fresh Air Ventilation System



Part #	Model #	Description
69097	VNT5150E1000	120VAC 150 CFM Energy Recovery Ventilator
69099	VNT5200E1000	120VAC 200 CFM Energy Recovery Ventilator
176210	40003916-548	Powerhead Replacement
77677	50053952-020	Ventilation Timer

W8150 Fresh Air Ventilation System

- The control operates a fresh air intake damper and, when necessary, activates the main HVAC blower to efficiently meet ASHRAE ventilation rates
- Smart Control optimizes air delivery by syncing ventilation calls with heating/cooling
- Easy-to-use input dials allow customized ventilation for each installation
- Test mode that includes immediate feedback to installer to confirm that air delivery requirements of selected ventilation standard are being met
- Economical supply-only ventilation; works with forced air system
- Can be used with other equipment, such as an HRV/ERV, for balanced ventilation
- 24VAC @ 60Hz
- Designed to help meet local ventilation codes and standards, including ASHRAE 62.2-2010 Standard, Ventilation and Acceptable Indoor Air Quality in Low-Rise Residential Buildings



Part #	Model #	Description
42283	W8150A1001	50 to 160 CFM for use with VNT5070, VNT5200, VNT5150, EARD6

Models and Specifications are Subject to Change Without Notice

Fresh Air

Y8150 Fresh Air Ventilation System with TrueZONE Damper

- Operates a fresh air intake damper and when necessary activates the main HVAC blower to efficiently meet ASHRAE ventilation rates
- Designed to help meet local ventilation codes and standards, including ASHRAE 62.2-2010
- Smart control optimizes air delivery by syncing ventilation calls with heating/cooling
- Input dials allow customized ventilation for each installation
- Test mode includes immediate feedback to installer
- Supply-only ventilation
- Works with forced air systems, and can also be used with HRV/ERV to balance ventilation
- Includes:
 - Fresh air ventilation control (W8150A1001)
 - Fresh air damper (EARD6TZ)
 - Transformer (AT120B1028)



Part #	Model #	Capacity	Free Air Flow	Power	Weight
170329	Y8150A1017	1,000 - 4,600 sq ft	160 CFM	24VAC	51 lbs

TrueZONE Automatic Round Dampers

EARDTZ Fresh Air Damper

- Round damper with a 24VAC powered-open/spring-closed reversible motor
- Used for fresh air intake for ventilation or for combustion makeup air
- Adjustable damper position range stops
- Single-blade damper
- Shipped as power open/spring return closed damper
- Galvanized steel
- Quiet operation
- Can be field-converted to power closed/spring return open damper
- Blade closes off tightly against gasket for minimal leakage
- Male (crimped) and female (uncrimped) ends to connect to any rigid or flexible round duct
- Motor mount: top and side



Part #	Model #	Size
169920	EARD6TZ	6"

Ventilation Controls

Fresh Air Ventilation Control System

- Controller that controls when and how long to ventilate
- Will not ventilate if outdoor temperature is above 100°F or below 0°F or if the central heating system requests ventilation when outdoor temperature is between 0° to 20°F
- Will not ventilate if it will raise indoor relative humidity above 55%



Part #	Model #	Description
194639	8126X	Fresh Air Ventilator Controller

Automated HVAC System Accessories

Part #	Model #	Description
58678	8120X	Digital Ventilation Controller

Fresh Air

Fresh Air Exchangers

- Design air flow 1,200 CFM and 0.3"wc external duct resistance
- No condensate drain or defrost cycles needed
- Connects with 6" diameter ducts with no special adapters
- 3-year limited warranty
- 5-year core warranty



Part #	Model #	Capacity	Free Air Flow	Power	Dimensions	Weight
45521	8100	3,600 sq ft	150 CFM	120VAC, 60Hz, 1.4A	20-9/16" x 37-3/8" x 12-3/4"	76 lbs



Indoor Air Quality

VHR Series Heat Recovery Ventilators

- Aluminum heat recovery core
- Vertical discharge
- (2) ebm™ Motors with backward curved blades
- (2) Washable electrostatic filters
- Automatic defrost cycle - fan shutdown
- Remote low voltage
- 4" Steel duct connections
- Electrical: 120V, 60Hz
- Airflow balancing using Fantech's "TRUE" motor adjustment feature
- Residential warranty:
 - 7-year warranty on motors
 - 5-year warranty on parts
 - Lifetime warranty on core (limited)



Part #	Model #	Description
141880	VHR70R	70 CFM @ 0.3 High Speed, 17-3/16"H x 10-1/5"W x 22-1/2"L

Optional Controls

- For SHR/VHR Heat Recovery Units



EDF1



RTS3

Part #	Model #	Description
66111	EDF1	On/Off, Low/High Speed Operation & Cycle Timer
72896	RTS3	Intermittent Bathroom Timer with 20/40/60 Min High Speed Boost

Models and Specifications are Subject to Change Without Notice

Zoning

AccuLink™ II/ComfortLink™ II System

7-Day Digital Programmable Control

- Controls communicating for conventional 24V HVAC systems with 24V relay panel accessory
- 7" High definition color LCD display
- 1-Touch pre-sets for home, away and sleep
- Customizable home screen
- 5-Day weather forecast, local radar image and weather alerts (via wireless home network)
- Weekly and monthly system run time monitor
- Built-in dual fuel economic calculator
- Digital photo album with slide show screensaver option
- Embedded diagnostics
- Heating humidification control
- Cooling dehumidification control
- Smart continuous fan
- Adjustable continuous fan airflow
- Service reminders
- Upgradable firmware via internet (SD card required)
- Keypad lock
- Operating temperature: 25° to 175°F, 5% to 95% relative humidity



AZONE940



TZONE940

American Standard

- Compatible with AccuLink™ II zoning systems - software version 2.0 or later required

Part #	Model #	Description	Used with:	Dimensions
74870	AZONE940AC52ZA	Remote Sensor	AccuLink™ Zoning Systems	3-3/8"H x 5-1/2"W x 1-1/8"D
72811	AZTSK500BB32MA	Remote Sensor	AccuLink™ Zoning Systems	4"H x 5-3/4"W x 1-1/4"D

Trane

- Compatible with ComfortLink™ II zoning systems

Part #	Model #	Description	Used with:	Dimensions
74871	TZONE940AC52ZA	Zoning Sensor	XL950 Control	3-2/5"H x 5-1/2"W x 1-1/10"D

Zone Control Unit

Part #	Model #	Description
48843	ZZSENSALO400AA	Zone Control Sensor for ComfortLink Systems

Front Bezel for TZONE940AW52ZA Control

Part #	Model #	Color
134127	TZGRA940ABEZEL	Graphite
134128	TZWHT940ABEZEL	White

Zoning

AccuLink™II/ComfortLink™II Zoning Assembly

- Trane®/American Standard® variable speed indoor unit (air handler/gas furnace) required
- Automatically sets maximum CFM per zone
- Compatible with 24V systems with the addition of 24V relay panel
- Controls 24V power open, power close modulating dampers
- Automatically detects installed dampers
- Supports 2-wire and 3-wire zone sensors
- Adjustable damper motor travel times of 15 to 60 seconds
- Requires field supplied 24V power supply
- Up to (4) 1.5 VA dampers can be wired parallel to each zone
- Backlit LCD display for easy setup and service
- Optional return and mixed air sensors are available
- Removable low voltage terminal blocks for easy service and replacement
- Includes:
4-Zone communicating zone panel, discharge air sensor, static pressure transducer and housing supply, return air static probes and connecting tubing, and (3) wiring blocks

American Standard/Trane

Part #	Model #	Description
74733	ZZONEPNLAC52ZB	AccuLink™ II/ComfortLink™ II Zoning Assembly

AccuLink™ II/ComfortLink™ II Zone Expander Panel

- Expands maximum number of zones per system to eight
- Controls 24V power open, power close modulating dampers
- Automatically detects installed dampers
- Supports 2-wire and 3-wire zone sensors
- Adjustable damper motor travel times of 15 to 60 seconds
- Requires field supplied 24V power supply
- Required with more than (4) zones
- Dimensions: 9-3/10"H x 8"W x 1-9/10"D

American Standard/Trane

Part #	Model #	Description
73799	ZZONEEXPAC52ZB	AccuLink™ II/ComfortLink™ II Zone Expander Panel

Zoning

Dampers

- 24VAC powered open, powered close
- 18 Gauge 3-wire connection
- 1.5 VA damper actuator with 60 second travel time
- 18 in-lbs of torque
- Manual gear release
- Screw terminal blocks
- 97% leak proof rating
- Aluminum blades and frame
- Motor is always mounted on second dimension



Square Modulating Damper

Part #	Model #	Uncrated Dimensions H x W	Motor Mount
74592	ZDAMPBMMMA0810A	8" x 10"	Bottom
74753	ZDAMPBMMMA0812A	8" x 12"	Bottom
74754	ZDAMPBMMMA0814A	8" x 14"	Bottom
74755	ZDAMPBMMMA0816A	8" x 16"	Bottom
74756	ZDAMPBMMMA0818A	8" x 18"	Bottom
74757	ZDAMPBMMMA0820A	8" x 20"	Bottom
74759	ZDAMPBMMMA0824A	8" x 24"	Bottom
75839	ZDAMPBMMMA1012A	10" x 12"	Bottom
76922	ZDAMPBMMMA1014A	10" x 14"	Bottom
75840	ZDAMPBMMMA1016A	10" x 16"	Bottom
75841	ZDAMPBMMMA1020A	10" x 20"	Bottom
75842	ZDAMPBMMMA1024A	10" x 24"	Bottom
74752	ZDAMPSMMA0808A	8" x 8"	Side
75851	ZDAMPSMMA1008A	10" x 8"	Side
74751	ZDAMPSMMA1010A	10" x 10"	Side
74744	ZDAMPSMMA1208A	12" x 8"	Side
74747	ZDAMPSMMA1408A	14" x 8"	Side
74745	ZDAMPSMMA1608A	16" x 8"	Side
74746	ZDAMPSMMA1808A	18" x 8"	Side
74591	ZDAMPSMMA2008A	20" x 8"	Side
73794	ZDAMPSMMA2010A	20" x 10"	Side

Round Modulating Damper

- Flexible shut-off seal provides 98% closure

Part #	Model #	Fits Round Duct Size
74763	ZDAMPBMMMA086A	6"
74764	ZDAMPBMMMA088A	8"
74765	ZDAMPBMMMA0810A	10"
75836	ZDAMPBMMMA0812A	12"

Zoning

Retrofit Round Modulating Damper

- 24 VAC Powered open/Powered closed
- Slip-In-Design installs quickly
- 1.5 VA damper actuator with 60 second travel time
- 18 in. lbs. of torque
- Flexible shutoff seal provides 98% closure

Part #	Model #	Fits Round Duct Size
74766	ZDAMPRRMA0006A	6"
75837	ZDAMPRRMA0007A	7"

Zoning Parts

Part #	Model #	Description	Use with:
56456	ASYSTAT106A	Single Setpoint Manual Changeover Thermostat	YC*150-301
56848	ASYSTAT108A	Dual Setpoint Manual or Automatic Changeover Thermostat	YC*150-301
70857	BAYSENS106A	Auto/High Fan, Cool/Off/Heat Single Setpoint Thermostat	-
70858	BAYSENS108A	Auto/High Fan, Cool/Off/Heat/Auto Dual Setpoint Thermostat	-
56918	ASYSTAT777A	Programmable Night Setback	Reliabel™ Units Only
66305	BAYSENS119A	Programmable Zone Sensor	-

Honeywell

TrueZONE® Panels & Kits

HZ432 TrueZONE® for Conventional & Heat Pump Applications up to (3) Zones

- Intuitive installer setup, digital display uses real language to guide installer through (4) easy steps
- Standard checkout procedure
- Robust push terminals
- Common-sense LEDs
- Clean, professional installation
- Smaller footprint
- Variable-speed fan control
- Accessories include:
 - TrueZONE® zone control panel
 - 40VA Transformer (AT140)
 - Discharge air temperature sensor (C7735A)
- Advanced dual fuel operation
- Use with TAZ-4 Add-A-Zone to expand to (32) zones
- RedLINK™ enabled for up to (4) wireless zones when used with THM4000R1000 wireless adapter
- Controls up to 3 heat/2 cool conventional or up to 2-stages compressor and 2-stages fossil fuel in dual fuel mode



Part #	Model #	Description
52830	HZ432K	Kit for Conventional, Heat Pump or Dual Fuel Applications up to (32) Zones (3 Heat/2 Cool) with Accessories, RedLINK™ Enabled
52754	HZ432	Panel Only for Conventional, Heat Pump or Dual Fuel Applications up to (32) Zones (3 Heat/2 Cool), RedLINK™ Enabled

Models and Specifications are Subject to Change Without Notice

Zoning

HZ322 TrueZONE® for Conventional & Heat Pump Applications up to (3) Zones

- Intuitive installer setup, digital display uses real language to guide installer through (4) easy steps
- Standard checkout procedure
- Robust push terminals
- Common-sense LEDs
- Clean, professional installation
- Smaller footprint
- Variable-speed fan control
- Accessories include:
 - TrueZONE® zone control panel
 - 40VA Transformer (AT140)
 - Discharge air temperature sensor (C7735A)
- RedLINK™ enabled for wireless operation when used with THM4000R1000 wireless adapter
- Controls up to 2 heat/2 cool conventional or 2 heat/1 cool heat pump



Part #	Model #	Description
52831	HZ322K	Kit for Conventional & Heat Pump Applications up to (3) Zones (2 Heat/2 Cool) with Accessories, RedLINK™ Enabled
52755	HZ322	Panel Only for Conventional & Heat Pump Applications up to (3) Zones (2 Heat/2 Cool), RedLINK™ Enabled

HZ311 TrueZONE® for Single-Stage Conventional Applications up to (3) Zones

- Robust push terminals
- Common-sense LEDs
- Clean, professional installation
- Smaller footprint
- Variable-speed fan control
- Accessories include:
 - TrueZONE® zone control panel
 - 40VA Transformer (AT140)
 - Discharge air temperature sensor (C7735A)
- Controls up to 1 heat/1 cool conventional



Part #	Model #	Description
52832	HZ311K	Kit for Conventional, Single-Stage Applications up to (3) Zones with Accessories
52756	HZ311	Panel Only for Conventional, Single-Stage Applications Up to (3) Zones

TotalZONE™ Panels

TAZ TotalZONE® Add-A-Zone™ Zone Control Panel

- Used to add zones to HZ432 TrueZONE panel
- Use multiple TAZ-4 control panels to control up to (32) zones



Part #	Model #	Description
34329	TAZ-4	3 Heat/2 Cool, 4-Zone Panel, May Use In Multiples up to (32) Zones

Zoning

TrueIAQ™ Total Home Comfort System

- Manages humidification, dehumidification, ventilation and bathroom fans from a central point in your home
- Setting changes can be made easily with the touch of a button
- Simultaneously displays both indoor and outdoor temperature and humidity levels on-screen
- Automatically adjusts inside settings based on outdoor conditions
- Includes individual air quality enhancements to your system with TrueIAQ™, or integrate them all as part of a total air quality system
- Intuitive digital backlit display



Part #	Model #	Description
52789	DG115EZIAQ	Steam Type, 120VAC, Duct or Remote Mount with Outdoor Temperature/Humidity Sensor, White

Zone Control Dampers

ARDTZ Automatic Round Damper

- Designated as power closed/spring return open damper for use with Honeywell Zoning Systems
- Low leakage control of circulating air in heating, cooling and ventilation systems
- Galvanized steel, single-blade damper
- Blades close off tightly against gasket for minimal leakage
- Can be field-converted when used as an independent zone or for fresh air intake
- 24V, 60Hz, 1-position motor type, (2-3) wires to motor
- Rated to operate up to 1"wc
- Simplified range stops
- Replaces ARD dampers



Part #	Model #	Size
161644	ARD6TZ/U	6"
161645	ARD8TZ/U	8"
161646	ARD9TZ/U	9"
161647	ARD10TZ/U	10"
161648	ARD12TZ/U	12"
161649	ARD14TZ/U	14"
161650	ARD16TZ/U	16"

Zoning

RRD Retrofit Round Damper

- Inserts into rigid round ducts for retrofit zoning in forced air heating and cooling
- Power open, power closed actuator draws 2.5 VA allowing multiple dampers per zone
- Quiet, long life motor automatically shuts itself off in full open and closed positions
- Gaskets around blade and under motor housing for low internal leakage and very low external leakage
- Range stops with easy adjustment from top of motor
- Easy to see and reliable mechanical blade position indicator
- Easy to hook up with conventional thermostat wire
- Simple manual blade positioning with push button gear release
- Motor mount: direct connection to damper shaft



Part #	Model #	Size
47997	RRD6	6"
47998	RRD7	7"
47999	RRD8	8"

TrueZONE® Bypass Constant Pressure Regulating Damper (CPRD)

- Round static pressure relief damper
- Used in forced-air bypass applications to relieve excess static pressure
- Quick installation and setup in any orientation
- No weight to adjust
- Engineered to provide constant system pressure regardless of changes in zones ceiling or blower speed
- Motor: calibrated spring tension regulator
- Motor or actuator mounting: quick connect regulator



Part #	Model #	Size
123805	CPRD8	8"
123806	CPRD10/U	10"
123748	CPRD12/U	12"
123825	CPRD14/U	14"
18500	SPRD12	12"

Zoning

ZD-TZ Series Damper

- Power close, spring open
- 24V spring-return motor used to control circulating air in HVAC systems
- Used when a normally open damper is required, typically used with the TrueZONE™ systems and other electronic zoning damper systems
- Kevlar gearing reduces wear, more than doubling damper life
- Adjustable range stops
- Mechanical visual position indicator for damper status
- Solid construction using extruded aluminum frame and blades
- Parallel blade design for low leakage performance
- Quieter operation with fewer blades
- Simple, easy-to-wire, 2-wire installation
- Compatible with conventional and networked zoning
- Ordering instructions: order ZD + dimension 1 x dimension 2 note: motor is always mounted on dimension 2 side
- Damper can be installed in any orientation (mounting side can be on either the bottom or the side of the duct)
- Optional LED indicator wire
- Simplified ring stops



Part #	Model #	Size	Shape	Motor Mount
161693	ZD8X8TZ/U	8" x 8"	Square	Side
161686	ZD8X10TZ/U	8" x 10"	Rectangular	Side
161687	ZD8X12TZ/U	8" x 12"	Rectangular	Side
161688	ZD8X14TZ/U	8" x 14"	Rectangular	Side
161689	ZD8X16TZ/U	8" x 16"	Rectangular	Side
161690	ZD8X18TZ/U	8" x 18"	Rectangular	Side
161691	ZD8X20TZ/U	8" x 20"	Rectangular	Side
188915	ZD8X22TZ/U	8" x 20"	Rectangular	Side
161692	ZD8X24TZ/U	8" x 24"	Rectangular	Side
161659	ZD10X8TZ/U	10" x 8"	Rectangular	Side
161652	ZD10X10TZ/U	10" x 10"	Square	Side
161653	ZD10X12TZ/U	10" x 12"	Rectangular	Side
161654	ZD10X14TZ/U	10" x 14"	Rectangular	Side
161655	ZD10X16TZ/U	10" x 16"	Rectangular	Side
161656	ZD10X18TZ/U	10" x 18"	Rectangular	Side
161657	ZD10X20TZ/U	10" x 20"	Rectangular	Side
161658	ZD10X24TZ/U	10" x 24"	Rectangular	Side
161665	ZD12X8TZ/U	12" x 8"	Rectangular	Side
161669	ZD14X8TZ/U	14" x 8"	Rectangular	Side
161666	ZD14X10TZ/U	14" x 10"	Rectangular	Side
161672	ZD16X8TZ/U	16" x 8"	Rectangular	Side
161670	ZD16X10TZ/U	16" x 10"	Rectangular	Side
161676	ZD18X8TZ/U	18" x 8"	Rectangular	Side
161681	ZD20X8TZ/U	20" x 8"	Rectangular	Side
161677	ZD20X10TZ/U	20" x 10"	Rectangular	Side
161678	ZD20X12TZ/U	20" x 12"	Rectangular	Side
161685	ZD24X8TZ/U	24" x 8"	Rectangular	Side
161683	ZD24X10TZ/U	24" x 10"	Rectangular	Side

Models and Specifications are Subject to Change Without Notice

Zoning

Zoning Parts & Accessories CPR Bypass Replacement Regulator



Part #	Model #	Description
159621	CPR8	8" Regulator
169673	CPR10/U	10" Regulator
169674	CPR12	12" Regulator
169675	CPR14	14" Regulator

Zone Control Damper Accessory M847D Damper Actuator

- Low voltage, spring-return damper actuator
- Equipped with anti-rotation and drive shaft extensions for direct mounting to 7/16" diameter coupling style dampers
- Adjustable range stops
- Direct replacement for M847D1004



Part #	Model #	Description
35029	M847D1012	24VAC, 2-Position, Spring Return Damper Actuator for use with ARD, EARD, ZD Zone Dampers
161641	M847D-VENT/U	24VAC, 2-Position, Spring Return Damper Actuator for use with EARD Zone Dampers
170026	M847D-ZONE	24VAC, 2-Position, Spring Return Damper Actuator for use with ARD, EARD, ZD Zone Dampers

MSTN Damper Actuator

- Power open/power close damper motor
- Use with MVRV; MVRH; SRTD; IOBD; AOBD-BM; AOBD; ASCD; ARCD



Part #	Model #	Description
10206	MSTN	Power Open/Power Close Damper Actuator

Direct-Coupled Damper Actuator Parts & Accessories

Part #	Model #	Description
71860	4074EKV	Auxiliary Switch, 24VAC for M6415; M7215; M7415; M8405; M8415

Zoning

Dampers

Retrofit Zoned Comfort Damper

- Spring-return round damper designed to be inserted in a round branch duct
- Completely automatic
- Spring-open operation
- LED Indicators



Part #	Model #	Size
82150	6705	5"
45555	6706	6"
82151	6707	7"
82152	6708	8"

Dampers

Distribution Panel

- Works with up to 10 dampers for zoning applications
- Features LED lighting for ease of use



Part #	Model #	Description
45551	8028	Damper Power Distribution Panel

Aprilaire Zoning Panels

- 18-30VAC, 50/60 Hz
- Completely automatic
- Features include:
 - 1 heating and 1 cooling stage
 - Equipment protection
 - Vacation mode – Zone 1 thermostat controls all zones



Part #	Model #	Description
45548	6202	Aprilaire 6202 Single Stage Zoning Panel Up to 2 Zones (1H/1C)
45549	6203	Aprilaire 6203 Single Stage Zoning Panel Up to 3 Zones (1H/1C)
52876	6303	Aprilaire 6303 Multi Stage Zoning Panel Up to 3 Zones (2H/1C)

Zoning

System 2000 GEN II Commercial Zoning System

GEN II Controller

- Universal vote based auto changeover controller
- Fully modulating system
- Integrated capacity control
- Leaving air temperature display
- Automatic purge and ventilation modes
- Auxiliary heat control included for each zone
- Night setback operation included
- Remote thermostat locking feature
- 2-Hour override capability
- Simple startup diagnostic
- 2-Wire daisy chain
- No programming required
- No computer required for setup or operation
- Communication: (2) wire twisted pair
- (1) Temperature sensing thermistor
- Use fused transformer
- 0.7 VA Power consumption
- Operating temperature: 32° to 160°F (0° to 71°C)
- Operating humidity: 10% to 95%, non-condensing
- Dimensions: 7-1/4"H x 10"W x 3"D



Part #	Model #	Description
51162	GEN II	Universal Gas/Electric or Heat Pump Controller, Supports 2 to 10 Zones per System

Modulating Thermostats

MODSTAT Communicating/Modulating/2-Position Zone Thermostat

- Auto changeover
- Controls modulating medium pressure and heavy duty dampers
- No batteries required
- Accurate temperature control
- Electronic lock
- Illuminated large LCD display
- Function buttons on front cover
- Configurable reheat and auxiliary heat output
- ModStat to control power open/close dampers
- Input: 24VAC, platinum thermistor
- Outputs: RO RC W2 triacs - 24VAC @ .3A maximum, W1 Relay - 24VAC @ 1.0A maximum
- Used with ModCom, Zonex Commander (Plus) DDC systems, and System 2000 GEN II zoning system
- Dimensions: 4-1/2"H x 2-7/8"W x 1"D
- Color: off-white



Part #	Model #	Description
50292	MODSTAT	24VAC Thermostat Modulating Zone Stat

Zoning

7-Day Programmable Time Clocks for System 2000 GEN II

- Provides a single channel, 24-hour or 7-day global scheduling for occupied (on) and unoccupied (off) system operation
- Maximum of 20 program events are provided for on-off schedules
- Time clock must be mounted next to the System 2000 GEN II controller
- No enclosure required
- Dimensions: 4-1/4"H x 2-7/8"W x 2-1/4"D



Part #	Model #	Description
51165	GCLK	24VAC 7-Day Programmable Time Clock

Zoning Control Accessories

Part #	Model #	Description
50298	TWPR	500' Twisted Pair Communication Wire

Bypass Dampers

System 2000 GEN II Round Medium Pressure Bypass Damper

- Fully modulating pressure dependent supply air damper
- May also function as a modulating bypass damper
- Shell: 20 - 22 gauge cold rolled galvanized steel
- Shaft: 1/2" hexagonal aluminum
- Actuator: power open/power close, 60° stroke
- Maximum pressure differential of 1.75"wc
- Operating temperature: 20° to 125°F
- Operating humidity: 10% to 95%, non-condensing



Part #	Model #	Description
50294	STMPD08	8" Pressure/Bypass Damper
50295	STMPD10	10" Pressure/Bypass Damper

Round Electronic Bypass Damper with Integrated Static Pressure Control

- Supply voltage: 24VAC
- Power consumption: 2.3VA
- Control range: .15" to .95"wc
- Shell: 20 - 22 gauge cold rolled galvanized steel
- Shaft: 1/2" hexagonal aluminum
- Bushings: Celcon
- Actuator: Belimo
- Stroke: 90°
- Pressure drop: < .04"wc @ rated CFM



Part #	Model #	Diameter	Length	CFM
88338	STBP14	14"	16"	1,700 CFM

Transformers

Part #	Model #	Description
72349	TR40	110VAC Input, 24VAC Output, 40VA

Models and Specifications are Subject to Change Without Notice

Rectangular Duct & Fittings

Rectangular Duct & Fittings

Rectangular Duct

- All duct e-lock



Part #	Model #	Size
173041	SSD-08X8X48	8" x 8" x 48"
7819	SSD-08X8X60	8" x 8" x 60"
8089	SSD-08X8X96	8" x 8" x 96"
173042	SSD-10X8X48	10" x 8" x 48"
18134	SSD-10X8X60	10" x 8" x 60"
18447	SSD-10X8X96	10" x 8" x 96"
173043	SSD-12X8X48	12" x 8" x 48"
9234	SSD-12X8X60	12" x 8" x 60"
9507	SSD-12X8X96	12" x 8" x 96"
173044	SSD-14X8X48	14" x 8" x 48"
640	SSD-14X8X60	14" x 8" x 60"
944	SSD-14X8X96	14" x 8" x 96"
173045	SSD-16X8X48	16" x 8" x 48"
10610	SSD-16X8X60	16" x 8" x 60"
10890	SSD-16X8X96	16" x 8" x 96"
173046	SSD-18X8X48	18" x 8" x 48"
1952	SSD-18X8X60	18" x 8" x 60"
2195	SSD-18X8X96	18" x 8" x 96"
173048	SSD-20X8X48	20" x 8" x 48"
12037	SSD-20X8X60	20" x 8" x 60"
12297	SSD-20X8X96	20" x 8" x 96"
27719	SSD-22X8X60	22" x 8" x 60"
27720	SSD-22X8X96	22" x 8" x 96"
173047	SSD-24X8X48	24" x 8" x 48"
13427	SSD-24X8X60	24" x 8" x 60"
13696	SSD-24X8X96	24" x 8" x 96"
190751	SSD-25X10X96	25" x 10" x 96"
19283	SSD-30X8X48	30" x 8" x 48"

Part #	Model #	Size
42932	SSD-10X10X60	10" x 10" x 60"
38715	SSD-10X10X96	10" x 10" x 96"
42931	SSD-12X10X60	12" x 10" x 60"
28699	SSD-12X10X96	12" x 10" x 96"
22806	SSD-14X10X60	14" x 10" x 60"
54560	SSD-14X10X96	14" x 10" x 96"
21476	SSD-16X10X60	16" x 10" x 60"
38716	SSD-16X10X96	16" x 10" x 96"
24131	SSD-18X10X60	18" x 10" x 60"
78624	SSD-18X10X96	18" x 10" x 96"
13010	SSD-20X10X60	20" x 10" x 60"
21471	SSD-20X10X96	20" x 10" x 96"
19260	SSD-24X10X60	24" x 10" x 60"
21467	SSD-24X10X96	24" x 10" x 96"
4179	SSD-25X10X60	25" x 10" x 60"

Part #	Model #	Size
29825	SSD-24X12X60	24" x 12" x 60"

Duct Reducer (534)



Part #	Model #	Size
4751	SSF-02-TAP	2" Taper for 8" Duct
3760	SSF-04-TAP	4" Taper for 8" Duct
2705	SSF-06-TAP	6" Taper for 8" Duct
1794	SSF-08-TAP	8" Taper for 8" Duct

Part #	Model #	Size
54095	SSF-02-TAP	2" Taper for 10" Duct
54096	SSF-04-TAP	4" Taper for 10" Duct
81311	SSF-06-TAP	6" Taper for 10" Duct
128186	SSF-08-TAP	8" Taper for 10" Duct

Rectangular Duct & Fittings

Duct End Cap (512)

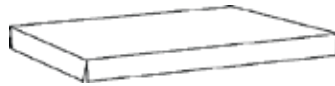

6 CONVENIENT LOCATIONS

Part #	Model #	Size
9365	SSF-08X8-EC	8" x 8"
18079	SSF-10X8-EC	10" x 8"
7581	SSF-12X8-EC	12" x 8"
16249	SSF-14X8-EC	14" x 8"
5757	SSF-16X8-EC	16" x 8"
14315	SSF-18X8-EC	18" x 8"
3965	SSF-20X8-EC	20" x 8"
27718	SSF-22X8-EC	22" x 8"
2234	SSF-24X8-EC	24" x 8"
19239	SSF-30X8-EC	30" x 8"

Part #	Model #	Size
63880	SSF-10X10-EC	10" x 10"
28700	SSF-12X10-EC	12" x 10"
51091	SSF-14X10-EC	14" x 10"
24140	SSF-16X10-EC	16" x 10"
43931	SSF-18X10-EC	18" x 10"
8631	SSF-20X10-EC	20" x 10"
9721	SSF-24X10-EC	24" x 10"
14774	SSF-25X10-EC	25" x 10"

Part #	Model #	Size
20930	SSF-24X12-EC	24" x 12"

ANN ARBOR

141 Jackson Industrial
Ann Arbor, MI 48103
P (800) 665-1452
F (734) 665-0679
M-F: 7:30 a.m. – 4:30 p.m.

COLDWATER

36 Mill Street
Coldwater, MI 49036
P (800) 922-5180
F (517) 279-7350
M-F: 7:30 a.m. – 4:30 p.m.

GRAND RAPIDS

130 Graham S.W.
Grand Rapids, MI 49503
P (800) 541-1144
F (616) 247-0283
M-F: 7:30 a.m. – 4:30 p.m.

JACKSON

1021 Belden Road
Jackson, MI 49203
P (800) 333-8005
F (517) 782-1155
M-F: 7:30 a.m. – 4:30 p.m.

LANSING

1115 S. Pennsylvania
Lansing, MI 48912
P (800) 487-4836
F (517) 487-1119
M-F: 7:30 a.m. – 4:30 p.m.

SAGINAW

219 Atwater
Saginaw, MI 48601
P (800) 292-0233
F (989) 754-4241
M-F: 7:30 a.m. – 4:30 p.m.

Rectangular Duct & Fittings

45° Horizontal Longway Elbow (532)

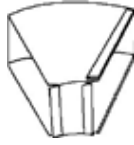

Part #	Model #	Size
1668	SSF-08X8-FW45	8" x 8"
7291	SSF-10X8-FW45	10" x 8"
12883	SSF-12X8-FW45	12" x 8"
18837	SSF-14X8-FW45	14" x 8"
5418	SSF-16X8-FW45	16" x 8"
11080	SSF-18X8-FW45	18" x 8"
16971	SSF-20X8-FW45	20" x 8"
86656	SSF-22X8-FW45	22" x 8"
9285	SSF-24X8-FW45	24" x 8"

Part #	Model #	Size
63879	SSF-10X10-FW45	10" x 10"
41808	SSF-12X10-FW45	12" x 10"
53945	SSF-14X10-FW45	14" x 10"
41804	SSF-16X10-FW45	16" x 10"
128183	SSF-18X10-FW45	18" x 10"
21473	SSF-20X10-FW45	20" x 10"
21470	SSF-24X10-FW45	24" x 10"
21351	SSF-25X10-FW45	25" x 10"

Part #	Model #	Size
48580	SSF-24X12-FW45	24" x 12"

90° Horizontal Longway Elbow (525)

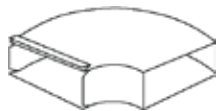

Part #	Model #	Size
2041	SSF-08X8-FW90	8" x 8"
7710	SSF-10X8-FW90	10" x 8"
13302	SSF-12X8-FW90	12" x 8"
340	SSF-14X8-FW90	14" x 8"
5818	SSF-16X8-FW90	16" x 8"
11527	SSF-18X8-FW90	18" x 8"
17382	SSF-20X8-FW90	20" x 8"
27722	SSF-22X8-FW90	22" x 8"
9685	SSF-24X8-FW90	24" x 8"

Part #	Model #	Size
48065	SSF-10X10-FW90	10" x 10"
41807	SSF-12X10-FW90	12" x 10"
51702	SSF-14X10-FW90	14" x 10"
41803	SSF-16X10-FW90	16" x 10"
48066	SSF-18X10-FW90	18" x 10"
21472	SSF-20X10-FW90	20" x 10"
21468	SSF-24X10-FW90	24" x 10"
20244	SSF-25X10-FW90	25" x 10"

Part #	Model #	Size
48581	SSF-24X12-FW90	24" x 12"

45° Vertical Shortway Elbow (314)



Part #	Model #	Size
10340	SSF-08X8-SW45	8" x 8"
16155	SSF-10X8-SW45	10" x 8"
2778	SSF-12X8-SW45	12" x 8"
8539	SSF-14X8-SW45	14" x 8"
14141	SSF-16X8-SW45	16" x 8"
1158	SSF-18X8-SW45	18" x 8"
6636	SSF-20X8-SW45	20" x 8"
86657	SSF-22X8-SW45	22" x 8"
18242	SSF-24X8-SW45	24" x 8"

Part #	Model #	Size
63878	SSF-10X10-SW45	10" x 10"
41806	SSF-12X10-SW45	12" x 10"
54094	SSF-14X10-SW45	14" x 10"
41802	SSF-16X10-SW45	16" x 10"
79115	SSF-18X10-SW45	18" x 10"
21474	SSF-20X10-SW45	20" x 10"
21594	SSF-24X10-SW45	24" x 10"
21352	SSF-25X10-SW45	25" x 10"

Part #	Model #	Size
48582	SSF-24X12-SW45	24" x 12"

Rectangular Duct & Fittings

90° Vertical Shortway Elbow (307)

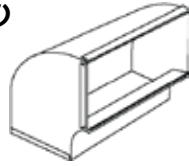

Part #	Model #	Size
10756	SSF-08X8-SW90	8" x 8"
16592	SSF-10X8-SW90	10" x 8"
3208	SSF-12X8-SW90	12" x 8"
8989	SSF-14X8-SW90	14" x 8"
14636	SSF-16X8-SW90	16" x 8"
1518	SSF-18X8-SW90	18" x 8"
7098	SSF-20X8-SW90	20" x 8"
27721	SSF-22X8-SW90	22" x 8"
18657	SSF-24X8-SW90	24" x 8"

Part #	Model #	Size
56264	SSF-10X10-SW90	10" x 10"
41805	SSF-12X10-SW90	12" x 10"
51505	SSF-14X10-SW90	14" x 10"
41801	SSF-16X10-SW90	16" x 10"
51842	SSF-18X10-SW90	18" x 10"
21475	SSF-20X10-SW90	20" x 10"
21469	SSF-24X10-SW90	24" x 10"
20926	SSF-25X10-SW90	25" x 10"

Part #	Model #	Size
48583	SSF-24X12-SW90	24" x 12"

Galvanized Volume Damper

Part #	Model #	Size
13551	SSF-08X8-DAM	8" x 8"
4671	SSF-10X8-DAM	8" x 10"
14773	SSF-12X8-DAM	8" x 12"
5834	SSF-14X8-DAM	8" x 14"
15980	SSF-16X8-DAM	8" x 16"
6992	SSF-18X8-DAM	8" x 18"
17183	SSF-20X8-DAM	8" x 20"
18364	SSF-24X8-DAM	8" x 24"

Offset Starting Collar (519)

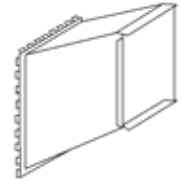

Part #	Model #	Size
6785	SSF-08X8-OST	8" x 8"
16996	SSF-10X8-OST	10" x 8"
7950	SSF-12X8-OST	12" x 8"
18137	SSF-14X8-OST	14" x 8"
9110	SSF-16X8-OST	16" x 8"
378	SSF-18X8-OST	18" x 8"
10204	SSF-20X8-OST	20" x 8"

Part #	Model #	Size
47352	SSF-16X10-OST	16" x 10"

Straight Starting Collar (520)

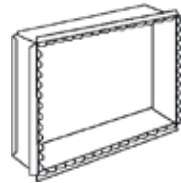

Part #	Model #	Size
10795	SSF-08X8-ST	8" x 8"
641	SSF-10X8-ST	10" x 8"
9081	SSF-12X8-ST	12" x 8"
17763	SSF-14X8-ST	14" x 8"
7292	SSF-16X8-ST	16" x 8"
15923	SSF-18X8-ST	18" x 8"
5479	SSF-20X8-ST	20" x 8"
86658	SSF-22X8-ST	22" x 8"
3681	SSF-24X8-ST	24" x 8"

Part #	Model #	Size
51701	SSF-16X10-ST	16" x 10"
55258	SSF-18X10-ST	18" x 10"
10068	SSF-20X10-ST	20" x 10"
28499	SSF-24X10-ST	24" x 10"
20245	SSF-25X10-ST	25" x 10"

Rectangular Duct & Fittings

Square Duct Transition (533)

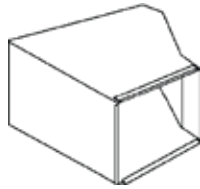

Part #	Model #	Plenum Size - Duct Size
10891	SSF-10X8-8X8-TR	10" x 8" - 8" x 8"
2196	SSF-12X8-8X8-TR	12" x 8" - 8" x 8"
9164	SSF-12X8-10X8-TR	12" x 8" - 10" x 8"
12298	SSF-14X8-8X8-TR	14" x 8" - 8" x 8"
7682	SSF-14X8-10X8-TR	14" x 8" - 10" x 8"
16353	SSF-14X8-12X8-TR	14" x 8" - 12" x 8"
3577	SSF-16X8-8X8-TR	16" x 8" - 8" x 8"
14787	SSF-16X8-10X8-TR	16" x 8" - 10" x 8"
4350	SSF-16X8-12X8-TR	16" x 8" - 12" x 8"
12914	SSF-16X8-14X8-TR	16" x 8" - 14" x 8"
31061	SSF-18X8-10X8-TR	18" x 8" - 10" x 8"
2893	SSF-18X8-12X8-TR	18" x 8" - 12" x 8"
11506	SSF-18X8-14X8-TR	18" x 8" - 14" x 8"
1314	SSF-18X8-16X8-TR	18" x 8" - 16" x 8"
11834	SSF-20X8-10X8-TR	20" x 8" - 10" x 8"
1582	SSF-20X8-12X8-TR	20" x 8" - 12" x 8"
10042	SSF-20X8-14X8-TR	20" x 8" - 14" x 8"
18798	SSF-20X8-16X8-TR	20" x 8" - 16" x 8"
8282	SSF-20X8-18X8-TR	20" x 8" - 18" x 8"
29035	SSF-24X8-10X8-TR	24" x 8" - 10" x 8"
29036	SSF-24X8-12X8-TR	24" x 8" - 12" x 8"
20286	SSF-24X8-14X8-TR	24" x 8" - 14" x 8"
5318	SSF-24X8-16X8-TR	24" x 8" - 16" x 8"
13822	SSF-24X8-18X8-TR	24" x 8" - 18" x 8"
3533	SSF-24X8-20X8-TR	24" x 8" - 20" x 8"

Part #	Model #	Plenum Size - Duct Size
47372	SSF-12X10-12X8-TR	12" x 10" - 12" x 8"
21477	SSF-16X10-16X8-TR	16" x 10" - 16" x 8"
44662	SSF-20X10-16X8-TR	20" x 10" - 16" x 8"
56	SSF-20X10-20X8-TR	20" x 10" - 20" x 8"
22811	SSF-20X10-16X10-TR	20" x 10" - 16" x 10"
35463	SSF-24X10-20X10-TR	24" x 10" - 20" x 10"
33951	SSF-24X10-24X8-TR	24" x 10" - 24" x 8"
22810	SSF-25X10-20X10-TR	25" x 10" - 20" x 10"

Offset Transition Starter (518)

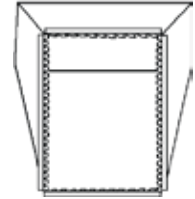

Part #	Model #	Plenum Opening	Duct
9144	SSF-14X8-OTST	12" x 10"	14" x 8"
14833	SSF-16X8-OTST	12" x 11"	16" x 8"
1665	SSF-18X8-OTST	12" x 12"	18" x 8"
7289	SSF-20X8-OTST	12" x 14"	20" x 8"
187972	SSF-22X8-OTST	12" x 15"	22" x 8"
18836	SSF-24X8-OTST	12" x 16"	24" x 8"
187973	SSF-28X8-OTST	16" x 14-1/2"	28" x 8"
187974	SSF-30X8-OTST	16" x 15-1/2"	30" x 8"
187975	SSF-32X8-OTST	16" x 17"	32" x 8"

Part #	Model #	Plenum Opening	Duct
47527	SSF-20X10-OTST	12" x 14"	20" x 10"
44292	SSF-24X10-OTST	12" x 18"	24" x 10"

Jumper Boot Companion Elbow

Part #	Model #	Size
45080	SSF-10X8-10X10-JUMPER	10" x 8" - 10" x 10"
45081	SSF-12X8-12X12-JUMPER	12" x 8" - 12" x 12"

Joist Panning

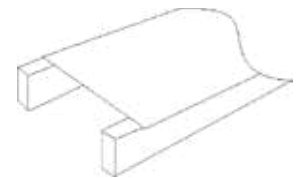

Part #	Model #	Size
3205	SMM-PNG-SNGL	16-1/2" x 30" Single
8668	SMM-PNG-DBL	33" x 29" Double

Round Duct & Fittings

Sheet Metal Pipe & Fittings Galvanized Round Sheet Metal Pipe



26ga

Part #	Model #	Size	Gauge
15348	SRP-03X24-26	3" x 24"	26ga
32360	SRP-03X60-26	3" x 60"	26ga
1523	SRP-04X24-26	4" x 24"	26ga
19369	SRP-04X60-26	4" x 60"	26ga
6359	SRP-05X24-26	5" x 24"	26ga
25554	SRP-05X60-26	5" x 60"	26ga
11426	SRP-06X24-26	6" x 24"	26ga
9574	SRP-06X60-26	6" x 60"	26ga
16571	SRP-07X24-26	7" x 24"	26ga
14592	SRP-07X60-26	7" x 60"	26ga
2504	SRP-08X24-26	8" x 24"	26ga
871	SRP-08X60-26	8" x 60"	26ga
7580	SRP-09X24-26	9" x 24"	26ga
20944	SRP-09X60-26	9" x 60"	26ga
12525	SRP-10X24-26	10" x 24"	26ga
10675	SRP-10X60-26	10" x 60"	26ga
3657	SRP-12X24-26	12" x 24"	26ga
1914	SRP-12X60-26	12" x 60"	26ga
13641	SRP-14X24-26	14" x 24"	26ga
11852	SRP-14X60-26	14" x 60"	26ga
4775	SRP-16X24-26	16" x 24"	26ga
3557	SRP-16X48-26	16" x 48"	26ga
2913	SRP-16X60-26	16" x 60"	26ga
14887	SRP-18X24-26	18" x 24"	26ga
13550	SRP-18X48-26	18" x 48"	26ga

28ga

Part #	Model #	Size	Gauge
73130	SRP-10X60-28	10" x 60"	28ga
72783	SRP-12X60-28	12" x 60"	28ga

30ga / Warm Air Gauge

Part #	Model #	Size	Gauge
15405	SRP-03X24-30	3" x 24"	30ga
17196	SRP-03X60-30	3" x 60"	30ga
1565	SRP-04X24-30	4" x 24"	30ga
12349	SRP-04X120-WA	4" x 120"	Warm Air
15048	SRP-06X24-30	6" x 24"	30ga
13085	SRP-06X60-WA	6" x 60"	Warm Air
16614	SRP-07X24-30	7" x 24"	30ga
2536	SRP-08X24-30	8" x 24"	30ga
30828	SRP-09X24-WA	9" x 24"	Warm Air
9304	SRP-09X60-30	9" x 60"	30ga
16277	SRP-10X24-WA	10" x 24"	30ga
14248	SRP-10X60-30	10" x 60"	30ga
3701	SRP-12X24-30	12" x 24"	30ga

30ga - Unboxed

Part #	Model #	Size	Gauge
30896	SRP-04X60-UNBOXED-WA	4" x 60"	Warm Air
73025	SRP-05X60-UNBOX	5" x 60"	Warm Air
19097	SRP-06X60-UNBOX	6" x 60"	Warm Air
19272	SRP-06X120-UNBOX	6" x 120"	Warm Air
30054	SRP-07X60-UNBOXED	7" x 60"	Warm Air
34028	SRP-07X120-UNBOX	7" x 120"	30ga
30897	SRP-08X60-UNBOXED	8" x 60"	Warm Air
48882	SRP-08X120-UNBOXED	8" x 120"	30ga

Galvanized Sheet Metal Flat Sheet



Part #	Model #	Size	Gauge
10541	SMM-3X8-28-FS	36" x 96"	28ga
21416	SMM-4X8-28-FS	48" x 96"	28ga
9091	SMM-3X8-26-FS	36" x 96"	26ga
3852	SMM-4X8-26-FS	48" x 96"	26ga
10754	SMM-3X8-24-FS	36" x 96"	24ga
19839	SMM-4X8-24-FS	48" x 96"	24ga

Round Duct & Fittings

Galvanized 90° Elbow



Part #	Model #	Size	Gauge
73128	SRF-10-28-90	10"	28ga
73129	SRF-12-28-90	12"	28ga
17340	SRF-03-26-90	3"	26ga
17133	SRF-03-30-90	3"	30ga
3243	SRF-04-26-90	4"	26ga
3018	SRF-04-30-90	4"	30ga
8312	SRF-05-26-90	5"	26ga
8091	SRF-05-30-90	5"	30ga
13226	SRF-06-26-90	6"	26ga
13029	SRF-06-30-90	6"	30ga
18508	SRF-07-26-90	7"	26ga
18308	SRF-07-30-90	7"	30ga
4356	SRF-08-26-90	8"	26ga
4157	SRF-08-30-90	8"	30ga
9448	SRF-09-26-90	9"	26ga
9247	SRF-09-30-90	9"	30ga
14407	SRF-10-26-90	10"	26ga
14177	SRF-10-30-90	10"	30ga
5537	SRF-12-26-90	12"	26ga
15672	SRF-14-26-90	14"	26ga
6664	SRF-16-26-90	16"	26ga
16882	SRF-18-26-90	18"	26ga

End Cap - No Crimp (421)



Part #	Model #	Size
17107	SRF-03-EC	3"
7441	SRF-04-EC	4"
17008	SRF-05-EC	5"
7341	SRF-06-EC	6"
16892	SRF-07-EC	7"
7262	SRF-08-EC	8"
16766	SRF-09-EC	9"
7128	SRF-10-EC	10"
7013	SRF-12-EC	12"
6895	SRF-14-EC	14"
6795	SRF-16-EC	16"
33876	SRF-18-EC	18"
33896	SRF-24-EC	24"

Starting Collar (416)

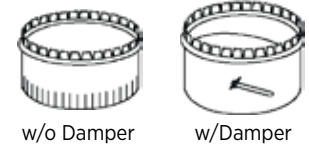

Part #	Model #	Dia x Length	Damper
4656	SRF-03-ST-S	3" x 2"	w/o Damper
18604	SRF-03-ST	3" x 4"	w/o Damper
18639	SRF-04-ST-S	4" x 2"	w/o Damper
8959	SRF-04-ST	4" x 4"	w/o Damper
13208	SRF-05-ST-S	5" x 2"	w/o Damper
18499	SRF-05-ST	5" x 4"	w/o Damper
8119	SRF-06-ST-S	6" x 2"	w/o Damper
8845	SRF-06-ST	6" x 4"	w/o Damper
2883	SRF-07-ST-S	7" x 2"	w/o Damper
18402	SRF-07-ST	7" x 4"	w/o Damper
16820	SRF-08-ST-S	8" x 2"	w/o Damper
8746	SRF-08-ST	8" x 4"	w/o Damper
18292	SRF-09-ST	9" x 4"	w/o Damper
6265	SRF-10-ST-S	10" x 2"	w/o Damper
8625	SRF-10-ST	10" x 4"	w/o Damper
14928	SRF-12-ST-S	12" x 2"	w/o Damper
8523	SRF-12-ST	12" x 4"	w/o Damper
4505	SRF-14-ST-S	14" x 2"	w/o Damper
8412	SRF-14-ST	14" x 4"	w/o Damper
8299	SRF-16-ST-S	16" x 2"	w/o Damper
29117	SRF-16-ST	16" x 4"	w/o Damper
8201	SRF-18-ST-S	18" x 2"	w/o Damper
26328	SRF-18-ST	18" x 4"	w/o Damper
68804	SRF-20-ST	20" x 4"	w/o Damper
19220	SRF-24-ST	24" Crimped	w/o Damper
7984	SRF-06-ST-D	6" x 2"	w/Damper
2751	SRF-07-ST-D	7" x 2"	w/Damper
16660	SRF-08-ST-D	8" x 2"	w/Damper
6141	SRF-10-ST-D	10" x 2"	w/Damper
14786	SRF-12-ST-D	12" x 2"	w/Damper
4349	SRF-14-ST-D	14" x 2"	w/Damper
24210	SRF-16-ST-D	16" x 2"	w/Damper

330 Wye Branch



Part #	Model #	Size
174677	SRF-10-ST-S-UC	10" x 2"

Round Duct & Fittings

90° Saddle

- 26 Gauge



Part #	Model #	Branch	Pipe
12091	SRF-04-SAD	4"	6" - 8"
30434	SRF-04-SAD/12	4"	12"
11571	SRF-05-SAD	5"	6" - 8"
11044	SRF-06-SAD	6"	6" - 8"
30435	SRF-06-SAD/12	6"	10" - 12"
56300	SRF-06-SAD/14	6"	14" - 18"
178831	SRF-06-SAD/16	6"	16" - 18"
10526	SRF-07-SAD	7"	8" - 10"
30436	SRF-07-SAD/12	7"	12"
191209	SRF-07-SAD/14	7"	14"
10030	SRF-08-SAD	8"	10" - 12"
30437	SRF-08-SAD/12	8"	10" - 12"
178832	SRF-08-SAD/16	8"	16" - 18"
9027	SRF-10-SAD	10"	10" - 12"
7973	SRF-12-SAD	12"	14" - 16"
178833	SRF-12-SAD/14		14" - 16"
178834	SRF-12-SAD/16		16" - 18"
6905	SRF-14-SAD	14"	16" - 18"

Tee Wye Joint to Crimp Inlet (229)

- 45° Branch

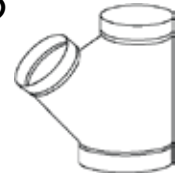

Part #	Model #	Size
45038	SRF-04-WYE	4" x 4" x 4"
34708	SRF-06-WYE	6" x 6" x 6"
12040	SRF-4X3X3-TEE	4" x 3" x 3"
17232	SRF-4X4X3-TEE	4" x 4" x 3"
2641	SRF-5X3X3-TEE	5" x 3" x 3"
7716	SRF-5X4X3-TEE	5" x 4" x 3"
7198	SRF-5X4X4-TEE	5" x 4" x 4"
12644	SRF-5X5X3-TEE	5" x 5" x 3"
12167	SRF-5X5X4-TEE	5" x 5" x 4"
17386	SRF-6X4X3-TEE	6" x 4" x 3"
16871	SRF-6X4X4-TEE	6" x 4" x 4"
3302	SRF-6X5X3-TEE	6" x 5" x 3"
2773	SRF-6X5X4-TEE	6" x 5" x 4"
8357	SRF-6X6X3-TEE	6" x 6" x 3"
7846	SRF-6X6X4-TEE	6" x 6" x 4"
7328	SRF-6X6X5-TEE	6" x 6" x 5"
7874	SRF-7X4X3-TEE	7" x 4" x 3"
12296	SRF-7X5X4-TEE	7" x 5" x 4"
18043	SRF-7X6X3-TEE	7" x 6" x 3"
17518	SRF-7X6X4-TEE	7" x 6" x 4"
3942	SRF-7X7X3-TEE	7" x 7" x 3"
3438	SRF-7X7X4-TEE	7" x 7" x 4"
7993	SRF-8X6X4-TEE	8" x 6" x 4"
6933	SRF-8X6X6-TEE	8" x 6" x 6"

Tee (352)

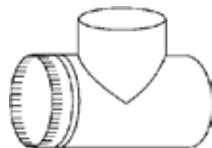

Part #	Model #	Size
13859	SRF-03-TEE	3" x 3" x 3"
13351	SRF-04-TEE	4" x 4" x 4"
12843	SRF-05-TEE	5" x 5" x 5"
12328	SRF-06-TEE	6" x 6" x 6"
11865	SRF-07-TEE	7" x 7" x 7"
11321	SRF-08-TEE	8" x 8" x 8"
10809	SRF-09-TEE	9" x 9" x 9"
10305	SRF-10-TEE	10" x 10" x 10"
9303	SRF-12-TEE	12" x 12" x 12"
8269	SRF-14-TEE	14" x 14" x 14"
7251	SRF-16-TEE	16" x 16" x 16"
48772	SRF-18-TEE	18" x 18" x 18"

330 Wye Branch



Part #	Model #	Size
19569	SRF-8X6X6-WYE	8" x 6" x 6"

Round Duct & Fittings

431 No Crimp Taper Reducer



Part #	Model #	Size
7565	SRF-04X03-RED	4" x 3"
1106	SRF-05X03-RED	5" x 3"
583	SRF-05X04-RED	5" x 4"
13158	SRF-06X03-RED	6" x 3"
12648	SRF-06X04-RED	6" x 4"
12176	SRF-06X05-RED	6" x 5"
6585	SRF-07X03-RED	7" x 3"
6062	SRF-07X04-RED	7" x 4"
5579	SRF-07X05-RED	7" x 5"
5039	SRF-07X06-RED	7" x 6"
18595	SRF-08X04-RED	8" x 4"
18053	SRF-08X05-RED	8" x 5"
17530	SRF-08X06-RED	8" x 6"
17026	SRF-08X07-RED	8" x 7"
10735	SRF-09X06-RED	9" x 6"
10230	SRF-09X07-RED	9" x 7"
9714	SRF-09X08-RED	9" x 8"
4095	SRF-10X06-RED	10" x 6"
3597	SRF-10X07-RED	10" x 7"
3056	SRF-10X08-RED	10" x 8"
2551	SRF-10X09-RED	10" x 9"
9830	SRF-12X06-RED	12" x 6"
8855	SRF-12X08-RED	12" x 8"
8309	SRF-12X09-RED	12" x 9"
7802	SRF-12X10-RED	12" x 10"
14472	SRF-14X08-RED	14" x 8"
13400	SRF-14X10-RED	14" x 10"
12355	SRF-14X12-RED	14" x 12"
46536	SRF-16X10-RED	16" x 10"
31434	SRF-16X12-RED	16" x 12"
24213	SRF-16X14-RED	16" x 14"
35997	SRF-18X16-RED	18" x 16"

451 No Crimp Taper Reducer Short Cap



Part #	Model #	Size
160602	SRF-04X03-RED-SC	4" x 3"
160603	SRF-05X04-RED-SC	5" x 4"
160604	SRF-06X04-RED-SC	6" x 4"
42966	SRF-06X05-RED-SC	6" x 5"
160605	SRF-07X05-RED-SC	7" x 5"
160607	SRF-08X06-RED-SC	8" x 6"
160608	SRF-08X07-RED-SC	8" x 7"



A MUNCH'S SUPPLY COMPANY

We are a full line wholesaler. Contact us for information about items not listed in this catalog.

Sheet Metal, Registers, Venting

Round Duct & Fittings

Galvanized Drawbands
410 Drawband

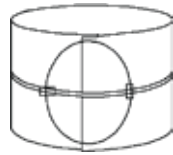

Part #	Model #	Size
7255	SRF-06-DB	6"
16765	SRF-07-DB	7"
7127	SRF-08-DB	8"

Round Damper - Single Handle



Part #	Model #	Size
30748	SRF-04-DAM	4"
16591	SRF-05-DAM	5"
16047	SRF-06-DAM	6"
15524	SRF-07-DAM	7"
14953	SRF-08-DAM	8"
14367	SRF-09-DAM	9"
13809	SRF-10-DAM	10"
12796	SRF-12-DAM	12"

52 Tabbed Duct Board Collarless Damper

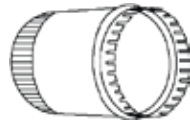

Part #	Model #	Size
44849	SRF-04-DBCT	4"
22017	SRF-06-DBCT	6"
22018	SRF-07-DBCT	7"
22019	SRF-08-DBCT	8"
22020	SRF-10-DBCT	10"
29743	SRF-12-DBCT	12"

Round Damper - Double Handle



Part #	Model #	Size
21484	SRF-14-DAM-2	14" w/2 Hardware
29971	SRF-16-DAM	16" w/2 Hardware

Round Duct & Fittings

"Scotty" Take-Off (325)

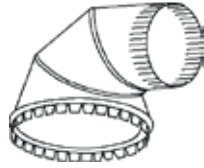

Part #	Model #	Size
18353	SRF-05-SC	5"
8682	SRF-06-SC	6"
18241	SRF-07-SC	7"
8567	SRF-08-SC	8"
26794	SRF-10-SC	10"

Round Self-Adhesive Take-Off with Damper (1329)

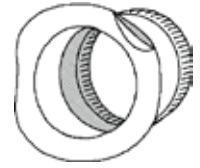

Part #	Model #	Size
138222	SRF-06	6"
138225	SRF-08	8"
138226	SRF-10	10"
138227	SRF-12	12"

Half-Tab "Scotty" Take-Off (325H)

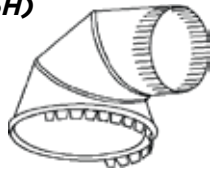

Part #	Model #	Size
24445	SRF-06-HTTO	6"
45754	SRF-07-HTTO	7"

Metal Spin-In Collar with Damper (47)

• 30 Gauge

Part #	Model #	Size
12408	SRF-06-SPD	6"
11420	SRF-08-SPD	8"
10396	SRF-10-SPD	10"
9386	SRF-12-SPD	12"

Round Self-Adhesive Saddle Take-Off (1231)

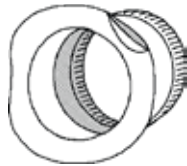

Part #	Model #	Size
53117	SRF-04-RR-SAD	4"
42967	SRF-06-RR-SAD	6"
48578	SRF-07-RR-SAD	7"
42984	SRF-08-RR-SAD	8"
53119	SRF-10-RR-SAD	10"

QUALITY. SERVICE. TOMMARK.

Round Duct & Fittings

Galvanized Register Boots
Straight Back Register Boot



Part #	Model #	Size
21863	SBR-2X10X4-ST	2-1/4" x 10" - 4"
9608	SBR-2X10X6-ST	2-1/4" x 10" - 6"
18372	SBR-2X12X6-ST	2-1/4" x 12" - 6"
9855	SBR-4X10X4-ST	4" x 10" - 4"
547	SBR-4X10X5-ST	4" x 10" - 5"
9759	SBR-4X10X6-ST	4" x 10" x 6"
449	SBR-4X10X7-ST	4" x 10" - 7"
18528	SBR-4X12X6-ST	4" x 12" - 6"
8871	SBR-4X12X7-ST	4" x 12" - 7"
18432	SBR-4X12X8-ST	4" x 12" - 8"
9914	SBR-6X10X6-ST	6" x 10" - 6"
595	SBR-6X10X7-ST	6" x 10" - 7"
18674	SBR-6X12X6-ST	6" x 12" - 6"
9025	SBR-6X12X7-ST	6" x 12" - 7"
18576	SBR-6X12X8-ST	6" x 12" - 8"
8177	SBR-6X14X6-ST	6" x 14" - 6"
17719	SBR-6X14X7-ST	6" x 14" - 7"
8054	SBR-6X14X8-ST	6" x 14" - 8"
43087	SBR-12X12X8-ST	12" x 12" - 8" w/3" Flange
179401	SBR-8X12X8-ST	8" x 12" - 8"
179403	SBR-8X12X10-ST	8" x 12" - 10"

Center End Boot



Part #	Model #	Size
8070	SBR-2X10X4-CE	2-1/4" x 10" - 4"
7982	SBR-2X10X6-CE	2-1/4" x 10" - 6"
16658	SBR-2X12X6-CE	2-1/4" x 12" - 6"
6138	SBR-2X14X6-CE	2-1/4" x 14" - 6"
187372	SBR-4X8X6-CE	4" x 8" x 6"
8243	SBR-4X10X4-CE	4" x 10" - 4"
17788	SBR-4X10X5-CE	4" x 10" - 5"
8137	SBR-4X10X6-CE	4" x 10" - 6"
17693	SBR-4X10X7-CE	4" x 10" - 7"
16844	SBR-4X12X6-CE	4" x 12" - 6"
7213	SBR-4X12X7-CE	4" x 12" - 7"
16722	SBR-4X12X8-CE	4" x 12" - 8"
8306	SBR-6X10X6-CE	6" x 10" - 6"
17858	SBR-6X10X7-CE	6" x 10" - 7"
17021	SBR-6X12X6-CE	6" x 12" - 6"
7352	SBR-6X12X7-CE	6" x 12" - 7"
16915	SBR-6X12X8-CE	6" x 12" - 8"
6467	SBR-6X14X6-CE	6" x 14" - 6"
15993	SBR-6X14X7-CE	6" x 14" - 7"
6341	SBR-6X14X8-CE	6" x 14" - 8"

90° Elbow Boot

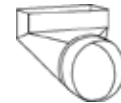

Part #	Model #	Size
6915	SBR-2X10X4-90	2-1/4" x 10" - 4"
6808	SBR-2X10X6-90	2-1/4" x 10" - 6"
15474	SBR-2X12X6-90	2-1/4" x 12" - 6"
29244	SBR-4X8X6-90	4" x 8" - 6"
7097	SBR-4X10X4-90	4" x 10" - 4"
16624	SBR-4X10X5-90	4" x 10" - 5"
6973	SBR-4X10X6-90	4" x 10" - 6"
16509	SBR-4X10X7-90	4" x 10" - 7"
15645	SBR-4X12X6-90	4" x 12" - 6"
6011	SBR-4X12X7-90	4" x 12" - 7"
15544	SBR-4X12X8-90	4" x 12" - 8"
7164	SBR-6X10X6-90	6" x 10" - 6"
16686	SBR-6X10X7-90	6" x 10" - 7"
15790	SBR-6X12X6-90	6" x 12" - 6"
6154	SBR-6X12X7-90	6" x 12" - 7"
15697	SBR-6X12X8-90	6" x 12" - 8"
14807	SBR-6X14X7-90	6" x 14" - 7"
5234	SBR-6X14X8-90	6" x 14" - 8"

Left End Boot



Part #	Model #	Size
18326	SBR-2X10X6-CEL	2-1/4" x 10" - 6"
9262	SBR-2X12X6-CEL	2-1/4" x 12" - 6"
9400	SBR-4X10X6-CEL	4" x 10" - 6"
657	SBR-4X12X6-CEL	4" x 12" - 6"

Sheet Metal, Registers, Venting

Sheet Metal Register Boots

Right End Boot



Part #	Model #	Size
18381	SBR-2X10X6-CER	2-1/4" x 10" - 6"
9326	SBR-2X12X6-CER	2-1/4" x 12" - 6"
9455	SBR-4X10X6-CER	4" x 10" - 6"
716	SBR-4X12X6-CER	4" x 12" - 6"

Straight Back Basement Register Boot with Ears & 1/2" Lip

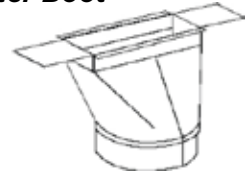

Part #	Model #	Size
30832	SBR-4X10X4-STBS	4" x 10" - 4"
30439	SBR-4X10X6-STBS	4" x 10" - 6"
12499	SBR-6X10X6-STBS	6" x 10" - 6"
32315	SBR-6X10X7-STBS	6" x 10" - 7"
18439	SBR-6X12X6-STBS	6" x 12" - 6"
33242	SBR-6X12X7-STBS	6" x 12" - 7"
34160	SBR-6X12X8-STBS	6" x 12" - 8"
30731	SBR-6X14X8-STBS	6" x 14" - 8"

Basement Boot With Ears (L575)

- With ears and 1/2" lip

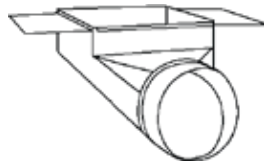

Part #	Model #	Size
30827	SBR-4X10X4-90BS	4" x 10" - 4"
588	SBR-4X10X6-90BS	4" x 10" - 6"
18027	SBR-6X10X6-90BS	6" x 10" - 6"
30833	SBR-6X10X7-90BS	6" x 10" - 7"
4583	SBR-6X12X6-90BS	6" x 12" - 6"
32316	SBR-6X12X7-90BS	6" x 12" - 7"
32458	SBR-6X12X8-90BS	6" x 12" - 8"

Center End Boot With Ears

- With ears on 6" side and 1/2" lip

Part #	Model #	Size
32177	SBR-6X10X6-CEBS	6" x 10" - 6"

Oval Duct & Fittings

Oval Pipe & Fittings

Oval Button Lock Pipe



Part #	Model #	Size
15152	SOP-6X100-OV	6" x 100"
4968	SOP-6X113-OV	6" x 113"
8557	SOP-7X100-OV	7" x 100"
17475	SOP-7X113-OV	7" x 113"
187688	SOP-8X60-OV	8" x 60"
39321	SOP-8X100-OV	8" x 100"
43273	SOP-8X113-OV	8" x 113"

Oval Horizontal Flatway 45° Elbow

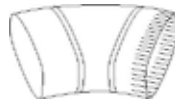

Part #	Model #	Size
4394	SOF-6-FW45	6"
18392	SOF-7-FW45	7"
48870	SOF-8-FW45	8"

Oval Horizontal Flatway 90° Elbow

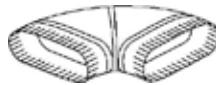

Part #	Model #	Size
4828	SOF-6-FW90	6"
18818	SOF-7-FW90	7"
48869	SOF-8-FW90	8"

Oval Vertical Shortway 45° Elbow



Part #	Model #	Size
13173	SOF-6-SW45	6"
8071	SOF-7-SW45	7"
44931	SOF-8-SW45	8"

Oval Vertical Shortway 90° Elbow

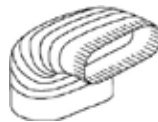

Part #	Model #	Size
13609	SOF-6-SW90	6"
8526	SOF-7-SW90	7"
48070	SOF-8-SW90	8"

Oval to Round Center End Boot

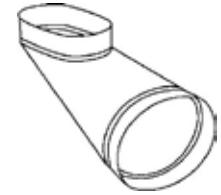

Part #	Model #	Size
3445	SOF-6-OR-CE	6"
8511	SOF-7-OR-CE	7"
44930	SOF-8-OR-CE	8"

Oval to Round Straight Boot



Part #	Model #	Size
5088	SOF-6-OR-ST	6"
10117	SOF-7-OR-ST	7"
39322	SOF-8-OR-ST	8"

Oval to Round 90° Boot

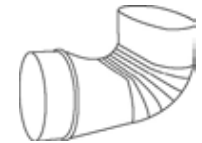

Part #	Model #	Size
2316	SOF-6-OR-90	6"
7353	SOF-7-OR-90	7"
12242	SOF-7OV-6RD-90	7" Oval - 6" Round
43269	SOF-8-OR-90	8"

Oval Starting Collar

Part #	Model #	Size
1664	SOF-6-ST	6"
10943	SOF-7-ST	7"
39323	SOF-8-ST	8"

Oval 45° Elbow Boot



Part #	Model #	Size
7145	SOF-4X10X6-45	4" x 10" - 6"
46476	SOF-4X10X6-45-C	4" x 10" x 6"

Oval Duct & Fittings

Oval 90° Elbow Boot

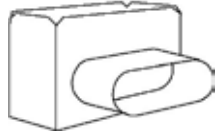

Part #	Model #	Size
7576	SOF-4X10X6-90	4" x 10" - 6"
31433	SOF-4X10X7-90	4" x 10" - 7"

Oval Stack Head

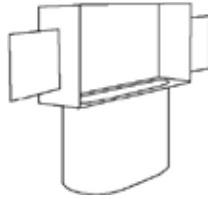

Part #	Model #	Size
33323	SOF-4X10X6-SH	4" x 10" - 6"
10380	SOF-6X10X6-SH	6" x 10" - 6"
1061	SOF-6X10X7-SH	6" x 10" - 7"
231	SOF-6X12X6-SH	6" x 12" - 6"
9467	SOF-6X12X7-SH	6" x 12" - 7"
44940	SOF-6X12X8-SH	6" x 12" - 8"
39821	SOF-6X14X8-SH	6" x 14" - 8"

Oval Double Take-Off Stackhead

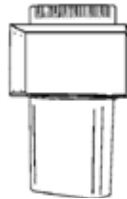

Part #	Model #	Size
16499	SOF-6X10X6-DBSH	6" x 10" - 6"
19273	SOF-6X10X7-DBSH	6" x 10" - 7"
19128	SOF-6X12X6-DBSH	6" x 12" - 6"
19351	SOF-6X12X7-DBSH	6" x 12" - 7"
88259	SOF-6X12X8-DBSH	6" x 12" - 8"



6 CONVENIENT LOCATIONS

ANN ARBOR

141 Jackson Industrial
Ann Arbor, MI 48103
P (800) 665-1452
F (734) 665-0679
M-F: 7:30 a.m. - 4:30 p.m.

COLDWATER

36 Mill Street
Coldwater, MI 49036
P (800) 922-5180
F (517) 279-7350
M-F: 7:30 a.m. - 4:30 p.m.

GRAND RAPIDS

130 Graham S.W.
Grand Rapids, MI 49503
P (800) 541-1144
F (616) 247-0283
M-F: 7:30 a.m. - 4:30 p.m.

JACKSON

1021 Belden Road
Jackson, MI 49203
P (800) 333-8005
F (517) 782-1155
M-F: 7:30 a.m. - 4:30 p.m.

LANSING

1115 S. Pennsylvania
Lansing, MI 48912
P (800) 487-4836
F (517) 487-1119
M-F: 7:30 a.m. - 4:30 p.m.

SAGINAW

219 Atwater
Saginaw, MI 48601
P (800) 292-0233
F (989) 754-4241
M-F: 7:30 a.m. - 4:30 p.m.

Wall Stack & Fittings

Wallstacks & Fittings
Wallstack

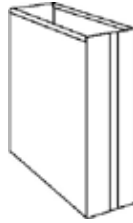

Part #	Model #	Size
11307	SWD-2X10X24-WS	2-1/4" x 10" x 24"
17743	SWD-2X10X100-WS	2-1/4" x 10" x 100"
8701	SWD-2X12X24	2-1/4" x 12" x 24"
8178	SWD-2X12X100	2-1/4" x 12" x 100"
13701	SWD-3X10X24	3-1/4" x 10" x 24"
14042	SWD-3X10X60	3-1/4" x 10" x 60"
2529	SWD-3X10X100	3-1/4" x 10" x 100"
13614	SWD-3X12X24	3-1/4" x 12" x 24"
19951	SWD-3X12X60	3-1/4" x 12" x 60"
1647	SWD-3X12X100	3-1/4" x 12" x 100"
13834	SWD-3X14X60	3-1/4" x 14" x 60"
39923	SWD-3X14X100	3-1/4" x 14" x 100"

512 Wallstack End Cap

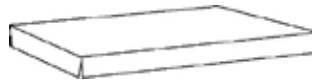

Part #	Model #	Size
8161	SWF-2X12-EC	2-1/4" x 12"
13185	SWF-3X10-EC	3-1/4" x 10"
13075	SWF-3X12-EC	3-1/4" x 12"
38267	SWF-3X14-EC	3-1/4" x 14"

532 Horizontal 45° Longway Angle

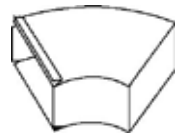

Part #	Model #	Size
8078	SWF-3X10-FW45	3-1/4" x 10"

525 Horizontal 90° Longway Elbow

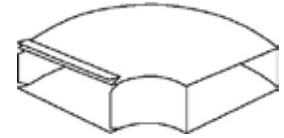

Part #	Model #	Size
8532	SWF-3X10-FW90	3-1/4" x 10"
17233	SWF-3X12-FW90	3-1/4" x 12"

314 Vertical 45° Shortway Angle

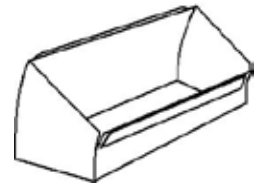

Part #	Model #	Size
7342	SWF-2X10-SW45	2-1/4" x 10"
17034	SWF-3X10-SW45	3-1/4" x 10"
6483	SWF-3X12-SW45	3-1/4" x 12"

307 Vertical 90° Shortway Elbow

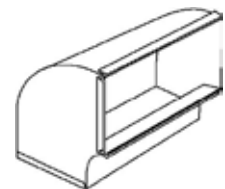

Part #	Model #	Size
7783	SWF-2X10-SW90	2-1/4" x 10"
16455	SWF-2X12-SW90	2-1/4" x 12"
17445	SWF-3X10-SW90	3-1/4" x 10"
6924	SWF-3X12-SW90	3-1/4" x 12"

Wall Stack & Fittings

520 Stack Straight Starting Collar

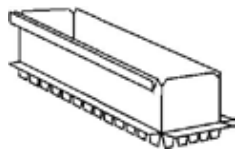

Part #	Model #	Size
14637	SWF-3X12-ST	3-1/4" x 12"

575 Stack Boot 90° Elbow

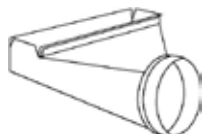

Part #	Model #	Size
221	SWF-2X10X6-WS-90	2-1/4" x 10" x 6"
398	SWF-2X12X6-WS-90	2-1/4" x 12" x 6"
10152	SWF-3X10X4-WS-90	3-1/4" x 10" x 4"
1428	SWF-3X10X6-WS-90	3-1/4" x 10" x 6"
6224	SWF-3X10X7-WS-90	3-1/4" x 10" x 7"
1556	SWF-3X12X6-WS-90	3-1/4" x 12" x 6"
6399	SWF-3X12X7-WS-90	3-1/4" x 12" x 7"
39516	SWF-3X12X8-WS-90	3-1/4" x 12" x 8"
27728	SWF-3X14X8-WS-90	3-1/4" x 14" x 8"

571 Stack Boot Center End

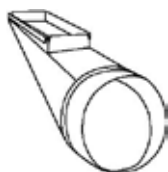

Part #	Model #	Size
1333	SWF-2X10X6-WS-CE	2-1/4" x 10" x 6"
1473	SWF-2X12X6-WS-CE	2-1/4" x 12" x 6"
11255	SWF-3X10X4-WS-CE	3-1/4" x 10" x 4"
2386	SWF-3X10X6-WS-CE	3-1/4" x 10" x 6"
19214	SWF-3X10X7-WS-CE	3-1/4" x 10" x 7"
2530	SWF-3X12X6-WS-CE	3-1/4" x 12" x 6"
7611	SWF-3X12X7-WS-CE	3-1/4" x 12" x 7"
39517	SWF-3X12X8-WS-CE	3-1/4" x 12" x 8"
16456	SWF-3X14X7-WS-CE	3-1/4" x 14" x 7"
27729	SWF-3X14X8-WS-CE	3-1/4" x 14" x 8"

572 Stack Straight Boot

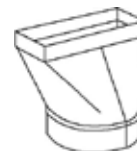

Part #	Model #	Size
2788	SWF-2X10X6-WS-ST	2-1/4" x 10" x 6"
12881	SWF-3X10X4-WS-ST	3-1/4" x 10" x 4"
4004	SWF-3X10X6-WS-ST	3-1/4" x 10" x 6"
23199	SWF-3X10X7-WS-ST	3-1/4" x 10" x 7"
4168	SWF-3X12X6-WS-ST	3-1/4" x 12" x 6"
9256	SWF-3X12X7-WS-ST	3-1/4" x 12" x 7"
39518	SWF-3X12X8-WS-ST	3-1/4" x 12" x 8"
38266	SWF-3X14X8-WS-ST	3-1/4" x 14" x 8"

302 Short Throat Stackhead

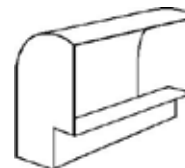

Part #	Model #	Size
1120	SWF-2X10-6X10-SH	2" x 10" - 6" x 10"
2197	SWF-3X10-6X10-SH	3-1/4" x 10" - 6" x 10"
2243	SWF-3X12-6X12-SH	3-1/4" x 12" - 6" x 12"

Miscellaneous Sheet Metal Products

Plenums

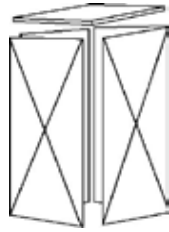

Part #	Model #	Size
4750	SMM-PL36-13.25	13-1/4" x 19-1/2" x 36"
8237	SMM-PL48-13.25	13-1/4" x 19-1/2" x 48"
14031	SMM-PL36-16.25	16-1/4" x 19-1/2" x 36"
17680	SMM-PL48-16.25	16-1/4" x 19-1/2" x 48"
4905	SMM-PL36-19.75	19-3/4" x 19-1/2" x 36"
8399	SMM-PL48-19.75	19-3/4" x 19-1/2" x 48"
4223	SMM-PL36-23.25	23-1/4" x 19-1/2" x 36"
7737	SMM-PL48-23.25	23-1/4" x 19-1/2" x 48"
187370	SMM-PLN-16X20-60	16" x 20" x 36"
8063	SMM-PLN-20X20-36	20" x 20" x 36"
8192	SMM-PLN-20X20-48	20" x 20" x 48"
187371	SMM-PLN-20X20-60	20" x 20" x 60"
18167	SMM-PLN-22X22-36	22" x 22" x 36"
9026	SMM-PLN-24X24-36	24" x 24" x 36"
9136	SMM-PLN-24X24-48	24" x 24" x 48"

Cold Return Top Load Filter Air Boot

• Filter sold separately

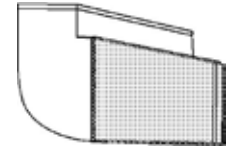

Part #	Model #	Size	Notes
70981	SSF-20X10-20X16-RAB	20" x 10" - 20" x 16"	*(1)
45078	SSF-20X10-20X19	20" x 10" - 20" x 19"	
13340	SSF-20X10-20X20-RAB	20" x 10" - 20" x 20"	
65296	SSF-25X10-25X16-RAB	25" x 10" - 25" x 16"	*
37941	SSF-25X10-25X19-RAB	25" x 10" - 25" x 19"	
65285	SSF-25X10-25X20-RAB	25" x 10" - 25" x 20"	*(2)

*With door
(1) Uses 24" x 16" x 4" media
(2) Uses 25" x 20" x 4" media

Side Load Filter Return Air Drop Kit

• Filter sold separately

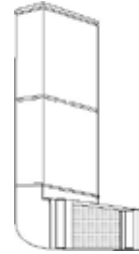

Part #	Model #	Size
11208	SSF-16X20-20X10-RAK	20" x 10" - 20" x 16" #1221
4258	SSF-16X25-25X10-RAK	25" x 10" - 25" x 16" #1222

Cold Return Side Load Filter Air Boot

• Filter sold separately

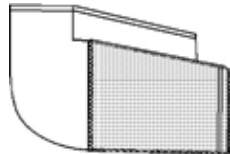

Part #	Model #	Size
12485	SSF-20X8-20X16-RAB	20" x 8" - 20" x 16"
10505	SSF-20X10-20X16-RAB	20" x 10" - 20" x 16"
16510	SSF-24X8-24X16-RAB	24" x 8" - 24" x 16"
20897	SSF-24X8-25X16-RAB	24" x 8" - 25" x 16"
2581	SSF-24X10-24X16-RAB	24" x 10" - 24" x 16"
12009	SSF-24X10-25X16-RAB	24" x 10" - 25" x 16"
187983	SSF-24X10-24X16 w/hinged door	24" x 10" - 24" x 16"

Top Load Filter Return Air Drop Kit

• Filter sold separately

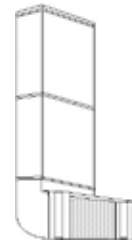

Part #	Model #	Size
124587	SSF-16X25-1222-T	25" x 10" - 25" x 16" #1222
6046	SSF-25X20-25X10-RAK	25" x 20" - 25" x 10"

Miscellaneous Sheet Metal Products

Filter Rack

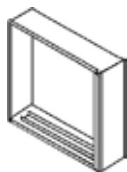

Part #	Model #	Size	Notes
7375	SMM-16X20-FIL	16" x 20"	-
4730	SMM-16X25-FIL	16" x 25"	-
46986	SMM-16X25-FIL-D	16" x 25"	w/door
39239	SMM-20X20-FIL	20" x 20"	-
19915	SMM-20X25-FIL	20" x 25"	-
125198	SMM-16X20-EFIL	16" x 20"	Economy
125199	SMM-16X25-EFIL	16" x 25"	Economy

Furnace Support Box



Part #	Model #	Size (L x W x H)	Openings
915	SMM-FSB-20X30	28" x 30" x 10"	8" x 24"
24601	SMM-FSB-28X48X12	28" x 36" x 12"	None
45288	SMM-FSB-36X28X15*	28" x 36" x 15"	10" x 25"
661	SMM-FSB-26X38	28" x 38" x 10"	10" x 24"

*Has slide out filter tray (Uses 20"x25"x5" Media)

Part #	Model #	Size (L x W x H)
83974	SMM-FSB	28-1/16" x 14-1/2" x 6"
39952	SMM-FSB	28-1/16" x 14-1/2" x 12"
39948	SMM-FSB	28-1/16" x 14-1/2" x 18"
83975	SMM-FSB	28-1/16" x 17-1/2" x 6"
39951	SMM-FSB	28-1/16" x 17-1/2" x 12"
39609	SMM-FSB	28-1/16" x 17-1/2" x 18"
83976	SMM-FSB	28-1/16" x 21" x 6"
39608	SMM-FSB	28-1/16" x 21" x 12"
39949	SMM-FSB	28-1/16" x 21" x 18"
83977	SMM-FSB	28-1/16" x 24-1/2" x 6"
39947	SMM-FSB	28-1/16" x 24-1/2" x 12"
39950	SMM-FSB	28-1/16" x 24-1/2" x 18"
41889	SMM-FSB-F*	28-1/16" x 14-1/2" x 18"
41891	SMM-FSB-F*	28-1/16" x 17-1/2" x 18"
41892	SMM-FSB-F*	28-1/16" x 21" x 18"
41893	SMM-FSB-F*	28-1/16" x 24-1/2" x 18"

*Has slide out filter tray

Return Air Frame



Part #	Model #	Size
1731	SMM-FRAME-10X6	10" x 6"
3496	SMM-FRAME-12X6	12" x 6"
33335	SMM-FRAME-12X12	12" x 12"
5394	SMM-FRAME-14X6	14" x 6"
5415	SMM-FRAME-14X8	14" x 8"
32712	SMM-FRAME-14X14	14" x 14"
14847	SMM-FRAME-24X6	24" x 6"
1636	SMM-FRAME-30X6	30" x 6"
1654	SMM-FRAME-30X8	30" x 8"

Furnace Bottom Pan

Part #	Model #	Size
84187	SMM-13.25X24-BOTTOM	13-1/4" x 24"
43572	SMM-16X24-BOTTOM	16" x 24"
43573	SMM-20X24-BOTTOM	20" x 24"
47960	SMM-23X24-BOTTOM	23" x 24"

Register Pan

- No flange, open one end

Part #	Model #	Size
33394	SMM-4X10X9-RP	4" x 10" x 9"

Standing "S" Cleat



Part #	Model #	Size	Gauge
44737	SMM-S-R-60-5/8	5/8" x 60"	24ga
13825	SMM-S-R-60	1" x 60"	24ga
34363	SMM-S-R-120-5/8	5/8" x 120"	24ga
17904	SMM-S-R-120-1	1" x 120"	24ga

Miscellaneous Sheet Metal Products

Hemmed Flat "S" Cleat



Part #	Model #	Size	Gauge
18715	SMM-S-008	8"	28ga
18928	SMM-S-010	10"	28ga
177	SMM-S-012	12"	28ga
377	SMM-S-014	14"	28ga
552	SMM-S-016	16"	28ga
723	SMM-S-018	18"	28ga
925	SMM-S-020	20"	28ga
185069	SMM-S-022	22"	28ga
1288	SMM-S-024	24"	28ga
185426	SMM-S-025	25"	28ga
16886	SMM-S-60	60"	28ga
7921	SMM-S-096	96"	28ga
10142	SMM-S-120	120"	28ga

Drive Cleat

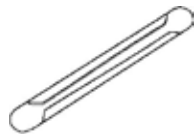

Part #	Model #	Size	Gauge
10915	SMM-DR-08	8"	26ga
11101	SMM-DR-10	10"	28ga
11283	SMM-DR-12	12"	28ga
10904	SMM-DR-60	1-1/8" x 60"	28ga
14283	SMM-DR-096	1-1/8" x 96"	28ga

Reinforcing Angle

Part #	Model #	Size	Gauge
28504	SMM-ANGLE-96	2" x 2" x 96"	26ga

Galvanized Register Boots Ceiling Box - Top with 1" Flange

Part #	Model #	Size	Insulation
44727	SBX-12X12X10-BOX	12" x 12" x 10"	R4
44728	SBX-14X14X12-BOX	14" x 14" x 12"	

Metal Drain Pan

- Leak-proof corner folds with full locking hem
- Includes one drain plug on long side

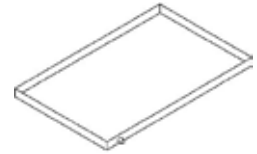

Part #	Model #	Size	Gauge
129744	SMM-DP-30X25X2	30" x 25"	24ga
50115	SMM-DP-30X30X2	30" x 30"	24ga
50117	SMM-DP-30X60X2	30" x 60"	24ga
50116	SMM-DP-36X36X2	36" x 36"	24ga
50118	SMM-DP-36X60X2	36" x 60"	24ga
50119	SMM-DP-36X72X2	36" x 72"	24ga

Galvanized Fresh Air Intake Vent

Part #	Model #	Size
26093	VENT-AIRINTAKE-4-GALV	4"
26095	VENT-AIRINTAKE-6-GALV	6"
26097	VENT-AIRINTAKE-8-GALV	8"
34736	VENT-AIRINTAKE-10-GALV	10"

Adjustable Duct Hanger with Spear Tip

Part #	Model #	Size	Gauge
21172	SMM-SPEAR	1" x 16-1/2"	18ga

Boot Frame

Part #	Model #	Size	Frame
51487	SBR-BF-4X10X24	4" x 10"	24"
128760	SBR-BF-4X12X24	4" x 12"	24"
51488	SBR-BF-6X10X24	6" x 10"	24"
51489	SBR-BF-6X12X24	6" x 12"	24"

PVC Coated Spiral Pipe & Fittings

PVC Coated Spiral Pipe & Fittings

PVC Coated Spiral Pipe



Part #	Model #	Size	Length
27439	PVS-06X10-PIPE	6"	10'
74278	PVS-08X10-PIPE	8"	10'
26116	PVS-10X10-PIPE	10"	10'
20372	PVS-12X10-PIPE	12"	10'

PVC Coated 4-Piece 90° Elbow

Part #	Model #	Size
16246	PVS-06-90	6"
16012	PVS-10-90	10"
15910	PVS-12-90	12"

PVC Coated Taper Reducer - Crimped Both Ends



Part #	Model #	Size
15239	PVS-10X08-RED	10" x 8"

PVC Coated 90° Saddle



Part #	Model #	Size
22556	PVS-06-SAD	6"

PVC Coated Register Boot 90° Elbow

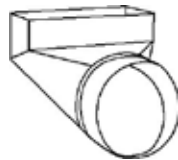

Part #	Model #	Size
12945	PVS-4X10X6-90	4" x 10" x 6"

PVC Coated Register Center End Boot

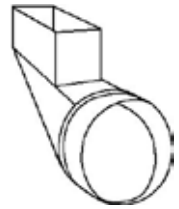

Part #	Model #	Size
14074	PVS-4X10X6-CE	4" x 10" x 6"

PVC Coated Connector

Part #	Model #	Size
6527	PVS-10-COUP	10"

PVC Coated Connector

- (6) Cans

Part #	Model #	Size
18391	PVS-PAINT	12 oz

**QUALITY.
SERVICE.
TOMMARK.**

Galvanized Spiral Pipe & Fittings

Galvanized Spiral Pipe & Fittings

Galvanized Spiral Pipe



Part #	Model #	Size	Gauge
17005	SGP-06X10-26	6" x 10'	26ga
7963	SGP-08X10-26	8" x 10'	26ga
18154	SGP-10X10-26	10" x 10'	26ga
9119	SGP-12X10-26	12" x 10'	26ga
393	SGP-14X10-26	14" x 10'	26ga
30547	SGP-16X10-26	16" x 10'	26ga
1460	SGP-18X10-24	18" x 10'	24ga
11308	SGP-20X10-24	20" x 10'	24ga
2425	SGP-22X10-24	22" x 10'	24ga
12417	SGP-24X10-24	24" x 10'	24ga

Galvanized Spiral Adjustable 90° Elbow



Part #	Model #	Size	Gauge
18169	SGF-06-26-90	6"	26ga
9131	SGF-08-26-90	8"	26ga
400	SGF-10-26-90	10"	26ga
10219	SGF-12-26-90	12"	26ga
1474	SGF-14-26-90	14"	26ga
11467	SGF-16-24-90	16"	24ga
2545	SGF-18-24-90	18"	24ga
12554	SGF-20-24-90	20"	24ga
13680	SGF-24-24-90	24"	24ga

Galvanized Spiral Connector

Part #	Model #	Size	Gauge
12334	SGF-06-CONN	6"	26ga
2075	SGF-08-CONN	8"	26ga
10596	SGF-10-CONN	10"	26ga
461	SGF-12-CONN	12"	26ga
8883	SGF-14-CONN	14"	24ga
17574	SGF-16-CONN	16"	24ga
7068	SGF-18-CONN	18"	24ga
15719	SGF-20-CONN	20"	24ga
13774	SGF-24-CONN	24"	24ga

Galvanized Spiral Taper Reducer Crimped Both Ends



Part #	Model #	Size	Gauge
9191	SGF-08X06-RED	8" x 6"	26ga
13735	SGF-10X08-RED	10" x 8"	26ga
755	SGF-12X08-RED	12" x 8"	26ga
18650	SGF-12X10-RED	12" x 10"	26ga
5210	SGF-14X10-RED	14" x 10"	26ga
4154	SGF-14X12-RED	14" x 12"	24ga
9871	SGF-16X12-RED	16" x 12"	24ga
8904	SGF-16X14-RED	16" x 14"	24ga
20005	SGF-18X12-RED	18" x 12"	24ga
14540	SGF-18X14-RED	18" x 14"	24ga
13461	SGF-18X16-RED	18" x 16"	24ga
480	SGF-20X16-RED	20" x 16"	24ga
18367	SGF-20X18-RED	20" x 18"	24ga

Galvanized Spiral 90° Saddle



Part #	Model #	Size	Gauge
29973	SGF-06-14/18-SAD	6"	14"-18"
13783	SGF-08-14/18-SAD	8"	14"-18"
17211	SGF-10-16/20-SAD	10"	16"-20"

Galvanized Spiral Register Saddle with Inside Tabs

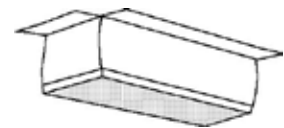

Part #	Model #	Size	Gauge	
3585	SGF-4X10-RS	4" x 10"	10"-12"	26ga
3486	SGF-4X12-RS	4" x 12"	10"-12"	26ga
22240	SGF-6X10-RS	6" x 10"	10"-12"	26ga
20912	SGF-6X12-RS	6" x 12"	10"-12"	26ga
37086	SGF-6X12-RS	6" x 12"	14"-16"	26ga
19296	SGF-6X14-RS	6" x 14"	10"-12"	26ga
39485	SGF-6X14-RS	6" x 14"	14"	26ga

Aluminum Duct & Fittings

Aluminum Duct Aluminum Pipe



Part #	Size
41164	4" x 24"
70691	4" x 48"

Aluminum Fittings Aluminum Adjusting Elbow



Part #	Size
70692	4"

Stainless Steel Vent Pipe & Fittings



SADJ



SE45



SE90

Single Wall SW Special Gas Vents & Fittings

- AL29-4C Superferritic stainless steel
- Precision TIG-welded butt seam
- Factory built-in, replaceable gaskets and locking band
- Wall thimble with built-in adjustable vent pipe

3" Model SW Single Wall SS Special Vent

Part #	Model #	Size
52568	3S12	12" Round Pipe
52570	3S24	24" Round Pipe
52571	3S36	3' Round Pipe
52572	3S48	4' Round Pipe
52573	3S60	5' Round Pipe
52574	3SADJ	2-Pc 6" - 19" Adj
52580	3SE90TR	90° TR Elbow
52577	3SE45	45° Adj Elbow

4" Model SW Single Wall SS Special Vent

Part #	Model #	Size
52630	4S24	24" Round Pipe
52632	4S48	4' Round Pipe
52633	4S60	5' Round Pipe
52634	4SADJ	2-Pc 6" - 19" Adj
52640	4SE90TR	90° TR Elbow
52670	4STS	Screen Termination



We maintain well-stocked and conveniently located warehouses. Please visit us at the branch nearest you.

B-Vent



Round Pipe

Adj Length Pipe

Increaser

Tee



90° Adj Elbow



45° Adj Elbow



60° Adj Elbow 3" - 6"



High Wind Cap 3" - 6"



Storm Collar 3" - 6"

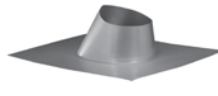

Adj Roof Flashing



Draft Hood Connector



Storm Collar 7" - 24"



Tall Cone Flashing

Round Type B Gas Vent & Pipe Fittings

3" Gas Vent Round

Part #	Model #	Description
3674	3RP12	3" x 12" Round Pipe
3745	3RP18	3" x 18" Round Pipe
3796	3RP24	3" x 24" Round Pipe
13348	3RP3	3" x 36" Round Pipe
13358	3RP4	3" x 48" Round Pipe
13371	3RP5	3" x 60" Round Pipe
13500	3RPA	3" x 12" Adj Pipe
14930	3REA90	90° Adj Elbow
10593	3RS	3" Storm Collar
13170	3RN4	3" - 4" Increaser
13720	3RT3	3" x 3" Tee
22131	3RHW	3" Metal High Wind Cap
10491	3RF	6-1/8" x 4-1/8" Adj Flashing (0 to 6/12)
12551	3RFA	3" Adj Flashing (6/12 to 12/12)
13903	3RTF	3" Tall Cone Flat Roof Flashing
14353	3RWT	3" Wall Thimble
13755	3RSA	3" Support Assembly
188405	3RWB	3" Wall Bracket

4" Gas Vent Round

Part #	Model #	Description
1772	4RPX12	4" x 12" Round Pipe
1822	4RPX18	4" x 18" Round Pipe
1880	4RPX24	4" x 24" Round Pipe
6843	4RPX3	4" x 36" Round Pipe
6853	4RPX4	4" x 48" Round Pipe
6866	4RPX5	4" x 60" Round Pipe
3993	4RPA	4" x 12" Adj Pipe
28609	4REA60	60° Adj Elbow
9713	4REA90	90° Adj Elbow
11541	4RS	4" Storm Collar
3725	4RN5	4" - 5" Increaser
3736	4RN6	4" - 6" Increaser
3746	4RN7	4" - 7" Increaser
4238	4RT4	4" x 4" Tee
22135	4RHW	4" Metal High Wind Cap
11423	4RF	7-3/8" x 4-1/8" Adj Flashing (0 to 6/12)
4402	4RTF	4" Tall Cone Flat Roof Flashing
4825	4RWT	4" Wall Thimble
52710	4OARA	Oval to Rnd Adapter
126889	4RWB	4" Wall Bracket
4270	4RSA	4" Support Assembly
45618	4RGS	4" Gripper Support
2926	4RDH	4" x 4-1/2" Draft Hood Connector

4" Female Vent Adapter

Part #	Model #	Description
59454	4RLA	4" Femal B-Vent Adapter
132431	4RRA	4" Female Adapter

QUALITY.
SERVICE.
TOMMARK.

B-Vent

5" Gas Vent Round

Part #	Model #	Description
22449	5RP6	5" x 6" Round Pipe
2633	5RP12	5" x 12" Round Pipe
2691	5RP18	5" x 18" Round Pipe
2742	5RP24	5" x 24" Round Pipe
13233	5RP3	5" x 36" Round Pipe
13243	5RP4	5" x 48" Round Pipe
13251	5RP5	5" x 60" Round Pipe
13382	5RPA	5" x 12" Adj Pipe
28608	5REA60	60° Adj Elbow
4501	5REA90	90° Adj Elbow
12438	5RS	5" Storm Collar
13086	5RN6	5" - 6" Increaser
22450	5RT4	5" x 4" Tee
13640	5RT5	5" x 5" Tee
22139	5RHW	5" Metal High Wind Cap
12314	5RF	5" Adj Flashing (0 to 6/12 Pitch)
12453	5RFA	5" Adj Flashing (6/12 to 12/12)
13794	5RTF	5" Tall Cone Flat Roof Flashing
14235	5RWT	5" Wall Thimble
126890	5RWB	5" Wall Bracket
13659	5RSA	5" Support Assembly
45619	5RGS	5" Gripper Support

6" Gas Vent Round

Part #	Model #	Description
3813	6RP6	6" x 6" Round Pipe
2161	6RP12	6" x 12" Round Pipe
2216	6RP18	6" x 18" Round Pipe
2263	6RP24	6" x 24" Round Pipe
3783	6RP3	6" x 36" Round Pipe
3797	6RP4	6" x 48" Round Pipe
3807	6RP5	6" x 60" Round Pipe
3912	6RPA	6" x 12" Adj Pipe
28611	6REA60	60° Adj Elbow
18477	6REA90	90° Adj Elbow
13372	6RS	6" Storm Collar
3624	6RN7	6" - 7" Increaser
3635	6RN8	6" - 8" Increaser
4161	6RT6	6" x 6" Tee
4143	6RT4	6" x 4" Tee
22140	6RHW	6" Metal High Wind Cap
2824	6RDH	6" Draft Hood Connector
13235	6RF	6" Adj Flashing (0 to 6/12 Pitch)
2943	6RFA	6" Adj Flashing (6/12 to 12/12)
4300	6RTF	6" Tall Cone Flat Roof Flashing
4166	6RSA	6" Support Assembly
45620	6RGS	6" Gripper Support
36703	6RRA	6" Adapter - Female

5" Female Vent Adapter

Part #	Model #	Description
12326	5RDH	5" Draft Hood Connector
57446	5RRA	5" Female Adapter
59455	5RLA	5" B-Vent Female Adapter
43625	5RYF	5" x 4" x 4" Wye

7" Gas Vent Round

Part #	Model #	Description
1727	7RP12	7" x 12" Round Pipe
1832	7RP24	7" x 24" Round Pipe
13133	7RP3	7" x 36" Round Pipe
13146	7RP4	7" x 48" Round Pipe
13154	7RP5	7" x 60" Round Pipe
13260	7RPA	7" x 18" Adj Pipe
13051	7REA90	90° Adj Elbow
14345	7RS	7" Storm Collar
14278	7RM	7" Cap
14205	7RF	7" Adj Flashing (0 to 6/12 Pitch)
12342	7RFA	7" Adj Flashing (6/12 to 12/12)
13693	7RTF	7" Tall Cone Flat Roof Flashing

B-Vent

8" Gas Vent Round

Part #	Model #	Description
1282	8RP12	8" x 12" Round Pipe
1319	8RP18	8" x 18" Round Pipe
1377	8RP24	8" x 24" Round Pipe
3675	8RP3	8" x 36" Round Pipe
3689	8RP4	8" x 48" Round Pipe
3697	8RP5	8" x 60" Round Pipe
3816	8RPA	8" x 18" Adj Pipe
7959	8REA90	90° Adj Elbow
15365	8RS	8" Storm Collar
4070	8RT8	8" x 8" Tee
15298	8RM	8" Cap
15227	8RF	8" Adj Flashing (0 to 6/12 Pitch)
2844	8RFA	8" Adj Flashing (6/12 to 12/12)
4197	8RTF	8" Tall Cone Flat Roof Flashing

10" Gas Vent Round

Part #	Model #	Description
8329	10RP18	10" x 18" Round Pipe
8380	10RP24	10" x 24" Round Pipe
11260	10RP3	10" x 36" Round Pipe
11422	10RPA	10" x 18" Adj Pipe
1499	10REA45	45° Adj Elbow
1073	10RM	10" Cap
1123	10RS	10" Storm Collar
1007	10RF	10" Adj Flashing (0 to 6/12 Pitch)
10490	10RFA	10" Adj Flashing (6/12 to 12/12)
11856	10RTF	10" Tall Cone Flashing

12" Gas Vent Round

Part #	Model #	Description
7338	12RP24	12" x 24" Round Pipe
11161	12RP3	12" x 36" Round Pipe
9941	12REA45	45° Adj Elbow
2785	12RS	12" Storm Collar
2735	12RM	12" Cap
2677	12RF	12" Adj Flashing (0 to 6/12 Pitch)
11755	12RTF	12" Tall Cone Flat Roof Flashing



A MUNCH'S SUPPLY COMPANY

**We are a full
line wholesaler.
Contact us for
information about
items not listed in
this catalog.**

Sheet Metal, Registers, Venting

Sheet Metal Products

Flexible Duct Connectors

Metal-Fab Connector

- 3" Metal, 3" fabric, 3" metal
- 24 Gauge galvanized
- Grip Loc seam
- 100' Roll



Part #	Model #	Item #	Description
15539	10159	MBX333	Excelon®

Junior Connector

- 1-3/4" Metal, 3" fabric, 1-3/4" metal
- 28 Gauge galvanized
- Guard Loc seam
- 100' Roll



Part #	Model #	Item #	Description
15640	10169	JBX-100	Excelon®

Dyn-O-Mate® Vane & Rails



Dyn-O-Mate® Hollow Turning Vane

- Designed to redirect the air through elbows and tees in ductwork without significant loss of air pressure

Part #	Model #	Item #	Description
48340	13207	HTV4-2410	4" x 10', 24ga Galv Steel

Dyn-O-Mate® Vane Rail

- Designed to redirect the air through elbows and tees in ductwork without significant loss of air pressure
- Has self-aligning tabs for easy vane installation

Part #	Model #	Item #	Description
70788	13302	DHVR4-2210	4" x 10', 22ga Galv Steel

Rapit™ Damper Regulators & Parts

Rapit™ Regulator

- 3" Metal, 3" fabric, 3" metal
- 24 Gauge galvanized
- Grip Loc seam
- 100' Roll



Part #	Model #	Item #	Description
1725	8086	RS156	(1) Spring Bearing, (1) Washer, Handle & Wing Nut
23089	8085	RS256	(2) Spring Bearings, (1) Washer, Handle & Wing Nut

Stampline® Damper Regulator Sets

1/4" Dial Regulator Set & Bearings for Dampers Up to 10"



Part #	Model #	Item #	Description
23130	8047	KS145L	Set Includes K-2 Regulator, KP-6 Long Spring Loc Bearing, KP-8S Long Sq End Bearing

Quadline® Damper Quadrant Sets

3/8" Quadrant Set

- For dampers up to 20"

Part #	Model #	Item #	Description
74777	8051	KS385	3/8" Quad Set Includes K-4 Quadrant, KP-7 Spring Loc Bearing, KP-9S Sq End Bearing

Access Doors

Standard Hinged Access Door



Part #	Model #	Item #	Description
19118	8169	IAD10X10	10" x 10"
21824	8170	IAD12X12	12" x 12"

Sheet Metal Products

Dyna-Tite™ Duct Hangers

CL-12 Cable Lock

- With 1/16 wire rope the load range is 75 lbs
- With 3/32 wire rope the load range is 150 lbs



Part #	Model #	Item #	Description
42895	30351	CL12	Cable Lock, 10/Pk

CL-23 Cable Lock

- With 1/8 wire rope the load range is 250 lbs
- With 3/16 wire rope the load range is 640 lbs



Part #	Model #	Item #	Description
33085	30350	CL23	Cable Lock, 10/Pk

Dyna-Tite™ Cable Lock Kit

- Includes:
 - Looped cable
 - CL18 Lock



Part #	Model #	Item #	Description
131826	30187	LC12K15-332	3/32" x 15' 1-1/2"

Cable Lock Wire Rope



Part #	Model #	Item #	Description
91161	30202	WC3	3/32" x 500'
25879	30204	WC4	1/8" x 500'
33088	30206	WC6	3/16" x 250'

Pocket Wire Rope Cable Cutter

- 3/16" Cutting capacity
- Storage catch
- Spring-loaded for ease of use
- Vinyl coated handles



Part #	Model #	Item #	Description
22223	894075	DTWRC	Cuts 1/8" Cable, 7-1/2" OAL 3/32" x 15' 1-1/2"

KV Bracket Assembly

- Enhances Dyna-Tite suspension system by addition of an integral bracket
- Fastens cable lock to duct with sheet metal screws



Part #	Model #	Description
64224	30361	Bracket Assembly with CL12 for use with 1/16" or 3/32" Cable

Dyna-Tite™ Zip-Clip Cable Lock & Looped Cable

- Safety factor 5:1
- Fits inside strut
- Work load limit: 220 lbs

Part #	Model #	Item #	Description
71537	30042	ZCWR10	10' Cable



Duct Hangers

Metallic Duct Strap Roll

- Galvanized duct strap in convenient cardboard dispenser
- Solid strapping, easy to drill or nail



Part #	Model #	Description
18240	6CKDS1H	26ga 1" x 100' Solid Strap

Poly Venting

PolyPro® Single-Wall Venting System

Single-Wall Pipe

- Use to vent condensing appliances
- 2" Overlap at the joint
- Listed to ULC-S636



Part #	Model #	Size
135435	2PPS-12L	2" x 12"
135436	2PPS-36L	2" x 36"
135437	2PPS-72L	2" x 72"
135468	3PPS-12L	3" x 12"
135469	3PPS-36L	3" x 36"
135470	3PPS-72L	3" x 72"

Black UV Resistant Single-Wall Pipe

- Use to vent condensing appliances
- 2" Overlap at the joint
- Listed to ULC-S636



Part #	Model #	Size
139432	2PPS-12BL	2" x 12"
139433	2PPS-36BL	2" x 36"
139447	3PPS-12BL	3" x 12"
139448	3PPS-36BL	3" x 36"

Adjustable Pipe

- Use to add length to straight length PolyPro® pipe
- Slips over standard single-wall pipe length
- 4-1/2" of adjustment



Part #	Model #	Size
135438	2PPS-08AL	2" x 4-1/2"
135471	3PPS-08AL	3" x 4-1/2"

Test Port Pipe

- Use to test for proper appliance operation without penetrating or disconnecting vent wall
- Install immediately above appliance



Part #	Model #	Size
135439	2PPS-TPL	2" x 10"
135472	3PPS-TPL	3" x 10"

PolyPro 45° Elbow w/LB2

- Offsets around obstructions as needed
- Includes 1 Locking Band
- Flex is double-wall polypropylene



Part #	Model #	Size
135441	2PPS-E45L	2"
135475	3PPS-E45L	3"

Black UV Resistant 45° Elbow



Part #	Model #	Size
139434	2PPS-E45BL	2"
139449	3PPS-E45BL	3"

PolyPro 90° Elbow w/LB2

- Offsets around obstructions as needed
- Includes 1 Locking Band
- Flex is double-wall polypropylene



Part #	Model #	Size
135442	2PPS-E90L	2"
135476	3PPS-E90L	3"

Poly Venting

Black UV Resistant 90° Elbow

- Offsets around obstructions as needed
- Made of UV resistant polypropylene
- Includes 1 locking band



Part #	Model #	Size
139435	2PPS-E90BL	2"
139450	3PPS-E90BL	3"

Black UV Resistant Extended 90° Elbow



Part #	Model #	Size
139436	2PPS-E90EBL	2" x 14"
139451	3PPS-E90EBL	3" x 14-1/4"

Tee with Cap

- Use for a 90° offset or to combine connections
- 8" diameter includes cap
- Includes 2 locking bands



Part #	Model #	Size
135446	2PPS-TL	2"
135479	3PPS-TL	3"

Black UV Resistant Tee

Part #	Model #	Size
139437	2PPS-TBL	2"
139452	3PPS-TBL	3"

Appliance Adapter, PVC to PolyPro®

- Use to connect rigid PolyPro® pipe length to PVC/CPVC coupler or appliance outlet
- Must be used with adapter connector for flue gas



Part #	Model #	Size
135440	2PPS-ADL	2"
135474	3PPS-ADL	3"

Adapter Connector

- Use to secure PolyPro® pipe to PVC/CPVC coupler or appliance outlet



Part #	Model #	Size
135466	PPS-PAC	2" - 4"

PolyPro Galvanized Metal Wall Strap

- Wall Strap legs can be rotated up to 360° for versatility
- Accepts standard 1/4" all-thread
- Available in galvanized or stainless steel metals



Part #	Model #	Size	Finish
135449	2PPS-WSM	2"	Galvanized
135483	3PPS-WSM	3"	Galvanized
135450	2PPS-WSM-SS	2"	Stainless
135484	3PPS-WSM-SS	3"	Stainless

Locking Band

- Use to secure (2) sections together
- Required only on 2" to 4" diameters to comply with ULC S636 listed installations



Part #	Model #	Size
135464	2PPS-LB2	2"
135497	3PPS-LB2	3"

Increaser

- Use to transition the vent system to a larger diameter
- Install in vertical orientation



Part #	Model #	Size
135448	2PPS-X3L	2" x 3"
135481	3PPS-X4L	3" x 4"

PolyPro Condensate Drain w/LB2

- Use to manage corrosive condensates common with high-efficiency systems
- Includes (1) locking band



Part #	Model #	Size
135445	2PPS-CDL	2"
135478	3PPS-CDL	3"
135535	3PPS-FAS	3"

EPDM Replacement Gasket

- Use as a replacement gasket for rigid PolyPro® products
- 12/Pack



Part #	Model #	Size
135462	2PPS-GA	2"
135496	3PPS-GA	3"

Poly Venting

Flex Chimney Lining Kit

- Use for vertical flex lining systems
- Includes:
 - Black UV resistant chimney cap
 - Rigid flue vent
 - Flex support bracket
 - (4) spacers (3" and 4" kits only)
 - Male and female flex adapters
 - Extended support elbow
 - Wall plate
 - Appliance adapter
 - Locking band
 - Adapter connector clamp
 - Gaskets



Part #	Model #	Size
135504	3PPS-FKL	3"

Vertical Termination Cap Kit Concentric

- Use for concentric vertical terminations
- Includes (2) appliance adapters and co-linear adapter



Part #	Model #	Size
135431	2PPS-VKL	2"
135433	3PPS-VKL	3"

Horizontal Termination Kit Concentric

- Use for concentric horizontal terminations
- Includes (2) appliance adapters, white wall plate, white firestop, and co-linear adapter
- UV resistant



Part #	Model #	Size
135429	2PPS-HKL	2" - 4"
135430	3PPS-HKL	3" - 5"

Horizontal Black Termination Metal w/LB2

Part #	Model #	Size	Pipes
135460	2PPS-HSTL	2"	Single
135494	3PPS-HSTL	3"	Single
135459	2PPS-HTPL	2"	Twin
135493	3PPS-HTPL	3"	Twin

Flex Chimney Liner



Part #	Model #	Size
135505	2PPS-FLEX25	2" x 25'
135507	2PPS-FLEX50	2" x 50'
135509	3PPS-FLEX25	3" x 25'
135510	3PPS-FLEX35	3" x 35'

Flex Chimney Liner Kit

Part #	Model #	Size
135503	2PPS-FK	2"

PolyPro Vertical Flex Termination Cap

- Black UV resistant
- Includes flex adapters and gaskets

Part #	Model #	Size
135495	3PPS-VFTL	3"

Adjustable Roof Flashing

- Roof pitch: 5/12 to 12/12 (F12)
- Black



Part #	Model #	Size
135457	2PPS-F12	2"
135491	3PPS-F12	3"

Firestop Spacer



Part #	Model #	Size	Pipes
135453	2PPS-FS	2"	Concentric
135487	3PPS-FS	3"	Concentric
135454	2PPS-FSS	2"	Single-Wall
135488	3PPS-FSS	3"	Single-Wall

Tee with Drain Cap

Part #	Model #	Size
135447	2PPS-TCDL	2"
135480	3PPS-TCDL	3"

Black Wall Plate

Part #	Model #	Size
135451	2PPS-WPB	2"
135485	3PPS-WPB	3"

Poly Venting

Twin Pipe Black Wall Plate

- Painted black metal with gasket



Part #	Model #	Size
135452	2PPS-WPT	2"
135486	3PPS-WPT	3"

B-Vent Retrofit Adapter

- Includes:
 - Adapter to cap
 - Flex/B-Vent lower support
 - C-Support bracket



Part #	Model #	Size	Chase
135536	3PPS-BV5	3"	5"

ESP Parts & Accessories

- For blocked intake on 2" and 3" PVC
- N-take 2 opens due to a slight vacuum inside



Part #	Model #	Description
72803	ESP-NT02	N-Take 2 Furnace Intake, Secondary Only

Horizontal Vent Termination Kit

- Use for venting high efficiency fossil fuel appliances
- Low profile kit hides vent from view



Part #	Model #	Description
128597	HVENT-2	2" Horizontal Vent Kit



Concentric venting

Concentric Vent

- Allows both the intake for combustion air and the exhaust vent to pass through a standard roof or sidewall
- Includes:
 - Combustion air inlet cap
 - Air inlet pipe
 - Vent pipe
 - Intake/vent concentric "Y"
 - Installation instructions on box



Part #	Model #	Description
86445	CVENT-2	For Use with 2" Intake/Vent Systems
86447	CVENT-3	For Use with 3" Intake/Vent Systems

Roof Flashing

No-Calk® Roof Flashing

Thermoplastic Standard Base No-Calk® Roof Flashing

- Slides over pipe
- For pitch to 45°
- Non-fading and non-cracking, rigid black thermoplastic base
- Non-fading, sealing collar
- Do not use petroleum based products on plastic bases or rubber collars
- Rated 180°F continuous heat
- Approved for Type B installations
- Not for hot-mopped or built-up roofs



Part #	Model #	Size
14238	11909	2"
14247	11910	3"
14256	11911	4"

Flex-Flash® Roof Flashing

- Slides over pipe - for pitch to 45°
- 100% completely flexible/foldable
- Do not use petroleum based products on rubber bases or rubber collars
- Non-fading TPR base and collar
- No caulking needed
- Rated 180°F continuous heat
- Not for hot-mopped or built-up roofs



Part #	Model #	Size
15477	14038	3"
15506	14041	4"

All-Flash® No-Calk® Highrise® Roof Flashing

- Slides over pipe for pitch 10° to 60°
- Do not use petroleum based products on plastic bases or rubber collars
- Ring on collar tears off, sealing flashings to different pipe diameters
- Rated 180°F continuous heat
- Not for hot-mopped or built-up roofs
- Non-fading, non-cracking and nonrusting rigid black TPE base and sealing collars
- Approved for Type B installations



Part #	Model #	Size
64344	11931	3" - 4"

Alumi-Flash Systems

Alumi-Flash for Standard Roof

- Used for condensate or refrigerant or gas lines going through the roof
- Includes hose clamps
- 10-Year limited warranty



With 126 Cap



With 212 Cap

Part #	Model #	Description
8305	22015	Base with C-126 Cap, 1 Port 2" - 6"
9129	22025	Base with C-212 Cap, 2 Ports 1/2" - 1" and 2 Ports 1" - 2"
10942	22035	Base with C-412 Cap, 4 Ports 1" - 2"

EPDM Deckmate Flashing

- Rubber flashing for corrugated metal roof
- Used for condensate, refrigerant, or gas lines going through the roof
- Includes hose clamps
- 10-Year limited warranty against deterioration due to weather



Part #	Model #	Model	Size
4427	81036	D.M. 3	1/4" OD - 4" OD
4453	81050	D.M. 5	4" OD - 7" OD

Registers & Grilles

Residential Ceiling Diffusers

11 Duct Ring

- For installation of #16 diffuser when not using a damper



Part #	Model #	Size	Finish
13512	13200	6" Dia	Brown
15530	13201	8" Dia	Brown
17157	13202	10" Dia	Brown
150	13203	12" Dia	Brown

12 Butterfly Damper

- Controls air volume evenly over entire #16 diffuser
- Removable knob operator for adjustment from closed to fully open



Part #	Model #	Size	Finish
18766	13220	6" Dia	Brown
1644	13221	8" Dia	Brown
10382	13222	10" Dia	Brown
12231	13223	12" Dia	Brown

16 Ceiling Diffuser

- Round steel construction
- Step-down face



Part #	Model #	Size	Finish
17762	12900	6" Dia	White
740	12901	8" Dia	White
7510	12902	10" Dia	White
9393	12903	12" Dia	White

Ceiling & Wall Diffuser

- Easy to install, no tools required
- For heating and A/C ventilation duct systems
- Non-sweating
- Fully adjustable grille
- Center adjustment cone allows for variable ventilation capacity
- Lifetime warranty

EASYAIR



Part #	Model #	Size	Finish
57233	EAG4	4" Dia	White
57234	EAG6	6" Dia	White
57235	EAG8	8" Dia	White

Quick Mount Fittings

- All white plastic design, will not rust or sweat
- Simple to install
- For ceiling or wall applications

EASYAIR



Part #	Model #	Description
57236	QM6	6"

Residential Floor Registers & Grilles

265 Heavy-Duty Floor Return Air Grille

- Steel construction
- Free area averages over 75%
- Provides firm, smooth surface
- Extremely rigid



Part #	Model #	Size	Finish
6525	11851	4" x 10"	Brown
6541	11852	4" x 12"	Brown
6405	11860	6" x 10"	Brown
6434	11861	6" x 12"	Brown
6457	11862	6" x 14"	Brown
6552	11866	6" x 24"	Brown
6610	11867	6" x 30"	Brown
6296	11870	8" x 10"	Brown
6316	11871	8" x 12"	Brown
6332	11872	8" x 14"	Brown
6441	11876	8" x 24"	Brown
6501	11877	8" x 30"	Brown
11775	11881	10" x 12"	Brown
22680	11885	10" x 20"	Brown
11664	11890	12" x 12"	Brown
11682	11891	12" x 14"	Brown
11742	11894	12" x 20"	Brown
11787	11895	12" x 24"	Brown
11845	11896	12" x 30"	Brown
11576	11898	14" x 14"	Brown
11630	11901	14" x 20"	Brown
11670	11903	14" x 24"	Brown
11733	11906	14" x 30"	Brown

Registers & Grilles

420 Toe-Space Grille

- Steel construction
- Multi-angle fins
- Heavy-gauge stamped face



Part #	Model #	Size	Finish
16711	11301	10" x 2"	Brown
18644	11303	12" x 2"	Brown
1540	11305	14" x 2"	Brown
17799	11300	10" x 2"	White
5610	11302	12" x 2"	White

421 Stamped Floor Diffuser

- Steel construction
- Multi-angle fins
- Foot-operated dial control
- Can be used in high traffic areas
- Rolled fin for strength and safety

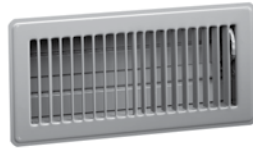

Part #	Model #	Size	Finish
16467	010710	2" x 10"	Brown
18412	010712	2" x 12"	Brown
15606	010714	2" x 14"	Brown
19641	010705	4" x 8"	Brown
9737	010721	4" x 14"	Brown
19330	010765	6" x 10"	Brown
15326	010767	6" x 12"	Brown
9272	010711	2" x 10"	White
9288	010713	2" x 12"	White
20169	010706	4" x 8"	White
19240	010764	6" x 10"	White
20273	010766	6" x 12"	White

Part #	Model #	Size	Finish
44972	421MB4X10	4" x 10"	Brown
44974	421MB4X12	4" x 12"	Brown
44973	421MW4X10	4" x 10"	White
44975	421MW4X12	4" x 12"	White

Residential Baseboard Registers & Grilles

406 Baseboard Diffuser

- Steel construction
- Blankets wall or window area

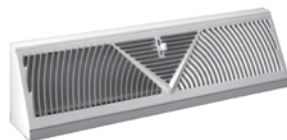

Part #	Model #	Size	Finish
2066	10681	18"	Brown
7679	10680	18"	White

462 Baseboard Diffuser

- Steel construction
- Airfoil valves reduce resistance
- Equal air distribution over the length of the diffuser
- Face can be easily removed



Part #	Model #	Size	Finish
12856	10726	24"	White

654 Baseboard Register

- Steel construction
- 1/3" Fin spacing set at 20°
- 7/8" Margin turnback
- Plate damper



Part #	Model #	Size	Finish
1196	43621	12" x 6"	White

655 Baseboard Register

- Steel construction
- 1/3" Fin spacing set at 20°
- 3-3/4" Base projection
- Volume-control damper



Part #	Model #	Size	Finish
7937	043633	14" x 6"	White

657 Baseboard Return

- Steel construction
- 1/3" Fin spacing set at 20°
- 7/8" Margin turnback
- Install with fins upward or downward for best duct concealment
- Complementary return air grille for Model 654 or 664 supply



Part #	Model #	Size	Finish
14116	43641	10" x 6"	White
16164	43644	12" x 6"	White
18107	43649	14" x 6"	White
14023	43671	30" x 8"	White

Registers & Grilles

Residential Sidewall & Ceiling Registers & Grilles

631 Sidewall/Ceiling Register

- Steel construction
- 1/3" Fin spacing set at 20°
- Multi-shutter valve
- 3-Way deflection
- 1-5/8" Depth when fully opened



Part #	Model #	Size	Finish
10707	10750	8" x 4"	White
16368	10753	10" x 6"	White

650 Sidewall Return Air Grille

- Steel construction
- 1/3" Fin spacing set at 20°
- 5/16" Margin turnback



Part #	Model #	Size	Finish
24741	43106	8" x 8"	White
17065	43108	10" x 4"	White
17081	43109	10" x 6"	White
17100	43110	10" x 8"	White
14073	43111	10" x 10"	White
24550	43113	10" x 20"	White
25766	43114	10" x 24"	White
51	43116	12" x 4"	White
67	43117	12" x 6"	White
84	43118	12" x 8"	White
13966	43119	12" x 10"	White
13986	43120	12" x 12"	White
26708	43124	12" x 20"	White
25478	43125	12" x 24"	White
1829	43126	14" x 4"	White
1850	43127	14" x 6"	White
1871	43128	14" x 8"	White
13856	43129	14" x 10"	White
13879	43130	14" x 12"	White
13904	43131	14" x 14"	White
13922	43132	14" x 16"	White
13957	43134	14" x 20"	White
13994	43135	14" x 24"	White
3634	43139	16" x 8"	White
13750	43140	16" x 10"	White
13772	43141	16" x 12"	White
13793	43142	16" x 14"	White
13814	43143	16" x 16"	White
13851	43144	16" x 20"	White
13891	43145	16" x 24"	White

650 Sidewall Return Air Grille

Part #	Model #	Size	Finish
5531	43147	18" x 8"	White
13728	43152	18" x 18"	White
7421	43154	20" x 6"	White
7438	43155	20" x 8"	White
13567	43156	20" x 10"	White
13582	43157	20" x 12"	White
13606	43158	20" x 14"	White
13619	43159	20" x 16"	White
13653	43161	20" x 20"	White
13684	43162	20" x 24"	White
11134	43166	24" x 6"	White
11152	43167	24" x 8"	White
13349	43168	24" x 10"	White
13367	43169	24" x 12"	White
13399	43170	24" x 14"	White
13429	43171	24" x 16"	White
13458	43173	24" x 20"	White
13501	43174	24" x 24"	White
16988	43177	30" x 6"	White
17001	43178	30" x 8"	White
13040	43179	30" x 10"	White
13056	43180	30" x 12"	White
45339	43186	30" x 30"	White



A MUNCH'S SUPPLY COMPANY

**WE APPRECIATE
YOUR BUSINESS!**

Registers & Grilles

659 Sidewall Return Air Filter Grille

- Steel construction
- 1/3" Fin spacing set at 20°
- Removable face
- Adjustable filter retainers
- Conceals filter
- Standard 1" disposable filters sold separately



Part #	Model #	Size	Finish
1118	43401	12" x 12"	White
1197	43402	12" x 20"	White
1227	43403	12" x 24"	White
1046	43404	14" x 14"	White
1093	43405	14" x 20"	White
1129	43406	14" x 24"	White
1140	43407	14" x 25"	White
961	43409	16" x 16"	White
999	43410	16" x 20"	White
1040	43411	16" x 25"	White
881	43413	18" x 18"	White
690	43416	20" x 12"	White
712	43417	20" x 14"	White
737	43418	20" x 16"	White
775	43419	20" x 20"	White
826	43420	20" x 25"	White
509	43423	24" x 12"	White
525	43424	24" x 14"	White
540	43425	24" x 16"	White
609	43428	24" x 24"	White
9738	43430	25" x 14"	White
9764	43431	25" x 16"	White
9792	43432	25" x 20"	White

661 Sidewall/Ceiling Supply Register

- Steel construction
- 1/3" Fin spacing set at 20°
- Multi-shutter valve
- 2-Way deflection
- 1-5/8" Depth when fully open
- Interlocking valve louvers for positive shut-off
- Ideal for shallow duct installations



Part #	Model #	Size	Finish
6882	10815	8" x 8"	White
15334	10816	10" x 4"	White
15355	10819	10" x 6"	White
15385	10820	10" x 8"	White
6682	10854	10" x 10"	White
17339	10821	12" x 4"	White
17354	10823	12" x 6"	White
17379	10825	12" x 8"	White
6599	10844	12" x 12"	White
28331	10827	14" x 4"	White
352	10830	14" x 6"	White
373	10832	14" x 8"	White
2086	10834	16" x 8"	White

672 Sidewall Return Air Grille

- Steel construction
- 1/2" Fin spacing set at 40°
- 5/16" Margin turnback



Part #	Model #	Size	Finish
44998	672M10X6	10" x 6"	White
44999	672M10X10	10" x 10"	White
45000	672M12X6	12" x 6"	White
45002	672M12X12	12" x 12"	White
45003	672M14X6	14" x 6"	White
45005	672M14X14	14" x 14"	White
170928	67218X10W	18" x 10"	White
170929	67214X10W	14" x 10"	White
23710	67212x12W	12" x 12"	White

Registers & Grilles

682M Builder Series Sidewall Supply Register

- Steel with metal handle
- 1/2" Fin spacing set at 40°
- Multi-shutter valve
- 2-Way deflection
- 1-5/8" Depth when fully open
- Interlocking valve louvers for positive shut-off
- Ideal for shallow duct installations

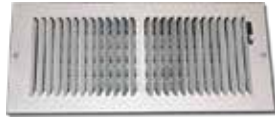

Part #	Model #	Size	Finish
44984	703908	10" x 4"	White
44985	703909	10" x 6"	White
44986	703911	12" x 4"	White
44987	703912	12" x 6"	White

Commercial Registers

821 Commercial Supply Register

- Steel construction
- Horizontal multi-shutter damper
- Vertical adjustable face bars



Part #	Model #	Size	Finish
4014	75005	10" x 4"	White
4037	75007	10" x 6"	White
5930	75010	12" x 4"	White
5947	75012	12" x 6"	White
24578	75013	12" x 8"	White
7887	75018	14" x 6"	White

Commercial T-Bar

FPD3 Commercial Fixed Pattern Diffuser

- Steel construction
- Formed steel back panel
- 360° Air diffusion
- Damper adjustable through face
- 3-Cone fixed core
- Accepts fixed collars of 6" to 14"
- Utilizes 3800 series butterfly damper inserted in collar
- Overall size: 23-3/4" x 23-3/4"



Part #	Model #	Size	Finish
5746	50509	6" Dia	White
5766	50510	8" Dia	White
5780	50511	10" Dia	White
5799	50512	12" Dia	White
5826	50513	14" Dia	White

3800 Damper for T-Bar Diffusers

- Adjustable butterfly damper with removable handle
- For use with 5400 and 6400 series collars



Part #	Model #	Size	Finish
4842	50290	6" Dia	Brown
4862	50292	8" Dia	Brown
4881	50294	10" Dia	Brown
4893	50295	12" Dia	Brown

Steel Return Air Grill

- Steel construction
- Mount flush with T-Bar ceilings
- Bright white finish
- Available sizes (inches)



Part #	Model #	Size
5286	94AT	22" x 22"
21647	SMF	24" x 24"

5400 Collar

- Unique snap-in design for easy installation
- 2" High collar permits easy flex connections
- Bead on collar improves the strength and provides retention for flexible duct connections
- Includes (4) small plastic push pins to snap into prepunched holes in metal plenum



Part #	Model #	Collar
1224	50312	8" Dia
1256	50316	12" Dia

5400PP Push Pin

- Permits attachment of 5400 collar to the molded fiberglass back



Part #	Model #	Model #	Qty
17251	14525	5400PP	100 Pc/Bag

659TI Commercial T-Bar Steel Lanced Return Air Filter Grille

- Steel construction
- Lanced-face design with 1/3" blade spacing
- Flush, removable face with concealed latches and hinges
- Can be installed in any direction
- Accepts 6" to 16" 6400 series tab collars, 5400 and 5400PP series snap-in collars or standard spin-in collars
- R-4.2 Insulation
- Overall size: 23-3/4" x 23-3/4"
- Standard 1" disposable filters sold separately



Part #	Model #	Filter	Finish
13823	50560	20" x 20"	White

Models and Specifications are Subject to Change Without Notice

Registers & Grilles

RENPS Renovator Series T-Bar Supply Commercial Diffuser with Insulated Back

- Perforated steel face with deflector
- Molded R-4.2 fiberglass back panel
- Accepts 6400 series lab collar or 5400/5400PP snap-on collar or standard spin-in collar
- Overall size: 23-3/4" x 23-3/4"



Part #	Model #	Filter	Finish
18247	50356	RENPS	White

USAIRE™

Grilles

Galvanized Spiral Grille



Part #	Model #	Size
77262	SPG1204	12" x 4"
77263	SPG1403	14" x 3"
77264	SPG1804	18" x 4"
77265	SPG2004	20" x 4"
77266	SPG2406	24" x 6"

Rotaire Grilles

Undereve Bath Fan Vent with Screen

- 360° Rotation



Part #	Model #	Size	Color	Overall
26081	3840-WH-S	4" Duct	White	5-1/2"
26082	3840-WN-S	4" Duct	Brown	5-1/2"
41087	3840-DB-S	4" Duct	Beige	5-1/2"
56464	3860-DB-S	6" Duct	Beige	7-1/2"



Return Air Panning

T-rap Return Air Panning

- High quality, lightweight alternative to sheet metal in constructing return air ducts between joists
- Corrugated insulation faced with aluminum
- Significantly reduces duct noises and labor
- Requires no shop fabrication



Part #	Model #	Size
44147	16048	16" x 47-1/2"
50611	19048	19-1/2" x 47-1/2"

T-rap Header

- For tight sealing air block
- Pre-cut and scored to fit easily between joists



Part #	Model #	Size	Header
44150	16016	16" x 16"	Standard

T-rap Class 1 Fire-Rated Header

Part #	Model #	Size	Header
87854	16013	16" x 12"	Standard

T-rap Panel Connector

- Molded polypropylene strips which easily connect T-rap panels

Part #	Model #	Size
44148	16348	16"

Universal Residential Mounting Bracket

- Pre-mounted brackets provide an easy one-man installation job
- Multi-use applications including copper, PVC and ABS pipe
- Maintenance free, use indoors or out
- Eliminates vibrations and noise call backs
- Easy to re-open for an additional or custom adjustment
- UV Protected

Part #	Model #	Size
44152	41118	1-1/2" OD

Panning Nails

Part #	Model #	Description
194888	16778	Panning Nails 5 Lbs.

Chimney Liner Kits

Chimney Liner Kits

Aluminum Liner Kit

- For use with masonry chimneys for venting NG and LP appliances listed for use with Type B vents



Part #	Model #	Size
16013	TL3-25	3" x 25'
16123	TL3-35	3" x 35'
6353	TL4-25	4" x 25'
6473	TL4-35	4" x 35'
15913	TL5-25	5" x 25'
16001	TL5-35	5" x 35'
6245	TL6-25	6" x 25'
6344	TL6-35	6" x 35'
15799	TL7-25	7" x 25'
15903	TL7-35	7" x 35'
6237	TL8-35	8" x 35'

Extension Kit

Part #	Model #	Size
10423	TLEK0410	4" x 10'
11348	TLEK0510	5" x 10'
12267	TLEK0610	6" x 10'

View the reference pages for sizes.



A MUNCH'S SUPPLY COMPANY

WE CARE WHO YOU ARE

Big business or small, you can expect the best service and quality products at competitive prices.

Sheet Metal, Registers, Venting

Duct Insulation

Fiberglas® Duct Board

- EnDuraGold™ FRK Facing
- 1-Component system
- Factory controlled board thickness
- Acoustically efficient lightweight system
- Tight closure system
- UL 181 Listed Class 1 Air Duct

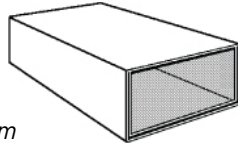

Type 475 Fiberglas® Duct System

Part #	Model #	Size
13283	QUIET R TYPE 475	4' x 10' x 1"

Fiberglas® All Service Duct Wrap

Type 75 SoftR™ Fiberglass Duct Wrap

- Foil reinforced kraft facing (FRK)
- Reduces dust and itch
- Assured thermal performance
- Condensation control
- Meets model energy and mechanical codes



Part #	Model #	Size	Header
5222	DWF1548	1-1/2" x 48" x 100'	4.2
26326	DWF2248-R6	2.2" x 48" x 75'	6.0
46764	DWF348-R8	3" x 48" x 50'	8.0

QuietR™ AcousticR™ Duct Liner

- Bonded blanket of glass fibers
- Designed to be installed inside ductwork and plenums with metal fasteners and adhesives
- Virtually damage-proof construction
- Bacteria and fungal growth resistance
- Code compliant



Part #	Model #	Size
55355	T200	1/2" x 47" x 100'
55356	T200-59	1/2" x 59" x 100'
55384	447354	1" x 47" x 100'

Reflectix, Inc.

The World's Largest Manufacturer of Reflective Insulation

Duct Insulation

- 5/16" Thick, (7) layer, reflective insulation
- (2) Outer layers of aluminum foil reflect 97% of radiant heat

Part #	Model #	Size
23660	HVPB48125G	48" x 125'

R-8.0 HVAC Duct Insulation

Big Bubble Insulation

- Reflective/bubble/reflective insulation
- Non-toxic, non-carcinogenic
- Itch and fiber free
- Inhibits condensation
- Not affected by moisture or humidity
- Lightweight and clean
- Energy efficient
- Class A/Class 1 fire rated
- Resists growth of fungi, mold and mildew



Part #	Model #	Size
68947	HVBB48075	48" x 75'
51176	HVBB48125	48" x 125'

Duct Spacers



Part #	Model #	Size
51374	HVSPACER	3/4" Rectangular for R-6

Double Bubble Staple Tab Duct Insulation

- (2) Outer layers of aluminum foil reflect 97% of radiant heat
- Each layer is bonded to layer of polyethylene for strength
- (2) Inner layers of insulating bubbles resist conductive heat flow
- Temperature range: -60° to 180°F
- Nominal thickness: 5/16"



Part #	Model #	Size
55424	HVST1610003	5/16" x 16" x 100'

Flex Duct

Flex Duct

F214 R-4.2 Class 1 Flex Duct with Silver Jacket

- Box packaging
- R-4.2 Insulated 2-ply polyester core with metallized polyester jacket reinforced with fiberglass scrim
- UL Listed



Part #	Model #	Diameter	Length
62747	557818	3"	25'
8563	051035	4"	25'
8577	051036	5"	25'
8587	051037	6"	25'
44123	047308	6"	50'
8600	051038	7"	25'
44124	047309	7"	50'
8613	051039	8"	25'
8627	051041	10"	25'
8645	051042	12"	25'
8673	051043	14"	25'
8685	051044	16"	25'
8713	051045	18"	25'
8735	051046	20"	25'

F216-R6.0 Class 1 Flex Duct with Silver Jacket

- Box packaging
- R-6.0 Insulated 2-ply polyester core with metallized polyester jacket reinforced with fiberglass scrim
- UL Listed



Part #	Model #	Diameter	Length
34814	051323	4"	25'
132041	051324	5"	25'
34815	051325	6"	25'
34816	051326	7"	25'
34817	051327	8"	25'
35175	051329	10"	25'
37743	051330	12"	25'
39078	051331	14"	25'
38457	051332	16"	25'
39082	051333	18"	25'
39083	051334	20"	25'

F218 R-8.0 Class 1 Flex Duct with Silver Jacket

- Box packaging
- R-8.0 Insulated 2-ply polyester core with metallized polyester jacket reinforced with fiberglass scrim
- UL Listed



Part #	Model #	Diameter	Length
39866	027823	4"	25'
39868	027825	6"	25'
39869	027826	7"	25'
39870	027827	8"	25'
39871	027828	9"	25'
39872	027829	10"	25'
39873	027830	12"	25'
39874	027831	14"	25'
39875	027832	16"	25'
39876	027833	18"	25'

F118 R-8.0 Class 1 Flex Duct with Vinyl Jacket

- Box packaging
- R-8.0 Insulated 2-ply polyester core with metallized polyester jacket reinforced with fiberglass scrim
- UL Listed



Part #	Model #	Diameter	Length
173845	027812	4"	25'
86001	027814	6"	25'
86002	027815	7"	25'
39857	027816	8"	25'
39858	027817	9"	25'
173847	027818	10"	25'
173848	027819	12"	25'
173849	027820	14"	25'

Flex Duct

Sleeve

F204 R-4.2 Flex Duct Sleeve with Silver Jacket

- R-4.2 Insulated metallized polyester jacket
- Includes (1) starter cone per carton
- UL Listed



Part #	Model #	Diameter	Length
39324	051120	4"	5'
83	051121	5"	5'
96	051122	6"	5'
107	051123	7"	5'
112	051124	8"	5'
121	051125	9"	5'
130	051126	10"	5'
148	051127	12"	5'
167	051128	14"	5'
190	051129	16"	5'

F108 R-8.0 Class 1 Flex Sleeve with Vinyl Jacket

- R-4.2 Insulated metallized polyester jacket
- Includes (1) starter cone per carton
- UL Listed



Part #	Model #	Diameter	Length
173863	553265	4"	25'
173865	553267	6"	25'
173866	553268	7"	25'
173867	553269	8"	25'
173868	553270	9"	25'
173869	553271	10"	25'
173870	553272	12"	25'
173871	553273	14"	25'
173872	553274	16"	25'



6 CONVENIENT LOCATIONS

ANN ARBOR

141 Jackson Industrial
Ann Arbor, MI 48103
P (800) 665-1452
F (734) 665-0679
M-F: 7:30 a.m. - 4:30 p.m.

COLDWATER

36 Mill Street
Coldwater, MI 49036
P (800) 922-5180
F (517) 279-7350
M-F: 7:30 a.m. - 4:30 p.m.

GRAND RAPIDS

130 Graham S.W.
Grand Rapids, MI 49503
P (800) 541-1144
F (616) 247-0283
M-F: 7:30 a.m. - 4:30 p.m.

JACKSON

1021 Belden Road
Jackson, MI 49203
P (800) 333-8005
F (517) 782-1155
M-F: 7:30 a.m. - 4:30 p.m.

LANSING

1115 S. Pennsylvania
Lansing, MI 48912
P (800) 487-4836
F (517) 487-1119
M-F: 7:30 a.m. - 4:30 p.m.

SAGINAW

219 Atwater
Saginaw, MI 48601
P (800) 292-0233
F (989) 754-4241
M-F: 7:30 a.m. - 4:30 p.m.

Flex Duct

F206 R-6.0 Flex Duct Sleeve with Silver Jacket

- R-6.0 Insulated metallized polyester jacket
- Includes (1) starter cone per carton
- UL Listed



Part #	Model #	Diameter	Length
37011	027538	4"	5'
35297	027484	6"	5'
35298	027540	7"	5'
35299	027541	8"	5'
37013	027542	9"	5'
37014	027543	10"	5'
37015	027544	12"	5'
37016	027545	14"	5'
37017	027546	16"	5'

F208 R-8.0 Flex Duct Sleeve with Silver Jacket

- R-8.0 Insulated metallized polyester jacket
- Includes (1) starter cone per carton
- UL Listed



Part #	Model #	Diameter	Length
50473	553277	6"	5'
50474	553278	7"	5'
50475	553279	8"	5'
50476	553280	9"	5'
50477	553281	10"	5'
51938	553282	12"	5'
51939	553283	14"	5'
51940	553284	16"	5'

Air Connectors

AlumiFlex™ F040CP Class 0 Residential Air Connector

- Sturdy corrugated aluminum construction
- Crimped, compressed



Part #	Model #	Diameter	Length
10283	055694	3"	8'
10293	055695	4"	8'
10299	055696	5"	8'
10315	055697	6"	8'
10320	055698	7"	8'
10331	055699	8"	8'
33882	055700	10"	8'

F090 Class 1 Air Connector

- Uninsulated 2-ply metallized polyester construction
- UL Listed



Part #	Model #	Diameter	Length
8014	044782	3"	25'
8023	044783	4"	25'
7539	044785	6"	25'
7549	044786	7"	25'
7561	044787	8"	25'
7573	044789	10"	25'
7600	044790	12"	25'
7620	044791	14"	25'

Flex Duct

Smart Flow Elbow

- For new and retrofit applications
- Forms flexible duct into a 90° elbow
- One size fits all brands of 4" to 16" flex duct
- Eliminates flex duct kinks and restrictions
- Decreases pressure drop by up to 500% over a kinked duct
- UL-2043 Classified



Part #	Model #	Description
67641	630500	Smart Flow Elbow

Parts & Accessories

Smart Filter Seal

- Seals furnace filter ducts from 1" - 4" width and 10" - 25" height
- 2-Piece overlapping construction
- Forest green color

Part #	Model #	Description
72662	2000153	Smart Filter Seal

Sheet Metal, Registers, Venting

Ventilation

Power Roof Ventilator Accessories

Variable-Speed Controller

- For UL 705 applications
- Adjustment of air movement from 100% to approximately 50%
- 120V, 60Hz
- Can be used to operate more than one fan (cannot exceed control rating)
- Not for use with any kitchen exhaust or NFPA/96 applications



Part #	Model #	Description
62632	5ACCO3SC	3A Maximum

Fantech Accessories

Backdraft Damper

- For circular ducts
- Galvanized steel
- (2) Spring-loaded damper blades
- Can be mounted vertically



Part #	Model #	Size
44751	RSK4	4" x 3-1/4"
59531	RSK6	6" x 3-1/8"
59532	RSK8	8" x 3-1/8"
59533	RSK10	10" x 3"

**QUALITY.
SERVICE.
TOMMARK.**

Ventilation

Exhaust Fans

- All ventilators are UL 705 Standard listed
- One-piece removable exhaust hood
- Inlet temperatures up to 170°F
- Backward inclined aluminum fan wheel
- Equipped with a built-in bird screen to protect discharge
- Externally cooled motor compartment



Part #	Down Blast, Roof Mounted, Direct Drive Fan	Voltage	Max CFM	Weight	Roof Mounted Damper	Flat Roof Curb, Insulated	Control	
							115V	230V
64408	FAN 5DDD085A 8"	115V 1Ph	417	26 lbs.	5ACC12RD	5ACC17FT	5ACC03SC	x
59551	FAN 5DDD10AA 10"	115V 1Ph	944	44 lbs.	5AAC12RD	5ACC17FT	5ACC03SC	x
59552	FAN 5ACC17FT	115V 1Ph	994	51 lbs.	5ACC12RD	5ACC17FT	5ACC03SC	x
59549	FAN 5DDD12CA 12"	115V 1Ph	1744	55 lbs.	5ACC15RD	5ACC20FT	5ACC06SC	x
64359	FAN 5ACC06SC	120V		1 lb.				
62624	FAN 5DDD13DB 13"	115/230V 1 PH	2223	66 lbs.	5ACC15RD	5ACC20FT	RPE10	RPE210
65287	FAN 5DDD16DB 16"	115/230V 1 PH	2913	149 lbs.	5ACC15RD	5ACC24FS	RPE10	RPE210
69242	FAN 5DDD18EB 18"	115/230V 1 PH	4030	164 lbs.	5ACC19RD	5ACC28FS	RPE10	RPE210

*Non-stock, call for pricing.

Dimensions

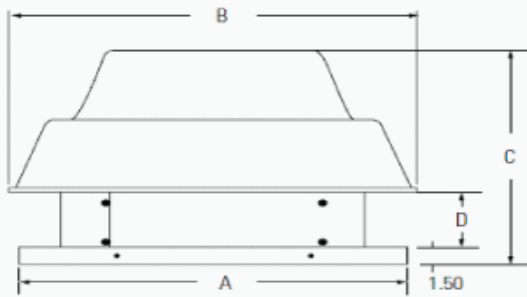

Part #	Model #	A	B	C	D
59550	FAN 5ACC20FT	20	17-1/2	28-1/2	12
60594	FAN 5ACC24FS	24	21-1/2	32-1/2	8
64408	5DDD085A	19	18-7/8	13-1/4	3-1/2
62633	5DDD106A	19	22-3/8	16-1/2	3-3/8
59551	5DDD10AA	19	22-3/8	16-1/2	3-3/8
59549	5DDD12CA	22	24-1/4	17-1/8	4
62624	5DDD13DB	22	25-5/8	18-1/8	4-3/8
60592	5DDD15CA	26	27-7/8	18-1/2	4-3/8
65287	5DDD16DB	26	29-3/4	20-1/4	4-3/4
69242	5DDD18EB	30	31-5/8	21-3/8	5-5/8

Roof Mount Damper

- Manufactured from 19-gauge galvanized steel frame 2" deep with 1" flange
- For quiet operation, aluminum blades have felted edges
- Pre-punched conduit hole knock-out



Part #	Model #	Fan Size	Rec. Roof Opening	Out. Flange, inch	Weight lbs.	Item #
60541	5ACC12RD	10	12-1/2" x 12-1/2"	12 x 12	3	47196
60046	5ACC15RD	12, 13	15-1/2" x 15-1/2"	15 x 15	4	47203
60593	5ACC19RD	15, 16	19-1/2" x 19-1/2"	19 x 19	5	47210
63135	5ACC23RD	18, 20	23-1/2" x 23-1/2"	23 x 23	9	47215

Ventilation

Cool Attic® Power Vents

- 115V, 60Hz Thermally protected motor
- Adjustable thermostat

VX Roof Mount Power Attic Ventilator

- 1.9A
- Galvanized steel dome
- 1,080 CFM Rating at 0.03 static pressure
- 2-Year limited warranty



VX1000AM

Part #	Model #	Finish
43960	VX1000AM	Mill
43980	VX1000AMWG	Weathered Gray

VXSVR Roof Mount Power Attic Ventilator

- 5.1A
- 1,600 CFM Rating at 0.03 static pressure
- 5-Year limited warranty



Part #	Model #	Finish
44589	VXSVRAMWG	Weathered Gray

Parts & Accessories

Controls

- Adjustable

Part #	Model #	Finish
52471	XXFIRESTAT	50°-120° 115V 15A Thermostat with Firestat™
54778	XXDUOSTAT	Dual Thermostat/Humidistat

Motor

- For use with power attic ventilators
- PSC (XE406)



Part #	Model #	Amps
52469	XE401	3.4A
54777	XE406	5.1A



Vent Caps

Versa Cap™ Flue and Hot Stack Cap

- Non-clogging positive draft design
- Adjustable clamp fitting
- UL Listed



Part #	Model #	Pipe OD	Single Wall
1601	SRF-03X04-V	2-7/8" - 5"	3" & 4"
11926	6-5070G	4-7/8" - 7"	5" & 6"
3457	6-7090G	6-7/8" - 9"	7" & 8"
13850	SRF-09X10-V	8-7/8" - 11"	9" & 10"
2189	SRF-12X14-V	11-7/8" - 14-1/2"	12" & 14"



A MUNCH'S SUPPLY COMPANY

We are a full line wholesaler. Contact us for information about items not listed in this catalog.

Ventilation

LoSone® Select® Ventilators

- 20 Gauge galvanized steel housing
- Quiet, automatic backdraft damper
- Sound-absorbing acoustic insulation
- Can be ducted horizontally or vertically
- Use Broan® electronic variable speed control to adjust blower speed and sound level (available separately)
- 120V
- AMCA Licensed for both air and sound

LoSone® Models L100/L150 Ceiling-Mount Fan

- 6" Duct size
- Single, impact-resistant centrifugal blower wheel
- Housing dimensions: 11-3/4"H x 12-1/4"W x 12-1/4"L
- 14" x 14" White grille
- UL Listed for use over bathtubs or showers when connected to a GFCI circuit
- 1-Year warranty



Part #	Model #	CFM	Sones	Grille
22008	L100	109	0.9	Polymer
22010	L150	157	1.5	Polymer

LoSone® Model L200/L300 Ceiling-Mount

- Single, impact-resistant centrifugal blower wheel
- Housing dimensions: 11-3/4"H x 12-1/4"W x 12-1/4"D
- 8" Round duct connector
- 14" Square grille



Part #	Model #	CFM	Sones	Grille
22011	L200	210	1.7	White Polymer
22012	L300	308	2.9	White Polymer

LoSone® Model L400 Ceiling-Mount

- 4-1/2" x 18-1/2" Duct connector
- 23-1/4" x 14" Grille
- (2) Impact-resistant centrifugal blower wheels



Part #	Model #	CFM	Sones	Grille
22744	L400	434	2.3	White Metal

Bath Fans

Economy Ceiling-Mount Bath Fan

- Duct size: 4"
- Torsion spring grille mounting
- 10-5/8" x 11-1/8" white polymeric grille
- Double strength mounting flanges with keyhole slots
- Centrifugal blower wheel and 4-pole motor
- Key-holed mounting brackets
- Housing dimensions: 5-3/4"H x 8-1/4"W x 8"L
- UL listed for use over bathtubs or showers when connected to a GFCI circuit



Part #	Model #	CFM	Sones
172214	A80	80	2.5
172212	A110	110	4.0

Deluxe Ceiling/Wall Fan

- 3" Round duct connector
- 9" x 9-1/4" white polymeric grille
- Torsion spring grille mounting
- Double strength mounting flanges with keyhole slots
- UL listed for showers and baths with GFCI-protected branch circuit
- Housing dimensions: 3-5/8"H x 7-1/2"W x 7-1/4"D



Part #	Model #	CFM	Sones
18427	671	70	6.0

Economy Ceiling/Wall-Mount Bath Fan

- 3" Duct size
- 9" x 9-1/4" white polymeric grille
- Torsion spring grille mounting
- Double strength mounting flanges with keyhole slots
- Compact housing fits easily between ceiling joists or wall studs
- Housing dimensions: 3-5/8"H x 7-1/2"W x 7-1/4"L
- UL listed for use over bathtubs or showers when connected to a GFCI circuit
- 1-Year warranty



Part #	Model #	CFM	Sones
18579	688	50	4.0

Ventilation

Combination Bath Fans Economy Fan/Light

- 4" Duct size
- 10-5/8" x 11-1/8" white polymeric grille
- 100W lighting capacity (bulb not included)
- Shatter-resistant light diffusing lens
- Type IC (insulation contact)
- Plug in, permanently lubricated motor
- Mounting ears
- Use with model 68W or 68V two-function control (available separately)
- Polymeric duct connectors with tapered sleeves
- Housing dimensions: 5-3/4"H x 8-1/4"W x 8"L
- UL listed for use over bathtubs or showers when connected to a GFCI circuit
- 1-Year warranty



Part #	Model #	CFM	Sones	Light
18485	678	50	2.5	Incandescent
18494	A70L	70	2.0	Incandescent

Power Attic Ventilators

Roof-Mounted Power Attic Ventilator

- 14" Diameter steel blades
- Operates automatically, built-in thermostat
- Thermally protected, permanently lubricated motor



Part #	Model #	CFM	For attics up to:	Color
20251	358	1,000	1,715 sq ft	Alum

Venting Accessories

634/634M Roof Cap

- Black
- Footprint: 14-1/4"W x 18-3/4"L
- Backdraft damper and bird screen provide a dependable roof cap
- 24 Gauge CRCQ steel construction with black electrically-bonded epoxy finish for durability and long life
- For use with range hoods, LoSone® Fans and bath ventilation fans



Part #	Model #	Description
20053	634	For 3-1/4" x 10" or Up to 8" Round Duct
10962	634M	For up to 6" Round Duct

636 Roof Cap

- Steel baked black enamel finish
- Footprint: 10-1/4"W x 11"L
- Built-in backdraft damper and bird screen



Part #	Model #	Description
18075	636	For 3" or 4" Round Duct

644 Roof Cap

- Aluminum natural finish
- Built-in backdraft damper and bird screen



Part #	Model #	Description
18161	644	For 3-1/4" x 10" or 6" - 8" Round Duct

441 Wall Cap

- Steel with aluminum louvers
- Gravity dampers



Part #	Model #	Description
16176	441	For 10" Round Duct

639 Wall Cap

- 24 Gauge CRCQ steel, black electrically-bonded epoxy finish
- Spring-loaded backdraft damper
- Built-in bird screen



Part #	Model #	Description
18099	639	For 3-1/4" x 10" Duct

641 Wall Cap

- Aluminum natural finish
- Built-in backdraft damper and bird screen



Part #	Model #	Description
18117	641	For 6" Round Duct

643 Wall Cap

- Aluminum natural finish
- Built-in backdraft damper



Part #	Model #	Description
18146	643	For 8" Round Duct

Ventilation

885BL Wall Cap

- 24 Gauge CRCQ steel, black electrically bonded epoxy finish
- Built-in damper and bird screen
- Includes 4" to 3" transition



Part #	Model #	Description
11207	885BL	For 3" or 4" Round Duct
192311	885AL	Aluminium Wallcap

Range Hood Accessories

Make-Up Air Damper

- Universal
- Automatic
- Includes pressure sensor kit



Part #	Model #	Description
123676	MD6TU	6" Damper
137652	MD8TU	8" Damper



Wall Vent Caps

Aluminum Wall Vent Cap



Part #	Model #	Size
11017	111840	6"
9996	111823	8"
37306	111824	10"

*Includes screen and damper

Plastic Wall Cap



Part #	Model #	Size	Color
18054	111777*	6"	White
48116	111778**	8"	White

*Sold in bulk

** Includes screen

Roof Caps

- Plastic
- Includes damper, screen and collar



Part #	Model #	Size	Color
11174	111250*	4"	Black

*Sold in bulk

Air Intake Vents

Louvered Type Air Intake Vent



Part #	Model #	Size	Color
1935	110811	4"	White
52828	110972	4"	Brown
1848	110898	6"	White
2277	111007	6"	Brown
46363	110906	8"	White

Vent Hoods

Plastic Louvered Vent Hood

- Tailpiece sold separately



Part #	Model #	Size	Color
45870	110842	6"	Brown
18707	110838	6"	White

Aluminum Standard Vent Hood

- Standard tailpiece



Part #	Model #	Size
18281	110271	4"



Ventilation Products

Air Return Diffuser

- Egg crate lay-in louver
- White polystyrene 1/2" open cell grid

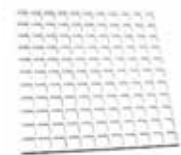

Part #	Model #	Description
2698	650-300	2' x 2' x 1/2"
1034	650-100	2' x 4' x 1/2"

Plastic Wall Vent with J Channel

- Plastic hood for brick, siding and stucco applications
- 1" tailpipe included



Part #	Model #	Description
188000	111705	4" White Trim Depth 0-.5"
188001	111706	4" White Trim Depth .5-1.15"

Ventilation

Bathroom Venting

3" Supurr-Vent® Louvered Bathroom Vent

- Opens with ease for maximum exhaust flow
- Curved louvers for quieter operation
- Durable and weather-resistant
- Unassembled
- Includes hood, pipe and collar



Part #	Model #	Size	Color
9251	SVHUW3	3"	White

Dryer Venting

Dryer Vent with Supurr Vent® Louvered Vent Hoods

- Unassembled
- Includes hood, aluminum pipe and collar



Part #	Model #	Size	Color
424	SVHUB4	4"	Brown
18829	SVHUW4	4"	White

Wide Mouth Dryer Vent Hood

- Removable bird guard helps prevent birds and other pests from nesting in vent or entering home
- Vent closure designed for maximum airflow
- Durable weather resistant
- Should self clean with wind or rain
- Assembled
- Includes hood, aluminum pipe and collar



Part #	Model #	Size	Color
42120	RVHAB4	4"	Brown
30842	RVHAW4	4"	White

Increaser/Reducer

- Connects 3" to 4" duct
- Plastic



Part #	Model #	Size	Color
37283	IRB43	4" - 3"	White

Bathroom/Dryer Vents

UNDEReVe® Vent

- For clothes dryer or bathroom exhaust venting
- Helps prevent cold air from entering the home
- Helps prevent birds from nesting in the vent and rodents from entering the home
- Vents clothes dryer exhaust, bathroom exhaust and any other vent up to 5" diameter
- 6/Case



Part #	Model #	Size	Color
15698	EVE/6	8"	White

Dryer Vent Boxes

Metal Dryer Vent Box with Snap-On Trim Ring

- Can also be used for down venting by turning box upside down
- 22 Gauge steel
- Powder-coated white finish



Part #	Model #	Size	For use with:
53952	DBX1000M-4	4"	2" x 4" Wall
53951	DBX1000M-6	6"	2" x 6" Wall

QUALITY. SERVICE. TOMMARK.

Ventilation

Side Wall Vent Systems

Packaged Side Wall Vent System

- Complete vent system
 - Power venter
 - 4" Vent hood (VH1-4)
 - 4" Draft control (DC4)
- Non-adjustable 45-second, post-purge relay/timer to purge vent system of residual flue gases after burner cycle
- For gas furnaces, boilers, pool heaters, and commercial water heaters
- Built-in fan proving switch interlocks with gas valve
- Durable, heavy-duty aluminum vent hood
- 4" Vent pipe
- 115V, 60Hz, 3,000 rpm, 95W, 1.26A
- 24/115V Switching relay therm protection
- Includes everything for installations except vent pipe
- AGA Certified



Part #	Model #	Description
35655	GPAK-1	Up To 250,000 BTUH

Side Wall Vent Hood

- Heavy-duty, corrosion-resistant aluminum construction
- Models VH1-3, VH1-4 and VH1-6 have an additional heat shield for built-in clearances from combustibles
- Includes all mounting hardware



Part #	Model #	Diameter	Rough-In
2789	VH1-3	3"	6-3/4" sq
2795	VH1-4	4"	8" sq

Eave Vent

Part #	Description
133833	Vent-Eave-6-WH

Inline Duct Fans for Round Duct

- For residential and commercial applications

FR Series Inline Centrifugal Fan

- Plastic housing constructed of UL-recognized, UV protected thermoplastic resin
- For outdoor and wet locations*
- Powered by external rotor motor
- Fully caulked to prevent moisture from entering the housing
- Prewired external wiring box with weatherproof gasket and mounting bracket
- 100% Speed controllable
- Suitable for airstream temperatures up to 140°F
- Energy Star® rated**
- cULus Listed
- cCSAus Certified
- 5-Year factory warranty



Part #	Model #	Duct	Volts	CFM
56803	FR110**	4"	115V	167
56804	FR150	6"	120V	263
62626	FG8	8"	120V	428
57974	FG10XL	10"	120V	598

*Not manufactured to operate with water running through the motor compartment, or to be used in applications where the fan would be buried underground
** Not Energy Star rated

DBF110 Dryer Exhaust Fan

- Integrated automatic pressure switch
- Maintains 1,200 FPM velocity to suspend lint
- Connects using external wiring box with waterproof gasket
- 4" Duct
- Voltage: 115V
- Single-phase
- CSA Certified
- HVI Certified
- 5-Year factory warranty



Part #	Model #	Description
63205	DBF110	Dryer Boosting Kit with 167 CFM Fan

Boilers

Dunkirk VLT - Gas-Fired, Wall Hung, Modulating, Condensing, Water Boiler

- Built-in primary/secondary piping cuts installation time in half
- Control features:
 - Built-in low water cut-off
 - 5:1 Turn down ratio
 - Outdoor reset
 - Priority domestic hot water
 - Integrated multiple boiler control (up to 16 boilers)
- Included with boiler:
 - Wall mounting bracket
 - 3/4" Drain valve
 - ASME Relief valve
 - Outdoor temperature sensor
 - LP Kit
- Stainless steel heat exchanger
- Warranty:
 - Parts: 1-year limited
 - Heat exchanger: 15-year limited



Part #	Model #	Heating Input BTUH Min/Max	Heating Cap BTUH	AFUE	Piping Connections Supply, Return, Gas	Combustion Air & Vent Pipe Eq Length (Sch 40 PVC, CPVC, Polypropylene)				
						Min	6'	6'	x	111 lbs
74044	DKVLT-100	20,000/100,000	91,000	95.0%	1-1/4", 1-1/4", 1/2"	Max	50'	100'	x	x
74045	DKVLT-150	30,000/150,000	139,000	95.0%	1-1/4", 1-1/4", 3/4"	Min	x	6'	x	x
74046	DKVLT-200	40,000/200,000	185,000	95.0%	1-1/4", 1-1/4", 3/4"	Max	x	100'	x	x

Dunkirk VX - Gas-Fired, Wall Hung, Modulating, Condensing, Water Boiler

- Control features:
 - Built-in low water cut-off
 - 5:1 Turn down ratio
 - Outdoor reset
 - Priority domestic hot water
 - Integrated multiple boiler control (up to 16 boilers)
- Included with boiler:
 - Wall mounting bracket
 - 3/4" Drain valve
 - ASME Relief valve
 - Outdoor temperature sensor
- Stainless steel heat exchanger
- Warranty:
 - Parts: 1-year limited
 - Heat exchanger: 15-year limited
 - \$500 First year heat exchanger labor warranty



Part #	Model #	Heating Input BTUH Min/Max	Heating Cap BTUH	AFUE	Piping Connections Supply, Return, Gas	Combustion Air & Vent Pipe Eq Length (Sch 40 PVC, CPVC, Polypropylene)			
						2"	3"	135 lbs	200 lbs
159967	VX-075	15,000/75,000	69,000	95.0%	3/4", 3/4", 1/2"	Min	6'	6'	135 lbs
159968	VX-100	20,000/100,000	92,000	95.0%	3/4", 3/4", 1/2"	Max	50'	100'	135 lbs
159969	VX-150	30,000/150,000	140,000	95.0%	1", 1", 3/4"	Min	x	6'	200 lbs
159970	VX-200	40,000/200,000	186,000	95.0%	1", 1", 3/4"	Max	x	100'	200 lbs

Boilers

Dunkirk DXL - Gas-Fired, Floor Standing, Gravity Vented, Water Boiler

- Control features:
 - Built-in low-water cut-off
 - Boiler reset control
 - Circulator relay
 - Domestic hot water input override
- Included with boiler:
 - Cast iron circulator pump (Grundfos)
 - Integral draft diverter
 - 3/4" Drain valve
 - ASME Relief valve
- Cast iron heat exchanger
- Warranty:
 - Parts: 1-year limited
 - Heat exchanger: 20-year non-prorated limited



Part #	Model #	Heating Input BTUH Min/Max	Heating Cap BTUH	AFUE	Piping Connections Supply, Return, Gas	Flue Diameter	W x D x H	Ship Wt
192072	DXL-50	50,000	42,000	83.5%	1-1/4", 1-1/4", 1/2"	4"	11-1/8" x 27" x 36-3/4"	205 lbs
192074	DXL-75	75,000	63,000	83.1%	1-1/4", 1-1/4", 1/2"	5"	15" x 27" x 36-3/4"	253 lbs
192076	DXL-100	100,000	83,000	83.0%	1-1/4", 1-1/4", 1/2"	6"	16" x 27" x 37-1/4"	253 lbs
192077	DXL-125	125,000	104,000	82.0%	1-1/4", 1-1/4", 1/2"	6"	18-7/8" x 27" x 37-1/4"	315 lbs
192078	DXL-150	150,000	124,000	83.0%	1-1/4", 1-1/4", 1/2"	7"	18-7/8" x 27" x 37-3/4"	315 lbs
192079	DXL-170	170,000	139,000	82.0%	1-1/4", 1-1/4", 3/4"	7"	22-3/4" x 27" x 38-3/4"	377 lbs
192081	DXL-200	200,000	165,000	82.0%	1-1/4", 1-1/4", 3/4"	8"	22-3/4" x 27" x 38-3/4"	377 lbs



A MUNCH'S SUPPLY COMPANY

Boilers

Dunkirk WPSB - Gas-Fired, Floor Standing, Gravity Vented, Water Boiler

- Control features:
 - Built-in low-water cut-off
 - Boiler reset control
 - Circulator relay
 - Domestic hot water input override
- Included with boiler:
 - Cast iron circulator pump (Grundfos)
 - Integral draft diverter
 - 3/4" Drain valve
 - ASME Relief valve
- Cast iron heat exchanger
- Warranty:
 - Parts: 1-year limited
 - Heat exchanger: 20-year non-prorated limited



Part #	Model #	Heating Input BTUH	Heating Cap BTUH	AFUE	Piping Connections Supply, Return, Gas	Flue Diameter	W x D x H	Ship Wt
130522	WPSB-7D	225,000	188,000	84.0%	1-1/4", 1-1/4", 1/2"	6"	24-1/2" x 26-1/5" x 36-3/8"	601 lbs
82291	WPSB-8D	262,000	220,000	83.9%	1-1/4", 1-1/4", 1/2"	6"	27-1/2" x 26-1/5" x 36-3/8"	665 lbs
25448	WPSB-9D	299,500	251,000	83.7%	1-1/4", 1-1/4", 1/2"	6"	30-3/4" x 26-1/5" x 36-3/8"	750 lbs

Dunkirk XEB - Gas-Fired, Floor Standing, Induced Draft, Water Boiler

- Control features:
 - Digital temperature display and diagnostics
 - Plug-in connection for system plug
- Draft inducer allows flue gases to be exhausted through a chimney or side wall vent*
- Included with boiler:
 - Cast iron circulator pump (Grundfos)
 - 3/4" Drain valve
 - ASME Relief valve
- Cast iron heat exchanger
- Warranty:
 - Parts: 1-year limited
 - Heat exchanger: 20-year non-prorated limited



Part #	Model #	Heating Input BTUH	Heating Cap BTUH	AFUE	Piping Connections Supply, Return, Gas	Vent Diameter,		W x D x H	Ship Wt
						(Cat I) Chimney	(Cat III) Hort Vent		
82404	XEB-3	75,000	63,000	83.4%	1-1/4", 1-1/4", 1/2"	4"	3"	14-1/4" x 23-1/4" x 29"	265 lbs
82405	XEB-4	112,500	94,000	83.0%	1-1/4", 1-1/4", 1/2"	4"	3"	17-1/2" x 23-1/4" x 29"	322 lbs
82406	XEB-5	150,000	125,000	82.7%	1-1/4", 1-1/4", 1/2"	4"	3"	20-3/4" x 23-1/4" x 29"	370 lbs
82407	XEB-6	187,500	155,000	82.3%	1-1/4", 1-1/4", 1/2"	4"	4"	24" x 23-1/4" x 29"	480 lbs

*Conventional venting through a lined chimney use a 4" flue adapter included.
 *Thru-the-wall venting requires 3" or 4" field supplied appliance adapter and cat III venting (sold separately).

Boilers

Hydronics

Dunkirk DCB/DCC

Gas-Fired, Wall Hung, Modulating, Condensing, Water Boiler

DCC Model For Combination Domestic Hot Water and Space Heating.

DCB Models For Space Heating Only.

- Dunkirk AI (Artificial Intelligence) control features
 - Auto commissioning and continuous calibration functions to optimize combustion.
 - High limit control
 - Low water sensor
 - Digital temperature display and diagnostics
 - 5.7:1 turndown in heating mode 7:1 turndown in combi mode
- DCB units include:
 - Wall mounting bracket
 - Two speed primary circulator pump
 - 3/4" drain valve
 - ASME relief valve
 - Labor saving primary/secondary manifold (DCB only)
- DCC combination boiler includes:
 - Stainless steel brazed plate heat exchanger for domestic hot water
- 316L Stainless steel heat exchanger
- Warranty:
 - Parts: 2-year limited
 - Heat exchanger: 8 year limited



Part #	Model #	Heating Input BTUH Min/Max	Heating Cap BTUH	Domestic Hot Water Output: @ 70° rise	AFUE	Piping Connections: Supply, Return, Gas, DHW	Flue Diameter*: To Chimney (Cat I), Hort Vent (Cat III)	W x D x H	Ship Wt
184764	DCB-125	22,000 / 125,000	113,000	N/A	95.0%	3/4", 3/4", 3/4", x	3" Coaxial	17-23/32" x 13-13/32" x 30"	103 lbs
184328	DCC-150	22,000 / 153,000	136,000	3.5 GPM	95.0%	3/4", 3/4", 3/4", 1/2"	3" Coaxial	17-23/32" x 13-13/32" x 30"	103 lbs

*Thru-the-wall venting requires field supplied appliance adapter and cat III venting (sold separately).



A MUNCH'S SUPPLY COMPANY

WE CARE WHO YOU ARE

Big business or small, you can expect the best service and quality products at competitive prices.

Boilers

Dunkirk DWB - Gas-Fired, Wall Hung, Modulating, Induced Draft, Water Boiler CCB Model for Combination Domestic Hot Water and Space Heating CHB Models for Space Heating Only

- Modulating inducer and gas valve for operation between 33% and 100% capacity
- Control features:
 - High limit control
 - Digital temperature display and diagnostics
- Draft inducer allows flue gases to be exhausted through a chimney or sidewall vent*
- CHB and CCB units include:
 - Wall mounting bracket
 - Primary circulator pump
 - 3/4" Drain valve
 - ASME Relief valve
- CCB-150 Combination boiler includes:
 - Stainless steel brazed plate heat exchanger for domestic hot water
 - 24-Volt diverting - priority valve for domestic valve
- Copper heat exchanger
- Warranty:
 - Parts: 2-year limited
 - Heat exchanger: 10-year limited



Part #	Model #	Heating Input BTUH Min/Max	Heating Cap BTUH	Domestic Hot Water Output: @ 70° rise @ 40° rise	AFUE	Piping Connections: Supply, Return, Gas, DHW	Flue Diameter*: To Chimney (Cat I), Hort Vent (Cat III)	W x D x H	Ship Wt
143752	CHB-100	33,000/100,000	85,000	x, x	85.0%	1", 1", 3/4", x	4", 3"	15-3/4" x 13" x 27-9/16"	65 lbs
143747	CCB-150	50,000/150,000	127,000	3.6 gpm, 6.3 gpm	85.0%	1", 1", 3/4", 3/4"	4", 3"	17-3/4" x 13" x 27-9/16"	78 lbs

Dunkirk PSB - Gas-Fired, Floor Standing, Gravity Vented, Steam Boiler

- Control features:
 - Probe type low-water cut-off
 - Pressure high limit control
- Included with boiler:
 - Integral draft diverter
 - Glass water level gauge
 - Brass copper pig tail
 - Powered vent damper
 - 3/4" Drain valve
 - Relief valve
- Cast iron heat exchanger
- Warranty:
 - Parts: 1-year limited
 - Heat exchanger: 12-year limited (residential)



Part #	Model #	Heating Input BTUH	Heating Cap BTUH	AFUE	Piping Connections: Supply, Return, Gas	Flue Diameter	W x D x H	Ship Wt
15068	PSB-4D	112,500	91,000	82.7%	2-1/2", 1-1/4", 1/2"	6"	14-1/2" x 26-1/2" x 36-3/8"	368 lbs
15166	PSB-5D	150,000	122,000	82.0%	2-1/2", 2-1/2", 1/2"	6"	17-3/4" x 26-1/2" x 36-3/8"	440 lbs
15266	PSB-6D	187,000	153,000	82.0%	2-1/2", 2-1/2", 3/4"	7"	21" x 26-1/2" x 36-3/8"	512 lbs
15383	PSB-7D	225,000	183,000	82.0%	2-1/2", 2-1/2", 3/4"	7"	24-1/4" x 26-1/2" x 36-3/8"	584 lbs
15510	PSB-8D	262,000	214,000	82.0%	2-1/2", 2-1/2", 3/4"	7"	27-1/2" x 26-1/2" x 36-3/8"	659 lbs
15611	PSB-9D	299,000	245,000	82.0%	2-1/2", 1-1/4", 3/4"	7"	30-3/4" x 26-1/2" x 36-3/8"	736 lbs

Boilers

Dunkirk D249 - Commercial, Gas-Fired, Floor Standing, Gravity Vented, Knocked Down, Steam Boiler

- Control features: pressure high limit control
- Included with boiler:
 - Pre-assembled boiler base with burner manifold, burner orifices, gas valve, electron ignition
 - Complete jacket assembly
 - Plug and play harness and junction box
 - Glass water level gauge
 - Drain valve
 - Relief valve
- Cast iron heat exchanger
- Warranty:
 - Parts: 1-year limited
 - Heat exchanger: 10-year limited



D249-S (Boiler Includes Low Water Cut-Off)

Part #	Model #	Heating Input BTUH	Gross Output BTUH	Thermal Efficiency	Chimney Size ID x Ht	Jacket Width	Ship Wt
144674	D249-300S	300,000	233,000	77.0%	8" x 20'	20-3/4"	922 lbs
144679	D249-400S	400,000	310,000	77.0%	10" x 20'	25"	1,133 lbs
144680	D249-500S	500,000	388,000	77.0%	12" x 20'	29-1/4"	1,344 lbs
144682	D249-600S	600,000	465,000	77.0%	12" x 20'	33-1/2"	1,555 lbs
144685	D249-700S	700,000	543,000	77.0%	12" x 20'	37-3/4"	1,766 lbs
144688	D249-800S	800,000	620,000	77.0%	14" x 20'	42"	1,977 lbs

D249-SL (Boiler Does Not Include Low Water Cut-Off)

Part #	Model #	Heating Input BTUH	Gross Output BTUH	Thermal Efficiency	Chimney Size ID x Ht	Jacket Width	Ship Wt
144675	D249-300SL	300,000	233,000	77.0%	8" x 20'	20-3/4"	922 lbs
144678	D249-400SL	400,000	310,000	77.0%	10" x 20'	25"	1,133 lbs
144681	D249-500SL	500,000	388,000	77.0%	12" x 20'	29-1/4"	1,344 lbs
144684	D249-600SL	600,000	465,000	77.0%	12" x 20'	33-1/2"	1,555 lbs
144687	D249-700SL	700,000	543,000	77.0%	12" x 20'	37-3/4"	1,766 lbs
144689	D249-800SL	800,000	620,000	77.0%	14" x 20'	42"	1,977 lbs
144659	D249-1000SL	1,000,000	775,000	77.0%	14" x 20'	50"	2,399 lbs
144663	D249-1200SL	1,200,000	930,000	77.0%	16" x 20'	59"	2,821 lbs

Boilers

Prestige ACVMAX

Gas-Fired, Wall Hung, Modulating, Condensing, Water Boiler

- Control features:
 - Low water cut-off
 - 60 Second boiler set up
 - Outdoor reset
 - Warm weather shutdown
 - Integrated cascade control joins up to 6 boilers
 - Controls up to 4 circulators
 - Domestic hot water priority
- Included with boiler:
 - Wall mounting bracket
 - 3/4" Drain valve
 - ASME Relief valve
 - Automatic air vent
 - Outdoor temperature sensor
 - LP Kit (all models except Solo110)
- Stainless steel heat exchanger
- Warranty:
 - Parts: 1-year limited
 - Control and blower: 2-year limited
 - Heat exchanger: 10-year non-prorated



Part #	Model #	Heating Input BTUH Min/Max	Heating Cap BTUH	AFUE	Piping Connections Supply, Return, Gas	Combustion Air & Vent Pipe Eq Length (Sch 40 PVC, CPVC, Polypropylene)			Ship Wt	
172596	PA-80	16,000/80,000	74,000	95.0%	1", 1", 1/2"	Max	55'	100'	100'	103 lbs
175351	PA-110	20,000/110,000	102,000	95.0%	1", 1", 1/2"	Max	45'	100'	100'	103 lbs
172597	PA-155	27,800/153,000	142,000	95.0%	1-1/4", 1-1/4", 3/4"	Max	x	100'	100'	118 lbs
175352	PA-175	39,000/170,000	157,000	95.0%	1-1/4", 1-1/4", 3/4"	Max	x	100'	100'	128 lbs
175356	PA-250	43,600/240,000	222,000	95.0%	1-1/4", 1-1/4", 3/4"	Max	x	60'	80'	140 lbs
172598	PA-299	72,500/299,000	278,000	95.0%	1-1/2", 1-1/2", 1"	Max	x	x	100'	210 lbs
175360	PA-399	72,500/399,000	379,000	95.1%	1-1/2", 1-1/2", 1"	Max	x	x	100'	216 lbs

Challenger Solo

Gas-Fired, Wall Hung, Modulating, Condensing, Water Boiler and Combination Water Heater

- Control features:
 - Advanced Modulating Temperature Control
 - Outdoor reset
 - Low Water Protection
 - Freeze Protection
 - 3 DHW Modes
 - DHW Priority
 - DHW thermostatic mixing valve
- Cast Aluminum Heat Exchanger
- Warranty:
 - Parts: 1-year limited
 - Heat Exchanger: 10 Year Non-Prorated
- Included with boiler:
 - Time Saving Primary Secondary Manifold
 - Wall Mounting Bracket
 - 3/4" Drain Valve
 - ASME Relief Valve
 - Automatic Air Vent
 - Outdoor Temperature Sensor



Part #	Model #	Heating Input BTUH Min/Max	Heating Cap BTUH	Domestic Hot Water Output @ 70° Rise	AFUE	Piping Connections Supply, Return, Gas, DHW	Ship Wt
75945	CC-125H	20,000 / 125,000	111,000	3.0 GPM	97%	1", 1", 1/2", 3/4"	80 lbs

Boilers

JVS

Gas-Fired, Floor Standing, Gravity Vented, Water Boiler

- Control features:
 - Outdoor reset control
 - Warm weather shutdown
 - Domestic water priority
 - Spark ignition
 - Two stage low/high firing JVS100N, JVS125N, JVS160N, JVS225N
 - Pump relay
- Included with boiler: built-in draft diverter and automatic vent damper
- Copper heat exchanger with cast iron wet walls
- Warranty:
 - Parts: 1-year limited
 - Heat exchanger: 20-year prorated limited



Part #	Model #	Heating Input BTUH	Heating Cap BTUH	AFUE	Flue Diameter	Piping Connections Supply, Return, Gas	W x D x H	Ship Wt
44449	JVS50N	50,000	42,500	85.0%	4"	1-1/4", 1-1/4", 1/2"	13-3/8" x 26-1/2" x 21-3/4"	120 lbs
44450	JVS75N	75,000	63,800	85.0%	5"	1-1/4", 1-1/4", 1/2"	13-3/8" x 27-1/2" x 21-3/4"	126 lbs
44451	JVS100N	100,000	85,000	85.0%	5"	1-1/4", 1-1/4", 1/2"	16-7/8" x 27-1/2" x 22-3/4"	134 lbs
44452	JVS125N	125,000	106,000	85.0%	6"	1-1/4", 1-1/4", 1/2"	16-7/8" x 27-1/2" x 22-3/4"	138 lbs
44453	JVS160N	160,000	136,000	85.0%	6"	1-1/4", 1-1/4", 1/2"	20-3/8" x 27-1/2" x 22-3/4"	164 lbs
44454	JVS225N	225,000	191,000	85.0%	7"	1-1/4", 1-1/4", 3/4"	20-5/8" x 27-1/2" x 22-3/4"	181 lbs

Brazed Plate Heat Exchanger

- Maximum working pressure: 150 psig
- Stainless steel plates, with 99.9% copper and brazed, ensuring a high resistance to corrosion
- Self cleaning and self descaling



Part #	Model #	Connections	Dimensions H x W x D	Ship Wt
13950	TTP1-14E	3/4" NPT 7/8 SWT	8" x 3.3" x 1.6"	3 lbs

Prestige Boiler Parts

Adapter Kit

Part #	Model #	Description	For Model(s):
67003	PSRKIT27	Vent Outlet Adapter Kit	SOLO 175 and SOLO 250

Boilers

Navien NHB

Gas-Fired, Wall Hung, Modulating, Condensing, Water Boiler

- Control features:
 - Pressure LWCO with manual reset
 - Up to 15:1 turn down ratio
 - Outdoor reset
 - Warm weather shutdown
 - Domestic hot water priority
 - Freeze protection
- Included with boiler:
 - Wall mounting bracket
 - Outdoor reset sensor
 - LP Kit conversion
 - High voltage terminal strip with 120V contacts for pumps controls
- Dual Stainless Steel Heat Exchangers
- Warranty:
 - Parts: 5-year residential, 3-year commercial
 - Labor: 1-year residential, 1-year commercial
 - Heat exchanger: 15-year residential, 10-year commercial



Part #	Model #	Heating		AFUE	Piping Connections Supply, Return, Gas	Combustion Air & Vent Pipe Eq Length (Sch 40 PVC, CPVC, Polypropylene)			Ship Wt
		Input BTUH Min/Max	Cap BTUH			2"	3"		
142157	NHB-55	8,000/55,000	51,000	95%	1", 1", 3/4"	Max	60'	150'	73 lbs
142158	NHB-80	8,000/80,000	74,000	95%	1", 1", 3/4"	Max	60'	150'	73 lbs
142159	NHB-110	10,000/110,000	102,000	95%	1", 1", 3/4"	Max	60'	150'	80 lbs
142160	NHB-150	10,000/150,000	138,000	95%	1", 1", 3/4"	Max	60'	150'	80 lbs

Navien NCB-E

Gas-Fired, Wall Hung, Modulating, Condensing, Combination Water Boiler and Water Heater

- Control features:
- Turn down ratio of 6:1 for heating, 11:1 for DHW
 - Domestic hot water priority
- Included with boiler:
 - Wall mounting bracket
 - LP Kit conversion
 - Dual Stainless Steel Heat Exchangers
 - Warranty:
 - Parts: 5-year residential
 - Labor: 1-year residential
 - Heat exchanger: 10-year



Part #	Model #	Heating		Domestic Hot Water Output @ 77° Rise	AFUE	Piping Connections Supply, Return, Gas	Combustion Air & Vent Pipe Eq Length (Sch 40 PVC, CPVC, Polypropylene)			Ship Wt
		Input BTUH Min/Max	Cap BTUH				2"	3"		
176969	NCB-180E	14,000/80,000	75,000	3.4 gpm	95.0%	1", 1", 3/4"	Max	60'	150'	74 lbs
176970	NCB-210E	18,000/100,000	94,000	4.0 gpm	95.0%	1", 1", 3/4"	Max	60'	150'	84 lbs
176971	NCB-240E	18,000/120,000	112,000	4.5 gpm	95.0%	1", 1", 3/4"	Max	60'	150'	84 lbs

Boilers

Pennco 15B

Gas-Fired, Floor Standing, Gravity Vented, Water Boiler

- Control features:
 - Integrated high limit control
 - Vent damper control
 - Electronic ignition
- Included with boiler:
 - Automatic vent damper
 - Low profile draft hood
 - Drain valve
 - ASME Relief valve
- Cast iron heat exchanger
- Warranty:
 - Parts: 1-year limited
 - Heat exchanger: 20-year non-prorated limited



Part #	Model #	Heating Input BTUH	Heating Cap BTUH	AFUE	Piping Connections Supply, Return, Gas	Flue Diameter	W x D x H
192061	15B045FE	45,000	37000	82.0%	1-1/4", 1-1/4", 1/2"	4"	11-1/4" x 27-1/8" x 36-5/16"
192062	15B070FE	70,000	57000	82.0%	1-1/4", 1-1/4", 1/2"	5"	15-1/8" x 28-1/8" x 36-5/16"
192063	15B096FE	96,000	79000	82.0%	1-1/4", 1-1/4", 1/2"	5"	15-1/8" x 28-1/8" x 36-5/16"
192064	15B120FE	120,000	98000	82.0%	1-1/4", 1-1/4", 1/2"	6"	19" x 29-1/8" x 36-5/16"
192065	15B145FE	145,000	119000	82.0%	1-1/4", 1-1/4", 1/2"	6"	19" x 29-1/8" x 36-5/16"
192066	15B170FE	170,000	140000	82.0%	1-1/4", 1-1/4", 1/2"	7"	22-7/8" x 30-1/8" x 36-5/16"
192067	15B195FE	195,000	160000	82.0%	1-1/4", 1-1/4", 1/2"	7"	22-7/8" x 30-1/8" x 36-5/16"
192068	15B245FE	245,000	201000	82.0%	1-1/4", 1-1/4", 3/4"	8"	26-3/4" x 31-1/8" x 36-5/16"
192069	15B295FE	295,000	242000	82.0%	1-1/4", 1-1/4", 3/4"	9"	30-5/8" x 32-1/8" x 36-5/16"



A MUNCH'S SUPPLY COMPANY

**Let us be your
 source for quality
 products from
 leading manufacturers.**

Indirect Water Heaters

Laars-Stor2™ Double-Wall Indirect Water Heaters

- "Double Wall" heat exchanger
 - Double wall 1-1/2" OD glass coated steel coil has a positive leak path, the boiler water will stay separate from the potable water
 - Meets city of Chicago code for "Double wall"
- Glass lined tank construction
 - The domestic storage tank is protected from the corrosive effects of the hot water by an exclusive ceramic porcelain-like coating
- Factory installed sediment reduction system
 - Cold water inlet sediment reducing device helps to prevent sediment build-up in the tank
- Fully automatic controls
 - Fast acting surface mount
 - Thermostat for automatic temp control
- Includes brass tip and drain valve
- Lifetime residential limited warranty



Part #	Model #	Tank Capacity	Jacket Dia	Heater Height	First Hour Rating @ 135° F	Domestic Inlet/Outlet	Approx Ship Wt
69042	LS-DW-2-50-L-464	48 gal	22"	46-1/4"	133 gph	3/4"	180 lbs
64336	LS-DW-2-65-L-464	64 gal	22"	59"	148 gph	3/4"	196 lbs
58223	LS-DW-2-80-L	75 gal	24"	59"	158 gph	3/4"	224 lbs

Triangle Smart Indirect Water Heaters "Tank-In-Tank"

- "Tank in Tank" technology
 - The inner stainless steel tank is surrounded by the boiler water in the outer steel tank resulting in a full "wrap around" heat exchanger. This gives 1.5 to 2.5 more heat exchanger surface that produces more hot water.
- Stainless steel tank construction
 - The inner domestic storage tank is constructed of durable, corrosion resistant stainless steel
- Self cleaning / self-descaling
 - The inner, domestic tank is designed to prevent line build up on the heat exchanger; thus maintaining its performance
- Limited residential lifetime warranty



Smart Series Indirect-Fired Water Heater

Part #	Model #	Tank Cap	Dimensions H x Dia	First Hour Ratings @ 140°F	Domestic Inlet/Outlet	Ship Wt
36913	SMART-40	36 gal	46" x 22"	180 gph	3/4"	135 lbs
40207	SMART-50	46 gal	57" x 22"	220 gph	3/4"	165 lbs
36914	SMART-60	56 gal	66" x 22"	410 gph	3/4"	190 lbs
36915	SMART-80	70 gal	61" x 26"	460 gph	1-1/2"	271 lbs
41599	SMART-100	95 gal	78" x 26"	525 gph	1-1/2"	362 lbs
50169	SMART-120	119 gal	72" x 32"	650 gph	1-1/2"	479 lbs

Circulator Pumps

Hydronics

Grundfos Circulator Pumps Grundfos Alpha2

- Simple push button
- Control enables the ALPHA2 to be programmed in one of 3-constant speed,
- 3-constant pressure, or AUTOADAPT control modes. The current operating mode is always visible on the ALPHA2's LED display
- The large LED display shows the current energy consumption in Watts and estimated flow in gallons per minute
- ALPHA2 can be used as a replacement for more than 30 competitor pump models

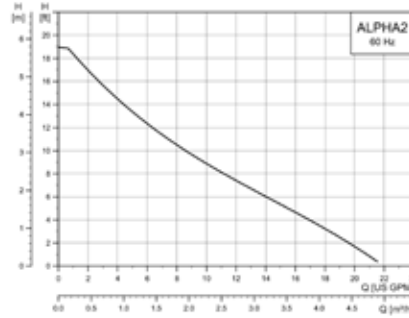

Part #	Model #	Description	Speeds	Flange Style	Body	Face to Face Dim	Volts	Max GPM	Max TDH
190604	15-55F	Grundfos Alpha2 Energy Efficient Circulator	Var	Standard	Cast Iron	6-1/2"	115	21	19

Grundfos Circulator with Check Valve

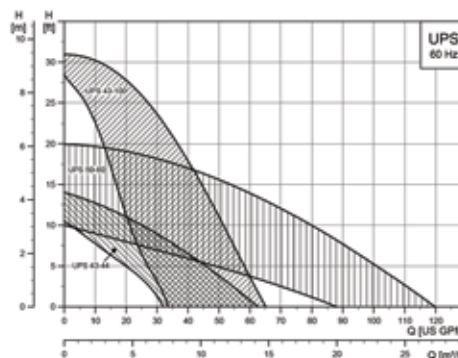
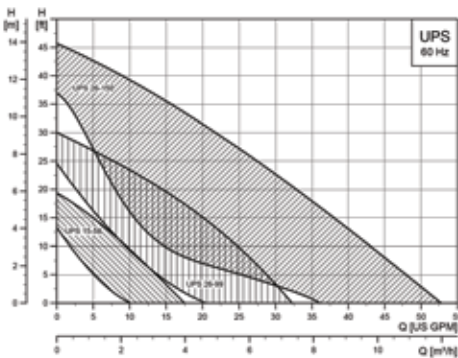

Part #	Model #	Description	Speeds	Flange Style	Body	Face to Face Dim	Volts	Max GPM	Max TDH
35832	UPS15-58 FC	Grundfos Circulator w/ Check Valve	3	Standard	Cast Iron	6-1/2"	115	17	19.5
48834	UPS26-99FC	Grundfos Circulator w/ Check Valve	3	Standard	Cast Iron	6-1/2"	115	33	29
48827	UPS43-44FC	Grundfos Circulator w/ Check Valve	3	2 Bolt HV	Cast Iron	8-1/2"	115	63	14
81190	UPS43-100F	Grundfos Circulator	3	2 Bolt HV	Cast Iron	8-1/2"	115	53	22

Grundfos Circulator

- 1.7 Amps
- Built-in motor protection for longer life and better performance
- Whisper-quiet operation for sound sensitive installations

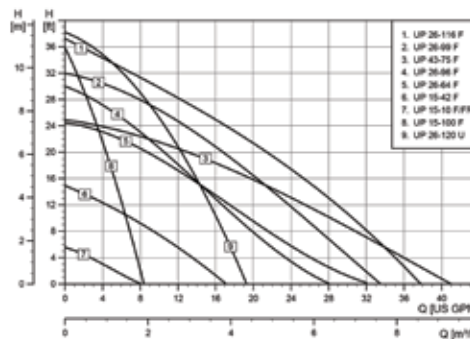

UP26-64F



UP43-75F

Part #	Model #	Description	Speeds	Flange Style	Body	Face to Face Dim	Volts	Max GPM	Max TDH
15	UP26-64F	Grundfos Circulator	1	Standard	Cast Iron	6-1/2"	115	32	24.5
10949	UP43-75F	Grundfos Circulator	1	2 Bolt HV	Cast Iron	8-1/2"	115	41	25

Models and Specifications are Subject to Change Without Notice

Circulator Pumps

Bell & Gossett Circulator Pumps

B&G Series

- Designed for use in domestic and light commercial water circulating systems
- Overcomes system-related noise caused by valves, fittings, or piping

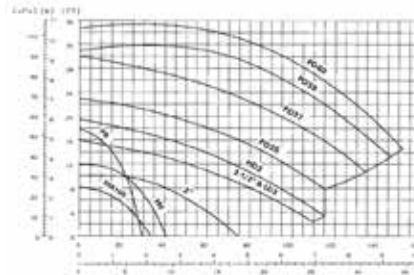

HV-NFI



PD

Part #	Model #	Description	Speeds	Flange Style	Body	Face to Face Dim	Volts	Max GPM	Max TDH
1015	100NFI	B&G Series 100 Pump	1	Standard	Cast Iron	6-3/8"	115	32	7
1386	HV NFI	B&G HV Series Circulator	1	2 Bolt HV	Cast Iron	8-1/2"	115	40	12
1422	2" NFI	B&G 2 Circulator	1	2" 4 Bolt	Cast Iron	8-1/2"	115	50	30

B&G Circulator

- High starting torque for dependable seasonal start-ups
- Closed impeller design improves operating efficiency
- 3-year warranty

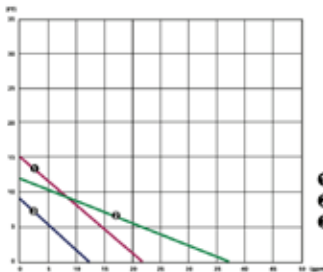

① NRF-22
② NRF-33
③ NRF-9F/LW

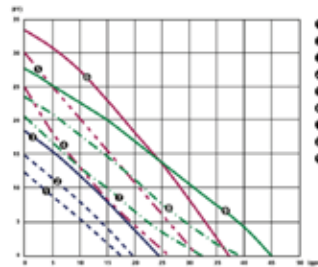

④ NRF-25 Speed 1
⑤ NRF-25 Speed 2
⑥ NRF-25 Speed 3
⑦ NRF-36 Speed 1
⑧ NRF-36 Speed 2
⑨ NRF-36 Speed 3
⑩ NRF-45 Speed 1
⑪ NRF-45 Speed 2
⑫ NRF-45 Speed 3



NRF-22



NRF-33

Part #	Model #	Description	Speeds	Flange Style	Body	Face to Face Dim	Volts	Max GPM	Max TDH
11014	NRF-22	B&G Circulator	1	Standard	Cast Iron	6-3/8"	115	22	15
26157	NRF-33	B&G Circulator	1	Standard	Cast Iron	6-3/8"	115	37	12
57524	NRF-25	B&G Circulator	3	Standard	Cast Iron	6-3/8"	115	24	19

B&G PL Series Circulator

- Precision-machined and balanced alloy steel rotor for superior performance
- XL-11™ Precision-Crafted Bearing System
- Permanently oil lubricated
- Double sided stainless steel neck ring for optimum efficiency

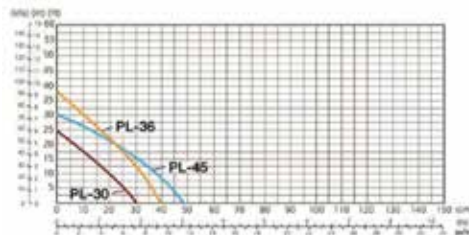

Part #	Model #	Description	Speeds	Flange Style	Body	Face to Face Dim	Volts	Max GPM	Max TDH
7652	PL-30	B&G PL-30 Circulator	1	Standard	Cast Iron	6-3/8"	115	70	18
20901	PL-36	B&G PL-36 Circulator	1	Standard	Cast Iron	6-3/8"	115	40	40
20318	PL-45	B&G PL-45 Circulator	1	Standard	Cast Iron	8-1/2"	115	50	30

Circulator Pumps

Wilo Energy Efficient Circulator Pump

- Energy efficiency class A
- Up to 80% power savings in comparison with uncontrolled circulators
- Highest efficiency thanks to ECM technology
- 3 x higher starting torque than conventional circulation pumps
- Electrical quick connection with spring clips 6-1/2" flange to flange dimension matches common models
- Pump equipped with rotating flanges for easy adaptation for all flanged types
- (F and FX types)
- High temperature check valve included for installation where required



Part #	Model #	Description	Speeds	Flange Style	Body	Face to Face Dim	Volts	Max GPM	Max TDH
77306	4145539	Wilo ECO 16FX Energy Efficient Circulator w/ Rotating Flange & Check Valve	Var	Standard	Cast Iron	6-3/8"	115	14	16

Wilo Star S Circulator Pump

- Rotating flange and installable check valve included on 'RFC' model
- Reliable wet rotor technology
- Quick connect wiring
- Powerful starting torque
- Ultra quiet
- Installable hi-temp check



Part #	Model #	Description	Speeds	Flange Style	Body	Face to Face Dim	Volts	Max GPM	Max TDH
57565	4090765	Wilo Star S 21 FX Circulator	3	Standard	Cast Iron	6-3/8"	115	19	21
159808	4190420	Wilo Star S 33 FC Circulator	3	Standard	Cast Iron	6-3/8"	115	26	30

Wilo Top S Circulator Pump

- Quiet low-maintenance wet rotor circulator
- Two speed, ultra-quiet operation
- Automatically vented
- Cataphoresis coating prevents corrosion
- 1/4" Suction and discharge pressure gauge tappings
- Sturdy cast aluminum electrical box
- Short flange to flange dimension
- Heads up to 71'
- Flows up to 290 USGPM
- 1.5 x 50
- Available in 1- 115/230V and 3- 208-230, 460, 575V
- Widest commercial wet rotor line in the industry!



Part #	Model #	Description	Speeds	Flange Style	Body	Face to Face Dim	Volts	Max GPM	Max TDH
57568	2067540	Wilo Top S 1.25 x 15 Circulator Pump	2	2 Bolt HV	Cast Iron	6-1/2"	115	27	18.4
57569	2067542	Wilo Top S 1.25 x 25 Circulator Pump	1	2 Bolt HV	Cast Iron	6-1/2"	115	35	27.2
57570	2067544	Wilo Top S 1.25 x 35 Circulator Pump	1	2 Bolt HV	Cast Iron	8-1/2"	115	48	32.6

Models and Specifications are Subject to Change Without Notice

Circulator Pumps

Circulator Pumps

- 3/4", 1", 1-1/4" or 1-1/2"
- 0 to 10' Discharge Head
- 1/2 HP
- 115 VAC at 60 Hz 0.74 A 1-Phase
- 0 to 23 GPM, 3250 RPM
- 125 PSI
- Lead-Free
- 1-Stage



Part #	Model #	Description	Speeds	Flange Style	Body	Face to Face Dim	Volts	Max GPM	Max TDH
28240	TAC007-F5	Taco 007 Circulator	1	Standard	Cast Iron	6-3/8"	115	23	10

Bronze Body Circulator Pumps

- 3/4", 1", 1-1/4" or 1-1/2"
- 0 to 15' Discharge Head
- 92 W
- 115 VAC at 60 Hz 1-Phase 0.8 A
- 0 to 22 GPM, 2940 RPM
- 150 PSI
- Lead-Free



Part #	Model #	Description	Speeds	Flange Style	Body	Face to Face Dim	Volts	Max GPM	Max TDH
20561	NBF-22	B&G Bronze Recirc Pump	1	Standard	Bronze	6-3/8"	115	22	15

Bronze Body Re-Circulator Pumps

- Easy installation
- Minimize water waste
- Lower energy consumption
- Learns and adapts to homeowner's water temperature needs



Part #	Model #	Description	Speeds	Flange Style	Body	Face to Face Dim	Volts	Max GPM	Max TDH
180834	UP10-16 PM A B5/LC	Comfort PM Auto Recirc Pump With Cord	1	1/2" SWT	Bronze		115	2.2	3.9
32646	UP15-10SU7P TLC	Comfort Hot Water Recirc Pump Kit		3/4" SWT	Bronze			6.5	6

Pump Flanges

Bell & Gossett Circular Pump Flange

- 3/4" NPT
- 150 PSI
- Chrome Plated Steel
- Companion



Part #	MFG	Size	Body	Flange Style	Includes
8824	B&G	3/4" FNPT Flange	Steel	Standard	1 Flange, 2 Bolts w/nuts
8836	B&G	1" FNPT Flange	Steel	Standard	1 Flange, 2 Bolts w/nuts
8846	B&G	1-1/4" FNPT Flange	Steel	Standard	1 Flange, 2 Bolts w/nuts
8859	B&G	1-1/2" FNPT Flange	Steel	Standard	1 Flange, 2 Bolts w/nuts

Grundfos Flange Kit

- 3/4" NPT
- Cast Iron



Part #	MFG	Size	Body	Flange Style	Includes
19501	Grundfos	3/4" FNPT Flange Kit	Cast Iron	Standard	2 Flanges, 2 Gaskets, 4 Bolts w/ Nuts
1398	Grundfos	1" FNPT Flange Kit	Cast Iron	Standard	2 Flanges, 2 Gaskets, 4 Bolts w/ Nuts

Taco Flange Kit



Part #	MFG	Size	Body	Flange Style	Includes
28243	Taco	3/4" FNPT Flange Kit	Cast Iron	Standard	2 Flanges, 4 Bolts w/ Nuts

Pump Flanges

Wilo Flange Kit

- 1-1/2" FPT
- Ductile Iron
- Bolt/Nut



Part #	MFG	Size	Body	Flange Style	Includes
68623	Wilo	1-1/2" FNPT Flange Kit	Cast Iron	Standard	2 Flanges, 2 Gaskets, 4 Bolts w/ Nuts

Part #	MFG	Size	Body	Flange Style	Includes
164497	Wilo	3/4" FNPT Flange Kit	Low Lead Brass	Standard	2 Flanges, 2 Gaskets, 4 Bolts w/ Nuts
175526	Wilo	1" FNPT Flange Kit	Low Lead Brass	Standard	2 Flanges, 2 Gaskets, 4 Bolts w/ Nuts
68634	Wilo	1-1/4" FNPT Flange Kit	Low Lead Brass	Standard	2 Flanges, 2 Gaskets, 4 Bolts w/ Nuts

Part #	MFG	Size	Body	Flange Style	Includes
57718	Wilo	HV 1-1/4" FNPT Flange Kit	Cast Iron	2 Bolt HV	2 Flanges, 2 Gaskets, 4 Bolts w/ Nuts
57719	Wilo	HV 1-1/2" FNPT Flange Kit	Cast Iron	2 Bolt HV	2 Flanges, 2 Gaskets, 4 Bolts w/ Nuts
20899	Grundfos	HV 1-1/2" FNPT Flange Kit	Cast Iron	2 Bolt HV	2 Flanges, 2 Gaskets, 4 Bolts w/ Nuts

Wilo Circulator Pump Flange with Check Valve



Part #	MFG	Size	Body	Flange Style	Includes
68625	Wilo	1" FNPT Flange Kit with Check Valve	Cast Iron	Standard	Kit Includes 1 flange with check valve, 1 Std Flange, 4 Bolts w/nuts, Two Gaskets
57720	Wilo	1-1/4" FNPT Flange Kit with Check Valve	Cast Iron	Standard	Kit Includes 1 flange with check valve, 1 Std Flange, 4 Bolts w/nuts, Two Gaskets
57721	Wilo	1-1/2" FNPT Flange Kit with Check Valve	Cast Iron	Standard	Kit Includes 1 flange with check valve, 1 Std Flange, 4 Bolts w/nuts, Two Gaskets

Part #	MFG	Size	Body	Flange Style	Includes
68631	Wilo	1-1/4" FNPT Isolation Flange with Check Valve Kit	Low Lead Brass	2 Bolt HV	2- Rotating Flanges with Ball Valves, 1 Check Valve, 4 Bolts w/nuts, 2 Gaskets
68185	Wilo	1-1/2" FNPT Isolation Flange with Check Valve Kit	Low Lead Brass	2 Bolt HV	2- Rotating Flanges with Ball Valves, 1 Check Valve, 4 Bolts w/nuts, 2 Gaskets

Pump Flanges

Wilco Circulator Pump Flange with Isolation Valve & Check



Part #	MFG	Size	Body	Flange Style	Includes
68628	Wilco	3/4" SWT Isolation Flange with Check Valve Kit	Low Lead Brass	Standard	2- Rotating Flanges with Ball Valves, 1 Check Valve, 4 Bolts w/nuts, 2 Gaskets
68629	Wilco	1" SWT Isolation Flange with Check Valve Kit	Low Lead Brass	Standard	2- Rotating Flanges with Ball Valves, 1 Check Valve, 4 Bolts w/nuts, 2 Gaskets
66315	Wilco	1-1/4" SWT Isolation Flange with Check Valve Kit	Low Lead Brass	Standard	2- Rotating Flanges with Ball Valves, 1 Check Valve, 4 Bolts w/nuts, 2 Gaskets
68630	Wilco	3/4" SWT Isolation Flange with Check Valve Kit	Low Lead Brass	Standard	2- Rotating Flanges with Ball Valves, 1 Check Valve, 4 Bolts w/nuts, 2 Gaskets

Part #	MFG	Size	Body	Flange Style	Includes
68626	Wilco	3/4" FNPT Isolation Flange with Check Valve Kit	Low Lead Brass	Standard	2- Rotating Flanges with Ball Valves, 1 Check Valve, 4 Bolts w/nuts, 2 Gaskets
68627	Wilco	1" FNPT Isolation Flange with Check Valve Kit	Low Lead Brass	Standard	2- Rotating Flanges with Ball Valves, 1 Check Valve, 4 Bolts w/nuts, 2 Gaskets
68166	Wilco	1-1/4" FNPT Isolation Flange with Check Valve Kit	Low Lead Brass	Standard	2- Rotating Flanges with Ball Valves, 1 Check Valve, 4 Bolts w/nuts, 2 Gaskets
68165	Wilco	1-1/2" FNPT Isolation Flange with Check Valve Kit	Low Lead Brass	Standard	2- Rotating Flanges with Ball Valves, 1 Check Valve, 4 Bolts w/nuts, 2 Gaskets

Wilco Circulator Pump Flange with Isolation Valve, Purge & Check

Part #	MFG	Size	Body	Flange Style	Includes
144017	Wilco	1-1/2" SWT Iso Flange with Purge & Check Valve Kit	Low Lead Brass	Standard	1- Rotating Flanges with Ball Valves, 1 Check Valve, 2 Bolts w/nuts, 1 Gaskets

Circulator Pump Flange Gaskets

Part #	MFG	Size	Body	Flange Style
15379	Grundfos	Flange Gasket	Cast Iron	Standard
63571	Taco	Flange Gasket	Cast Iron	Standard
1953	B&G	Flange Gasket	Cast Iron	Standard

Part #	MFG	Size	Body	Flange Style
69662	Wilco	Gasket for 1-1/4" & 1-1/2" HV Ball Valves	Cast Iron	2 Bolt HV
1998	B&G	Gasket for 1-1/2" HV Flange	Cast Iron	2 Bolt HV

Models and Specifications are Subject to Change Without Notice

B&G Pumps & Parts

Pump Motors & Accessories

Bearing Assembly

- Lead-free



118844



186863

Part #	Model #	For Models:
6310	118844LF	100 Series NFI, BI
2978	186863LF	PD-35, PD-37, 60 "AA", 1522; IB, BF or AB
5182	189105LF	PR, 2-1/2", LD-3, HD-3
23769	189163LF	Obsolete 1-1/2", Obsolete 2", Obsolete HV
23770	189165LF	HV, 2", 1-1/2" Obsolete IB or BI

Body Gasket

- 3/8" OD



Part #	Model #	For Models:
9775	P04080	100 Series

Impeller

- Lead-free



189132

Part #	Model #	For Models:	For Models:
5453	189132LF	2-3/4" NFI	Series 100
5423	189128LF	3-3/8" NFI	HV, NFI

Motor Coupler



118473



118705



189110

Part #	Model #	For Models:
2832	118473	PD-35, PD-37, 60 "AA", 1522 (1/2" HSAft Frame)
5037	118705	100 Series, HV, 2", PD
23986	118723	2-1/2", LD-3, HD-3, Obsolete HLD-3, Obsolete HHD-3
5224	189110	1/12 hp and 1/6 hp Pumps

B&G Pumps & Parts

Power Pack Motor

- 115V
- 1725 RPM
- Quiet, dependable service



111034



111031

Part #	Model #	Phase	HP	For Models:
8609	111034	Single	1/12 hp	Series 100
8572	111031	Single	1/6 hp	HV

Ring Motor Mounting Set



Part #	Model #	For Models:
688	118223	100 Series, 1", 1-1/4", 1-1/2", 2" HV, PR

Parts & Accessories



Part #	Model #	Description	For Models:
59	118153	Small Oil Tube	Series 100, HV, PD, PR



A MUNCH'S SUPPLY COMPANY

Let us be your source for quality products from leading manufacturers.

Air Elimination

Fittings

T-77 Coin Key Air Vent

- Pipe thread comply with ANSI B1.20.1
- Nickel Plated Brass Body
- Slotted & hexagon screws for adjustment
- Air pressure ratings: 0-125PSI
- Designed for manual venting on baseboards, radiators and high points in piping systems



Part #	Model #	Description
2586	CK-100	1/8" IPS
57529	110-340	Key For Coin Vent

Vent/Baseboard Tee (C x FPT x C)



Part #	Model #	Connections
8181	302-253	3/4" x 1/8" x 3/4"
10039	302-254	1" x 1/8" x 1"
26473	404-T	1-1/4" x 1/8"



Air Eliminators

Float-Type Automatic Air Vent

- Brass body with non-ferrous internals
- Maximum operating temperature: 240°F



Part #	Model #	Model	Connection	Max Pressure
35578	113222	97	1/8" NPT	150 psi



Air Vents

SV-12 Steam Radiator Air Vent

- Nickel plated brass body
- Polypropylene float
- Brass valve seat
- Stainless steel Bimetal Thermostatic Element



Part #	Model #	Conn	Type
14946	6005690	1/8"	Angle
14955	6005691	1/8"	Straight
14978	6005693	3/4" M x 1/2" F	Straight Main



Air Vents

5023 VALCAL® Extra High Capacity Automatic Air Vent (MPT)

- Brass body
- Maximum working temperature: 250°F
- Maximum working pressure: 150 psi
- Maximum discharge pressure: 60 psi



Part #	Model #	Connection
59118	502343A	1/2"

5027 Automatic Air Vent with Check Valve (MPT)

- Brass body
- Maximum working temperature: 240°F
- Maximum working pressure: 150 psi
- Maximum discharge pressure: 90 psi



Part #	Model #	Connection
56753	502710A	1/8"

Air Vent

- Cast iron with stainless steel, brass, and EPDM internal components
- Float valve
- Maximum operating temperature: 250°F
- Minimum operating temperature: 35°F
- Operating pressure: 150 psi



Part #	Model #	Size	Dimensions H x W x L
16677	700-C	1/8"	4" x 2" x 2"

5080 Automatic Hygroscopic Air Vent (MPT)

- Manual closed operation by unscrewing knob
- Maximum working pressure: 150 psi
- Maximum working temperature: 212°F



Part #	Model #	Connection
56333	508013A	1/8"

Air Elimination

Air Separators

551 DISCAL® Air Separator

- Brass body
- Maximum working pressure: 150 psi
- Working temperature: 250°F



Part #	Model #	Connection	Model
56325	551022A	3/4" SWT	Compact, SWT

Part #	Model #	Connection	Optimal Flow
56326	551028A	1" SWT	9.3 gpm
56327	551035A	1-1/4" SWT	15.3 gpm
78538	551041A	1-1/2" SWT	23.09 gpm
78537	551054A	2" SWT	36.1 gpm

Part #	Model #	Connection	Optimal Flow
56620	551005A	3/4" NPT	6 gpm
56622	551006A	1" NPT	9.3 gpm
56331	551007A	1-1/4" NPT	15.3 gpm
56330	551008A	1-1/2" NPT	23.09 gpm
56623	551009A	2" NPT	36.1 gpm

Hydro and Discal Air Separators

Hydro Separator

- Hydraulic separator
- Epoxy resin coated steel body
- 300 Series stainless steel internal baffle
- Pre-formed insulation



Part #	Model #	Connection	Optimal Flow
56601	548006A	1" Female NPT	11 GPM
56603	548007A	1-1/4" Female NPT	18 GPM
62418	548009A	2" Female NPT	11 GPM

Part #	Model #	Connection	Optimal Flow
56602	548006A	1" SWT	11 GPM
56604	548007A	1-1/4" SWT	18 GPM

5463 DIRTMAG® Dirt Separator

- Brass body
- Magnetic separator 1/2" NPT Top thread with plug for optional air vent
- Drain valve with hose connection
- Maximum temperature: 250°F
- Maximum working pressure: 150 psi



Part #	Model #	Connection	Optimal Flow
87662	546306A	1" NPT	9.3 gpm
89658	546307A	1-1/4" NPT	15.3 gpm
89525	546308A	1-1/2" NPT	23.09 gpm

Caleffi Parts

Part #	Model #	Description
85778	F39807	Cover & Float for Brass Discal



Air Elimination

Air Purger

- Cast iron
- Non-ASME
- Working pressure: 125 psi



Part #	Model #	Size	Dimensions H x W x L
14057	443	1"	4" x 2-1/2" x 6"
14071	444	1-1/4"	4" x 2-1/2" x 6"
14081	445	1-1/2"	5" x 3-1/2" x 8"
14094	446	2"	5" x 3-1/2" x 8"

Fill / Expansion

Webstone PRO-PAL® Series Expansion Valves

PRO-PAL® Ball Drain™ (Copper)

- Full port forged brass ball valve with hi-flow hose drain
- Reversible handle
- Adjustable packing gland
- Allows system to be isolated for purging and filling



Part #	Model #	Size
69180	50613	3/4"
64896	50614	1"
69182	50615	1-1/4"

Webstone PRO-PAL® Expansion Tank Pro Service Valve™ (FPT x MPT x FPT x Hose)

- Allows for filling and purging water boiler system
- Allows expansion tank to be isolated



Part #	Model #	Size
64895	41672	1/2"



Hydronic System Feeders

Pressure Pal MF200 Residential Mini Feeder

- For feeding and pressurizing closed hydronic systems that do not require cold static fill pressures higher than 25 psig
- Compatible with water and glycol/water solutions
- Power supply plugs into any standard 115VAC outlet



Part #	Model #	Capacity
29386	MF200	6 gal

Axiom MF200-S Solar Pal Mini System Feeder



Part #	Model #	Description
58642	MF200-S	Solar Pal Mini System Feeder



Gauge Glass Standard



Part #	Model #	Size	Max PSI
5345	H1-8	5/8" OD x 8"	210 - 100
6820	H1-10	5/8" OD x 10"	205 - 100
19203	H1-12	5/8" OD x 12"	200 - 100

Gauge Glass Washer

- Standard
- Neoprene, square cut
- 100/Pack



Part #	Model #	Size	Fits:
3497	H6-10	9/16" x 13/16" x 1/4"	5/8" OD Glass

Cutting Tools Glass Cutter

- Hardened and tempered alloy steel cutting wheels provide an easy clean cut

Part #	Model #	Description
13679	996	Gauge Glass Cutter

Fill-Trol® System Expansion Tank

- Eliminates the need for a separate automatic fill valve
- Tank pressure controls system fill
- Factory pre-charged: 12 psig
- Fully adjustable up to a maximum working pressure of 100 psig



Part #	Model #	Dia	Height	Volume
10959	109	8"	13"	2.0 gal
10970	110	11"	16"	4.4 gal
10982	111	11"	23"	7.6 gal

Parts & Accessories

Fill-Trol® Expansion Tank Valve

Part #	Model #	Description
11493	109-15	Fill-Trol® Valve

Fill / Expansion



Steel Expansion Tanks



Part #	Model #	Capacity	Size
16059	THR15	15 gal	12" x 30"
16156	THR24	24 gal	12" x 48"
16213	THR30	30 gal	12" x 60"

Airtrol® Tank Fittings

- Directs free air to the compression tank
- Restricts thermal circulation to boiler
- Establishes initial tank air level
- Allows compression tank size reduction
- Maximum design limitations: 175 psi @ 250°F



Part #	Model #	Tank Diameter	Tank Connection	Boiler Connection
22701	112010-ATF-12	12", 13", or 14"	1/2" NPTM	3/4" NPTM

Tank Drains

Part #	Model #	Description
14638	THR1	1/2"



Expansion Tanks

- 16 Gauge cold rolled painted steel tank
- Constructed of deep drawn welded steel domes
- Brass valve with o-ring seal
- Welded system connection
- Patented double diaphragm design constructed of 100% butyl rubber
- 5-Year limited warranty



Part #	Model #	Capacity	Mount	Connection
131204	HTX15	2.1 gal	Pipe	1/2" MPT
131205	HTX30	4.5 gal	Pipe	1/2" MPT
131206	HTX60	6 gal	Pipe	1/2" MPT
131207	HTX90	15 gal	Pipe	3/4" MPT
131208	SXHT30	15 gal	Floor	1" FPT
131209	SXHT40	20 gal	Floor	1" FPT
131210	SXHT60	33 gal	Floor	1" FPT

Backflow Preventers

Double Check Backflow Preventer with Intermediate Vacuum Breaker

- Ideal for boiler feed lines, livestock drinking fountains, trailer park water hook-ups, laboratory equipment and numerous other applications
- Suitable for either hot or cold water service
- Non-continuous backflow temperatures: up to 250°F
- Working supply pressures: up to 175 psi



Part #	Model #	Connection
48755	BP900	1/2" NPT

Fill / Expansion

Pressure Reducing Valves

- Fast fill feature
- Low inlet pressure check valve
- Convenient cleanable strainer
- Maximum operating temperature: 225°F
- Maximum operating pressure: 125 psi

Combination "Dual Units" Pressure Relief and Reducing Valve

- Relief valve pressure setting: 30 psi
- Reducing valve pressure setting: 12 psi



Part #	Model #	Model	Connection	Components Relief Plus
56550	110197	F-3	1/2" NPT	FB-38

Pressure Reducing Valve

- Factory pressure setting: 12 psi
- Pressure range: 10 to 25 psi



FB-38

B7-12

Part #	Model #	Model	Connection
829	110192LF	FB-38	1/2" NPT
877	110196	B7-12	3/4" NPT

Pressure Reducing Valve Strainer



Part #	Model #	For Models:
25979	118036	B-38, B-38TU, FB-38, FB-38TU and 6

Fill / Expansion

Hydronic Valves

573 Backflow Preventer & Auto-Fill Combination

- Adjustable automatic filling unit
- Maximum working temperature: 150°F
- Preset outlet pressure: 15 psi
- Maximum inlet pressure: 175 psi
- Setting pressure range: 3 to 60 psi



Part #	Model #	Description	Inlet	Outlet
190956	573012A	Caleffi Adj Auto Fill Valve & Backflow Preventer with Pressure Gauge (1/2" NPT)	1/2" NPT	1/2" NPT
56332	573009A	Caleffi Adj Auto Fill Valve & Backflow Preventer with Pressure Gauge (1/2" NPT)	1/2" SWT	1/2" NPT
90226	553542A	Caleffi Adj Auto Fill Valve (1/2" SWT)	1/2" SWT	1/2" SWT



A MUNCH'S SUPPLY COMPANY

**Let us be your
source for quality
products from
leading manufacturers.**

Relief Valves

The Isolator® E-X-P E2™ Tankless Water Heater Service Valve Kit (IPS Union)

- Tankless water heater valve kit with relief valve
- Allows for cleaning and service of tankless water heater
- Includes:
 - Relief valve (200,000 BTUH)
 - Hot and cold set of full port forged brass ball valves with hi-flow drains



Part #	Model #	Size	PSI	Conn
160226	54443WPR	3/4"	150	SWT
90714	44443WPR	3/4"	150	IPS
86876	44444WPR3	1"	30	IPS

The Isolator® E-X-P™ Tankless Water Heater Service Valve Accessories Residential Pressure Relief Valve

- Relief valve for tankless water heater
- 150 psi
- 200,000 BTUH



Part #	Model #	Size
89862	20713	3/4"



Pressure Relief Valves

Water Boiler Pressure Relief Valve (FPT)

- Stainless Steel Spring
- High heat resisting silicone disc
- Bronze seat



Part #	Model #	Model	Size	PSI
18529	342670	335	3/4" FDT	30 psi
17493	342671	M335M1	3/4" MPT	30 psi

ASME Steam Boiler Safety Valves

ASME Steam Safety Relief Valve

- For low pressure steam heating equipment
- Non-sticking Teflon® disc
- Seat located above drain
- Standard relief set pressure: 15 psi
- ASME Section IV



315 (MPT Inlet x FPT Outlet - Drain)

Part #	Model #	Model	Size	Discharge Cap @ 15 PSI
17128	342615	M315-M2	3/4" x 3/4"	375 lbs/hr



Safety Relief Valves ASME

- Bronze
- Protects fired and unfired hot water vessels against hazardous operating pressures
- Diaphragm assisted
- Fail-safe disc with sufficient area to permit valves to maintain function in the event of a diaphragm rupture
- Factory pressure setting: 50 psi
- Maximum operating temperature: 250°F
- Maximum working pressure: 125 psi
- Meets requirements of section IV of the ASME boiler and pressure vessel code



Part #	Model #	Model	Connection	Capacity BTUH
134594	110124	790-50	3/4" NPT	1,160,000
134595	110132	1170-50	1" NPT	1,710,000

Mixing Valves & Gauges



Hydronic Valves

521 3-Way Mixing Valve (Sweat)

- Dezincification resistant body with internal anti-scale materials
- Locking set point knob
- Adjustable range: 85° to 155°F
- Maximum inlet temperature: 200°F
- Maximum working pressure: 200 psi
- ASSE 1017 and NSF Approved



Part #	Model #	Connection	Cv	Note:
57468	521509A	3/4"	3	
85569	521519A	3/4"	3	w/Gauge
57469	521609A	1"	3	
132840	521619A	1"	3	w/Gauge

NA10056 Mixed Temperature Gauge

- Point of distribution mixed temperature gauge adapter for 521 series mixing valves
- Threaded union mounting
- Removable gauge fits into temperature well
- 2" Dial scales from 30° to 210°F



Part #	Model #	Description
56997	NA10056	3/4" SWT with Gauge

Westwood

Hydronic Gauges

Tridicator

- Range:
 - Temperature: 70° - 320°F (20° - 160°C)
 - Pressure: 0 - 75 psi (0 - 170 Ft H2O)
- CBM - Center back mount
- LM - Low mount base



Part #	Model #	Mount	Face	Shank	Ins
4455	H25	1/4" CBM	2-5/8"	1-3/4"	1"
5440	H25-1	1/4" CBM	2-5/8"	2"	1"
13655	H25-2	1/2" CBM	3-1/4"	1-1/4"	1"
13736	H25-3	1/2" LM	3-1/4"	1"	3/4"

Dial Thermometer

- Temperature range: 32° to 248°F
- CBM - Center back mount



Part #	Model #	Mount	Face	Shank	Ins
17051	H25-90	1/2" CBM	2-1/2"	3/4"	1-1/4"
16478	H25-92	3/4" CBM	2-1/2"	3/4"	2"

Bronze Heating & Radiator Valves

T-431 Angle Radiator Valve (FPT x MPT)

- 15 psi steam
- 60 psi water



Part #	Model #	Model	Connection(s)
32860	110-103	T-431	1/2"
8568	110-104	T-431	3/4"
1587	110-105	T-431	1"
9317	110-106	T-431	1-1/4"
9292	110-107	T-431	1-1/2"

T/S-437 Hot Water Angle Valve

- Constructed of heavy-duty bronze
- Screwed bonnet, rising stem, and bronze disc



Part #	Model #	Model	Connection(s)
6131	110-114	T-437	3/4" IPS
44687	110-124	S-437	3/4" SWT

T-438 Union Elbow (FPT)

- Heavy-duty bronze



Part #	Model	Connection(s)
51633	T-438	1/2"
38547	T-438	3/4"
35779	T-438	1"
38570	T-438	1-1/4"

S-438 Union Elbow (Swt)

- Heavy-duty bronze



Part #	Model	Connection(s)
44688	S-438	3/4"

Models and Specifications are Subject to Change Without Notice

Radiator Valves / Fittings / Flow Controls

S-439 Bronze Balancing Valve (Swt)

- Ball type with screwdriver slot 100% shut-off
- 400 CWP
- 150 WSP



Part #	Model	Connection(s)
9316	S-439	3/4"

Fittings

T-570 Mono-Flow Tee (Copper)



Part #	Model	Connection(s)
25273	T-570	1" x 1/2"
7239	T-570	1" x 3/4"
6658	T-570	1-1/4" x 1/2"



Radiator Valve Spud/Nipple Wrenches

- Heavy duty tool made from zinc



Part #	Model #	Size
69590	25011	1/2" - 2"



RA 2000 Valve Bodies

Straight (FPT x MPT)

- Regulates the flow of hot water
- Nickel plated



Part #	Model #	Size
63313	013G8015	1/2"
52363	013G8020	3/4"

Angle (FPT x MPT)



Part #	Model #	Size
51632	013G8019	3/4"

RA2000 Thermostatic Valve Operators Valve-Mount Dial & Remote Sensor

- Suitable for practically all types of radiator/convactor heating systems and installations.



Part #	Model #	Design	Capillary Tube
67849	013G8252	Standard	0 - 6'

Danfoss RA2000 Operators



Part #	Model #	Description
38530	013G8250	Valve Mounted Dial and Sensor
58105	013G8562	Wall Mounted Dial and Built-in Sensor



A MUNCH'S SUPPLY COMPANY

WE APPRECIATE YOUR BUSINESS!

Radiator Valves / Fittings / Flow Controls



Commercial Bronze Check Valves

601S Silent Spring Check Valve (Swt)

- Especially designed for well pump service and other applications requiring tight seating
- Bronze seat, Viton disc
- 400 psi WOG at -20° to 100°F



Part #	Model #	Model	Size
19104	376395	601S	3/4"



Hydronic Valves

519 Differential Pressure By-Pass Valve (NPT)

- Adjustable from 2 to 10 psi
- Maximum working temperature: 230°F
- Maximum working pressure: 150 psi



Part #	Model #	Inlet	Outlet
59617	519502A	3/4"	3/4"

Flo-Control™ Valves

- Cast iron
- Prevents gravity flow in forced water systems
- Permits summer-winter operation of indirect water heaters
- Straight-angle design
- Removable top cap
- Manual operating position for vertical lift disc to permit gravity circulation
- Maximum operating temperature: 250°F
- Maximum working pressure: 125 psi



Part #	Model #	Model	Size NPT
8825	107034	SA3/4	3/4" NPT
8664	107018	SA1	1" NPT
8678	107019	SA1-1/4	1-1/4" NPT
19665	107020	SA1-1/2	1-1/2" NPT



A MUNCH'S SUPPLY COMPANY

WE CARE WHO YOU ARE

Big business or small, you can expect the best service and quality products at competitive prices.

Zone Controls / Zone Valves

Z-One™ Zone Valves

- 2-Way zone valve
- Screw terminal connection
- Spring return
- Normally closed
- Z1 Actuator and Z2 valve body
- Temperature range: 32° to 240°F
- Maximum body pressure: 300 psi
- Power supply: 24VAC
- Power consumption: 6.5W, 7VA
- Rating of micro switch contacts: 5A
- UL and cUL Listed



Part #	Model #	Description	Cv	PSI
56323	Z55	3/4" SWT	7.5	20
56324	Z56	1" SWT	7.5	20
55985	Z57	1-1/4" SWT	7.5	20
64532	Z200537	3/4" SWT		
164891	Z200637	1" SWT		

Z1 Z-One™ Actuators

- Mounts on Z2 and Z3 series valve bodies
- Power consumption: 6.5W, 7VA
- 2-Position spring return normally closed
- UL and cUL Listed



Part #	Model #	Description	Cv	PSI
56635	Z151000	24V w/Microswitch Terminal Block		

*Includes (2) 3/4" sweat fittings

Caleffi Pump Control Panel

ZSR 2-One Relay

- Works with 24V T-Stats
- LED indicators
- Switches PRI pump on with call for heat



Part #	Model #	Description
140033	ZSR-103	Zone Pump Control
140034	ZSR-104	4 Zone Pump Control
140035	ZSR-106	6 Zone Pump Control

Caleffi Zone Valve Control Panel

ZVR 2-One Relay

Part #	Model #	Description
140036	ZVR-103	3 Zone Valve Control
140037	ZVR-104	4 Zone Valve Control
140038	ZVR-106	6 Zone Valve Control

Switching Relays

ARM Zone Pump Control

- Priority safety timer
- 5-Second time delay for boiler shut-off
- Electronic fuse - auto reset
- Relay diagnostic light
- Plug-in, add-on zone modules
- High relay load rating: 7.2 amp, 1/3 hp



Part #	Model #	Zones	Transformer Voltage
52391	ARM2P	2	120VAC, 60Hz, 20VA
52392	ARM3P	3	120VAC, 60Hz, 30VA
52393	ARM4P	4	120VAC, 60Hz, 30VA
52394	ARM6P	6	120VAC, 60Hz, 30VA

Add-On Zoning Modules for ARM Relay Control

- Relay switching 0.085
- Thermostat current SPST
- 1/3 hp Single-phase motor rating



Part #	Model #	Zones	Transformer Voltage
58232	AD-4	4	N/A

Zone Valve Controls

- Built-in priority zone
- Switchable priority improves versatility
- Internal isolated end switch
- Reliable double-sided printed circuit board
- Plug-in replacement priority relay
- LED Diagnostic lights for easy troubleshooting
- Clearly marked terminals with quick-connect screwless clamps
- Thermostat current SPST, 7.2A



Part #	Model #	Zones	Transformer Voltage
52395	AZ-4CP	4	120V, 60Hz, 40VA
63907	AZ-6CP	6	120V, 60Hz, 75VA

Zone Controls / Zone Valves

Hydronic Motorized Zone Valves

V8043 Low Voltage Normally Closed Zone Valve

- 2-Way on-off low voltage valves consist of an actuator and valve assembly for controlling the flow of hot water
- Manual opener (on all models, except straight-through, normally open valves) for valve operation on power failure; valve returns to automatic position when power is restored
- All models may be installed without disassembling the valve
- Compact construction for easy installation
- Complete powerhead may be removed or replaced without breaking plumbing line connections or draining the system
- Use this valve in closed loop hydronic systems that do not contain dissolved oxygen in system water, such as fresh water from frequent source of makeup water
- Valve designed for cycling (not constantly powered on) applications
- Fluid temperature range: 50° to 200°F (10° to 93°C)
- Maximum ambient temperature: 125°F
- UL Listed



Part #	Model #	Pipe Size	Capacity (Cv)	Max Close-Off Pressure	De-energized Position	Voltage	Electrical Connect	Manual Opener
4093	V8043F1036	3/4" Swt	3.5 Cv	20 psi	Normally Closed**	24V @ 50/60Hz	Term Blk	Yes
4229	V8043F1051	1" Swt	3.5 Cv	20 psi	Normally Closed**	24V @ 50/60Hz	Term Blk	Yes

**Auxiliary End Switch Normally Open SPST

Hydronic Control Accessories

Zone Valve Parts & Accessories



Part #	Model #	Description
18841	40003916-026	24VAC, 50/60Hz Replacement Head with End Switch for V8044E 2-Way, Spring Return to Close
118	40003916-048	24VAC, 50/60Hz Replacement Head for V8043F with End Switch 2-Way, Spring Return to Close

MZV Series Zone Valve Replacement Part

- Replacement part for MZR Series Zone Valves

Part #	Model #	Description
39519	MZV520-RP	Operator for MZV Zone Valves with End Switch

Zone Controls / Zone Valves

Zone Control Valves

Hydronic Zone Control

- Quiet operation
- Stainless steel
- Self-aligning barrel-type design
- Automatic recycling manual operator shows valve position at all times
- Built-in auxiliary contacts to control burner or circulator relay
- Screw terminal wiring panel
- Motor can be removed without draining system
- Maximum differential across valve: 15 psi
- Maximum water temperature: 240°F
- Maximum system pressure: 50 psi



3-Wire, 24V Valve with Screw Terminal Wiring Panel and Auxiliary Switch

Part #	Model #	Tubing Size	24VAC Thermostat Circuit Rating	Time Cycle Open/Close
10719	1311-102	3/4" ID	0.4A	45 Sec/45 Sec
10736	1311-103	1" ID	0.4A	45 Sec/45 Sec

2-Wire, 24V Valve with Screw Terminal Wiring Panel and Auxiliary Switch

Part #	Model #	Tubing Size	24VAC Thermostat Circuit Rating	Time Cycle Open/Close
3779	1361-102	3/4" ID	0.2A	45 Sec/60 Sec
3790	1361-103	1" ID	0.2A	45 Sec/60 Sec
3803	1361-104	1-1/4" ID	0.2A	45 Sec/60 Sec

Parts & Accessories

Motor Assembly



F19-0097

Part #	Model #	Description
2071	F19-0097	Zone Valve Motor Assemblies for 1311-102, 1311-103 & 1311-104
2126	F19-0104	Zone Valve Motor Assemblies for 1361-102, 1361-103 & 1361-104

Zone Controls / Zone Valves

Zone Valves

570 Gold Series 2-Way Zone Valve

- Pump head: 65' of water
- Maximum working pressure: 125 psi
- Temperature range: 40° to 240°F
- 0.9A, 24V, 60Hz



Part #	Model #	Connection Size	Normal Flow Range	Equivalent Feet of Pipe	CV
9277	571-2	3/4" Swt	4-1/2 - 6 gpm	20'	6.1
9286	572	1" Swt	6 - 10 gpm	60'	7

Power Unit for Zone Valves



Part #	Model #	Description
10138	555-050RP	Power Unit Assembly, Snap-Action Switch



A MUNCH'S SUPPLY COMPANY

We maintain well-stocked and conveniently located warehouses. Please visit us at the branch nearest you.

Hydronic Controls

Thermostats

518/519 Single-Stage Thermostat

- Not a safety (limit) control
- Air operation controls, adjustable heat cycles
- Error messages
- 24VAC Rated relay outputs
- Auto heating cycle
- Backlight
- Floor and air temperature display
- Freeze protection
- Outdoor and floor temperature display
- Direct replacement for 507/508
- 3-Year warranty



Part #	Model #	Description
129173	518	Single-Stage Heat Radiant Thermostat
129174	519	Single-Stage Heat Radiant Thermostat with Slab Sensor

521 2-Stage Thermostat

- Two-heat or heat-cool
- 7-Day programmable schedule
- Backlight
- Outdoor and floor temperature display
- Radiant floor heating
- 3-Year warranty



Part #	Model #	Description
143498	521	2-Stage Thermostat with Slab Sensor

256 Outdoor Reset Control

- Microprocessor-based (PID) control
- Regulates supply water temperature from a single boiler based on outdoor temperature
- Includes:
 - Warm weather shut down (WWSD)
 - Minimum boiler setting
 - Liquid crystal display (LCD)



Part #	Model #	Description
29437	256	1-Stage Boiler Control

261 Boiler Control 2-Stage & Setpoint

- Microprocessor-based (PID) 2-stage control
- Regulates supply water temperature from a single 2-stage or (2) single boilers based on either outdoor temperature or a set point demand
- Can stage and rotate two single fire boilers or stage a single Lo/Hi fire boiler
- Operates the system pump



Part #	Model #	Description
31364	261	2-Stage Boiler and Set point

274 Boiler Control

- Microprocessor PID control
- Not a safety (limit) control
- (1) tN4, 4-Stage boiler and DHW/set point control
- Indoor use only
- Operates up to (4) on/off boilers
- Can provide outdoor reset, domestic hot water and set point operation with priority



Part #	Model #	Description
56476	274	Boiler Control (1) tN4, 4-Stage Boiler and DHW/Set point

Hydronic Controls

Snow Melting Controls

Automatic Snow Melting Control

- Automatic snow/ice detection
- Warm weather cut-off
- Cold weather cut-off
- Accurate slab temperature control
- Slab outdoor reset



Part #	Model #	Description
19672	090	Snow/Ice Sensor 65' Cable
19673	091	Snow/Ice Sensor Socket with F090

665 Snow Detector & Melting Control

- When combined with snow/ice sensor 090 provides automatic snow/ice detection
- Uses pulse width modulation to operate an on/off injection valve, pump, boiler or contactor for electric cables



Part #	Model #	Description
41499	665	Snow Detector and Melting Control

Sensors



070



071



079

Part #	Model #	Description
30354	070	Outdoor Sensor
19499	071	Universal Sensor with 12" 2-Cond Wire
46823	079	Slab Sensor with SS Sleeve and 10' 2-Cond Zipcord

Control Accessories

- Allows certain Tekmar controls to be mounted to a 2 x 4 electrical box



Part #	Model #	Description
42696	007	Adapter Plate for RTU or Indoor Sensor



Low Water Cut-Offs

GuardDog® Series 752P Electronic Low Water Cut-Off for Hot Water Boilers

- For commercial or industrial applications
- Primary or secondary control on hot water boilers
- Secondary control (manual reset models only) on steam boilers (meets CSDI)
- Green power on indicating LED
- Red low water indicating LED
- Test button
- No lock out with loss of power if probe is in water
- Maximum water temperature: 250°F
- Maximum steam pressure: 15 psi
- Maximum water pressure: 160 psi
- 3-Year warranty



Part #	Model #	Model	Description
69163	176234	751PMT	24V w/Std Probe

Low Water Cut-Offs for Boilers

GuardDog® RB-24 Electronic with Auto Reset for Hot Water Boilers

- For residential applications
- Brass threads
- Compact size
- Maximum ambient temperature: 120°F
- Maximum water temperature: 250°F
- Maximum water pressure: 50 psi
- Includes 3' harness cable



Part #	Model #	Model	Description
57485	349056	RB-24E	24V

Hydronic Controls

Low Water Cut-Offs for Steam Boilers GuardDog® PSE-800-M Electronic Low Water Cut-Off for Steam Boilers

- For residential, commercial, and industrial applications
- Self-cleaning probe
- CSD-1 Code compliance
- No blow down of control required when mounted directly into boiler tapings
- Provision to add alarm
- Maximum ambient temperature: 120°F
- Maximum water temperature: 250°F
- Maximum water pressure: 160 psi



Part #	Model #	Model	Description
142389	153602	PSE-802-24	24V Reset w/Std Probe
141708	153602R	PSE-802-RX2-24	24V Reset w/Remote Probe

61 Float Type Low Water Cut Off for Steam Boilers

- For residential and commercial low pressure steam boiler applications
- For boilers of any steaming capacity
- Dual precision switches
- 1" NPT Equalizing pipes and blow down valve required
- Maximum steam pressure: 20 psi



Part #	Model #	Model	Description
35513	140100	61	120 or 240VAC

67 Mechanical Float Type Low Water Cut Off for Steam Boilers

- For residential and commercial applications
- For boilers of any steaming capacity
- Lever-operated, full port ball valve for easy blow down
- Dual precision switches
- Large float chamber
- Maximum steam pressure: 20 psi
- Includes quick hook-up fittings



Part #	Model #	Model	Description
16754	149400	67	120/240VAC
1310	149600	67-G	For Millivolt Service

Combination Water Feeder/Low Water Cut-Offs

47-2 Combination Mechanical Water Feeder/Low Water Cut-Off

- For steam and hot water boilers with cold water feed
- Continuous maintenance of minimum safe water level, independent of electrical service
- Proportional feed action
- Maximum inlet water temperature: 120°F
- Maximum water supply pressure: 150 psi
- Maximum boiler pressure: 25 psi
- Includes quick hook-up fittings



Part #	Model	Description
1232	47-2	Combo Feeder/LWCO

Electronic Water Feeders

WFE Uni-Match® Electronic Water Feeder

- Field adjustable dwell-feed cycles
- Multi-color LED status indicator
- Manual feed button
- Compatible with all electronic and mechanical low water cut-offs
- Hard-stop limit to avoid flooding the boiler
- Removable strainer (replace after cleaning)
- Maximum water temperature: 120°F
- Maximum water pressure: 150 psi
- Maximum boiler pressure: 15 psi
- Maximum ambient temperature: 100°F
- Includes adapters for connection to 1/2" copper tubing



Part #	Model	Description
59567	WFE-24	24V

101-A Electronic Water Feeder

- For low pressure steam boilers with cold water feed
- Can be used with mechanical or electronic low water cut-off controls
- Quick-change replaceable cartridge, valve, and strainer
- Manual feed button
- Maximum water temperature: 120°F
- Maximum water pressure: 150 psi
- Maximum boiler pressure: 25 psi



Part #	Model	Description
4553	101-A	Electric Water Feeder

Hydronic Controls

Liquid Level Controls

Replacement Probe Remote

- For steam and hot water boilers with cold water feed
- Continuous maintenance of minimum safe water level, independent of electrical service
- Proportional feed action
- Maximum inlet water temperature: 120°F
- Maximum water supply pressure: 150 psi
- Maximum boiler pressure: 25 psi
- Includes quick hook-up fittings



Model LCD Snow Switch[®]

- Melts snow only when necessary
- Detects precipitation as snow at temperatures below 38°F
- Internal, isolated 3 amp relay contact remains closed for hold-on time after snowfall stops

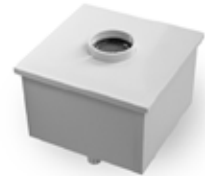

Part #	Model #	Description
42045	PA-800-RX2	Remote Probe for PS-800-RX

Part #	Model #	Description
134438	LCD-8	0,1,3, or 5 Hour Hold-On



Draft Controls

GVD Series Vent Damper Less Harness

- Operates with all 24VAC, 60Hz intermittent ignition and standing pilot ignition systems
- Stainless steel construction
- Damper operation: power opens in 15 seconds, power closes in 15 seconds
- Keyed wiring harness connector plug installs only one way, preventing incorrect wiring connection



Part #	Model #	Piping Size	Length	Height	Clearance	Exposed Pipe
47898	GVD-5PL	5"	6-1/16"	9-7/8"	15/16"	4-13/16"
47899	GVD-6PL	6"	6-1/2"	10-7/8"	1-3/16"	5-1/4"
47900	GVD-7PL	7"	7-1/16"	11-7/8"	1-7/16"	5-13/16"
47901	GVD-8PL	8"	8-1/16"	12-7/8"	1-15/16"	6-13/16"

GVD Accessories

- Operates with all 24VAC, 60Hz intermittent ignition and standing pilot ignition systems
- Stainless steel construction
- Damper operation: power opens in 15 seconds, power closes in 15 seconds
- Keyed wiring harness connector plug installs only one way, preventing incorrect wiring connection

Part #	Model #	Description
48766	GVD-RMA-PL	Damper Motor Repair Kit
74847	GVD-UWK	Universal 8' Harness with Conduit

Hydronic Controls

Aquatrol® Zoning Systems

AQ250 Aquatrol® Boiler Control Panel

- Boiler controls for single temperature, residential hydronic heating systems ensure ample supply of hot water for space heating and domestic uses
- Convert single-zone heating systems or upgrade relay-logic zoning systems
- Use with AQ1000 2-wire communicating thermostats, or most dry contact digital thermostats
- Offers zoning control for up to 4 zones and controls up to 2-stages of heat from a single thermostat
- Can expand up to 16 zones with AQ255 or AQ257 or up to 64 zones with AQ254 Add-A-Temp panels
- Line or low-voltage output for zoning equipment, including pumps or valves
- Features zone synchronization through the zone or greatest demand control
- Includes domestic hot water priority, priority override protection and boiler short cycling protection
- Automated test feature for quick start-up and simplified troubleshooting
- CSA/cCSAus Certified



Part #	Model #	Description
65531	AQ25042B	DHW Priority (4) Zone of Zone Pumps or 2-Wire Valves (Line Voltage), Tradeline

AQ257 Aquatrol® Boiler Control Panel

- UAQ257 for zoning with zone valves with end switches
- Includes auto test function to test zones at system start up
- LED lights for visual diagnostic of zone operation
- Adjacent zoning panels can operate different zone equipment
- Easily switch from zone valves to pumps with same zoning module
- R-C transformer and B-B data bus terminal connections for easy expansion
- Zones can be set to energize a group pump via Aux Out dry contacts on main control panel or expansion control panel
- Zone synchronization through Zone of Greatest Demand control



Part #	Model #	Description
69210	AQ25742B	Zoning Control Panel for 2 Wire Zone Valves

AQ1000TN2 Aquatrol® Non-Programmable Communicating Thermostat

- Used to control the ambient air temperature or floor temperature in hydronic heating applications
- Provides zoning control and communicates with and is powered by a Honeywell AQ2000 series zoning module
- 2-Wire polarity-insensitive non-programmable network communicating thermostat
- User buttons feature liquid crystal display as well as outdoor, indoor, and floor temperature displays
- Floor temperature sensing with minimum and maximum limits (when used with optional AQ12C20 Slab/Floor Sensor (sold separately))
- Selectable temporary and permanent backlight
- Powered by 24VDC AQ zoning module
- Setting temperature range: 40° to 100°F (5° to 38°C)
- Dimensions: 4-19/32"H x 2-13/16"W x 1"D



Part #	Model #	Description	Color
51395	AQ1000TN2	Single-Stage Heat, Terminal Designations: TH, TH, Sensor, Sensor	Premier White®

Aquatrol® Zoning System Parts & Accessories



Part #	Model #	Description
52768	AQ12C20	Slab/Floor Sensor 15' Lead Length for AQ1000 Series

Aquastats & Aquastat Controls

Hydronic Switching Relays

RA89/RA832 Hydronic Switching Relay

- Provides switching for hydronic zone controlled heating systems
- (1) Load must be line voltage; the other may be either line or low voltage
- Includes integral transformer for low voltage power for control circuit
- UL Listed, CSA certified



Part #	Model #	Description
5417	RA89A1074	120V SPST Switching of a Line Voltage Device From a Low Voltage Controller, Switches (1) Line Voltage Load, Tradeline
1423	RA832A1066	DPST Switching of a Line Voltage Device From a Low Voltage Controller, Switches (2) Line Voltage Loads Having a Common Power Source
36178	R8845U1003	Universal Hydronic

Aquastat® Controllers

L4006/L6006 Immersion Type Aquastat® Control

- Immersion type devices for limiting or regulating the temperature of liquids in boilers, storage tanks, and other applications where temperature control is required
- Totally enclosed Micro Switch™ snap-acting switches operate on temperature rise to set point
- Visible control point scale and external adjustment screw permit easy setting
- Horizontal or vertical insertion of the sensing element
- Direct or well immersion of the sensing element
- Models available for strap-on mounting
- Remote bulb model may be used to sense air temperature in ducts and in outside air sensing applications
- Tradeline models have heat-conductive compound
- Case dimensions: 5-5/8"H x 2"W x 2-1/8"D
- Bulb size: 3/8" x 2-7/8" copper
- Maximum ambient temperature: 150°F (66°C)
- AGA Certified
- UL Listed
- CSA Certified

L4006E High or Low Limit Manual Reset Aquastat® Controller

- SPST Contacts break on temperature rise
- Stop factory set @ 240°F
- Tradeline
- Includes 3" capillary



Part #	Model #	Operating Temp Range	Differential Temperature
21296	L4006E1067	130° to 270°F	Manual Reset

L4006H High Limit Manual Reset Strap-On Aquastat® Controller

- SPST Contacts break on temperature rise
- Stop factory set @ 240°F
- Tradeline
- Includes bracket for strap-on mounting and 1-1/2" capillary



Part #	Model #	Operating Temp Range	Differential Temperature
36709	L4006H1004	100° to 240°F	Manual Reset

Aquastats & Aquastat Controls

L6006A High or Low Limit & Circulator Aquastat® Controller

- SPDT Contacts
- Stop factory set @ 240°F
- Includes 3" capillary and heat compound



Part #	Model #	Operating Temp Range	Differential Temperature
14749	L6006A1145	100° to 240°F	5° to 30°F Adj Manual Reset

L6006C High or Low Limit & Circulator Surface Mount Aquastat® Controller

- SPDT Contacts
- Stop factory set @ 200°F
- Horizontal, vertical or strap-on mounting
- Tradeline



Part #	Model #	Operating Temp Range	Differential Temperature
3152	L6006C1018	65° to 200°F	5° to 30°F Adj

Electronic Temperature Controller

- Save time on installations with the easy-to-use graphical Interface, large display, and the intuitive programming
- Use the time clock scheduler or digital input to control the setback and disable output options to help save energy
- Protect equipment from freezing or overheating on models with the modulating high or low limit control option
- Get pinpoint control on modulating outputs by setting the integral and derivative times (PI or PID)
- Configure models with reset in a few easy steps
- Control floating actuators with floating outputs on select models
- Eliminate the need for a separate time delay device and protect equipment with the minimum off time option
- Sensor 50021579-001 included with non-NEMA 4X models
- Sensor T775-SENS-WR included with NEMA-4X models



Part #	Model #	Description
78248	TEK313	Electronic Temperature Controller w Reset

Aquastats & Aquastat Controls

Aquastat® Relays

L8148 Aquastat® Relay

- Immersion-type controllers that combine high limit protection with switching relay control of burner and circulator motors
- SPST Switching action for high limit and circulator
- High limit opens burner circuit only
- Select models include transformer and accessory terminals for adding a remote low limit controller
- Case available for horizontal or vertical mounting
- Requires 24VAC thermostat with heat anticipator set at 0.2A
- Tradeline models include well adapter, tube of heat conductive compound and range stops
- Tradeline
- Includes:
 - Transformer
 - Accessory terminals for adding a remote low limit controller
 - Well adapter
 - Tube of heat conductive compound
 - Range stops
- UL Listed
- CSA Certified



L8148 High Limit Aquastat® Relay

- Switching action: SPST high limit and circulator

Part #	Model #	Description
29105	L8148A1017	120V, 1-1/2" to 3" Insul, 140° to 240°F, 8°F Fixed, 4-1/2' Cap, Horizontal Mount Less Well
37040	L8148E1265	120V, 1-1/2" to 3" Insul, 180° to 240°F, 15°F Fixed, 4-1/2' Cap, Vertical Mount, Molex® Plug for Vent Damper
8009	L8148J1009	120V, 1-1/2" to 3" Insul, 120° to 240°F, 8°F Fixed, 4-1/2' Cap, Vertical/Horizontal Mount Less Well

Aquastat® Accessories

3" Copper Well Assembly

- Copper and stainless steel well assemblies for use with Aquastat sensors
- Available in various lengths, diameters, and insulation depths



Part #	Model #	Description
6707	121371B	3/8" x 3" Bulb Size, Copper 3/4" x 14 NPT, 1-1/2" Insulation, 3" Insertion Well with Mounting Clamp
14732	123869A	3/8" x 3" Bulb Size, Copper 1/2" NPT, 1-1/2" Insulation, 3" Insertion Well with Well Clamp

Radiant Systems

TruFLOW Heating Manifold Exploded View

TruFLOW™ Classic and Jr. manifolds exploded view

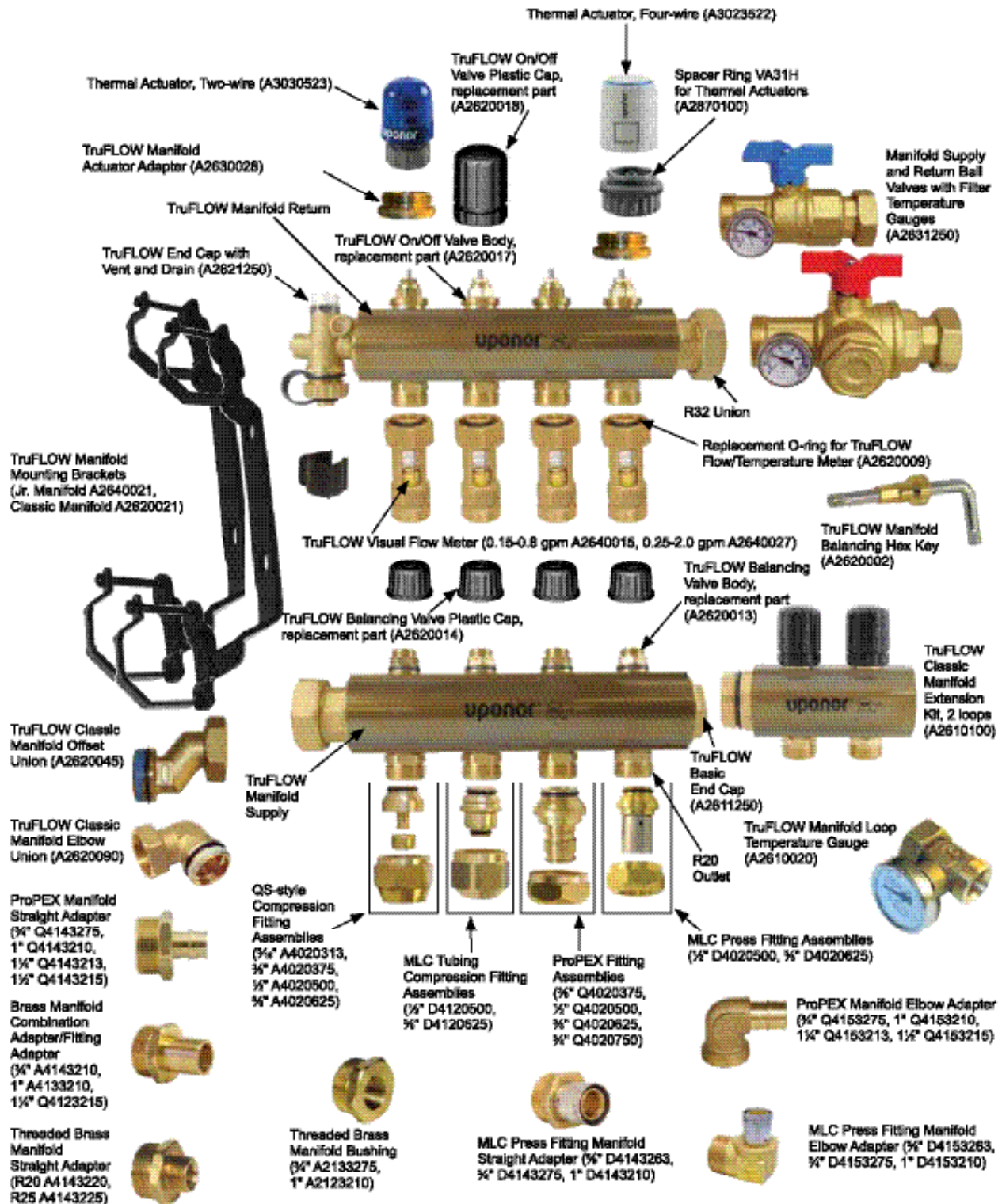

Radiant Systems

Stainless Steel Manifold Parts & Accessories

Part #	Model #	Description
144362	A2771060	Thermal Actuator Adapter, Spacer

Stainless Steel Manifolds

Stainless Steel Manifold Assembly

- Includes:
 - Flow meter
 - Balance valve
 - Isolation valve

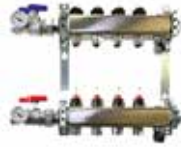

Part #	Model #	Size	Loops
143805	A2700202	1"	2-Loop
143815	A2700302	1"	3-Loop
143816	A2700402	1"	4-Loop
143818	A2700502	1"	5-Loop
143819	A2700602	1"	6-Loop
143820	A2700702	1"	7-Loop
143821	A2700802	1"	8-Loop
143822	A2701002	1"	10-Loop
143823	A2701202	1"	12-Loop

Uponor hePEX™ Plus Barrier Tubing

- PEX-A Tubing
- Oxygen barrier tubing
- Can be used with ProPEX® or QS-style fittings



Part #	Model #	Size	Length
23136	A1180313	5/16"	250'
25259	A1220313	5/16"	1,000'
25126	A1210375	3/8"	400'
9162	A1250500	1/2"	300'
10626	A1220500	1/2"	1,000'
8480	A1250625	5/8"	300'
12280	A1220625	5/8"	1,000'
9632	A1250750	3/4"	300'
50995	A1220750	3/4"	1,000'
27582	A1251000	1"	300'

MultiCor® Tubing (PEX-AL-PEX)

- PEX-A Tubing
- Oxygen barrier tubing
- Can be used with ProPEX® or QS-style fittings



Part #	Model #	Size	Length
40617	D1250500	1/2"	300'
36742	D1220500	1/2"	1,000'
38082	D1140750	3/4"	100'



A MUNCH'S SUPPLY COMPANY

Radiant Systems

TruFlow™ Jr. Manifold Assemblies

TruFLOW™ Jr. Manifold Assembly with Balancing & Isolation Valve

- 1-1/4", R32 x R20
- Union x MPT
- 145 PSI/4 GPM
- 2-Port
- 1-Valve



Part #	Model #	Loops
48787	A2660201	2-Loop
48788	A2660301	3-Loop
48789	A2660401	4-Loop
48790	A2660501	5-Loop
48791	A2660601	6-Loop
48792	A2660701	7-Loop
48793	A2660801	8-Loop

TruFLOW™ Jr. Manifold Assembly with Balancing Valves



Part #	Model #	Loops
48796	A2660300	3-Loop
48797	A2660400	4-Loop
48798	A2660500	5-Loop

Brass Manifold Pressure Test Kit

- Includes:
 - R32 x 3/4" Manifold bushing
 - R32 Solid brass plug
 - 3/4" Brass nipple
 - Pressure gauge assembly (100 psi)
 - Schraeder valve



Part #	Model #	Description
5311	E6122000	Pressure Test Kit

Gaskets

Part #	Model #	For use with:
49052	A2620005	R32 Unions Replacement Gasket

1-1/4" Brass Manifold Accessories End Cap with Vent

- For 1-1/4" Brass manifolds
- Includes:
 - Swivel drain valve
 - Manual air vent
 - Gasket



Part #	Model #	Description
15858	A2803250	End Cap with Vent, R32

End Cap

- For 1-1/4" Brass manifolds
- Includes required gasket



Part #	Model #	Description
2797	A2080032	Basic End Cap, R32
2704	A2080020	Loop End Cap, R20

Manifold Accessories for TruFLOW™ & 1-1/4" Brass Manifolds ProPEX® Manifold Adapter

- R32 x ProPEX® ends



Part #	Model #	Description
42596	Q4143275	R32 x 3/4" Straight
36989	Q4153210	R32 x 1" Elbow
36988	Q4153275	R32 x 3/4" Elbow

Controls & Zoning

Thermal Actuator

- 24VAC



Part #	Model #	Description
144937	A3023522	4-Wire Thermal Actuator

501S Uponor Set Point Thermostat

- With floor sensor
- Single-stage



Part #	Model #	Description
38078	A3041501	Set Point Thermostat

Radiant Systems

ProPEX® Brass Fittings

- ProPEX® tool and rings required (sold separately)

ProPEX® Brass Coupling (PEX)



Part #	Model #	Size
24672	Q4546363	5/8" ProPex x 5/8" ProPex
65277	LF4545050	1/2" ProPex x 1/2" ProPex
172392	LF4547575	3/4" Pex x 3/4" Pex

ProPEX® Brass Sweat Adapter (PEX x CU)



Part #	Model #	Size
24671	Q4516375	5/8" Pex to 3/4" Copper Pipe
70363	LF4515050	1/2" ProPex to 1/2" Copper Pipe Lead-Free
74884	LF4515075	1/2" ProPex to 3/4" Copper Pipe Lead-Free
72327	LF4517575	3/4" ProPex to 3/4" Copper Pipe Lead-Free
70681	LF4511010	1" ProPex to 1" Copper Pipe Lead-Free

ProPEX® Brass Fitting Adapter (PEX x CU)



Part #	Model #	Size
24297	Q4506375	5/8" Pex to 3/4" Copper Ftg
75322	LF4505075	1/2" ProPex to 3/4" Copper Ftg Lead-Free
74769	LF4507575	3/4" ProPex to 3/4" Copper Ftg Lead-Free

ProPEX® Brass Male Threaded Adapter (PEX x MPT)



Part #	Model #	Size
25467	Q4526375	5/8" ProPex x 3/4" NPT
44805	LF4527575	3/4" ProPress x 3/4" NPT
78990	LF5632020	1" ProPress x 1" NPT

ProPEX® Rings

- With stop



Part #	Model #	Size
55255	Q4690512	1/2"
131336	Q4690625	5/8"
60067	Q4690756	3/4"
72567	Q4691000	1"
39583	Q4691250	1-1/4"

ProPEX® Engineered Polymer Fittings

- ProPEX® tool and rings required (sold separately)

ProPEX® Engineered Polymer Coupling (PEX)



Part #	Model #	Size
38828	Q4775050	1/2" ProPex x 1/2" ProPex
38829	Q4776363	5/8" ProPex x 5/8" ProPex
38827	Q4777575	3/4" ProPex x 3/4" ProPex

ProPEX® Lead-Free Valves

ProPEX® Lead-Free Brass to Copper Ball Valve with Large Bore (PEX x CU Adapter)



Part #	Model #	Size
65519	LF4805050	1/2" ProPex to 1/2" Copper Ftg
41786	Q5806375	5/8" ProPex to 3/4" Copper Ftg

ProPEX® Baseboard Fittings

- ProPEX® tool and rings required (sold separately)

ProPEX® Baseboard Elbow (PEX x CU Adapter)



Part #	Model #	Size
26423	Q4386375	5/8" ProPex to 3/4" Copper

Expander Heads

ProPEX® Expander Head

- Use with all ProPEX® expander tools
- Not compatible with APR
- Blunt Expander Tool



Part #	Model #	Size
24945	Q6310750	3/4"
24163	Q6310500	1/2"
24164	Q6310625	5/8"

Radiant Systems

Fitting Assemblies

QS-Style Brass Fitting Assembly

- Compression fitting assembly with o-ring (sold separately)
- Connects Uponor hePEX® plus and AQUAPEX® tubing to all Uponor manifolds and R20 components
- Maximum pressure: 200 psi



Part #	Model #	Size	Type
23141	A4020313	5/16"	R20 Thread
29696	A4020375	3/8"	R20 Thread
17298	A4020500	1/2"	R20 Thread
16471	A4020625	5/8"	R20 Thread
17675	A4020750	3/4"	R25 Thread

ProPEX® Fitting Assembly

- Connects ProPEX® tubing to brass manifolds
- 2-Piece assembly includes a ProPEX® insert and R20 swivel nut
- ProPEX® tool and ProPEX® rings required (sold separately)



Part #	Model #	Size	Type
24167	Q4020500	1/2"	R20 Thread
24168	Q4020625	5/8"	R20 Thread
44027	Q4020750	3/4"	R20 Thread

QS Fitting Assembly O-Ring

Part #	Model #	Type
2072	A4021116	R20 Thread

MultiCor® Brass Compression Fitting Assembly

- Connects 1/2" and 5/8" MultiCor® tubing to brass manifolds



Part #	Model #	Size	Type
36743	D4120500	1/2"	R20 Thread
38833	D4120625	5/8"	R20 Thread

Tubing Transition Fittings

QS-Style Brass Coupling Nipple

- Use coupling nipple (brass) and the appropriate fitting assembly to connect
- 5/16", 1/2", 5/8" or 3/4" tubing together



Part #	Model #	Type
9619	A4322020	R20 Thread x R20 Thread

QS-Style Brass Conversion Nipple (Thread x MPT)

- Use conversion nipple (brass) and the appropriate fitting to connect 5/16", 1/2", 5/8" or 3/4"
- Uponor tubing to 1/2", 3/4" & 1" NPT



Part #	Model #	Size
36185	A4322050	R20 x 1/2" NPT
10127	A4322075	R20 x 3/4" NPT

QS-Style Copper Adapter (Thread x CU)

- Use R20 or R25 adapter and appropriate QS-style fitting assembly to transition PEX tubing to 1/2" and 3/4" copper pipe



Part #	Model #	Size
15762	A4332050	R20 x 1/2" Copper
15168	A4332075	R20 x 3/4" Copper
1114	A4332575*	R25 x 3/4" Copper

*For 3/4" Tubing

QS-Style Copper Fitting Adapter (Thread x CU)

- Use R20 adapter and appropriate QS-style fitting assembly to transition PEX tubing to 1/2" and 3/4" copper fittings



Part #	Model #	Size
29748	A4342050	R20 x to 1/2" Fitting
1396	A4342075	R20 x to 3/4" Fitting

Repair Coupling

- Use to connect 5/16" hePEX plus together
- 1-Piece repair coupling comes as a kit so no other fittings are necessary



Part #	Model #	Size
38584	A4010313	5/16"

Panels & Plates

Quik Trak™ Panel

- 1/2" Plywood panels attached to an aluminum heat transfer sheet
- Use with Uponor 5/16" hePEX® plus only



Part #	Model #	Size
23139	A5060701	7" x 48"
33260	A5060761	7" x 48" x 6 Panels (Preassembled)

Quik Trak™ Return Panel

- Use with Uponor 5/16" hePEX® plus only



Part #	Model #	Size
23140	A5060702	7" x 48"

Radiant Systems

Hydronics

Quik Trak™ Joist Track

- Extruded aluminum
- 4'L x 4"W
- 20/Box



Part #	Model #	Size
36745	A5080500	1/2"

MultiPress Fittings for TruFLOW® Classic, TruFLOW® Jr. & 1-1/4" Brass Manifolds

- MultiPress tool required (sold separately)

MultiPress Adapter (Thread x MLC)

- For TruFLOW Classic, TruFLOW Jr. and 1-1/4" brass manifolds
- Transition R32 manifold connection to 5/8", 3/4" and 1" MultiCor tubing



Part #	Model #	Size	Type
46621	D4143275	R32 x 3/4" MLC	Straight
46620	D4153275	R32 x 3/4" MLC	Elbow

MultiPress Fittings for MultiCor®

MultiPress Brass Sweat Adapter (MLC x CU)

- Transitions MultiCor tubing to copper pipe
- Comes disassembled for sweating
- MultiPress tool required (sold separately)



Part #	Model #	Size
46622	D4517575	3/4" MLC to 3/4" Copper Pipe
44888	D4511010	1" MLC to 3/4" Copper Pipe

Manifold Adapters & Fittings

Brass Manifold Combination Adapter

- R32 Threaded side couples with R32 union connection on brass manifolds



Part #	Model #	Size
6183	A4143210	R32 x 3/4" or 1" Copper
1370	A4133210	R32 x 1" or 1-1/4" Copper

Manifold Threaded Adapter/Bushing

- For brass manifold transitions the R32 manifold union nut to PEX or MultiCor tubing with QS-style fittings
- Use with 1-1/4" Brass and TruFLOW Manifolds



Part #	Model #	Size
15002	A2123210	R32 Male x 1" FPT

Installation Aids

Fixing Wire

- Galvanized steel
- 1,000/Bundle



Part #	Model #	Size
15742	A7031000	6" Long

Fixing Wire Twister

- Use with fixing wire



Part #	Model #	Description
9376	E6090005	Fixing Wire Twister

Plastic PEX Clip

- Enhanced Uponor PEX clips provide better holding power and can be attached together laterally for tight installations
- PEX Clips are attached under the wood subfloor for joist-heating applications
- Clips prevent tubing from coming in direct contact with subfloor
- Drywall screws are commonly used to secure the clips to the wood subfloor



Part #	Model #	Description
9222	F7051258	For use with 1/2" & 5/8" Tubing

Tube Talon

- Use to secure 1/2", 5/8", 3/4" and 1" PEX to wood surfaces
- Pre-loaded nail



Part #	Model #	Description
29695	F7050750	1/2", 5/8", 3/4"

Metal Bend Support

- Zinc-plated
- Provides rigid 90° bend for



Part #	Model #	Description
34138	A5110375	For 3/8" Tubing
25862	A5110500	For 1/2" Tubing
14197	A5110625	For 3/4" Tubing

Radiant Systems

PVC Plastic Bend Support

- Provides rigid 90° bend for 1/2", 5/8" and 3/4" Uponor PEX exiting a concrete slab



Part #	Model #	Size	Bend Support Size
29858	A5500500	3/4"	3/8" and 1/2"
1791	A5500625	1"	5/8"
2826	A5500750	1-1/4"	3/4"

Quik Trak™ Sealant

- 100% Silicone
- Used to adhere tubing in groove and provide good thermal transfer



Part #	Model #	Size
36956	E6050010	10.3 fl oz

Foam Staple

- For use with E6025075 manual stapler
- Plastic foam staple used to secure 1/2", and 5/8" PEX to rigid insulation
- For 1-1/2" or thicker foam



Part #	Model #	Size
27024	A7015075	2-1/2"

Metal Tubing Staple

- 2,500/Box



Part #	Model #	Size
79254	A7011250	1-1/4"

Select Uncoiler

- Facilitates the uncoiling of 5/16" to 1" PEX or up to 5/8" MLC tubing
- Adjustable reel for either horizontal or vertical position uncoiling
- Equipped with tubing feed eyelet
- Cannot support 1,000' coils of 5/8" and larger MLC tubing



Part #	Model #	Description
38305	E6062000	Select Uncoiler



Reflective Insulation

Insul-Tarp® Under-Slab Insulation

- Provides a thermal break and moisture barrier between slab and grade
- Cross woven polyethylene with 3mil aluminum and polyethylene closed-cell foam core
- Temperature range: -60° to 180°F
- Tensile strength: 45 lbs/in
- Bursting strength: 90 psi
- Fire rated up to Class A-1



Part #	Model #	Size	Coverage
35020	DRFB1250	12' x 50' x 1/2"	600 sq ft

Radiant Systems

BranchMaster™ Copper Manifolds

1" x 1" (MSwt x MSwt Trunk)

- 1" Type L trunk
- Branches are 2" on-center
- For crimp connection



Part #	Model #	Description
63359	672X1244	(12) 1/2" PEX Branches

BranchMaster™ No Lead 1" x 1" (MSwt x MSwt Trunk)

- 1" Type L copper trunk
- Branches are 2" on-center



Part #	Model #	Description
63355	678-21244	(12) 1/2" M Swt Branches

No-Lead 1-1/4" x 1-1/4" (MSwt x MSwt Trunk)

- 1-1/4" Type L trunk
- Branches are 3" on center



Part #	Model #	Description
63360	6795L-12333	(12) 3/4" M Swt Branches

1" Main Header (Swt)

- 1" Type L trunk

Part #	Model #	Description
63335	06784L-2433-3	(12) 3/4" M Swt Branches

Branchmaster™ Hydronic Copper Manifolds

1/2" PEX F1807 Branches with Valve

- 1" Type L trunk with 1" F Swt x 1" M Swt connection
- Branches are 2" on center
- For crimp connection



Part #	Model #	Description
63352	672XV0242	(2) 1/2" F1807 Ball Valve
63353	672XV0342	(3) 1/2" F1807 Ball Valve
63354	672XV0442	(4) 1/2" F1807 Ball Valve

PEX Fittings

PowerPEX™ PEX Crimp Ring

- Pure, annealed copper rings
- For use with PEX SDR9 piping only
- Not for use with PB pipe



Part #	Model #	Size
63357	649X2	1/2"

Crimp Tools

- For PEX and PB crimp rings

Ratcheting Compact Crimp Tool

- Right angle tool for making crimps in close quarters
- Compact tool allows one-hand crimping
- Works with PowerPex® crimp rings



Part #	Model #	Size	Length
63358	305-92R	1/2" Crimp	11"



Manifold Components

680 Universal PEX Fitting

- Compatible with any ASTM F876 single layer PEX and ASTM F1281 multi-layer PEX-AL-PEX pipe
- Maximum working pressure: 150 psi



Part #	Model #	Description
56692	680504A	1/2" Nom Universal PEX Fitting

Radiant Systems

Heatrim Model RB Residential Baseboard Radiation



- Hydronic perimeter baseboard
- Dimensions: 7-3/8"H x 2-11/16"D
- Enclosure top, back and front panel
- Snap-in brackets
- Pivot-mounted damper



Heatrim Model RB Baseboard Radiation Complete

- One length each of front and back panel, damper, support brackets, slide cradles and heating element
- 5', 6', 8' Lengths include joining piece set

Part #	Model #	Length	Copper Fin
41342	RB-750-A2	2'	3/4"
41343	RB-750-A3	3'	3/4"
41344	RB-750-A4	4'	3/4"
41345	RB-750-A5	5'	3/4"
41346	RB-750-A6	6'	3/4"
41347	RB-750-A7	7'	3/4"
41348	RB-750-A8	8'	3/4"
41363	RB-750-A10	10'	3/4"

Enclosure Only Assembled Pack

- One length each of front and back panel, damper and support brackets

Part #	Model #	Length	Includes:
41362	RB-8-A	8'	Joining piece

Element Only Four Pack

Part #	Model #	Length	Fin
4278	E-750-8	8'	3/4"

Heatrim™ Accessories



Part #	Model #	Description
12603	RA-ECR-03	3" Right-Hand End Cap
12902	RA-ECL-03	3" End Cap, Left-Hand
18453	RA-VER-04	4" Hinged Vlv Encl, Right-Hand
18769	RA-VEL-04	4" Hinged Vlv Encl, Left-Hand
41354	RB-ICF-90	90° Hinged Inside Corner
12478	RA-ICB-90	90° Inside Corner Back Piece
41355	RB-ICF-45	135° Hinged Inside Corner
391	RA-OCF-90	90° Outside Corner
41356	RB-WEP-03	3" Wall End Piece
41359	RB-JPS-02	2" Joining Piece Set (3 Pc)

BROAN

Heaters

High-Capacity Wall Heater

- Large capacity fan-forced heaters for high heat loss areas
- Easily converts to half-wattage
- 18"H x 14-1/4"W x 3-3/4"D Housing
- Totally enclosed, sheathed elements
- Heavy-gauge steel grille, 20-1/4"H x 16-3/8"W x 1-1/4"D
- Can be recess or surface mounted (surface mounting requires Model 85 Kit sold separately)
- White baked enamel



Part #	Model #	Watts	Volts
13704	198	4,000/3,000W	240/208V
3644	BR085	Surface mount kit for 198	



Twin-Flo® III Heaters

Twin-Flo® III Kickspace Heater

- Install in kickspace under cabinets, in between floor joists and other tight spaces
- Works with home hot water heating system
- Made in USA
- 1/2" Nominal connections
- ETL Listed
- 5-Year warranty



Part #	Model #	BTUH	CFM	Dimensions H x W x L
38668	K42	4200	53	3-7/8" x 12-1/4" x 12-3/4"
38669	K84	8400	103	3-7/8" x 19-1/4" x 12-3/4"
20038	K120	12000	127	3-7/8" x 19-1/4" x 12-3/4"

Twin-Flo® III Hose Kit

- Allows for installation of any "K" kickspace heater in new or retro-fit construction situations
- Includes:
 - (2) 1/2" Female bronze barbed hose connections
 - (2) 1/2" Male bronze barbed hose connections
 - (4) Constant tension hose clamps
 - (1) 10' Length of 1/2" flexible hose



Part #	Model #	Description
46013	HK10	Twin-Flow® III Hose Kit

Radiant Systems

Gov-Board™ Baseboard Assemblies

Gov-Board™ Assembly

- Cast iron radiant baseboard
- Low profile and quiet



Part #	Model #	Length	Side
28091	9A2C	2'	Complete
28093	9A3C	3'	Complete
28094	9A4C	4'	Complete
28095	9A5C	5'	Complete
28096	9A6C	6'	Complete
28072	9A1R	1'	Right-Hand
28073	9A2R	2'	Right-Hand
28074	9A3R	3'	Right-Hand
28075	9A4R	4'	Right-Hand
28076	9A5R	5'	Right-Hand
28086	9A2I	2'	Center
28087	9A4I	4'	Center
28089	9A6I	6'	Center
28077	9A1.5C	1.5'	Left-Hand
28079	9A2L	2'	Left-Hand
28082	9A4L	4'	Left-Hand
28085	9A6L	6'	Left-Hand

Gov-Board™ End Cap

Part #	Model #	Description
28116	6074111	LH Adjustable End Cap
53213	60741111	6" LH End Cap
28117	6074112	RH Adjustable End Cap
28115	6074114	RH End Cap

Gov-Board™ Fittings

Part #	Model #	Description
28122	8064101	3/4" Push Nipples
44941	8074417	3/8-16 x 1-1/4" Tie Bolt w/Nuts
28120	8076001	4-5/8" Flex Connectors for Compression Inside Corner 90° #90-S

Gov-Board™ Support

Part #	Model #	Description
28107	6074116	Top Center Support
28108	6074118	Bottom Center Support

Gov-Board™ Accessories & Fittings



Gov-Board™ Corner

Part #	Model #	Description
28104	80741603	4-5/8" Inside Corner Plate
28105	80741604	10-5/8" Inside Corner Plate

Gov-Board™ Valve Enclosure

Part #	Model #	Description
28099	6074419	LH Valve Enclosure
28103	6074420	RH Valve Enclosure

Rheem Residential Gas Water Heaters

Professional™ Classic™ Gas Water Heaters

6-Year Limited Warranty on Tank and Parts

- Enhanced-flow brass drain valve
- Natural gas FHR: 50 to 90 gallons
- Guardian System™ - air/fuel shut-off system offers double protection and no filter maintenance free
- Low NOx design for low nitrous oxide emissions
- Maintenance free - no filter to clean
- EverKleen™ self cleaning device
- Exclusive R-Tech resistored anode rod
- 3/4" Water connections
- High altitude compliant
- Low-lead compliant
- Includes T&P relief valve
- Meets or exceeds requirements of the National Appliance Energy Conservation Act (NAECA)



Professional™ Classic™ Tall Atmospheric Natural Gas Water Heater

Part #	Model #	Type of Gas	Cap	Input BTUH	Tank Height	Jacket Dia	Height to Side of T&P Valve	Height to Vent	Height to Gas Conn	Vent Size	Energy Factor	Approx Ship Wt
159264	PROG29-32N RH63	NG	29 gal	32,000	56-7/8"	16-1/2"	50-3/4"	59-3/4"	14-1/4"	3" or 4"	0.63	100 lbs
159149	PROG40-38N RH62	NG	40 gal	38,000	58-1/2"	19"	52-1/4"	61-1/2"	14-1/4"	3" or 4"	0.62	120 lbs
159151	PROG50-38N RH60	NG	50 gal	38,000	58-3/8"	20-1/2"	51-3/8"	61-1/4"	14-1/4"	3" or 4"	0.6	140 lbs

Professional™ Classic™ Short Atmospheric Natural Gas Water Heater

Part #	Model #	Type of Gas	Cap	Input BTUH	Tank Height	Jacket Dia	Height to Side of T&P Valve	Height to Vent	Height to Gas Conn	Vent Size	Energy Factor	Approx Ship Wt
159260	PROG40S-38N RH62	NG	40 gal	38,000	50-1/4"	21-3/8"	53-1/4"	52-3/4"	14-1/4"	3" or 4"	0.62	125 lbs

Professional™ Classic™ Tall Atmospheric LP Gas Water Heater

Part #	Model #	Type of Gas	Cap	Input BTUH	Tank Height	Jacket Dia	Height to Side of T&P Valve	Height to Vent	Height to Gas Conn	Vent Size	Energy Factor	Approx Ship Wt
162259	PROG40-32P RH62	LP	40 gal	32,000	58-1/2"	18-1/2"	52-1/4"	61-1/2"	14-1/4"	3" or 4"	0.62	115 lbs
159268	PROG50-36P RH62V2	LP	50 gal	36,000	59-1/4"	21-1/2"	52-1/2"	62-1/2"	14-1/2"	3" or 4"	0.62	165 lbs



A MUNCH'S SUPPLY COMPANY

Rheem Residential Gas Water Heaters

Professional™ Classic Plus™ Gas Water Heaters

8-Year Limited Warranty on Tank and Parts

- FHR: Up to 83 gallons for natural gas
- Enhanced-flow brass drain valve
- Recovery rate of up to 40.4 gallons for NG at 90° rise
- Guardian System™ - air/fuel shut-off system offers double protection and no filter maintenance free
- Eco-friendly burner
- Low NOx design
- EverKleen™ self cleaning device
- Exclusive R-Tech resistored anode rod
- High altitude compliant
- Low-lead compliant
- Standard replacement parts
- Includes T&P relief valve
- Meets or exceeds requirements of the National Appliance Energy Conservation Act (NAECA)



Professional™ Classic Plus™ Tall Atmospheric Natural Gas Water Heater

Part #	Model #	Type of Gas	Cap	Input BTUH	Tank Height	Jacket Dia	Height to Side of T&P Valve	Height to Top of Assembly	Height to Gas Conn	Energy Factor	Approx Ship Wt
138212	PRO+G40-40N RH62	NG	40 gal	40,000	60"	19-1/2"	53-1/2"	63-1/4"	14"	0.62	135 lbs
138740	PRO+G50-40N RH62	NG	50 gal	40,000	59-1/4"	21-1/2"	52-1/2"	62-1/2"	14"	0.62	165 lbs

Professional™ Classic Plus™ Heavy-Duty Atmospheric Natural Gas Water Heater

8-Year Limited Warranty on Tank and Parts

- FHR: Up to 135 gallons for natural gas, up to 125 gallons for LP gas
- Enhanced-flow brass drain valve
- Recovery rate of up to 75.8 gallons for NG, up to 65.7 gallons for LP, at 90° rise
- Guardian System™ - air/fuel shut-off system offers double protection and no filter maintenance free
- Eco-friendly burner
- Low NOx design
- Maintenance free - no filter to clean
- EverKleen™ self cleaning device
- Exclusive R-Tech resistored anode rod
- Piezo ignition
- High altitude compliant
- Low-lead compliant
- Standard replacement parts
- Includes T&P valve
- Meets or exceeds requirements of the National Appliance Energy Conservation Act (NAECA)



Part #	Model #	Type of Gas	Cap	Input BTUH	Tank Height	Jacket Dia	Height to Side of T&P Valve	Height to Vent	Height to Gas Conn	Vent Size	Energy Factor	Approx Ship Wt
159152	PRO+G75-76N RH	NG	75 gal	75,100	60"	26-1/4"	53-1/4"	64"	14-3/4"	4"	-	320 lbs

Models and Specifications are Subject to Change Without Notice

Rheem Residential Gas Water Heaters

Professional™ Classic™ Power Vent Gas Water Heaters

6-Year Limited Warranty on Tank and Parts

- FHR: Up to 87 gallons for 50-gallon model, up to 71 gallons for 40-gallon model
- Enhanced-flow brass drain valve
- Recovery rate of up to 32.4 to 42.4 gph for 50 gallon, 32.4 to 40.4 for 40 gallon models, at 90° rise
- Longer venting lengths up to 100'
- PVC, ABS, or CPVC Vent pipe options
- Vertical or horizontal termination
- Self-diagnostic system
- Guardian System™ - air/fuel shut-off system offers double protection and no filter maintenance free
- Uses indoor air for combustion, blower exhausts the flue gases
- Whisper-quiet blower
- Low NOx design
- Maintenance free - no filter to clean
- EverKleen™ self cleaning device
- Exclusive R-Tech resistored anode rod
- Silicon nitride igniter (HSI)
- High altitude compliant
- Low-lead compliant
- Standard replacement parts
- Includes T&P relief valve
- Energy Star® rated
- Meets or exceeds requirements of the National Appliance Energy Conservation Act (NAECA)



Professional™ Classic™ Tall Power Vent Gas Water Heater

Part #	Model #	Type of Gas	Cap	Input BTUH	Tank Height	Jacket Dia	Height to Side of T&P Valve	Height to Top of Assembly	Height to Gas Conn	Energy Factor	Approx Ship Wt
130869	PROG40-40N RH67 PV	NG	40 gal	40,000	59"	19-3/4"	53-1/2"	67-3/8"	14"	0.67	140 lbs
159263	PROG40S-32P RH67 PV	LP	40 gal	32,000	63"	21-3/4"	44-1/2"	62-1/2"	14"	0.61	155 lbs
130868	PROG50-42N RH67 PV	NG	50 gal	42,000	58"	21-3/4"	52-1/2"	66-3/8"	14"	0.67	170 lbs
130884	PROG50-42P RH67 PV	LP	50 gal	42,000	58"	21-3/4"	52-1/2"	66-3/8"	14"	0.67	170 lbs

Professional™ Classic™ Short Power Vent Gas Water Heater

Part #	Model #	Type of Gas	Cap	Input BTUH	Tank Height	Jacket Dia	Height to Side of T&P Valve	Height to Top of Assembly	Height to Gas Conn	Energy Factor	Approx Ship Wt
159263	PROG40S-32P RH67 PV	LP	40 gal	32,000	51-1/4"	21-3/4"	44-1/4"	62-1/2"	14"	0.67	155 lbs
180628	PROG50S-32P RH67 PV	LP	50	32,000	51-1/4"	23-3/4"	44"	62-1/2"	14"	0.65	175 lbs



A MUNCH'S SUPPLY COMPANY

Rheem Residential Gas Water Heaters

Professional™ Classic Plus™ Power Vent Gas Water Heaters

Professional™ Classic Plus™ Tall Heavy-Duty Power Vent Gas Water Heater

8-Year Limited Warranty on Tank and Parts

- FHR: 120 gallons for 75-gallon model, 104 gallons for 60-gallon model
- Enhanced-flow brass drain valve
- Recovery rate of 69.7 to 75.8 gph for 75-gallon models and 50.5 to 55.6 for 60-gallon models, at 90° rise
- Longer venting lengths up to 100'
- PVC, ABS, or CPVC Vent pipe options
- Vertical or horizontal termination
- Self-diagnostic system
- Guardian System™ - air/fuel shut-off system offers double protection and no filter maintenance free
- Uses indoor air for combustion, blower exhausts the flue gases
- Standard 110VAC electrical connection
- Whisper-quiet blower
- Eco-friendly burner
- Low NOx design
- Maintenance free - no filter to clean
- EverKleen™ self cleaning device
- Exclusive R-Tech resitored anode rod
- Silicon nitride igniter (HSI)
- High altitude compliant
- Low-lead compliant
- Standard replacement parts
- Includes T&P relief valve
- Meets or exceeds requirements of the National Appliance Energy Conservation Act (NAECA)



Plumbing

Part #	Model #	Type of Gas	Cap	Input BTUH	Tank Height	Jacket Dia	Height to Side of T&P Valve	Height to Vent	Height to Gas Conn	Energy Factor	Approx Ship Wt
159262	PRO+G75-76N RH PV	NG	75 gal	75,100	60-1/8"	26-1/4"	53-1/4"	71-7/8"	14-1/2"	-	330 lbs

Models and Specifications are Subject to Change Without Notice

Rheem Residential Electric Water Heaters

Professional Classic™ Electric Standard Water Heaters

6-Year Limited Warranty on Tank and Parts

- 240VAC, Single phase
- Isolated tank design
- Enhanced-flow brass drain valve
- Restored copper upper element and restored Lifeguard™ stainless steel lower element
- Diagnostic system with glowing LED indicators
- EverKleen™ self cleaning device
- Exclusive R-Tech restored anode rod
- Electric junction box located above heating elements for easy installation
- Over-temperature protector cuts off power in excess temperature situations
- Includes T&P relief valve
- Low-lead compliant
- Meets or exceeds requirements of the National Appliance Energy Conservation Act (NAECA)
- UL Listed



Part #	Model #	Cap	Tank Height	Jacket Dia	First Hour Rating	Energy Factor	Approx Ship Wt
159272	PROE36 S2 RH95	36 gal	31-1/2"	24-1/4"	45 gph	0.95	118 lbs
159273	PROE28 S2 RH95	28 gal	30"	23"	42 gph	0.95	95 lbs

Professional™ Classic™ Medium Electric Water Heater

Part #	Model #	Cap	Tank Height	Jacket Dia	First Hour Rating	Energy Factor	Approx Ship Wt
159270	PROE40 M2 RH95	40 gal	48-1/4"	20-1/4"	55 gph	0.95	106 lbs

Professional™ Classic™ Tall Electric Water Heater

Part #	Model #	Cap	Tank Height	Jacket Dia	First Hour Rating	Energy Factor	Approx Ship Wt
159271	PROE50 T2 RH95	50 gal	58-5/8"	20-1/4"	57 gph	0.95	121 lbs

Professional Classic™ Electric Point-of-Use Water Heaters

6-Year Limited Warranty on Tank and Parts

- 120VAC, 2-Wire single phase
- Enhanced-flow brass drain valve (on 2.5 gallon model)
- Stainless steel high-efficiency lower heating element
- Exclusive Rheemglas® tank lining resists corrosion and prolongs tank life
- Over-temperature protector cuts off power in excess temperature situations
- Automatic thermostat keeps water at desired temperature
- Wall bracket for wall-mount installations
- Includes T&P relief valve
- Meets or exceeds requirements of the National Appliance Energy Conservation Act (NAECA)
- UL Listed



Part #	Model #	Cap	Tank Height	Jacket Dia	Height to Side of T&P Valve	Height to Hot Water Outlet	Height to Cold Water Inlet	Energy Factor	Approx Ship Wt
130881	PROE6 1 RH POU	6 gal	15-1/4"	15-3/4"	11-1/2"	12-1/2"	4-1/4"	n/a	36 lbs



A MUNCH'S SUPPLY COMPANY

Rheem Commercial Gas Water Heaters

Commercial Gas Water Heaters

Universal Commercial Gas Water Heater

3-Year Limited Warranty on Tank

- Designed for tight retrofit applications
- Spark-to-pilot ignition system
- 80% Thermal efficiency
- Small jacket diameters
- Short floor-to-vent heights
- System Sentinel™ LED diagnostic system
- Maximum operating temperature: 180°
- Patented multi-flue design
- Low profile automatic flue damper
- Stainless steel burners
- Full port, full flow brass drain valve
- Patented anode design using multiple magnesium rods
- Includes T&P relief valve



Part #	Model #	Capacity	Input BTUH	Gas Type	Energy Factor	Vent Size	Unit H x Dia	Approx Ship Wt
25106	G75-125	75 gal	125,000	NG	0.8	5"	65-1/2" x 26-1/4"	480 lbs
8582	G82-156	82 gal	156,000	NG	0.8	6"	68-13/16" x 26-1/4"	490 lbs
30641	G37-200	35 gal	199,900	NG	0.8	6"	49-1/4" x 26-1/4"	405 lbs
12055	G76-200	76 gal	199,900	NG	0.8	6"	68-13/16" x 26-1/4"	540 lbs
13067	G100-200	100 gal	199,900	NG	0.8	6"	73-1/16" x 30-1/4"	780 lbs

Medium-Duty Commercial Gas Water Heater

3-Year Limited Warranty on Tank

- Small jacket diameters
- Short floor-to-vent heights
- Factory installed AGA/ASME rated T&P valve
- Maximum operating temperature: 180°
- Designed to shut off gas if the pilot flame is extinguished
- Rigid polyurethane foam insulation
- Full port, full flow brass drain valve
- Includes T&P relief valve
- N' Suffix denotes models meet low NOx construction standard



Part #	Model #	Capacity	Input BTUH	Gas Type	Energy Factor	Vent Size	Unit H x Dia	Approx Ship Wt
41238	G75-75N	75 gal	75100	NG	0.8	4"	64" x 26-1/4"	320 lbs
54633	G100-80	100 gal	80000	NG	0.8	4"	69-5/8" x 28-1/4"	410 lbs

Models and Specifications are Subject to Change Without Notice

Rheem Commercial Storage Tank

Commercial Storage Tanks

5-Year Limited Warranty Against Tank Leaks

- Meets or exceeds thermal efficiency and standby loss requirements of current ASHRAE standard
- Installed individually, or in parallel manifold
- Steel tank with two coats of high temperature porcelain enamel
- (2) Magnesium anode rods
- Maximum working pressure: 150 psi
- Can pass through a 30" opening
- 2" Rigid polyurethane foam insulation
- T&P Valve sold separately



Part #	Model #	Capacity	Input BTUH	Type	Energy Factor	Inlet Size	Unit H x Dia	Approx Ship Wt
26560	ST120	115 gal	N/A	Tank	N/A	2" NPT	59-1/4" x 28-1/4"	300 lbs

Thermostatic Mixing Valves

AM-1 Series 3-Way Thermostatic Mixing Valve

- Adjusts, maintains and limits the hot water temperature to a desired setting selected by user
- While increasing the amount of safe, usable hot water, it efficiently offers anti-scald, anti-chill protection
- Dual-purpose mixing or diverting
- Offers constant water temperature under changing operating conditions
- Temperature is limited at any point and if cold water supply is interrupted, flow reduction occurs in seconds
- Provides reliable performance at minimum flow of 0.5 gpm and proportional valve for simultaneous control of hot and cold
- Tamper-resistant design with nickel-plated brass construction and EPDM O-rings
- Designed for easy maintenance and Teflon® coating prevents mineral build-up and extends life
- Maximum pressure: 150 psi
- Maximum temperature: 212°F (100°C)
- cCSAus Certified, ASSE listed, IAPMO listed

Honeywell



Part #	Model #	Pipe Size	Connection	Capacity	Operating Temperature
30402	AM-101R-US-1	3/4"	Union Swt	3.9 Cv	70° to 180°F
37508	AM-102R-US-1	1"	Union Swt	3.9 Cv	70° to 180°F



A MUNCH'S SUPPLY COMPANY

6 CONVENIENT LOCATIONS

ANN ARBOR

141 Jackson Industrial
Ann Arbor, MI 48103
P (800) 665-1452
F (734) 665-0679
M-F: 7:30 a.m. – 4:30 p.m.

COLDWATER

36 Mill Street
Coldwater, MI 49036
P (800) 922-5180
F (517) 279-7350
M-F: 7:30 a.m. – 4:30 p.m.

GRAND RAPIDS

130 Graham S.W.
Grand Rapids, MI 49503
P (800) 541-1144
F (616) 247-0283
M-F: 7:30 a.m. – 4:30 p.m.

JACKSON

1021 Belden Road
Jackson, MI 49203
P (800) 333-8005
F (517) 782-1155
M-F: 7:30 a.m. – 4:30 p.m.

LANSING

1115 S. Pennsylvania
Lansing, MI 48912
P (800) 487-4836
F (517) 487-1119
M-F: 7:30 a.m. – 4:30 p.m.

SAGINAW

219 Atwater
Saginaw, MI 48601
P (800) 292-0233
F (989) 754-4241
M-F: 7:30 a.m. – 4:30 p.m.

Navien Residential Gas Water Heaters

NPE Series Premium Condensing Gas Tankless Water Heaters

Residential: 1-Year Warranty on Labor, 5-Year Warranty on Parts, 15-Year Warranty on Heat Exchanger

Commercial: 1-Year Warranty on Labor, 5-Year Warranty on Parts, 8-Year Warranty on Heat Exchanger

- Utilizes existing 1/2" gas line up to 24'
- 2" PVC, CPVC, Polypropylene venting up to 60'
- Negative pressure gas valve and dual venturi system allows for easy field convertibility from NG to LP operation
- Dual stainless steel heat exchangers
- Cascading capable without additional controllers (requires cascade cable)
- Forced draft direct vent
- Electronic ignition
- Low NOx emissions
- Water pressure: 15 - 150 psi
- Natural gas supply pressure: 3.5" to 10.5"wc
- Propane gas supply pressure: 8" to 13"wc
- Connection sizes: 3/4" NPT
- Power supply: 120VAC, 60Hz, 200W (maximum 2A)
- AHRI Certified
- Energy Star® rated



NPE-A Advanced Tankless Water Heater with ComfortFlow™ Technology

- Includes:
 - Buffer tank
 - Recirculation pump

Part #	Model #	Gas	Flow Rate @ 67° F Temp Rise	Heat Capacity Input (BTUH) Min/Max	UEF Rating	Dimensions H x W x D	Ship Wt
85807	NPE-180A	NG/LP	4.3 gpm	15,000/150,000	96%	27-2/5" x 17-3/10" x 11-2/5"	75 lbs
85808	NPE-210A	NG/LP	5.0 gpm	19,900/180,000	96%	27-2/5" x 17-3/10" x 13-1/5"	82 lbs
85809	NPE-240A	NG/LP	5.6 gpm	19,900/199,900	96%	27-2/10" x 17-3/10" x 13-1/5"	82 lbs

NPE-S Standard Tankless Water Heater

Part #	Model #	Gas	Flow Rate @ 67° F Temp Rise	Heat Capacity Input (BTUH) Min/Max	UEF Rating	Dimensions H x W x D	Ship Wt
130352	NPE180S	NG/LP	4.2 gpm	15,000/150,000	97%	27-2/5" x 17-3/10" x 11-2/5"	67 lbs
130356	NPE210S	NG/LP	5.2 gpm	19,900/180,000	97%	27-2/5" x 17-3/10" x 13-1/5"	75 lbs
130357	NPE240S	NG/LP	5.7 gpm	19,900/199,900	97%	27-2/5" x 17-3/10" x 13-1/5"	75 lbs

Navien Accessories and Manifolds

Part #	Model #	Description
197313	30014367A	Common Vent Collar Kit
124932	30009757A	Wired Remote Controller for NPE
146602	GFFM-MCOZUS-001	Primary Manifold for NCB
159986	GFFM-MSOZUS-001	Primary Manifold for NHB
184951	GFFM-KDIZUS-001	Ready-Link-Rack Floor Mount. Supports one unit or two back to back.
184952	GFFM-KDIZUS-002	Ready-Link-Rack for Expansion kit. Used to expand Ready-Link-Rack for 3+ units.

Water Heater Accessories

Self-Closing T&P Valves

- Bronze body with stainless steel spring
- Thermo-bonded, non-metallic protective coating on thermostat
- Fully automatic
- Includes test levers

100XL ASME (MPT Inlet x FPT Outlet)

- For hot water supply tanks and hot water heaters up to 105,000 BTUH
- Unique thermostat with special thermo-bonded coating
- ASME Certified
- CSA Certified



Part #	Model #	Size	PSI	
1503	100XL-150	3/4"	150 psi	with standard probe
134165	L100XL	3/4"	150 psi	with 2" extended body

Self-Closing Lead-Free T&P Valves (MPT Inlet x FPT Outlet)

- Bronze body with stainless steel spring
- Lead-free copper alloy
- For hot water storage tanks and heaters
- Thermo-bonded (non-metallic) protective coating on thermostat
- Fully automatic
- Includes test levers
- ASME Section IV
- CSA Certified



LF100XL Lead-Free ASME (MPT Inlet x FPT Outlet)

Part #	Model #	Size	PSI	
40685	100XL8	3/4"	150 - 210 psi	with extended probe

40 ASME Automatic Reseating T&P Valve

- For hot water supply tanks and heaters
- Non-mechanical seat-to-disc alignment
- Tamper-resistant bonnet screws
- ASME Section IV



ASME (MPT Inlet x FPT Outlet)

Part #	Model #	Size	PSI
36936	40XL-8	3/4"	150 psi

Water Heater Accessories

Water Heater Expansion Tanks

PH Series Potable Water Expansion Tank

- 16 Gauge cold rolled painted steel tank
- Brass valve with o-ring seal
- Welded system connection
- Maintains safe pressure in domestic water systems that utilize a back flow preventer or check valve
- 100% Butyl diaphragm and plastic liner to separate the system water from the tank's air precharge
- Steel clench ring regulates movement and prevents diaphragm from rubbing against tank wall
- System connection has stainless steel sleeve
- 1-Year limited warranty



Part #	Model #	Model	Size
131202	PH-05	2.1 gal	3/4" MPT
131203	PH-12	4.8 gal	3/4" MPT

Dielectric Union

Dielectric Union (C X FPT) ASME (MPT Inlet x FPT Outlet)



Part #	Model #	Size
8263	DIE012CXFE	1/2" (C x FPT)
15868	DIE034CXFE	3/4" (C x FPT)
713	DIE100CXFE	1" (C x FPT)
13191	DIE112CXFE	1-1/2" (C x FPT)
12187	DIE114CXFE	1-1/4" (C x FPT)

Dielectric Union (C x MPT)



Part #	Model #	Size
10362	DIE034CXM	3/4" (C x MPT)

Dielectric Gasket

Part #	Description
11245	Gasket For 3/4"
65160	Gasket For 1-1/4"

Water Heater Accessories

Water Heater Pans

Aluminum Water Heater Pan

- Manufactured from prime aluminum and are expertly worked to exact specifications under strict quality control
- Recommended for gas or electric water heaters
- Meets requirements of Southern Building Code
- Exposed edges have been rolled to protect the installer from injury



Part #	Model #	Size	Fitting
1302	34151	20"	1" PVC
39712	34153	24"	1" PVC
127902	34156	28"	1" PVC

Alarms

Flood Alert Alarm

- LED Alert
- Extra loud audible buzzer warning
- Detects water overflow
- For use on floors, in bathrooms or cellars, water heaters, sinks, washing machines, etc
- Includes:
 - (2) AA Battery
 - 1 12" Sensor cable



Part #	Model #	Description
90806	MA-1665B	Flood Alert Alarm

Plumbing



A MUNCH'S SUPPLY COMPANY

**Let us be your
source for quality
products from
leading manufacturers.**



Copper Pipe Fittings

Type L Copper - Blue

Type L Hard Blue - 10' Lengths



Part #	Model #	Nom Size	OD Size
7842	CPL-012X10	1/2"	5/8"
6655	CPL-034X10	3/4"	7/8"
3230	CPL-100X10	1"	1-1/8"

Type M Copper - Red

Type M Hard Red - 10' Lengths



Part #	Model #	Nom Size	OD Size
1353	CPM-012X10	1/2"	5/8"
255	CPM-034X10	3/4"	7/8"
15663	CPM-100X10	1"	1-1/8"
14886	CPM-114X10	1-1/4"	1-3/8"
14995	CPM-112X10	1-1/2"	1-5/8"
10392	CPM-200X10	2"	2-1/8"

Copper Pressure Fittings - Water

Copper Female Adapter (C x FPT)



Part #	Model #	Nom Size	OD Size
3398	CNF-F-12	1/2"	5/8" x 1/2"
3839	CNF-FR-1234	1/2" x 3/4"	5/8" x 3/4"
3605	CNF-F-34	3/4"	7/8" x 3/4"
5437	CNF-FR-3412	3/4" x 1/2"	7/8" x 1/2"
11476	CNF-F-1	1"	1-1/8" x 1"
3165	CNF-FR-134	1" x 3/4"	1-1/8" x 3/4"
2710	CNF-FR-1114	1" x 1-1/4"	1-1/8" x 1-1/4"
5263	CNF-F-114	1-1/4"	1-3/8" x 1-1/4"
5244	CNF-F-112	1-1/2"	1-5/8" x 1-1/2"
11486	CNF-F-2	2"	2-1/8" x 2"

Copper Street Female Adapter

(Ftg x FPT)



Part #	Model #	Nom Size	OD Size
54935	CNF-FST-12	1/2"	5/8" x 1/2"
22824	CNF-FST-34	3/4"	7/8" x 3/4"

Copper Male Adapter (C x MPT)



Part #	Model #	Nom Size	OD Size
12470	CNF-M-12	1/2"	5/8" x 1/2"
1294	CNF-MR-1234	1/2" x 3/4"	5/8" x 3/4"
12666	CNF-M-34	3/4"	7/8" x 3/4"
2671	CNF-MR-3412	3/4" x 1/2"	7/8" x 1/2"
6747	CNF-MR-341	3/4" x 1"	7/8" x 1"
18258	CNF-M-1	1"	1-1/8" x 1"
4766	CNF-MR-134	1" x 3/4"	1-1/8" x 3/4"
188	CNF-MR-1114	1" x 1-1/4"	1-1/8" x 1-1/4"
1765	CNF-M-114	1-1/4"	1-3/8" x 1-1/4"
442	CNF-MR-1141	1-1/4" x 1"	1-3/8" x 1"
1746	CNF-M-112	1-1/2"	1-5/8" x 1-1/2"
18265	CNF-M-2	2"	2-1/8" x 2"

Copper Flush Bushing (Ftg x C)



Part #	Model #	Nom Size	OD Size
1006	CNF-BUSH-134	1" x 3/4"	1-1/8" x 7/8"

Copper Tube Cap (Copper)



Part #	Model #	Nom Size	OD Size
12237	CNF-CAP-12	1/2"	5/8"
12423	CNF-CAP-34	3/4"	7/8"
15731	CNF-CAP-1	1"	1-1/8"
1180	CNF-CAP-114	1-1/4"	1-3/8"
28943	CNF-CAP-112	1-1/2"	1-5/8"



Copper Pipe Fittings

Copper Coupling (Copper)



Part #	Model #	Nom Size	OD Size
5509	CNF-COUP-12	1/2"	5/8"
5710	CNF-COUP-34	3/4"	7/8"
8994	CNF-COUP-1	1"	1-1/8"
12227	CNF-COUP-114	1-1/4"	1-3/8"
12206	CNF-COUP-112	1-1/2"	1-5/8"
9000	CNF-COUP-2	2"	2-1/8"

Copper Reducing Coupling (Copper)



Part #	Model #	Nom Size	OD Size
14221	CNF-COUP-R-3412	3/4" x 1/2"	7/8" x 5/8"
2436	CNF-COUP-R-112	1" x 1/2"	1-1/8" x 5/8"
2638	CNF-COUP-R-134	1" x 3/4"	1-1/8" x 7/8"
9975	CNF-COUP-R-11412	1-1/4" x 1/2"	1-3/8" x 5/8"
10165	CNF-COUP-R-11434	1-1/4" x 3/4"	1-3/8" x 7/8"
13577	CNF-COUP-R-1141	1-1/4" x 1"	1-3/8" x 1-1/8"
28275	CNF-COUP-R-11212	1-1/2" x 1/2"	1-5/8" x 5/8"
28276	CNF-COUP-R-11234	1-1/2" x 3/4"	1-5/8" x 7/8"
3670	CNF-COUP-R-1121	1-1/2" x 1"	1-5/8" x 1-1/8"
8084	CNF-COUP-R-112114	1-1/2" x 1-1/4"	1-5/8" x 1-3/8"
33447	CNF-COUP-R-234	2" x 3/4"	2-1/8" x 7/8"
17304	CNF-COUP-R-21	2" x 1"	2-1/8" x 1-1/8"
14018	CNF-COUP-R-2114	2" x 1-1/4"	2-1/8" x 1-3/8"
12957	CNF-COUP-R-2112	2" x 1-1/2"	2-1/8" x 1-5/8"

Copper 45° Elbow (Copper)



Part #	Model #	Nom Size	OD Size
10405	CNF-45-12	1/2"	5/8"
10590	CNF-45-34	3/4"	7/8"
11498	CNF-45-1	1"	1-1/8"
16695	CNF-45-114	1-1/4"	1-3/8"
16670	CNF-45-112	1-1/2"	1-5/8"
11508	CNF-45-2	2"	2-1/8"

Copper 45° Street Elbow (Ftg x C)



Part #	Model #	Nom Size	OD Size
8953	CNF-45ST-12	1/2"	5/8"
9154	CNF-45ST-34	3/4"	7/8"
9297	CNF-45ST-1	1"	1-1/8"
8324	CNF-45ST-114	1-1/4"	1-3/8"
8296	CNF-45ST-112	1-1/2"	1-5/8"
9306	CNF-45ST-2	2"	2-1/8"

Copper 90° Elbow (Copper)



Part #	Model #	Nom Size	OD Size
11204	CNF-90-14	1/4"	3/8"
17698	CNF-90-12	1/2"	5/8"
15943	CNF-90R-3412	3/4" x 1/2"	7/8" x 1/2"
17906	CNF-90-34	3/4"	7/8"
323	CNF-90R-134	1" x 3/4"	1-1/8" x 3/4"
16093	CNF-90-1	1"	1-1/8"
12173	CNF-90-114	1-1/4"	1-3/8"
12162	CNF-90-112	1-1/2"	1-5/8"
16106	CNF-90-2	2"	2-1/8"

Copper 90° Street Elbow (Ftg x C)



Part #	Model #	Nom Size	OD Size
3038	CNF-90ST-12	1/2"	5/8"
3260	CNF-90ST-34	3/4"	7/8"
4860	CNF-90ST-1	1"	1-1/8"
6899	CNF-90ST-114	1-1/4"	1-3/8"
6883	CNF-90ST-112	1-1/2"	1-5/8"
4869	CNF-90ST-2	2"	2-1/8"



Copper Pipe Fittings

Copper Tee (Copper)



Part #	Model #	Nom Size
2673	CNF-T-12	1/2"
10558	CNF-T-R-121234	1/2" x 1/2" x 3/4"
18076	CNF-T-R-341212	3/4" x 1/2" x 1/2"
18307	CNF-T-R-341234	3/4" x 1/2" x 3/4"
2866	CNF-T-34	3/4"
951	CNF-T-R-343412	3/4" x 3/4" x 1/2"
3106	CNF-T-R-34341	3/4" x 3/4" x 1"
12527	CNF-T-R-11212	1" x 1/2" x 1/2"
8837	CNF-T-R-1121	1" x 1/2" x 1"
14559	CNF-T-R-13434	1" x 3/4" x 3/4"
10829	CNF-T-R-1341	1" x 3/4" x 1"
18591	CNF-T-R-1112	1" x 1" x 1/2"
7795	CNF-T-R-1134	1" x 1" x 3/4"
5718	CNF-T-1	1"
17592	CNF-T-R-11412114	1-1/4" x 1/2" x 1-1/4"
4686	CNF-T-R-1143434	1-1/4" x 3/4" x 3/4"
701	CNF-T-R-114134	1-1/4" x 1" x 3/4"
14417	CNF-T-R-11411	1-1/4" x 1" x 1"
1917	CNF-T-R-1141114	1-1/4" x 1" x 1-1/4"
18295	CNF-T-R-11411412	1-1/4" x 1-1/4" x 1/2"
18493	CNF-T-R-11411434	1-1/4" x 1-1/4" x 3/4"
9013	CNF-T-R-1141141	1-1/4" x 1-1/4" x 1"
17129	CNF-T-114	1-1/4"
31472	CNF-T-R-11211212	1-1/2" x 1-1/2" x 1/2"
21883	CNF-T-R-11211234	1-1/2" x 1-1/2" x 3/4"
2881	CNF-T-R-1121121	1-1/2" x 1-1/2" x 1"
625	CNF-T-R-112112114	1-1/2" x 1-1/2" x 1-1/4"
17111	CNF-T-112	1-1/2"
26090	CNF-T-R-2212	2" x 2" x 1/2"
522	CNF-T-R-2234	2" x 2" x 3/4"
21604	CNF-T-R-221	2" x 2" x 1"
1722	CNF-T-R-22114	2" x 2" x 1-1/4"
1698	CNF-T-R-22112	2" x 2" x 1-1/2"
5728	CNF-T-2	2"

Copper Tee (C x FPT)

Part #	Model #	Nom Size
3997	CNF-T-R-F-343412	3/4" x 3/4" x 1/2"
15807	CNF-T-R-F-1112	1" x 1" x 1/2"

Copper Union (Copper)



Part #	Model #	Size	OD Size
11536	CNF-UNION-12	1/2"	5/8"
11751	CNF-UNION-34	3/4"	7/8"
14929	CNF-UNION-1	1"	1-1/8"
2238	CNF-UNION-114	1-1/4"	1-3/8"OD

Push Fittings



Part #	Model #	Nom Size
179543	CPF-COUP-12	1/2" Coupling Push Fit
179544	CPF-COUP-34	3/4" Coupling Push Fit
179545	CPF-COUP-1	1" Coupling Push Fit
179547	CPF-COUP-R-3412	3/4"x1/2" Red Coup Push Fit
179549	CPF-COUP-R-134	1"x3/4" Red Coup Push Fit
179546	CPF-COUP-REP-12	1/2" Repair Coup Push Fit
179548	CPF-COUP-REP-34	3/4" Repair Coup Push Fit
179550	CPF-COUP-REP-1	1" Repair Coup Push Fit
179569	CPF-CAP-12	1/2" Copper Cap Push Fit
179570	CPF-CAP-34	3/4" Copper Cap Push Fit
179571	CPF-CAP-1	1" Copper Cap Push Fit
179558	CPF-90-12	1/2" CxC 90 Elbow Push Fit
179559	CPF-90-34	3/4" CxC 90 Elbow Push Fit
179560	CPF-90-1	1" CxC 90 Elbow Push Fit
179561	CPF-90R-3412	3/4" COPx1/2 Cop 90 Elbow Push Fit
179562	CPF-T-12	1/2" CxCxC Tee Push Fit
179563	CPF-T-34	3/4" CxCxC Tee Push Fit
179564	CPF-T-1	1" CxCxC Tee Push Fit
179566	CPF-T-R-343412	3/4"x3/4"x1/2" Red Tee Push Fit
179568	CPF-T-R-1134	1"x1"x3/4" Red Tee Push Fit
179567	CPF-T-R-341234	3/4"x1/2"x3/4" Red Tee Push Fit
179565	CPF-T-R-341212	3/4"x1/2"x1/2" Red Tee Push Fit
179551	CPF-F-12	1/2" CxFemale Adapter Push Fit
179552	CPF-F-34	3/4" CxFemale Adapter Push Fit
179553	CPF-F-1	1" CxFemale Adapter Push Fit
179554	CPF-FR-1234	1/2" COPx3/4" FIP CxFemale Adapter Push Fit
179555	CPF-M-12	1/2" CxMale Adapter Push Fit
179556	CPF-M-34	3/4" CxMale Adapter Push Fit
179557	CPF-M-1	1" CxMale Adapter Push Fit
182576	CPF-MR-1234	1/2" COPx3/4" MIP CxMale Adapt Push Fit
182577	CPF-MR-341	3/4" COPx1" MIP CxMale Adapt Push Fit
182578	CPF-MR-134	1" COPx3/4" MIP CxMale Adapt Push Fit
179539	CPF-CLIP-12	1/2" Release Clip/Push Fit
179540	CPF-CLIP-34	3/4" Release Clip/Push Fit
179541	CPF-CLIP-1	1" Release Clip/Push Fit
179575	CPF-VAL-12	1/2" CxC Ball Valve Push Fit
179576	CPF-VAL-34	3/4" CxC Ball Valve Push Fit
179577	CPF-VAL-1	1" CxC Ball Valve Push Fit
179542	CPF-FLEX-34	3/4" FIPx3/4" Push Fit 18" SS Flex Connector
179574	CPF-FLEX-34-V	3/4" FIPx3/4" Push Fit 18" SS Flex Connector W/Ball Valve

Copper Press Fittings

Press System® Fittings

Coupling (Press)



Part #	Model #	Size
65646	PC600DS	1/2"
65647	PC600DS	3/4"
65648	PC600DS	1"
65649	PC600DS	1-1/4"
65650	PC600DS	1-1/2"
65652	PC600DS	2"
65651	PC600DS	2-1/2"
65653	PC600DS	3"

Reducing Coupling (Press)



Part #	Model #	Size
65655	PC600R	3/4" x 1/2"
65656	PC600R	1" x 1/2"
65657	PC600R	1" x 3/4"
65658	PC600R	1-1/4" x 3/4"
65659	PC600R	1-1/4" x 1"
65660	PC600R	1-1/2" x 3/4"
65661	PC600R	1-1/2" x 1"
65662	PC600R	1-1/2" x 1-1/4"
65665	PC600R	2" x 3/4"
65666	PC600R	2" x 1"

Adapter (P x FPT)



Part #	Model #	Size
65689	PC603	1/2"
65691	PC603	1/2" x 3/4"
65693	PC603	3/4" x 1/2"
65692	PC603	3/4"
65695	PC603	1" x 1/2"
65696	PC603	1" x 3/4"
65694	PC603	1"
65699	PC603	1-1/4" x 1"
65698	PC603	1-1/4"
65703	PC603	1-1/2" x 3/4"
65700	PC603	1-1/2"
65704	PC603	2"

Adapter (P x MPT)



Part #	Model #	Size
65708	PC604	1/2"
65710	PC604	1/2" x 3/4"
65712	PC604	3/4" x 1/2"
65711	PC604	3/4"
65714	PC604	1" x 3/4"
65713	PC604	1"
65716	PC604	1-1/4"
65719	PC604	1-1/2"
65721	PC604	2"

Fitting Reducer (Ftg x P)



Part #	Model #	Size
65615	PC600-2	3/4" x 1/2"
65623	PC600-2	1" x 3/4"
65624	PC600-2	1-1/4" x 1"

45° Elbow (Press)



Part #	Model #	Size
65725	PC606	1/2"
65726	PC606	3/4"
65727	PC606	1"
65728	PC606	1-1/4"
65729	PC606	1-1/2"
65730	PC606	2"

45° Elbow (Ftg x P)



Part #	Model #	Size
65734	PC606-2	1/2"
65735	PC606-2	3/4"
65736	PC606-2	1"
65737	PC606-2	1-1/4"
65738	PC606-2	1-1/2"
65739	PC606-2	2"

Models and Specifications are Subject to Change Without Notice

Copper Press Fittings

90° Elbow (Press)



Part #	Model #	Size
65743	PC607	1/2"
65744	PC607	3/4"
65746	PC607	1"
65747	PC607	1-1/4"
65748	PC607	1-1/2"
65749	PC607	2"
65750	PC607	2-1/2"
65751	PC607	3"

90° Elbow (Ftg x P)



Part #	Model #	Size
65754	PC607-2	1/2"
65755	PC607-2	3/4"
65756	PC607-2	1"
65758	PC607-2	1-1/2"
65757	PC607-2	1-1/4"
65759	PC607-2	2"
65760	PC607-2	2-1/2"
65753	PC607-2	3"

90° Elbow (P x FPT)



Part #	Model #	Size
65896	PC607-3	1/2" x 3/4"

Tee (Press)



Part #	Model #	Size
65770	PC611	1/2"
65771	PC611	1/2" x 1/2" x 3/4"
65772	PC611	1/2" x 1/2" x 1"
65774	PC611	3/4" x 1/2" x 1/2"
65775	PC611	3/4" x 1/2" x 3/4"
65776	PC611	3/4" x 3/4" x 1/2"
65773	PC611	3/4"
65777	PC611	3/4" x 3/4" x 1"
65778	PC611	1"
65779	PC611	1" x 1/2" x 1"
65780	PC611	1" x 3/4" x 1/2"
65781	PC611	1" x 3/4" x 3/4"
65782	PC611	1" x 3/4" x 1"
65783	PC611	1" x 1" x 1/2"
65784	PC611	1" x 1" x 3/4"
65785	PC611	1" x 1" x 1-1/4"
65787	PC611	1-1/4" x 1" x 3/4"
65788	PC611	1-1/4" x 1" x 1"
65789	PC611	1-1/4" x 1-1/4" x 1/2"
65790	PC611	1-1/4" x 1-1/4" x 3/4"
65791	PC611	1-1/4" x 1-1/4" x 1"
65786	PC611	1-1/4"
65793	PC611	1-1/2" x 1/2" x 1-1/2"
65794	PC611	1-1/2" x 3/4" x 3/4"
65795	PC611	1-1/2" x 1" x 3/4"
65796	PC611	1-1/2" x 1" x 1"
65797	PC611	1-1/2" x 1" x 1-1/2"
65798	PC611	1-1/2" x 1-1/4" x 1"
65799	PC611	1-1/2" x 1-1/4" x 1-1/4"
65800	PC611	1-1/2" x 1-1/2" x 1/2"
65801	PC611	1-1/2" x 1-1/2" x 3/4"
65802	PC611	1-1/2" x 1-1/2" x 1"
65792	PC611	1-1/2"
65803	PC611	1-1/2" x 1-1/2" x 1-1/4"
65812	PC611	2" x 1-1/2" x 1-1/2"
65815	PC611	2" x 2" x 1"
65817	PC611	2" x 2" x 1-1/2"
65804	PC611	2"
65846	PC611	3" x 3" x 1/2"
65847	PC611	3" x 3" x 3/4"
65848	PC611	3" x 3" x 1"
65850	PC611	3" x 3" x 1-1/2"
65851	PC611	3" x 3" x 2"
65852	PC611	3" x 3" x 2-1/2"

Copper Press Fittings

Tee (P x P x FPT)



Part #	Model #	Size
65869	PC612	1" x 1" x 3/4"
65870	PC612	1-1/4" x 1" x 1"
65872	PC612	1-1/2" x 1-1/2" x 3/4"

Union - Lead-Free (P x MPT)



Part #	Model #	Size
65926	PC633-4	3/4"
65928	PC633-4	1-1/4"
65929	PC633-4	1-1/2"
65930	PC633-4	2"

Tee - Lead-Free (P x P x FPT)



Part #	Model #	Size
65908	PC612	1/2"
65909	PC612	3/4" x 3/4" x 1/2"
65871	PC612	1-1/4" x 1-1/4" x 3/4"
65911	PC612	1-1/2" x 1-1/2" x 1/2"

Tee (P x P x FPT)



Part #	Model #	Size
65910	PC712	1" x 1" x 1/2"

Union (Press)



Part #	Model #	Size
65914	PC733	3/4"
65915	PC733	1"

Tube Cap (Press)



Part #	Model #	Size
65880	PC617	1/2"
65881	PC617	3/4"
65882	PC617	1"
65883	PC617	1-1/4"
65884	PC617	1-1/2"
65885	PC617	2"
65887	PC617	3"

Union (P x MPT)



Part #	Model #	Size
65927	PC733-4	1"

Union - Lead-Free (Press)



Part #	Model #	Size
65913	PC633	1/2"
65916	PC633	1-1/4"
65917	PC633	1-1/2"
65918	PC633	2"

EPDM Seal

Part #	Model #	Size
66026	T048052	1/2"
66028	T048056	1"
66029	T048058	1-1/4"
66030	T048060	1-1/2"
66031	T048062	2"
66025	T048064	2-1/2"
66034	T048066	3"
66036	T048070	4"

Copper Press Fittings

Press System® Valves

Press System® Bronze Swing Check Valve

- Press x press female end
- Horizontal swing, regrinding type
- Y-Pattern, renewable seat and disc
- 200 psi Non-shock cold working pressure
- Maximum operating temperature: 250°F



Part #	Model #	Size
65946	PS413Y	3/4"
65961	PF413Y	1"
65962	PF413Y	1-1/4"
65943	PS413Y	1-1/2"
65963	PF413Y	1-1/2"
65942	PS413Y	2"

Press System® Bronze Ball Valve

- 2-Piece body, press by press female end
- Full port
- Bronze trim
- Dezincification resistant
- Blowout-proof stem
- 600 psi Non-shock cold working pressure
- 250°F Maximum operating temperature



Part #	Model #	Size
65939	PFFP600	1/2"
65940	PFFP600	3/4"
65935	PFFP600	1"
65938	PFFP600	1-1/4"
65937	PFFP600	1-1/2"
65936	PFFP600	2"

Press System® Tools

PC-200M Mini Pressing Tool Kit with Jaws

- Includes:
 - Pressing tool
 - (3) Jaws
 - (2) 18V 1.3 Ah Lithium-ion batteries
 - 110V Battery charger and case



Part #	Model #	Description
69186	PC200M	Mini Pressing Tool Kit & Jaws

Press Rental Tool

- See your local branch



Part #	Model #	Description
73515	RENTALTOOL	Press Tool Rental



PVC Pipe



A MUNCH'S SUPPLY COMPANY

PVC Pipe & Fittings

PVC DWV Sch 40 Pipe



PVC DWV Sch 40 Plain End Pipe

Part #	Size
15448	3/4" x 10'
11947	1" x 10'
47789	2" x 10'
46824	3" x 10'
56777	4" x 10'

PVC DWV Sch 40 Foam Core Plain End Pipe

Part #	Size
11316	1-1/2" x 10'
6784	2" x 10'
1710	3" x 10'
15417	4" x 10'

PVC Condensate Pipe

Part #	Size
2303	3/4"x10'

PVC Sch 40 Fittings

PVC Sch 40 Tee (Slip Socket)



Part #	Model #	Size
7423	PPF-TEE-034	3/4"
8035	PPF-TEE-100	1"
5778	PVC-T-2	2"
5783	PVC-T-3	3"

PVC Sch 40 Reducing Tee (S x FPT)



Part #	Model #	Size
21791	PPF-T-R-3X3X34FPT	3" x 3/4"

PVC Sch 40 Reducing Tee (Slip Socket)

Part #	Model #	Size
90992	PPF-T-R-34X12	1" x 1" x 3/4"

PVC Sch 40 90° Elbow (Slip Socket)



Part #	Model #	Size
16582	PPF-90-012	1/2"
16803	PPF-90-034	3/4"
17444	PPF-90-100	1"
6257	PVC-90-2	2"
6274	PVC-90-3	3"
6283	PVC-90-4	4"

PVC Sch 40 Long Sweep 90° Elbow (Slip Socket)

Part #	Model #	Size
10081	PVC-90-2-LS	2"
10094	PVC-90-3-LS	3"
10098	PVC-90-4-LS	4"

PVC Sch 40 90° Elbow (S x FPT)



Part #	Model #	Size
18186	PPF-90F-034	3/4"

PVC Sch 40 90° Street Elbow (Spgt x S)



Part #	Model #	Size
11048	PPF-90S-012	1/2"
11226	PPF-90S-034	3/4"
11895	PPF-90S-100	1"
8225	PVC-90ST-2	2"
8236	PVC-90ST-3	3"
8247	PVC-90ST-4	4"



PVC Pipe & Fittings

PVC Sch 40 90° Long Sweep Street Elbow (Spgt x S)

Part #	Model #	Size
14830	PVC-90ST-2-LS	2"
14843	PVC-90ST-3-LS	3"
14855	PVC-90ST-4-LS	4"

PVC Sch 40 90° Street Elbow (MPT x S)



Part #	Model #	Size
14348	PPF-90M-034	3/4"

PVC Sch 40 45° Elbow (Slip Socket)



Part #	Model #	Size
1967	PPF-45-012	1/2"
2130	PPF-45-034	3/4"
2702	PPF-45-100	1"
7184	PVC-45-2	2"
7195	PVC-45-3	3"
7208	PVC-45-4	4"

PVC Sch 40 45° Street Elbow (Spgt x S)



Part #	Model #	Size
9083	PVC-45ST-2	2"
9093	PVC-45ST-3	3"
9096	PVC-45ST-4	4"

PVC Sch 40 Coupling (Slip Socket)



Part #	Model #	Size
10171	PPF-COUP-012	1/2"
10379	PPF-COUP-034	3/4"
10994	PPF-COUP-100	1"
7376	PVC-COUP-2	2"
7390	PVC-COUP-3	3"
7397	PVC-COUP-4	4"

PVC Sch 40 Reducer Coupling (Slip Socket)



Part #	Model #	Size
15907	PPF-COUP-34X12	3/4" x 1/2"
177292	PPF-COUP-R 212X2	2-1/2" x 2"
6733	PVC-COUP-R-3X2	3" x 2"
6745	PVC-COUP-R-4X2	4" x 2"

PVC Sch 40 Adapter (S x FPT)



Part #	Model #	Size
8799	PPF-FEM-034	3/4"

PVC Sch 40 Adapter (MPT x S)



Part #	Model #	Size
2035	PPF-MALE-034	3/4"
2571	PPF-MALE-100	1"

PVC Sch 40 Flush Style Reducer Bushing (Spgt x S)



Part #	Model #	Size
18473	PPF-BUSH-3412	3/4" x 1/2"
34213	PPF-BUSH-1X34	1" x 3/4"
16149	PVC-BUSH-3X2	3" x 2"
16254	PVC-BUSH-4X2	4" x 2"

PVC Sch 40 Cap (Slip Socket)



Part #	Model #	Size
12793	PPF-CAP-034	3/4"
3471	PVC-CAP-2	2"
3481	PVC-CAP-3	3"



PVC Fittings



A MUNCH'S SUPPLY COMPANY

PVC Pipe & Fittings

PVC Sch 40 Plug (MPT)



Part #	Model #	Size
8657	PPF-PLUG-034	3/4"

PVC Schedule 40 Unions

PVC Sch 40 Union with Buna-N O-Ring Seal (Slip Socket)

- Pressure: 150 psi @ 73°F



Part #	Model #	Size
123763	PPF-UNION-034	3/4"

PVC Solvent Weld Sewer Fittings

ASTM D 3034 SDR 35 & ASTM F 679

PVC Solvent Weld Cap (Hub)



Part #	Model #	Size
1637	SP-06-CAP	6"

PVC Sch 40 Pressure Fittings

PVC P-Trap (Slip)



Part #	Model #	Size
3630	PPF-PTRAP-034	3/4"

PVC Ball Valves

- For use with schedule 40 or 80 pipe
- Corrosion resistant
- Quarter turn operation
- Large ports for maximum flow
- Residential, commercial, or industrial fluid systems
- Wastewater, chemical, or agricultural applications

Sch 40 PVC Ball Valve (Solvent)

- White
- EPDM Seats and o-rings
- Flow rate: 150 psi
- NSF Approved



Part #	Model #	Size
26800	107-635	1"

Plumbing Specialties

Termination Screens



112002W



112003W

Part #	Model #	Description
82492	112002W	2", White PVC
82493	112003W	3", White PVC

PVC Polyethylene Pipe Insert Fittings

PVC Male Adapter (Ins x MPT)



Part #	Model #	Size
8382	POF-MA-034	3/4"

Flexible Couplings

Clay to CI or Plastic Flexible Coupling



Part #	Model #	Size
6242	FER66CC	6" x 6"

Cast Iron to Plastic Flexible Coupling



Part #	Model #	Size
13892	FER22	2" x 2"
13993	FER33	3" x 3"
14325	FER64	6" x 4"
14344	FER66	6" x 6"

Polyethylene Fusion Fittings

PE Fusion (Fus x FPT) Coupling with Female Adapter

Part #	Model #	Size
46506	POF-MR-1234	3/4" x 1/2"

Nylon Fittings

Nylon Elbow



Part #	Model #	Description
68233	TEA-2416	3/4" MPT x 1/2" Barb

Models and Specifications are Subject to Change Without Notice



CPVC Pipe & Fittings

CPVC Pipe CPVC CTS Pipe



Part #	Size
12959	3/4" x 10"

CPVC Fittings CPVC Male Adapter (Slip x MPT)



Part #	Model #	Size
17910	PCF-MA-034	3/4"
3311	PCF-MA-1	1"

CPVC Female Adapter (Slip x FPT)

• Includes washer



Part #	Model #	Size
16245	PCF-FA-034	3/4"

CPVC Coupling (Slip Socket)



Part #	Model #	Size
5487	PCF-CO-034	3/4"

CPVC 90° Elbow (Slip Socket)



Part #	Model #	Size
16446	PCF-90-012	1/2"
16643	PCF-90-034	3/4"

CPVC 90° Drop Ear Elbow (Slip x FPT)

• Includes washer



Part #	Model #	Size
13479	PCF-90DEF-012	1/2"

CPVC Tee (Slip Socket)



Part #	Model #	Size
13159	PCF-T-012	1/2"
13374	PCF-T-034	3/4"



Black Steel Pipe



Steel Pipe & Fittings

Black Steel Pipe

Black Steel Standard Weight Pipe - TBE



Part #	Model #	Size
2203	IBP-012X10FT	1/2" x 10'
1218	IBP-034X10FT	3/4" x 10'
16680	IBP-100X10FT	1" x 10'
15916	IBP-114X10FT	1-1/4" x 10'
16019	IBP-112X10FT	1-1/2" x 10'
11356	IBP-200X10FT	2" x 10'
45152	IBP-212X10FT	2-1/2" x 10'
40739	IBP-300X10FT	3" x 10'

Black Steel Domestic Pipe

Black Steel Standard Weight Pipe - TBE



Part #	Model #	Size
48016	IBPD-012X10FT	1/2" x 10'
48017	IBPD-100X10FT	1" x 10'



Black Fittings

Threaded Black Malleable Iron Fittings

Black Malleable Iron 150# Hex Bushing



Part #	Model #	Size
11116	IBF-BUSH-1218	1/2" x 1/8"
11083	IBF-BUSH-1214	1/2" x 1/4"
11304	IBF-BUSH-1238	1/2" x 3/8"
10019	IBF-BUSH-3418	3/4" x 1/8"
9977	IBF-BUSH-3414	3/4" x 1/4"
9948	IBF-BUSH-3412	3/4" x 1/2"
16052	IBF-BUSH-112	1" x 1/2"
16283	IBF-BUSH-134	1" x 3/4"
14240	IBF-BUSH-11412	1-1/4" x 1/2"
14477	IBF-BUSH-11434	1-1/4" x 3/4"
9342	IBF-BUSH-1141	1-1/4" x 1"
14362	IBF-BUSH-11212	1-1/2" x 1/2"
14615	IBF-BUSH-11234	1-1/2" x 3/4"
7448	IBF-BUSH-1121	1-1/2" x 1"
16998	IBF-BUSH-112114	1-1/2" x 1-1/4"
6394	IBF-BUSH-212	2" x 1/2"
6617	IBF-BUSH-234	2" x 3/4"
17291	IBF-BUSH-21	2" x 1"
9773	IBF-BUSH-2114	2" x 1-1/4"
9748	IBF-BUSH-2112	2" x 1-1/2"
2882	IBF-BUSH-212114	2-1/2" x 1-1/4"
2864	IBF-BUSH-212112	2-1/2" x 1-1/2"
6908	IBF-BUSH-2122	2-1/2" x 2"
9281	IBF-BUSH-3114	3" x 1-1/4"
18275	IBF-BUSH-32	3" x 2"
282	IBF-BUSH-42	4" x 2"
292	IBF-BUSH-43	4" x 3"

Black Malleable Iron 150# Cap



Part #	Model #	Size
14302	IBF-CAP-12	1/2"
14538	IBF-CAP-34	3/4"
1078	IBF-CAP-1	1"
9481	IBF-CAP-114	1-1/4"
9476	IBF-CAP-112	1-1/2"
1086	IBF-CAP-2	2"
133167	IBF-CAP-3	3"

Black Malleable Iron 150# RH Coupling



Part #	Model #	Size
13923	IBF-COUP-12	1/2"
14139	IBF-COUP-34	3/4"
10976	IBF-COUP-1	1"
18322	IBF-COUP-114	1-1/4"
18299	IBF-COUP-112	1-1/2"
10992	IBF-COUP-2	2"
304	IBF-COUP-212	2-1/2"
11016	IBF-COUP-4	4"

Black Malleable Iron 150# 45° Elbow



Part #	Model #	Size
14576	IBF-45-12	1/2"
14821	IBF-45-34	3/4"
6196	IBF-45-1	1"
18816	IBF-45-114	1-1/4"
18792	IBF-45-112	1-1/2"
6203	IBF-45-2	2"
133166	IBF-45-3	3"

Black Malleable Iron 150# 45° Street Elbow



Part #	Model #	Size
17537	IBF-45ST-12	1/2"
17745	IBF-45ST-34	3/4"
11303	IBF-45ST-1	1"
14087	IBF-45ST-114	1-1/4"



Black Malleable Iron Fittings



A MUNCH'S SUPPLY COMPANY

Black Fittings

Black Malleable Iron 150# 90° Elbow



Part #	Model #	Size
45386	IBF-90-12	1/2"
2944	IBF-90-34	3/4"
10714	IBF-90-1	1"
14207	IBF-90-114	1-1/4"
14181	IBF-90-112	1-1/2"
10722	IBF-90-2	2"
15203	IBF-90-212	2-1/2"
10733	IBF-90-3	3"

Black Malleable Iron 150# Square Head Plug - Solid



Part #	Model #	Size
10037	IBF-PLUG-12	1/2"
10228	IBF-PLUG-34	3/4"
12439	IBF-PLUG-1	1"
16480	IBF-PLUG-114	1-1/4"
16468	IBF-PLUG-112	1-1/2"
12456	IBF-PLUG-2	2"
57585	IBF-PLUG-4	4"

Black Malleable Iron 150# 90° Reducing Elbow



Part #	Model #	Size
4362	IBF-90R-3412	3/4" x 1/2"
17991	IBF-90R-112	1" x 1/2"
18225	IBF-90R-134	1" x 3/4"
17671	IBF-90R-11412	1-1/4" x 1/2"
17883	IBF-90R-11434	1-1/4" x 3/4"
3772	IBF-90R-1141	1-1/4" x 1"
1960	IBF-90R-1121	1-1/2" x 1"
11135	IBF-90R-112114	1-1/2" x 1-1/4"
4190	IBF-90R-2114	2" x 1-1/4"
4175	IBF-90R-2112	2" x 1-1/2"

Black Malleable Iron 150# Reducing Coupling



Part #	Model #	Size
12842	IBF-COUP-R-1238	1/2" x 3/8"
11513	IBF-COUP-R-3412	3/4" x 1/2"
11983	IBF-COUP-R-112	1" x 1/2"
12184	IBF-COUP-R-134	1" x 3/4"
7259	IBF-COUP-R-11412	1-1/4" x 1/2"
7434	IBF-COUP-R-11434	1-1/4" x 3/4"
10846	IBF-COUP-R-1141	1-1/4" x 1"
5326	IBF-COUP-R-11212	1-1/2" x 1/2"
5526	IBF-COUP-R-11234	1-1/2" x 3/4"
9036	IBF-COUP-R-1121	1-1/2" x 1"
5341	IBF-COUP-R-112114	1-1/2" x 1-1/4"
2672	IBF-COUP-R-234	2" x 3/4"
17932	IBF-COUP-R-21	2" x 1"
11305	IBF-COUP-R-2114	2" x 1-1/4"
11278	IBF-COUP-R-2112	2" x 1-1/2"
4755	IBF-COUP-R-212112	2-1/2" x 1-1/2"
37624	IBF-COUP-R-2122	2-1/2" x 2"
10801	IBF-COUP-R-3114	3" x 1-1/4"
18920	IBF-COUP-R-32	3" x 2"

Black Malleable Iron 150# 90° Street Elbow



Part #	Model #	Size
11551	IBF-90ST-12	1/2"
11776	IBF-90ST-34	3/4"
6961	IBF-90ST-1	1"
12706	IBF-90ST-114	1-1/4"
12683	IBF-90ST-112	1-1/2"
6978	IBF-90ST-2	2"



Black Fittings

Black Malleable Iron 150# Tee



Part #	Model #	Size
16487	IBF-T-12	1/2"
16702	IBF-T-34	3/4"
3291	IBF-T-1	1"
2224	IBF-T-114	1-1/4"
2214	IBF-T-112	1-1/2"
3300	IBF-T-2	2"
3098	IBF-T-212	2-1/2"
3307	IBF-T-3	3"

Black Malleable Iron 150# Reducing Run/Outlet Tee



Part #	Model #	Size
8214	IBF-T-R-341212	3/4" x 1/2" x 1/2"
8590	IBF-T-R-11212	1" x 1/2" x 1/2"
7428	IBF-T-R-13412	1" x 3/4" x 1/2"
7647	IBF-T-R-13434	1" x 3/4" x 3/4"
14228	IBF-T-R-1143434	1-1/4" x 3/4" x 3/4"
11683	IBF-T-R-114341	1-1/4" x 3/4" x 1"
9724	IBF-T-R-114134	1-1/4" x 1" x 3/4"
2305	IBF-T-R-11411	1-1/4" x 1" x 1"

Black Malleable Iron 150# Reducing Run Tee



Part #	Model #	Size
8418	IBF-T-R-341234	3/4" x 1/2" x 3/4"
14654	IBF-T-R-1121	1" x 1/2" x 1"
16860	IBF-T-R-1341	1" x 3/4" x 1"
14691	IBF-T-R-11412114	1-1/4" x 1/2" x 1-1/4"
13490	IBF-T-R-11434114	1-1/4" x 3/4" x 1-1/4"
5245	IBF-T-R-1141114	1-1/4" x 1" x 1-1/4"
32507	IBF-T-R-11234112	1-1/2" x 3/4" x 1-1/2"

Black Malleable Iron 150# Reducing Outlet Tee



Part #	Model #	Size
9968	IBF-T-R-343412	3/4" x 3/4" x 1/2"
13335	IBF-T-R-1112	1" x 1" x 1/2"
17109	IBF-T-R-1134	1" x 1" x 3/4"
8074	IBF-T-R-11411412	1-1/4" x 1-1/4" x 1/2"
8298	IBF-T-R-11411434	1-1/4" x 1-1/4" x 3/4"
11615	IBF-T-R-1141141	1-1/4" x 1-1/4" x 1"
16666	IBF-T-R-11211212	1-1/2" x 1-1/2" x 1/2"
16909	IBF-T-R-11211234	1-1/2" x 1-1/2" x 3/4"
12401	IBF-T-R-1121121	1-1/2" x 1-1/2" x 1"
16657	IBF-T-R-112112114	1-1/2" x 1-1/2" x 1-1/4"
2079	IBF-T-R-2212	2" x 2" x 1/2"
2261	IBF-T-R-2234	2" x 2" x 3/4"
11002	IBF-T-R-221	2" x 2" x 1"
12208	IBF-T-R-22114	2" x 2" x 1-1/4"
12200	IBF-T-R-22112	2" x 2" x 1-1/2"

Black Malleable Iron 150# Bull Tee



Part #	Model #	Size
15779	IBF-T-R-1234	1/2" x 1/2" x 3/4"

Black Malleable Iron Unions

Black Malleable Iron 150# Brass Seat Union



Part #	Model #	Size
9913	IBF-UNION-212	2-1/2"



Black Malleable Iron Fittings



Black Fittings

Black Malleable Iron 150# All Iron Union



Part #	Model #	Size
17556	IBF-UNION-12	1/2"
17761	IBF-UNION-34	3/4"
4392	IBF-UNION-1	1"
9050	IBF-UNION-114	1-1/4"
9029	IBF-UNION-112	1-1/2"
4404	IBF-UNION-2	2"

Domestic Black Malleable Iron 150# Reducing Run/Outlet Tee



Part #	Size
48021	1" x 1/2" x 1/2"

Domestic Black Malleable Iron 150# Reducing Run Tee



Part #	Size
48022	1" x 1/2" x 1"

Domestic Black Malleable Iron 150# Reducing Outlet Tee



Part #	Size
48019	1" x 1" x 1/2"

Domestic Black Malleable Iron Unions Domestic Black Malleable Iron 150# All Iron Union



Part #	Size
48030	1/2"
48023	1"

Domestic Threaded Black Malleable Iron Fittings

Domestic Black Malleable Iron 150# 90° Elbow



Part #	Size
48028	1/2"
48025	1"
88134	1-1/4"

Domestic Black Malleable Iron 150# 90° Street Elbow



Part #	Size
48029	1/2"

Domestic Black Malleable Iron 150# Tee



Part #	Size
48027	1/2"
48018	1"



Black Nipples

Black Malleable Iron Pipe Nipples



3/8" Black Malleable Iron Nipple

Part #	Model #	Size
15784	IBN38XCL	3/8" x Close
14380	IBN38X2	3/8" x 2"
15033	IBN38X212	3/8" x 2-1/2"

3/4" Black Malleable Iron Nipple

Part #	Model #	Size
15998	IBN34XCL	3/4" x Close
16258	IBN34X112	3/4" x 1-1/2"
10619	IBN34X2	3/4" x 2"
17239	IBN34X212	3/4" x 2-1/2"
10630	IBN34X3	3/4" x 3"
18203	IBN34X312	3/4" x 3-1/2"
10637	IBN34X4	3/4" x 4"
226	IBN34X412	3/4" x 4-1/2"
10645	IBN34X5	3/4" x 5"
1164	IBN34X512	3/4" x 5-1/2"
10655	IBN34X6	3/4" x 6"
10665	IBN34X7	3/4" x 7"
10674	IBN34X8	3/4" x 8"
10686	IBN34X9	3/4" x 9"
13880	IBN34X10	3/4" x 10"
13893	IBN34X11	3/4" x 11"
13905	IBN34X12	3/4" x 12"
13959	IBN34X18	3/4" x 18"
14009	IBN34X24	3/4" x 24"
14076	IBN34X30	3/4" x 30"
14140	IBN34X36	3/4" x 36"
14268	IBN34X48	3/4" x 48"
14390	IBN34X60	3/4" x 60"

1" Black Malleable Iron Nipple

Part #	Model #	Size
5027	IBN1XCL	1" x Close
17292	IBN1X2	1" x 2"
15263	IBN1X212	1" x 2-1/2"
17307	IBN1X3	1" x 3"
16290	IBN1X312	1" x 3-1/2"
17314	IBN1X4	1" x 4"
17276	IBN1X412	1" x 4-1/2"
17323	IBN1X5	1" x 5"
18249	IBN1X512	1" x 5-1/2"
17335	IBN1X6	1" x 6"
17342	IBN1X7	1" x 7"
17349	IBN1X8	1" x 8"
17358	IBN1X9	1" x 9"
3047	IBN1X10	1" x 10"
3061	IBN1X11	1" x 11"
3071	IBN1X12	1" x 12"
3142	IBN1X18	1" x 18"
3198	IBN1X24	1" x 24"
3252	IBN1X30	1" x 30"
3323	IBN1X36	1" x 36"
3436	IBN1X48	1" x 48"
3552	IBN1X60	1" x 60"

1/2" Black Malleable Iron Nipple

Part #	Model #	Size
17206	IBN12XCL	1/2" x Close
8638	IBN12X112	1/2" x 1-1/2"
8925	IBN12X2	1/2" x 2"
9540	IBN12X212	1/2" x 2-1/2"
8937	IBN12X3	1/2" x 3"
10486	IBN12X312	1/2" x 3-1/2"
8950	IBN12X4	1/2" x 4"
11407	IBN12X412	1/2" x 4-1/2"
8957	IBN12X5	1/2" x 5"
12307	IBN12X512	1/2" x 5-1/2"
8968	IBN12X6	1/2" x 6"
8977	IBN12X7	1/2" x 7"
8985	IBN12X8	1/2" x 8"
8995	IBN12X9	1/2" x 9"
15108	IBN12X10	1/2" x 10"
15114	IBN12X11	1/2" x 11"
15122	IBN12X12	1/2" x 12"
15186	IBN12X18	1/2" x 18"
15252	IBN12X24	1/2" x 24"
15316	IBN12X30	1/2" x 30"
15390	IBN12X36	1/2" x 36"
15541	IBN12X48	1/2" x 48"
15658	IBN12X60	1/2" x 60"



Black Malleable Iron Fittings



A MUNCH'S SUPPLY COMPANY

Black Nipples

1-1/4" Black Malleable Iron Nipple 2" Black Malleable Iron Nipple

Part #	Model #	Size
11777	IBN114XCL	1-1/4" x Close
13262	IBN114X2	1-1/4" x 2"
9970	IBN114X212	1-1/4" x 2-1/2"
13270	IBN114X3	1-1/4" x 3"
10878	IBN114X312	1-1/4" x 3-1/2"
13282	IBN114X4	1-1/4" x 4"
11851	IBN114X412	1-1/4" x 4-1/2"
13297	IBN114X5	1-1/4" x 5"
12723	IBN114X512	1-1/4" x 5-1/2"
13307	IBN114X6	1-1/4" x 6"
13313	IBN114X7	1-1/4" x 7"
13328	IBN114X8	1-1/4" x 8"
13337	IBN114X9	1-1/4" x 9"
9805	IBN114X10	1-1/4" x 10"
9816	IBN114X11	1-1/4" x 11"
9827	IBN114X12	1-1/4" x 12"
9869	IBN114X18	1-1/4" x 18"
9944	IBN114X24	1-1/4" x 24"
10009	IBN114X30	1-1/4" x 30"
10058	IBN114X36	1-1/4" x 36"
10160	IBN114X48	1-1/4" x 48"
10277	IBN114X60	1-1/4" x 60"

Part #	Model #	Size
14432	IBN2XCL	2" x Close
14741	IBN2X212	2" x 2-1/2"
18278	IBN2X3	2" x 3"
15746	IBN2X312	2" x 3-1/2"
18286	IBN2X4	2" x 4"
16731	IBN2X412	2" x 4-1/2"
18300	IBN2X5	2" x 5"
17700	IBN2X512	2" x 5-1/2"
18311	IBN2X6	2" x 6"
18323	IBN2X7	2" x 7"
18328	IBN2X8	2" x 8"
18339	IBN2X9	2" x 9"
12457	IBN2X10	2" x 10"
12464	IBN2X11	2" x 11"
12473	IBN2X12	2" x 12"
12530	IBN2X18	2" x 18"
12581	IBN2X24	2" x 24"
12685	IBN2X36	2" x 36"
12814	IBN2X48	2" x 48"
12912	IBN2X60	2" x 60"

4" Black Malleable Iron Nipple

Part #	Model #	Size
35155	IBN4XCL	4" x Close
1231	IBN4X4	4" x 4"
1241	IBN4X5	4" x 5"

Black Steel Nipple Sets

Assorted Black Steel Nipple Set



Part #	Model #	Size	Qty
1198	NIPPACK-012B	1/2"	66-Piece
3040	NIPPACK-034B	3/4"	66-Piece
9325	NIPPACK-100B	1"	66-Piece
10589	NIPPACK-114B	1-1/4"	60-Piece
18902	NIPPACK-200B	2"	25-Piece

Nipple Tote Trays

- Rugged steel construction
- Holds nipple sizes of close through 6"
- Fold away handle
- Steel dividers
- Individually boxed trays



Part #	Size	Qty
15989	1/2"	77 Nipples
17962	3/4"	66 Nipples

1-1/2" Black Malleable Iron Nipple

Part #	Model #	Size
11875	IBN112XCL	1-1/2" x Close
11454	IBN112X2	1-1/2" x 2"
10977	IBN112X212	1-1/2" x 2-1/2"
11464	IBN112X3	1-1/2" x 3"
11927	IBN112X312	1-1/2" x 3-1/2"
11478	IBN112X4	1-1/2" x 4"
12827	IBN112X412	1-1/2" x 4-1/2"
11489	IBN112X5	1-1/2" x 5"
13747	IBN112X512	1-1/2" x 5-1/2"
11501	IBN112X6	1-1/2" x 6"
11509	IBN112X7	1-1/2" x 7"
11519	IBN112X8	1-1/2" x 8"
11525	IBN112X9	1-1/2" x 9"
9901	IBN112X10	1-1/2" x 10"
9915	IBN112X11	1-1/2" x 11"
9927	IBN112X12	1-1/2" x 12"
10051	IBN112X24	1-1/2" x 24"
10150	IBN112X36	1-1/2" x 36"
10265	IBN112X48	1-1/2" x 48"
10384	IBN112X60	1-1/2" x 60"

2-1/2" Black Malleable Iron Nipple

Part #	Model #	Size
6670	IBN212XCL	2-1/2" x Close
10924	IBN212X3	2-1/2" x 3"
10931	IBN212X4	2-1/2" x 4"
18056	IBN212X412	2-1/2" x 4-1/2"
10939	IBN212X5	2-1/2" x 5"
102	IBN212X512	2-1/2" x 5-1/2"
10955	IBN212X6	2-1/2" x 6"
4699	IBN212X10	2-1/2" x 10"
4719	IBN212X12	2-1/2" x 12"

3" Black Malleable Iron Nipple

Part #	Model #	Size
4894	IBN3XCL	3" x Close
285	IBN3X3	3" x 3"
295	IBN3X4	3" x 4"
16190	IBN3X412	3" x 4-1/2"
309	IBN3X5	3" x 5"
328	IBN3X6	3" x 6"
2961	IBN3X12	3" x 12"

Models and Specifications are Subject to Change Without Notice



Galvanized Fittings

Galvanized Malleable Iron Fittings

Galv Malleable Iron Threaded 150# Hex Bushing



Part #	Model #	Size
8887	IGF-BUSH-3412	3/4" x 1/2"

Galv Malleable Iron Threaded 150# Cap



Part #	Model #	Size
5485	IGF-CAP-34	3/4"
11674	IGF-CAP-112	1-1/2"

Galv Malleable Iron Threaded 150# Coupling



Part #	Model #	Size
16528	IGF-COUP-34	3/4"

Galv Malleable Iron Threaded 150# 45° Elbow



Part #	Model #	Size
806	IGF-45-34	3/4"

Galv Malleable Iron Threaded 150# 90° Elbow



Part #	Model #	Size
7574	IGF-90-12	1/2"
7799	IGF-90-34	3/4"

Galv Malleable Iron Threaded 150# Square Head Solid Plug



Part #	Model #	Size
12212	IGF-PLUG-12	1/2"
12393	IGF-PLUG-34	3/4"
16170	IGF-PLUG-112	1-1/2"
3423	IGF-PLUG-2	2"

Galv Malleable Iron Threaded 150# Reducer



Part #	Model #	Size
14881	IGF-COUP-R-3412	3/4" x 1/2"
7928	IGF-COUP-R-134	1" x 3/4"

Galv Malleable Iron Threaded 150# Tee



Part #	Model #	Size
3784	IGF-T-34	3/4"

Galvanized Malleable Iron Unions

Galv Malleable Iron Threaded 150# Ground Joint All Iron Union



Part #	Model #	Size
17280	IGF-UNION-12	1/2"
17492	IGF-UNION-34	3/4"



Brass Valves & Fittings



A MUNCH'S SUPPLY COMPANY

Galvanized Nipples/Brass Valves & Fittings

Galvanized Steel Nipple Packs

Galv Steel Assorted Nipple Pack

• (66) Pieces



Part #	Model #	Size
3095	NIPPACK-034G	3/4"

Galvanized Malleable Iron Pipe Nipples

1/2" Galv Malleable Iron Nipple



Part #	Model #	Size
1984	IGN12X2	1/2" x 2"
14269	IGN12X212	1/2" x 2-1/2"
1993	IGN12X3	1/2" x 3"
15287	IGN12X312	1/2" x 3-1/2"
16313	IGN12X412	1/2" x 4-1/2"

3/4" Galv Malleable Iron Nipple

Part #	Model #	Size
3111	IGN34XCL	3/4" x Close
2040	IGN34X112	3/4" x 1-1/2"
3676	IGN34X2	3/4" x 2"
2885	IGN34X212	3/4" x 2-1/2"
3690	IGN34X3	3/4" x 3"
3842	IGN34X312	3/4" x 3-1/2"
3698	IGN34X4	3/4" x 4"
4759	IGN34X412	3/4" x 4-1/2"
3715	IGN34X5	3/4" x 5"
5734	IGN34X512	3/4" x 5-1/2"
3726	IGN34X6	3/4" x 6"
3739	IGN34X7	3/4" x 7"
3747	IGN34X8	3/4" x 8"
3759	IGN34X9	3/4" x 9"
1342	IGN34X10	3/4" x 10"
1357	IGN34X12	3/4" x 12"

1" Galv Malleable Iron Nipple

Part #	Model #	Size
2438	IGN1X212	1" x 2-1/2"
14549	IGN1X3	1" x 3"
3385	IGN1X312	1" x 3-1/2"

Brass Flare Fittings

Brass Flare Short Nut



Part #	Model #	Size
129820	BRC-ANS4C	1/4"
129819	BRC-ANS4E	3/8"
129822	BRC-ANS4F	1/2"
129821	BRC-ANS4I	5/8"



MONTE AND ASSOCIATES, INC.

Tubing

Copper Tube Extensions with 1/4" Service Valve

• Length: 2"

Part #	Model #	Size
90814	AF1000	1/8" OD
90815	AF1100	3/16" OD
90816	AF1200	1/4" OD
90817	AF1300	5/16" OD
90818	AF1400	3/8" OD

Brass 45° Flare Fittings

- Smooth interior finish provides unrestricted flow and reduced pressure drop
- Maximum working pressure: 700 psig, 48 bar
- Conforms to:
 - Refrigeration Fitting Standards SAE J5 13
 - Military Standards MS-35867 through MS35873 inclusive, MS-35919, MS35925, MS16993
- Made in USA



Brass Bushing (NPTE x NPTI)

- External pipe thread to internal pipe thread



Part #	Model #	Universal #	Size
937	A 00633	R1-ED	3/4" x 1/2"

Models and Specifications are Subject to Change Without Notice



Valves & Fittings

Brass Ball Valves



Full Port 600 PSI Threaded Ball Valve

Part #	Model #	Size
18749	VALBAL-12T	1/2" IPS
34	VALBAL-34T	3/4" IPS
17432	VALBAL-1T	1" IPS
4137	VALBAL-114T	1-1/4" IPS
756	VALBAL-112T	1-1/2" IPS
17447	VALBAL-2T	2" IPS

Full Port 600 PSI Solder Ball Valve

Part #	Model #	Size
14113	VALBAL-12S	1/2" CxC
16375	VALBAL-34S	3/4" CxC
1505	VALBAL-1S	1" CxC
1251	VALBAL-114S	1-1/4" CxC
4604	VALBAL-112S	1-1/2" CxC
1586	VALBAL-2S	2" CxC

Drain Valves

- Brass with cast iron handle
- Heavy construction
- 3/4" Hose thread outlet

Male Boiler Drain Valve

Part #	Model #	Size
3415	VALBO1-12	1/2"
3619	VALBO1-34	3/4"

Female Boiler Drain Valve

Part #	Model #	Size
7753	VALBO1-34F	3/4"

Check Valves

Threaded Swing Check Valve

- Brass
- Non-shock WOG: 150 psi

Part #	Model #	Size
10617	VALSW1-34T	3/4"
4475	VALSW1-1T	1"
11381	VALSW1-114T	1-1/4"

Swing Check Valve (Solder)

- Brass
- Non-shock WOG: 150 psi

Part #	Model #	Size
8707	VALSW1-12S	1/2"
10699	VALSW1-34S	3/4"
6198	VALSW1-1S	1"
40477	VALSW1-114S	1-1/4"

ProLine® Gas Valves

7701G Gas Ball Valve (FPT x FPT)

- 1-Piece body, forged brass
- 1/4-Turn lever handle
- Coated aluminum handle
- Multi-directional flow
- Chrome-plated brass ball
- 200 psi
- Temperature range: -20° to 300°F
- UL Listed



Part #	Model #	Size
2191	VALGAS-012	1/2"
2363	VALGAS-034	3/4"

Preformed Brass Valve Tees

No Lead Add-A-Line™ Full-Slip Valve Tee (Trunk x Tee)

- For adding humidifiers, dishwashers, ice makers, or any new water line
- 1-Piece forged brass compression and sweat tee body
- 5/8" or 7/8" OD Compression trunks provide easy and totally torchless installations
- 1/2" or 3/4" Full-slip sweat trunks
- Quality brass ball valve replaces saddle valves



Part #	Model #	Connections
75589	601-G20CV	5/8" OD Comp x 1/4" OD Comp
64215	601-G30CV	7/8" OD Comp x 1/4" OD Comp

Gas Connectors, Pipe & Fittings

Yellow Epoxy Coated SS Gas Connectors

- Approved for use with natural, manufactured, LP (propane), and LP air mixture gases with internal line pressure no greater than 1/2 psi (3.5kPa)
- Durable 304 stainless steel (ASTM A240)
- Neck-free design for maximum bending flexibility
- 100% Leak tested for quality assurance
- High quality 45° flare fittings (SAE J512)
- Rated operating temperature: -40° to 150°F
- CSA Design certified for indoor and outdoor use



Yellow Epoxy-Coated Stainless Steel Gas Appliance Connector

Part #	Length	Description
67699	24"	1/2" MIP x 1/2" FIP
67702	36"	1/2" MIP x 1/2" FIP
67703	48"	1/2" MIP x 1/2" FIP
67704	60"	1/2" MIP x 1/2" FIP
67705	36"	3/4" MIP x 3/4" FIP
67707	48"	3/4" MIP x 3/4" FIP

Stainless Steel Water Connectors Water Heater Connector

- Stainless steel stainless steel (ASTM A240)



Part #	Length	Description
67709	12"	3/4" FIP x 3/4" FIP
67710	18"	3/4" FIP x 3/4" FIP

OmegaFlex

Part #	Model #	Description
187436	FGP-CS-500-100	CounterStrike 1/2"x100' Reel
187443	FGP-CS-100-50	CounterStrike 1/2"x100' Reel
187451	FGP-SFST-500	AutoSnap Straight 1/2"
187453	FGP-SFST-1000	AutoSnap Straight 1"
187487	FGP-FST-500	AutoFlare Straight 1/2"
187508	FGP-CPLG-500	Coupling - 1/2"
187510	FGP-CPLG-1000	Coupling - 1"
187515	FGP-BFF-500	Flange Fitting 1/2"
187594	FGP-WBTM-500	Metal Wallbox w/valve 1/2"
187656	FGP-SP-025	Quarter Striker Plate
187657	FGP-SP-050	Half Striker Plate
187659	FGP-SP-100	Full Striker Plate

Underground Gas Piping System

- Yellow
- For underground use
- ASTM D2513/D1248
- ANSI b31.8

Yellow Polyethylene Gas Piping

Part #	Description
17464	3/4" x 150' Roll
9323	1" x 150' Roll
5962	1-1/4" x 150' Roll

Polyethylene Gas Piping Male Adapter

- Protects poly gas piping when transitioning from underground to above ground



Part #	Description
7914	3/4" Compression x 3/4" MIP
10988	1" Compression x 3/4" MIP
6356	1-1/4" Compression x 3/4" MIP

Polyethylene Gas Piping Repair Coupling

Part #	Description
2999	3/4" Repair Coupling
6695	1" Repair Coupling
14864	1-1/4" Repair Coupling

Electrical Conduit & Fittings

EMT Thin Wall Conduit



Part #	Description
8322	1/2" x 10'
8537	3/4" x 10'



Greenfield Flexible Metal Conduit

Reduced Wall Aluminum Flexible Metal Conduit

- Premium aluminum alloy
- Interlocking design



Part #	Description
5517	3/8" x 25' Aluminium
5740	3/8" x 50' Aluminium
952	1/2" x 100' Aluminium
176667	1/2" x 25' Steel

BX Armored Electrical Cable



Part #	Description	Wire	Length
5704	BX Cable	14-2	50'
5922	BX Cable	14-2	50'
5173	BX Cable	14-3	25'
5432	BX Cable	14-3	50'
16429	BX Cable	12-2	50'

Non-Metallic Liquidtight Conduit

Part #	Description
11807	1/2" x 100'
585	3/4" x 100'



EMT Set Screw Connector

EMT Set Screw Connector

- Zinc die-cast
- Concrete tight
- UL Listed; CSA Certified



Part #	Description
8032	1/2"
8048	3/4"

EMT Set Screw Coupling

- Zinc die-cast
- Concrete tight
- UL Listed; CSA Certified



Part #	Description
7538	1/2"
7555	3/4"

EMT Compression Connector

- Zinc die-cast
- Concrete tight
- UL Listed; CSA Certified



Part #	Description
7626	1/2"
15412	3/4"

EMT Compression Coupling

- Zinc die-cast
- Concrete tight
- UL Listed; CSA Certified



Part #	Description
15267	1/2"
15297	3/4"

Combination Pulling Elbow (Set Screw And Threaded)

- Zinc die-cast
- Combination threaded rigid and set-screw EMT to box
- EMT to Flex



Part #	Description
55740	1/2"
176669	1/2" Squeeze Type Greenfield Style Connector

Electrical Conduit & Fittings

Rubber Cord to Box Connector with Strain Relief

- Non-metallic, liquid tight, and oil tight
- Cord range: .100" to .300"
- Includes sealing ring and locknut
- CSA Certified
- UL Listed (UL not applicable for under .240" wire diameter)



Part #	Description	Knockout
3175	Liquid-tight Cord to Box Connector	1/2"

BX Straight Connector

- Zinc die-cast
- For steel only
- UL Listed; CSA Certified



Part #	Description	Knockout
19222	Connects 3/8" BX to Box	1/2"

BX 90 Elbow Connector

- Zinc die-cast
- For aluminum and steel
- Flex-AC-MC cable
- Concrete tight when taped
- UL Listed; CSA Certified



Part #	Description	Knockout
16071	Connects 3/8" BX to Box	1/2"

Insulated Metal Grounding Bushing

- Zinc die-cast
- Includes dual rated
- CU-AI C clamp grounding lug



Part #	Description
74346	1/2" Bushing w/ Ground Lug

Rigid Conduit Nipple

- Zinc die-cast



Part #	Description
1679	1/2" Chase Nipple

Rigid Conduit Lock Nut

- Plated steel



Part #	Description
5342	1/2" Die Cast Lock Nut
5540	3/4" Die Cast Lock Nut

Liquidtight Conduit Straight Connector

Straight Zinc Die-Cast Connector



Part #	Description	Knockout
3561	1/2" Liquidtight Connector	1/2"
3795	3/4" Liquidtight Connector	3/4"

Liquidtight Conduit 90° Elbow Connector



Part #	Description	Knockout
19095	1/2" Liquidtight Connector	1/2"
19238	3/4" Liquidtight Connector	3/4"

Switches and Receptacles

Single Pole Switch

- Quickwire push-in and side-wired toggle switch
- Quickwire accepts conductors up to #14 AWG
- Side-wire accepts conductors up to #12 AWG
- Thermoplastic toggle and frame
- Large head triple-drive combination screws
- UL Listed
- CSA Certified
- 2-Year limited warranty

1-Pole Framed Toggle - 15A, 120VAC - Non-Grounding

- 12A Maximum
- 1/2 hp, 120V



Part #	Model #	Description
10789	LEV1451-I	SP Switch Ivory 15A 120V

Receptacle

- UL Listed
- 2-Year limited warranty

Duplex Receptacle with Ears - 2-Pole 3-Wire - 15A/125V - Grounding

- Straight blade
- Thermoplastic
- NEMA 5-15R
- Quickwire push-in and side wired



Part #	Model #	Description
18422	LEV5320-I	Duplex Recept Ivory 15A 120V

Ground Fault Receptacle



Part #	Model #	Description
184246	LEVGF TR2-HFW	GFI Duplex Recept White 20A 120V
175544	LEVGFTR2-I	GFI Duplex Recept Ivory 20A 120V

Ground Fault Receptacle with Switch



Part #	Description
176186	GFI Recept w/ Switch 15A 125V



Electrical Boxes

- Used in the installation of ceiling or wall lighting fixtures, switches, or receptacles
- Used where multiple conductor runs are split into two or more directions
- Combination screw heads
- Per UL 514A, suitable for use without bonding jumper in circuits above or below 250 volts

4" Square Box

- Steel
- 1-1/2" Depth
- Max static fixture support load: 50 lbs
- Welded with conduit knockouts



Part #	Model #	Description
16108	189	(8) 1/2" (4) TKO Side (2) 1/2" & (2) TKO Btm KOs

4" Square Box Extension Ring

- 1-1/2" Depth
- Drawn-in conduit knockouts



Part #	Model #	Description
16235	201	(12) 1/2" KOs

Electrical Boxes

Handy/Utility Boxes

4" Handy/Utility Box for Conduit

- Used for convenience outlets, switch boxes, or small junction boxes
- Steel
- 1-7/8" Depth
- Drawn-in conduit knockouts
- Popular for exposed work applications
- Acceptable for use in 2-hour fire rated walls
- UL Listed



Part #	Model #	Description
1626	660	1/2" Side (2) 1/2" Btm (2) 1/2" End KOs

Electrical Box Covers

4" Square Cover

- Used to close an outlet box
- Angled mounting slots compensate up to 12" for box misalignment



Part #	Model #	Description
2370	752	Flat, Blank

4" Square Exposed Work Cover

- Used to support switches or receptacles on boxes in surface mount applications



Part #	Model #	Description
2794	800C	1 Toggle
3778	902C	1 Duplex Receptacle, Crushed Corners
3819	906C	1 Duplex & 1 Toggle Switch
19143	907C	2 Duplex Receptacles

GFCI Receptacle Cover



Part #	Model #	Description
175552	808C	1 GFCI Receptacle Cover
175553	814C	1 GFCI Receptacle & 1 Toggle Switch Cover

4" Square 1 Device Plaster Ring

- Used to close an outlet box or for mounting



Part #	Model #	Description
2528	772	Single, Raised 1/2

Handy Box Covers

- Used to close 4" x 2" handy boxes

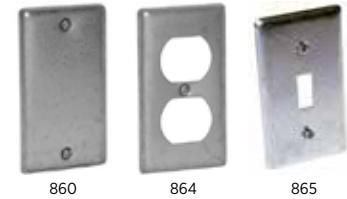

Part #	Model #	Description
3378	860	Blank Box Cover
3414	864	Duplex Receptacle
3426	865	Toggle Switch

GFCI Receptacle Cover



Part #	Model #	Description
175551	862	GFCI Receptacle Cover

Wire & Cable

THHN Copper Wire

• 90°C 600V Nylon jacketed building wire



Part #	Type	Color	Length
12077	#14 Solid	Black	500'
13961	#14 Solid	White	500'
3498	#12 Solid	Black	500'
5457	#12 Solid	White	500'
2655	#12 Stranded	Black	500'
4574	#12 Stranded	White	500'
12966	#10 Stranded	Black	500'
47635	#8 Standard	Black	100'
18373	#8 Stranded	Black	500'

AC Whips With Non-Metallic Core Liquidtight



Part #	Size	Wire	Fitting
11050	1/2" x 4'	#10 THHN	Metal
9946	1/2" x 6'	#10 THHN	Metal
4918	3/4" x 4'	#8 THHN	Metal
23314	3/4" x 6'	#8 THHN	Metal

Part #	Size	Wire	Fitting
37276	1/2" x 4'	#10 THHN	Non-Metallic
37275	1/2" x 6'	#10 THHN	Non-Metallic
169776	3/4" x 4'	#8 THHN	Non-Metallic
169777	3/4" x 6'	#8 THHN	Non-Metallic

AC Whips With Metallic Core Liquidtight

Part #	Size	Wire	Fitting
48387	1/2" x 4'	#10 THHN	Metal
48389	3/4" x 4'	#8 THHN	Metal

Mini-Split Jacketed Cable

Part #	Description
170497	14/3 Stranded Black Cable 250'

Devco Terminal Crump Kit

Part #	Model #	Description
182685	6202MX	Crump Kit

Wirenuts

Part #	Model #	Color	Description
9043	BRA8651	Blue	22-14 AWG
9051	BRA8652	Orange	22-14 AWG
17331	BRA8653	Yellow	18-12 AWG
18206	BRA8654	Red	18-10 AWG

Duct, Pipe Hangers & Supports

Pipe Hangers

6H-B Galvanized Steel Hanger with Bolt

- For EMT or rigid conduit
- Vertical or horizontal installation



Part #	EMT Size	Rigid Size
13401	1/2"	3/8" to 1/2"
13499	3/4"	3/4"
13589	1"	1"
13625	1-1/2"	1-1/4"
13751	1-1/2"	1-1/2"

Pipe Straps

Iron 2-Hole Strap



Part #	Size
7199	3/4" IP

EMT Single Hole Strap



Part #	Size
7483	1/2" EMT/TW
7745	3/4" EMT/TW
7964	1" EMT/TW
8206	1-1/4" EMT/TW
8444	1-1/2" EMT/TW
8939	2" EMT/TW

EMT 2-Hole Strap



Part #	Size
6945	1/2" EMT/TW
7226	3/4" EMT/TW
7442	1" EMT/TW
7692	1-1/4" EMT/TW
7924	1-1/2" EMT/TW
8396	2" EMT/TW

Copper Mineralac Strap

Part #	Model #	Size
28751	4301	3/4"

Nylon Wire & Cable Clamps



Part #	Model #	Size	Qty
37659	TH012-105	5/16"	100/Pk

Breakers



6 CONVENIENT LOCATIONS

ANN ARBOR

141 Jackson Industrial
Ann Arbor, MI 48103
P (800) 665-1452
F (734) 665-0679
M-F: 7:30 a.m. – 4:30 p.m.

COLDWATER

36 Mill Street
Coldwater, MI 49036
P (800) 922-5180
F (517) 279-7350
M-F: 7:30 a.m. – 4:30 p.m.

GRAND RAPIDS

130 Graham S.W.
Grand Rapids, MI 49503
P (800) 541-1144
F (616) 247-0283
M-F: 7:30 a.m. – 4:30 p.m.

JACKSON

1021 Belden Road
Jackson, MI 49203
P (800) 333-8005
F (517) 782-1155
M-F: 7:30 a.m. – 4:30 p.m.

LANSING

1115 S. Pennsylvania
Lansing, MI 48912
P (800) 487-4836
F (517) 487-1119
M-F: 7:30 a.m. – 4:30 p.m.

SAGINAW

219 Atwater
Saginaw, MI 48601
P (800) 292-0233
F (989) 754-4241
M-F: 7:30 a.m. – 4:30 p.m.

Circuit Breakers

Type CH 2-Pole Circuit Breaker

- Plug requires (2) 3/4" spaces
- Fits Cutler-Hammer style box



Part #	Model #	Amps
2584	CH230	30A

Type BR 1-Pole Small Frame Circuit Breaker

- Fits Challenger/GE style box
- Volts: 120/240VAC
- #14 - 4 Wire size range
- Lifetime warranty



Part #	Model #	Amps
5706	BR115	15A
5738	BR120	20A

Type BR 2-Pole Small Frame Circuit Breaker

- Fits Challenger/GE style box
- Volts: 120/240VAC
- #14 - 4 Wire size range
- Lifetime warranty



Part #	Model #	Amps
6618	BR215	15A
6667	BR220	20A
6781	BR230	30A
6871	BR240	40A
6975	BR250	50A
7082	BR260	60A

Breakers

Classified 2-Pole Circuit Breaker

- Requires (2) 3/4" spaces
- Replacement for Square D Type QO breakers
- 240VAC
- Lifetime warranty



Part #	Model #	Amps
15538	CHQ220	20A
15638	CHQ230	30A
15724	CHQ240	40A

Classified 2-Pole #14-4 Circuit Breaker

- Requires (2) 1" spaces
- Replacement for Square D Homeline, GE Type THQ, Crouse-Hinds Type MP, Thomas and Betts Type TB, Murray Type MP, ITE/Siemens Type QP breakers
- 120/240VAC
- Lifetime warranty



Part #	Model #	Amps
13026	CL230	30A

Li'L Popper Control Board Circuit Breakers

- Provides a temporary emergency fix for control boards that continue to blow fuses or that are shorted out
- Includes quick setting thermal cut out
- Self-adhesive backing for easy temporary installation



POP3

POP5

Part #	Model #	Description
43687	POP3	3A
43686	POP5	5A

Type BR Main Lug Load Centers

Type BR Single-Phase Main Lug Load Center

- Single-phase 3-wire
- 2-Space, 4-pole
- Insulated/bondable neutral
- 120/240VAC
- Indoor enclosure
- Aluminum bus
- NEMA Type 1



Part #	Model #	Amps
19247	BR24L70SP	70A

Fuses

Time Delay Cartridge Fuse (Dual Element)

250V Dual Element Fuse

- Time delay for temporary over-current conditions



Part #	Model #	Description
16741	ECNR15	15 Amp Cartridge Fuse
16791	ECNR20	20 Amp Cartridge Fuse
16854	ECNR25	25 Amp Cartridge Fuse
16912	ECNR30	30 Amp Cartridge Fuse
16960	ECNR35	35 Amp Cartridge Fuse
17015	ECNR40	40 Amp Cartridge Fuse
17057	ECNR45	45 Amp Cartridge Fuse
17099	ECNR50	50 Amp Cartridge Fuse
17187	ECNR60	60 Amp Cartridge Fuse

Combination Cover and Switch

- Maximum: 15A
- Maximum: 125VAC
- For use with type T plug fuses
- UL Listed
- CSA Certified



Part #	Model #	Description
14434	SSU	Switch and Fuse Holder for 2"x4" Box
15145	SSY	Switch and Fuse Holder for 4"x4" Box

Time Delay Screw-In Fuse



Part #	Model #	Description
6056	PTD015	15 Amp Screw-In Fuse
6116	PTD020	20 Amp Screw-In Fuse
6193	PTD030	30 Amp Screw-In Fuse

Fuses

Edison ECNR Dual-Element Time Delay Fuse

- UL Listed, Class RK5, Guide JDDZ, File E162363
- CSA Certified, C22.2, No. 248.12, Class 1422-02, File 700489



Part #	Model #	Amperage	Voltage
6056	82346	15A	250V
6116	82347	20A	250V
6193	82349	30A	250V

Disconnects

Solderless Terminals Female Disconnect



Part #	Size	Description
18277	10-12 / Yellow	.25" Female Disconnect 100 Pack
18060	16-14 / Blue	.25" Female Disconnect 100 Pack
17874	22-18 / Red	.25" Female Disconnect 100 Pack
82491	PiggyBack Adapter (1 Female 2 Male)	

Disconnect Boxes Midwest Pullout NEMA 3R Disconnect Box

- 3-Phase, 240V
- Zinc-coated steel



Part #	Model #	Amperage	Voltage	Type
37963	MRS83321	60A	240V	Non-Fused
38710	MRS83323	60A	240V	Fused

Terminals

Tab Solderless Compressor Terminal with Wire Kit

- Includes:
 - (3) Color-coded #10AWG type AWM extra flexible lead wires in 10" lengths
 - (1) End with .250" x .032" female tab 12-10 quick disconnect, other end stripped 5/16"
 - (3) 12-10 Shrink tube butt connectors



Part #	Model #	Description
4966	86379	Compressor Terminal Wire Kit with Female Tab End

A/C Disconnect Boxes

- Application: HVAC circuitry
- Power Rating: 30A (DDS-30) or 60A at 240VAC, 10 horsepower max
- Indoor/Outdoor use



Part #	Model #	Description
117493	DDS-30	30A Fusible Disconnect
79789	DDS-60	60A Fusible Disconnect
78443	DDS-60U	60A Non-fusible Disconnect

Meters & Instruments

AC 600A True RMS HVAC/R Clamp Meter

- True RMS
- 600A AC
- 750V AC/600V DC
- Resistance 60MΩ
- Capacitance 2000μF
- Temperature -31° to 752°F (-35° to 400°C)
- DC microamps 2000μA
- Frequency/Duty cycle
- Diode test
- Non-contact voltage detection
- Audible continuity
- 2-Year limited warranty
- Test leads, w/alligator clips CATIV 600V/CATIII 1000V
- Thermocouple temperature probe (ATT71)
- Zippered pouch
- (2) AAA Batteries
- Manual



Part #	Model #	Description
183990	DL479	AC600A True RMS HVAC/R Clamp Meter

DL389 G2Phoenix Pro+ Clamp-On Meter

- True-RMS
- 4000μF Capacitance
- 20009 ptA AC/DC Current
- 400A AC Current (clamp)
- 24 - 600VAC Non-contact voltage
- 750VAC/1000VDC
- Resistance
- Frequency/duty cycle
- Continuity
- Diode check
- Minimum/maximum
- Temperature (K-type): -22° - 752°F
- Dual display
- Detachable clamp head
- Input jack lock
- Worklight
- Low battery display lock
- EasyView high contrast backlit display
- Magnetic mount
- User temperature calibration
- Test lead storage
- Test lead holder on clamp head
- Automatic power-off
- Compatible with common industry accessories heads
- Safety compliance CAT III 600V, CAT II 1000V
- Includes:
 - K-Type temperature probe (ATT29)
 - Test leads (ATL59)
 - (2) AAA Batteries
 - Manual
 - Zippered carrying pouch
- 3-Year limited warranty



Part #	Model #	Description
55698	DL389	G2Phoenix Pro+ Clamp-On Meter

**QUALITY.
SERVICE.
TOMMARK.**

Meters & Instruments

CO Detectors

CO71A Carbon Monoxide Detector

- Carbon monoxide (ambient 0 - 999 ppm)
- 3-Color warning light:
 - Green 2 to 9 ppm
 - Amber 10 to 34 ppm
 - Red with audible alert +35 ppm
- Maximum capture
- Low battery indicator
- Backlit display
- Includes:
 - Holster with clip
 - 9V Battery
 - Manual
- 3-Year limited warranty



Part #	Model #	Description
52875	CO71A	CO Detector

Manometers

EM201SPKIT Dual Input Electronic Manometer Kit

- Dual input differential measurement to $\pm 60''$ wg
- Triple scale: in-wc, mBar, and psi
- Minimum/maximum value capture
- Data hold
- Backlit display
- Ruggedized, including rubber boot with integral magnet
- Automatic power-off
- Includes:
 - Dual input electronic manometer (EM201E)
 - (2) Magnetic static pressure tips (ASPI)
 - (2) Brass valve fitting connectors (BF100)
 - Soft carrying case (AC319)
 - (2) Pressure tubes with brass 1/4" MPT adapter
 - (1) 9V Battery
 - Manual
- 3-Year limited warranty



Part #	Model #	Description
85279	EM201SPKIT	Dual Input Electronic Manometer Kit

Meters

Palm Size Digital Multimeter

- Measures DCV, ACV, DC current, resistance, and temperature
- Includes meter, case, leads, battery, and manual



Part #	Model #	Description
90797	MA-33C	Multimeter

Digital Multimeter with Temperature

- Measures DCV, ACV, milliamps, capacitance, resistance, and temperature
- Includes mechanical doors to prevent wrong hook-up



Part #	Model #	Description
90800	MA-12817B	Multimeter

Digital Auto Ranging Multimeter

- AC Voltage: 400mV to 750V
- DC Voltage: 400mV to 1,000V
- DC Amperage: 400uA to 10A
- AC Amperage: 400uA to 10A
- Resistance: 400 ohms to 40 mohms
- Capacitance: 4nF to 200uF
- Frequency: 100 HZ to 10mHz
- Duty cycle: -1% to 99.9%
- Temperature: -4° to 1,400°F
- Transistor test
- Diode test
- Continuity buzzer
- Includes: meter, leads, K-type thermocouple, battery, and manual



Part #	Model #	Description
128931	MA-MY69	Multimeter

Meters & Instruments

Digital Economy Multimeter with Rubber Boot

- Measures AC/DC voltage, DC amps, resistance, and temperature
- Manual ranging and fuse protected
- Audible continuity
- Data hold and peak hold function
- 3-1/2" Backlit digital display
- CAT II
- Size: 5-1/2" x 3-1/4"



Part #	Model #	Description
55126	MA-DMT3	Multimeter

Economy Auto-Ranging Clamp-On Meter

- Volts
- Amps
- Ohms
- Data hold
- Continuity buzzer
- CAT II
- Includes carrying case



Part #	Model #	Description
55125	MA-600CF	Multimeter

Pocket Thermometer

- Range -40 to 482°F (-40 to 250°C) with 0.1 degree resolution
- Max/Min, Hold and Average functions
- Auto-power off after 15 minutes conserves battery life



Part #	Model #	Description
194354	ET05	Pocket Thermometer

Low Temperature Clamp-On Meter

- MAC Current
- AC/DC Voltage
- Resistance
- Capacitance
- Temperature
- Frequency
- LCD Display with backlight
- Data hold
- Auto power off
- Includes:
 - Carrying case
 - Test leads
 - K-Type probe
 - 9V Battery



Part #	Model #	Description
83117	MA-12822A	Clamp-On Meter

Digital Clamp-On HVAC Meter Flame Safeguard Circuits

- 4,000 Count LCD backlit display
- Data hold
- Max hold
- Zero function
- Automatic power off
- Low battery indicator
- Test μ A current range for HVAC
- Includes:
 - Temperature leads
 - Soft case
 - Manual
 - (2) AAA 1.5V batteries
- CATIII-600V



Part #	Model #	Range
128928	MA-12826A	-58° to 2372°F

Meters & Instruments

Digital Capacitor Tester

- 3-1/2" LCD display
- Low battery indicator
- Fuse protected
- CAT II
- Includes (1) 9V battery



Part #	Model #	Description
90803	MA-12815A	Digital Capacitor Tester

Electrical Testers

Low Voltage Detector & LED Flashlight

- Non-contact detection of AC voltage from 24 to 1,000VAC
- Double molded case
- For outlets or against wire insulation testing
- For use on 50/60Hz circuits
- Flashing red LED light indicator and audible beeper
- Built-in, bright LED flashlight with on/off button
- Convenient size with pocket clip
- Includes (2) AAA batteries



Part #	Model #	Range
90801	MA-49858A	24V to 1,000VAC

Volt Probe and Continuity Tester

- Non-contact detection of AC voltage from 24 to 1,000VAC
- Double molded case
- For outlets or against wire insulation testing
- For use on 50/60Hz circuits
- Flashing red LED light indicator and audible beeper
- Built-in, bright LED flashlight with on/off button
- Convenient size with pocket clip
- Includes (2) AAA batteries



Part #	Model #	Description
90847	MA-8206	Pocket Volt Tester

Borescopes

ET510 Borescope

- Use to view inaccessible areas
- Durable camera snake with adjustable work light
- Waterproof, dustproof camera (IP67), adjustable LED work light, high resolution screen, mirror image
- Multiple applications: electrical, HVAC, plumbing, automotive, aircraft



Part #	Model #	Description
146599	ET510	2-2/5"

Capacitor Testers

Digital Capacitor Tester

- Measure the capacitance value on start run capacitors
- Checks for open and shorted capacitors
- Use as a continuity tester
- Checks run, start and DC electrolytic capacitors
- Powered by (4) AA Size 1.5V batteries (sold separately)



Part #	Model #	Description
9255	MFD10	2-5/8" x 1-3/8" x 4-1/4"

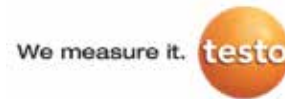

Testo Gas Combustion Analyzers

Model 310 Residential Combustion Analyzer Kit

- Measures CO level, draught, exhaust, electrochemical, efficiency
- 30-Seconds to start
- Powerful magnets on the housing allow for hands-free operation
- Includes:
 - Analyzer
 - Rechargeable battery
 - Probe with cone
 - Hose
 - Silicon tubing (for pressure)
 - (5) Extra particulate filters
 - A/C Power supply (with USB recharging)
 - (5) Pressure plugs
 - Calibration certificate
 - Case



Part #	Model #	Testo #	Description
84134	310	0563 3100	Analyzer Kit

Testo Paper



Part #	Model #	Description
75413	0554 0568	Thermal Printer Paper (6 Rolls)

Meters & Instruments

Refrigeration Meters

Model 550 Refrigeration System Analyzer Digital Manifold

- 60 Refrigerant profiles built in for automatic PT calculations
- Used for refrigeration and heat pump systems including 16 SEER systems
- Measures low/high pressures and temperature
- Simultaneous calculation of superheating and subcooling in real time with (2) probes
- App integration via Bluetooth® for monitoring and reporting



Part #	Model #	Testo #	Description
162749	550	0563 1550	3-Port, 2-Valve, Bluetooth Enabled Refrigeration Analyzer Manifold

Model 557 Refrigeration System Analyzer Digital Manifold with Built-In Vacuum Gauge

- 4-Way aluminum valve block
- Built-in magnifying sight glass
- (2) NTC Temperature probe inputs
- (60) Refrigerants on-board
- Large, easy-to-read back-lit display
- Dimensions: 8-3/4" x 4" x 2-3/4"
- Ranges: -14.7 to 870psi pressure; -58° to 302°F; 0 to 20,000 micron vacuum



Part #	Model #	Testo #	Description
162771	557	0563 1557	4-Valve Analyzer With Vacuum Gauge with Bluetooth

Parts & Accessories

Clamp Type Temp Probe for Testo Meters



Part #	Model #	Description
72750	0613 5505	Probe for Temperature Measure On Pipe

Furnace Key

Part #	Model #	Description
170924	FSKEY	Furnace Key

Accessories

Carrying Cases

- 5-1/2"W x 10-1/2"H x 2-1/2"D
- Inside pocket business card holder
- Stylish design carrying strap
- One year limited warranty



Part #	Model #	Description
29775	AC-519	Deluxe Large Soft Case

Test Lead

- UL Listed



Part #	Model #	Description
21133	ATL55	Standard Insulated Test Leads

Temperature Probes

K-Type Temperature Probe



Part #	Model #	Description
131593	ATT29	4' Standard Fiber Glass Coated for DTO150, DL289, DL279, DL269, DL259, DL250, and TA2K
33756	ATT29A	4' Standard Fluoroplastic Coated, FDA Approved

Pipe Clamp Probe

ATTPC3 K-Type Pipe Clamp Probe

- Temperature range: -40° to 250° F (-40° to 121° C)
- Compact and easy to use
- Improved strain relief
- Comfort grip
- Clamp style adapter for use with K-Type inputs



Part #	Model #	Description
183989	ATTPC3	Fits 1/4" to 1-1/2" Pipes

Digital Vacuum Gauge

Part #	Model #	Description
38784	V664	Digital Vacuum Gauge

Test Leads & Probes

Tools

J/B Vacuum Pumps/Accessories



Part #	Model #	Description
34704	DV200N	7CFM Platinum Vacuum
26565	DV22N	Hand Held Digital Vacuum Gauge
64813	DV41	Supernova Digital Vacuum Gauge with Case
190319	DV40S	Wireless Micron Gauge

Meter Accessories

Type K Clamp-On Thermometer Probe

- Use with any instrument that accepts K-type temperature leads
- Clamp jaw opening to 1-3/8"



Part #	Model #	Range
55122	MA-12355A	-40° to 212°F

Test Lead

- Use with any instrument that accepts K-type temperature leads
- Clamp jaw opening to 1-3/8"



Part #	Model #	Description
55116	MA05031-2	10-Wire, 18"L, Low Voltage w/Alligator Clips: White, Red, Black, Yellow, & Green Wire
90805	MA-69523	Test Lead Set with Start Switch

Test Leads

Heavy-Duty Jumper Lead

- Red and black test lead in each pack
- 18 Gauge 90° C EPR rubber insulation
- Soldered connections
- Flexible down to -30°C

Part #	Model #	Description
18049	13807	36" Jumper Leads (Pair)

Manometers

Mini Dual Differential Manometer

- Dual input range
- Data hold
- Provides differential measurements
- Low battery indicator
- Automatic power off
- Backlit LCD display
- Accuracy +/- 0.3% full scale output 77° F
- Repeatability +/- 0.2% (Max +/-0.5% full scale output)
- Maximum pressure: 10 psi
- Response time: 0.5 seconds
- Includes:
 - 9V Battery and magnet



Part #	Model #	Range
90799	MA-12838A	-55.40 to +55.40"wc

Digital Mini Anemometer

- Automatic power off
- Record mode: maximum/minimum
- Temperature units °C/°F
- Temperature display
- Velocity display
- Velocity units
- Low battery indicator
- Data hold
- Memory recall
- Includes:
 - 9V battery and carrying case



Part #	Model #	Range
90802	MA-AN84	-32° to 122°F

Air & Pressure Measurement

Digital Anemometer with Flexible Neck

- Measures air flow, air velocity, and temperature
- °C/°F switchable
- Data hold/maximum/minimum
- 12" Gooseneck detector hard-to-reach areas
- (4) Digit display of air velocity in meters/sec, ft/min, km/MPH, knots, and CFM
- Low battery indication
- Auto power off
- Includes:
 - 9V battery and carrying case



Part #	Model #	Range
55124	MA-12843B	14° to 140°F

Manometers

Dual Digital Manometer

- Tests for leaks in low-pressure gas systems, differential measurement
- Dual inputs
- (11) Units of measure
- Data hold
- Automatic power off
- LCD Display with backlight
- Includes:
 - 9V Battery
 - Soft carrying case



Part #	Model #	Description
54625	DDM55	-55 to +55"wc Range

Psychrometers

Digital Psychrometer

- Measures dew point, wet point, temperature, and humidity
- Backlit dual display
- Response time: 0.5 seconds
- Maximum hold and data hold
- Automatic power off
- Size: 10" x 1-4/5" x 1-3/10"
- Includes:
 - 9V battery and soft case



Part #	Model #	Range
55123	MA-16531B	-22° to 212°F

Airflow Meters

Airflow Balancing Meter

- Converts air speed into air volume
- Records data to a history log which may be emailed for professional looking reports
- Apple® and Android® device compatible



Part #	Model #	Description
147072	ABM-100	Airflow Balancing Meter



A MUNCH'S SUPPLY COMPANY

WE APPRECIATE YOUR BUSINESS!

Thermometers

PDT550 Digital Pocket Thermometer

- Water resistant
- Minimum/maximum
- Protective boot
- Magnetic mount
- Data hold
- Automatic power-off
- New ergonomic designed head
- Pen style sheath
- Includes AB13 batteries
- 3-Year limited warranty



Part #	Model #	Range
34394	PDT550	-58° to 572°F

PDT650 Folding Pocket Thermometer

- Folding temperature probe
- Built-in magnetic mount
- Minimum/maximum record
- Automatic power-off
- Large easy to read display
- Includes battery (AB13)
- 3-Year limited warranty



Part #	Model #	Range
131556	PDT650	-58° to 572°F

K-Type Differential Thermometer

- Dual input
- Minimum/maximum capture
- Built-in microprocessor and high resolution analog to digital converter chip
- Automatic power off with disable feature (15 minutes)
- Large LCD screen
- Complete with bead wire temperature probes
- °C/°F Select function
- Magnetic mount



Part #	Model #	Description
126017	DTK2	Differential Thermometer

Temperature & Humidity Testers

DTH35 Digital In Duct Psychrometer

- Measures temperature and relative humidity
- Calculates wet bulb, dew point, enthalpy, min/max, data hold
- Large-digit back-lit display
- Designed for in-duct measurement (4" x 3/8" probe dimensions)
- Magnetic mount for hands-free use
- Probe cover functions as an extension for hard to reach areas



Part #	Model #	Range
175111	DTH35	-4° to 122°F

Thermometers

Shirt Pocket Laser Thermometer

- 6:1 Distance to spot ratio
- Large LCD backlit display
- Automatic power off
- Laser targeting
- Low battery indicator



Part #	Model #	Range
90808	MA-IRT203B	-58° to -518°F

Digital Pocket Thermometer

- High/low recall
- Water-resistant



Part #	Model #	Range
90809	MA-PDT392B	-40° to +392°F

Thermometers / Leak Detectors

Oval Style Digital Stem Thermometer

- Large LCD display
- Anti-rolling head design
- Includes plastic sheath which can also be used as a holder and pocket clip



Part #	Model #	Range
72324	MA-RT335	-50° to 392°F

Big Digit Hygro-Thermometer

- Dual display for humidity and temperature
- Maximum and minimum reading memory
- °C/°F Selectable
- Fast reading update
- Pen-shape design with large, clear display



Part #	Model #	Description
55121	MA-RT819	Hygro-Thermometer

Infrared Thermometers

Mini-Infrared Thermometer

- 10:1 Distance to spot ratio
- Built-in laser pointer
- °C/°F Selectable button
- Backlit LCD display
- Data hold
- Automatic power off
- Includes:
 - Carrying case and 9V battery



Part #	Model #	Range
90807	MA-16509B	-58° to 1,022°F

Laser Distance Measurer 65 FT / 20 M

- Meter provides measurements up to 65-feet in distance, at an accuracy of + or - 1/16"
- Quickly calculates area, length and volume with large, easy-to read buttons
- Provides both fractional (imperial) and metric readings
- Offers the option of one-touch, single-distance measurement and continuous measurement



Part #	Model #	Range
190103	93LDM65	65 ft/20m

ET05 Klein Pocket Thermometer

Part #	Model #	Range
194354	ET05	N/A

Infrared Thermometers

INF195 Scout II Infrared Thermometer

- Min/Max/Differential/Average
- Hi/low alarm (user adjustable)
- K-Type thermocouple input
- 12 to 1 Spot ratio
- (3) Emissivity levels: 0.30, 0.70, 0.95
- Includes:
 - Carrying case
 - (2) AAA Batteries
 - Manual
- 3-Year warranty



Part #	Model #	Range
80785	INF195	-76° to 1022°F

Thermometers

550B Digital Pocket Thermometer

- Water resistant
- Minimum/maximum
- Protective boot
- Magnetic mount
- Data hold
- Automatic power-off
- New ergonomic designed head
- Pen style sheath
- Includes AB13 batteries
- 3-Year limited warranty



Part #	Model #	Range
38108	550B	-58° to 572°F

Leak Detectors

CD100A Combustible Gas Leak Detector

- 50 ppm Minimum detection
- Long 18" gooseneck
- Detects acetone, alcohol, ammonia, benzene, ethylene oxide, gasoline/petrol, halon and hydrogen sulfide
- Precision sensor detects even the smallest leaks
- Worklight in sensor cap illuminates the search area
- Adjustable tick rate
- Headphone jack
- Includes:
 - 9V battery and manual
- 1-Year limited warranty



Part #	Model #	Range
22621	CD100A	Combustible Gas Leak Detector

Refrigerant Recovery/Vacuum Pumps/Oil

Refrigerant Recovery Systems

Robinair® The Cube™ Ultralight Refrigerant Recovery Machine

- Ideal for any residential and appliance-sized recovery job
- 1/3 hp Single-cylinder, oil-less compressor
- IEC Connector and power cord
- Works with all CFC, HFC, HCFC refrigerants including R-410A
- Auto shut-off if pressure rises above 550 psi
- Dimensions: 9-1/2"H x 6-1/2"W x 12-1/2"L
- Weight: 18 lbs
- Electrical: 115V, 60Hz
- UL Listed
- Conformance European
- 1-Year warranty



Part #	Model #	Range
141075	RG3	The Cube™ Ultralight Refrigerant Recovery Machine

Recovery Machine Parts & Accessories

Part #	Model #	Description
37267	100343	Replacement Male/Female Filter for Promax

Recovery Tanks/Cylinders



Part #	Model #	Description
14954	REF-50	50#, 400 PSI, DOT

Robinair® Vacuum Pumps

VacuMaster Vacuum Pump

- 1/2" ACME and 1/4" MFL Intake fitting
- Rotary vane
- Gas ballast
- 2-Stage, 115V, 60Hz operation
- 1-Year "no-hassle" over-the-counter replacement warranty



Part #	Model #	CFM	HP	Oil Cap	Weight
40447	15500	5 CFM	1/3 hp	9.5 oz	21 lbs

Robinair® Heavy Duty Twin Cylinder Recovery Machine

- Self-purge manifold
- Internal filter
- Dual-proprietary oil-less compressor
- Field-serviceable semi-hermetic compressor
- Works with all CFC, HFC, HCFC refrigerants including R-410A
- Auto shut-off if pressure rises above 550 psi
- Auto resets if pressure drops below 400 psi
- Weight: 27 lbs
- Electrical: 115V, 60Hz
- UL Listed
- 1-Year warranty



Part #	Model #	Range
160382	RG6	Robinair® Recovery Machine

J/B Recovery Machine

- Micro-channel condenser for industry leading recovery rates
- Powerful dual piston compressor
- Full one horse power motor
- Self-purging without the need to change hoses
- Oversized cooling fan for superior heat dissipation
- Heavy duty handle with comfortable rubber grip
- Simple two-valve operation
- Made in USA



Part #	Model #	Description
177745	F6-DP	DVAL Piston Refrigerant Recovery Unit

Refrigerant Recovery/Vacuum Pumps/Oil

Eliminator® Series Vacuum Pump

- 2-Stage, direct drive
- Tested to 25 microns
- Capacitor start motor with thermal overload protection
- 3/8" NPT Break-resistant handle encompasses exhaust
- Check valve prevents oil back flow during power failure
- All metal construction including all brass fittings
- Heavy-duty power paint is scratch-resistant
- Tethered safety cap prevents oil spills during transit
- Well protected drain valve
- Completely field repairable
- 24-Month over the counter warranty
- UL Listed



US Domestic Eliminator Vacuum Pump

- 110V US Plug
- Motor: 115V @ 60Hz, 1/2 hp 1,725 rpm

Part #	Model #	CFM	Intake Ports
47498	DV-4E	4 CFM	1/4" x 3/8" MFlr
47499	DV-6E	6 CFM	1/4" x 3/8" MFlr

Deep Vacuum Pump Accessories

Black Gold Vacuum Pump Oil

- Pure and non-detergent
- Hydro processed which means it goes through a series of catalytic steps rendering the oil extremely refined, more viscous and more stable
- For industrial oil, the viscosity is an ISO grading at 40°C
- Black Gold vacuum pump oil is an ISO 41, a special to this type of application



Part #	Model #	Description
33834	DVO-1	1 pt
8394	DVO-12	1 qt
37265	DVO-24	1 gal

Deep Vacuum Flexible Metal Hose

- Will not permeate under vacuum
- Positive seal o-ring quick coupler fittings
- Recommended for deep/high vacuum
- Replacement o-ring: P90009



Part #	Model #	Description
4136	D10436	1/4" x 36" ((1) 45° Ftg)

DV-T1 The Tank Vacuum Pump Oil Caddy Pink

- Change vacuum pump oil in-between jobs
- Holds up to (5) oil changes



Part #	Model #	Description
126154	DV-T1	Vacuum Pump Oil Caddy

Novent® Locking Refrigerant Caps 1/4" Thread R-410A Socket Refrigerant Cap

- Seal service valve to prevent leaks
- Help prevent illegal venting or accidental mixing of refrigerant
- Color coded for easy ID
- Corrosion resistant
- Integral torque limiter



Part #	Model #	Description
55066	NP-R410	2-Pack

Locking Refrigerant Cap Kit



Part #	Model #	Description
55065	NG-R22	R-22 Caps (3) Red R-410A ap (1) Multi-key

Refrigerant Cap Keys

Multi-Key Refrigerant Cap Key



Part #	Model #	Description
55067	NV-MULTI	Multi-key for NG, NS, NP & NPE Caps
170870	SHLD-3-DRIVER	The Shield-Stubby Screwdriver
194999	SHLD-U4	Universal Locking Cap
195000	SHLD-P4	Pink R410 Locking Cap
195001	SHLD-MULTI	Universal Locking Cap, Key w/bits for Novent, C&D Valve, & Shield Lock



Manifolds & Accessories

Tools

Patriot Manifolds

Patriot™ 2-Valve 1/4" Brass Manifold

- 3-1/8" Metal class 1 (1%) illuminating gauges
- Replaceable free floating O-ring system and swiveling hose holder fittings
- Surge dampened gauges for reduced needle movement
- Original free floating dual o-ring sealing system for faster evacuation/charging
- Pull-out proof hanging hook
- Metal hand wheels
- Solid brass forging
- Camouflage design gauges available



Part #	Model #	Description
159781	22225CM	Manifold less Hoses
184613	22225 2V	Patriot Manifold with Illuminating Gauges

Standard Brass Manifolds

Standard Brass 2-Valve Manifold

- Surge dampened gauges for reduced needle movement
- Original free floating dual O-ring sealing system
- All metal gauges
- Color-coded refrigerant dials for easy reading
- Pull-out proof hanging hook
- Replaceable intake/hose holder fittings for storage
- Easy turning plastic handwheels
- Completely repairable
- Limited lifetime warranty on manifold bar



2-1/2" Standard Gauges R-22, R-404A, R-410A

Part #	Model #	Description
59874	M2-8-410A	Manifold less Hoses

Zeppelin™ Manifolds

Zeppelin™ 4-Valve 3/8" Aluminum Manifold

- Heavy-duty forged aluminum body
- Full 3/8" bore for fast evacuation
- Sight glass standard
- Surge dampened gauges for reduced needle movement
- Original free floating dual o-ring sealing system for faster evacuation/charging
- Color-coded refrigerant dials for easy reading
- Pull-out proof hanging hook
- Replaceable intake/hose holder fittings for storage
- Soft grip rubber handwheels reduce turning to open/close
- Includes (4) 60" hose set unless otherwise noted



2-1/2" Standard Gauges R-22, R-404A, R-410A

Part #	Model #	Description
51396	25200	Manifold less Hoses

3-1/8" Glow-in-the-Dark Gauges R-22, R-404A, R-410A



Part #	Model #	Description
65314	25244	Manifold with 60" CCLV Hoses with Whip End

Revolver Manifolds

Revolver™ Brass 4-Valve Ball Valve Manifold

- 1/4-Turn full open/close handle
- (4) Internal ball valves
- 3/8" Port for faster evacuation
- Hose holders swivel to the front and rear for flexibility
- Pull-out proof hanging hook
- Soft grip rubber handwheels reduce turning to open/close
- Surge dampened gauges for reduced needle movement
- All metal gauges
- No liquid charging adapter necessary
- Includes (4) 60" hose set



3-1/8" Glow-in-the-Dark Gauges R-22, R-404A, R-410A

Part #	Model #	Description
78595	26244	Manifold with 60" CCLV Hoses with Whip End
177750	DMG2-5	Digital Manifold with hoses, case and temp clamps

Manifolds & Accessories

Manifold Gauges

2-1/2" (63.5mm) Standard Steel Gauge

- High quality steel case
- Standard size gauges
- Surge dampened for accuracy
- High-impact clear view Lexan lens
- Recalibration screw
- Full size brass movements
- 1/8" MPT Connections
- Compound gauge:



R-12, R-22, R-502 2-1/2" Steel Gauge

- 30" vacuum to 120 psi, retard to 350 psi
- Pressure gauge: 0 to 500 psi

Part #	Model #	Description
2762	M2-250	2-1/2" Compound
5135	M2-500	2-1/2" Pressure

R-22, R-404, R-410A 2-1/2" Steel Gauge

- Compound gauge: 30" vacuum to 120 psi, retard to 350 psi
- Pressure gauge: 0 to 800 psi



Part #	Model #	Description
64993	M2-460	2-1/2" Compound
55949	M2-465	2-1/2" Pressure

3-1/8" (80mm) Glow-in-the-Dark Gauge with Steel Case

- Glow-in-the-dark dials store energy to emit light in dimly lit or dark applications
- The R-410A only gauge is not glow-in-the-dark due to pink dial
- High impact clear view Lexan lens with 1/8" MPT connection
- Compound gauge: 30" vacuum to 250 psi, retard to 500 psi
- Pressure gauge: 0 to 800 psi



R-12, R-22, R-502 3-1/8" Glow-in-the-Dark Gauge

Part #	Model #	Description
55445	M2-820	3-1/8" Compound
56175	M2-825	3-1/8" Pressure

Manifold Accessories

Repair Parts

Part #	Model #	Description
55223	MR-601	Handwheel & Screw for Zeppelin

Gauge Boot



Part #	Model #	Description
134272	MR-598	2-1/2" Black Protective Gauge Boot
159785	MR-593CM	3-1/8" Camo Protective Gauge Boot

Gauge Lens



Part #	Model #	Description
56759	MR-533	80mm Snap-On Gauge Lens
181423	33112RK	Secure Seal Hose Repair Kit

**QUALITY.
SERVICE.
TOMMARK.**



Manifolds & Accessories

KOBRA® High Pressure Charging Hose **KOBRA® CLS Series High Pressure Hose with** **Low Loss Secure Seal Fitting**

- Opens to full flow
- Rebuildable secure seal fitting
- Rebuild kit: 33112RK
- Replacement O-ring: P90022
- Working pressure: 800 psi
- Burst pressure: 4,000 psi
- UL Approved for R-410A

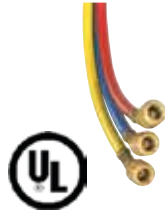

Part #	Model #	Description
44540	CLS-60B	60" Blue
44541	CLS-60Y	60" Yellow
41280	CLS-60R	60" Red
23756	CCLS-60	60" R/Y/B Set

KOBRA® CLE Series High Pressure Hose with **Gasket Seal Fitting**

- Blowout resistant depressor and barrel gasket
- Depressor is set to ARI standard for the access valve core
- Replacement depressor: P90514
- Replacement gasket: P511
- Working pressure: 800 psi
- Burst pressure: 4,000 psi



Part #	Model #	Description
26165	CLE-60B	60" Blue
64805	CLE-60Y	60" Yellow
64806	CLE-60R	60" Red

Kobra™ CLV High Pressure Hose **with Ball Valve and 6" Whip End**

- 1/4-Turn lever style ball valve with 6" whip end with 1/8" MPT fitting
- Replacement depressor: P90514
- Replacement gasket: P511
- Whip end replacement less ball valve: CLP Series
- Whip end replacement with ball valve: CLV-6
- Working pressure: 800 psi
- Burst pressure: 4,000 psi



Part #	Model #	Description
65315	CLV-60B	60" Blue
65316	CLV-60R	60" Red
23339	CLV-60Y	60" Yellow
13061	CCLV-60	60" R/Y/B Set

Kobra™ CLV High Pressure Hose with **Ball Valve Whip Ends Only with Ball Valve**

- 1/4-Turn lever style ball valve on 6" whip ends
- Whip ends only with 1/8" MPT fitting
- Replacement depressor: P90514
- Replacement gasket: P511
- Working pressure: 800 psi
- Burst pressure: 4,000 psi



Part #	Model #	Description
30734	CCLV-6	1/4" x 6" R/Y/B Set

3/8" Kobra Black and Yellow High Pressure **Charging Hose**

- Gasket seal fittings
- Lined with Kevlar
- Replacement gasket: P90016
- Working pressure: 600 psi
- Burst pressure: 3,000 psi



Part #	Model #	Description
38089	CL6-60Y	60" Yellow

Kobra Hose Repair Parts

Part #	Model #	Description
38471	P90022	O-Ring for CLS Series Hose, 5/Pk

Manifolds & Accessories

400 Series Deluxe 2-Valve Brass Manifolds

- Dual o-ring, soft-seat valves with full-flow design
- Precision gauges with protective boots
- Polarshield® high performance hoses
- Ergonomic, soft-touch non-slip grip handles
- Working pressure: 800 psi
- Burst pressure: 4,000 psi



2-1/2" PSI Scales R-22, R-404A, R-410A - Red/Blue Gauges

Part #	Model #	Description
40426	421-C	Manifold with 1/4" SAE Ports and 60" R/Y/B Hoses

800 Series 4-Valve Manifolds

- 1/4" and 3/8" SAE Port connections
- Oversized internal passages
- Proven diaphragm-type, soft-seat valves
- Precision gauges with protective boots
- Large ergonomic, soft-touch, non-slip grip handles
- Clamshell packaging
- Polarshield® high performance hoses
- Working pressure: 800 psi
- Burst pressure: 4,000 psi



2-1/2" PSI Scales R-404A, R-410A - Red/Blue Gauges

Part #	Model #	Description
65317	846-C	Manifold with 1/4" & 3/8" SAE Ports and (3) 60" Hoses with Low Loss Ball Valve Shut-Offs and (1) 3/8" Vacuum Line, Clamshell Pkg

Manifold Gauges

2-1/2" Manifold Gauge (°F) for Gauge Scales R-12, R-22, R-502



Part #	Model #	Description	Prs Scale
41860	423-CR	Red Prs	0 - 500 psi

2-1/2" Manifold Gauge (°F) for Gauge Scales R-22, R-404A, R-410A

- Color-coded refrigeration scales
- Shock, vibration, and pulsation-resistant



Part #	Model #	Description	Prs Scale
47627	422-CR	Red Prs	0 - 800 psi
41214	422-CB	Blue Comp	30" Hg - 500 psi

Charging Hose

800 Series Polarshield® Charging Hose

- 1/4" SAE Connections
- Compatible with all CFC, HFC, HCFC refrigerants (R-410A, R-404A, R-407C and R-134a)
- Working pressure: 800 psi
- Burst pressure: 4,000 psi
- UL Recognized component



Part #	Model #	Length	Color
47738	805-MRS	60"	R/Y/B

950 Series PolarShield® Hose with Low Loss Ball Valve Shut-Off

- 1/4" FFL Connections
- Compatible with all CFC, HFC, HCFC refrigerants (R-410A, R-404A, R-407C and R-134a)
- Working pressure: 800 psi
- Burst pressure: 4,000 psi
- UL Recognized component



Part #	Model #	Length	Color
50555	955-MRS	60"	R/Y/B

Manifold Hanger Straps

AmiraLin HVAC Strap™

- Magnetic HVAC manifold gauge holder
- Made in the USA for HVAC technicians
- Invented by an HVAC technician



Part #	Model #	Description
136422	ST-101	HVAC Strap for Magnetic Manifold

Access Fittings & Accessories

Kwik Charge®

- Low side charger
- Use when working with tracing dyes
- Up to 8 times faster than vapor charging
- No need to heat refrigerant cylinder
- Built-in check valve opens for drawing unrestricted vacuum
- No pressure drop in cylinder
- (1) Charger services all units 0.5 ton or larger



Part #	Model #	Description
50553	535-C	1/4" Male Female SAE Flare Inlet, 1/4" Male AE Flare Outlet

Vacuum/Charging Valves

Kwik-Coupler™ Kit



Part #	Model #	Description
10436	18-C	Set of 2 (16-C and 17-C) Service Hose Shut-Offs, Skin Packaged



Quick Couplers

Quick-Coupler Shut-Off Fitting

- Use with existing charging hose
- Immediately traps refrigerant discharge from hose when disconnected from access fitting



Part #	Model #	Description
12591	33112N	1/4" QC x 1/4" SAE

Quick Coupler Depressor



Part #	Model #	Description
14312	P90513	For 1/4" Hoses/Couplers

Caps

O-Ring Quick Seal Cap

- A/C Refrigeration or deep vacuum
- Finger tight sealing for all male SAE connections



Part #	Model #	Description
15828	NFT5-4	1/4" SAE Cap, 10/Pk
15851	NFT5-6	3/8" SAE Cap, 3/Pk

Quick Seal Cap Gasket

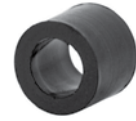

Part #	Model #	Description
3279	P509	Replacement Gasket for Quick Seal Cap, 10/Pk

Access Valves

Copper Tube Extension

- Use with Sil-phos alloy and copper fittings
- Install through the side of the larger line to extend length approximately two inches
- Temperature range: -40° to 250°F
- Includes cap and valve core



Part #	Model #	Description
5048	A31002	1/8" OD
5061	A31003	3/16" OD x 1/8" ID
5072	A31004	1/4" OD x 3/16" ID
5082	A31005	5/16" OD x 1/4" ID
5092	A31006	3/8" OD x 5/16" ID

Copper Braze Tee

- Extra depth slip fit solder cups
- Bend, cut, flare, swage or pinch
- Simple installation anywhere along line

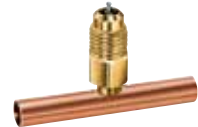

Part #	Model #	Description
6253	A31134	1/4" ODS x 5/16" ODF, 3/Pk
6266	A31135	5/16" ODS x 3/8" ODF, 3/Pk
6276	A31136	3/8" ODS x 1/2" ODF, 3/Pk
6333	A31142	3/4" ODS
6351	A31144	7/8" ODS

Swivel Flare Tee with Depressor

- Extra depth slip fit solder cups
- Bend, cut, flare, swage or pinch
- Simple installation anywhere along line



Part #	Model #	Description
12991	A31851	1/4" Fem SAE Swivel Nut on Run
13007	A31852	1/4" Fem SAE Swivel Nut on Branch

Access Fittings & Accessories

Access Valve (MPT)

- Core pre-torqued at 2.9 to 2.95 in-lb



Part #	Model #	Description
64801	A31482	1/8" MPT Half Union
64800	A31484	1/4" MPT Half Union

Brass Tube Fittings

- SAE 45° Flared tube fittings may be used with copper, brass, aluminum, steel and plastic tube provided an acceptable flare could be generated with the material
- Vacuum and pressure of 5,000 psi can be handled depending upon the size, material and conditions - using a 4:1 safety factor, the following general rule (excluding plastic tube) is used:
 - 3,000 psi to 1/4"
 - 2,000 psi to 1/2"
 - 1,500 psi to 1"
- Good vibration resistance (improved by using long nuts)
- Fittings generally comply with SAE, ASA, ASME and MS standards
- Made in USA quality

Flare Tee (Flare)

Part #	Model #	Description
66754	T2-4	1/4" x 1/4" x 1/4"

Adapter (FFlr x Flr)

- Furnished with copper gasket



Part #	Model #	Description
141350	UR3-68	3/8" x 1/2"

Valve Core Tools

1/4" Valve Core Tool

- Hollow handle for storage
- Includes (6) extra cores



Part #	Model #	Description
14482	A32004	1/4" Valve Core Tool

1/4" Valve Core

- PTFE/Neoprene seal replacement
- Maximum pressure: 800 psi @ 220°F (104°C)



Part #	Model #	Description
14422	A31999	5/Pk

Valve Core Torque Tool

- Automatically sets proper torque to 5 in lbs
- Calibrated to precise torquing requirements for core valves
- Works with all Schrader valve cores



Part #	Model #	Description
89754	A32008-BX	Valve Core Torque Tool

Access Fittings

Valve Core

ROBINAIR



Part #	Model #	Description
18635	18561	Solid Brass Body Remover/Installer

MA-LINE
MONTI AND ASSOCIATES, INC.

Metal Valve Core Tool

- Includes 6 Replacement Cores



Part #	Model #	Cores
90819	MA-AF2000-M	6

Quick-Pierce Vise Grip



Part #	Model #	Description
90823	MA-QP400	Quick-Pierce Vise Grip

Hand Tools

All-Purpose Pliers

- Strips and cuts 8 to 16 AWG solid and 10 to 18 AWG stranded wire
- Long nose
- 6 to 32 and 8 to 32 Screw shearing
- Induction hardened cutting knives
- Hot-riveted joint
- Forged steel
- Cramps insulated and non insulated terminals
- Dual material Journeyman™ handles



Part #	Model #	Description
173883	J207-8CR	All Purpose Pliers with Crimper

High Leverage Side-Cutting Pliers

High Leverage Side-Cutting Pliers

- Rivet is closer to cutting edge for 46% greater cutting and gripping power than other designs
- Hot-riveted joint
- Induction hardened cutting knives
- Sure-gripping, cross-hatched, knurled jaws
- Handle tempering helps absorb "snap" when cutting wire
- Precision-hardened pliers head
- Custom US-made tool steel
- HD213-9NE heavy-duty oversized "Handform" handles



Part #	Model #	Jaw Length	Jaw Width
54824	D213-9NE	1-19/32"	1-1/4"

High Leverage Diagonal Angled Head Cutting Pliers

- High leverage
- Plastic dipped handles



Part #	Model #	Jaw Cup	Jaw Width
54825	D248-8	3/4"	1-3/16"
194296	D228-8	1-3/16"	1-3/16"

Standard Needle-Nose Side-Cutting Pliers

- Induction hardened cutting knives
- Knurled jaws
- Plastic dipped handles



Part #	Model #	Jaw Length	Jaw Width
54826	D203-6	1-7/8"	11/16"
194297	D203-8	2-5/16"	1"

Pump Pliers

- Secure tongue and groove design for non-slip grip
- Wide range of versatile jaw positions
- Plastic-dipped handle



Part #	Model #	Max Cap	Overall Length
54827	D502-10	1-3/4"	10"
194301	D504-10B	2-1/8"	10"
194304	D504-10	2-1/8"	10"
194305	D504-7	1-3/8"	7-3/8"

Cable Cutters

Journeyman™ Crimping/Cutting Tool with Non-Insulated/Insulated Terminals

- Crimps insulated and non-insulated 10 to 22 AWG solderless terminals and connectors
- Tapered nose design
- Contoured thumb area
- Specially hardened cutter



Part #	Model #	Length
54830	J1005	9-3/4"
60431	1005	9-3/4"

Hand Tools

Wire Stripping & Cutting Tools

Long-Nose Multi-Purpose Tool

- Cuts and strips wire 10 to 22 AWG
- Crimps insulated and non-insulated terminals and 7 to 8 mm ignition terminals
- Narrow serrated pliers nose to pull, loop, and bend wire
- Long curved cutting blade
- Cutters and strippers are in front of the pivot for reaching into tight places
- Plastic covered cushioned handles



Part #	Model #	Length
54828	1010	8-1/4"

Klein-Kurve™ Wire Stripper/Cutter

- Precision shear-type blades
- Clean cuts on solid and stranded copper wire
- Markings on both sides
- Curved handles
- Wire looping and bending holes
- Coil spring provides fast self-opening action
- Precision-ground stripping holes
- Strong-gripping serrated nose
- Screw-shearing holes
- Closure lock for convenient storage
- Double dipped comfort grips



Part #	Model #	Strips & Cuts
54829	11055	10 - 18 Solid 12 - 20 Stranded

Self-Adjusting Wire Stripper/Cutter

- Stripping head adjusts to strip 10 to 20 AWG solid, 12 to 22 AWG stranded, and 12/2 and 14/2 Romex® wire
- Adjustable stopper controls length of the core strip
- Tensioning thumb screw for precise stripping of smaller gauge wire
- Convenient wire cutter in handle
- Grooved grips



Part #	Model #	Description
90439	11061	10-20AWG Solid, 12-22 AWG Stranded, 2/2 and 14/2 Romex®
194298	K12055	Heavy Duty Wire Stripper

Adjustable Wrenches

Extra Capacity Adjustable Wrench

- Extra capacity allows use of a smaller size wrench to handle bigger jobs, especially in confined spaces
- Precision-machined jaws
- Heat-treated for long life
- Forged heat-treated alloy steel
- Knurl turns smoothly for easy operation
- Rail is ground for precision fit
- Contoured, plastic-dipped handles
- Rust-resistant chrome-plated finish



Part #	Model #	Capacity	Overall Length
54845	D507-8	1-1/8"	8-3/8"
54846	D507-10	1-5/16"	10-3/8"

Adjustable Wrench

- Plastic-dipped handles for added comfort
- Rail is ground for precision fit
- Chrome-plated for rust resistance



Part #	Model #	Description
194308	D506-4	4" Adjustable Wrench
194307	D507-6	6-1/2" Extra Capacity Adjustable Wrench
194306	D509-8	8" Adjustable Wrench Extra Wide Jaw

Ratcheting Box Wrenches

6-Point Fully Reversible Ratcheting Offset Box Wrench

- Both ends are offset 25°
- Laminated construction
- Reverse ratcheting action by turning wrench over
- Rust-resistant, chrome-plated
- Made in the USA



Part #	Model #	Size
54848	68234	1/4" x 5/16"

Fully Reversible Ratcheting Refrigeration Wrench

- For refrigeration packing gland nuts, valve stem sockets, and beam clamp installation
- Compact with clearly marked sockets for four nut sizes
- Chrome finish



Part #	Model #	Socket Sizes
54847	68310	3/16" & 5/16" Square 1/4" & 3/8" Square

Hand Tools

Tools

Folding Hex Key Sets

9-Key Hex Set

- 2 Key positions (straight-out or right angle) for extra leverage
- Square-cut hex ends for a secure full depth fit and maximum contact with hex socket to prevent slippage and stripping of the socket



Part #	Model #	Description
54849	70591	Sizes: 5/64", 3/32", 7/64", 1/8", 9/64", 5/32", 3/16", 7/32", 1/4"

Cushion Grip Screwdrivers

Heavy-Duty Square Shank Screwdriver with Keystone Tip

- Bolster reinforces shank for hard use
- Internal flanges inside handle
- Special heat-treated, premium chrome-plated shaft
- Precision-machined tip for exact fit
- Tip-Ident® quickly identifies screwdriver type and tip orientation
- Cushion-grip handle
- Meets or exceeds applicable ASME/ANSI specifications



Part #	Model #	Tip Size	Shank Length	Overall Length
54831	600-4	1/4"	4"	8-11/32"

Round Shank Screwdriver with Profilated® Phillips Tip

- Precision-machined tip
- Internal flanges inside handle
- Special heat-treated, premium chrome-plated shafts
- Tip-Ident® quickly identifies the screwdriver type and tip orientation
- Cushion-Grip handle
- Meets or exceeds applicable ASME/ANSI specifications



Part #	Model #	Tip Size	Shank Length	Overall Length
54832	603-4	#2	4"	8-5/16"

Demolition Driver Screwdriver with Keystone Tip

- Plated metal strike cap to protect handle from hammer blows
- Heat treated metal shank runs complete length of handle to metal strike cap to transfer metal strike force



Part #	Model #	Tip Size	Shank Length	Overall Length
90361	602-4DD	1/4"	4"	9"
90362	602-7DD	5/16"	7"	12-3/8"

Cushion Grip Screwdriver Sets

4-Piece Miniature Cushion Grip Screwdriver Set

- Precision tips for an exact fit and rigorous applications
- Premium chrome-plated shaft
- Tip-Ident® quickly identifies the type of screwdriver and tip orientation
- Includes:
 - Phillips tip #0 (604-3)
 - Keystone tip 1/16" (606-2)
 - Cabinet tip 3/32" (607-3)
 - Cabinet tip 1/8" (608-3)



Part #	Model #	Description
54833	85484	4-Piece Mini Driver Set

Screw-Holding Screwdrivers

Phillips Screwdriver

- Cushion-Grip non-slip handle



Part #	Model #	Hex Size	Shank Length	Overall Length
90360	32216	#2	7"	11-1/4"

Electronics Screwdriver with Rotating End

- Four different tips in one tool
- Includes #0 and #00 Phillips plus 1/8" and 3/32" slotted tips
- Rotating cap for optimum and precise control



Part #	Model #	Description
190317	32581	4-in-1 Rotating Control Screwdriver

Insulated Slotted Cabinet Screwdriver

- Four different tips in one tool
- Includes #0 and #00 Phillips plus 1/8" and 3/32" slotted tips
- Rotating cap for optimum and precise control



Part #	Model #	Description
64481	601-7-INS	3/16" Slotted Cabinet Screwdriver 7"
64482	602-7-INS	5-16" Slotted Cabinet Screwdriver 7"

Hand Tools

Screwdriver/Nut Driver Combinations

11-in-1 Screwdriver/Nut Driver

- Shaft holds (8) popular tips and converts to (3) nut driver sizes
- Interchangeable blade
- Industrial strength, heat treated bits
- TORX® is a registered trademark of Acument Intellectual Properties, LLC
- Cushion grip handle
- Assembled in USA of US and imported components
- Includes:
 - 3/8", 5/16", and 1/4" Nut drivers
 - #1 and #2 Phillips
 - 1/4" and 3/16" Slotted
 - #10 and #15 TORX®
 - #1 and #2 Square-recess



Part #	Model #	Description
54834	32500	11-in-1 Screwdriver/Nut Driver

11-in-1 Screwdriver/Nut Driver with Valve Removal/Installation Bit

- End of handle is marked to quickly identify tool
- Cushion grip handle
- Includes:
 - 3/8", 5/16", and 1/4" Nut drivers
 - #1 and #2 Phillips
 - 1/4" and 3/16" Slotted
 - #1 and #2 Square
 - Schrader valve core removal/installation - extractor



Part #	Model #	Description
64460	32527	11-in-1 Screwdriver/Nut Driver

Magnetic Screwdriver with 32-Piece Bit Set

- Non-ratcheting screwdriver
- Cushion grip handle
- Includes:
 - TORX® - T7, T8, T10, T15, T20, T25, T27, T30, and T40
 - Fraction Hex - 3/32" 7/64", 1/8", 9/64", 5/32", and 3/16"
 - Metric Hex - 2mm, 2.5mm, 3mm, 4mm, and 5mm
 - Spanner - 4, 6, 8, and 10
 - Tri-Wing® - 1, 2, 3, and 4
 - TORQ-SET® - 6, 8, and 10
 - 1/4" Square to 1/4" hex adapter to drive sockets



Part #	Model #	Description
60179	32510	Screwdriver with 32-Pc Bit Set

Multi-Bit Screwdriver/Nut Driver Ratcheting Screwdriver/Nut Driver

- High-torque ratcheting mechanism for tough applications
- Interchangeable shaft holds 6 universal tips; converts to 3 nut driver sizes and 1 hex driver
- 3-way ratcheting mechanism for forward, reverse and locked positions
- Nut drivers are heat-treated for added strength and improved torque
- Cushion-Grip handle provide superior torque and comfort
- Contains: 3/16" (5 mm) and 1/4" (6 mm) slotted, #1 and #2 Phillips, 1/4" (6 mm), 5/16" (8 mm), and 3/8" (10 mm) nut driver, #1 and #2 square-recess, 3/8" hex driver



Part #	Model #	Shank Length	Overall Length
90356	32558	2.95"	8"

Stubby Screwdriver/Nut Driver

- Shaft holds screwdriver tips and converts to nut driver sizes
- Cushion-Grip handle
- Includes:
 - #1 and #2 square recess
 - 3/16" (5 mm) slotted
 - #2 Phillips
 - 1/4" (6 mm) and 5/16" (8 mm) nut drivers
- U.S. Patent No. D684, 836



Part #	Model #	Shank Length	Overall Length
90358	32561	1.27"	3.2"

Terminal Block Screwdrivers

- Precision machined tip for exact fit for terminal block screws
- Tip is up to 19% stronger than competitors
- Cushion-grip handle
- Tip provides 76% higher torque value than the required ASME B107 standard



Part #	Model #	Shank Tip	Shank Length	Overall Length
90363	612-4	1/8"	4"	7-3/4"
172764	32751	1/4"	4-8"	4-8"

Ratcheting Stubby Screwdriver

- Four different screwdriver bits
- Includes 1/4" and 5/16" nut drivers



Part #	Model #	Description
190316	32593	6-in-1 Ratcheting Stubby Screwdriver

Hand Tools

Screwdriver/Nut Driver Tools 10-Fold™ Screwdriver/Nut Driver Schrader® Valve Core Tool

- For HVAC and other industrial applications
- Driver arms fold conveniently into the body
- Unfold each driver arm up to a full 180°, or at 90°
- Quick release button unlocks fully extended driver arm
- Each arm contains (4) interchangeable bit-styles and (2) nut drivers
- Fits easily into pocket
- Includes:
 - 5/16" and 1/4" Nut drivers
 - #1 and #2 Phillips
 - 1/4" and 3/16" Slotted
 - Schrader® valve core removal/installation-extractor
 - #1 and #2 Square-recess



Part #	Model #	Description
90354	32534	Screwdriver/Nut Driver Schrader 10-in-1 Valve Core

Cushion Grip Nut Drivers Cushion Grip Stubby Nut Driver with Hollow Shaft

- Full hollow shaft for work on stacked circuit boards, or other long bolt applications
- For work in close quarters
- Internal flanges
- Premium chrome-plated
- Tip-Ident® quickly identifies nut driver and size
- Color-coded cushion-grip handle
- Meets or exceeds applicable ASME/ANSI specifications



Part #	Model #	Hex Size	Shank Length
54835	610-1/4M	1/4"	1-1/2"

Magnetic Tip Cushion Grip Stubby Nut Driver with Hollow Shaft

- Rare Earth magnetic tip
- Full hollow shank for long bolts or studs
- Meets or exceeds applicable AMSE/ANSI specifications



Part #	Model #	Hex Size	Shank Length
54836	610-5/16M	5/16"	1-1/2"

Cushion Grip Magnetic Tip Nut Driver with Hollow Shaft

- Rare Earth magnetic tip
- Chrome plated shaft
- Internal flanges for solid, twist-resistant shaft anchor
- Color-coded handle



Part #	Model #	Hex Size	Shank Length
54837	646-1/4M	1/4"	6"
54838	646-5/16M	5/16"	6"
54839	618-1/4M	1/4"	18"
54840	618-5/16M	5/16"	18"

Cushion Grip Nut Driver Sets Cushion Grip Stubby Nut Driver Set with Hollow Shaft

- Full hollow shaft for long bolts or studs
- Includes: - 1/4" and 5/16"
- Meets or exceeds applicable AMSE/ANSI specifications



Magnetic Tip Stubby Nut Driver Set with Hollow Shaft

Part #	Model #	# of pieces	Shank Length
64469	610M	2	1-1/2"

2-Piece Magnetic Tip Nut Driver Set with Hollow Shaft

- Rare Earth magnetic tip
- Chrome-plated shaft
- Includes: - 1/4" and 5/16"

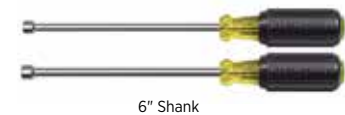

Part #	Model #	# of pieces	Shank Length
64468	646M	2	6"

HVAC 8-in-1 Slide Drive™ Screwdriver/Nut Driver

- Unique, patented head slides back and forth to switch from 1/4 inch to 5/16 inch magnetic hex-head screwdriver
- Thumb nut locks tip setting
- Features a specialty bit for installation/removal of common TR-4 Schrader® valves



Part #	Model #	# of pieces	Shank Length
193802	32596	2	3-1/4"

Hand Tools

Klein Multi Nut Driver

- Includes 3/16", 1/4", 5/16", 3/8" and 9/16" six-point hex nut drivers
- Hollow shafts accommodate long bolts



Part #	Model #	Description
190315	32801	5-in-1 Multi-Nut Driver Heavy Duty

Magnetic Hex Driver

- 3-pack
- Strong rare earth magnets for maximum holding



Part #	Model #	Description
194350	86600	1/4" Magnetic Hex Driver
194349	86601	5/16" Magnetic Hex Driver 1/4"
194348	86602	3/8" Magnetic Hex Driver 1/4"

Torpedo Lighted Level

- Rare earth magnet
- Automatic shut-off after 10 minutes
- Vials set for measurements at 0°, 45°, and 90°
- Water and impact resistant
- Machined billet aluminum design
- Includes (2) AAA batteries



Part #	Model #	Description
90364	9330RE	9" Level, Plumb & 45°
189926	935RBLT	9" Lighted

Auto-Loading Folding Retractable Utility Knife

- High quality, triple ground blades stay sharp longer
- Rubber grips on handle for improved control and comfort
- Heavy-duty durable construction
- Internal blade storage includes and holds 3 blades



Part #	Model #	Overall Length	Closed Length
90366	44130	4-1/2"	4-1/8"

Klein DK06 Duct Knife

- Cuts duct board and flexible duct
- Double-edged knife-regular and serrated
- Puncture resistant nylon sheath with belt loop
- Cushion-Grip handle for comfort



Part #	Model #	Description
194300	DK06	Duct Knife
194331	44101	Utility Knife Blades, 5 pack
194332	44131	Folding Utility Knife

Cutting & Notching Snips

Journeyman Offset Snip

- Forged steel cutting blades
- Klein Kurve® handles with soft touch grips



Part #	Model #	Overall Length	Cutting Pattern	Color Code
64461	J2100L	9-1/2"	Left/Strt	Red/Blk
64462	J2101R	9-1/2"	Right/Strt	Green/Blk

Hand Tools

Tool Bags

Tradesman Pro™ Organizer 8" Tote

- (9) Interior and (11) Exterior Pockets for tool storage
- Orange interior for easy tool visibility
- Removable zipper bag
- Tough durable feet
- 1680D Ballistic weave
- Carrying handle



Part #	Model #	Dimensions (H x W x L)
142146	55415-8	17" x 8" x 8"

Tradesman Pro™ Organizer 10" Tote

- (18) Interior and (22) Exterior Pockets for tool storage
- Orange interior for easy tool visibility
- Removable zipper bag
- Tough durable feet
- 1680D Ballistic weave
- Shoulder strap and carrying handles



Part #	Model #	Dimensions (H x W x L)
142147	55416-10	12" x 10" x 10"

Tradesman Pro™ Organizer Backpack

- (34) Interior and (5) Exterior Pockets for tool storage
- Orange interior for easy tool visibility
- Wide opening
- Tough durable molded bottom
- Large front pocket easily fits fish tapes
- 1680D Ballistic weave



Part #	Model #	Dimensions (H x W x L)
190309	55421-BP	18" x 7" x 14"

Tradesman Pro Lighted Tool Bag

- Twist on/twist off removable LED light
- 31 pockets
- 1680D ballistic weave for durability



Part #	Model #	Description
164253	55431	Lighted Tool Bag

Canvas Zipper Bag

- Constructed of No. 8 canvas
- Set of 4 colors (orange, green, yellow, and blue)



Part #	Model #	Dimensions (H x W x L)
54843	5140	7" x 12-1/2"

Tradesman Pro Hard Case Medium

- Hard shell protects tools, meters, small parts and tech devices
- Soft interior lining
- Durable zipper closure



Part #	Model #	Description
194346	5184	Tradesman Pro™ Hard Case Medium



QUALITY. SERVICE. TOMMARK.

Hand Tools

Electrical Testers

Dual Range Non-Contact Voltage Tester

- Lightweight durable polycarbonate plastic resin construction with convenient pocket clip
- Automatically detects and indicates low voltage (12 to 48VAC) and standard voltage (48 to 1,000VAC)
- High intensity, bright green LED indicates tester is operational and aids in illuminating workspace
- Digitally controlled on/off power button
- Automatic power-off feature conserves battery life
- Microprocessor controlled low-battery indicator
- CAT IV 1,000V rating



Part #	Model #	Description
74635	NCVT-2	50 - 500Hz
172772	NCVT-3	Non-Contact Voltage Tester

Beverage Tool



Part #	Model #	Description
54858	98002BT	Beverage Opening Tool

Drill Bits

Carbide-Tipped Masonry Drill Bit

- Drills through brick, concrete, plaster, and tile
- Black-oxide finish



Part #	Model #	Size
127917	53178	1/2"

Mini Aviation Snips

- Maneuverable compact length.
- Sharply defined cut.
- Comfortably fits any size hand.
- Spring-actuated, handles will not collapse.
- Self-opening latch will not accidentally catch or close



Part #	Model #	Description
194938	AVM6	cuts left
194941	AVM7	cuts right

Metal & Vinyl Snips

Max2000™ Aviation Snips

- An adjustable crossover disk assures an optimal length of cut that remains smooth and accurate
- Machined serrations on outside face of cutting edge
- Thicker, stronger steel handle resists abuse and will not collapse under normal use
- Length: 10-3/4"
- Ergonomic grip



M2001



M2002



M2004

Part #	Model #	Description	Color
17598	M2001	Cuts Left	Red
17606	M2002	Cuts Right	Green
64617	M2004	Straight Double Cut	Yellow

Max2000™ Bulldog Aviation Snips

- Designed for notching and trimming
- Ideal for cutting multiple layers or "S" cleats
- Ergonomic grip



Part #	Model #	Description	Color
17638	M2005	Cuts Straight	Red

Max2000™ Offset Aviation Snips

- Cuts straight line and 5" diameter circles
- Ergonomic grip



M2006



M2007

Part #	Model #	Description	Color
20946	M2006	Cuts Left	Red
20947	M2007	Cuts Right	Green

Hand Tools

Andy™ Combination Snips

- Straight pattern
- Lightweight aluminum handle



Part #	Model #	Description
15177	M14RB	Replacement Blade for M14

Andy™ Pattern Snips

- Ground blade edge
- Suitable for mild curve cuts, straight shearing, or cutting multiple layers of sheet metal
- Lightweight aluminum handle
- Larger handle loops
- Extended blade tips
- 3-1/4" Cutting length



Part #	Model #	Description
31523	M14N	14" Pattern Snips

Andy™ Aluminum Snips

- Beveled blade edge
- Suitable for straight shearing and left or right circular cuts down to 6" diameter
- Lightweight aluminum handle
- Larger handle loops
- Extended blade tips
- 3-1/4" Cutting length



Part #	Model #	Description
68681	MC14N	14" Comb Andy Snips
68680	MC14NRB	Replacement Blade for MC14N

AVs™ Aviation Snips

- Forged steel construction



Part #	Model #	Description
90338	AV6	Offset Left, Red Grips

Awls

Scratch Awl

- High carbon alloy tool steel blade polished to resist rust
- May be resharpened many times
- Easy-to-spot orange handles are shock and shatter-resistant

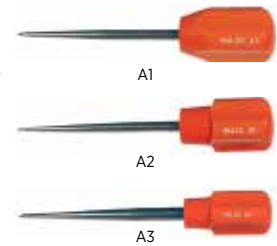

Part #	Model #	Blade Dia	Overall Length
6244	A1	7/32"	5-3/4"
6254	A2	1/4"	6-1/4"
6267	A3	3/8"	7-1/2"

Scribers

Pocket Size Sheet Metal Scriber

- (5) Teeth produce (10) scribing depths
- Compact scribe stores in pocket, pouch or tool box
- Use hang hole or magnet to keep handy on the job



Part #	Model #	Min/Max Adjustments
62471	A40	1/8" - 1" Depths

Hand Tools

Adjustable Sheet Metal Scriber

- Measure, mark and scribe in one easy operation
- Depth up to 12-1/2"
- Compact design
- Durable construction
- Constructed of rust resistant nickel plated steel
- Knob assembly with hardened steel bolt insert will not strip out
- Uses Zip-In® sheet metal screw making point replacement easy



Part #	Model #	Min/Max Adjustments
8942	A60	1/4" - 12-1/2" Depths

Dividers

- Scratch awl points are easily resharpened or replaced
- Nickel-plated steel body



Part #	Model #	Max Circle Dia	Length
4817	18	36"	11"

Folding Tools

- Folding seams are formed from (2) permanently joined steel halves



Part #	Model #	Width	Folding Depths
12537	12F	12"	3/8" & 1"
13087	18F	18"	3/8" & 1"
13654	24F	24"	3/8" & 1"

Crimpers

Redline™ 5-Blade Pipe Crimper

- 1-Hand operation latch
- Soft-touch, non-slip handle insert
- Ergonomically contoured handles



Part #	Model #	Throat Depth
63917	C5R	1-5/8"

Hand Notchers

Redline™ Hand Notcher

- 1-Hand operation latch
- Non-slip handle insert
- Ergonomically contoured handles
- Opening maximizes handle leverage



Part #	Model #	Throat Depth
64726	N1R	13/16"
63920	N2R	1"

Redline™ Hand Seamer with Forged Steel Jaw

- 1-Hand operation latch
- Non-slip handle insert
- Ergonomic handle contours



S6R



S2R

Part #	Model #	Jaw Depth	Jaw Width
63918	S2R	1-1/4"	3-1/4"
64728	S6R	1-1/4"	6"

Redline™ Offset Hand Seamer with Forged Steel Jaw

- 1-Hand operation latch
- Soft-touch, non-slip handle insert
- Ergonomically contoured handles
- Opening maximizes handle leverage



Part #	Model #	Jaw Depth	Jaw Width
63919	S3R	1-1/4"	3-1/4"

Hand Tools

Snap Lock Punches

Redline™ Snap Lock Punch for Siding

- One-hand operation
- Ergonomic handles
- Opening maximizes handle leverage



Part #	Model #	Length	Throat Depth
64727	SL1R	8"	3/8"

Crimpers

Replacement Spring

Part #	Model #	Description
22247	5018	C5, S2, S3, S6, N1, SL1

Duct Tools & Accessories

Duct Stretcher

- Use to hold duct in place with one hand while slipping drive cleat in place with other hand
- Additional spacing holes allow wheels to be adjusted to span greater distances
- Rugged anodized aluminum body features large vinyl cushion grip and hang-up hole



Part #	Model #	Description
14425	DS1	16"
14433	DS2	16", Offset Handle

Pipe & Duct Holder

- Like an extra pair of hands
- (2) Clamps and 4' of 125 lb tensile strength linked chain
- Clamp handles are 8" long
- Both clamps and chain are nickel-plated steel



Part #	Model #	Description
15274	2DH	1 Pair of Clamps and Chain

Fiberglass Flex Duct Tools

Tensioning Tool

- Action tie tools feature a unique notched gripper
- Comfortable handles reduce the pinch point area
- Works on all ties
- 6" Length



Part #	Model #	Description
788	TY4G	Manual Cut-Off Tie Tool with Grip

Tensioning Tool with Auto Cut-Off

- Hardened steel stampings with weather-resistant nickel chrome finish
- Vinyl cushion grips with hand stops
- Tensioning adjustment knob



Part #	Model #	Description
11162	TY6	High Leverage Tie Tool

Flex Duct Shear

- Thumb operated latch
- Smooth scissor action
- Heavy-duty wire cutter



Part #	Model #	Description
25929	FDC2	Flex Duct Shear
1799	FDC1	Flex Duct Cutter

Utility Caulk Gun

- Spouted cartridge application
- User can regulate stroke to fit hand
- Handy puncture wire folds inside handle



Part #	Model #	Capacity	Dia
12368	CG10	1/10 gal	2"

Hand Tools

Tubing Tools

Tube Bender

- Use for bending soft tubing to any shape without collapsing walls
- Spring steel is nickel finished
- One end flared for quick tube insertion



Part #	Model #	Description
16297	TB102K	5 Sizes, 1 Ea of 1/4", 3/8", 1/2", 5/8", 3/4" OD

Combination Swaging Punch

- (3) Sizes in one tool
- Knurled stock for easy removal of punch



Part #	Model #	Description
5705	ST94	1/2", 5/8", 7/8" OD, 3/8", 1/2", 3/4" Nom

Magnetic Power Return Tip Tape Measure

- Ultraviolet curing extends blade life
- Impact-resistant cases
- Reinforced end hook
- Nylon-coated blade
- Yellow blade



Part #	Model #	Size
90335	T425M	1" x 25'

Klein Measuring Tape

- Dual angle magnetic hooks attach to conduit and steel studs
- Up to 9-1/2 ft. stand-out



Part #	Model #	Description
190314	86225	25' Double Hook Magnetic Tape Measure

Top Reading Torpedo Level

- Three large vials plumb, level and 45°
- White vial holders and top read feature



Part #	Model #	Description	Length
1059	L9M	Magnetic Level	9"

Setting Sheet Metal Hammer

- 1-Piece forged, I-beam construction
- Full-polished heads with beveled face and pein are corrosion-resistant
- Hammer sections are individually hardened and tempered for strength and resiliency
- Face size: 7/8"
- Overall length: 11-3/4"



Part #	Model #	Size	Handle	Head Wt
38856	SH3V	5-1/2"	Vinyl	18 oz

Electrical Cutter/Stripper/Crimper Pliers

- Up front scissors action strips copper wire clean and cuts easily sizes 10-20 and 22-14 (red and blue)



Part #	Model #	Crimping	Length
90337	WSC8	22-10 Gauge	8-1/4"

Yellow Jacket HVAC/R Tools

- Quick change bending mandrels and shoes
- Trouble free ratchet mechanism
- Index marks to locate bends
- Complete tube bender kit includes all items required to bend 1/4", 5/16", 3/8", 1/2", 5/8", 3/4" and 7/8" tubing
- Reverse bending mandrel included in 60325 kit and sold separately (60342)



Part #	Model #	Description
137358	60325	Tube Bender with Reverse Bend Adapter 1/4" to 7/8" W/Case
30766	60331	Tube Bender with 1/4" to 7/8" W/Case
37854	60342	Reverse Bend Adapter for 60331
79829	60493	Hydraulic Tubing Expander

Hand Tools

Ratchet Wrenches

Offset Square Ratchet Wrench

- For installing or servicing heating, air conditioning or refrigeration units



Part #	Model #	Sizes
90347	RRW5	3/16", 1/4", 5/16", 3/8"

Shank Refrigeration Wrench Insert

- For installing or servicing heating, air conditioning or refrigeration units



Part #	Model #	Sizes
473	RRW316	3/16"
361	RRW516	5/16"

Nut Drivers

CONNEXT™ Pre-Assembled Magnetic Hex Driver

Long Lengths

- CONNEXT™ Quick change handles
- Magnetic hex chuck driver shaft components
- Use with Zip-In® and "A" hex head screws



Part #	Model #	Hex Dia	Shaft Length	Grips
5456	HHD1	1/4"	6-7/8"	Red
5467	HHD2	5/16"	6-7/8"	Yellow

CONNEXT™ Hollow Hex Chuck Driver

- Use with CONNEXT™ Quick change handles
- Precision-fit and hardened hollow hex chuck driver shaft components
- 1/4" Power insert shanks
- Color-coded



Part #	Model #	Hex Dia	Depth	Grips
64729	HD1	1/4"	1-1/2"	Red
64730	HD2	1/4"	3"	Red
64731	HD3	5/16"	1-1/2"	Yellow
64733	HD5	3/8"	1-1/2"	Blue

CONNEXT™ Dual-Sided Magnetic Hex Driver

- Easy-clean magnet
- Ideal for use with Malco Zip-in and Bit-Tip screws



Part #	Model #	Description
190392	MSHC	Reversible Hex Chuck Driver

CONNEXT™ Quick Change Handle

- Clear, molded acetate handles are shock-proof, shatter-proof and fluted to fit any hand
- Equipped with a quick-connect holder mechanism to accept any 1/4" shank chuck driver
- Grip diameter: 1-1/8"
- Holder opening: 1/4" hex



Part #	Model #	Grip Length	Holder Dia	Holder Length	OAL
90330	CONNEXT2	1-7/8"	11/16"	1-1/8"	3-1/8"

CONNEXT™ Kits

CONNEXT™ 9-Piece Magnetic Hex Driver Kit

- Includes:
 - Cordura pouch with belt-clip and Velcro closure
 - (2) 1/4" & 5/16" Driver shafts in short, medium and long varieties
 - (3) Handles, including stubby, full grip & full grip ratcheting style



Part #	Model #	Description
90331	CONNEXT4	9-Piece Magnetic Hex Driver Kit

Hand Tools

Aviation Snips

Regular Snips Forged Blade Standard Hardness Model

- Serrated blades
- Cuts wide curves
- 9-3/4" Nominal length
- Cutting capacity: 18 gauge cold rolled, 22 gauge stainless steel



Part #	Model #	Type	Cut Length
43576	P6716S	Straight	1-3/8"
43577	P6716L	Left	1-1/4"
43579	P6716R	Right	1-1/4"

Regular Notch Cut Snips Forged Blade Standard Hardness Model

- Cuts thick materials, multiples layers of materials and seams
- Serrated blades
- 9" Nominal length
- Cutting capacity: 16 gauge cold rolled, 18 gauge stainless steel



Part #	Model #	Type	Cut Length
43588	P6716B	Bulldog	7/8"

Offset Snips Forged Blade Standard Hardness Offset Model

- Bottom blade serrated
- Cuts tight curves and straight
- 9-3/4" Nominal length
- Cutting capacity: 18 gauge cold rolled, 22 gauge stainless steel

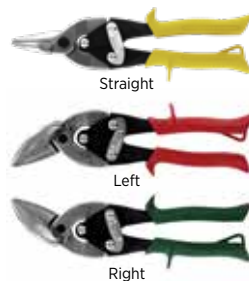

Part #	Model #	Type	Cut Length
43583	P6510S	Straight	1-1/2"
43585	P6510L	Left	1-1/4"
43586	P6510R	Right	1-1/4"

Upright Snips® Forged Blade Upright® Model

- Top blade serrated optimum 40 serrations per inch
- Use with blades up or blades down in push or pull motion
- Ideal for working in confined areas
- Ergonomic design
- Cuts tight curves, circles and straight
- 8-3/4" Nominal length
- Cutting capacity: 24 gauge cold rolled, 28 gauge stainless steel



Part #	Model #	Type	Cut Length
43275	P6900L	Left	1-1/4"
43274	P6900R	Right	1-1/4"



Screwdrivers

6-In-1 Screwdriver



Part #	Model #	Description
90822	MA-9358	6-in-1 Heavy-Duty Rubber Grip

Screwdriver Set



Part #	Model #	Description
90828	MA-AP8SD	8-Piece Set

Hand Tools

Inspection Mirrors



Part #	Model #	Description
90844	MA-142A	2-1/4" Round, Telescopic 9-1/4 - 14-1/4
90845	MA-142MA	2-1/4" Round Magnifying Telescopic 9-1/4"-14-1/4"
90856	MA-143A	1-1/4" Round w/Pocket Clip, Telescopic 7"-19"
90848	MA-143M	1-1/4" Round Magnifying with Pocket Clip, Telescopic 7"-19"
90857	MA-149	2-1/8" x 3-1/2" Rectangular, 11"-15-1/2" Handle
90843	MA-157A	1" x 2" Oval w/Pocket Clip, Telescopic 7"-19"
90846	MA-SM7	2" x 3-3/4" Rectangular, Stainless Steel
90840	MA-IM24	Rectangular with (2) LEDs
90838	MA-IM30	3" Dia x 11-1/8" Long Round Telescopic with (2) LEDs, Extends to 34-1/4"

Pick-Up Tools

- Magnetic
- Picks up to 10 lbs
- Extends up to 32"



Part #	Model #	Description
90835	MA-159A	Pick-Up Tool with Swivel Head

Tube & Hose Cutters

PVC Pipe Cutter



Part #	Model #	Max Cut
90827	MA-S25	1"
90830	MA-L42	1-1/4"

Vinyl Tubing Cutter

- Cuts vinyl tube, PVC pipe, and rubber tubing



Part #	Model #	Description
90829	MA-VTC1	Vinyl Tube, PVC Pipe, & Rubber Tubing

Deburring Tools



Part #	Model #	Description
90821	MA-49310	Deluxe
90825	MA-49316	All Metal with Fixed Blade

Swaging Tools



Part #	Model #	Description
90824	MA-49318	6-in-1: 3/16", 1/4", 5/16", 3/8", 1/2", & 5/8" OD

Knives

- Cut duct board, flex-duct and insulation
- Includes: Carrying case easily attaches to belt
- Dims: 11"H x 1-1/2"W x 1/2"D



Part #	Model #	Description
178786	MA-KN74HD	Heavy Duty Duct Board Tactical Knife

Hand Tools

Magnetic Adjustable Work Light

- 180° Adjustable swiveling lamp head
- Magnet holds approximately 50 lbs on any metal surface
- Sturdy metal lamp guard
- 3-Wire grounding outlet



Part #	Model #	Includes
60199	MA-748325A	25' Cord

Fan Tools & Accessories

Hub Pullers

- Includes alignment tool



Part #	Model #	Description
14195	MA-FB2	Pulls fan blades and blower wheels; Alignment Tool Included

Flashlights

Water-Resistant LED Flashlight

- Impact-resistant rigid aluminum alloy body
- Includes nylon pouch and AA battery



Part #	Model #	Lamps
55120	MA-0620	5

LED Flashlight

- Includes batteries



MA-FL3BU



MA-FL3A

Part #	Model #	Description
195079	MA-FL3BUV	(10) White LEDs, (5) UV LEDs, (1) Laser, & Compass. Includes (3) AAA Batteries & Strap
90842	MA-AP132	(6) LED Pen Light
90839	MA-FL3A	(3) LED Extendable with Flexible Neck

BRAMEC®

Extend-A-Mirror™

- Telescopic to 19" except 9068 (15")
- Features a double ball-joint with nylon insert locking nut for 360° viewing without mirror movement due to a loose joint
- Made of durable chrome-plated brass with a pocket clip
- Carded



9062



9063



9068

Part #	Model #	Description
5717	9062	2-1/4" Round
5727	9063	1" x 2" Oval
5764	9068	2-1/8" x 3-1/2" Rectangular

Hand Tools

Tools

Work Lights

LED Task Light with Laser Pointer

- Aerospace grade aluminum body provides impact resistance
- Anti-roll body design
- On/Off switch controls area/spot/laser lights individually
- Super bright LED's for years of maintenance-free operation
- The 16-LED area function emits (32) lumens of clear bright light
- The 8-LED spot function emits (16) lumens bright directional light
- Red laser pointer function
- Heavy-duty base magnet provides hands-free convenience
- Includes (3) AAA Eveready batteries included for up to 6 hours of area lighting use and up to (12) hours use as spot directional light



Part #	Model #	Description
86416	L1407	(16 + 8) LED with Laser, Counter Display
127407	L1411	(16 + 8) LED with Laser, Blister Pack

SJT PVC Trouble Light

- Round orange vinyl jacket
- Dual hook system hangs the work light by either the guard or handle
- UL Listed



Part #	Model #	AWG/Cond	Length	Rating
127410	691	16/3	25'	75W
127411	692	16/3	50'	75W

Light Bulbs

Rough Service Coated Shatterproof Bulb



Part #	Model #	Watt
20876	79175	75

Portable LED Work Light

- Weatherproof pushbutton power switch



Part #	Model #	Lamps
127413	L1681	22

Eco-Zone™ Portable LED Work Light

- Long lasting lithium battery with 2-hour run time on full charge
- No maintenance costs, bulbs never need to be replaced
- Superior heat management system equals longer UEI life and fixture stays cool to the touch
- Heavy-duty, die cast aluminum housing with weather-proof pushbutton power switch



Part #	Model #	Description
127412	L1320	(24) SMD LED, (779) Lumens High Intensity, Rechargeable

LED Head Lamps

- Adjustable headband
- Weatherproof switch



Part #	Model #	Lamps
127408	L1240	21

Hand Tools

Extension Cords

- Striped cords feature a dominant color and an extruded colored stripe that runs the length of the cord
- Contractor grade SJTW cord features a high gloss jacket
- Clear molded plugs with power-indicator light in female end to show that power is on
- Heavy-duty strain relief and reinforced blades and ground pin
- UL Listed; CSA Certified



Stripes™ Outdoor Extension Cord

Part #	Model #	AWG/Cond	Length	Color
127405	02548USA1	12/3	50'	R/W/B
127406	02549USA1	12/3	100'	R/W/B

Extension Cord

Part #	Model #	AWG/Cond	Length	Color
127402	024088804	14/3	50'	Red
127403	02498804	14/3	100'	Red

Vinyl SJTW Outdoor Extension Cord

- Vinyl jacket resists moisture, abrasion and prolonged exposure to sunlight
- Reinforced blades help prevent accidental bending or breaking
- Molded plugs and heavy-duty strain relief protects electrical connections resulting in longer cord life
- Outer jacket won't mark floors or walls
- Operating voltage: 125VAC
- CSA Certified
- cULus Listed
- Meets OSHA requirements for outdoor use



Part #	Model #	AWG/Cond	Length	Current Rating
162228	10693908	14/3	50'	15A

Vinyl SJTW Outdoor Extension Cord, Lighted End

- General indoor/outdoor cord for power equipment
- Yellow vinyl jacket resists moisture, abrasion and prolonged exposure to sunlight
- Reinforced blades help prevent accidental bending or breaking
- Molded plugs and heavy-duty strain relief protects electrical connections
- Outer jacket won't mark floors or walls
- cULus Listed
- Meets OSHA requirements for outdoor use



Part #	Model #	AWG/Cond	Length	Current Rating
127404	02588-00-02	12/3	50'	15A

Tri-Source® 3-Way STW Power Block Extension Cord

- Yellow
- Amperage: 15A



Part #	Model #	AWG/Cond	Length
127401	04112-88-02	12/3	2'

Hand Tools

S2 Plastic Tubing Cutter

- High carbon steel blade cuts rigid plastic tubing with a single cut
- Rubberized handles
- Cast aluminum body
- Conveniently positioned locking latch allows for one-handed operation of spring-loaded cutter



Part #	Model #	Description
90404	12122S2	Cuts up to 1" nominal, 1-5/16" OD

Utility Knives

Lenox® Gold™ Quick Change Knife



Part #	Model #	Description
44399	20353-SSRK1	Retractable Blade Knife with (3) Blades
41584	20350-GOLD5C	Replacement Blades, 5/Pk

Lenox® Gold™ Locking Tradesman Utility Knife

- Easy open and close secure locking mechanism
- Ergonomic, rubberized comfort grip
- Multi-use tool; bottle opener, screwdriver and pipe reamer
- Built-in wire stripper



Part #	Model #	Description
64760	10771	Locking Tradesman Utility Knife

All-In-One Screwdrivers



Part #	Model #	Description
64764	23932	9-In-1

Sharpie® Permanent Markers

Part #	Model #	Description
42481	15001-SH	King Size Black
49140	30101-SH	Fine Size



A MUNCH'S SUPPLY COMPANY

We are a full line wholesaler. Contact us for information about items not listed in this catalog.

Hand Tools

Tube Cutters

ROTRAC PLUS Copper Tube Cutter

- Rolling stop to protect cutter wheel
- Protected screw spindle to shield against dirt and jamming
- Lightweight cast aluminum body
- Deburrer swivels up and spare cutter wheel is stored in handle
- Compatible with Yellow Jacket 60120 cutting wheels



Part #	Model #	Description
65034	RT70021	Copper Tube 1/4" to 1-5/8" OD

Mini Tube Cutter

- Use for cutter copper tubes
- Large knurled knob for fatigue-free pressure control
- (2) Guide rollers with recess assist with cutting close to flares
- Compatible with JB Industries RT70017 and Yellow Jacket 60120 cutting wheels



Part #	Model #	Description
65036	RT70402	Copper 1/4" to 7/8" OD

Replacement Cutter Wheel

- Compatible with Mini and Professional tube cutters

Part #	Model #	Description
68034	RT70007B	Replacement Cutter Wheel for ROTRAC PLUS, 2/Pk
65038	RT70017B	Replacement Cutter Wheel, 2/Pk

Multi-Swage

- Handy all-in-one tool
- T21000: 3/16" 1/4", 5/16", 3/8", 7/16", 1/2", 5/8", 3/4" and 7/8" OD



Part #	Model #	Description
1934	T21000	(3) Pieces for (9) OD Sizes

Lenox Tubing Cutters

- Ergonomical design
- Four roller tracking keeps tube from threading
- Professional deburring
- Full-stop feed system prevents damage to cutting wheel
- Change out wheels with only a screwdriver
- Storage in handle for extra cutting wheel



Part #	Model #	Tube Diameter Range
64762	21009	1/8" to 1"

Big-Imp® Tube Cutter

- For 3/8" to 1-1/8" (10 to 28mm) OD tubing (1/4" to 1" nom)
- Requires only 1-15/16" swing radius (2-1/4" with 1-3/8" tube)
- Size: 2-11/16" x 1-1/32" x 1-1/8"
- Weight: 5 oz
- Skin-packaged



Part #	Model #	Tubing OD
40422	174F	3/8" to 1-1/8"

Imp® Mini Tube Cutter

- Requires only 1-1/4" swing radius (1-3/8" with 5/8" tube)
- Repositioned rollers to bottom of tool allow for easier cutter engagement on tubing
- Enclosed feed screw minimizes contamination, assuring continued free operation
- Redesigned feed mechanism improves overall cutting action



Part #	Model #	Tubing OD
40421	TC-1050	1/8" to 5/8"

Hi-Duty® Tube Cutter

- Unique design eliminates spiraling



Part #	Model #	Tubing OD
17642	TC-1000	1/8" to 1-1/8"
40423	312-FC	1/4" to 1-5/8"

Tubing Cutter Replacement Parts



Part #	Model #	Description
40424	TC1A	Cutter Wheel Kit, 4 Pcs
40425	TC1C	Cutter Wheel Service Kit, 3 Pcs

Hand Tools

Ratchet Wrenches

- Chrome plated
- Specially designed for use on compressors with access valves in hard to reach places



Part #	Model #	Description
40438	127-C	1/4", 3/8", 3/16", and 5/16" Square Reversible Drives



Edge Scribes

- For simple and easy marking of metal sheets
- Attached magnet keeps tool within reach
- Marks 1/8", 3/16", 1/4", 5/16", 3/8", 1/2", 5/8", 3/4" and 1"



Part #	Model #	Description
14019	10015	Stainless Steel Scribe

Hammers

Steel Tinner's Hammer

- 1-Piece solid polished steel



Part #	Model #	Description
26757	DDTH-18	18 oz. Steel Tinner's Hammer



Shears

TurboShear™

- Inserts into chuck of 1,200 rpm A/C or cordless drill
- Offset design saves hands
- Navigates tight patterns and square cuts
- 20 Gauge capacity in galvanized steel
- Cutting applications include both ferrous and non-ferrous sheet metals, metal roofing/building panels, vinyl, steel mesh, ductwork, furnace jackets, equipment enclosures, or automotive body panels
- Optional TSDC drill clamp



Part #	Model #	Description
36596	TS1	TurboShear™
36617	TSIRB	TurboShear™ Replacement Blades

TurboShear HD™ Drill

- Inserts into chuck of 14.4V or larger A/C or cordless drill
- Navigates tight patterns and square cuts
- 18 Gauge capacity in galvanized steel



Part #	Model #	Description
81078	TSHD	TurboShear HD™ with Clamp
135571	TSHDRB	TurboShear HD™ Replacement Blade

Hand Tools

Hole Cutters

"Gold Standard" Hole Cutter

- Cuts holes up to 12" diameter in 20 gauge sheet metal
- Use with any standard 1/4" electric drill
- Cast aluminum body
- All wearing parts made of special heat-treated steel



Part #	Model #	Description
16869	HC1	2" - 12" Hole Diameter

Hole Cutter Replacement Part

- Cuts holes up to 12" diameter in 20 gauge sheet metal
- Use with any standard 1/4" electric drill
- Cast aluminum body
- All wearing parts made of special heat-treated steel

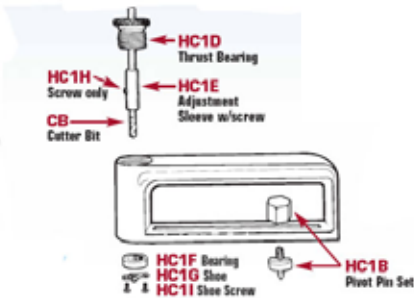

Part #	Model #	Description
6620	CB	Malco Bit for HC1 & HC2
18238	HC1B	Pivot Pin Set for HC1

Power Bits

Color Coded Magnetic Hex Driver Bit

- 1/4" Shank diameter



Part #	Model #	Hex Open	Nose Dia	Color	OAL
14458	MSH1/4	1/4"	7/16"	Red	1-3/4"
15612	MSH5/16	5/16"	1/2"	Yellow	1-3/4"
16516	MSH3/8	3/8"	9/16"	Blue	1-3/4"

Long Style Magnetic Color Coded Hex Driver Bit

- 1/4" Shank diameter



Part #	Model #	Hex Open	Nose Dia	Color	OAL
6515	MSHL1/4	1/4"	7/16"	Red	2-9/16"
8704	MSHL5/16	5/16"	1/2"	Yel	2-9/16"

Extra Long Style Magnetic Color-Coded Hex Driver Bit

- 1/4" Shank diameter



Part #	Model #	Hex Open	Nose Dia	Color	OAL
18269	MSHML1/4	1/4"	47.16"	Red	4"
12333	MSHXL1/4	1/4"	7/16"	Red	6"
90332	MSHML5/16	5/16"	1/2"	Yellow	4"
36961	MSHXL5/16	5/16"	1/2"	Yellow	6"

Power Bit Extension

- Ball bearing on holder provides a positive lock on 1/4" hex
- Tempered steel
- Black finish
- 9/16" Nose diameter



Part #	Model #	Hex Open	OAL
27741	BHE6	1/4"	6"
54559	BHE10	1/4"	10"

Tools

Furnace Fooler



Part #	Model #	Description
146517	FF-75	Door Switch Depression Tool

Blades

Reciprocating Saw Blades

Lenox® Gold™ Reciprocating Blade

- Longest lasting blade ever™
- Reinforced tooth design and precision applied titanium coating dissipate heat
- Titanium coating makes teeth more wear resistant so they stay sharp for quicker cuts
- Bi-metal design stands up to the most demanding applications



Part #	Model #	Applications	TPI	L x W x Thick	Pkg Qty
44405	21060-656G	Wood, Nail-Embedded Wood, Drywall & Plaster	6	3/4" x 6" x .050"	5
44403	21067-614G	Thick to Medium Metal (3/32" - 1/2")	14	3/4" x 6" x .035"	5
44404	21069-618G	Medium Metal (3/32" - 5/16")	18	3/4" x 6" x .035"	5
44406	21070-818G	Medium Metal (3/32" - 5/16")	18	3/4" x 8" x .035"	5

Demolition Blade

- Engineered to rip through a wide array of materials with ease including structural steel, lumber, pipe and nail embedded wood
- Wider and thicker to stand up to the brutal conditions in demolition applications
- Shatter resistant, bi-metal design provides the flexibility and durability



Part #	Model #	Applications	TPI	L x W x Thick	Pkg Qty
6212	20598-966R	Demolition, Nail-Embedded Wood, Drywall & Plaster	6	7/8" x 9" x .062"	2
64743	20371-966R5	Demolition, Nail-Embedded Wood, Drywall & Plaster	6	7/8" x 9" x .062"	5
10839	20597-960R	Demolition	10	1" x 9" x .062"	2

Bi-Metal™ Reciprocating Saw Blade

- Patented TUFF TOOTH™ design provides long blade life
- Optimized for specific applications
- Shatter resistant, bi-metal design provides the flexibility and durability single-metal blades can't



Part #	Model #	Applications	TPI	L x W x Thick	Pkg Qty
18548	20575-634R	Wood	4	3/4" x 6" x .050"	5
17821	20560-606R	Wood, Non-Ferrous Metal, Plastics & Composites	6	3/4" x 6" x .035"	5
17190	20572-656R	Wood & Nail-Embedded Wood	6	3/4" x 6" x .050"	5
18437	20570-636RP	Drywall & Plaster	6	3/4" x 6" x .050"	5
30236	20530-B656R	Wood & Nail-Embedded Wood	6	3/4" x 6" x .050"	25
12359	20582-956R	Wood & Nail-Embedded Wood	6	3/4" x 9" x .050"	5
16369	20585-156R	Wood & Nail-Embedded Wood	6	3/4" x 12" x .050"	5
7722	20562-610R	Wood, Non-Ferrous Metal, Plastics & Composites	10	3/4" x 6" x .035"	5
9086	20580-810R	Nail-Embedded Wood, Non-Ferrous Metal Thick Metal (1/8" - 1/2"), Plastics & Composites	10	3/4" x 8" x .050"	5
16772	20564-614R	Non-Ferrous & Medium Metal (3/32" - 5/16")	14	3/4" x 6" x .035"	5
6632	20566-618R	Non-Ferrous & Thin Metal (1/8" & Less)	18	3/4" x 6" x .035"	5
30233	20529-B618R	Non-Ferrous & Thin Metal (1/8" & Less)	18	3/4" x 6" x .035"	25
1379	20578-818R	Non-Ferrous & Thin Metal (1/8" & Less)	18	3/4" x 8" x .035"	5
15888	20568-624R	Thin Metal (1/8" & Less)	24	3/4" x 6" x .035"	5
43244	20174-6118R	Atructural Steels and All Metals 1/16" to 1/4"	18	1" x 6" x .035"	

Models and Specifications are Subject to Change Without Notice

Hole Saws & Accessories

Hole Saws

Bi-Metal Hole Saws

- Use arbor 2L, 3L, 6L, or 7L
- TUFF TOOTH™ design is reinforced to cut stronger and last longer
- Patented VARI-TOOTH® design resists tooth stripping
- High speed steel teeth resist breaking and offer extended life
- (1) Per box



32L



40L



58L

Part #	Model #	Dia	Pipe Tap	Pipe Entr.
9583	30032-32L	2"	-	1-1/2"
6150	30040-40L	2-1/2"	-	2"
5335	30042-42L	2-5/8"	2-1/2"	-
17652	30058-58L	3-5/8"	-	3"
14997	30064-64L	4"	-	-
14034	30066-66L	4-1/8"	-	3-1/2"
64746	30068-68L	4-1/4"	4"	-
11553	30072-72L	4-1/2"	-	-

Lenox® Blue Carbide Tipped Hole Saw

- Use arbor 2L, 2SL, or 7L
- Cuts abrasive materials, lasts up to 10 times longer than standard
- Uses standard arbors, recommend carbide tipped pilot drill
- (1) per box

Part #	Model #	Dia	Pipe Tap	Pipe Entr.
64748	30242-42CT	2-5/8"	2-1/2"	-

Hole Saw Arbor

- 7L "Ejector Arbor" makes removal of material from inside of hole saw easier



Part #	Model #	Fits Hole Saws	Size	Shank
7972	1779801	20L-96L	1/2"	Solid Hex
8147	1779805	20L-96L	3/8"	Hex

Pilot Drill Bit



Part #	Model #	Dia	Pipe Tap	Pipe Entr.
14797	30850-4321	1L, 2L, 4L	1/4"	1

Arbored Hole Saw 10-Piece Plumbers Kit

- Designed for professional trades
- Includes:
 - (1) Each 3/4", 7/8", 1-1/8", 1-1/2", 1-3/4" and 2-1/4" Hole saws
 - (1) Each 2L and 5L Snap-back arbors
 - Pilot drill
 - Arbor adapter
 - Plastic case



Part #	Model #	Description
90401	1853786	10-Pc Hole Saw Kit

Vari-Bits®

Vari-Bit® Step Drill Bit

- High speed steel construction and steam oxide coating
- (2) Cutting flutes for clean burr-free holes



VB2



VB12

Part #	Model #	Number Hole Sizes	Hole Sizes	Elec Drill Size
1408	30882-VB2	9	1/2" - 1"	3/8"
8986	30912-VB12	5	7/8" - 1-3/8"	3/8"

Wood Bits

Bi-Metal Self-Feed Wood Drill Bit

- High speed steel cutting edit
- Chamfered edge, flutes remove excess wood chips
- Lead screw tip
- Shank cuts 4" x 4" without extension
- Quick change



Part #	Model #	Description
90402	1787566	2-9/16"

Drill Bits

Twin End Drill Bit



Part #	Model #	Item #	Size	Decimal Size
13295	24015	TED-1/8	1/8	0.1250

Brushes

Fin Combs



Part #	Model #	Description
90832	MA-MFC1	Adjustable All Metal
90831	MA-MFC2	Metal with Handle Grip
90833	MA-MFC3	6-In-1: 8, 9, 10,12, 14 & 15 FPI

Brushes

BRAMEC®

Chip Brush

- Ideal for applying adhesives and paint



Part #	Model #	Description
7325	9229	3" Wide

Condenser Fin Whisk Brush

- For cleaning condenser fins and evaporators
- Has hundreds of uses



Part #	Model #	Description
136905	9216	With Plastic Handle

Stove and Appliance Brush

- For general purpose cleaning



Part #	Model #	Description
7273	9222	Stainless Steel Bristles

Copper Tube Fitting Brush

- Stainless steel wire
- Hand-fitting poly grip



Part #	Model #	Description
34556	9111	3/8" OD

Duct Cleaning Brush

- Black fiber bristles twisted in wire
- 2-1/8" Dia x 7" brush



Part #	Model #	Description
7373	9235	48" OA Length

Radiator Cleaning Brush

- Black horse hair twisted in wire
- Sturdy wood handle
- 2-1/8" Dia x 7" brush length



Part #	Model #	Description
7363	9234	27" OA Length



Brushes

Wire Handle Fitting Brush

- High-strength, high quality steel bristles
- Cleans and prepares metal fittings for joining



Part #	Model #	Size
12191	31336	1/2"
12232	31337	3/4"
12274	31338	1"

Plastic Handle Fitting Brush

- High-strength, high quality steel bristles
- Cleans and prepares metal fittings for joining



Part #	Model #	Size
12392	31328	3/4"

Tube Cleaning Brush

- Cleans and prepares copper tubing for joining with fittings
- High quality stainless steel



Part #	Model #	Size
12545	31346	3/4"

Acid, Flux, and Swif® Solder Brush

- Metal shaft, natural bristle brush



Part #	Model #	Size
12867	30711	1/2"

Brushes

Oatey®

4-in-1 Brush

- Long lasting high carbon steel brushes
- For cleaning the ID of hand-tempered steel and the OD of 1/2" and 3/4" copper tube fittings



Part #	Model #	Description
8555	31407	4-in-1 Brush, Carded

Torches & Accessories

Tools & Accessories

Fin Comb

- Long lasting high carbon steel brushes
- For cleaning the ID of hand-tempered steel and the OD of 1/2" and 3/4" copper tube fittings



Part #	Model #	Description
25461	FCR6	Handy Ring Set with (6) Fin Combs on Ring

Packard Adjustable Metal Fin Comb



Part #	Model #	Description
178768	PFC550	Packard Adjustable Metal Fin Comb

Acetylene Torches

Extreme™ Self-Lighting Air Acetylene Torch Kit

- Extreme™ swirl technology
- Quick disconnect handle and tip
- Replaceable tip
- Color-coded o-rings for gas identification
- Includes:
 - Gauge guards
 - Cylinder wrench
 - Hose (AH-12)
 - Instruction manual



PL-8ADLX-MC



PL-8ADLX-B



PL-12ADLX-B

Part #	Model #	Model #	Soft solders to:	Silver brazes to:	Regulator	Handle	Tip	Tank Connection	Valve Position
34737	PL-8ADLX-MC	0386-0834	2"	1"	AR-MC	G4	PL-8A	MC	Rear
40251	PL-8ADLX-B	0386-0835	2"	1"	AR-B	G4	PL-8A	B	Rear
23719	PL-12ADLX-B	0386-0836	4"	2"	AR-B	G4	PL-12A	B	Rear

Extreme™ Self-Lighting Air Acetylene Replacement Tip

- Removable orifice screw
- Color-coded O-rings for gas identification



PL-5A



PL-8A



PL-12A

Part #	Model #	Model #	Tip Size	Soft solders to:	Silver brazes to:
16500	PL-5A	0386-0818	1/4"	3/4" - 1-1/2"	1/4" - 3/4"
25747	PL-8A	0836-0819	5/16"	1" - 2"	1/2" - 1"
5894	PL-12A	0386-0820	3/8"	2" - 4"	1" - 2"

Air-Acetylene Rolling Tote Kit

- Metal framework
- Telescoping pull handle
- Metal sleeve for hot tip storage
- Adjustable vehicle security strap
- Includes:
 - Tips (PL-8A and A-3)
 - Torch handle (G4)
 - Regulator (AR-B)
 - Hose (AH-12)
 - Tote case



Part #	Model #	Description
82884	TDLX2010BAG	Rolling Tote Only

Torches & Accessories

Tools

Air-Acetylene Components Acetylene Torch Regulator



Part #	Model #	Model #	Description
7216	AR-MC	0386-0726	Fits "MC" Tank

Nitrogen Purge Kits NFM-TT Nitrogen Flowmeter

- For nitrogen purging
- Brass body construction
- Outflow: 0 to 75 SCFH and 0 to 35 LPM
- 1/4" FFir Inlet
- Maximum inlet pressure: 50 psi
- 1/4" MFir Outlet
- Over-pressure safety relief valve
- Provides visual confirmation of gas flow



Part #	Model #	Model #	Description
82297	0386-0849	NFM-TT	Nitrogen Purge Flowmeter

Nitrogen Purge Components Nitrogen Purging Regulator

- 2" Gauges
- Forged brass



Part #	Model #	Model #	Connection	High Pressure	Low Pressure	Delivery Range
16237	245-03P	0386-0814	CGA-580	4,000 psig	600 psig	0 - 500 psig

TurboTorch® Parts & Accessories Fitting



Part #	Model #	Model #	Description
17117	BTMCR	0386-0503	"MC" Regulator to "B" Cylinder Adapter

Flint & Flint Striker



L-1



F-1

Part #	Model #	Model #	Description
9387	L-1	1423-0061	Single Flint Striker
3706	F-1	1423-0024	Box of (5) Flints for L-1 Striker

Torches & Accessories

Hose



Part #	Model #	Model #	Description
4856	AH-12	0386-1090	12' Acetylene Hose with "A" Fittings

TurboTorch Part



Part #	Model #	Model #	Description
125384	0386-1226	TK	Tank Key for "B" & "MC" Tank Valves

Propane & MAP-Pro™ Torches

TX-500 MAPP® or Propane Torch Kit

- Swirl Flame
- MAPP/LP Gas
- Self-Lighting
- Welding Hand Torch



Part #	Model #	Model #	Description
39209	TX-500	0386-1299	Pro-Pak Includes TX504 Hand Torch & T-503 Tip

Torch Supplies

Hand Torch Gas

- Map-Propane Type
- Application HVAC
- #TT-LP Leak Detector



Part #	Model #	Description
84542	332401	14.1 oz NRT Map Pro Gas

Acetylene, CO2, Nitrogen and Oxygen Tanks

Part #	Description
43283	Acetylene Tank 40 Cu Ft "B" (Filled Tank Complete)
43286	Acetylene Tank 10 Cu Ft "MC" (Filled Tank Complete)
43290	CO2 10 Cu Ft Tank (Filled Tank Complete)
43292	CO2 20 Cu Ft Tank (Filled Tank Complete)
43291	CO2 20 Cu Ft Aluminum Tank (Filled Tank Complete)
43285	Nitrogen Tank 40 Cu Ft "J" (Filled Tank Complete)
43287	Nitrogen Tank 20 Cu Ft "R" (Filled Tank Complete)
43289	Oxygen Tank 20 Cu Ft "R" (Filled Tank Complete)

Furnace & A/C Installation Supplies

Furnace Leg Kits

Easy Leveler™ Furnace Leg Kit

- Levels furnace and A/C coil for proper drainage
- Supports up to 400 lbs
- Easily adjustable even after installation
- Includes:
 - (4) Easy leveler legs
 - Sheet metal screws



Part #	Model #	Min Height	Max Height
37315	79095	2-3/4"	4"

Anti-Vibration Pads

Rubber/Cork Anti-Vibration Pad

- Elastomeric oil-resistant padding
- Withstands 50 lbs per square inch
- Cork is laminated between (2) corrugated pads



Part #	Model #	Description
2699	MP-2C	2" x 2" x 7/8"
2717	MP-4C	4" x 4" x 7/8"
72576	MP-18C	18" x 18" x 7/8"
52888	MP-4E	4" x 4" x 7/8"

Economy NSA Blocks

Part #	Model #	Description
31303	NSA-FMB-1BLOCK	Plastic Furnace Mounting Block

Concrete Block

- Dimensions: 8"W x 16"D

Part #	Model #	Description
306	BLO2	2" Solid Concrete Block
334	BLO4	4" Solid Concrete Block
365	BLO8	8" Concrete Block

Equipment Pads

E-Lite® Plastic Equipment Pad

- Molded with size label and symbol representing content of recycled material
- Rounded edges and concrete gray color
- Limited lifetime warranty



Part #	Model #	Description
169763	EL2424-3	24" x 24" x 3"
6840	EL3030-2	30" x 30" x 2"
169701	EL3030-3	30" x 30" x 3"
3749	EL3036-2	30" x 36" x 2"
1975	EL3636-2	36" x 36" x 2"
169702	EL3636-3	36" x 36" x 3"
31	EL3640-2	36" x 40" x 2"
169764	EL3842-3	38" x 42" x 3"
169703	EL3640-3	36" x 40" x 3"
183339	EL3232-3	32" x 32" x 3"

Ultralite® Lightweight Equipment Pad

- Concrete pad at weight of plastic
- EPS Core prevents warping and provides solid bottom to resist settling
- Vibration-absorbing
- Freeze/thaw resistant
- Limited lifetime warranty



Part #	Model #	Description
10826	UC3036-2	30" x 36" x 2"
13871	UC3030-2	30" x 30" x 2"
9054	UC3636-2	36" x 36" x 2"
6922	UC3640-2	36" x 40" x 2"
146820	HP3636-8	Heat Pump Pad with 8" of lift

Air Conditioner Brackets

- Powder coated
- Pair



Part #	Model #	Size
51008	ACB-SB-POWDER COATED	36"
51009	ACB-SB-POWDER COATED	42"
51010	ACB-SB-POWDER COATED	48"

Supplies

Line Sets & Insulation

Equipment Stands & Mounting Blocks

Pump-Up® Equipment Stand

- Elevate heat pumps and air handling units
- Corrosion-resistant plastic
- Helps prevent corrosion of metal base
- Solid 6" x 6" mounting base
- Top diameter: 4-1/8"

BRAMEC®



Part #	Model #	Description
21783	4005	3" High
14976	4008	6" High

1/2" EZ-Pull Insulation No End Bend

Part #	Liquid Line	Suction Line	Length
192151	3/8"	5/8"	25'
192152	3/8"	5/8"	35'
192153	3/8"	5/8"	50'
192154	3/8"	3/4"	25'
192155	3/8"	3/4"	35'
192156	3/8"	3/4"	50'
192157	3/8"	7/8"	25'
192158	3/8"	7/8"	35'
192159	3/8"	7/8"	50'
196215	3/8"	1-1/8"	50'

Sweat Line Sets



Line Set with 3/8" Insulation with 90° Bends

Part #	Liquid Line	Suction Line	Length
29798	3/8"	5/8"	25'
29799	3/8"	5/8"	35'
29800	3/8"	5/8"	50'
14547	3/8"	3/4"	25'
14663	3/8"	3/4"	35'
14832	3/8"	3/4"	50'
12521	3/8"	7/8"	25'
12608	3/8"	7/8"	35'
12742	3/8"	7/8"	50'
5076	3/8"	1-1/8"	50'

Rubber Pipe Insulation

- Sold in 6' lengths
- Solid - no-split



Part #	Model #	Size x Ins	Pipe OD
19737	1/4-RUBATEX	1/4"ID x 3/8"	1/4"
19747	3/8-RUBATEX	3/8"ID x 3/8"	3/8"
19748	1/2-RUBATEX	1/2"ID x 3/8"	1/2"
10239	5/8-RUBATEX	5/8"ID x 3/8"	5/8"
2791	3/4-RUBATEX	3/4"ID x 3/8"	3/4"
8834	7/8-RUBATEX	7/8"ID x 3/8"	7/8"
14824	118-RUBATEX	1-1/8"ID x 3/8"	1-3/8"
6010	138-RUBATEX	1-3/8"ID x 3/8"	1-3/8"
68061	6RX048238	2-3/8"ID x 1/2"	2-3/8"
46702	6RX048312	3-1/2"ID x 1/2"	3-1/2"

Insul-Lock® Self Seal Pipe Insulation

- Flexible closed-cell insulation is pre-slit with factory applied pressure sensitive adhesive
- Temperature range: -70° to 200°F
- Greenguard® certified
- Sold in 6' length



Part #	Description	Ins
87281	7/8" ID Insul-Loc	3/4"
66080	3/4" ID Insul-Lock	3/8"
66081	7/8" ID Insul-Lock	3/8"

**QUALITY.
SERVICE.
TOMMARK.**

Duct, Pipe Hangers & Supports

Continuous Threaded Rod - Galvanized

• Electro-galvanized



Part #	Description	Length
5936	3/8"	6'
12869	3/8"	10'

Slotted Strut



Part #	Description	Length
77871	13/16" x 1-5/8" Green	10'
13710	1-5/8" x 1-5/8" Green	10'

Strut Nut with Spring



Part #	Description
1886	3/8" Strut Nut with Spring

Hex Nut



Part #	Description
4950	3/8" Hex Nut

Flat Washer



Part #	Description
10566	3/8" Flat Washer

Rod Coupling



Part #	Description
5852	3/8" Rod Coupling

Coach Screw (Lag x Threaded)

Part #	Description
4849	3/8" x 6"
4863	3/8" x 8"

Beam Clamp

Junior Top Beam C-Clamp



Part #	Description
4849	3/8" with Set Screw and nut

Clevis Hanger Loop Style w/Nut Copper Clevis Hanger



Part #	Description	Rod Size
13842	3/4" IP	3/8"
13644	1" IP	3/8"
6698	1-1/4" IP	3/8"
6679	1-1/2" IP	3/8"
10956	2" IP	3/8"

Clevis Hanger Copper Clevis Hanger



Part #	Description	Rod Size
13742	3/4"	3/8"

Strut Clamp

Strut Clamp (IPS)



Part #	Description
3869	1/2" IP
13459	3/4" IP
13343	1" IP
3063	1-1/4" IP
2532	1-1/2" IP
16372	2" IP

Cushion Strut Clamp



Part #	Description
6299	1/2" OD
6411	3/4" OD
16314	5/8" OD
16413	7/8" OD
8280	1-1/8" OD
33502	1-3/8" OD
176503	1-5/8" OD

Models and Specifications are Subject to Change Without Notice

Duct, Pipe Hangers & Supports

Straps & Ties

Galvanized MSTC Strap Tie

- Staggered countersunk nail slots
- Coined edges
- To reinforce top plate



Part #	Model #	Description
44698	MSTC52	3" x 52-1/4", 16ga

Galvanized RPS Strap Tie

- Reinforces top plate



Part #	Model #	Description
44697	RPS28	1-1/2" x 28", 16ga

Basset Galvanized Brackets Self-Nailing Galvanized Bracket



Part #	Model #	Description
1835	A-1	12" to 19" 25/Ctn

Galvanized Square Duct Hangers

- 18 Gauge

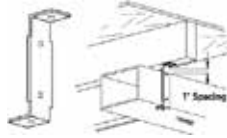

Part #	Model #	Description
23342	BH-8	8"
23343	BH-9	9"
35925	BH-10	10"
51677	BH-11	11"

Basset Straps

FHA Steel Mending Strap

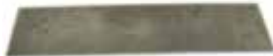

Part #	Model #	Description
78436	SSTRPS24	1-1/2" x 24" 16ga
44695	SSTRPS18	1-1/2" x 18" 16ga
194394	FHA-300-1816	3" x 18" 16ga

Pipe Clamps

Half Clamp with Barbed Nail

Oatey



Part #	Model #	Size	Pkg Qty
12671	33900	1/2"	100
12915	33901	3/4"	100

Pipe Hooks

DWV J-Hook™

The Ultimate Pipe Hanger

- Support drain, waste and vent plastic pipe from joists and rafters
- Nail holes on all four sides allow for attachment at various angles for pipe runs
- Made of high impact ABS for increased load capacity
- Accommodates Sch 40 and Sch 30 DWV plastic pipe



Part #	Model #	Size	Color
5688	33741	2" x 7"	White
15116	33742	3" x 7"	White
5591	33743	4" x 7"	White

Sioux Chief Zip Stick Pipe Hanger

- Perfect for hanging DWV, wrapped or insulated pipe, bundles of PEX, cable, wiring or supporting vent pipe in attics
- Universal cradle hangs any pipe from 1" CTS to 6" IPS
- White or black, with 14" or 26" stems
- Graduated numerals at nail ways for easy measuring
- Releasable locking mechanism



Part #	Model #	Description
162789	SIO553-026W	26" Long Will hold up to 6" Diam Pipe

Stud Guards

- Provide protection for pipes and wiring installations
- Special self-nailing feature
- Made of 18 gauge steel



Part #	Model #	Description
1271	33895	1-1/2" x 6", 5-1/2" Between Points
18705	33930	1-1/2" x 3", 2-1/2" Between Points



Refrigeration Tubing & Fittings

Hanger Strap

Plastic Hanger Strap

- Nail holes are 2-1/2" apart
- Non-corrosive, non-conductive, with nail holes
- Quick and inexpensive way to hang pipe from joists and rafters
- 1/8" Nominal hole size



Part #	Model #	Size
14535	33925	3/4" x 25'
15238	33927	3/4" x 100'

Pipe Hooks

Wire Pipe Hook

- Bright basic 9 gauge wire



Part #	Size
12243	3/4" x 6"
12515	1" x 6"
12687	1-1/4" x 6"
12797	1-1/2" x 6"

Copper Wire Hook

- Copper coated wire

Part #	Size
15460	3/4" x 6"
15757	1" x 6"
15955	1-1/4" x 6"
16048	1-1/2" x 6"

Metal Hanging Strap



Part #	Description
1583	3/4" x 10" Perforated Galv Strap
171568	3/4" x 100' Perforated Galv Strap
18240	1" x 100" Non Perforated Galv Strap

Copperized Perforated Iron Band



Part #	Size	Gauge
43115	3/4" x 10'	22ga

Duct Hangers

Hanging Wire

- 18 Gauge galvanized on reel



Part #	Model #	Size
662	710-185G	5# (830') Hanging Wire

Copper A/C Refrigeration Tubing - Blue

Type ACR Hard ASTM B280

- 20' Lengths



Part #	Model #	Size
3610	CPA-038X20	3/8" OD
4933	CPA-012X20	1/2" OD
2569	CPA-058X20	5/8" OD
3830	CPA-034X20	3/4" OD
1672	CPA-078X20	7/8" OD
18613	CPA-118X20	1-1/8" OD
17548	CPA-138X20	1-3/8" OD

Coiled Refrigeration Tubing - 50' Rolls



Part #	Model #	Size
195660	REF1/4X10	1/4" OD
7880	REF1/4X50	1/4" OD
13544	REF5/16X50	5/16" OD
16346	REF3/8X50	3/8" OD
7976	REF1/2X50	1/2" OD
5846	REF5/8X50	5/8" OD
16545	REF3/4X50	3/4" OD
14410	REF7/8X50	7/8" OD
2998	REF11/8X50	1-1/8" OD

Copper Refrigeration Fittings

Copper Reducing Bushing (Ftg x C)



Part #	Model #	Size
8898	COF-BU-3814	3/8" x 1/4" OD
63937	COF-BU-I-1258	1/2" x 5/8" OD
11300	COF-BU-3458	3/4" x 5/8" OD

Copper Extended Reducing Bushing (Ftg x C)

Part #	Model #	Size
17586	COF-BU-E-3458	3/4" x 5/8" OD
38473	COF-BU-E-7858	7/8" x 5/8" OD
14957	COF-BU-E-7834	7/8" x 3/4" OD
11142	COF-BU-E-11878	1-1/8" x 7/8" OD
11273	COF-BU-E-138118	1-3/8" x 1-1/8" OD

Refrigeration Tubing & Fittings

Copper Coupling with Rolled Stops (Copper)



Part #	Model #	Size
9762	COF-CO-14	1/4" OD
9993	COF-CO-38	3/8" OD
6948	COF-CO-516	5/16" OD
5739	COF-CO-12	1/2" OD
9952	COF-CO-34	3/4" OD

Copper Reducing Coupling (Copper)



Part #	Model #	Size
134	COF-CR-3814	3/8" x 1/4" OD
8479	COF-CR-38516	3/8" x 5/16" OD
13578	COF-CR-1238	1/2" x 3/8" OD
8802	COF-CR-5838	5/8" x 3/8" OD
8536	COF-CR-5812	5/8" x 1/2" OD
15399	COF-CR-3438	3/4" x 3/8" OD
2406	COF-CR-3458	3/4" x 5/8" OD
17437	COF-CR-7834	7/8" x 3/4" OD
15594	COF-CR-11834	1-1/8" x 3/4" OD

Copper 45° Long Turn Elbow (Copper)

Part #	Model #	Size
10360	COF-45LT-34	3/4" OD

Copper 45° Street Elbow (Ftg x C)



Part #	Model #	Size
11969	COF-45ST-34	3/4" OD

Copper 90° Long Turn Elbow (Copper)



Part #	Model #	Size
8848	COF-90LT-1	1/4" OD
9068	COF-90LT-38	3/8" OD
8828	COF-90LT-12	1/2" OD
9236	COF-90LT-58	5/8" OD
9022	COF-90LT-34	3/4" OD
9420	COF-90LT-78	7/8" OD
9777	COF-90LT-118	1-1/8" OD
9965	COF-90LT-138	1-3/8" OD

Copper 90° Long Turn Street Elbow (Ftg x C)



Part #	Model #	Size
22937	COF-90LT-38-ST	3/8" OD
9717	COF-90LT-58-ST	5/8" OD
9503	COF-90LT-34-ST	3/4" OD
9895	COF-90LT-78-ST	7/8" OD
10287	COF-90LT-118-ST	1-1/8" OD



Piercing Valves

"MAC" Line Piercing Valve

- Uniport: (1) connection for piercing and servicing
- Needle automatically back seats after servicing



QTM-1

Part #	Model #	Tube Size	Qty
12604	QTM-1	1/4", 5/16", 3/8" OD	Each
12613	WATA-2	1/2", 5/8" OD	Each

Brazing & Soldering

Brazing Alloys

NetBraz 15 Brazing Alloy

- 15% Silver
- Liquidus: 1475°F
- Solidus: 1190°F

Part #	Model #	Description
138982	NETBRAZE-15-5	5' Coil
138983	NETBRAZE-15-22	22' Coil

Handy One® Aluminum

AL 822 Handy One® Aluminum Brazing Alloy

- Flux cored solder
- Larger temperature window
- Customizable flux combination
- 22% Aluminum, 78% Zinc
- High temperature
- Solidus: 800°F (426°C)
- Liquidus: 900°F (482°C)
- Made in USA



Part #	Mfg #	Description	Qty
170563	99088	.090" Dia x 20"	4 sticks

Phos-Copper Brazing Alloys

Stay-Silv® 2 Phos-Copper Brazing Alloy

- 2% Silver, 91% copper, 7% phosphorus
- Designed to broaden the melting range of Harris O
- Proven useful in some specific applications where mechanical properties are less critical
- Solidus: 1,190°F (643°C)
- Liquidus: 1,450°F (788°C)
- AWS A5.8 Class: BCuP-6
- RoHS Compliant
- Made in USA



Part #	Model #	Description
11256	SF-2	0.050" x 1/8", 28 Stick Tube

Stay-Silv® 5 Phos-Copper Brazing Alloy

- 5% Silver, 89% copper, 6% phosphorus
- Medium-range alloy well suited where close fit-up cannot be maintained
- Filler metal is more ductile than Harris O® or Stay-Silv® 2
- Solidus: 1,190°F (643°C)
- Liquidus: 1,500°F (816°C)
- AWS A5.8 Class: BCuP-3
- RoHS Compliant
- Made in USA



Part #	Model #	Description
72954	SF5	5%, Single Tube

Stay-Silv® 15 Phos-Copper Brazing Alloy

- 15% Silver, 80% copper, 5% phosphorus
- Excellent for situations where thermal expansion and service vibration are involved
- Solidus: 1,190°F (643°C)
- Liquidus: 1,480°F (804°C)
- AWS A5.8 Class: BCuP-5
- Meets Fed. Spec. QQ-B-654A, Grade III, BCuP-5 for QQ-B-654.
- RoHS Compliant
- Made in USA



Part #	Model #	Description
72121	SS15-1	15%, Single Stick
10345	SS15	0.050" x 1/8", 25 Pack

Lead-Free Solders

Stay-Brite® 8 Silver Lead-Free Solder

- 6% Silver, 94% tin
- Low temperature solder for many HVAC connections
- Bonds with all ferrous and nonferrous alloys, except aluminum
- Effective in filling loosely fitted couplings
- Solidus: 430°F (221°C)
- Liquidus: 535°F (279°C)
- Meets NSF/ANSI Standard 61 and 372 for drinking water components
- RoHS Compliant
- Made in USA



Part #	Model #	Description
5765	10010	1/16" x 1 lb Spool

Brazing & Soldering

Solder

Silver Lead-Free Plumbing Solder



Part #	Model #	Description
3147	23001	1 lb Lead Free Solder

95/5 Lead-Free Plumbing Wire Solder

- Lead-free alloy of 95% tin and 5% antimony
- Melting range: 450° to 464°F
- Most commonly used where frequent and extreme temperature changes and vibrations occur



Part #	Model #	Description
7385	22017	1 lb 95/5 Wire Solder

Flux

No. 5 Paste Flux

- Cleans and fluxes at the same time
- Effective on all metals except aluminum, magnesium and stainless steel
- 100% Lead-free
- Blended to clean surface oxidation



30041

Part #	Model #	Size
39970	30013	4 oz
78870	30014	8 oz
39969	30041	16 oz

No. 11 Liquid Flux

- Formulated with strong cleaning agent
- Ensures fast and effective soldering operation
- No need to clean oxidized copper
- Can be used for HVAC applications



Part #	Model #	Size
78871	30106	4 oz

Flame Protector

- 9" x 12" Woven ceramic (non asbestos) heat shield
- Protects work areas from torches up to 2000°F
- Packaged in a polybag



Part #	Model #	Description
54924	31400	Flame Protector

Flux

All Hercules Fluxes Can be Used with Soft Solder Alloys on Commonly Soldered Metals, but NOT Recommended for Use on Aluminum or Some Grades of Stainless Steel

Jel-Flux™

- Non-drip, non-runny, self-cleaning, lead-free, liquid flux for use with soft solder
- Cleans, fluxes, retards oxide formation during heating and penetrates through oil film
- For use on most common metals



Part #	Model #	Size
18755	10810	4 oz

Heat Pastes

Thermo-Trap® Heat Paste

- High capacity for absorbing heat
- Soaks up heat and reduces heat transfer
- Apply to copper, steel, or other pipe surfaces before welding, brazing, or soldering to protect nearby sensitive controls or components



Part #	Model #	Description
54887	4371-36	11 oz Tube
59127	4371-32	32 oz Spray Bottle

Abrasives

General Purpose Abrasive Pad

- Cleans copper and fittings
- Rinses clean with water

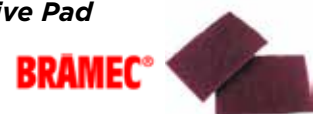

Part #	Model #	Description
12121	13195	4" x 6" x 1/4", 10/Bag

Abrasives Cloth

180 Open Mesh Cloth

- For working with copper, brass or aluminum
- Made of an open nylon fabric with a phenolic resin adhesive which provides a rugged, waterproof aluminum oxide cloth of superior quality



Part #	Model #	Size
7818	31321	1-1/2" x 10 yds

Condensate Pumps & Accessories

VCMX NEXTGen™ Automatic Condensate Pumps

- Collects, detects, and automatically removes condensate from air conditioning equipment, dehumidifiers, high efficiency furnaces, condensing boilers and other equipment where an automatic drain pump is required
- 1/30 hp High performance motor with patent-pending cooling design to increase pump life
- Flow rate: 84 gph @ 1'
- head, 93W, 1.5A
- 115V @ 60Hz
- .3 Gallon tank
- Fully automatic
- 3/8" Check valve
- 3/8" Discharge
- External test/run lever to drain tank for servicing
- Thermal overhead protection
- 6' Cord
- Includes mounting bracket



VC Series Automatic Condensate Removal Pumps

- For high-efficiency gas-furnace condensation
- Liquid temperature: 120°F
- Discharge: 3/8" barbed
- 1/30 hp Motor
- Flow rate: 80 gph @ 1' head
- 115V @ 60Hz
- 3/10 Gallon ABS tank, volute and switch cover
- Thermal overload protection
- Includes removable 3/8" barbed check valve
- UL Listed
- cCSAus Listed



VCC Low Profile Tank Condensate Pump

Part #	Model #	Size	Max Lift
16529	554200	VCC-20ULS	20'

VCMX Series Condensate Pump less Tubing

Part #	Model #	Max Lift
57356	VCMX-20ULS	21'

VCMA Automatic Condensate Pumps

- For high-efficiency, gas furnace condensate and condensing boilers
- 1/50 hp Motor
- Flow rate: 65 gph @ 1' head
- 115V @ 50Hz
- 1/2 Gallon leak-proof, rust-proof, high-impact ABS tank
- Fully automatic
- (3) Drain holes
- 3-Prong plug
- Snap-action switch
- Stainless steel shaft
- Polypropylene impeller
- ABS Plastic motor, tank cover, and volute
- Optional safety switch
- Thermal overload protection
- 6' Cord
- Includes removable 3/8" barbed check valve
- cCSAus Certified



Diversitech Condensate Pumps

- Vibration Dampening Feet and Motor Mounts
- Metal Hanging Tabs
- Four Inlet Holes
- Float Switch and Safety Check Valve
- Safety Switch Terminals



Part #	Model #	Max Lift
130918	CP-16	16' Lift
177037	CP-22	22' Lift

VCMA Series Condensate Pump less Tubing

Part #	Model #	Max Lift
776	VCMA-15ULS	15'

Condensate Pumps & Accessories

Condensate Overflow Switches

Condensate Cop™ Clamp-On Float Switch

- Large over clamping area that fits the edge of all types of drain pans
- Separate float/probe assembly swivels to position switch
- Switch opens when rising water presents a flooding condition
- 2-Wire connection
- 24V/1.5A NC Reed switch
- Includes:
 - 5' Leads
 - Wire nuts
 - Clamping screws



Part #	Model #	Description
55348	CC-1	Drain Pan Switch

Wet Switch Flood Detector

- Solid state control designed to help prevent flooding
- Turns system off when detecting moisture due to condensate or drain leaks
- Connects to 24VAC
- LED Indicates switch is activated
- Simple, 5-wire installation
- ETL Listed



Part #	Model #	Description
27223	WS-1	Wet Switch

Condensate Overflow Switches

Auxiliary Condensate Overflow Safety Switch

- ABS Housing and float
- 5A Maximum
- Low voltage (48VAC/DC)
- Can be installed to activate audible and/or visual alarm, or lift system
- 18" Wires
- CSA Listed



Part #	Model #
22523	599122 ACS-2

Condensate Drain Pans

High Rise Pan™ Kit

- Allows placement of an handler 2-3/4" above the outside lip of pan without mounting blocks
- Molded-in network of risers to give a 5" lift
- Includes:
 - Condensate Cop™ float switch
 - (6) EVA Anti-vibration pads
 - (1) 3/4" PVC Male adapter



Part #	Model #	Size
54844	6-HK3050	30" x 50"
54850	6-HK3060	30" x 60"

A/C Secondary Condensate Drain Pan

- Collects condensate from cooling and evaporator coils
- 3/4" Diameter PVC discharge fitting
- Plastic construction
- Rolled edges for durability
- Ribbed bottoms for rigidity



Part #	Model #	Size	Drain Line Outlet Side
21120	6-3030L	30" x 30" x 2"	Long
16296	6-3050L	30" x 50" x 2"	Long
17279	6-3060L	30" x 60" x 2"	Long
25265	6-3636L	36" x 36" x 2"	Long
25266	6-3660L	36" x 60" x 2"	Long

A/C Condensate Drain Pan Fitting (Slip)



Part #	Model #	Size
28994	6-1	3/4"

Condensate Pumps & Accessories

Condensate Drain Line Cleaners

Gallo Drain Gun and Accessories

- Clears condensate drains with a SWOOSH CO2 cartridge
- Lightweight, portable
- Pressure: 800 psi
- Environmentally safe and recyclable cartridges
- Includes a tapered fitting for 3/8" - 3/4" drain openings



Part #	Model #	Description
65449	GG-1	Gallo Gun with SWOOSH CO2 Cartridge

Swoosh CO2 Cartridge

- Delivers 800 psi of oil free food-grade air to clear line
- Environmentally safe and recyclable
- No need for air or nitrogen tanks



Part #	Model #	Description
65450	GGC-12	Replacement Cartridge for SWOOSH CO2, 12/Pk

Tubing

Clear Vinyl Tubing

- Clear, tough, flexible tubing
- Nominal wall thickness: 1/16"
- Good for A/C condensate drains



Part #	Description
6612	3/8" ID x 100' Roll
195764	1/2" ID x 10' Roll
6741	1/2" ID x 100' Roll
7000	3/4" ID x 100' Roll

Pan-Treat™ Condensate Pan Tablet

- Effective in treating build-up of sludge, scum, and other condensate pan accumulations
- Safe, non-corrosive, non-toxic and biodegradable
- Completely soluble in water and does not form any deposits



Part #	Model #	Description
54882	4296-60	200 Tablets

pH-TREAT™ pH Neutralizer

- Neutralizes condensate water raising the pH to near neutral
- Designed for gravity feed
- Product life is expected to have 1-year service life
- Temperature range: 40° to 100°F
- Pressure range: 0 to 125 psi
- Includes:
 - (1) C-Clip for mounting
 - (2) 1/2" Barb x 3/8" MPT fittings
 - (2) 3/4" FPT x 3/8" MPT fittings



Part #	Model #	Description
69583	4720-06	2.5" x 12" Cartridge Housing with 3/8" FPT Connections



A MUNCH'S SUPPLY COMPANY

WE APPRECIATE YOUR BUSINESS!

Leak Detection Repair



Leak Detectors

Heated Pentode Leak Detector

- Operating range: 32° to 125°F
- Detects all halogenated refrigerants
- Tri-color visual leak size indicator
- Adjustable sensitivity
- 16" Probe



Part #	Model #	Description
34080	TIFZX	Pentode Detector

Refrigerant Leak Detector

- Six-segment visual leak size indicator
- True mechanical pump provides positive airflow through sensing tip
- High and low sensitivity levels
- One touch reset
- Tactile keypad controls
- Two-year warranty



Part #	Model #	Description
22624	TIFRX-1A	Halogen Leak Detector with Pump, HI/LO, Visual Leak Size
37001	TIFXP-1A	HLD Halogen Hawk

Part #	Model #	Description
72894	LD5000	Leak Detector
186501	LDC4000	Combustible Gas and HC Refrigerant Leak Detector
190322	LD3000	Quest Hand Held Refrigerant Leak Detector

GLO-STICK® Dye Capsules

- For small to medium size systems
- Prefilled, disposable capsules allow dye to be injected into pressurized systems using refrigerant
- Will withstand pressures of more than 1,000 psi
- Requires the use of (2) BV-50 bleed valves (for use on 1/4" flare hose fittings)



GLO-STICK® Universal Dye Capsule

- For mineral oil, polyol ester and alkyl benzene lubricant systems

Part #	Model #	Description
40406	GS-2/ECS	(1) 0.5 oz Capsule, Each Treats 5 to 9.9 lbs of Refrigerant or 1.7 to 3.2 qts of Lubricant, Clamshell
40407	GS-3/ECS	(1) 0.5 oz Capsule, Each Treats 10 to 25 lbs of Refrigerant or 3.3 qts to 2 gals of Lubricant, Clamshell

EZ-Ject™ Dye Cartridges

- For small to medium size systems
- EZ-Ject™ cartridges are prefilled with co-solvent free, OEM-approved dye that meet ASHRAE and ANSI standards



Part #	Model #	Description
51889	EZ-4/ECS	(6) 0.5 oz Cartridges Universal/POE Dye Cartridge, Also Compatible with Mineral Oil & Alkyl Benzene Lubricants, Clamshell

Refrigerant Leak Sealants

A/C EasySeal Leak Sealant

- Designed to prevent and repair leaks anywhere in the system, including condensers, evaporators, copper lines and soldered joints
- Will react with moisture or air that is naturally present at a leak, forming a secure seal



4050-01



4050-06



4051-99



Part #	Model #	Description
65461	4050-01	A/C EasySeal-SS 1.25 oz Pressurized Can, Treats Fractional to 1.5 Tons
65462	4050-06	A/C EasySeal 3 oz Pressurized Can, Treats 1.5 to 5.0 Tons
159569	4050-08	A/C EasySeal Direct Inject, Treats 1.5 to 5.0 Ton Units, Single Use
65473	4051-99	A/C Piercing Valve & Hose

EasySeal Direct

- Clear tube so you can see the sealant go in.
- No need to pump down R-410A units.
- Perfect for split systems, heat pumps, microchannel coils, packaged units, and mini splits.
- No injection hose or caulk gun needed.



Part #	Model #	Description
159569	4050-08	1.5 - 5 Ton System
191388	4050-07	1.5 - 5 Ton System (6-Pack)
193066	4050-12	1.5 - 5 Ton System w/ Dye
190687	4050-11	1.5 - 5 Ton System w/ Dye (6 Pack)
193067	4050-15	UV Leak Detection Kit

Leak Detection & Repair/Pipe Thread Sealant

Gas Leak Detectors

Fluorescent Gas Leak Detector

- Detects the smallest leak
- High viscosity formula enables it to remain in contact with the applied surface for an extended period of time
- Non-corrosive to metals
- Freeze protected and safe for use on all refrigerants, natural gas and oxygen



Part #	Model #	Description
54908	4184-53	8 oz Bottle with Dauber
90353	4184-24	1 qt Spray Bottle

Gas Leak Detector

- High viscosity liquid forms bubbles when daubed on gas leak
- Non-corrosive, non-staining and harmless to skin
- Freeze point well below 0°F
- USDA approved



Part #	Model #	Description
14798	4180-53	6 oz w/Dauber

Cal-Blue® Plus Gas Leak Detector

- Complete, detects smallest leak
- High viscosity formula provides long lasting bubbles and enables the product to remain in contact with the applied surface
- Non-corrosive to metal
- Freeze protected to 5°F



Part #	Model #	Description
54902	4182-53	6 oz with Dauber
14237	4182-24	1 qt Spray Bottle
72401	4182-08	1 gal Bottle

Test Kits

QwikCheck® Acid Test Kit

- 2-Second refrigeration acid test
- Color change indicates pass/fail
- Works with all refrigerants and oils
- Tests to ARI-700 limit of 1 ppm
- Test for inorganic acid (including POE)
- Compatible with all lubricants
- Meets EPA venting rules



Part #	Model #	Description
44835	QT2000	Acid Test Kit, 50/Pack

BRAMEC®

Visu-Glow® Leak Detector

- High visibility, fluorescent color
- High viscosity, stays on vertical surfaces
- Not for use on oxygen systems



Part #	Model #	Size
19115	16164	8 oz

Thread Sealants

Pro Dope® Thread Sealant

- Oil based
- Not for use on plastic pipe or fittings
- Gray color
- Non-setting formula, will not harden, crack or become brittle
- Accepted for use on FlowGuard Gold® pipe and fittings



Part #	Model #	Size
12257	15420	1/2 pt
12313	15427	1 pt

Megaloc® Thread Sealant

- Made with DuPont™ Kevlar®
- Wipes easily from hands and tools with dry rag
- No odor, no waiting, non-flammable
- High performing; Grit-free



Part #	Model #	Size
16038	15806	1/2 pt
31834	15808	1 pt
16084	15811	1 qt

Real-Tuff™ Thread Sealant

- Multi-purpose, heavy-duty white PTFE paste thread sealant
- Lead-free, contains no heavy metals or volatile solvents
- Non-flammable and non-separating
- Positive, leak-proof seal on all piping material and for all liquids and gases except oxygen
- Leak-proof hydraulic resistance up to 12,000 psi
- Withstands gas pressure up to 2,600 psi
- Temperature range: -200°F 550°F



Part #	Model #	Description
14126	15620	1/2 pt Brush-in-Cap
14180	15625	1 pt Brush-in-Cap

Models and Specifications are Subject to Change Without Notice

Pipe Thread/Sealants

Pipe Joint Compounds

Leak Lock Joint Compound

- Resistant to all refrigerants, oils, water and most chemicals, liquids and gases
- Ideal for joining all metals, plastics and other materials
- Will stick to all clean surfaces
- Guarantees a perfect seal under all conditions



Part #	Model #	Description
68278	HS10001	1-1/3 oz Tube
68279	HS10004	4 oz Brush Top Plastic Jar
68280	HS10016	16 oz Brush Top Plastic Jar

Tape Thread Sealants

White Thread Seal Tape with Teflon®

- Provides a clean, positive seal on threaded connections
- A high density product that resists tearing and stretching for easy, efficient application
- Available carded or packaged bulk on spools
- Complies with Military Spec No. T-27730A and UL 31 RO
- 3 mil thick, 0.7 grams/cubic centimeters densit.



Part #	Model #	Size
8524	31199	1/2" x 260"
10899	31202	1/2" x 520"
17640	31212	3/4" x 260"

Hercules® Megatape Gray Thread Seal Tape with Teflon®

- All-purpose
- Virgin PTFE
- Extra-large spool
- Gray tape is 3.5 mil thick with density of 0.70 to 1.00 grams/cubic centimeter
- Meets UL 31 RO and 7N15 MH18499



Part #	Model #	Size
144060	144060	1/2" x 1,000'
144062	144062	3/4" x 1,000'

Caulk

Munch Supply HVAC Silicone Sealant

- Interior or exterior sealant that remains flexible and has excellent adhesion to a wide range of materials
- Skins in 10 minutes
- Cure rate: 1/4" diameter bead/48 hours



Part #	Model #	Color
90392	SILICONEG	Aluminum
90398	SILICONEW	White
90395	SILICONEC	Clear
90396	SILICONER	Red - High Temp
195049	66-200	Flagstop Caulk

Sealants

THUM-GUM™ Sealing Compound

- Non-hardening putty for larger sealing jobs
- For plugging openings through foundations & refrigeration tube entry
- Does not contain asbestos



Part #	Model #	Description
5585	1003	1 lb Bag
5597	1004	2 lb Box

Aerosol Sealants

Nu-Foam® Sealant

- Expanding, polyurethane, prepolymer foam
- Used as a sealing and insulating product
- Designed to seal, fill and insulate small cracks, gaps, and voids



Part #	Model #	Description
129941	4293-75	20 oz Can

Insulating Foams and Sealants

Boss 333-Polyurethane Expanding Foam

- Meets CA-25-4
- Triple expanding
- Weatherproofs against wind & moisture
- Complies with EPA Method 24 and California Air Resource Board Method 310



Part #	Model #	Description
19142	20174	12 oz

Sealants & Gaskets/Duct Sealants, Adhesives & Fasteners

Sealants

Roof and Flashing Sealant

- Special bituminous composition with superior adhesion under the most severe weather conditions
- Heavy, paste-like consistency, easily applied with trowel or putty knife
- No separation, no stirring, no objectionable odor
- Adheres to wet/moist surfaces - can be applied in rain
- Forms durable, flexible, weatherproof coating



Part #	Model #	Size
41598	25403	10.3 oz
6991	25405	1 qt
7040	25410	1 gal

Insulation Products

Cork-Tite™ Insulation Tape

- Can be used on hot or cold pipes
- Also serves as gasket material or sound deadening material
- Sticks to all dry metals and seals tightly
- Will not shrink or melt between -20° and +200°F



Part #	Model #	Description
54900	4217-12	2" x 1/8" x 30' Roll

Foam-Tite™ Insulation Tape

- Utilizes closed-cell construction and can be used with cold water pipes, chilled water lines, and refrigerant lines to prevent sweating and condensation
- Also for use on hot water lines to prevent heat loss
- Can be overlapped or edges can be butted



Part #	Model #	Description
54899	4219-12	2" x 1/8" x 30' Roll

Pan Spray

- Water-proof rubberized coating that won't chip, flake, or peel
- Seals out rust and corrosion
- Repairs leaky condensate pans, cooling towers, swamp coolers, roofing, gutters and down spouts



Part #	Model #	Description
54898	4296-50	16 oz Aerosol, White

Duct Sealants

AirSeal Zero High Performance Solvent Based Duct Sealant

- 0 Reportable VOC's
- LEED EQ Credit 4.1
- Cures to a tough, flexible film
- Excellent adhesion
- Formulated for indoor and outdoor use
- Exceeds all SMACNA pressure and sealing classes
- Dries to touch in minutes



Part #	Model #	Description
54989	ASZERO-T-G	10.5 oz Tube, Gray
54990	ASZERO-1-G	1 gal Pail, Gray

AirSeal 22 Smooth Water Based Duct Sealant

- Seals all types of HVAC duct systems including metal, fiberglass duct board and flex duct
- Cures to tough flexible film
- Fast dry time
- Formulated for indoor and outdoor use
- Pressure: 12"wc
- Excellent mold and mildew resistance



Part #	Model #	Description
54987	AS22-TG	10.5 oz Tube, Gray
54988	AS22-1G	1 gal Pail, Gray

Tripod Bangers™



Part #	Model #	Description
14300	26129	TBG12, 1/2" Insulation 1,000/Pk
14311	26130	TBG100, 1", 1-2# Density 1,000/Pk

Insulation Fasteners

DynaStick Self Adhesive Hanger w/ Steel Washer



Part #	Model #	Description
13685	26067	3/4", 100/Pk
13691	26068	1-1/4", 100/Pk
13417	SAHB34	3/4", 500/Pk
13428	SAHB114	1-1/4", 500/Pk

Supplies

Duct Sealants, Adhesives & Fasteners

Rib Pins®



Part #	Model #	Item #	Clip Size	Liner Size	Pack
13259	26023	CP-12	1/2"	1/2"	1000

FTC Econo-Point

- For use with Duro-Dyne® Pinstotter models FG-15, PBFS, RH and MFPT
- Sold per bucket only



Part #	Model #	Description
13731	26072	1/2", 5,000/Pk
13739	26073	3/4", 5,000/Pk

Insulation Adhesives

Glasstack® 35 Medium Tack Water Based Insulation Adhesive

- Medium tack time
- LEED EQ Credit 4.1
- Strong bond strength
- High solids
- Brush, rolls or spray application
- Meets SMACNA requirements
- Excellent mold and mildew resistance



Part #	Model #	Description
76108	GT-1	1 gal Pail, White
76109	GT35-5	5 gal Pail, White

Glasstack® 151 Solvent Based Insulation Adhesive

- Immediate tack
- Non-flammable when dry
- Excellent bond strength
- Offers exceptional strength
- Meets or exceeds all SMACNA requirements
- Mold and mildew resistant



Part #	Model #	Description
54994	GT151-1	1 gal Pail, Red
54996	GT151-5	5 gal Pail, White

Aero-Tack Aerosol Duct Liner & General Purpose Adhesive

- Bonds all types of insulation to metal, fiberglass, paper and wood
- Excellent general purpose adhesive
- VOC Compliant
- Variable pattern
- Fast tracking
- Adjustable spray



Part #	Model #	Description
54997	AT20Z	12 oz Aerosol, Clear

Spray-n-Bond® Insulation Adhesive

- Formulated for insulation and duct liner applications
- Ideal for uneven and porous surfaces
- Waterproof and transparent



Part #	Model #	Description
90350	4369-75	12 oz Aerosol

PVC Cleaners, Mortar & Cement

Plastic Pipe Cement

PVC Cement Clear (Blue Label)

- Medium body, medium set
- For PVC Types I and II potable water, DWV and SW pipe and fittings up to 6" diameter Sch 40 and 80
- Conforms to ASTM D2564



Part #	Model #	Size
3985	31017	1/4 pt
4059	31018	1/2 pt
4086	31019	1 pt
4134	31020	1 qt

PVC Cement Clear (Orange Label)

- Regular body, fast set
- For CPVC
- Conforms to ASTM D2564



Part #	Model #	Size
6920	31125	1/2 pt

PVC Cement Clear (Green Label)

- Medium Body Fast Set
- For use on all schedules and classes of PVC pipe and fittings up to 6" diameter with interference fit
- Recommended application temperature -15°F to 110°F / -26°C to 43°C.
- Meets ASTM D2564



Part #	Model #	Size
5317	60142	1/2 pt
5343	31132	1 PT
5370	31133	1 QT

Plastic Pipe Primers & Cleaners

PVC & CPVC Purple Primer (Purple Label)

- To soften and prepare surface of PVC and CPVC pipe and fittings
- Contain a dye which is difficult or impossible to remove
- For all schedules



Part #	Model #	Size
7814	30755	1/4 pt
7902	30756	1/2 pt
7923	30757	1 pt
7960	30758	1 qt

PVC Clear Primer (Red Label)

- Soften and prepare surface of PVC pipe and fittings



Part #	Model #	Size
8271	30750	1/4 pt
8330	30751	1/2 pt
8345	30752	1 pt

Concrete & Mortar

Sakrete® Mortar/Stucco Mix Type S

- High strength mortar mix
- Grey
- Mixture of sand and cement
- For laying brick, block, and stone, for building load bearing walls above and below ground level, and for tuck pointing mortar joints and stuccoing walls
- Not to be used as grout on traffic bearing surface
- Exceeds ASTM specification C387



Part #	Model #	Size
15516	13240	40 lbs

Furnace/Stove Cement

High-Heat Regular Body Furnace/Stove Cement

- High temperature refractory and retort cement for mortar facing, caulking or coating
- Clean 'n Friendly™ formula
- Will not shrink, crack or crumble
- Contains no oil, asbestos or silicon dioxide



35509



35515

Part #	Model #	Size
2720	35504	1 pt
2808	35515	1/2 gal
3738	35610	1 gal

Hydronics Supplies

Anti-Freeze

Cryo-Tek™ 100 Anti-Freeze

- Contains virgin (not recycled) propylene glycol with triple protection corrosion inhibitor
- Pre-mixed, ready-to-use formulation
- Pink liquid
- Compatible with PEX and elastomeric radiant tubing
- Low freeze point and higher boiling point than water
- Non-flammable, odorless, non-toxic
- Freeze protection down to -70°F/-57°C
- Pumpable down to -80°F/-62°C
- Burst protection down to -100°F/-73°C



Part #	Model #	Size
867	35284	5 gal

Cryo-Tek™ 100/AL Anti-Freeze

- Special formula for aluminum heat exchange boilers
- Orange liquid



Part #	Model #	Size
46483	35283	5 gal

Cryo-Tek™ Test Kit

- Checks level of propylene glycol and level of corrosion protection



Part #	Model #	Includes
21350	35271	(10) Color-Coded Disposable Test Strips

Winter-Treat®

- Multi-treatment product for hot water and steam heating boilers and other closed water systems
- Emulsifies and cleans away rust, corrosion deposits, and sludge as well as inhibits system corrosion, foaming, surging and lime scale



Part #	Model #	Description
69496	4390-32	1 qt Bottle
69495	4390-08	1 gal Bottle

Boiler/Heating System Stop-Leaks

Boiler Liquid

- For lasting repairs of cracked or leaking steam and hot water heating boilers
- Will not clog system or controls
- Withstands high pressures
- Cannot cause odors, priming or foaming
- Boiler cleaners will not affect repairs made with this product



Part #	Model #	Size
1773	30115	1 qt
1814	30120	1 gal

Boiler & Heating Cleaners

Boiler & Heating System Cleaner

- Liquid cleaner and corrosion preventative treatment
- Helps maximize boiler efficiency



Part #	Model #	Size
127	35206	1 qt
176	35211	1 gal

Scale Removal/Descaling

Vital-Flo™ Tankless Water Heater Descaler

- Includes:
 - 1/6 hp Submersible descaler pump
 - Set of (2) 5' x 3/4" female hose threaded assemblies
 - 8 oz Descaler solution packaged in a lidded 4 gal chemical resistant container



Part #	Model #	Description
76110	4387-01	Vita-Flo™ Kit
76113	4387-02	8 oz Solution Only

Coil Cleaners & Sprayers

Coil Cleaners

Blackhawk™ Expanding Foam Coil Cleaner

- Safe for cleaning HVAC/R coils in food processing areas
- Metal/plastic safe
- Non-rinse for evaporators
- Nonflammable
- Biodegradable
- Sprays from any angle



Part #	Model #	Description
161003	4127-75	18 oz Can

Cal-Blast® Condenser Coil Cleaner

- High performance aerosol with excellent solvency and blasting spray
- Quick-drying solvent with a pleasant scent
- High dielectric strength and non-flammable



Part #	Model #	Description
75834	4132-20	20 oz

Cal-Brite® Coil Cleaner

- Low-ph or acid-based product
- For cleaning evaporator coils, air-cooled condensers and other finned cooling and heating coils
- Based upon glycolic acid and ammonium bifluoride
- Can be used inside or outside



Part #	Model #	Description
54881	4133-08	1 gal Bottle

CalClean® Coil Cleaner

- Formulation of liquid detergents
- Contains a balance of surfactants, grease solvents, alkaline cleaners, corrosion inhibitors and water conditioners
- Concentrated detergent designed to be diluted with four to ten parts of water



Part #	Model #	Description
73969	4135-08	1 gal Bottle

Special HD CalClean® Coil Cleaner

- Extra-strong liquid detergent for evaporators and condensers
- Contains surface-active agents, grease solvents, alkaline cleaners, corrosion inhibitors and water conditioners
- Designed for cleaning electronic air filters
- Will not corrode or tarnish aluminum or other metals when used at the recommended concentrations



Part #	Model #	Description
74860	4143-08	1 gal Bottle

Cal-Green Coil Cleaner

- Biodegradable
- Low-foaming, non-toxic coil cleaner
- Part of NuCalgon's "Green Select" program
- EPA Design for the Environment (DfE) recognized for safer chemistries



Part #	Model #	Description
60009	4190-08	1 gal Bottle

Evap-Fresh® No Rinse Evaporator Coil Cleaner

- Ready-to-use, non-abrasive, one-step cleaner and disinfectant
- For evaporator coils in small air conditioners, commercial air handling equipment, HVAC cooling coils and refrigeration equipment
- Kills viruses like SARS, Norwalk, Rotovirus and more



Part #	Model #	Description
54904	4166-75	18 oz Aerosol

Evap Foam No Rinse® Coil Cleaner

- High performance detergent with special surfactants and alkaline cleaners that have been developed into a foaming, no rinse product
- Spray right side up or upside down
- For cooling or evaporator coils
- NSF Registered



Part #	Model #	Description
54903	4171-75	18 oz Aerosol

Coil Cleaners & Sprayers

Evap-Green Evaporator Coil Cleaner

- Biodegradable
- Removes dust, dirt and debris on evaporator coils
- Part of NuCalgon's "Green Select" program
- EPA Design for the Environment (DfE) recognized for safer chemistries



Part #	Model #	Description
60010	4191-08	1 gal Bottle

Evap Pow'r-C® Evaporator Coil Cleaner

- "No-rinse" product formulated for cleaning indoor evaporator coils
- Metal-safe
- Cleans and emulsifies the most stubborn soils and deposits
- Biodegradable
- USDA Authorized



Part #	Model #	Description
15003	4168-08	1 gal Bottle

Foam-Brite® Condenser Coil Cleaner

- Non-acidic, alkaline-based cleaner and brightener
- Contains biodegradable ingredients and a chelant/surfactant package to penetrate and remove greasy soils and oxidation
- High foaming formula
- Does not contain any acids
- Not for indoor use or use on evaporator coils



Part #	Model #	Description
54884	4178-08	1 gal Bottle

Nu-Blast® Condenser Coil Cleaner

- "No rinse required" condenser coil cleaner
- Double action of high pressure blast and solvent cleaning
- Non-flammable and non-conductive



Part #	Model #	Description
9302	4290-75	18 oz Aerosol

Nu-Brite® Condenser Coil Cleaner

- Non-acid, alkaline-based
- For cleaning and brightening
- Formulated with foaming detergents and chelants to penetrate and dissolve greasy dirt and grime and foam it right out of the coil
- Safer alternative to acids



Part #	Model #	Description
54883	4291-18	18 oz Aerosol
18250	4291-08	1 gal Bottle

Green Clean® Coil Cleaner

- All purpose cleaner
- Rapidly removes grim and other heavy soils
- Penetrates greasy and oily surfaces
- Non-corrosive
- Part of NuCalgon's "Green Select" program
- EPA Design for the Environment (DfE) recognized for safer chemistries



Part #	Model #	Description
54901	4186-24	1 qt Spray Bottle

TriClean 2X Coil Cleaner

- For the annual cleaning of residential and light commercial outdoor A/C coils
- Simply connect to hose, clean, and rinse
- Restores system efficiency by rapidly emulsifying insulating soils from outdoor coil
- A must-have for any clean and check preventative maintenance program
- Cleans where water alone is ineffective
- Metal safe, biodegradable chemistry
- (1) Bottle cleans up to (3) 5-ton coils
- No sprayer required



Part #	Model #	Description
81555	4372-24	1 qt w/Hose Connector

Coil Cleaners & Sprayers/Refrigeration Flush & Oil

Sprayers

Coil Gun® Sprayer & Probe

- Use for coil cleaning as well as in food preparation areas, wash rooms, or any situation where use of water-diluted chemicals are required
- No pre-mixing is necessary as chemical and water are automatically blended in mixing head as you spray
- Coil Gun® probe has 90° direction of spray that allows cleaning from inside the coil



4774-0

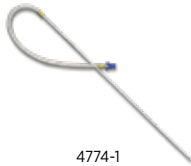

4774-1

Part #	Model #	Description
15190	4774-0	2 qt Capacity Sprayer
126180	4774-1	Coil Gun® Probe

No. 220CP Poly Sprayer

- Constructed of high-density translucent polyethylene
- Can be used for spraying solutions on air conditioning cooling coils, air-cooled condensers, finned heating coils, refrigeration case or cooler coils, permanent air filters and other greasy, dirty surfaces



Part #	Model #	Description
54886	4771-3	2 gal Capacity Sprayer

Chemical Sprayers

Compression Sprayer

- Environmentally safe foam
- 5-Year warranty



Part #	Model #	Description
26125	1002	Hand-Held Sprayer

Rx11-flush® Air Conditioning & Refrigeration System Flush

- Solvent that has been engineered for flushing refrigeration and air conditioning systems
- HFC Based solvent formulation is powerful enough to flush away sludge, carbon residue, oils, acids, water and other particulate
- For system flushing after burnouts, retrofits, and for flushing line sets for R-410A conversions
- Non-toxic, non-flammable and is non-ozone depleting



4300-08



4300-09



4300-10



4300-15



4300-30



4300-38



4300-50



4300-89

Part #	Model #	Description
65161	4300-08	Rx11-flush® Start Kit, Includes: 1 lb Can, Hose, Gun & Valve
54896	4300-09	1 lb Canister, Flushes 3 - 4 Tons
54893	4300-10	2+1 Display Pack, Includes (2) 2 lb Cans & Valve
55926	4300-15	13 lb Canister
79498	4300-30	19.5 oz Can
79499	4300-38	Starter Kit with Liquid Can, Tank, Gun & Hose
54891	4300-50	Flushing Tool
54890	4300-89	Injection Valve

Refrigeration Oils

A/C Re-New Refrigeration and Vacuum Pump Oil

- Used to improve the performance of air conditioning and refrigeration systems
- Quiets noisy systems and extends the life of the system
- Reduces energy consumption
- Lubricant that blends with the system's oil



Part #	Model #	Description
66279	4057-55	A/C Renew 4 oz.

Refrigeration & Oil/Lubricants & Oils

Refrigeration Compressor Oil

Pro-Lube-POE™ 100 Polyolester

- Refrigeration compression oil
- For use with HFC and other highly fluorinated, environmentally safe refrigerants
- OEM Approved
- ISO Grade 100



Part #	Model #	Size
67389	POE100-32	1 qt

Refrigerants



R-22 / 30#



R410-A / 25#



R-438A / 25#

Part #	Model #	Refrigerant	Qty
10625	R-22 30#	R-22	30 lbs
23357	R-410A 25#	R-410A	25 lbs
89656	M099 25#	R-438A	25 lbs

Lubricants

WD-40® Lubricant



Part #	Model #	Description
1194	18047	12 oz

Lubricants

Break-n-Lube

- Penetrates, lubricates, displaces moisture, and provides superior resistance to corrosion
- Made with CERFLON®



Part #	Model #	Description
54905	4128-03	12 oz Aerosol

Penetrate HD® Super Penetrating Oil

- Frees stuck fan blades, blower shafts, pulleys, rusted nuts and bolts
- Low surface tension formula penetrates into the smallest spaces and breaks and dissolves the bonds of rust and corrosion
- For industrial and professional use only



Part #	Model #	Description
161007	61105	12 oz Can

Zoom-Spout Oiler

- All purpose oiler with 14" telescoping spout



Part #	Model #	Description
18710	40019	4 oz

Dark Cutting Oil

- For high-speed machine-threading requirements
- High-quality mineral oil with sulfur-lard base
- Contains no nitrosamines



40220

Part #	Model #	Size
16486	30204	1 qt
16523	30205	1 gal

Screws & Fasteners

Super Sabers® Screws

- Self piercing screws for light to medium gauge
- Formed from steel, heat treated and zinc plated
- All standard Saber screws are 1/4" head



Part #	Model #	Description
15344	14166	7 x 1/2", 100/Pk
15272	14159	7 x 1/2", 1,000/Pk
5678	15154	7 x 1/2", 5,000/Bucket
15364	14167	8 x 1/2", 100/Pk
15283	14160	8 x 1/2", 1,000/Pk
5684	15155	8 x 1/2", 5,000/Bucket
15296	14161	8 x 3/4", 1,000/Pk
5696	15156	8 x 3/4", 4,000/Bucket
15656	14193	8 x 1", 100/Pk
15455	14174	8 x 1", 1,000/Pk
5779	15167	8 x 1", 3,000/Bucket
15423	14172	8 x 1-1/2", 100/Pk
32869	14175	8 x 1-1/2", 1,000/Pk
5784	15168	8 x 1-1/2", 3,000/Bucket
15437	14173	8 x 2", 100/Pk
15484	14176	8 x 2", 1,000/Pk
5797	15169	8 x 2", 3,000/Bucket
5899	15180	8 x 2" White Head, 100/Pk

Screws

Pro Points® Screws

- Self-drilling screws for heavy gauge



Part #	Model #	Description
15493	14177	8 x 1/2", 100/Pk
15577	14185	8 x 1/2", 1,000/Pk
15595	14187	8 x 3/4", 1,000/Pk
15618	14189	10 x 5/8", 1,000/Pk
15624	14190	10 x 3/4", 1,000/Pk

Zip-In® Screw



Part #	Model #	Size	Qty
16931	HW7x1/2Z	7 x 1/2"	15,000/Pk
1620	HW7x1/2ZT	7 x 1/2"	1,000/Pk

Zip-In® Screw Painted White



Part #	Model #	Size	Qty
2407	HW8X11/2ZWT	8 x 1-1/2"	250/Pk

High Head Saber Screws

- Pierces through heavier gauges of steel
- No metal filings to clog drill chuck



Part #	Model #	Description	Pkg. Qty.
193781	11028	High Head 8 x 1/2"	100
193782	11023	High Head 8 x 1/2"	1000
193785	11026	High Head 8 x 1/2"	5000
193786	11024	High Head 8 x 3/4"	1000
193788	11030	High Head 8 x 3/4"	4000

Rivets

Steel Rivet



Part #	Model #	Riv Dia	Body Length	Mandrel	Pk Qty
7324	SS42D	1/8"	.232	Plated	1,000

Fasteners

Cable Ties

BRAMEC®



Part #	Description	Pkg. Qty.
34366	7" Black Nylon UV Rated Tie	1000
11681	8" Black Nylon UV Rated Tie	100
43951	12" Black Nylon UV Rated Tie	100
9597	36" Natural Nylon Tie	50
9016	48" Natural Tie Natural Nylon Tie	50
70385	11" Natural Nylon Tie w/Screw Eye	50

Hangers

Wood Vertical Hanger

- For 3/8" rod
- 1-Piece self-tapping screw style mechanical anchor
- Used for anchoring into wood
- 25/Pack



Part #	Model #	Size
134166	7165-25	1/4" x 2" Wood

Concrete Vertical Hanger

- For 3/8" rod
- 1-Piece self-tapping screw style mechanical anchor
- Used for anchoring into concrete
- 25/Pack



Part #	Model #	Size
134167	7173-25	1/4" x 1/2" Concrete

Drivers

Vertigo Driver



Part #	Model #	Description
134169	7187	Universal Red Metal/Wood Socket
134168	7197	3/8" Blue Concrete Socket



A MUNCH'S SUPPLY COMPANY

WE ARE A FULL LINE WHOLESALER.

For products not shown in this catalog,
contact us for complete information.

Misc. Supplies

Anchors

EPA Plastic Anchor Kit

- With pan head sheet metal screws with combination heads
- Plastic anchors
- High impact reusable plastic case
- Includes masonry drill bit



Part #	Model #	Anchor Size	Screw Size
11340	GBAP4-K100	1/4 x 1"	10 x 1-1/4"

Nylon Straps



MA-RS300

Part #	Model #	Length	Type
58386	MA-S144	12'	Clip
58387	MA-RS300	15'	Ratcheting



Yellow Polypropylene Rope

- 100% Twisted, 3-strand monofilament
- Buoyant



Part #	Model #	Size
58388	MA-0360	1/4" x 50'
58389	MA-0363	3/8" x 100'



Cooling Tower & Water Treatment Products

Humidi-Pro Humidifier Water Treatment

- Designed for humidifiers using up to 25 gallons per day
- Inhibits scale for one season



Part #	Model #	Description
56379	4190-02	Humidi-Treat In-line Filter

Hand Cleaners

Scrubs® HVAC 80

- Pumice hand-cleaner impregnated towel
- Disposable



Part #	Model #	Description
5459	4366-87	80 Count Bucket

Great Wipes

- Industrial strength waterless wipes
- Pre-moistened with pumice scrub
- Disposable



Part #	Model #	Description
75833	4185-75	75 Count Bucket
194347	51425	Kleaners Hand Cleaning Towels

Specialty Aerosol Products

Nu-Kill® II Wasp & Hornet Killer

- Formulated with both tetramethrin and permethrin for instant kill
- Provides residual kill as insects return to the nest
- Does not contain any CFC's
- Very high dielectric strength



Part #	Model #	Description
9204	4292-75	13 oz Aerosol

A/C Shine

- Cleans exterior metal surfaces



Part #	Model #	Description
161004	61118	12 oz Can

Misc. Supplies

Compressor Oil Products

Acid-Away® Acid Neutralizer for POE

- Compressor burnout acid neutralizer
- Helps compressor burnouts by effectively removing the acid buildup that occurs in polyol ester refrigeration oils used in air conditioning and refrigeration systems
- Treatment for both hermetic and semi-hermetic compressors of virtually any size that operates with polyol ester lubricants
- Eliminates the need for flushing systems with solvents to remove residual acids



Part #	Model #	Description
82497	45009	4 oz

Wasp & Hornet Killers

ENFORCER® Wasp & Hornet Killer

- Kills wasps, hornets, and yellow jackets
- Delivers 20' jet blast
- Instant knock-down



Part #	Model #	Size
9062	VIRVB	16 oz

Gloves

Journeyman Utility Gloves (K1)

- Supple, breathable, durable synthetic leather palm
- 2-Way stretch spandex padded top for form-fitting elasticity
- Reinforced thumb, index finger, and fingertips
- Concealed interior seam stitching prevents snagging
- Wide opening elastic cuff
- Contact points on index finger and thumb feature smooth surface for improved handling of objects



Part #	Model #	Size
54851	40053	Large

Journeyman™ Leather Work Gloves (K4)

- Genuine goatskin professional grade leather
- 2-way form-fitting spandex top for ventilation, comfort, and fit
- Molded Thermal Plastic Rubber (TPR) ribs for flexible protection for back of hand and fingers
- Thermal Plastic Rubber (TPR) cuff strap with hook and loop closure
- Easy entry elastic cuff ventilates and increases comfort
- Stretch knuckle with Ethylene Vinyl
- Acetate (EVA) foam padding
- Lightly padded palm increases grip and comfort



Part #	Model #	Size	Description
140536	40067	Medium	Journeyman Work Gloves
54855	40069	X-Large	Journeyman Work Gloves
142169	40222	X-Large	Journeyman K4 Work Gloves
142168	40206	Large	Journeyman Utility Work Gloves
140600	40207	Large	Journeyman Utility Work Gloves
194351	40215	Large	Journeyman Grip Gloves
194353	40216	X-Large	Journeyman Grip Gloves

Gloves

Work Gloves

- High quality and economically priced
- Hang tags for pegboard display



Part #	Model #	Description
37009	16766	9 oz Brown Jersey

Black Contractor Gloves



Part #	Model #	Size
138896	PCBK-L	Large
138895	PCBK-XL	X-Large

Shoe Covers

- Slip-resistant sole



Part #	Model #	Description
32834	19807	X-Large Shoe Covers, Bulk
54503	19819	XX-Large Shoe Covers (Pair), Bag of 50
162250	20361	Water Proof Shoe Cover, Pack 40

Gloves, Kneepads & Tape

Blue Contractor Gloves

- Resists stretching, shrinking and hardening
- Breathable, washable fabric
- Protects knuckle area
- Hook and loop, soft cuff closure
- Fingertip grips
- Large hand tag



Part #	Model #	Size
138897	PCBU-L	Large
138899	PCBU-XL	X-Large

Journeyman Pro Contractor Gloves

- Breathable, washable fabric
- Adjustable velcro tabs
- Reinforced thumb and finger tips
- Anti-slip double stitched palm pad
- Black synthetic leather and red spandex construction



Part #	Model #	Size
138900	PCRD-L	Large
138901	PCRD-XL	X-Large

343 Kneepads

- Poly shield cap
- Nylon fabric
- High density foam core
- Tapered



Part #	Model #	Size
146513	04811	7" x 9-1/4"



Foil Tape

322 General Purpose Aluminum Foil Tape

- 5 mil Thickness
- Conformability to irregular surfaces
- 2 mil Dead soft aluminum foil backing with synthetic rubber backing and unbleached natural kraft paper liner
- Low VOC content
- UL 723 Classified



Part #	Model #	Size
25859	322-25	2-1/2" x 50 yds

360-17 Foilmastic UL723 Listed Tape

- Printed aluminum
- 2 mil Dead soft; 15 mil adhesive blend
- Butyl rubber adhesive
- Release liner
- Waterproofing repair tape



Part #	Model #	Size
24385	360-17-3	3 x 100'

Duct Tape

365 Premium Duct Tape

- Easy to apply - no liner
- Extremely conformable, very aggressive adhesive
- Backing matches metal surfaces
- Used to match and close aluminum, steel and other types of metal



Part #	Model #	Size	Color
11522	365	2" x 60 yds	Silver

398 Professional Grade Duct Tape

- 11 mil Thickness
- Excellent balance of tearability and tensile strength; 27 lbs/inch
- Conforms well to irregular surfaces
- Superior holding power for hanging applications
- Tears straight, hangs straight, curl resistant
- Easy unwind
- Low VOC content
- PE Suffix - coated cloth backing with rubber adhesive



Part #	Model #	Size	Color
20965	398	2" x 60 yds	Grey
18701	398	2" x 60 yds	Black

222 Cloth Duct Tape

- Polyethylene coated cloth
- Natural rubber adhesive

Part #	Model #	Size	Color
42781	222	3" x 60 yds	Silver

Foam Insulation Tape



Part #	Description	Size
140252	Nu-Calgon Foam Tape PE	3 8" x 2" x 30'

Models and Specifications are Subject to Change Without Notice

Tape

Duck Tape

555 FlexFix™ UL181B-FX Listed Film Tape

- 3.1 mil Thickness
- Tensile strength: 34 lb/in
- Operating temperature: 0° to 210°F
- Printed OPP film backing
- Acrylic adhesive
- Tough, contractor grade closure system for Class 1 flexible air ducts and connectors
- Sealing reflective and bubble insulation
- Suitable for metal to metal connections in HVAC and refrigeration applications
- Low VOC content



Part #	Model #	Size	Color
44078	880921	48mm x 110m (1.88" x 120yd)	Metallic

Foil Tape

324A Printed Cold Weather Premium Foil Tape UL181A and B Listed

- 4.8 mil Thickness
- Tolerates extreme temperatures; -20° to 326°F
- Long-term anchorage and strong cohesive bond for long-term durability
- 2 mil Aluminum foil backing with acrylic adhesive and unbleached natural kraft liner
- Low VOC content



Part #	Model #	Size
3572	324A	2-1/2" x 60 yds

330 Extreme Weather Foil Tape

- 3.7 mil Thickness
- For taping joints and seams in ductwork for heating, A/C and refrigeration systems
- Working temperature of -35° to 260°F
- 1.75 mil, Dead-soft aluminum foil backing
- For plain dead soft aluminum foil-faced duct systems
- High adhesion, quick stick
- Matches most foil laminated duct work
- For use over a wide temperature range
- UL 723 Listed all weather duct tape



Part #	Model #	Size
49264	330-3	3" x 50 yds

338 Foil/Scrim/Kraft Tape

- 8 mil Thickness
- Tensile strength: 35 lb/in
- Diamond pattern, tear resistant
- Provides excellent adhesion to substrate over wide temperature range
- Extra strength seal to maintain vapor barrier integrity
- Low VOC; Tested in accordance with UL 723



Part #	Model #	Size
7578	338	3" x 50 yds

Foil Flue Tape



Part #	Model #	Description
173551	335FT	High Temperature Foil Flue Tape

339 Cold Weather Premium UL181A-P & B-FX Printed Foil Tape

- 4.8 mil Thickness
- Tensile strength: 27 lb/in
- Operating temperature: -20° to 325°F
- Printed 2 mil foil backing
- Cold weather acrylic adhesive
- Unbleached natural kraft paper liner
- Permanently seals seams in fiberglass duct board and flexible ducts for HVAC systems
- Tear-resistant
- Low VOC content



Part #	Model #	Size	Color
43591	339	3" x 60 yds	Aluminum

Electrical Tape

821 Economy PE Electrical Tape

- Polyethylene film backing
- Solvent and moisture resistant
- Superior tape for application in cold or warm weather



Part #	Model #	Size	Color
6907	821	3/4" x 60'	Black

Tape

Industrial PE Film Tape

827 Multi-Purpose PE Film Tape

- Tough Polyethylene backed tape with chemical resistant rubber adhesive
- Resists degradation from UV exposure
- For electroplate masking, splicing polyethylene, sealing packages, holding labels



Part #	Model #	Size	Color
6045	827	2" x 36 yds	White

Berry Plastics 444 Line Set Tape

- 3.0 mil Thickness
- Tensile strength: 32 lb/in
- High adhesion for wrapping and protecting outdoor line sets
- Resists lifting and flagging
- OPP Film backing with acrylic adhesive
- UV-Resistant; Low VOC



Part #	Model #	Size	Color
55195	685011	48mm x 55m	Black
196207	444W	48mm x 55m	White

BRAMEC®

Insulation Tape

Cork Insulation Tape

- Adheres firmly to all metals
- Can be used on hot & cold pipes
- Won't dry or crack
- Stops condensation and drips



Part #	Model #	Description
5617	1006	1/8" x 2" x 30' Roll

Foam Insulation Tape

- Self-adhesive tape
- Easily cut and molded
- Works on both hot & cold pipes, valves and fittings



Part #	Model #	Description
5628	1007	1/8" x 2" x 30' Roll

Extreme Temp Foil Tape

Part #	Model #	Description
173511	335	Extreme Temp Foil Tape 3" x 335'



6 CONVENIENT LOCATIONS

ANN ARBOR

141 Jackson Industrial
Ann Arbor, MI 48103
P (800) 665-1452
F (734) 665-0679
M-F: 7:30 a.m. - 4:30 p.m.

COLDWATER

36 Mill Street
Coldwater, MI 49036
P (800) 922-5180
F (517) 279-7350
M-F: 7:30 a.m. - 4:30 p.m.

GRAND RAPIDS

130 Graham S.W.
Grand Rapids, MI 49503
P (800) 541-1144
F (616) 247-0283
M-F: 7:30 a.m. - 4:30 p.m.

JACKSON

1021 Belden Road
Jackson, MI 49203
P (800) 333-8005
F (517) 782-1155
M-F: 7:30 a.m. - 4:30 p.m.

LANSING

1115 S. Pennsylvania
Lansing, MI 48912
P (800) 487-4836
F (517) 487-1119
M-F: 7:30 a.m. - 4:30 p.m.

SAGINAW

219 Atwater
Saginaw, MI 48601
P (800) 292-0233
F (989) 754-4241
M-F: 7:30 a.m. - 4:30 p.m.

Gas Valves

Combination Gas Controls

VS820 Millivoltage Combination Gas Control

- For use with gas-fired standing pilot appliances with 750mV self-powered control systems
- Capacities:
 - 1/2" x 3/4" Capacities 250,000 BTUH based on 1" p.d. 23,000 BTUH minimum, 290,000 BTUH maximum
- Adjustments and connections are accessible from top of control
- Add separate energy cutoff (ECO) where codes call for dual safety shutoff, part no 392451-1
- Mount 0° to 90° in any direction from the upright position of the gas control knob, including vertically
- Requires use of 750mV Powerpile generator
- Straight-through body pattern, multi-tapped with 1/2" right and left outlets plugged, except as noted
- Includes:
 - Manual gas valve
 - Safety shut-off
 - Single millivoltage automatic valve operator
 - Optional pressure regulator
 - LITE-RITE (Off-Pilot-On) lighting sequence
 - Safety shut-off on pilot flame failure
 - Pilot flow adjustment screw
- UL Listed, CSA certified



Part #	Model #	Inlet/ Outlet Size	Voltage	Type	Pressure Regulator Setting	Type of Gas	Ambient Temp Range	Type of Pressure Regulator
10578	VS820A1047	1/2" / 3/4"	750mV	1-Stg	3.5"wc, 3"-5" Adj	NG	32° to 175°F	Std (1)

* 1/2" NPT Side outlets

(1) Includes (1) 3/4" x 1/2" reducer bushing and (1) 1/2" x 3/8" reducer bushing

Gas Valves

VR Series Combination Gas Controls

- (2) Automatic valves
- Solenoid-operated first automatic valve opens on thermostat call for heat; closes when call for heat ends
- Diaphragm-operated second automatic valve opens under control of regulator; closes if gas or power supply is interrupted
- Meets codes requiring dual safety shut off
- Mounting: 0° to 90°, any direction from upright position of gas control knob, including vertically
- For use in gas-fired, standing pilot appliances with capacities from 30 - 300 cfh
- Controls include safety shutoff, manual valve, (2) automatic operators, pressure regulator and pilot adjustment
- All adjustments, wiring connections and pilot outlets are accessible from the top of control
- Adjustable Servo regulator effectively maintains almost constant gas output pressure under wide fluctuations in gas supply pressure
- LITE-RITE (Off-Pilot-On) lighting sequence
- Capacities:
 - 1/2" x 3/4" Capacities 190,000 BTUH based on 1" p.d. 30,000 BTUH minimum, 290,000 BTUH maximum
 - 3/4" x 3/4" Capacities 200,000 BTUH based on 1" p.d. 30,000 BTUH minimum, 300,000 BTUH maximum
- Compatible with ECO connector
- Compact size
- Straight-through body patter, with integral tapping and flange
- Frequency: 60Hz
- UL Listed, CSA certified



Part #	Model #	Inlet/Outlet Size	Voltage	Type	Pressure Regulator Setting	Type of Gas	Ambient Temp Range	Type of Pressure Regulator
11789	VR8300A3500	1/2" / 3/4"	24VAC	1-Stg	3.5"wc/0.87kPa	NG	-0° to 175°F	Std (2)
2335	VR8300A4508	3/4" / 3/4"	24VAC"	1-Stg	3.5"wc/0.87kPa	NG	-0° to 175°F	Std (4)

(2) Includes NG to LP gas conversion kit (393691), (1) 3/4"x 1/2" reducer bushing
(4) Includes NG to LP gas conversion kit (393691), (2) 3/4"x 1/2" reducer bushings

VR200 Continuous Pilot Dual Automatic Valve Combo Gas Control

- For use in 24VAC gas-fired, standing pilot appliances with capacities from 20 to 200 cfh
- Controls include manual valve, (2) automatic operators, Servo pressure regulator and pilot adjustment
- All adjustments, wiring connections and pilot outlets are accessible from the top of control
- Adjustable Servo regulator effectively maintains almost constant gas output pressure under wide fluctuations in gas supply pressure
- LITE-RITE (Off-Pilot-On) lighting sequence
- Compatible with ECO connector
- Capacities 130,000 BTUH based on 1" p.d. 20,000 BTUH minimum, 200,000 BTUH maximum
- Compact size
- Straight-through body pattern
- Frequency: 60Hz
- UL Listed, CSA certified



Part #	Model #	Inlet/Outlet Size	Voltage	Type	Pressure Regulator Setting	Type of Gas	Ambient Temp Range	Type of Pressure Regulator
8314	VR8200A2132	1/2" / 1/2"	24VAC	1-Stg	3.5"wc/0.87kPa	NG	0° to 175°F	Std (2)
28482	VR8200H1251	1/2" / 1/2"	24VAC	1-Stg	3.5"wc/0.87kPa	NG	-0° to 175°F	Slow Opening (2)

(2) Includes NG to LP gas conversion kit (393691), (1) 1/2"x 3/8" reducer bushing, (1) 3/4" straight flange

Models and Specifications are Subject to Change Without Notice

Gas Valves

VR8345 Universal Electronic Ignition Combination Gas Control

- For use with direct spark ignition, hot surface ignition or intermittent pilot ignition in 24VAC, gas-fired appliances with capacities up to 300 cu ft/hour at 1" wc pressure drop
- Controls include manual valve, (2) automatic operators, pressure regulator, pilot adjustment, pilot plug and ignition adapter
- Replaces virtually any IP, HSI or DSI gas control
- For use with natural or manufactured gas or LP gas
- 4" Swing radius allows easy rotation into position inside the tightest furnace vestibules
- Clearly marked, keyed terminal block allows quick attachment wires and IP/DSI/HSI jumper
- Internal inlet screen blocks contaminants in gas line from entering valve
- Capacities:
 - 1/2" x 1/2" Capacities 240,000 BTUH based on 1" p.d.
30,000 BTUH minimum, 300,000 BTUH maximum
 - 3/4" x 3/4" Capacities 300,000 BTUH based on 1" p.d.
30,000 BTUH minimum, 415,000 BTUH maximum
- Compact size
- Straight-through body pattern
- Frequency: 60Hz
- UL Listed, CSA certified



Part #	Model #	Inlet/Outlet Size	Voltage	Type	Pressure Regulator Setting	Type of Gas	Ambient Temp Range	Type of Pressure Regulator
15167	VR8345M4302	3/4" / 3/4"	24VAC	1-Stg	3.5"wc/0.87kPa	NG	-40° to 175°F	Std (2)

(2) Includes NG to LP gas conversion kit (393691), (2) 3/4" x 1/2" reducer bushings

VR8304 Intermittent Pilot Dual Automatic Valve Combo Gas Control

- For use in 24VAC gas-fired, intermittent pilot with capacities from 30 to 415 cfh
- Controls include 100% safety shutoff, manual valve, (2) automatic operators, pressure regulator and pilot adjustment
- All adjustments, wiring connections and pilot outlets are accessible from the top of control
- Adjustable Servo regulator effectively maintains almost constant gas output pressure under wide fluctuations in gas supply pressure
- On-Off lighting sequence
- Use with S86F,H; S860D; S8600F,H; S8610 and S90A,B control modules
- Single stage unless otherwise noted
- Capacities:
 - 1/2" x 1/2" Capacities 240,000 BTUH based on 1" p.d.
30,000 BTUH minimum, 340,000 BTUH maximum
 - 1/2" x 3/4" Capacities 270,000 BTUH based on 1" p.d.
30,000 BTUH minimum, 370,000 BTUH maximum
 - 3/4" x 3/4" Capacities 300,000 BTUH based on 1" p.d.
30,000 BTUH minimum, 415,000 BTUH maximum
- Compact size
- Straight-through body pattern
- Frequency: 60Hz
- Compatible with ECO connector
- UL Listed, CSA certified



Part #	Model #	Inlet/Outlet Size	Voltage	Type	Pressure Regulator Setting	Type of Gas	Ambient Temp Range	Type of Pressure Regulator
17215	VR8304M4507	3/4" / 3/4"	24VAC	1-Stg	3.5"wc/0.87kPa	NG	-40° to 175°F	Std (3)

(3) Includes NG to LP gas conversion kit (393691), (2) 3/4" x 1/2" reducer bushings

Gas Valves

SmartValve® Hot Surface Pilot Ignition Controls

SV9501/SV9502 SmartValve® System Control

- Combines gas flow control and electronic intermittent pilot sequencing functions into a single unit
- The specific application of the SmartValve® System is the responsibility of the appliance manufacturer
- Directly compatible with the Q3450 or Q3480 intermittent pilot burners used with the original controls on the appliance
- Suitable for a wide range of gas-fired appliances including residential furnaces, roof-top furnaces, residential boilers, unit heaters, infrared heaters, space heaters, and commercial cooking units
- Replaces SV9500, SV9502, SV9601 and SV9602 controls
- Ignition sequence includes timed trial for ignition
- Flame sense: HSI
- Straight through body pattern
- Frequency: 50/60Hz
- CSA Certified



Part #	Model #	Inlet/ Outlet Size	Voltage	Pressure Regulator Setting	Type of Gas	Ambient Temp Range	PrePurge	Type of Pressure Regulator
28487	SV9502H2522	1/2" / 1/2"	24VAC	3.2"wc/0.80kPa	NG	0° to 175°F	15 Sec	Slow Opening
21626	SV9501M2528	1/2" / 1/2"	24VAC	3.5"wc/0.87kPa	NG	-40° to 175°F	None	Std

SV9520/SV9641 SmartValve® System Control

- Combines gas flow control and electronic intermittent pilot sequencing functions
- Communicates directly with an electronic fan timer (ST9160 Electronic Fan Timer for single-stage applications; ST9162 Electronic Fan Timer for two-stage applications) in typical forced warm air furnace applications
- These ignition system controls provide all gas ignition safety functions by controlling gas flow, ignition source, and a 120VAC or 240VAC combustion air blower
- Monitors the appliance airflow proving switch and limit string to assure proper appliance operation
- Provides prepurge, postpurge, timed trial for pilot ignition, with 100% shutoff and continuous retry
- Q3450 or Q3480 Pilot hardware supplies the low voltage igniter, flame sensor and pilot burner
- Suitable for wide range of fan assisted combustion gas-fired appliances including: furnaces, rooftop furnaces, boilers, unit heaters, infrared heaters, water heaters, and commercial cooking appliances
- Diagnostic LED indicates system status
- Directly interfaces with the appropriate power supplies and a system thermostat for additional appliance applications
- When controlled directly by a thermostat, these controls do not provide a postpurge function, because power to the control is removed when the thermostat call for heat ends
- Flame sense: 2-rod
- Straight-through body pattern
- Frequency: 60Hz
- CSA Certified



Part #	Model #	Inlet/ Outlet Size	Voltage	Pressure Regulator Setting	Type of Gas	Ambient Temp Range	PrePurge	Type of Pressure Regulator
57041	SV9520H8513	1/2" / 1/2"	24VAC	3.5"wc/0.87kPa	NG	0° to 175°F	15 Sec	Fast-Slow
57635	SV9641M4510	3/4" / 3/4"	24VAC	3.5"wc/0.87kPa	NG	-40° to 175°F	15 Sec*	Std (2)

* 30 Second postpurge

(2) Includes NG to LP gas conversion kit, (2) 3/4" x 1/2" reducer bushings

Models and Specifications are Subject to Change Without Notice

Gas Valves

Gas Valves

36C Standing Pilot Single-Function Gas Valve

- Wide range of applications and replacement valves
- Adjustable regulator
- Valve may be mounted upright, 90° from upright, and vertical
- Inlet/outlet screens
- Line interrupter
- Optional side outlets
- Use with thermocouples
- Ambient operating temperature: -40° to 175°F
- Maximum pressure rating: 1/2 psi (14.0"wc)
- Straight-thru flow direction
- Electrical: 24VAC @ 50/60Hz
- Includes LP Conversion Kit
- CSA Approved



Part #	Model #	Opening Characteristic	Inlet/Outlet Size	Nat Gas Capacity	Pressure Tap	Inlet Side Taps
2643	36C03-300	Fast Open	1/2" x 3/4"	230000	No	No
2933	36C03-333	Fast Open	1/2" x 3/4"	230000	No	Yes
3594	36C03-400	Fast Open	3/4" x 3/4"	280000	No	No

36H Intermittent Ignition Combination Gas Control Valve

- Highest capacity combination multi-function controls for a wide range of applications
- For use with most electronic ignition systems (HSI/DSI/proven pilot)
- Adjustable regulator
- Quiet operation redundant design
- Inlet/outlet screens
- Tamper resistant screws
- Natural gas
- Operating ambient temperature: -40° to 175°F
- Maximum pressure rating: 1/2 psi (14.0"wc)
- Electrical: 24VAC @ 50/60Hz
- Includes LP conversion kit
- CSA Approved



Part #	Model #	Opening Characteristic	Inlet/Outlet Size	Nat Gas Capacity	Pressure Tap	Inlet Side Taps
57248	36H32-304	1-Stg Fast	1/2" x 3/4"	230000	Yes	No
50099	36H32-423	1-Stg Fast	3/4" x 3/4"	300000	Yes	No
50100	36H64-463	2-Stg Fast	3/4" x 3/4"	300000	Yes	No

36H Intermittent Ignition Combination Gas Control Valve

Part #	Model #	Opening Characteristic	Inlet/Outlet Size	Nat Gas Capacity	Pressure Tap	Inlet Side Taps
72122	36C94-303	Delay Slow	1/2" x 3/4"	140,000	Yes	No

Pressure Regulators

Pressure Regulators

- Gases: natural, manufactured, mixed, liquefied, petroleum and LP gas-air mixtures
- Corrosion-resistant construction

325-3 Lever Acting Pressure Regulator

- Self-aligning valve with lever action for dead end lockup
- Maximum individual load: 100,000 BTUH
- Capacity: 150,000 BTUH
- Vent pipe connection: 1/8" NPT
- Multi-poise mounting



Part #	Model #	Description
4728	325-3-12	1/2" Reg with 12A09 Installed

325-5A Lever Acting Pressure Regulator

- Self-aligning valve with lever action for dead end lockup
- Maximum individual load: 325,000 BTUH
- Capacity: 325,000 BTUH
- Vent pipe connection: 3/8" NPT
- Multi-poise mounting



Part #	Model #	Description
14913	325-5A-34	3/4" Regulator
22697	325-5A-1	1" Regulator with 12A39 Installed

Gas Appliance Pressure Regulator Accessories

Vent Limiter

- Automatic vent limiting device
- For outdoor applications to ensure proper vent protection
- Must be mounted in horizontal upright position



12A09



12A39

Part #	Model #	Description
21089	12A09	1/8" NPT
20647	12A39	3/8" NPT, Brass

Vent Protector

- For use with 325-3, 325-3L
- For outdoor applications
- Protect breather hole from outside elements
- Must be mounted in upright position



Part #	Model #	Description
39392	13A15	For 1/8" NPT Vent

Gas Pressure Regulator Weather Covers

- Rubber weather shield for gas regulators

Part #	Model #	For use with:
58698	3R	325-3
58699	5R	325-5

Parts



A MUNCH'S SUPPLY COMPANY

**Let us be your
source for quality
products from
leading manufacturers.**

Furnace Controls

Integrated Ignition Furnace Controls

21V51U-843 Universal 2-Stage HSI Integrated Furnace Control Kit

- 16-Pin variable speed circulator output for ECM
- Pushbutton fault history retrieval
- Tri-color Furnace status LED (green, red and amber)
- Heat fan off delay (dipswitch selectable), fan on delay for cooling
- Auto second stage delay (dipswitch selectable)
- 120VAC Humidifier output, 120VAC electronic air cleaner output
- Operating temperature range: -40° to 175°F
- Includes:
 - Ignition control module
 - Wiring harnesses
 - Universal 120V nitride igniter kit (21D64-2)



Part #	Model #	Prepurge	Delay Heat ON	Delay Heat OFF	Delay Cool ON	Delay Cool OFF	Auto Reset
75807	21V51U-843	15 Sec	45 Sec	90/120/150/180 Sec	5 Sec	60 Sec	60 Min

21M51U-843 Universal 2-Stage HSI Integrated Furnace Control Kit

- 120VAC 3-Speed (PSC) fan motor output, 2-speed inducer output, 2-stage gas valve output
- Pushbutton fault history retrieval
- Tri-color Furnace status LED (green, red and amber)
- Heat fan off delay (dipswitch selectable), fan on delay for cooling
- Auto second stage delay (dipswitch selectable)
- 120VAC Humidifier output, 120VAC electronic air cleaner output
- Operating temperature range: -40° to 175°F
- Replaces all 50M51-XXX controls
- Includes:
 - Ignition control module
 - Universal 120V nitride igniter kit (21D64-2)
 - Installation instructions and OEM cross-reference



Part #	Model #	Prepurge	Delay Heat ON	Delay Heat OFF	Delay Cool ON	Delay Cool OFF	Auto Reset
75808	21M51U-843	15 Sec	45 Sec	90/120/150/180 Sec	5 Sec	60 Sec	60 Min

50A55 Universal Silicon Carbide HSI Integrated Furnace Control

- Diagnostic LED for flash code diagnostics
- Replaces most White-Rodgers and OEM integrated ignition modules for silicon carbide applications
- For gas-fired forced-air furnaces with integrated furnace control module with a silicon carbide igniter
- Fused to protect low voltage system transformers
- Additional jumpers to extend length of connections
- Includes:
 - Mounting hole template
 - Extensive model cross-reference



Part #	Model #	Prepurge	Delay Heat ON	Delay Heat OFF	Delay Cool ON	Delay Cool OFF	Auto Reset
36313	50A55-843	30 Sec	30/45 Sec	60/90/120/180 Sec	5 Sec	45/90 Sec	60 Min

Furnace/Heat Pump Controls

50M56U-843 Universal Single-Stage HSI Integrated Furnace Control Kit

- Replaces virtually all single-stage carbide and nitride HSI systems and many 80V and 120V OEM models
- Replaces all OEM models 80V and 120V
- 3-Fan speeds - cool, low heat and high heat
- Fault recall system diagnostics with red LED flash codes
- Low voltage fuse protection, 3A replaceable automotive type
- Surface mount multi-poise
- Input voltage: 25VAC @ 50/60Hz
- Operating temperature range: -40°F to 176°F
- Dimensions: 7" x 5-1/4" x 1-1/4"
- Includes:
 - Ignition control module
 - (9) quick-select/quick connect wiring harnesses
 - Universal 120V nitride igniter kit
 - Installation instructions and OEM cross-reference
 - Universal 120V nitride igniter kit (21D64-2)



Part #	Model #	Prepurge	Delay Heat ON	Delay Heat OFF	Delay Cool ON	Delay Cool OFF	Auto Reset
64434	50M56U-843	30 Sec	30 Sec	100/150 Sec	6 Sec	45 Sec	60 Min

47D01U-843 Universal Heat Pump Defrost Control

- Electrical rating:
 - Control voltage: 24VAC 50/60 Hz
 - Line voltage: 208/230VAC 50/60 Hz
- Input ratings:
 - Outdoor PSC fan: 0.5 hp @ 240VAC, 0.125 hp @ 120VAC
 - Contactor coil: 24VAC
 - Auxiliary heat (D/W/X2): 24VAC
 - Reversing valve: 24VAC
- Operating temperature range: -40° to 150°F (-40° to 65°C)
- Auxiliary heat lockout - above the selected temperature, auxiliary heat will only run during defrost operation, selectable from 0° to 40°F or off
- Compressor lockout selectable from -10° to 45°F or off
- Reversing valve shift delay selectable 0, 12, or 30 second delay
- Short-cycle protection selectable 0, 3, or 5 minute delay between cycles
- Random start delay - delay operation for a random delay after power outage to protect the compressor and avoid brownouts, selectable on or off
- Includes:
 - Defrost control board
 - Wiring harnesses
 - Coil and ambient temperature sensors
 - Mounting accessories and labels



Part #	Model #	Description
171966	47D01U-843	Universal Heat Pump Defrost Control

Furnace Controls

Fan Blower Control



ICM270

ICM271C

ICM275

Part #	Model #	Description
75431	ICM270	Replacement for OEM Models including Rheem 47-22827-X Series Control Boards
52106	ICM271C	Replacement for OEM Models including Carrier CES0110017/18 and HH84AA-X Series Control Boards
52107	ICM275	Replacement for OEM Models including Carrier CES0110019-X Series Control Boards

Furnace Control



ICM280

ICM2804

ICM289



ICM291

ICM292

Part #	Model #	Description
52108	ICM280	Replacement for OEM Models including Goodman B18099-XX Series Control Boards
71756	ICM2804	Replacement for Carrier CES0110074-00/01 control boards
63905	ICM289	Replacement for Lennox Control Boards (Replaces All BCC1, BCC2 and BCC3 Circuit Boards)
71761	ICM291	Replacement for Carrier LH33WP003/3A Control Boards
71762	ICM292	Replacement for Rheem 62-24140-04 Control Boards

HSI Gas Ignition Control



Part #	Model #	Description
62760	ICM283	Replacement for Popular Models, including Honeywell S8910U-1000

IPI Gas Ignition Control



ICM290A

ICM2902

ICM295

Part #	Model #	Description
62763	ICM290A	Replacement for Popular Models, including Honeywell S8610U-3009
164102	ICM2902	Replacement for Popular Models, including Lennox 30W33 and JCI G776RGD-14 Series Controls
78853	ICM295	Replacement for Carrier LH33WZ510

Furnace Ignition Control Board



ICM2810

ICM282A

ICM281

ICM286

ICM2805A

Part #	Model #	Description
196296	ICM2810	Replacement for Goodman PCBBF136 and PCBBF140
76348	ICM286	Replacement for Goodman PCBBF112(S), B1809926(S), 0130F00005(S) control boards
52110	ICM282A	Replacement for OEM models including Carrier HK42FZ0-xx series control boards.
71759	ICM2805A	Replacement for Nordyne 624631 control boards for use with G3, G4, G5, G6, M2 and M3 furnace modules
52109	ICM281	Replacement for OEM models including Carrier CES0110057-xx series control boards

Ignition Modules & Accessories

Ignition Pilot Modules

S8610U Universal Intermittent Pilot Module

- Replaces over 400 multiple field-installed intermittent pilot modules supplied by Honeywell®, Robertshaw®, Johnson®, and UTEC® (HSC)
- Uses existing intermittent pilot burner
- Provides ignition sequencing, flame monitoring and safety shutoff for intermittent pilot warm air furnaces and heating appliances
- For use in systems with combination igniter-sensor (single rod or dual rod/ remote sense)
- Provides 100% pilot gas shutoff if pilot fails to light; after 6-minute delay, trial for ignition is repeated
- Ignition trial/delay sequence is repeated until the appliance lights or call for heat is removed
- Honeywell VR8204, VR8304 or VR8345M combination gas control recommended
- Functional equivalent of S86, S8600, S8610 and S90 modules
- For use with natural or LP gas
- Includes: damper connection, automatic vent damper plug, cross reference, instructions and accessories
- CSA Certified



Part #	Model #	Flame Sense	Ignition Trial Time	Between Trial Time	Ignition Trials to Lockout	PrePurge
49354	S8610U3009	1- or 2-Rod	15 or 90 Sec	Continuous	Continuous	30 Sec or No Prepurge



We maintain well-stocked and conveniently located warehouses. Please visit us at the branch nearest you.

Parts

Ignition Modules & Accessories

S9200U Hot Surface Ignition Control

- Universal integrated furnace control offers universal compatibility and diagnostics
- Replaces a large number of furnace control models in single-stage warm air furnaces
- Uses 120VAC hot surface igniter
- Cross reference and wire harnesses provided for simple replacement over 195 existing furnace controls
- Main burner ignition using a 120V hot surface igniter
- Flame rectification circuit to monitor flame presence
- Monitoring of system pressure switch, high temperature limit, and rollout functions
- Appliance operation/safety requirements controlled via microprocessor
- Controls circulating fan motor based on appliance requirements, in response to a conventional low voltage thermostat
- LED System status, performance and diagnostic indication
- Twinning capability
- Includes: instructions and special wire harnesses



Part #	Model #	Description
52460	S9200U1000	Universal Integrated Furnace Control

Y8610U Universal Retrofit Intermittent Pilot Gas Burner Ignition System

- Intermittent pilot retrofit kits save energy by converting atmospheric standing pilot systems to intermittent pilot
- Typical applications are gas-fired atmospheric furnaces, boilers and heating appliances, NG or LP
- Provides 100% pilot gas shutoff if pilot fails to light; after 6-minute delay, trial for ignition is repeated
- Ignition sequence: continuous retry, after trial for ignition, pilot gas shuts off for (5) minutes, then another trial for pilot ignition takes place until appliance lights or call for heat is removed
- Includes: gas valve, ignition module, pilot burner hardware, ignition cable and wiring harness



Part #	Model #	Flame Sense	Ignition Trial Time	Ignition Trials to Lockout	PrePurge	Includes
52263	Y8610U6006	1- or 2-Rods	15 or 90 Sec	Continuous Retry	0 or 30 Sec	VR8304M3558

Ignition Module Accessories

Ignition Cable



Part #	Model #	Description
12910	394800-30	30" Ignition Cable Assembly for S8600 Family, with Right Angle Boot for Ignition Terminal & 1/4" Straight Quick Connect at Module End

Ignition Modules & Accessories

Ignition Pilot Modules

Universal Non-Integrated Hot Surface Ignition Module

- Silicon carbide igniter
- For gas-fired non-integrated forced-air furnaces and boilers
- Direct and indirect flame sense
- Tri-Color LED diagnostic indicator
- Valve relay load rating: 25VAC, 1.5A maximum
- Igniter relay load rating: 120VAC, 6.0A maximum
- Includes: program keys, color-coded timing label, double-sided foam back tape, mounting hardware and extensive cross-reference guide



Part #	Model #	Description
36387	50E47-843	Universal Ignition Module

Robertshaw.

Ignition Controls

785 Automatic Pilot Relight Kit

- For use on rooftop heating equipment, water heaters, boilers, space heaters, unit heaters, dryers, and other commercial, industrial and residential appliances where the problem of pilot outage may occur
- 1-Year limited warranty



Part #	Model #	Description
2467	785-001	24/120V Includes Igniter Assembly and Mounting Bracket



A MUNCH'S SUPPLY COMPANY

WE CARE WHO YOU ARE

Big business or small, you can expect the best service and quality products at competitive prices.

Igniters

Hot Surface Igniters

Hot Surface Igniter (HSI)

- Delivers dependable ignition in heating systems of every description
- Designed to reach ignition temperature(s) within 17 seconds
- Operates at 120VAC, some modules are rated for 208/240V input, however, the voltage to the igniter is stepped down to 120VAC
- 1-Year limited warranty



Part #	Model #	Factory Model#	Ceramic Block Style	Terminal Conn Style	Lead Wire Length	Notes:
13917	41-401	271A	A	A	4-1/2"	Includes Gasket
13926	41-402	217W	B	None	19"	
13940	41-404	271	C	C	4-1/2"	Includes Special Mount Adapters
13949	41-405	2711D	D	None	5-1/2"	
13962	41-406	271Y	E	None	10-1/2"	
13978	41-408	271	B	C	5"	
13988	41-409	271	C	D	4-1/2"	
13996	41-410	271N	B	B	4-1/2"	
14011	41-412	271NM	F	None	5-1/4"	

CERAMIC BLOCK STYLES

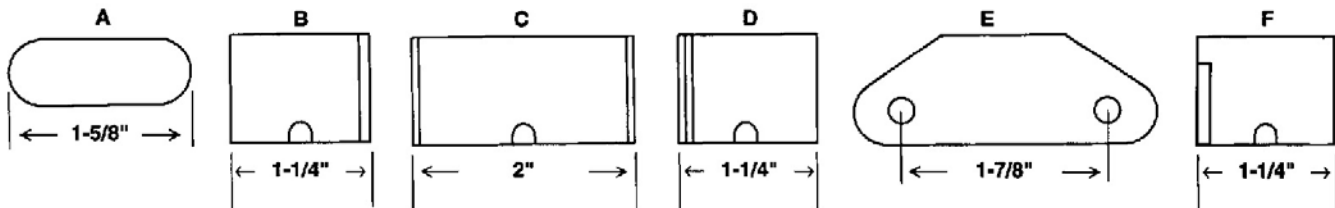

TERMINAL BLOCK STYLES

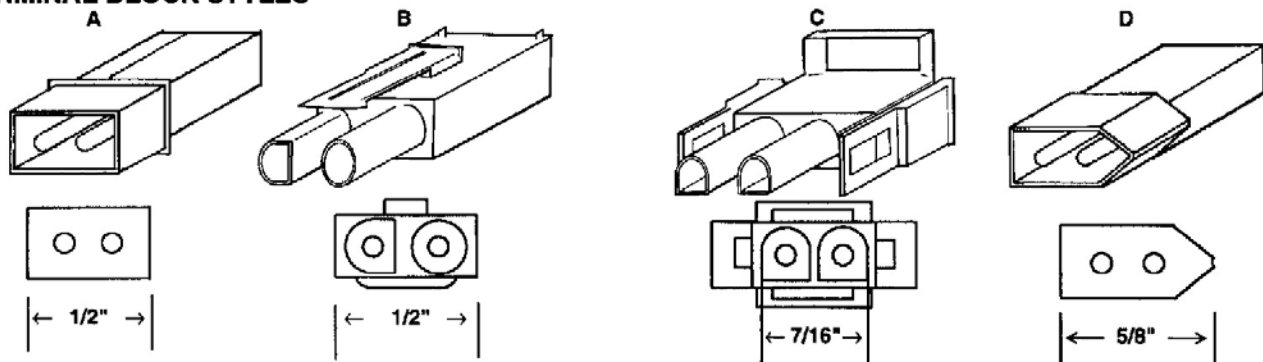

Igniters

White Rodgers™

Ignition Pilot Modules

Silicon Carbide Hot Surface Igniter

- Works with 15, 17, or 45 second HSI systems
- Lead insulation temperature rating: 200°C
- CSA Approved



767A-370



767A-372



767A-378

Part #	Model #	Lead Length	Electrical Connection
66401	767A-370	5-1/4"	Receptacle w/0.093" Male Pins
51124	767A-372	5-1/4"	Molex Side Lock Connector w/0.092" Male Pins
76390	767A-378	5-1/8"	Electrical Connector Matches Amana #20165702

Hot Surface Igniters

Series 679 Universal Hot Surface Igniter

- Includes mounting hardware



Part #	Model #	Description
75390	67900	Flat Universal Silicone Carbide, SUPCO SIG1100

Igniters

Round Furnace Igniter



SIG101



SIG1100

Part #	Model #	Description
38717	SIG101	Nordyne Style Hot Surface
52268	SIG1100	Universal Kit

Flame Sensor

- Easily clean sensor
- Prevent false starts
- Convenient key ring



Part #	Model #	Description
193770	FSC10	Flame Sensor Cleaner
193771	HYBIYL	Hybrid Jumper

Models and Specifications are Subject to Change Without Notice

Igniters

Igniters

Q3200 Glowfly™ Universal Hot Surface Igniter Kit

- Provides a robust field service replacement igniter, in gas-fired appliances with Norton/St. Gobain/CoorsTek 120VAC, silicon carbide, hot surface igniters
- Replaces over (110) OEM igniter models
- Igniter application templates enable quick bracket selection
- Robust Silicon nitride igniter construction
- Includes: cross reference instructions, (6) brackets and installation accessories



Part #	Model #	Description
62730	Q3200U1004	Glowfly™ Universal Hot Surface Igniter Kit
62731	Q3200U2002	Glowfly™ Universal Hot Surface Igniter Kit, Service Pack of (6) Kits

White Rodgers™

Igniters

HotRod™ Universal Nitride Hot Surface Igniter Upgrade Kit

- Replaces over 150 OEM, White-Rodgers and competitive HSI igniters
- For gas-fired forced-air furnaces, water heaters, and boilers
- Latest nitride igniter construction
- Includes:
 - Nitride igniter with 15-1/2" leads
 - Universal mounting bracket and screw
 - Mounting adapter bracket
 - (2) Ceramic wire nuts
 - Updated manufacturer cross-reference
 - Nitride upgrade furnace label
 - Instruction booklet
- cCSAus Approved (igniter only)



Part #	Model #	Description
50088	21D64-2	120V Nitride Universal Igniter Upgrade Kit

Nitride Hot Surface Ignitor

Part #	Model #	Description
193780	21D64-44	HotRod EX 120V Nitride Hot Surface Ignitor

OEM Style Replacement Nitride Igniter

- 2-Terminal AMP receptacles with female sockets



Part #	Model #	OEM Replacement	Female Socket Size
50108	768A-842	Amana 11111701, 768A-2, 768A-842	.093
50110	768A-844	Lennox 41K5601, 768A-4, 768A-844; Rheem 62-24134-02	.084

Pilot Burner Parts

SmartValve® Flame Rod Assembly



Part #	Model #	Description
1930	Q3400A1024	30" Igniter Flame Rod Assembly for Q3450, Q3480 Hot Surface Pilot Burner

Flame Sensors

HSI Flame Sensors

- Flame sensors for Hot Surface Ignition (HSI) systems
- Can be mounted remotely on multiple burners or adjacent to igniter on other application
- For use with spark ignition and flame sensing
- High quality alumina ceramic insulator
- High temperature kanthal flame rod material that can withstand 1800°F

Straight Flame Sensor

- Single rod
- Connection: 1/4" Female
- Probe length: 3"



Part #	Model #	Description
76223	PFS401	Replaces Fast OEM® 31380679, Mars® 67970, and White-Rogers® 760-401

Flame Sensor

- Single rod
- Connection: 1/4" Male
- Probe length: 3"



Part #	Model #	Description
76221	PFS802	Replaces ICP™ 1380687, Goodman® 0130F00010, York® 025-27773-700

Carrier® HSI Flame Sensor

- For use with Carrier® and Bryant® models: 355MAV, 345MAV, 340MAV, 350MAV, 373LAV, 58MXA, 58MVP and 58MCA



Part #	Model #	Description
76224	PFS013	Replaces Carrier® LH680013, LH33WZ514, LH33WZ516

Flame Sensor with Ceramic Insulator

- A direct replacement for Goodman



Part #	Model #	Description
183907	PFS010	Replaces Goodman D130F00010

45° HSI Flame Sensor

- For use with Carrier® LH33ZS004 igniter
- For use with Carrier® and Bryant® models: 330AAV/JAV, 333BAV/JAV, 398AAV, 58DHC/DXC/PAV/8SSC/SXC/TUA/WAV



Part #	Model #	Description
76222	PFS014	Replaces Carrier® LH680014, OH680012, LH33WZ511, LH33WZ515, 6-62442-18179-4

45° HSI Flame Sensor

- Length: 2-1/2" mounting flange to sensor tip, 1-9/16" long 90° sensor offset
- Termination: 1/4" male quick connect
- Commonly found on models: UGDG, VGDG, UGDG, VGDG, UGDG, VGDG, UGDJ, UGFD, UGLG, UGLH, UGLH, UGLJ, UGLK, UGLL, UGLN, UGLQ, UGLR, UGPH, UGPJ, UGPK, UGPL, UGPN, UGPP, UGPQ, UGPR, UGRA, UGRB, UGRJ, UGRK, UGRL, UGRM, UGSA, UGTA, UGTJ, UGVG, UGVH, UGVJ, 80LJ, 80LS, 80PJ, 80PS, 90RJ, 90RS, 90RT, 90TJ, 90TS, RGF, RGLS, RGPS, URGRM, RGRS, RGRT, RGTS, SGPG, SGPN



Part #	Model #	Description
76225	PFS301	Replaces Rheem® 62-23543-01, for Various Models

Models and Specifications are Subject to Change Without Notice

Pilot Burners

Pilot Burners

Q314 Pilot Burner

- Insert orifice-type, for main burner ignition
- Used with Q309, Q340, Q390 thermocouples or Q313 thermopiles
- Variety of mounting brackets available
- Single tip style
- Variety of tip directions to provide desired flame pattern
- Interchangeable, color-coded orifice and inlet fittings can be ordered to convert between natural and liquid propane gas
- Non-primary aeration
- CSA Certified



Part #	Model #	Bracket	Orifices	Tip
11318	Q314A4586	B Bracket*	BBR-10, BCR-18 Orifices	Single (F) Front Tip
6581	Q314A6094	B Bracket*	BBR-10, BCR-18 Orifices	Single (L) Left Tip
6662	Q314A6102	B Bracket*	BBR-10, BCR-18 Orifices	Single (K) Right Tip

* Special mounting bracket with screws to convert "B" bracket to "A" bracket

Q314 Universal Pilot Burner

- Insert orifice-type, for main burner ignition
- Used with Q309, Q340, Q390 thermocouples or Q313 thermopiles
- Variety of mounting brackets available
- Single tip style
- Variety of tip directions to provide desired flame pattern
- Interchangeable, color-coded orifice and inlet fittings can be ordered to convert between natural and liquid propane gas
- Non-primary aeration
- CSA Certified



Part #	Model #	Description
135807	Q314U1001	Universal U Bracket, BCR-18 BBR-10, CAR-12, CAR-13, BBR-8 Orifices, Single Adjustable Left, Right, and Center Tip, Standard and Low BTU Hoods

Q345 Pilot Burner

- Non-primary aerated combination pilot burner and igniter
- Used with S86, S860, S8610 or S8670 in intermittent pilot systems
- Single tip style
- Natural and liquid propane gas orifices available
- Includes: pilot burner with bracket, ceramic-insulated Kanthal flame rod/spark igniter and ground strap
- CSA Certified



Part #	Model #	Bracket	Orifices	Tip
3472	Q345A1305	B Bracket*	BCR-18 Orifice	Single (F) Front Tip
3549	Q345A1313	B Bracket*	BCR-18 Orifice	Single (L) Left Tip
3611	Q345A1321	B Bracket*	BCR-18 Orifice	Single (K) Right Tip

* Special mounting bracket with screws to convert "B" bracket to "A" bracket

Pilot Burners

Q3450 SmartValve® System Pilot Burner

- SmartValve® System pilot burners provide pilot flame ignition and sensing for SV9500/SV9600 systems
- Used with SV9500/SV9600 SmartValve® system
- Replaceable igniter-flame rod assembly (Q3400A)
- Integral keyed plug provides quick, convenient connection of igniter and sensor to SV9500/SV9600
- Front or 20° right, left flame pattern
- Natural and liquid propane gas orifices available
- Variety of target styles available
- Variety of mounting brackets available
- Use for natural gas and liquid propane applications
- Includes: replaceable igniter-flame rod, bracket, pilot target, ground electrode, orifice assembly, compression fitting and spring Clip
- CSA Certified



Part #	Model #	Bracket	Orifices	Tip
68849	Q3450C1185	C Bracket	BCR-18, BCR-20, BCR-22 Orifices	Single (L) 20° Left Tip



Tubing

Aluminum Tubing Coil Kit

- 0.035" Wall thickness
- ASTM B491 1435 Alloy
- Temperature range: -250° to 250°F
- Includes: 5' Aluminum coil, (1) Brass breakaway fitting, (1) Brass sleeve and (1) Brass compression nut



Part #	Model #	Size
14778	MA-AT18-5	1/8" x 5'
14804	MA-AT14-5	1/4" x 5'

Fan & Limit Controls

Thermodisc Thermostats

Gas Furnace Limit Control & Plenum Thermostat

- Switching: SPST
- 3.12" Insertion unless noted



Part #	Model #	Open	Close	Insertion Length
183908	SHL501	170F	130°F	3.12"
183909	SHL502	180F	150°F	3.12"
183910	SHL503	190F	150°F	3.12"
183911	SHL504	240F	200°F	3.12"
69358	SHL505*	140°	110°F	1.87"
69357	SHL507	140°F	110°F	3.12"
69351	SHL508	150°F	130°F	3.12"
69356	SHL513**	170°F	130°F	3.12"
69352	SHL514	180°F	140°F	3.12"
69350	SHL515*	200°F	160°F	3.12"
69349	SHL516	210°F	170°F	3.12"
69348	SHL517**	220°F	180°F	3.12"
69347	SHL518	250°F	210°F	3.12"

*1.87" Insertion
** Includes gasket

Manual Rollout Limit Thermostat

- SPST, Manual reset
- Vertical 1/4" terminals



Part #	Model #	Cut Out
69340	SRL130	130°F
69341	SRL135	135°F
69342	SRL220	220°F
69343	SRL240	240°F
69345	SRL250	250°F
69344	SRL300	300°F
69346	SRL350	350°F

CAMSTAT® Controls

Fan & Limit Control with Time Delay

- Adjustable limit temperature
- Pilot duty, 40VA @ 30VAC and 120VAC
- SPST Switch
- Fan off: 90°F to 120°F
- Limit: 150°F to 250°F
- Differential: 30°F



Part #	Model #	Description
13392	FALTS-57C-05T-120-A	7" Insertion

Limit Control

- SPDT Switch
- Fan off: 120° to 250°F
- Differential: 30°F fixed



Part #	Model #	Description
13474	L59-3B-A	3" Insertion
13485	L59-7B-A	7" Insertion

Fan & Limit Controls

Industrial Pressure & Limit Controls

L4079 Pressuretrol® Limit Controller

- Pressure-actuated high limit switch
- Stainless steel diaphragm for use with steam, air, non-combustible gases and fluids non-corrosive to stainless steel
- Micro Switch™ snap-acting switches open automatically on pressure rise; must be manually reset
- Mount using 1/4" NPT female fitting on diaphragm assembly or surface-mount through back of case
- Maximum ambient temperature: 150°F (66°C)
- UL Listed



Part #	Model #	Operating Pressure Range	Max Sustained Operating Pressure	Switch Operation	Switching Action & Comments
42475	L4079B1033	2 to 15 psi	25 psi	Manual Reset	SPST Break on Pressure Rise

Fan Centers

R8285 Control Center

- Provides low voltage control of line voltage fan motors and auxiliary circuits in heating, cooling or heat-cooling circuits
- Transformer powers low voltage control systems and provides overload protection
- Low voltage terminal board provides convenient connections for thermostat and heating/cooling equipment wiring
- Transformer provides overload protection
- Mounts on standard 4" x 4" junction box
- Relay is easily replaced without disturbing wiring
- 3/4 Horsepower
- Frequency: 60Hz
- Tradeline
- UL Listed
- CSA Certified



Control Fan Center for "Total Comfort" Applications with F50 Electronic Air Cleaner, Humidifier & Blower Motor

Part #	Model #	Description
46305	R8285B1053	120/208/240VAC, DPDT Switching, 40VA Transformer, Includes R8222D Plug-In Relay

Fan & Limit Controls

Electronic Fan Timers

ST9120U Universal Integrated Gas Combustion Blower Control

- Integrates control of all combustion blower and circulating fan operations in gas warm-air appliance
- Replaces 40+ existing Honeywell electronic fan timers
- Instruction sheet supplies full cross reference and wiring guide
- Interface harnesses for simple conversion
- Replaceable fuse
- DIP Switch selectable heat and cool delay on and off times
- LED Lights for easy diagnostics
- Electronic air cleaner and humidifier terminal connections
- Continuous low speed indoor air circulation
- Electrical ratings: 18 to 30VAC
- Includes: instructions and special wire harnesses
- UL Listed
- CSA Certified



Part #	Model #	Heat Fan On Delay Field Adjustable/Set	Heat Fan Off Delay Field Adjustable/Set	Cool Fan On Delay Field Adjustable/Set	Cool Fan Off Delay Field Adjustable/Set
60477	ST9120U1011	30 or 60 Sec/30 Sec	60,120,150 or 180 Sec/120 Sec	4 or 30 Sec/4 Sec	30 or 60 Sec/30 Sec

Fan & Limit Controls

L4064B Combination Fan & Limit Furnace Control

- For control of high limit and fan motors in forced air heating systems
- (3) Wiring terminal options: female receptacles for 1/4" male flange connectors, push-in receptacles for stripped wire and auxiliary screw terminals
- Field adjustable fan and high limit settings
- Manual fan switch that overrides the fan control to keep the fan running continuously
- High Limit Stop: 200°F
- Plenum temperature 125° fan on and 100° fan off stops
- Tradeline
- Includes: mounting adapters, strain relief bushings and jumper
- UL Listed
- CSA Certified



Part #	Model #	Description
16567	L4064B2210	11-1/2" Insertion, Surface or Universal Mounting Bracket Available (50077438-001/U), Tradeline
16752	L4064B2228	5" Insertion, Surface or Universal Mounting Bracket Available (50077438-001/U)
16843	L4064B2236	8" Insertion, Surface or Universal Mounting Bracket Available (50077438-001/U)"

Fan & Limit Controls

Adjustable Snap Disc Controls

ST9120U Universal Integrated Gas Combustion Blower Control

- Adjustable snap disc thermostat allows setting temperature set point to match specific needs
- 1/4" Quick contact terminals standard
- Includes: thermostat and tab to screw terminals



Adjustable Snap Disc Fan Control

Part #	Model #	Temp Range	Differential	Switching	Function
13896	3F05-1	90° - 130°F	20°F	SPST	Close on Rise
13907	3F05-2	140° - 180°F	20°F	SPST	Close on Rise

Adjustable Snap Disc Fan Control



Part #	Model #	Temp Range	Differential	Switching	Function
10832	3L05-1	135° - 175°F	40°F	SPST	Open on Rise
10842	3L05-2	175° - 215°F	40°F	SPST	Open on Rise
10850	3L05-3	210° - 250°F	40°F	SPST	Open on Rise

Fan Control Centers

- Transformer and relay combination
- Line voltage connections pre-wired
- Color-coded pre-stripped leads
- Low voltage connections on terminal board
- Mounts on 4" x 4" junction box
- UL File fan center E73641



Part #	Model #	Primary Voltage	Primary Hz	Secondary Voltage	Secondary VA	Relay
4906	90-112	120V	60	24V	40	DPDT
4919	90-113	120V	60	24V	40	SPDT



We maintain well-stocked and conveniently located warehouses. Please visit us at the branch nearest you.

Pressure Switches

Dual Purpose Air Switches

- Responds to positive, negative, or differential air pressure
- Design eliminates "fluttering" or malfunction due to shock or vibration normally encountered with sail switches
- Wide operating range
- Can be mounted in any position except upside down
- Enclosed diaphragm
- Ambient temperature: -40° to 180°F
- Maximum pressure: 1/2 psi
- Includes: (1) 1/4" OD x 12" Piece flexible tubing, nuts and ferrules
- UL Listed
- CSA Certified



Part #	Model #	Adj Operating Range	Switch Action	--Resistive (Non-Inductive)--		
				120VAC	240VAC	277VAC
3294	770-1	0.05 - 12.0wc	SPDT	15.0A	15.0A	15.0A



Air Pressure Switches

- Mounts with the diaphragm in vertical plane
- Designed for residential furnace and light commercial after market application; duct heater, oven and other HVAC or energy management applications
- UL Listed
- CSA Certified



Field Adjustable Air Pressure Switch Kit

Part #	Model #	Range	Operating Temp Range	Contact Arrangement	Terminal Connection
64086	PS495	0.20"wc to 1.0"wc	-40° - 190°F	SPDT	(3) Male 90° Quick Connect
64209	PS498	1.0"wc to 4.0"wc	-40° - 190°F	SPDT	(3) Male 90° Quick Connect



Neoprene Air Tubing

Neoprene Air Tubing

- For use on furnaces, boilers, draft inducer motors, air duct pressure switches and rooftop pressure differential switches
- Pressure rating: -20 to 20"wc
- Temperature rating: 0° to 160°F



Part #	Model #	Size
64550	MA-NAT316-5	3/16" ID x 5'

Inducer Venter Motors

Inducer Venter Motors



Part #	Description	Replaces
68771	PACKARD 48331 Inducer Complete	Goodman B4833000S
68765	PACKARD 65569 Inducer Motor Only	Carrier HC21ZE115
68808	PACKARD 65570 Inducer Motor Only	Carrier HC24HE230
68768	PACKARD 66005 Inducer Complete	Goodman # B1859005 & B1859005S
69394	PACKARD 66781 Inducer Complete	Rheem 70-10187-81
144329	PACKARD 66787 Inducer Complete	Trane BLW00473
69396	PACKARD 66833 Inducer Complete	ICP 1010238P, ICP 1013833,
84035	PACKARD 82052 Inducer Complete	Dunkirk 433-00-510
68776	PACKARD 82672 Inducer Complete	ICP 1006168
68772	PACKARD A079 Inducer Complete	York 026-32067-000 / 026-32067-700, Rheem 4MH15 / 70-21496-00 / 70-21496-03 / 70-21496-06 / 70-21504-03 / 70-21504-04 / 7021-10262, / 7021-5615 /7021-6804 / 7021-7481 / 74-70-21496-03 / 74-70-21504-03, Goodman B1859000, Trane MOT-3482, Nordyne RH702149603 / RH702149683
69409	PACKARD A090 Inducer Complete	ICP 1005425 / 1006168 / 1006168P, Rheem 21-50401-04 / 21-50403-04 / 21496-03-01 / 51-21496-01 / 70-21496-01 / 7021-10268 / 7021-49601 / 7021-5239 / 7062-4699 / 74-70-21496-01-06 / JA1M102
77153	PACKARD A150 Inducer Complete	Trane BLW00451
69435	PACKARD A170 Inducer Complete	ICP 1010312 / 1010526 / 1010527 / 1010928 / 1011095 / 1011097 / 1011409 / 1164280 / 1164282
69437	PACKARD A172 Inducer Complete	ICP 1010975
68779	PACKARD A173 Inducer Complete	ICP 1011350
77154	PACKARD A194 Inducer Complete	ICP BLW-572
75923	PACKARD A195 Inducer Complete	Trane BLW00864
77155	PACKARD A197 Inducer Complete	Trane BLW00879
69444	PACKARD A200 Inducer Complete	Lennox 31L5501
69446	PACKARD A202 Inducer Complete	Lennox 45037-001 / 45037-1P / 46087-001 / 7021-10602, Armstrong 45037-1P/ 46087-001 / 58W01, Ducane R45037-001
69609	PACKARD A65569BW Inducer Wheel Only	Carrier LA11AA005
193387	PACKARD 66756 Inducer Complete	Carrier 1179081
193388	PACKARD 66757 Inducer Complete	Carrier 320725-757
193389	PACKARD 66758 Inducer Complete	Carrier 320725-758

Relays

Relays

R4225/R8225 General-Purpose Fan Relay

- Provide general-purpose and heavy-duty switching for refrigeration and air conditioning equipment, appliances, vending machines and similar applications
- Molded terminal numbers and circuit diagram on top of relay provide easy identification for wiring and checking system operation
- Open coil assures cooler operation
- Laminated magnet construction for higher efficiency
- Base designed for easy replacement of competitive relays
- Double quick-connect coil terminals
- Plug compatible with Stevco 90-340 and Mars 90340
- Frequency: 60Hz
- Temperature rating: 115°F
- Tradeline
- UL Listed, CSA certified



Part #	Model #	Description
30690	R8225A1017	24VAC SPDT General Purpose Fan Relay

R8330 Electric Furnace Sequencer

- Sequencing of fan control with up to (3) safety operations
- Isolated fan switch has positive interlock to assure fan is on when the element is on, and fan is off when the element is off
- Replaces many of the OEM and competitive models
- Auxiliary switch controls a second R8330 in application with more than (3) elements
- 10-Second minimum delay between stages (makes sequence and break sequence)
- Timings meet EEI-NEMA and ARI 280 Standards
- Tradeline
- UL Listed, CSA certified



Part #	Model #	Description
10143	R8330D1039	24VAC Electric Furnace Sequencer, Cycles On within 2-Minutes, Off within 4-Minutes

Universal Upgrade for Mechanical Compressor Contactors Emerson SureSwitch™ Relay

- Universal electronic upgrade for mechanical compressor contactors
- Replaces the function of a contactor and short-cycle timer
- 5X Contactor life
- Sealed to keep out ants and debris
- Microprocessor-controlled sealed compressor switching
- Compressor protected from brownouts and short cycling
- 5-Year limited warranty

White
Rodgers™



Part #	Model #	Line Voltage Input	Amps (FLA)	Pole
124686	49P11-843	208/240VAC 50/60Hz	40A	1 or 1.5

Relays

Fan & Blower Relays

WR/RBM Type 84 Enclosed Fan Relay

- Totally enclosed
- Used for switching single or 2-speed fan motors, solenoids, relays, resistive loads, and general purpose switching
- Mechanical life (no load): 1,000,000 operations, 60/minute
- Frequency: 50/60Hz
- Temperature range: -40° to 150°F



90-293Q

Part #	Model #	Type	Coil Voltage (50/60Hz)	DC Res	Nom Current MA	Nom VA Sealed	Inrush VA
63611	90-291Q	SPNO	24V	90	125	3	4
10521	90-293Q	SPDT	24V	90	125	3	4

Heavy-Duty WR/RBM Type 184 Enclosed Fan Relay

- Heavy-duty, general purpose, totally enclosed
- Operates in any position
- For heating, cooling, and general switching
- Mechanical life (no load): 1,000,000 operations, 120/minute
- Frequency: 50/60Hz
- Temperature range: -40° to 150°F



Part #	Model #	Type	Coil Voltage (50/60Hz)	DC Res	Nom Current MA	Nom VA Sealed	Inrush VA
7414	90-370	SPDT	24V	77	125	3	4

Switching Relays

2-Pole WR/RBM Type 91 Switching Relay

- 2-Pole double throw semi-enclosed relay
- For power or pilot duty, vending machines, appliances, fan controls, heating and air conditioning applications, and general purpose switching
- Mechanical life (no load): 1,000,000 operations, 120/minute
- Frequency: 50/60Hz
- Fits receptacles
- Temperature range: -40° to 130°F



90-340

Part #	Model #	Switching	Coil Voltage (50/60Hz)	Terminals 1-2-3	Terminals 4-5-6	DC Res	Nom Current MA
7117	90-340	2PDT	24V	Power	Power	17.5	334
7129	90-341	2PDT	115-120V	Power	Power	420	66

Thermocouples

Thermopiles

Q313 Replacement Thermopile Generator

- Contains multiple thermocouples connected in series to increase the millivoltage output
- The power generated is sufficient to operate an automatic millivolt gas control system, independent of any outside power source
- Push-in clip, split nut, and adapter assembly for easy pilot burner installation
- Spade or quick-connect terminals available for millivolt gas control connections
- Open circuit output: 600 to 705mV
- Includes push-in clip and 1/2" thermopile attaching nut
- CSA Certified



Part #	Model #	Lead Length	Connection	Voltage	Resistance
12180	Q313A1188	35"	Spade Terminals	750mV	2.89 ohms

Super Tradeline

Thermocouples

Q340 Universal 30mV Thermocouple

- Male nut connector for Pilotstat® safety control power units
- Q340A Thermocouples sense the pilot flame on gas-fired heating systems
- The pilot flame heats the tip of the thermocouple, producing a temperature differential between it and the base to generate a small amount of DC power, measured in millivolts
- Available in a variety of lead lengths
- Open circuit output: 26 to 32mV
- Includes push-in clip, split nut and adapter assembly
- CSA Certified



Part #	Model #	Lead Length	Connection	Voltage	Resistance
13936	Q340A1066	18"	11/32" 32 Male Connector Nut	30mV	.02 ohms
14008	Q340A1074	24"	11/32" 32 Male Connector Nut	30mV	.02 ohms
14103	Q340A1082	30"	11/32" 32 Male Connector Nut	30mV	.02 ohms
14176	Q340A1090	36"	11/32" 32 Male Connector Nut	30mV	.02 ohms
14373	Q340A1108	48"	11/32" 32 Male Connector Nut	30mV	.02 ohms

Thermocouples

Q390 30mV Thermocouple

- Male nut connector for Pilotstat® safety control power units
- Q390A Thermocouples sense the pilot flame on gas-fired heating systems
- The pilot flame heats the tip of the thermocouple, producing a temperature differential between it and the base to generate a small amount of DC power, measured in millivolts
- Push-in clip, split nut, and adapter assembly for easy pilot burner installation
- Available in a variety of lead lengths
- Open circuit output: 26 to 32mV
- Voltage: 30mV
- Resistance: 0.02 ohms
- Includes push-in clip, and adapter assembly
- CSA Certified



Part #	Model #	Lead Length	Connection	Includes
7	Q390A1061	36"	11/32" 32 Male Connector Nut	Adapter & Push-In Clip

White Rodgers™

Millivolt Power Generators

250/750 Millivolt Power Generator

- Provides power for 750mV self-generation control systems



Part #	Model #	Type	Lead	Connector
14328	G01A-332	750mV	36" Armored Cable	F Spade Clip/PG9 Adapter

Packard

Thermocouples

- Designed to simplify installation on automatic controls and burners
- Stainless steel head and weld at tip to provide reliable performance
- Includes adapters to fit most types of pilot burners



Part #	Model #	Size
75288	22236	36"

Transformers

Transformers

AT88 Transformer

- Powers 24VAC air conditioning circuits and other applications that do not exceed the listed ratings
- Overload protection provided
- 12" Color-coded leadwire for primary connections
- Internally fused secondary for overload protection
- Frequency: 50/60Hz
- Meets NEC Class 2 not wet, Class 3 wet and UL 1585 requirements
- Tradeline
- UL Listed, CSA certified

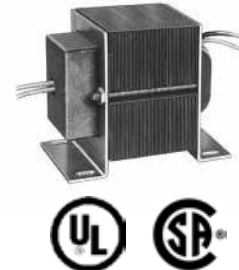

Part #	Model #	Output at 24VAC	Primary Voltage	Mount
13135	AT88A1047	75VA	480VAC	Foot

AT140/AT150A/AT175A Class 2 General Purpose Transformer

- Designed to power 24VAC circuits
- Typically used in heating/cooling control systems, they can be used in any application that doesn't exceed the load ratings.
- Fixed 1/4" male quick-connects and color-coded lead wires for primary and secondary connections
- Universal mount can be foot-mounted, plate-mounted on 2" x 2" or 4" x 4" outlet box, clamp-mounted using outlet box knockout or panel-mounted
- Frequency: 60Hz
- Meets NEC Class 2 not wet, Class 3 wet and UL 1585 requirements
- UL Listed, CSA certified



Part #	Model #	Output at 24VAC	Primary Voltage	Mount	Comments
1610	AT140A1000	40VA	120VAC	Univ Mnt (Plate, Foot & K/O)	Metal End Bells
1763	AT140A1018	40VA	120/208/240VAC	Univ Mnt (Plate, Foot & K/O)	Metal End Bells
13795	AT150A1007	50VA	120/208/240VAC	Univ Mnt (Plate, Foot & K/O)	Metal End Bells
6790	AT175A1008	75VA*	120/208/240VAC	Univ Mnt (Plate, Foot & K/O)	Metal End Bells

* NEMA Type E enclosure

Transformers

AT175F Class 2 Circuit Breaker Transformer

- Designed to power 24VAC circuits
- Color-coded lead wires for primary connections and screw terminals for secondary connections
- Fixed 1/4" male quick-connects or color-coded lead wires for primary and secondary connections are standard
- Includes: circuit breaker manual reset button, 1/2" 14 NPSM conduit connector with lock nut for mounting and feet for surface mount
- Tradeline
- Meets NEC Class 2 not wet, Class 3 wet and UL 1585 requirements
- UL Listed, CSA certified



Part #	Model #	Output at 24VAC	Primary Voltage	Mount	Comments
30717	AT175F1023	75VA	120/208/240VAC	Conduit & Foot Mount	Metal Bell Ends

White Rodgers™

Class 2 Transformers

Class 2 24 Volt Energy Limiting Secondary Transformer

- For industrial heating and air conditioning control applications
- Foot-mount (open construction)
- Color-coded primary leads:
 - Primary side - common black (common with respect to transformer winding, not external circuit), 120V white, 208V red, 240V orange
 - Secondary side - common blue, 24V yellow



Part #	Model #	VA	Hertz	Primary	Connections	Secondary
1574	90-T40F3	40	60Hz	120/208/240V	Leads	24V
1112	90-T50F3	50	60Hz	120/208/240V	Leads	24V

Air Conditioner Controls

Head Pressure Controls

ICM326H Single-Phase Head Pressure Control

- Integral Heat Pump Bypass Circuitry Allows Electronic Bypass of Speed Control
- Built-In Transformer Eliminates Cost, Reduces Installation Time and Simplifies Wiring
- Helps Prevent Evaporator Freeze-Ups, Low Pressure Cut Outs and Liquid-Slugged Compressors in Low Ambient Conditions
- Hard Start, Low Temperature Cutoff, High Temperature Bypass
- Ideal for Line Voltage Air Conditioning and Refrigeration
- Made in USA



Part #	Model #	Description
40527	ICM326HN	120 or 208/240VAC, Clamshell

Line Voltage/Phase Monitors

ICM401 3-Phase Line Voltage Monitor

- Low cost 3-phase protection for single side
- Monitors for phase reversal, phase loss, unbalance % as a function of input voltage
- Bright LED indicators for on and fault
- Epoxy encapsulated for moisture protection
- Input: Control: 18 to 30VAC, Voltage: 190 to 600VAC and Frequency: 50/60Hz
- Output: SPDT Relay and N.O.: 10A



Part #	Model #	Description
53839	ICM401	190- 600VAC

ICM517 Single-Phase Surge Protector

- Single-phase protection against: Lightning power surges and voltage surges from air conditioners, generators, motors
- Weatherproof housing
- Service voltage: 120/240V, single-phase
- Installation point: electrical panel and service disconnect
- (4) AC Protection modes: line-line, line-neutral, line-ground, neutral-ground
- UL Listed
- Limited lifetime protection warranty



Part #	Model #	Description
144431	ICM517	100,000A Max Current, 1,020J

MARS Surge Protective Device

- Type: HVAC/R
- Connection Type: 18" 10 AWG Leads
- Mounting: Outdoor 1/2" x 20 Threaded Nipple
- Voltage Rating: 120/240 VAC
- Max. Amps: 20000
- MOV Type: Thermally Protected
- Warranty: 7,500 Connected Equipment
- Standards: UL 1449 4th Edition



Part #	Model #	Description
188064	83905	Surge Protector

Contactors/Heat Sequencers

Definite Purpose Contactors

- Meet specifications for devices up to 600VAC
- Coils have Class B insulation
- Includes lug, spade terminals and covers
- UL Listed
- CSA Certified



1-Pole



2-Pole



3-Pole

Part #	Model #	Poles	Inductive Amps	Rotor Amps	Resistive Amps	Coil AC Volts
17091	C130A	1	30A	150/125/100A	40A	24V
11752	C230A	2	30A	180/150/120A	40A	24V
12498	C240A	2	40A	240/200/160A	50A	24V
16018	C240C	2	40A	240/200/160A	50A	208-240V
6540	C330A	3	30A	180/150/120A	40A	24V
7399	C340A	3	40A	240/200/160A	50A	24V
2060	C340C	3	40A	240/200/160A	50A	208-240V
44493	C350A	3	50A	300/250/200A	65A	24V

Heat Sequencers

- Contact ratings: up to 25A @ 120V or 240V and 12.5A @ 480V
- Full-load rated auxiliary contacts
- Standard operating ambient: -50° to 165°F (-45.5° to 73.8°C)
- Shock and vibration resistant
- Solid state
- Quick-connect terminals
- Mounts in any position
- UL Listed, CSA certified



SPDT 1& 3 N.O. Heat Sequencer

Part #	Model #	Type	Control Voltage	Delay On	Delay Off	Replaces
134591	HS33247	SPDT 1 & 3 NO	24V	1 - 24 Sec	15 - 75 Sec	Goodman B1370738, Klixon COM-21

SPST Heat Sequencer

- 125VA
- 6,000W
- Motor rating: 10A
- Pitch: 21°
- Rotation: CW



HS24A341



HS24A342

Part #	Model #	Timings	Switches	Delay On	Delay Off
134584	HS24A341	1	1	1 - 20 Sec	40 - 110 Sec
134586	HS24A342	1	1	30 - 90 Sec	1 - 30 Sec

Models and Specifications are Subject to Change Without Notice

Heat Sequencers

2DPDT-SPST Heat Sequencer

- 125VA
- 6,000W
- Motor rating: 10A
- Pitch: 21°
- Rotation: CW



Part #	Model #	Timings	Switches	Delay On	Delay Off
134585	HS24A3414	4	5	1 - 160 Sec	1 - 160 Sec

DPDT Heat Sequencer

- 125VA
- 6,000W
- Motor rating: 10A



HS24A343

Part #	Model #	Timings	Switches	Delay On	Delay Off
134587	HS24A343	1	2	1 - 20 Sec	40 - 110 Sec
134588	HS24A344	1	2	30 - 90 Sec	1 - 30 Sec
134589	HS24A345	2	3	1 - 110 Sec	1 - 110 Sec

2-DPDT Heat Sequencer

- 125VA
- 6,000W
- Motor rating: 10A



Part #	Model #	Timings	Switches	Delay On	Delay Off
134590	HS24A346	2	4	1 - 110 Sec	1 - 110 Sec

Filter-Driers

Filter-Driers

DRYMASTER® Liquid Line Filter-Drier (Sweat)

- Maximum working temperature: 160°F/70°C
- UL/cUL listed
- Solid core design
- Compatible with all existing and new refrigerants and oils
- High pressure shell and connections
- 100% copper connection for solder models



Part #	Model #	Size
5541	FIL052S	1/4"
8507	FIL083S	3/8"
16095	FIL163S	3/8"
16203	FIL164S	1/2"
16299	FIL165S	5/8"

DRYMASTER® Suction Line Filter-Drier (Sweat)

- Maximum working temperature: 160°F/70°C
- UL/cUL listed
- High retention filter for removal of particulate as small as 25 microns
- Dual access fitting for precise pressure drop measurements



Part #	Model #	Size
10434	FIL305S	5/8"
10519	FIL306S	3/4"
10599	FIL307S	7/8"
10788	FIL309S	1-1/8"

DRYMASTER® Suction Line Filter-Drier Solder Connection (Short Lay-In)

Part #	Model #	Size
16410	FIL166S	3/4"
16495	FIL167S	7/8"

DRYMASTER® High Capacity Heat Pump Filter-Drier (Sweat)

- Design Pressure (DP)/Maximum abnormal pressure (MAP): 700 psig
- Maximum working temperature: 160°F/70°C
- High retention filter for removal of particulate as small as 25 microns
- UL/cUL listed



Part #	Model #	Size
48412	FIL083SBF	3/8"
48413	FIL163SBF	3/8"

Sight Glasses/Moisture Indicator (SAE Flare)

- Coil sold separately
- Hermetically sealed

Part #	Model #	Size
37085	VIRKSG-3S	3/8" Male

Capacitors

Packard Capacitors

- 83% Longer operational life than standard motor run capacitors
- Tested to 60,000 hours
- Contains metallic polypropylene film technology for self-restoration in the event of a breakdown
- Sophisticated UL-approved pressure sensitive interrupter to remove the capacitor from circuit at end of life
- Patented, environmentally-friendly oil prevents corrosion and aids in optimum heat transfer

TITAN PRO®



TITAN PRO Single Capacitor, 370VAC

Part #	Model #	Description
5153	CAP04-370	4 MFD 370VAC Capacitor (Oval)
4597	CAP05-370	5 MFD 370VAC Capacitor (Oval)
2158	CAP07.5-370	7.5 MFD 370VAC Capacitor (Oval)
2095	CAP10-370	10 MFD 370VAC Capacitor (Oval)
8319	CAP12.5-370	12.5 MFD 370VAC Capacitor (Oval)
18589	CAP15-370	15 MFD 370VAC Capacitor (Oval)
15908	CAP20-370	20 MFD 370VAC Capacitor (Oval)
13151	CAP25-370	25 MFD 370VAC Capacitor (Oval)
8059	CAP35-370	35 MFD 370VAC Capacitor (Oval)
5462	CAP40-370	40 MFD 370VAC Capacitor (Oval)
2829	CAP45-370	45 MFD 370VAC Capacitor (Oval)
83374	CAP45-370	45 MFD 370VAC Capacitor (Round)

TITAN PRO Single Capacitor, 440VAC

Part #	Model #	Description
5304	CAP05-440	5 MFD 440VAC Capacitor (Oval)
27097	CAP07.5-440	7.5MFD 440VAC Capacitor (Oval)
2697	CAP10-440	10 MFD 440VAC Capacitor (Oval)
13811	CAP25-440	25 MFD 440VAC Capacitor (Oval)
11257	CAP30-440	30 MFD 440VAC Capacitor (Oval)
8763	CAP35-440	35 MFD 440VAC Capacitor (Oval)
6092	CAP40-440	40 MFD 440VAC Capacitor (Oval)
17441	CAP55-440	55 MFD 440VAC Capacitor (Oval)
67543	CAP80-440	80 MFD 440VAC Capacitor (Round)

Capacitors

Packard Capacitors (cont from pg 427)

TITAN PRO®



370V

TITAN PRO Dual Capacitor, 370VAC

Part #	Model #	Description
13249	CAP25+5-370	25/5 MFD 370VAC Capacitor (Round)
736	CAP30+5-370	30/5 MFD 370VAC Capacitor (Round)
6684	CAP35+5-370	35/5 MFD 370VAC Capacitor (Round)
30733	CAP40+5-370	40/5 MFD 370VAC Capacitor (Round)
283	CAP45+5-370	45/5 MFD 370VAC Capacitor (Round)



TITAN PRO Dual Capacitor, 440VAC

Part #	Model #	Description
40860	CAP30+5-440	30/5 MFD 440VAC Capacitor (Round)
34368	CAP35+5-440	35/5 MFD 440VAC Capacitor (Round)
40858	CAP40+5-440	40/5 MFD 440VAC Capacitor (Round)
51921	CAP40+7.5-440	40/7.5 MFD 440VAC Capacitor (Round)
40861	CAP45+5-440	45/5 MFD 440VAC Capacitor (Round)
40857	CAP45+7.5-440	45/7.5 MFD 440VAC Capacitor (Round)
40859	CAP50+5-440	50/5 MFD 440VAC Capacitor (Round)
67544	CAP50+7.5-440	50/7.5MFD 440VAC Capacitor (Round)
13002	CAP55+5-440	55/5 MFD 440VAC Capacitor (Oval)
40856	CAP55+5-440	55/5 MFD 440VAC Capacitor (Round)
67542	CAP60+5-440	60/5 MFD 440VAC Capacitor (Round)
182358	CAP80+5-440	80/5 MFD 440VAC Capacitor (Round)

Direct Drive Blower Motors

Evergreen ECM Blower Motors

5.5" Dia Genteq Evergreen® IM Direct Drive Blower ECM Motor

- MARS® Series 036
- Genteq Evergreen Motors
- Ideal for truck stock
- Multi-volt 115/230VAC and reversible rotation
- Applications:
 - Direct drive, 115VAC or 230VAC motor systems
 - Clock-wise (CW) or counter clock-wise (CCW) rotation
 - Residential split and packaged systems
 - Air conditioning or heat pump systems
 - Natural gas, propane and oil heat furnaces
 - Dual fuel systems
 - Hot water coil and Geothermal air handlers
- Integrated with HVAC system controls/operation
- 4-Speed selections for heating and cooling
- Optimized constant fan speed
- 2-Year warranty



Part #	Model #	Model# 5SME39	HP	Volts	Amps	RPM/ Speed	Rot	Dimensions Shaft
57875	06005	HXL110	1/5, 1/4, 1/3, 1/2 hp	115/208-230V	4.0A	1,075/4	Rev	1/2" x 5"
57876	06010	SXL111	3/4, 1 hp	115/208-230V	7.6A	1,075/4	Rev	1/2" x 5"

Electronically Commutated Direct Drive Motors

- High efficiency ECM: Up to 80% efficient
- Replaces either PSC or X13 model of equivalent HP
- Dual voltage design: Replace 115 or 230V with one motor
- 4 motors replaces 8 motors
- Wiring harness and simple installation guide included
- Rotation Sensing Technology
- Automatically selects rotation upon first start up
- 45" wiring harness



Part #	Model #	HP	Volts	RPM/ Speed	Amps	Hertz	Motor Type	Dimensions Shaft	Length Less Shaft	Cord Length
46013	197700	1/3	115/230	1075	5.0/3.0	60/50	ECM	1/2" x 5"	6-3/8"	45"
46012	197701	1/2	115/230	1075	6.7/4.0	60/50	ECM	1/2" x 5"	6-3/8"	45"
46034	197702	3/4	115/230	1075	8.2/4.9	60/50	ECM	1/2" x 5"	7-5/8"	45"
46001	197703	1	115/230	1075	11.0/6.7	60/50	ECM	1/2" x 5"	7-5/8"	45"

Direct Drive Blower Motors

Single-Phase Direct Drive Blower Motors

5.5" Dia GE PSC OAO Standard Efficiency Commercial Direct Drive Furnace Blower Motor

- GENTEQ Commercial motors by Regal-Beloit
- Continuous duty, air over
- Overload protection
- Reversible
- Class B insulation
- All angle sleeve bearings
- Single-phase, 50/60Hz
- 1/2" Extended thru bolts
- 2-1/4" Resilient rings plus (4) split rings
- 4" Long, 1/2" Shaft diameter
- 26" Leads
- 3-Speed: approximately 150 rpm differential between speeds depending on fan load



Part #	Model #	GE# 5KCP39	HP	Volts	Amps	RPM/ Speed	Rot	Dimensions Shaft x Body	Cap Req'd	Base #
5862	03583	FGN651T*	1/4 hp	115V	4.2A	1,075/3	Rev	4.0" x 4.89"	5/370V	08055
6971	03584	FGN652T*	1/4 hp	208-230V	2.0A	1,075/3	Rev	4.0" x 4.89"	5/370V	08055
1070	03585	JGN653T*	1/3 hp	115V	6.2A	1,075/3	Rev	4.0" x 5.14"	5/370V	08056
2023	03586	JGN654T*	1/3 hp	208-230V	2.9A	1,075/3	Rev	4.0" x 5.14"	5/370V	08056
14829	03587	PGN655T*	1/2 hp	115V	9.0A	1,075/3	Rev	4.0" x 6.14"	5/370V	08060
15971	03588	NGN656T*	1/2 hp	208-230V	4.3A	1,075/3	Rev	4.0" x 5.89"	5/370V	N/A
11586	03589	PGN657T*	3/4 hp	115V	10.3A	1,075/3	Rev	4.0" x 6.14"	15/370V	08060

*60Hz only

SOS™ 5-1/2" Multi-Horsepower Direct Drive Motors

Reversible 6-Pole Multi HP Direct Drive

- 1,075 rpm
- Ideal for truck stock
- All angle sleeve or ball bearings
- Open end shields
- Extended mounting studs
- 2-1/2" Resilient rings
- Capacitor requirement noted on motor label
- Single phase, 60Hz
- Overload protection
- Fan duty, continuous air over
- Open construction
- Class B insulation



Part #	Model #	Mars#	HP	Volts	Amps	Bearings	Dimensions Shaft Length x Dia x Body
36732	MOTDD-MULTI-115	03466	3/4, 1/2, 1/3, 1/4, 1/5	115V	8.4A	Ball	5" x 1/2" x 5-63/64"
58377	MOTDD-MULTI-230	03467	3/4, 1/2, 1/3, 1/4, 1/5	208/230V	4.2A	Ball	5" x 1/2" x 5-15/64"

Belted Fan & Blower Motors

5.5" Dia GE Split-Phase "PDQ" Open Construction Economy Belt Fan & Blower Motor

- GENTEQ Commercial motors by Regal-Beloit
- Continuous duty, open construction
- Overload protection
- Reversible
- 40°C Ambient
- Single-phase, 60Hz
- Resilient base mounted
- Slotted holes in base match 48 or 56 frame bolt patterns
- 1/2" Shaft diameter, 5/8" adapter with key included



Part #	Model #	GE# 5KH3	HP	Volts	Amps	RPM/ Speed	Bearings	SF	Dimensions Shaft x Body	NEMA Frame
17377	04708	9QN5773T	1/2 hp	115V	7.9A	1,725/1	Sleeve	1.25	1.5" x 6.91"	48/56
5810	04338	9QN9541T	3/4 hp	115V	11.4A	1725/1	Ball	1.00	1.5" x 9.80"	56

Models and Specifications are Subject to Change Without Notice

Direct Drive Blower Motors

Blower Motors

Direct Drive Furnace Blower Motor

- Installs with all standard 48 frame mounting brackets
- Standard motor casing size, shaft length, diameter and flats
- Automatic thermal overload protector
- Low power consumption
- Continuous duty, air over
- Uses 370V capacitors
- Electrically reversible
- Class B insulation
- 1,075 rpm, 3-Speed, 60Hz
- Quiet operation



Part #	Model #	HP	Volts	Cap Mfd	Shaft Length	Includes:
62888	WG840583	1/4	115V	5	1/2"	2.5" diameter Hub Rings
62889	WG840585	1/3	115V	5	1/2"	2.5" diameter Hub Rings
62634	WG840587	1/2	115V	5	1/2"	2.5" diameter Hub Rings
62890	WG840589	3/4	115V	15	1/2"	2.5" diameter Hub Rings

Multi-Horsepower Blower Motor

- Reversible plugs
- Extended thru bolts
- Installs with all 48 frame mounting brackets
- Designed for 370V capacitors



Part #	Model #	HP	Volts	RPM	Shaft Length	Includes:
73928	WG840463	1/5 - 3/4	115V	1075	1/2"	36" Leads
73929	WG840466	1/5 - 3/4	115V	1075	1/2"	36" Leads
73930	WG840467	1/5 - 3/4	208/230V	1075	1/2"	36" Leads

Direct Drive Blower Motors

SF Single-Horsepower Diameter Direct Drive Blower Motors

- Permanent split capacitor
- Multiple capacitor/speed combinations
- Continuous duty, air over
- Mounting rings, thru bolts and holes in shell
- Class B insulation
- Reversible rotation
- Automatic overload
- 48 Frame
- 60 Hertz
- Single Phase
- 5 Speed



Part #	Model #	HP	Volts	RPM	Description
175189	SFMB253SP1V	1/4	115V	1075	3 SPD Blower Motor
175190	SFMB333SP1V	1/3	115V	1075	3 SPD Blower Motor
175192	SFMB503SP1V	1/2	115V	1075	3 SPD Blower Motor
175193	SFM7553SP1V	3/4	115V	1075	3 SPD Blower Motor
197986	SFMB253SP2V	1/4	230V	1075	3 SPD Blower Motor
197987	SFMB333SP2V	1/3	230V	1075	3 SPD Blower Motor
197989	SFM7553SP2V	3/4	230V	1075	3 SPD Blower Motor

SF Multi-Horsepower Diameter Direct Drive Blower Motors

Part #	Model #	HP	Volts	RPM	Description
175197	SFMMH501VB	1/6-1/2	115V	1075	3 SPD Blower Motor
175198	SFMMH751VB	1/5-3/4	115V	1075	3 SPD Blower Motor
175200	SFMMH502VB	1/6-1/2	230V	1075	3 SPD Blower Motor

Direct Drive Blower Motors

Packard Single-Horsepower Diameter Direct Drive Blower Motors

- Permanent split capacitor
- Multiple capacitor/speed combinations
- Continuous duty, air over
- Mounting rings, thru bolts and holes in shell
- Class B insulation
- Reversible rotation
- Automatic overload
- 48 Frame
- 60 Hertz
- Single Phase
- 5 Speed



Part #	Model #	HP	Volts	RPM	Description
197878	43583	1/4	115V	1075	3 SPD Blower Motor
196802	43585	1/3	115V	1075	3 SPD Blower Motor
197879	43587	1/2	115V	1075	3 SPD Blower Motor
197880	43589	3/4	115V	1075	3 SPD Blower Motor
197883	43584	1/4	230V	1075	3 SPD Blower Motor
197885	43586	1/3	230V	1075	3 SPD Blower Motor
197886	43588	1/2	230V	1075	3 SPD Blower Motor
197887	43590	3/4	230V	1075	3 SPD Blower Motor

Packard Multi-Horsepower Diameter Direct Drive Blower Motors

Part #	Model #	HP	Volts	RPM	Description
197881	45460	1/6-1/2	115V	1075	3 SPD Blower Motor
197882	45470	1/5-3/4	115V	1075	3 SPD Blower Motor
197888	45461	1/6-1/2	230V	1075	3 SPD Blower Motor
197889	45471	1/5-3/4	230V	1075	3 SPD Blower Motor

Condenser Fan Motors

Single-Phase Condenser Fan Motors

5.5" Dia PSC Vertical Shaft Up/Down Condenser Fan Motor

- GENTEQ Commercial motors by Regal-Beloit
- Continuous duty, air over
- Automatic thermal overload protection
- Reversible
- Class B insulation
- All angle sleeve or ball bearings
- Single-phase, 60Hz
- Shell and end shield are enclosed for weather protection
- Suitable for air conditioning or heat pump applications
- Thru bolt or band mounting
- Water slinger on shaft
- Serrated end cap on shaft end only
- Full 6" shaft length with (2) full flats at 90°
- 1/2" Shaft diameter
- 6-Pole motors are standard efficiency



Part #	Model #	GE# 5KCP39	HP	Volts	Amps	RPM/ Speed	Bearings	Dimensions Shaft x Body	Cap Req'd	Leads
194	03728	FGM599S	1/4 hp	208-230V	1.8A	1,075/1	Sleeve	6.0" x 4.25"	5/370V	26"
9523	03729	LGS407S	1/3 hp	208-230V	2.3A	1,075/1	Sleeve	6.0" x 5.70"	7.5/370V	26"
294	03730	PGS618S	1/2 hp	208-230V	3.5A	1,075/1	Sleeve	6.0" x 6.50"	10/370V	26"
18058	03731	SGT309S	3/4 hp	208-230V	4.7A	1,075/1	Sleeve	6.0" x 5.75"	10/370V	26"

SOS™ 5-1/2" Multi-Horsepower Condenser Fan Motors

Reversible Multi HP Condenser Fan Motor

- Ideal for truck stock
- Ball bearings
- Thru bolt or band mounting
- Water slinger on shaft
- Air conditioning or heat pump duty
- Capacitor requirement noted on motor label
- End shield drain hoses with plugs
- Single phase, 60Hz
- Overload protection
- Fan duty, continuous air over
- Totally enclosed, non-ventilated
- Class B insulation



Part #	GE #	HP	RPM/Poles	Volts	Amps	Dimensions Shaft Length x Dia x Body
67851	03458	1/3, 1/4, 1/5, 1/6	1,075/6	208/230V	2.8A	6-3/4" x 1/2" x 5-5/16"
27621	03459	1/3, 1/4, 1/5, 1/6, 1/8	825/8	208/230V	2.4A	6-3/4" x 1/2" x 5-5/16"
41391	3458	1/3, 1/4, 1/5, 1/6	1,075	208/230V	2.50A	6.00" x 4.73"

Cap-Can Fan Motors

5" Dia PSC Cap-Can Vertical/Shaft Down Condenser Fan & Heat Pump Motor

- MARS® Series 029
- GE Commercial motors by Regal-Beloit
- For use in residential outdoor condenser fan and heat pump units (primarily up to 3.5 tons) requiring vertical shaft down with stud or flange mounting
- Vertical shaft down mounting orientation
- Continuous duty, air over
- Automatic thermal overload protection
- CW or CCW rotation in several ratings
- Class B insulation
- 60Hz
- #8-32 Extended stud or flange mount
- Water slinger on shaft
- 1/2" Shaft diameter
- 26" Leads



Part #	Model #	GE# 5KCP29	HP	Volts	Amps	RPM/ Speed	Rot	Dimensions Shaft x Body	Cap Req'd
81544	02245	JCA325S	1/4 hp	208-230V	1.7A	1,075/1	CCWOSE	2.75" x 3.85"	7.5/370V
81545	02249	DCA329S	1/8 hp	208-230V	0.75A	1,075/1	CCWOSE	2.75" x 3.35"	5/370V

Models and Specifications are Subject to Change Without Notice

Condenser Fan Motors

Condenser Fan Motors

Condenser Fan Motor

- Installs with all standard 48 frame mounting brackets
- Permanent split capacitor
- 208/230V-60Hz
- Mount up, down or with belly band
- 39 Frame size
- Sleeve bearings
- CW/CCW Rotation (electrically reversible)
- Shaft: 1/2" diameter x 3-5/8" long, one side flat
- Automatic thermal overload
- 60°C Ambient



Part #	Model #	HP	Volts	RPM
65175	WG840728	1/4	208/230V	1,075
65176	WG840729	1/3	208/230V	1,075
65173	WG840730	1/2	208/230V	1,075

Multi-Horsepower Condenser Fan Motor

- Reversible plugs
- Extended thru bolts
- 36" Leads
- Installs with all 48 frame mounting brackets
- Designed for 370V capacitors
- 1/2" Shaft



Part #	Model #	HP	Volts	RPM
73926	WG840465	1/6 - 1/3	208/230V	1,075
80972	WG840468	1/5 - 1/2	208/230V	1,075
73927	WG840469	1/6 - 1/3	208/230V	825



Let us be your source for quality products
from leading manufacturers.

Condenser Fan Motors

SF Single-Horsepower Condenser Fan Motors

- Reversible plugs
- Extended thru bolts
- 36" Leads
- Installs with all 48 frame mounting brackets
- Designed for 370V capacitors
- 1/2" Shaft



Part #	Model #	HP	Volts	RPM	Description
175194	SFMC251SP2V	1/4	208/230V	1,075	1 SPD Fan Motor
175195	SFMC331SP2V	1/3	208/230V	1,075	1 SPD Fan Motor
175196	SFMC501SP2V	1/2	208/230V	1,075	1 SPD Fan Motor

SF Multi-Horsepower Condenser Fan Motors

Part #	Model #	HP	Volts	RPM	Description
175199	SFMMH332V	1/6-1/3	208/230V	1,075	1 SPD Fan Motor
175201	SFMMH332V	1/6-1/3	208/230V	825	1 SPD Fan Motor

Packard Single-Horsepower Condenser Fan Motors

- Reversible plugs
- Extended thru bolts
- 36" Leads
- Installs with all 48 frame mounting brackets
- Designed for 370V capacitors
- 1/2" Shaft



Part #	Model #	HP	Volts	RPM	Description
164514	43732	1/4	208/230V	1,075	1 SPD Fan Motor
197891	43733	1/3	208/230V	1,075	1 SPD Fan Motor
197875	43734	1/2	208/230V	1,075	1 SPD Fan Motor
197876	43735	3/4	208/230V	1,075	1 SPD Fan Motor
197877	45458B	1/3-1/6	208/230V	1,075	1 SPD Fan Motor

Packard Multi-Horsepower Condenser Fan Motors

Part #	Model #	HP	Volts	RPM	Description
197877	45458B	1/6-1/3	208/230V	1,075	1 SPD Fan Motor

Motor Parts / V-Belts

Motor Brackets

Motor Mounting Bracket

- For use with direct drive blower motors
- Includes grommets and eyelets



Part #	Model #	Size	Type
84126	MA-FM554A	5-5/8"	Torsion

Motor Brackets

Fas Mount Bracket Kit

- For direct drive blower motors using flexible bracket mounting arrangement
- Bolt circle 9" and 10.18"
- Includes grommets & eyelets



Part #	Model #	Description
46336	FASFM55	For 5.5" Motors

Motor Accessories

Motor Mounting Bracket Kit

- Includes:
 - Steel bracket with (3) welded legs
 - (3) Steel sleeves
 - (3) Sets of rubber grommets



Part #	Model #	Diameter	Frame
86599	A60048	5-5/8"	48

QwikLug™ Compressor Terminal Repair Kits

- Replaces damaged or corroded spade terminals
- Fits all standard compressor terminals
- Tightens from the front with a screwdriver



Part #	Model #	Description
34732	QT2810	10 AWG, 3/Pk, 2' Leads with Nut

Series 941 V-Belts

FHP V-Belt

- For solving problems of minimum space, small pulley diameters, large ratios and fractional horsepower requirements
- For air conditioning, refrigeration and appliance equipment



Part #	Model #	Model #	Length
4141	94162	4L230	23"
4222	74024	4L240	24"
4320	94164	4L250	25"
4514	74027	4L270	27"
4885	94170	4L310	31"
5198	94173	4L340	34"
5303	94174	4L350	35"
5412	94175	4L360	36"
5501	94176	4L370	37"
5596	94177	4L380	38"
5682	94178	4L390	39"
5763	94179	4L400	40"
5849	94180	4L410	41"
5945	94181	4L420	42"
6035	94182	4L430	43"
6126	94183	4L440	44"
6208	94184	4L450	45"
6289	94185	4L460	46"
6391	94186	4L470	47"
6497	94187	4L480	48"
6597	94188	4L490	49"
6692	94189	4L500	50"
6802	94190	4L510	51"
6898	94191	4L520	52"
7008	94192	4L530	53"

Hard Starts / Time Relays

Hard Starts

- 2-Wide hard start kit
- 90 - 277VAC
- HS5 - HS6 Time delay
- HS8 - Electronic potential relay



Part #	Model #	Compressor Size	Compressor Rating BTUH	Use With:
4279	HS5	1/2 thru 5 hp	4,000 thru 60,000	1.5 to 3 Tons
4284	HS6	1/2 thru 5 hp	4,000 thru 120,000	3.5 to 5 Tons
4304	HS8	1/2 thru 10 hp	4,000 thru 120,000	1.5 to 5 Tons

Three-Wire Mechanical Potential Relay Hard Start

- Combines a potential relay and start capacitor
- Applications:
 - All 208/240V single-phase compressors
 - Scroll compressors
 - Reciprocating compressors
 - Can be used with single or dual run capacitors
- Voltage sensing
- Instant re-start; 25A Relay contacts
- Quick installation with EZ Snap Bracket
- 2-Year warranty

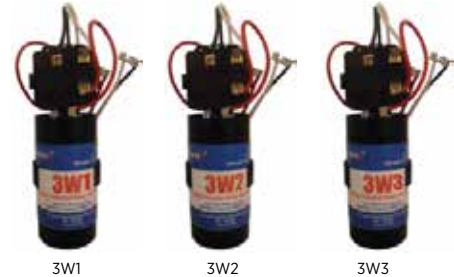

Part #	Model #	Compressor Size	Use With:
73876	3W1	1 - 3 hp, 88 - 108 mfd, Replaces CSRU1	1 to 3 Tons
73877	3W2	3.5 - 4.5 hp, 189 - 227 mfd, Replaces CSRU3	3.5 to 4.5 Tons
73878	3W3	4 - 5 hp, 270 - 324 mfd, Replaces CSRU3	4 to 5 Tons

Timers

- Multi-purpose delay on make timing
- Protects air-conditioning, refrigeration and heat pumps from damage caused by short cycling of compressor
- Delay range: 6-second to 8-minute adjustable, 3- or 5-minute fixed
- Voltage: 19 to 250VAC/VDC, 50/60Hz input
- Initiate timer: 70 milliseconds
- Maximum load: 1A, 10A inrush
- Operating temperature: 0° to 160°F (-18° to +71°C)
- Dimensions: 2" x 2" x 3/4" (5.08 x 5.08 x 1.9 cm)

Single Hole Mount Delay on Make Timer

- For compressor staging and stagger starting multiple units



TD69



TD73

Part #	Model #	Description
40317	TD69	Adj 6-Sec, 8-Min Delay with 1/4" M Terminals

Single Hole Mount Delay on Break Timer

Part #	Model #	Description
12766	TD73	Adj 6 Sec-5 Min Delay with 1/4" M Terminals

Models and Specifications are Subject to Change Without Notice

Fireplaces (Available in Illinois/Indiana Only)

Novus Gas Burning Fireplaces

- Choice of designer fronts and trims
- Realistic logs
- Large viewing area
- 19-1/8" Depth
- Heater listed to ANSI Z21.88 standards
- Standing pilot standard
- IntelliFire™ ignition system, pilot shuts down when fireplace is not operating
- Certified for installation in bedrooms and bed/sitting rooms

Novus B-Vent Series Gas Burning Fireplace

- Vented using "B-Vent" systems and accessories



Part #	Model #	Input BTUH	Frame	View
177181	NBV4236I-B	25,000/17,000	42"	36"
180959	NBV4842I-B	30,000/20,500	48"	42"

Novus Direct Vent Series Gas Burning Fireplace

- DVP Series venting and accessories are required (5" inner pipe, 8" outer pipe)
- Also certified for mobile homes



Part #	Model #	Input BTUH	Frame	View
177185	NDV3630I	20,000/14,000	36"	30"
179241	NDV3933I	22,000/15,000	39"	33"
177188	NDV4236I	25,000/17,000	42"	36"
177191	NDV4842I	30,000/20,500	48"	42"

Fronts

Part #	Model #
177194	HEASIM-4236 Front for ND/NBV4236I
177197	HEASIM-3630 Front for ND/3630I-B
177199	HEASIM-4842 Front for ND/4842I-B
179014	HEASIM-3933 Simon screen front-B

Caliber® Multi-Sided Gas Burning Fireplaces

- Choice of designer fronts and trims
- Realistic logs with random flame
- Modulating flame control
- Certified for installation in bedrooms, bed/sitting rooms, and mobile homes
- 36" Fireplace
- IntelliFire™ ignition system, pilot shuts down when fireplace is not operating
- Tested and listed to UL safety standards
- Limited lifetime warranty
- Certified for installation in bedrooms and bed/sitting rooms

Caliber® MS Direct Vent Series Gas Burning Fireplace

- Top/rear direct vent
- Cinch Pipe Series venting and accessories required

Part #	Model #	Configuration
194901	GDST4336IFT	See-Thru

Caliber® Gas Burning Fireplaces

- Choice of designer fronts and trims
- Burner fully enclosed
- Large viewing area, 23" box depth
- Steel refractory interior lining
- Standing pilot standard
- DVP Series and Cinch Pipe Series venting and accessories required
- Top or rear direct vent
- Circulating fireplace
- Listed to ANSI Z21.88 standards
- Tested and listed to UL safety standards
- Limited lifetime warranty



Caliber® Direct Vent Series Gas Burning Fireplace

Part #	Model #	Frame	View	Fuel
64049	CD4236IR-D	42"	36"	NG
64050	CD4842IR-D	48"	42"	NG

Fronts

Part #	Model #
159322	SIM-36C-BK Simon Front Black for Caliber CD4236
176195	SIM-42C-BK Simon Front Black for Caliber CD4842

Fireplaces (Available in Illinois/Indiana Only)

Wood-Burning Fireplaces

- Powder-coat finish
- Dual gas knockouts
- SL300 Series chimney components required
- Tested and listed to UL safety standards
- 20-Year Buyer Protection Plan

Element 42 Wood-Burning Fireplace

- Enhanced refractory lining
- Ash lip, front damper handle
- Steel grate and safety fire screen
- Radiant heat
- Factory-installed outside air kit
- Front mount damper control



Part #	Model #	Frm	View	Insulated
43242	EL36	42"	36"	No
43240	EL42	48"	42"	No

Accelerator Wood-Burning Fireplace

- Fully insulated
- Radiant design allows non-combustible finishing material right up to firebox opening
- Circulating design allows air to circulate into the living area
- Uses 8" chimney pipe
- 19-3/4" Firebox depth



Part #	Model #	Opening Size	Style	Refractory Pattern
20335	A36C	36"	Circ	Traditional
20325	A36R	36"	Radiant	Traditional
20330	A42C	42"	Circ	Traditional
20334	A42R	42"	Radiant	Traditional

Fireplace Options

Outside Air Kit

Part #	Model #	Configuration
14033	AK14	Outside Air Kit
19313	AK22	Outside Air Kit
50572	AK24	Outside Air Kit

DM Series Operable Original Bi-Fold Glass Door



Part #	Model #	Description
1798	DM1036	36" Black
30022	DM1036S	36" Stainless Steel f/E/EC36 E/EC36i HR/HC36 EL36/EL36i
1852	DM1042	42" Black
30026	DM1042S	42" Stainless Steel f/E/EC42
39149	DMSRV1136	36" Black SRVDM1136
3617	DM1242	42" Black
20326	DM1736	36" Black
20331	DM1742	42" Black
29874	DM8042	42" Black

Fan Kit

Part #	Model #	Description
20329	FK23	Includes Wiring Harness for A36C, A42C
51415	GFK4B	100 CFM
44295	GFK160B	160 CFM

Remote Control for Gas Fireplace



Part #	Model #	Function(s):
33358	RCT-MLT-HTL	On/Off, Varies Blower Speed & Flame Hgt, Set Temperature Thermostatically
33357	SMART-STAT -HTL	On/Off, Controls Room Temperature
64348	RC200-HTL	On/Off, 5-Step Flame Control, Pilot Activation
64875	SMART-BATT -HTL-B	On/Off, Temp Readout, Thermostat Mode, Timer Mode



Rave Unit



Crave Unit



ICON Series

Other models available, call us for more details.

Illinois/Indiana
866-440-0307

Fireplaces (Available in Illinois/Indiana Only)

Direct Vent Pipe System Components

Part #	Model #	Description
37163	DVP4	4" Straight Section Direct Vent Pipe
37164	DVP6	6" Vent Extension Direct Vent Pipe
37166	DVP12	12" Vent Extension Direct Vent Pipe
37167	DVP24	24" Vent Extension Direct Vent Pipe
37168	DVP36	36" Vent Extension Direct Vent Pipe
37169	DVP48	48" Vent Extension Direct Vent Pipe
37917	DVP12A	12" SLIP Section to Slide Over Any Pipe
37182	DVP45	Snap Lock 45° Elbow
37180	DVP90ST	Snap Lock 90° Starter Elbow
38920	DVP-FS	Direct Vent Fire Stop Spacer
3508	RF6	Direct Vent Roof Flashing
39822	RF12	6/12 Steep Pitch Direct Vent Roof Flashing
39218	DVP-TRAP2	Rear Vent Termination Kit
39220	DVP-TRAPK2	Top Vent Termination Kit
37179	DVP-TV	Vertical Termination Cap with Storm Collar
126961	DVP-BEK2-1	Brick Extension Kit 12" x 14"

Chimney System Components

SL1100 Series Chimney Section

- 10-3/4" effective length after snapped to another
- For Icon Woodburning Fireplaces



Part #	Model #	Size
31477	SL1112	12"
31478	SL1118	18"
31479	SL1136	36"
31480	SL1148	48"

SL300 Series Chimney Section

- 4-3/4" effective length after snapped to another.
- For Elements & Accelerator Woodburning Fireplaces.



Part #	Model #	Size
12331	SL306	6"
12379	SL312	12"
12455	SL318	18"
12511	SL324	24"
12615	SL336	36"
12722	SL348	48"

SL300 Series Roof Flashing

Part #	Model #	Pitch
13745	RF370	0-6/12
13753	RF371	6/12-12/12

SL300 Series Chase Top



Part #	Model #	For Use With:
3737	CT35	SL300 Series Pipe

SL300 Series Firestop Spacer



Part #	Model #	For Use With Model(s):
9596	FS338	SL300 Series Straight Firestop Spacer

Round Cap for SL300 & SL1100 Pipe



Part #	Model #	Description
31487	TR11	Round Terminal Cap w/Storm Collar f/ SL1100 Pipe
49492	TR344	Round Terminal Cap w/Storm Collar f/ SL300 Pipe

30' Offset & Return



Part #	Model #	For Use With Model(s):
31482	SL1130	SL1100 Series
12559	SL330	SL300 Series

Fireplace Accessories (Available in Illinois/Indiana Only)

Fireplaces

Log Lighter Specialties

Hearthmaster™ Log Lighter Kit

- Includes:
 - Log lighter bar
 - Valve
 - Flange
 - Key



Straight Ball Valve Kit

Part #	Model #	Description
9196	955	(3) FPT Inlets/16 Orifice

Hearthmaster™ Log Lighter Accessories

Cast Zinc Key



Part #	Model #	Description
12684	949-K09	5/16" Socket 9-1/2" Key



Chimney Stack Assistant Kits

- For NG or LP gas
- Opens at 185°F
- Manual reset
- 115V, 60Hz
- 1,550 rpm
- Includes:
 - Gas pressure switch (950-2080)
 - 115/24V, 20VA Transformer (950-2030)
 - Wheel kit (950-3010)
 - 24/115V 1/2 hp Relay (950-1040)
 - Motor kit (950-3020)
 - 185°F Linear limit switch (950-2034)
 - Thermocouple junction adapter (950-0470)
 - Housing kit (950-3000)



Part #	Model #	Pipe Diameter	Water Heater Capacity BTUH	Horizontal Vent Connector Length	Watts	Amps
135342	CSA-1	4"	65000	20'	35W	.43A

Models and Specifications are Subject to Change Without Notice



Index by Model Number

007.....	256	0386-1226.....	361	1006.....	390	110898.....	218
010705.....	203	0386-1299.....	361	1007.....	390	110906.....	218
010706.....	203	04112-88-02.....	351	100NFI.....	233	110972.....	218
010710.....	203	04338.....	428	100XL-150.....	282	111007.....	218
010711.....	203	043633.....	203	100XL8.....	282	1110.....	128
010712.....	203	044782.....	212	101-A.....	257	111031.....	240
010713.....	203	044783.....	212	1010.....	335	111034.....	240
010714.....	203	044785.....	212	10.....	147	111.....	243
010721.....	203	044786.....	212	10159.....	195	111250.....	218
010764.....	203	044787.....	212	10169.....	195	111705.....	218
010765.....	203	044789.....	212	102.....	129	111706.....	218
010766.....	203	044790.....	212	1042-LH.....	148	111777.....	218
010767.....	203	044791.....	212	10680.....	203	111778.....	218
013G8015.....	249	04708.....	428	10681.....	203	111823.....	218
013G8019.....	249	047308.....	210	10693908.....	351	111824.....	218
013G8020.....	249	047309.....	210	107-635.....	294	111840.....	218
013G8250.....	249	04811.....	388	107018.....	250	111848.....	71
013G8252.....	249	051035.....	210	107019.....	250	112002W.....	294
013G8562.....	249	051036.....	210	107020.....	250	112003W.....	294
02245.....	432	051037.....	210	107034.....	250	112010-ATF-12.....	244
02249.....	432	051038.....	210	10726.....	203	11300.....	203
024088804.....	351	051039.....	210	10750.....	204	11301.....	203
02498804.....	351	051041.....	210	10753.....	204	11302.....	203
02548USA1.....	351	051042.....	210	10771.....	352	11303.....	203
02549USA1.....	351	051043.....	210	10810.....	369	11305.....	203
02588-00-02.....	351	051044.....	210	10815.....	205	113.....	129
027484.....	212	051045.....	210	10816.....	205	113222.....	241
027538.....	212	051046.....	210	10819.....	205	1137-17.....	149
027540.....	212	051120.....	211	10820.....	205	1137-8.....	149
027541.....	212	051121.....	211	10821.....	205	1137.....	148
027542.....	212	051122.....	211	10823.....	205	118-RUBATEX.....	363
027543.....	212	051123.....	211	10825.....	205	118036.....	245
027544.....	212	051124.....	211	10827.....	205	118153.....	240
027545.....	212	051125.....	211	10830.....	205	118223.....	240
027546.....	212	051126.....	211	10832.....	205	118473.....	239
027812.....	210	051127.....	211	10834.....	205	11851.....	202
027814.....	210	051128.....	211	10844.....	205	11852.....	202
027815.....	210	051129.....	211	10854.....	205	11860.....	202
027816.....	210	051323.....	210	109-15.....	243	11861.....	202
027817.....	210	051324.....	210	109.....	243	11862.....	202
027818.....	210	051325.....	210	1099-20.....	148	11866.....	202
027819.....	210	051326.....	210	1099-42.....	149	11867.....	202
027820.....	210	051327.....	210	1099-LHS.....	148	11870.....	202
027823.....	210	051329.....	210	10REA45.....	194	118705.....	239
027825.....	210	051330.....	210	10RF.....	194	11871.....	202
027826.....	210	051331.....	210	10RFA.....	194	11872.....	202
027827.....	210	051332.....	210	10RM.....	194	118723.....	239
027828.....	210	051333.....	210	10RP18.....	194	11876.....	202
027829.....	210	051334.....	210	10RP24.....	194	11877.....	202
027830.....	210	0554 0568.....	320	10RP3.....	194	11881.....	202
027831.....	210	055694.....	212	10RPA.....	194	118844LF.....	239
027832.....	210	055695.....	212	10RS.....	194	11885.....	202
027833.....	210	055696.....	212	10RTF.....	194	11890.....	202
03458.....	432	055697.....	212	110-103.....	248	11891.....	202
03459.....	432	055698.....	212	110-104.....	248	11894.....	202
03466.....	428	055699.....	212	110-105.....	248	11895.....	202
03467.....	428	055700.....	212	110-106.....	248	11896.....	202
03583.....	428	06005.....	427	110-107.....	248	11898.....	202
03584.....	428	06010.....	427	110-114.....	248	11901.....	202
03585.....	428	0613 5505.....	321	110-124.....	248	11903.....	202
03586.....	428	06784L-2433-3.....	270	110-340.....	241	11906.....	202
03587.....	428	070.....	256	110124.....	247	11909.....	201
03588.....	428	071.....	256	110.....	129, 243	11910.....	201
03589.....	428	076701323.....	63	110132.....	247	11911.....	201
03728.....	432	079.....	256	110192LF.....	245	11931.....	201
03729.....	432	0836-0819.....	359	110196.....	245	12006-01.....	132
03730.....	432	090.....	256	110197.....	245	1210.....	128
03731.....	432	091.....	256	11023.....	384	12122S2.....	352
0386-0503.....	360	1-1/4.....	283	11024.....	384	1213.....	130
0386-0726.....	360	1/2-RUBATEX.....	363	11026.....	384	121371B.....	262
0386-0814.....	360	1/4-RUBATEX.....	363	110271.....	218	12.....	147
0386-0818.....	359	10010.....	368	11028.....	384	123324-004.....	132
0386-0820.....	359	10015.....	354	11030.....	384	123324-005.....	132
0386-0834.....	359	1002.....	382	11055.....	335	123869A.....	262
0386-0835.....	359	1003.....	375	11061.....	335	127-C.....	354
0386-0836.....	359	100343.....	326	110811.....	218	12900.....	202
0386-0849.....	360	1004.....	375	110838.....	218	12901.....	202
0386-1090.....	361	1005.....	334	110842.....	218	12902.....	202

Index by Model Number

12903.....	202	15500.....	326	2" NFI.....	233	261.....	255
12A09.....	396	15620.....	374	2000153.....	212	26129.....	376
12A39.....	396	15625.....	374	201.....	129, 309	26130.....	376
12F.....	343	15806.....	374	20174-6118R.....	356	26244.....	328
12REA45.....	194	15808.....	374	20174.....	375	265000-001.....	150
12RF.....	194	15811.....	374	203371.....	125	269835.....	71
12RM.....	194	15B045FE.....	230	203372.....	125	269836.....	71
12RP24.....	194	15B070FE.....	230	20350-GOLD5C.....	352	269838.....	71
12RP3.....	194	15B096FE.....	230	20353-SSRK1.....	352	269839.....	71
12RS.....	194	15B120FE.....	230	20361.....	387	269853.....	71
12RTF.....	194	15B145FE.....	230	20371-966R5.....	356	27-1130.....	75
1310.....	128	15B170FE.....	230	20529-B618R.....	356	274.....	255
1311-102.....	253	15B195FE.....	230	20530-B656R.....	356	2AYTXVH3G2436A.....	39, 43
1311-103.....	253	15B245FE.....	230	20560-606R.....	356	2AYTXVH3G4848A.....	43
131.....	150	15B295FE.....	230	20562-610R.....	356	2AYTXVH3G6000A.....	43
13195.....	369	160.....	132	20564-614R.....	356	2AYTXVH3H1836A.....	41
13200.....	202	16013.....	207	20566-618R.....	356	2AYTXVH3H4248A.....	41
13201.....	202	16016.....	207	20568-624R.....	356	2AYTXVH3H6060A.....	41
13202.....	202	16048.....	207	20570-636RP.....	356	2DH.....	344
13203.....	202	1610.....	128	20572-656R.....	356	2PPS-08AL.....	197
13207.....	195	16164.....	374	20575-634R.....	356	2PPS-12BL.....	197
13220.....	202	1620.....	128	20578-818R.....	356	2PPS-12L.....	197
13221.....	202	16348.....	207	20580-810R.....	356	2PPS-36BL.....	197
13222.....	202	165295202.....	67	20582-956R.....	356	2PPS-36L.....	197
13223.....	202	165295205.....	67	20585-156R.....	356	2PPS-72L.....	197
13240.....	378	165296401.....	67	205895-UDAS30.....	71	2PPS-ADL.....	198
13302.....	195	16766.....	387	205896-SDH.....	71	2PPS-CDL.....	198
1361-102.....	253	16778.....	207	20597-960R.....	356	2PPS-E45BL.....	197
1361-103.....	253	174F.....	353	20598-966R.....	356	2PPS-E45L.....	197
1361-104.....	253	176234.....	256	2067540.....	234	2PPS-E90BL.....	198
136434AA.....	125	1779801.....	357	2067542.....	234	2PPS-E90EBL.....	198
136434BA.....	125	1779805.....	357	2067544.....	234	2PPS-E90L.....	197
137266.....	125	1787566.....	357	20713.....	247	2PPS-FI2.....	199
138-RUBATEX.....	363	18-C.....	332	21009.....	353	2PPS-FK.....	199
13807.....	322	18047.....	383	210.....	129	2PPS-FLEX25.....	199
13A15.....	396	1830.....	152	21060-656G.....	356	2PPS-FLEX50.....	199
140100.....	257	18.....	343	21067-614G.....	356	2PPS-FS.....	199
14038.....	201	1850.....	152	21069-618G.....	356	2PPS-FSS.....	199
14041.....	201	1853786.....	357	21070-818G.....	356	2PPS-GA.....	198
1410.....	128	18561.....	333	211762.....	71	2PPS-HKL.....	199
1413.....	130	186863LF.....	239	211763.....	71	2PPS-HSTL.....	199
14159.....	384	1870.....	152	213.....	129	2PPS-HTPL.....	199
14160.....	384	189105LF.....	239	21D64-2.....	405	2PPS-LB2.....	198
14161.....	384	189110.....	239	21D64-44.....	405	2PPS-TBL.....	198
14166.....	384	189128LF.....	239	21M51U-843.....	397	2PPS-TCDL.....	199
14167.....	384	189132LF.....	239	21V51U-843.....	397	2PPS-TL.....	198
14172.....	384	189163LF.....	239	220110-020.....	132	2PPS-TPL.....	197
14173.....	384	189165LF.....	239	22015.....	201	2PPS-VKL.....	199
14174.....	384	189.....	309	22017.....	369	2PPS-WPB.....	199
14175.....	384	18F.....	343	22025.....	201	2PPS-WPT.....	200
14176.....	384	19048.....	207	22035.....	201	2PPS-WSM-SS.....	198
14177.....	384	197700.....	427	2210.....	128	2PPS-WSM.....	198
14185.....	384	197701.....	427	22225 2V.....	328	2PPS-X3L.....	198
14187.....	384	197702.....	427	22225CM.....	328	3/4" x 10".....	295
14189.....	384	197703.....	427	22236.....	418	3/4-RUBATEX.....	363
14190.....	384	19807.....	387	222.....	388	3/4.....	283
14193.....	384	19819.....	387	23001.....	369	3/8-RUBATEX.....	363
1423-0024.....	360	198.....	271	23932.....	352	30009757A.....	281
1423-0061.....	360	1C20-101.....	120	24015.....	357	30013.....	369
144060.....	375	1C26-101.....	120	2410.....	128	30014367A.....	281
144062.....	375	1E78-140.....	119	245-03P.....	360	30014.....	369
14525.....	206	1E78-151.....	119	24F.....	343	30032-32L.....	357
149400.....	257	1F56N-444.....	120	25011.....	249	30040-40L.....	357
149600.....	257	1F78-144.....	119	250.....	150	30041.....	369
15-55F.....	232	1F78-151.....	119	25200.....	328	30042-42L.....	357
15001-SH.....	352	1F80ST-0471.....	120	25244.....	328	30042.....	196
1510.....	128	1F83C-11NP.....	117	25403.....	376	30058-58L.....	357
15154.....	384	1F83C-11PR.....	117	25405.....	376	30064-64L.....	357
15155.....	384	1F85U-42PR.....	117	25410.....	376	30066-66L.....	357
15156.....	384	1F86-344.....	119	255649-101.....	132	30068-68L.....	357
15167.....	384	1F86EZ-0251.....	118	255649-102.....	132	30072-72L.....	357
15168.....	384	1F87U-42WF.....	117	255649-105.....	132	30101-SH.....	352
15169.....	384	1F89EZ-0251.....	118	256.....	255	30106.....	369
15180.....	384	1F95-1277.....	118	26023.....	377	30115.....	379
153602.....	257	1F95-1291.....	118	26067.....	376	30120.....	379
153602R.....	257	1F95EZ-0671.....	118	26068.....	376	30187.....	196
15420.....	374	1F95U-42WF.....	117	26072.....	377	302-253.....	241
15427.....	374	1F97-1277.....	118	26073.....	377	302-254.....	241

Models and Specifications are Subject to Change Without Notice



Index by Model Number

30202.....	196	33900.....	365	3PPS-VKL.....	199	41-404.....	403
30204.....	196, 383	33901.....	365	3PPS-WPB.....	199	41-405.....	403
30205.....	383	33925.....	366	3PPS-WPT.....	200	41-406.....	403
30206.....	196	33927.....	366	3PPS-WSM-SS.....	198	41-408.....	403
30242-42CT.....	357	33930.....	365	3PPS-WSM.....	198	41-409.....	403
30350.....	196	339.....	389	3PPS-X4L.....	198	41-410.....	403
30351.....	196	34151.....	284	3R.....	396	41-412.....	403
30361.....	196	34153.....	284	3REA90.....	192	410.....	129
305-92R.....	270	34156.....	284	3RF.....	192	41118.....	207
30711.....	358	342615.....	247	3RFA.....	192	4119.....	130
30750.....	378	342670.....	247	3RHW.....	192	4127-75.....	380
30751.....	378	342671.....	247	3RN4.....	192	4128-03.....	383
30752.....	378	348818-001A.....	132	3RP12.....	192	413.....	129
30755.....	378	349056.....	256	3RP18.....	192	4132-20.....	380
30756.....	378	350.....	145	3RP24.....	192	4133-08.....	380
30757.....	378	35.....	147	3RP3.....	192	4135-08.....	380
30758.....	378	35206.....	379	3RP4.....	192	4143-08.....	380
30850-4321.....	357	35211.....	379	3RP5.....	192	4145539.....	234
30882-VB2.....	357	35271.....	379	3RPA.....	192	4166-75.....	380
30912-VB12.....	357	35283.....	379	3RS.....	192	41672.....	243
310.....	129, 320	35284.....	379	3RSA.....	192	4168-08.....	381
31017.....	378	35504.....	378	3RT3.....	192	4171-75.....	380
31018.....	378	35515.....	378	3RTF.....	192	4178-08.....	381
31019.....	378	35610.....	378	3RWB.....	192	4180-53.....	374
31020.....	378	358.....	217	3RWT.....	192	4181.....	147
31125.....	378	360-17-3.....	388	3S12.....	191	4182-08.....	374
31132.....	378	365.....	388	3S24.....	191	4182-24.....	374
31133.....	378	36C03-300.....	395	3S36.....	191	4182-53.....	374
31199.....	375	36C03-333.....	395	3S48.....	191	4184-24.....	374
312-FC.....	353	36C03-400.....	395	3S60.....	191	4184-53.....	374
31202.....	375	36C94-303.....	395	3SADJ.....	191	4184.....	146
31212.....	375	36H32-304.....	395	3SE45.....	191	4185-75.....	386
313.....	129	36H32-423.....	395	3SE90TR.....	191	4186-24.....	381
31321.....	369	36H64-463.....	395	3W1.....	436	4190-02.....	386
31328.....	358	376395.....	250	3W2.....	436	4190-08.....	380
31336.....	358	3840-DB-S.....	207	3W3.....	436	4190420.....	234
31337.....	358	3840-WH-S.....	207	4000-7121/C.....	83	4191-08.....	381
31338.....	358	3840-WN-S.....	207	4000-7141/C.....	83	4191.....	147
31346.....	358	3860-DB-S.....	207	4000-7151/C.....	83	421-C.....	331
31400.....	369	394800-30.....	401	4000-8181/C.....	83	4217-12.....	376
31407.....	358	398.....	388	40003916-026.....	252	4218.....	147
3200161-001.....	142	3F05-1.....	412	40003916-048.....	252	4219-12.....	376
32001615-001.....	142	3F05-2.....	412	40003916-548.....	154	421MB4X10.....	203
32001630-001.....	142	3L05-1.....	412	4001.....	147	421MB4X12.....	203
32001632-001.....	142	3L05-2.....	412	400.....	144	421MW4X10.....	203
32001639-002.....	142	3L05-3.....	412	40019.....	383	421MW4X12.....	203
32001676-001.....	142	3 LITE PRO.....	120	4004.....	146	422-CB.....	331
32001752-001.....	142	3PPS-08AL.....	197	4005.....	147, 363	422-CR.....	331
32001876-001.....	142	3PPS-12BL.....	197	40053.....	387	4223.....	146
32005376-001.....	142	3PPS-12L.....	197	40067.....	387	4226.....	146
322-25.....	388	3PPS-36BL.....	197	40069.....	387	423-CR.....	331
32216.....	336	3PPS-36L.....	197	4008.....	363	4231.....	146
324A.....	389	3PPS-72L.....	197	400M.....	144	4232.....	146
325-3-12.....	396	3PPS-ADL.....	198	4010.....	146	4235.....	146
325-5A-1.....	396	3PPS-BV5.....	200	401.....	129	4236.....	147
325-5A-34.....	396	3PPS-CDL.....	198	40206.....	387	4237.....	146
32500.....	337	3PPS-E45BL.....	197	40207.....	387	4238.....	146
32510.....	337	3PPS-E45L.....	197	40215.....	387	4246.....	147
32527.....	337	3PPS-E90BL.....	198	40216.....	387	4247.....	145
32534.....	338	3PPS-E90EBL.....	198	40222.....	387	4270.....	130
32558.....	337	3PPS-E90L.....	197	404-T.....	241	4290-75.....	381
32561.....	337	3PPS-F12.....	199	4040.....	147	4291-08.....	381
32581.....	336	3PPS-FAS.....	198	4050-01.....	373	4291-18.....	381
32593.....	337	3PPS-FKL.....	199	4050-06.....	373	4292-75.....	386
32596.....	338	3PPS-FLEX25.....	199	4050-07.....	373	4293-75.....	375
32751.....	337	3PPS-FLEX35.....	199	4050-08.....	373	4296-50.....	376
32801.....	339	3PPS-FS.....	199	4050-11.....	373	4296-60.....	372
330-3.....	389	3PPS-FSS.....	199	4050-12.....	373	4300-08.....	382
33112N.....	332	3PPS-GA.....	198	4050-15.....	373	4300-09.....	382
33112RK.....	329	3PPS-HKL.....	199	4051-99.....	373	4300-10.....	382
332401.....	361	3PPS-HSTL.....	199	4057-55.....	382	4300-15.....	382
335.....	390	3PPS-HTPL.....	199	4074EHG.....	125	4300-30.....	382
335FT.....	389	3PPS-LB2.....	198	4074EKV.....	165	4300-38.....	382
33741.....	365	3PPS-TBL.....	198	4079.....	146	4300-50.....	382
33742.....	365	3PPS-TCDL.....	199	4090765.....	234	4300-89.....	382
33743.....	365	3PPS-TL.....	198	40XL-8.....	282	4301.....	312
338.....	389	3PPS-TPL.....	197	41-401.....	403	43106.....	204
33895.....	365	3PPS-VFTL.....	199	41-402.....	403	43108.....	204

Index by Model Number

43109.....	204	43432.....	205	4AYTXVH3G2436A.....	39, 43	4PXCDD48BS3HDA.....	40
43110.....	204	43583.....	431	4AYTXVH3G4848A.....	43	4PXCDD60BS3HDA.....	40
43111.....	204	43584.....	431	4AYTXVH3G6000A.....	43	4PXCDDU48BS3HAA.....	40
43113.....	204	43585.....	431	4GXCA001AC6HUA.....	43	4PXCDDU60BS3HAA.....	40
43114.....	204	43586.....	431	4GXCA003AC6HUA.....	43	4RDH.....	192
43116.....	204	43587.....	431	4GXCB002AC6HUA.....	43	4REA60.....	192
43117.....	204	43588.....	431	4GXCB004AC6HUA.....	43	4REA90.....	192
43118.....	204	43589.....	431	4GXCB006AC6HUA.....	43	4RF.....	192
43119.....	204	43590.....	431	4GXCC005AC6HUA.....	43	4RGS.....	192
43120.....	204	43621.....	203	4GXCC007AC6HUA.....	43	4RHW.....	192
43124.....	204	43641.....	203	4GXCC009AC6HUA.....	43	4RLA.....	192
43125.....	204	43644.....	203	4GXCD008AC6HUA.....	43	4RN5.....	192
43126.....	204	43649.....	203	4GXCD010AC6HUA.....	43	4RN6.....	192
43127.....	204	4366-87.....	386	4MXC8512A10NOA.....	88	4RN7.....	192
43128.....	204	43671.....	203	4MXC8518A10NOA.....	88	4RPA.....	192
43129.....	204	4369-75.....	377	4MXC8524A10NOA.....	88	4RPX12.....	192
43130.....	204	4371-32.....	369	4MXCA001AC6HCA.....	43	4RPX18.....	192
43131.....	204	4371-36.....	369	4MXCA003AC6HCA.....	43	4RPX24.....	192
43132.....	204	4372-24.....	381	4MXCB002AC6HCA.....	43	4RPX3.....	192
43134.....	204	43732.....	434	4MXCB004AC6HCA.....	43	4RPX4.....	192
43135.....	204	43733.....	434	4MXCB006AC6HCA.....	43	4RPX5.....	192
43139.....	204	43734.....	434	4MXCC005AC6HCA.....	43	4RRA.....	192
43140.....	204	43735.....	434	4MXCC007AC6HCA.....	43	4RS.....	192
43141.....	204	4387-01.....	379	4MXCC009AC6HCA.....	43	4RSA.....	192
43142.....	204	4387-02.....	379	4MXCD008AC6HCA.....	43	4RT4.....	192
43143.....	204	4390-08.....	379	4MXCD010AC6HCA.....	43	4RTF.....	192
43144.....	204	4390-32.....	379	4MXL8518A10NOA.....	88	4RWB.....	192
43145.....	204	44101.....	339	4MXL8524A10NOA.....	88	4RWT.....	192
43147.....	204	441.....	217	4MXW1609A10NOA.....	84	4S24.....	191
43152.....	204	44130.....	339	4MXW1612A10NOA.....	84	4S48.....	191
43154.....	204	44131.....	339	4MXW1618A10NOA.....	84	4S60.....	191
43155.....	204	441729-101.....	132	4MXW1624A10NOA.....	84	4SADJ.....	191
43156.....	204	441730-101.....	132	4MXW3809A10NUA.....	84	4SE90TR.....	191
43157.....	204	443.....	242	4MXW3812A10NUA.....	84	4STS.....	191
43158.....	204	444.....	242	4MXW3818A10NUA.....	84	4TTA3036A3000C.....	53
43159.....	204	44443WPR.....	247	4MXW3824A10NUA.....	84	4TTA3036B3000B.....	53
43161.....	204	44444WPR3.....	247	4MXW8509A10NOC.....	84, 86	4TTA3036B4000A.....	53
43162.....	204	444W.....	390	4MXW8512A10NOC.....	84, 86	4TTA3048D3000C.....	53
43166.....	204	445.....	242	4MXW8518A10NOC.....	84, 86	4TTA3048D4000C.....	53
43167.....	204	446.....	242	4MXW8524A10NOC.....	84, 86	4TTA3060D3000C.....	53
43168.....	204	447354.....	209	4MXW8536A10NOC.....	84	4TTA3060D4000C.....	53
43169.....	204	447380-010.....	131	4OARA.....	192	4TTL6018A1000A.....	4
43170.....	204	45009.....	387	4 PRO.....	120	4TTL6024A1000A.....	4
43171.....	204	45.....	147	4PXA AU24BS3HAA.....	42	4TTL6030A1000A.....	4
43173.....	204	45458B.....	434	4PXABU24BS3HAA.....	42	4TTL6036A1000A.....	4
43174.....	204	45460.....	431	4PXABU30BS3HAA.....	42	4TTL6042A1000A.....	4
43177.....	204	45461.....	431	4PXABU36BS3HAA.....	42	4TTL6048A1000A.....	4
43178.....	204	45470.....	431	4PXABU42BS3HAA.....	42	4TTR3018H1000N.....	6
43179.....	204	45471.....	431	4PXABU48BS3HAA.....	42	4TTR3024H1000N.....	6
43180.....	204	455578-001C.....	132	4PXACU30BS3HAA.....	42	4TTR3030H1000N.....	6
43186.....	204	455600-025.....	131	4PXACU36BS3HAA.....	42	4TTR3036H1000N.....	6
4330.....	147	455600-125.....	131	4PXACU42BS3HAA.....	42	4TTR3042E1000N.....	6
4331.....	147	455602-025.....	131	4PXACU48BS3HAA.....	42	4TTR3048E1000N.....	6
4332.....	146	455602-125.....	131	4PXACU60BS3HAA.....	42	4TTR4018L1000A.....	6
4335.....	146	4602.....	130	4PXADU48BS3HAA.....	42	4TTR4024L1000B.....	6
4336.....	146	4640.....	147	4PXADU60BS3HAA.....	42	4TTR4030L1000A.....	6
43401.....	205	4655.....	145	4PXCAD24BS3HDA.....	40	4TTR4036L1000A.....	6
43402.....	205	4670.....	146	4PXCADU24BS3HAA.....	40	4TTR4042L1000A.....	6
43403.....	205	47-2.....	257	4PXCBD24BS3HDA.....	40	4TTR4048L1000A.....	6
43404.....	205	4720-06.....	372	4PXCBD30BS3HDA.....	40	4TTR6018J1000A.....	4
43405.....	205	4732.....	146	4PXCBD36BS3HDA.....	40	4TTR6024J1000B.....	4
43406.....	205	4736.....	130	4PXCBD42BS3HDA.....	40	4TTR6030J1000A.....	4
43407.....	205	4740.....	146	4PXCBD48BS3HDA.....	40	4TTR6036J1000A.....	4
43409.....	205	4750.....	146	4PXCBU24BS3HAA.....	40	4TTR6042J1000A.....	4
43410.....	205	4771-3.....	382	4PXCBU30BS3HAA.....	40	4TTR6048J1000A.....	4
43411.....	205	4774-0.....	382	4PXCBU36BS3HAA.....	40	4TTR6049J1000A.....	4
43413.....	205	4774-1.....	382	4PXCBU42BS3HAA.....	40	4TTR6060J1000A.....	4
43416.....	205	4792.....	146	4PXCBU48BS3HAA.....	40	4TTR6061C1000A.....	4
43417.....	205	4793.....	146	4PXCDD30BS3HDA.....	40	4TTR7024A1000B.....	4
43418.....	205	47D01U-843.....	398	4PXCDD36BS3HDA.....	40	4TTR7036A1000B.....	4
43419.....	205	4837.....	146	4PXCDD42BS3HDA.....	40	4TTR7048A1000B.....	4
43420.....	205	4839.....	146	4PXCDD48BS3HDA.....	40	4TTV0024A1000B.....	1
43423.....	205	4894.....	130	4PXCDD60BS3HDA.....	40	4TTV0036B1000B.....	1
43424.....	205	4897.....	130	4PXCCU30BS3HAA.....	40	4TTV0048A1000B.....	1
43425.....	205	4900-20.....	135	4PXCCU36BS3HAA.....	40	4TTV0060A1000B.....	1
43428.....	205	49771.....	134	4PXCCU42BS3HAA.....	40	4TTV0061A1000B.....	1
43430.....	205	4981.....	146	4PXCCU48BS3HAA.....	40	4TTV8024A1000B.....	1
43431.....	205	49P11-843.....	415	4PXCCU60BS3HAA.....	40	4TTV8036A1000B.....	1

Models and Specifications are Subject to Change Without Notice



Index by Model Number

4TTV8037A1000B.....	1	4TXK8512A10NOC.....	84	54443WPR.....	247	5RP5.....	193
4TTV8048A1000B.....	1	4TXK8518A10NOC.....	84	546306A.....	242	5RP6.....	193
4TTV8060A1000B.....	1	4TXK8524A10NOC.....	84	546307A.....	242	5RPA.....	193
4TTX6018J1000A.....	2	4TXK8536A10NOC.....	84	546308A.....	242	5RRA.....	193
4TTX6024J1000B.....	2	4TXM6518A1020C.....	86	548006A.....	242	5RS.....	193
4TTX6030J1000A.....	2	4TXM6524A1030C.....	86	548007A.....	242	5RSA.....	193
4TTX6036J1000A.....	2	4TXM6530A1040B.....	86	548009A.....	242	5RT4.....	193
4TTX6042J1000A.....	2	4TXM6536A1040C.....	86	550.....	321	5RT5.....	193
4TTX6048J1000A.....	2	4TXM6542A1050C.....	86	550B.....	325	5RTF.....	193
4TTX6049J1000A.....	2	4YCC4024A1060A.....	44	551005A.....	242	5RWB.....	193
4TTX6060J1000A.....	2	4YCC4030A1070A.....	44	551006A.....	242	5RWT.....	193
4TTX6061J1000A.....	2	4YCC4036A1090A.....	44	551007A.....	242	5RYF.....	193
4TTX8024A1000B.....	2	4YCC4042A1090A.....	44	551008A.....	242	6-1.....	371
4TTX8036A1000B.....	2	4YCC4048A1090A.....	44	551009A.....	242	6-3030L.....	371
4TTX8048A1000B.....	2	4YCC4060A1115A.....	44	551022A.....	242	6-3050L.....	371
4TTX8060A1000B.....	2	5/8-RUBATEX.....	363	551028A.....	242	6-3060L.....	371
4TWR4018G1000A.....	9	50000293-002.....	125	551035A.....	242	6-3636L.....	371
4TWR4024G1000A.....	9	50000293-004.....	125	551041A.....	242	6-3660L.....	371
4TWR4030G1000A.....	9	5000.....	128	551054A.....	242	6-5070G.....	215
4TWR4036G1000A.....	9	500.....	144	553265.....	211	6-7090G.....	215
4TWR4042G1000A.....	9	50024917-001.....	142	553267.....	211	6-HK3050.....	371
4TWR4048G1000A.....	9	50027997-001.....	142	553268.....	211	6-HK3060.....	371
4TWR4060G1000A.....	9	50027998-002.....	142	553269.....	211	600-4.....	336
4TWR6018H1000A.....	9	50028001-001.....	142	553270.....	211	600.....	144
4TWR6024H1000A.....	9	50028044-001.....	141	553271.....	211	6005690.....	241
4TWR6030H1000A.....	9	50041883-001.....	142	553272.....	211	6005691.....	241
4TWR6036H1000A.....	9	50041883-002.....	142	553273.....	211	6005693.....	241
4TWR6042H1000A.....	9	50041890-002/U.....	142	553274.....	211	600M.....	144
4TWR6048H1000A.....	9	50043683-001.....	142	553277.....	212	601-7-INS.....	336
4TWR6060H1000A.....	9	50046086-001/U.....	142	553278.....	212	601-G20CV.....	305
4TWR7024A1000C.....	9	50046089-001/U.....	142	553279.....	212	601-G30CV.....	305
4TWR7036B1000C.....	9	50053952-020.....	154	553280.....	212	60142.....	378
4TWR7048A1000C.....	9	50057547-001.....	142	553281.....	212	60.....	145
4TWR7060A1000C.....	9	50057547-002.....	142	553282.....	212	601S.....	250
4TWW0024A1000B.....	7	50057547-003.....	142	553283.....	212	602-4DD.....	336
4TWW0036A1000B.....	7	500M.....	144	553284.....	212	602-7-INS.....	336
4TWW0048A1000B.....	7	501.....	129	553542A.....	246	602-7DD.....	336
4TWW0060A1000B.....	7	50.....	145	55415-8.....	340	603-4.....	336
4TWW8024A1000B.....	7	5018.....	344	55416-10.....	340	60325.....	345
4TWW8036A1000B.....	7	502343A.....	241	554200.....	370	60331.....	345
4TWW8037A1000B.....	7	502710A.....	241	55421-BP.....	340	60342.....	345
4TWW8048A1000B.....	7	50290.....	206	55431.....	340	60493.....	345
4TWW8049A1000B.....	7	50292.....	206	555-050RP.....	254	60741111.....	272
4TWW8060A1000B.....	7	50294.....	206	557.....	321	6074111.....	272
4TWX6024H1000A.....	8	50295.....	206	557818.....	210	6074112.....	272
4TWX6030H1000A.....	8	50312.....	206	571-2.....	254	6074114.....	272
4TWX6036H1000A.....	8	50316.....	206	572.....	254	6074116.....	272
4TWX6042H1000A.....	8	50356.....	207	573009A.....	246	6074118.....	272
4TWX6048H1000A.....	8	50509.....	206	573012A.....	246	6074419.....	272
4TWX6060H1000A.....	8	50510.....	206	599122 ACS-2.....	371	6074420.....	272
4TWX8024A1000C.....	8	50511.....	206	5ACCO3SC.....	213	610-1/4M.....	338
4TWX8036C1000C.....	8	50512.....	206	5ACC12RD.....	214	610-5/16M.....	338
4TWX8048A1000C.....	8	50513.....	206	5ACCI5RD.....	213, 214	610.....	129
4TWX8060A1000C.....	8	50560.....	206	5ACC19RD.....	214	610M.....	338
4TXCA002DS3HCA.....	40	50613.....	243	5ACC23RD.....	214	61105.....	383
4TXCB003DS3HCA.....	40	50614.....	243	5DDDO85A.....	214	61118.....	386
4TXCB004DS3HCA.....	40	50615.....	243	5DDDI06A.....	214	612-4.....	337
4TXCB006DS3HCA.....	40	508013A.....	241	5DDDI10AA.....	214	618-1/4M.....	338
4TXCC005DS3HCA.....	40	50A55-843.....	397	5DDDI2CA.....	214	618-5/16M.....	338
4TXCC007DS3HCA.....	40	50E47-843.....	402	5DDDI3DB.....	214	6202.....	166
4TXCC009DS3HCA.....	40	50M56U-843.....	398	5DDDI5CA.....	214	6202MX.....	311
4TXCD008DS3HCA.....	40	510.....	129	5DDDI6DB.....	214	6203.....	166
4TXCD010DS3HCA.....	40	51.....	145	5DDDI8EB.....	214	62.....	145
4TXFH024CZ3HHB.....	42	5140.....	340	5R.....	396	6303.....	166
4TXFH033CC3HHB.....	42	51425.....	386	5RDH.....	193	630500.....	212
4TXFH036CZ3HHB.....	42	5162.....	94	5REA60.....	193	634.....	217
4TXFH041CC3HHB.....	42	518.....	255	5REA90.....	193	634M.....	217
4TXFH054CC3HHB.....	42	5184.....	340	5RF.....	193	636.....	217
4TXFH064AZ3HHA.....	42	519.....	255	5RFA.....	193	639.....	217
4TXK1609A10NOA.....	84	519502A.....	250	5RGS.....	193	641.....	217
4TXK1612A10NOA.....	84	521.....	255	5RHW.....	193	643.....	217
4TXK1618A10NOA.....	84	521509A.....	248	5RLA.....	193	644.....	217
4TXK1624A10NOA.....	84	521519A.....	248	5RN6.....	193	646-1/4M.....	338
4TXK3809A10NUA.....	84	521609A.....	248	5RP12.....	193	646-5/16M.....	338
4TXK3812A10NUA.....	84	521619A.....	248	5RP18.....	193	646M.....	338
4TXK3818A10NUA.....	84	5306.....	146	5RP24.....	193	649X2.....	270
4TXK3824A10NUA.....	84	53178.....	341	5RP3.....	193	650-100.....	218
4TXK8509A10NOB.....	84	535-C.....	332	5RP4.....	193	650-300.....	218

INDEX

Index by Model Number

650264-00.....	64, 83	700M.....	144	83017.....	92	90-370.....	416
650264-01.....	64, 83	703908.....	206	83321.....	316	90-T40F3.....	420
655009-03.....	64	703909.....	206	83323.....	316	90-T50F3.....	420
655009-07.....	64	703911.....	206	83905.....	421	902C.....	310
655009-08.....	64	703912.....	206	84002.....	98	9062.....	349
655009-09.....	64	70591.....	336	84003.....	98	9063.....	349
655010-08.....	64	710-185G.....	366	84004.....	97	9068.....	349
655010-09.....	64	7165-25.....	385	84007.....	98	906C.....	310
65614156.....	64	7173-25.....	385	84010.....	97	907C.....	310
65614162.....	64	7187.....	385	84011.....	98	9111.....	358
65614168.....	64	7197.....	385	84012.....	98	9216.....	358
656166-01.....	83	74024.....	435	84014.....	98	9222.....	358
656166-02.....	83	74027.....	435	84015.....	98	9229.....	358
66-200.....	375	75005.....	206	84016.....	97	9234.....	358
660.....	310	75007.....	206	84064.....	97	9235.....	358
665.....	256	75010.....	206	84102.....	98	9330RE.....	339
66731.....	97	75012.....	206	84103.....	98	935RBLT.....	339
66733.....	97	75013.....	206	84104.....	97	93LDM65.....	325
66735.....	97	75018.....	206	84107.....	98	94162.....	435
66737.....	97	752.....	310	84110.....	97	94164.....	435
6705.....	166	767A-370.....	404	84111.....	98	94170.....	435
6706.....	166	767A-372.....	404	84112.....	98	94173.....	435
6707.....	166	767A-378.....	404	84115.....	98	94174.....	435
6708.....	166	7680B6541.....	83	84116.....	97	94175.....	435
671.....	216	768A-842.....	405	84164.....	97	94176.....	435
67212x12W.....	205	768A-844.....	405	84267.....	98	94177.....	435
67214X10W.....	205	770-1.....	413	84270.....	97	94178.....	435
67218X10W.....	205	772.....	310	84271.....	98	94179.....	435
672M10X10.....	205	785-001.....	402	84272.....	98	94180.....	435
672M10X6.....	205	7900A6111.....	83	84274.....	98	94181.....	435
672M12X12.....	205	7900A6171.....	83	84276.....	97	94182.....	435
672M12X6.....	205	79095.....	362	8444.....	116	94183.....	435
672M14X14.....	205	79175.....	350	8448.....	116	94184.....	435
672M14X6.....	205	7990-6261.....	83	846-C.....	331	94185.....	435
672X1244.....	270	7990-6281.....	83	8463.....	116	94186.....	435
672XV0242.....	270	7REA90.....	193	8465.....	116	94187.....	435
672XV0342.....	270	7RF.....	193	8476.....	116	94188.....	435
672XV0442.....	270	7RFA.....	193	8476W.....	116	94189.....	435
678-21244.....	270	7RM.....	193	85484.....	336	94190.....	435
678.....	217	7RP12.....	193	8600.....	116	94191.....	435
67900.....	404	7RP24.....	193	860.....	310	94192.....	435
6795L-12333.....	270	7RP3.....	193	8620.....	116	949-K09.....	440
680504A.....	270	7RP4.....	193	8620W.....	116	94AT.....	206
68234.....	335	7RP5.....	193	86225.....	345	955-MRS.....	331
68310.....	335	7RPA.....	193	862.....	310	955.....	440
685011.....	390	7RS.....	193	86379.....	316	97622.....	93
688.....	216	7RTF.....	193	864.....	310	98002BT.....	341
691.....	350	800.....	143	865.....	143, 310	990-13.....	148
692.....	350	800C.....	310	86600.....	339	990-53.....	149
6CKDSIH.....	196	80.....	146	86601.....	339	99088.....	368
6RDH.....	193	8028.....	166	86602.....	339	991675-01.....	64
6REA60.....	193	8047.....	195	880921.....	389	991675-02.....	64
6REA90.....	193	805-MRS.....	331	885AL.....	218	9940040.....	134
6RF.....	193	8051.....	195	885BL.....	218	9960009.....	134
6RFA.....	193	8064101.....	272	8910.....	116	9960011.....	134
6RGS.....	193	80741603.....	272	8910W.....	116	996.....	243
6RHW.....	193	80741604.....	272	8920W.....	116	9970025.....	134
6RN7.....	193	8074417.....	272	894075.....	196	9A1.5C.....	272
6RN8.....	193	8076001.....	272	8REA90.....	194	9A1R.....	272
6RP12.....	193	8085.....	195	8RF.....	194	9A2C.....	272
6RP18.....	193	8086.....	195	8RFA.....	194	9A2I.....	272
6RP24.....	193	808C.....	310	8RM.....	194	9A2L.....	272
6RP3.....	193	80LC.....	147	8RP12.....	194	9A2R.....	272
6RP4.....	193	8100.....	156	8RP18.....	194	9A3C.....	272
6RP5.....	193	810.....	129	8RP24.....	194	9A3R.....	272
6RP6.....	193	81036.....	201	8RP3.....	194	9A4C.....	272
6RPA.....	193	81050.....	201	8RP4.....	194	9A4I.....	272
6RRA.....	193	811097020419.....	105	8RP5.....	194	9A4L.....	272
6RS.....	193	8120X.....	155	8RPA.....	194	9A4R.....	272
6RSA.....	193	8126X.....	155	8RS.....	194	9A5C.....	272
6RT4.....	193	814C.....	310	8RT8.....	194	9A5R.....	272
6RT6.....	193	8169.....	195	8RTF.....	194	9A6C.....	272
6RTF.....	193	8170.....	195	90-112.....	412	9A6I.....	272
6RX048238.....	363	821.....	389	90-113.....	412	9A6L.....	272
6RX048312.....	363	82346.....	315	90-291Q.....	416	9QN5773T.....	428
7/8-RUBATEX.....	363	82347.....	315	90-293Q.....	416	9QN9541T.....	428
700-C.....	241	82349.....	315	90-340.....	416	A-1.....	365
700.....	144	827.....	390	90-341.....	416	A 00633.....	304

Models and Specifications are Subject to Change Without Notice



Index by Model Number

A110.....	216	A4342050.....	267	AM-102R-US-1.....	279	BAYCURB050A.....	44, 50
A1180313.....	264	A4342075.....	267	AP543-100.....	50	BAYCURB051A.....	44, 50
A1210375.....	264	A5060701.....	267	AP572-100.....	50	BAYCURB320A.....	48
A1220313.....	264	A5060702.....	267	AQ1000TN2.....	259	BAYDMPRO29C.....	46
A1220500.....	264	A5060761.....	267	AQ12C20.....	259	BAYDMPRO53A/B.....	45
A1220625.....	264	A5080500.....	268	AQ25042B.....	259	BAYDMPRO56A.....	45
A1220750.....	264	A5110375.....	268	AQ25742B.....	259	BAYDMPRO58A.....	46
A1250500.....	264	A5110500.....	268	AR-MC.....	360	BAYDMPR301A.....	49
A1250625.....	264	A5110625.....	268	ARD10TZ/U.....	162	BAYDMPR321A.....	48
A1250750.....	264	A5500500.....	269	ARD12TZ/U.....	162	BAYEAAC05BK1BA.....	33
A1251000.....	264	A5500625.....	269	ARD14TZ/U.....	162	BAYEAAC08BK1BA.....	33
A1.....	342	A5500750.....	269	ARD16TZ/U.....	162	BAYEAAC10BK1BA.....	33
A2080020.....	265	A60048.....	435	ARD6TZ/U.....	162	BAYEABC15BK1BA.....	33
A2080032.....	265	A60.....	343	ARD8TZ/U.....	162	BAYEABC20BK1BA.....	33
A2123210.....	268	A7011250.....	269	ARD9TZ/U.....	162	BAYEAACC25BK1BA.....	33
A2.....	342	A7015075.....	269	AREMOT2AHANDAA.....	85, 87, 88	BAYECAAI01LGB1A.....	33
A2620005.....	265	A7031000.....	268	ARM2P.....	251	BAYECMT004.....	1, 7
A2660201.....	265	A70L.....	217	ARM3P.....	251	BAYECMT023.....	1, 7
A2660300.....	265	A80.....	216	ARM4P.....	251	BAYECON086B.....	45
A2660301.....	265	ABM-100.....	323	ARM6P.....	251	BAYECON088B.....	45
A2660400.....	265	AC-519.....	321	AS22-1G.....	376	BAYECON089A.....	46
A2660401.....	265	AC-ACM.....	76	AS22-TG.....	376	BAYECON090A.....	46
A2660500.....	265	AC-IKLT-2.....	76, 77	ASP-MA-UNI.....	95	BAYECON091A.....	47
A2660501.....	265	AC-IKLT-5.....	76, 77	ASP-ML-UNI.....	96	BAYECON092A.....	47
A2660601.....	265	AC-KCWE.....	75	ASP-MO-UNI.....	95	BAYECON101A.....	44
A2660701.....	265	AC-PAJ.....	75	ASP-MW-UNI.....	96	BAYECON102A.....	44
A2660801.....	265	AC-PAJSQ.....	75	ASYSTAT106A.....	160	BAYECON200A.....	44
A2700202.....	264	AC-RBC-2.....	78	ASYSTAT108A.....	160	BAYECON201A.....	44
A2700302.....	264	AC-RBC-3.....	78	ASYSTAT777A.....	160	BAYECON300A.....	49
A2700402.....	264	AC-RBC-5.....	78	ASZERO-1-G.....	376	BAYECON301A.....	49
A2700502.....	264	AC-RBF-3.....	75	ASZERO-T-G.....	376	BAYECON320A.....	48
A2700602.....	264	AC-RMED3P-2.....	78	AT140A1000.....	419	BAYENTH001A.....	44
A2700702.....	264	AC-RMED3P-3.....	78	AT140A1018.....	419	BAYENTH007A.....	46, 47
A2700802.....	264	AC-RMED3P-5.....	78	AT150A1007.....	419	BAYENTH300.....	45, 49
A2701002.....	264	AC-RMK-FACM.....	76	AT175A1008.....	419	BAYENTH301.....	45, 49
A2701202.....	264	AC-ST6-100.....	75	AT175F1023.....	420	BAYFLR2220A.....	29, 31
A2771060.....	264	AC-ST8-75.....	75	AT20Z.....	377	BAYFLTR101C.....	44
A2803250.....	265	AC-TKFS-2.....	76	AT88A1047.....	419	BAYFLTR200.....	18, 25
A3023522.....	265	AC-TKFS-5.....	76	ATL55.....	321	BAYFLTR201C.....	44
A3041501.....	265	AC-TKMR-2.....	76	ATT29.....	321	BAYFLTR203.....	18, 25
A31002.....	332	AC-TKMR-5.....	76	ATT29A.....	321	BAYFLTR204.....	18, 25
A31003.....	332	AC-TORD.....	76	ATTPC3.....	321	BAYFLTR205.....	18, 25
A31004.....	332	AC-TRM-LS-UO.....	78	AV6.....	342	BAYFLTR206.....	18, 25
A31005.....	332	AC-TRM-OS-UO.....	78	AVM6.....	341	BAYFLTR317.....	18, 25
A31006.....	332	ACB-AB.....	93	AVM7.....	341	BAYFLTR321.....	18, 25
A31134.....	332	ACB-SB-POWDER COATED.....	362	AZ-4CP.....	251	BAYFLTR324.....	18, 25
A31135.....	332	ACC-0410.....	102	AZ-6CP.....	251	BAYFRAME145.....	134
A31136.....	332	ACONT200AN11AA.....	108	AZON1050AC52ZA.....	101	BAYFRAME175.....	134
A31142.....	332	ACONT401AN21MA.....	108	AZONE940AC52ZA.....	157	BAYFRAME210.....	134
A31144.....	332	ACONT402AN32DA.....	108	AZTSK500BB32MA.....	157	BAYFRAME245.....	134
A31482.....	333	ACONT600AF11MA.....	107	BAY369BBADBDBEA.....	104	BAYFRKIT100.....	32
A31484.....	333	ACONT602AF22MA.....	107	BAY469ABACAMEA.....	104	BAYFRTLLOUPNL20.....	39
A31851.....	332	ACONT624AS42DA.....	102	BAY599ABALLFEA.....	104	BAYFRTLLOUPNL22.....	39
A31852.....	332	ACONT800AS11AA.....	107	BAY599SNALLFEA.....	104	BAYHHKIT001.....	29, 31
A31999.....	333	ACONT802AS32DA.....	107	BAY6TXV2442A.....	36	BAYHTR1505BRKC.....	37
A32004.....	333	ACONT803AS32DA.....	107	BAY6TXV4860A.....	36	BAYHTR1508BRKC.....	37
A32008-BX.....	333	ACONT824AS52DA.....	102	BAYAIR30AVENTA.....	13, 18	BAYHTR1510BRKC.....	37
A3.....	342	ACONT850AC52UA.....	101	BAYATXV1836B.....	32, 36	BAYHTR1515BRKB.....	37
A36C.....	438	ACONTV10APBCOA.....	153	BAYATXV4248B.....	36	BAYHTR1516BRKB.....	37
A36R.....	438	AD-4.....	251	BAYATXV6161B.....	36	BAYHTR1519BRKB.....	37
A4010313.....	267	AF1000.....	304	BAYBASE205.....	13, 18, 25	BAYHTR1520BRKB.....	37
A4020313.....	267	AF1100.....	304	BAYBRFBX100.....	32	BAYHTR1521BRKB.....	37
A4020375.....	267	AF1200.....	304	BAYCARR001A.....	49	BAYHTR1522BRKA.....	37
A4020500.....	267	AF1300.....	304	BAYCC24VK01A.....	29	BAYHTR1525BRKA.....	37
A4020625.....	267	AF1400.....	304	BAYCCHT301RES.....	3, 5, 6, 8, 10	BAYHTRM505BRK.....	39
A4020750.....	267	AFD175CLFR000C.....	122	BAYCCHT302RES.....	3, 5, 6, 8, 10	BAYHTRM508BRK.....	39
A4021116.....	267	AFD17DCLFR000C.....	122	BAYCLE17A1722A.....	41	BAYHTRM510BRK.....	39
A40.....	342	AFD210CLFR000C.....	122	BAYCLE21A2130A.....	41	BAYHZRT001A.....	49
A4133210.....	268	AFD21DCLFR000C.....	122	BAYCONV18A.....	41	BAYICSKIT01.....	29, 31, 32
A4143210.....	268	AFD245CLFR000C.....	122	BAYCONV23A.....	41	BAYISLT101.....	1
A42C.....	438	AH-12.....	361	BAYCONV27A.....	41	BAYSKT263.....	3, 5, 6, 8, 10
A42R.....	438	AHUMD200ABM00B.....	138	BAYCONV30A.....	41	BAYSKT266.....	3, 5, 8, 10
A4322020.....	267	AHUMD300ABA00B.....	138	BAYCOVR800A.....	102	BAYLEGS004.....	1, 7, 8, 10
A4322050.....	267	AHUMD500APA00A.....	138	BAYCURB026B.....	46, 50	BAYLEGS007.....	1, 3, 5, 6, 7, 8, 10
A4322075.....	267	AK14.....	438	BAYCURB027B.....	46, 49, 50	BAYLOAM103.....	3, 5, 6, 8, 10
A4332050.....	267	AK22.....	438	BAYCURB042A.....	45, 50	BAYLOAM107.....	3, 5, 8, 10
A4332075.....	267	AK24.....	438	BAYCURB043A.....	45, 50	BAYLPKT210B.....	18
A4332575.....	267	AM-101R-US-1.....	279	BAYCURB044A.....	50	BAYLPKT210C.....	25

Index by Model Number

BAYLPKT220B.....	18	BM-6839-10.....	76	CAP80+5-440.....	426	CNF-90-2.....	286
BAYLPSS210B.....	18, 25	BM-6898.....	78	CAP80-440.....	425	CNF-90-34.....	286
BAYLPSS220C.....	18	BM-9149.....	75	CB.....	355	CNF-90R-134.....	286
BAYLPSS400A.....	13	BM-9169.....	75	CC-125H.....	227	CNF-90R-3412.....	286
BAYLVKIT100.....	29, 32	BP900.....	244	CC-1.....	371	CNF-90ST-112.....	286
BAYLVKIT100A.....	31	BR085.....	271	CCB-150.....	225	CNF-90ST-114.....	286
BAYMFGH100A.....	18	BR100.....	103	CCLS-60.....	330	CNF-90ST-12.....	286
BAYMFGH200A.....	13	BR115.....	313	CCLV-60.....	330	CNF-90ST-1.....	286
BAYOSAH001A.....	44	BR120.....	313	CCLV-6.....	330	CNF-90ST-2.....	286
BAYOSAH002A.....	44	BR215.....	313	CD100A.....	325	CNF-90ST-34.....	286
BAYPLT01AMHCOA.....	138	BR220.....	313	CD42361R-D.....	437	CNF-BUSH-134.....	285
BAYPWRX029A.....	46	BR230.....	313	CD48421R-D.....	437	CNF-CAP-112.....	285
BAYRACK960A.....	18, 25	BR240.....	313	CDI-1-2005-3100.....	51	CNF-CAP-114.....	285
BAYRETFLGAA.....	29, 31, 32	BR24L70SP.....	314	CDI-1-2010-3105.....	51	CNF-CAP-12.....	285
BAYRETFLGBA.....	29, 31	BR250.....	313	CDI-1-2015-3105.....	51	CNF-CAP-1.....	285
BAYRETFLGCA.....	29, 31	BR260.....	313	CDI-1-3000-3100.....	51	CNF-CAP-34.....	285
BAYSEN01A.....	102	BRA8651.....	311	CDI-1-3000-3105.....	51	CNF-COUP-112.....	286
BAYSEN02A.....	102	BRA8652.....	311	CDI-1-3005-3105.....	51	CNF-COUP-114.....	286
BAYSENS077A.....	102	BRA8653.....	311	CDI-1-3010-3015.....	51	CNF-COUP-12.....	286
BAYSENS106A.....	160	BRA8654.....	311	CDI-1-3010-3105.....	51	CNF-COUP-1.....	286
BAYSENS108A.....	160	BRC-A41C.....	93	CDI-1-3015-3020.....	51	CNF-COUP-2.....	286
BAYSENS119A.....	160	BRC-A41E.....	93	CDI-1-3036-3100.....	51	CNF-COUP-34.....	286
BAYSFI185AAA.....	36	BRC-A41F.....	93	CDI-1-3100-3105.....	51	CNF-COUP-R-112114.....	286
BAYSFI235AAA.....	36	BRC-A41I.....	93	CDI-1-3500-3105.....	51	CNF-COUP-R-11212.....	286
BAYSFI265AAA.....	36	BRC-A42C.....	93	CDI-1-3505-3100.....	51	CNF-COUP-R-1121.....	286
BAYSPEKT200.....	29, 31	BRC-A42E.....	93	CDI-1-3510-3105.....	51	CNF-COUP-R-112.....	286
BAYSPEKT201A.....	36	BRC-A42F.....	93	CDI-1-3595-3105.....	51	CNF-COUP-R-11234.....	286
BAYSRKIT100.....	31, 32	BRC-A42I.....	93	CDI-1-4000-3100.....	51	CNF-COUP-R-11412.....	286
BAYSUPFLGAA.....	29, 31	BRC-ANS4C.....	304	CDI-1-4000-3105.....	51	CNF-COUP-R-1141.....	286
BAYSUPFLGBA.....	29, 31	BRC-ANS4E.....	304	CDI-1-4005-3105.....	51	CNF-COUP-R-11434.....	286
BAYSUPFLGCA.....	29, 31	BRC-ANS4F.....	304	CDI-1-4010-3020.....	51	CNF-COUP-R-134.....	286
BAYTEMDFKTIA1.....	36	BRC-ANS4I.....	304	CDI-1-4010-3105.....	51	CNF-COUP-R-2112.....	286
BAYVENT200B.....	13, 18	BTMCR.....	360	CDI-1-4500-3100.....	51	CNF-COUP-R-2114.....	286
BAYVENT500A.....	18	C130A.....	422	CDI-1-4505-3105.....	51	CNF-COUP-R-21.....	286
BAYVENT800B.....	25	C230A.....	422	CDI-1-4510-3100.....	51	CNF-COUP-R-234.....	286
BAYWAAA05SCIAA.....	29, 31	C240A.....	422	CDI-1-5005-3100.....	51	CNF-COUP-R-3412.....	286
BAYWABBO7SCIAA.....	29, 31	C240C.....	422	CDI-1-5005-3105.....	51	CNF-F-112.....	285
BAYWACC08SCIAA.....	29, 31	C330A.....	422	CDI-1-5010-3015.....	51	CNF-F-114.....	285
BAYWACCIISCI1AA.....	29, 31	C340A.....	422	CDI-1-5010-3105.....	51	CNF-F-12.....	285
BAYWAKIT24VAC.....	29	C340C.....	422	CDI-1-7540-3100.....	51	CNF-F-1.....	285
BCRMA3124-S001.....	64	C350A.....	422	CG10.....	344	CNF-F-2.....	285
BCRMA3124-S003.....	64	C5R.....	343	CH230.....	313	CNF-F-34.....	285
BCRMB6136-S001.....	64	C7089R1013.....	116	CHB-100.....	225	CNF-FR-1114.....	285
BCRMB6136-S003.....	64	C7189R1004.....	116	CHQ220.....	314	CNF-FR-1234.....	285
BCRMB9148-S001.....	64	CAP04-370.....	425	CHQ230.....	314	CNF-FR-134.....	285
BCRMB9148-S003.....	64	CAP05-370.....	425	CHQ240.....	314	CNF-FR-3412.....	285
BCRMC4160-S001.....	64	CAP05-440.....	425	CHW3610W 1001.....	113	CNF-FST-12.....	285
BCRMC4160-S003.....	64	CAP07.5-370.....	425	CHWE5 41013.....	113	CNF-FST-34.....	285
BH-10.....	365	CAP07.5-440.....	425	CK-100.....	241	CNF-M-112.....	285
BH-11.....	365	CAP10-370.....	425	CK-11.....	73	CNF-M-114.....	285
BH-8.....	365	CAP10-440.....	425	CL230.....	314	CNF-M-12.....	285
BH-9.....	365	CAP12.5-370.....	425	CL6-60Y.....	330	CNF-M-1.....	285
BHE10.....	355	CAP15-370.....	425	CLE-60B.....	330	CNF-M-2.....	285
BHE6.....	355	CAP20-370.....	425	CLE-60R.....	330	CNF-M-34.....	285
BKO-25408W.....	68	CAP25+5-370.....	426	CLE-60Y.....	330	CNF-MR-1114.....	285
BKO-2542W.....	68	CAP25-370.....	425	CLS-60B.....	330	CNF-MR-1141.....	285
BKO-2543W.....	68	CAP25-440.....	425	CLS-60R.....	330	CNF-MR-1234.....	285
BKO-2544W.....	68	CAP30+5-370.....	426	CLS-60Y.....	330	CNF-MR-134.....	285
BKO-2545W.....	68	CAP30+5-440.....	426	CLV-60B.....	330	CNF-MR-3412.....	285
BKO-2546W.....	68	CAP30-440.....	425	CLV-60R.....	330	CNF-MR-341.....	285
BKO-2548W.....	68	CAP35+5-370.....	426	CLV-60Y.....	330	CNF-T-112.....	287
BLO2.....	362	CAP35+5-440.....	426	CNF-45-112.....	286	CNF-T-114.....	287
BLO4.....	362	CAP35-370.....	425	CNF-45-114.....	286	CNF-T-12.....	287
BLO8.....	362	CAP35-440.....	425	CNF-45-12.....	286	CNF-T-1.....	287
BM-2535.....	75	CAP40+5-370.....	426	CNF-45-1.....	286	CNF-T-2.....	287
BM-2536.....	75	CAP40+5-440.....	426	CNF-45-2.....	286	CNF-T-34.....	287
BM-3001.....	75	CAP40+7.5-440.....	426	CNF-45-34.....	286	CNF-T-R-1112.....	287
BM-3002.....	75	CAP40-370.....	425	CNF-45ST-112.....	286	CNF-T-R-112112114.....	287
BM-3003.....	75	CAP40-440.....	425	CNF-45ST-114.....	286	CNF-T-R-11211212.....	287
BM-3004.....	75	CAP45+5-370.....	426	CNF-45ST-12.....	286	CNF-T-R-1121121.....	287
BM-3007.....	75	CAP45+5-440.....	426	CNF-45ST-1.....	286	CNF-T-R-11211234.....	287
BM-3008.....	76	CAP45+7.5-440.....	426	CNF-45ST-2.....	286	CNF-T-R-11212.....	287
BM-3020-KIT.....	76, 77	CAP45-370.....	425	CNF-45ST-34.....	286	CNF-T-R-1121.....	287
BM-3050-KIT.....	76, 77	CAP50+5-440.....	426	CNF-90-112.....	286	CNF-T-R-1121.....	287
BM-6808-10.....	76	CAP50+7.5-440.....	426	CNF-90-114.....	286	CNF-T-R-114114.....	287
BM-6809-10.....	76	CAP55+5-440.....	426	CNF-90-12.....	286	CNF-T-R-11411.....	287
BM-6818.....	75	CAP55-440.....	425	CNF-90-1.....	286	CNF-T-R-11411412.....	287
BM-6822.....	78	CAP60+5-440.....	426	CNF-90-14.....	286	CNF-T-R-1141141.....	287

Models and Specifications are Subject to Change Without Notice



Index by Model Number

CNF-T-R-11411434.....	287	CPF-CAP-12.....	287	D249-400SL.....	226	DV-T1.....	327
CNF-T-R-11412114.....	287	CPF-CAP-1.....	287	D249-500S.....	226	DV200N.....	322
CNF-T-R-114134.....	287	CPF-CAP-34.....	287	D249-500SL.....	226	DV22N.....	322
CNF-T-R-1143434.....	287	CPF-CLIP-12.....	287	D249-600S.....	226	DV40S.....	322
CNF-T-R-121234.....	287	CPF-CLIP-34.....	287	D249-600SL.....	226	DV41.....	322
CNF-T-R-1341.....	287	CPF-COUP-12.....	287	D249-700S.....	226	DV600.....	79
CNF-T-R-13434.....	287	CPF-COUP-1.....	287	D249-700SL.....	226	DVB-1.....	79
CNF-T-R-22112.....	287	CPF-COUP-34.....	287	D249-800S.....	226	DVC-35-SPPX-NAT.....	79
CNF-T-R-22114.....	287	CPF-COUP-R-134.....	287	D249-800SL.....	226	DVC-55-SPPX-NAT.....	79
CNF-T-R-2212.....	287	CPF-COUP-R-3412.....	287	D4120500.....	267	DVO-12.....	327
CNF-T-R-221.....	287	CPF-COUP-REP-12.....	287	D4120625.....	267	DVO-1.....	327
CNF-T-R-2234.....	287	CPF-COUP-REP-1.....	287	D4143275.....	268	DVO-24.....	327
CNF-T-R-341212.....	287	CPF-COUP-REP-34.....	287	D4153275.....	268	DVP-1.....	79
CNF-T-R-341234.....	287	CPF-F-12.....	287	D4511010.....	268	DVP-BEK2-1.....	439
CNF-T-R-343412.....	287	CPF-F-1.....	287	D4517575.....	268	DVP-FS.....	439
CNF-T-R-34341.....	287	CPF-F-34.....	287	D502-10.....	334	DVP-TRAP2.....	439
CNF-T-R-F-1112.....	287	CPF-FLEX-34-V.....	287	D504-10.....	334	DVP-TRAPK2.....	439
CNF-T-R-F-343412.....	287	CPF-FLEX-34.....	287	D504-10B.....	334	DVP-TV.....	439
CNF-UNION-114.....	287	CPF-FR-1234.....	287	D504-7.....	334	DVPI2.....	439
CNF-UNION-12.....	287	CPF-M-12.....	287	D506-4.....	335	DVPI2A.....	439
CNF-UNION-1.....	287	CPF-M-1.....	287	D507-10.....	335	DVP24.....	439
CNF-UNION-34.....	287	CPF-M-34.....	287	D507-6.....	335	DVP36.....	439
CO71A.....	318	CPF-MR-1234.....	287	D507-8.....	335	DVP4.....	439
COF-45LT-34.....	367	CPF-MR-134.....	287	D509-8.....	335	DVP45.....	439
COF-45ST-34.....	367	CPF-MR-341.....	287	DBF110.....	220	DVP48.....	439
COF-90LT-118-ST.....	367	CPF-T-12.....	287	DBX1000M-4.....	219	DVP6.....	439
COF-90LT-118.....	367	CPF-T-1.....	287	DBX1000M-6.....	219	DVP90ST.....	439
COF-90LT-12.....	367	CPF-T-34.....	287	DCA329S.....	432	DWF1548.....	209
COF-90LT-1.....	367	CPF-T-R-1134.....	287	DCB-125.....	224	DWF2248-R6.....	209
COF-90LT-138.....	367	CPF-T-R-341212.....	287	DCC-150.....	224	DWF348-R8.....	209
COF-90LT-34-ST.....	367	CPF-T-R-341234.....	287	DDM55.....	323	DXL-100.....	222
COF-90LT-34.....	367	CPF-T-R-343412.....	287	DDS-30.....	316	DXL-125.....	222
COF-90LT-38-ST.....	367	CPF-VAL-12.....	287	DDS-60.....	91, 316	DXL-150.....	222
COF-90LT-38.....	367	CPF-VAL-1.....	287	DDS-60U.....	91, 316	DXL-170.....	222
COF-90LT-58-ST.....	367	CPF-VAL-34.....	287	DDTH-18.....	354	DXL-200.....	222
COF-90LT-58.....	367	CPG41838-U.....	80	DG115EZIAQ.....	162	DXL-50.....	222
COF-90LT-78-ST.....	367	CPG41851-C.....	80	DGAA056BDTD.....	83	DXL-75.....	222
COF-90LT-78.....	367	CPG42438-C.....	80	DGAA070BDTD.....	83	E-750-8.....	271
COF-BU-3458.....	366	CPG42451-C.....	80	DGAA077BDTD.....	83	E3-R5e3PK2-01.....	120
COF-BU-3814.....	366	CPG42464-U.....	80	DGAA090BDTD.....	83	E6050010.....	269
COF-BU-E-11878.....	366	CPG43051-C.....	80	DH16.....	93	E6062000.....	269
COF-BU-E-138118.....	366	CPG43064-C.....	80	DH16S.....	93	E6090005.....	268
COF-BU-E-3458.....	366	CPL-012X10.....	285	DIE012CXFE.....	283	E6122000.....	265
COF-BU-E-7834.....	366	CPL-034X10.....	285	DIE034CXFE.....	283	EAG4.....	202
COF-BU-E-7858.....	366	CPL-100X10.....	285	DIE034CXM.....	283	EAG6.....	202
COF-BU-I-1258.....	366	CPM-012X10.....	285	DIE100CXFE.....	283	EAG8.....	202
COF-CO-12.....	367	CPM-034X10.....	285	DIE112CXFE.....	283	EARD6TZ.....	155
COF-CO-14.....	367	CPM-100X10.....	285	DIE114CXFE.....	283	ECNR15.....	315
COF-CO-34.....	367	CPM-112X10.....	285	DK06.....	339	ECNR20.....	315
COF-CO-38.....	367	CPM-114X10.....	285	DKVLT-100.....	221	ECNR25.....	315
COF-CO-516.....	367	CPM-200X10.....	285	DKVLT-150.....	221	ECNR30.....	315
COF-CR-11834.....	367	CPRI0/U.....	165	DKVLT-200.....	221	ECNR35.....	315
COF-CR-1238.....	367	CPRI2.....	165	DL389.....	317	ECNR40.....	315
COF-CR-3438.....	367	CPRI4.....	165	DL479.....	317	ECNR45.....	315
COF-CR-3458.....	367	CPR8.....	165	DM1036.....	438	ECNR50.....	315
COF-CR-3814.....	367	CPRD10/U.....	163	DM1036S.....	438	ECNR60.....	315
COF-CR-38516.....	367	CPRD12/U.....	163	DM1042.....	438	EDF1.....	156
COF-CR-5812.....	367	CPRD14/U.....	163	DM1042S.....	438	EDG-P1000-14X25X1.....	132
COF-CR-5838.....	367	CPRD8.....	163	DM1242.....	438	EDG-P1000-14X30X1.....	132
COF-CR-7834.....	367	CPWS.....	80	DM1736.....	438	EDG-P1000-14X36X1.....	132
CONNEXT2.....	346	CSA-1.....	440	DM1742.....	438	EDG-P1000-16X20X1.....	132
CONNEXT4.....	346	CT35.....	439	DM8042.....	438	EDG-P1000-16X25X1.....	132
CP-16.....	370	CVENT-2.....	200	DMG2-5.....	328	EDG-P1000-20X20X1.....	132
CP-22.....	370	CVENT-3.....	200	DMSRV1136.....	438	EDG-P1000-20X25X1.....	132
CPA-012X20.....	366	D10436.....	327	DR65A3000.....	151	EL1838-3.....	91
CPA-034X20.....	366	DI140750.....	264	DRB-1.....	79	EL2424-3.....	362
CPA-038X20.....	366	D1220500.....	264	DRFB1250.....	269	EL2448-3.....	91
CPA-058X20.....	366	D1250500.....	264	DS-20000.....	99	EL3030-2.....	362
CPA-078X20.....	366	D203-6.....	334	DS-20000S.....	99	EL3030-3.....	362
CPA-118X20.....	366	D203-8.....	334	DS1.....	344	EL3036-2.....	362
CPA-138X20.....	366	D213-9NE.....	334	DS2.....	344	EL3232-3.....	362
CPE41815-C.....	80	D228-8.....	334	DTH35.....	324	EL3636-2.....	362
CPE42410-C.....	80	D248-8.....	334	DTK2.....	324	EL3636-3.....	362
CPE42415-C.....	80	D249-1000SL.....	226	DV-215-SGX-NAT.....	79	EL3640-2.....	362
CPF-90-12.....	287	D249-1200SL.....	226	DV-25-SG-NAT.....	79	EL3640-3.....	362
CPF-90-1.....	287	D249-300S.....	226	DV-35-SG-NAT.....	79	EL36.....	438
CPF-90-34.....	287	D249-300SL.....	226	DV-4E.....	327	EL3842-3.....	362
CPF-90R-3412.....	287	D249-400S.....	226	DV-6E.....	327	EL42.....	438

Index by Model Number

EM201SPKIT.....	318	FGP-SP-050.....	306	FLT20X25X1.....	133	GBC048A3EMA0000.....	48
ERM 5220 R1018.....	111	FGP-SP-100.....	306	FLT20x25x2-PLEAT.....	133	GBC048A4EMA0000.....	48
ESP-2430JH4.....	74	FGP-WBTM-500.....	306	FLT20X25X2.....	134	GBC060A3EMA0000.....	48
ESP-2430JV4M.....	74	FHA-300-1816.....	365	FLT20x25x5-PLEAT.....	133	GBC060A4EMA0000.....	48
ESP-3642JH4.....	74	FIL052S.....	424	FLT20X30X1-PLEAT.....	133	GCLK.....	168
ESP-3642JV4M.....	74	FIL083S.....	424	FLT20X30X1.....	133	GD00Z-3.....	106
ESP-4860JH4.....	74	FIL083SBF.....	424	FLT20x30x2-PLEAT.....	133	GDST4336IFT.....	437
ESP-4860JV4M.....	74	FIL163S.....	424	FLT20X30X2.....	134	GEN II.....	167
ESP-NT02.....	200	FIL163SBF.....	424	FLT20x35x2.....	133	GFFM-KDIZUS-001.....	281
ET05.....	319, 325	FIL164S.....	424	FLT24X24X1.....	133	GFFM-KDIZUS-002.....	281
ET510.....	320	FIL165S.....	424	FLT24x24x2-PLEAT.....	133	GFFM-MCOZUS-001.....	281
EVE/6.....	219	FIL166S.....	424	FLT24X24X2.....	134	GFFM-MSOZUS-001.....	281
EZ-4/ECS.....	373	FIL167S.....	424	FLT24x24x4-PLEAT.....	133	GFK160B.....	438
EZT-113.....	92	FIL305S.....	424	FLT24X25X1.....	133	GFK4B.....	438
EZT-113B.....	92	FIL306S.....	424	FLT25X25X1.....	133	GG-1.....	372
EZT-150.....	92	FIL307S.....	424	FLT30x36x2-PLEAT.....	133	GGC-12.....	372
EZT-210.....	92	FIL309S.....	424	FLT9x11-3/8x1.....	133	GPAK-1.....	220
EZT-626.....	92	FK23.....	438	FOAN-45.....	66	GPS-2400-1.....	135
F-1.....	360	FLRSF1185.....	36	FR110.....	220	GPS-2400-3.....	135
F100F1620/U.....	126	FLRSF1235.....	36	FR150.....	220	GPS-ICLEAN.....	135
F100F1625/U.....	126	FLRSF1265.....	36	FR8000F1625.....	127	GS-2/ECS.....	373
F100F2020/U.....	126	FLT10X20X1.....	133	FR8000F2025.....	127	GS-3/ECS.....	373
F100F2025/U.....	126	FLT10X24X1.....	133	FS338.....	439	GT-1.....	377
F19-0097.....	253	FLT10X25X1.....	133	FSAN-30.....	66	GT151-1.....	377
F19-0104.....	253	FLT12X12X1.....	133	FSAN-45.....	66	GT151-5.....	377
F200F1625/U.....	126	FLT12X20X1.....	133	FSAN-60.....	66	GT35-5.....	377
F200F2025/U.....	126	FLT12X24X1.....	133	FSAN-75.....	66	GVD-5PL.....	258
F300E1001.....	125	FLT12X24X2-PLEAT.....	133	FSAP-45.....	66	GVD-6PL.....	258
F300E1019.....	125	FLT12X24X2.....	134	FSAP-75.....	66	GVD-7PL.....	258
F300E1035.....	125	FLT12X25X1.....	133	FSC10.....	404	GVD-8PL.....	258
F39807.....	242	FLT14X14X1.....	133	FSKEY.....	321	GVD-RMA-PL.....	258
F6-DP.....	326	FLT14x20x1-PLEAT.....	133	G01A-332.....	418	GVD-UWK.....	258
F61-2689.....	117	FLT14X20X1.....	133	G100-200.....	278	H1-10.....	243
F7050750.....	268	FLT14X20X2-PLEAT.....	133	G100-80.....	278	H1-12.....	243
F7051258.....	268	FLT14X20X2.....	134	G109.....	132	H1-8.....	243
FALTS-57C-05T-120-A.....	409	FLT14X24X1.....	133	G37-200.....	278	H25-1.....	248
FAN 5ACC06SC.....	214	FLT14X25X1-PLEAT.....	133	G75-125.....	278	H25-2.....	248
FAN 5ACC17FT.....	214	FLT14X25X1.....	133	G75-75N.....	278	H25-3.....	248
FAN 5ACC20FT.....	214	FLT14X25X2-PLEAT.....	133	G76-200.....	278	H25-90.....	248
FAN 5ACC24FS.....	214	FLT14X25X2.....	134	G82-156.....	278	H25-92.....	248
FAN 5DDD085A 8".....	214	FLT14X30X1.....	133	GA4238.....	149	H25.....	248
FAN 5DDD10AA 10".....	214	FLT15X20X1.....	133	GA50.....	148	H6-10.....	243
FAN 5DDD12CA 12".....	214	FLT15X20X2-PLEAT.....	133	GAC180A3EMA0000.....	49	H6062A1000/U.....	140
FAN 5DDD13DB 13".....	214	FLT15X20X2.....	134	GAC180A4EMA0000.....	49	H8908ASPST.....	140
FAN 5DDD16DB 16".....	214	FLT16X16X1.....	133	GAC210A3EMA0000.....	49	H8908DSPST.....	151
FAN 5DDD18EB 18".....	214	FLT16X16X2-PLEAT.....	133	GAC210A4EMA0000.....	49	HCI.....	355
FASF55.....	435	FLT16X16X2.....	134	GAC240A3EMA0000.....	49	HCIB.....	355
FAW-40-SPPX.....	79	FLT16X20X1-PLEAT.....	133	GAC240A4EMA0000.....	49	HC22A1007.....	141
FAW-55-SPPX-NA.....	79	FLT16X20X1.....	133	GAC300A3EMA0000.....	49	HC22E1003.....	141
FC100A1003.....	127	FLT16X20X2-PLEAT.....	133	GAC300A4EMA0000.....	49	HC26A1008.....	141
FC100A1011.....	127	FLT16X20X2.....	134	GAF2A0A18S11.....	34	HC26E1004.....	141
FC100A1029.....	127	FLT16x20x4-PLEAT.....	133	GAF2A0A18S11EE.....	32	HD1.....	346
FC100A1037.....	127	FLT16X22X1.....	133	GAF2A0A24S21.....	34	HD2.....	346
FC200E1029.....	127	FLT16X24X1.....	133	GAF2A0A24S21EE.....	32	HD3.....	346
FC200E1037.....	127	FLT16X24X2-PLEAT.....	133	GAF2A0A30S21.....	34	HD5.....	346
FCR6.....	359	FLT16X24X2.....	134	GAF2A0A30S21EE.....	32	HE100A1000.....	140
FDC1.....	344	FLT16X25X1-PLEAT.....	133	GAF2A0A36M31.....	34	HE105A1000/U.....	139
FDC2.....	344	FLT16X25X1.....	133	GAF2A0A36M31EC.....	32	HE150A1005.....	140
FER22.....	294	FLT16X25X2-PLEAT.....	133	GAF2A0A36S31.....	34	HE1K142D210B.....	61
FER33.....	294	FLT16X25X2.....	134	GAF2A0A36S31EE.....	32	HE1K642A155.....	62
FER64.....	294	FLT16x25x4-PLEAT.....	133	GAF2A0A36S3A.....	34	HE1K642A170.....	62
FER66.....	294	FLT17-1/8X26-1/8X1.....	134	GAM5B0A18M11.....	30	HE1K642A200.....	62
FER66CC.....	294	FLT18X18X1.....	133	GAM5B0A18M11EA.....	30	HE200A1000.....	140
FF-75.....	355	FLT18X18X2.....	134	GAM5B0A24M21.....	34	HE205A1000/U.....	139
FG10XL.....	220	FLT18X20X1.....	133	GAM5B0A24M21EA.....	30	HE250A1005.....	140
FG8.....	220	FLT18X24X2-PLEAT.....	133	GAM5B0B30M21.....	34	HE2K148A200.....	62
FGM599S.....	432	FLT18X24X2.....	134	GAM5B0B30M21EA.....	30	HE2K148D210B.....	61
FGN651T.....	428	FLT18X25X1.....	133	GAM5B0B36M31.....	34	HE2K648A170.....	62
FGN652T.....	428	FLT20X20X1-PLEAT.....	133	GAM5B0B36M31EA.....	30	HE2K648A200.....	62
FGP-BFF-500.....	306	FLT20X20X1.....	133	GAM5B0C42M31.....	34	HE300A1005.....	140
FGP-CPLG-1000.....	306	FLT20X20X2-PLEAT.....	133	GAM5B0C42M31EA.....	30	HE30124A130.....	62
FGP-CPLG-500.....	306	FLT20X20X2.....	134	GAM5B0C48M41.....	34	HE30624A130.....	62
FGP-CS-100-50.....	306	FLT20X22X1-PLEAT.....	133	GAM5B0C48M41EA.....	30	HE31130A130.....	62
FGP-CS-500-100.....	306	FLT20X22X1.....	133	GAM5B0C60M51.....	34	HE32136A155.....	62
FGP-FST-500.....	306	FLT20X24X1.....	133	GAM5B0C60M51EA.....	30	HE32136A170.....	62
FGP-SFST-1000.....	306	FLT20X24X2-PLEAT.....	133	GBAP4-K100.....	386	HE32136D145B.....	61
FGP-SFST-500.....	306	FLT20X24X2.....	134	GBC036A3EMA0000.....	48	HE32136D175B.....	61
FGP-SP-025.....	306	FLT20X25X1-PLEAT.....	133	GBC036A4EMA0000.....	48	HE32630A130.....	62

Models and Specifications are Subject to Change Without Notice



Index by Model Number

HE32636A140.....	62	IBF-90-34.....	298	IBF-PLUG-112.....	298	IBN114X2.....	302
HE32636A155.....	62	IBF-90R-112114.....	298	IBF-PLUG-114.....	298	IBN114X24.....	302
HE32636A170.....	62	IBF-90R-1121.....	298	IBF-PLUG-12.....	298	IBN114X30.....	302
HE33636A155.....	62	IBF-90R-112.....	298	IBF-PLUG-1.....	298	IBN114X312.....	302
HE33636A170.....	62	IBF-90R-11412.....	298	IBF-PLUG-2.....	298	IBN114X3.....	302
HE36636A155.....	62	IBF-90R-1141.....	298	IBF-PLUG-34.....	298	IBN114X36.....	302
HE36636A170.....	62	IBF-90R-11434.....	298	IBF-PLUG-4.....	298	IBN114X412.....	302
HE46660A235.....	62	IBF-90R-134.....	298	IBF-T-112.....	299	IBN114X4.....	302
HE48160A200.....	62	IBF-90R-2112.....	298	IBF-T-114.....	299	IBN114X48.....	302
HE48160D210B.....	61	IBF-90R-2114.....	298	IBF-T-12.....	299	IBN114X512.....	302
HE48160D245B.....	61	IBF-90R-3412.....	298	IBF-T-1.....	299	IBN114X5.....	302
HE48660A200.....	62	IBF-90ST-112.....	298	IBF-T-212.....	299	IBN114X60.....	302
HE49660A205.....	62	IBF-90ST-114.....	298	IBF-T-2.....	299	IBN114X6.....	302
HEASIM-3630.....	437	IBF-90ST-12.....	298	IBF-T-3.....	299	IBN114X7.....	302
HEASIM-3933.....	437	IBF-90ST-1.....	298	IBF-T-34.....	299	IBN114X8.....	302
HEASIM-4236.....	437	IBF-90ST-2.....	298	IBF-T-R-1112.....	299	IBN114X9.....	302
HEASIM-4842.....	437	IBF-90ST-34.....	298	IBF-T-R-112112114.....	299	IBN114XCL.....	302
HH58636A225.....	63	IBF-BUSH-112114.....	297	IBF-T-R-11211212.....	299	IBN12X10.....	301
HH60660A305.....	63	IBF-BUSH-11212.....	297	IBF-T-R-1121121.....	299	IBN12X112.....	301
HHD1.....	346	IBF-BUSH-1121.....	297	IBF-T-R-11211234.....	299	IBN12X11.....	301
HHD2.....	346	IBF-BUSH-112.....	297	IBF-T-R-11212.....	299	IBN12X12.....	301
HK10.....	271	IBF-BUSH-11234.....	297	IBF-T-R-1121.....	299	IBN12X18.....	301
HM750A1000/U.....	139	IBF-BUSH-11412.....	297	IBF-T-R-11234112.....	299	IBN12X212.....	301
HP3636-8.....	362	IBF-BUSH-1141.....	297	IBF-T-R-1134.....	299	IBN12X2.....	301
HS10001.....	375	IBF-BUSH-11434.....	297	IBF-T-R-1141114.....	299	IBN12X24.....	301
HS10004.....	375	IBF-BUSH-1214.....	297	IBF-T-R-11411.....	299	IBN12X30.....	301
HS10016.....	375	IBF-BUSH-1218.....	297	IBF-T-R-11411412.....	299	IBN12X312.....	301
HS24A341.....	422	IBF-BUSH-1238.....	297	IBF-T-R-1141141.....	299	IBN12X3.....	301
HS24A3414.....	423	IBF-BUSH-134.....	297	IBF-T-R-11411434.....	299	IBN12X36.....	301
HS24A342.....	422	IBF-BUSH-2112.....	297	IBF-T-R-11412114.....	299	IBN12X412.....	301
HS24A343.....	423	IBF-BUSH-2114.....	297	IBF-T-R-114134.....	299	IBN12X4.....	301
HS24A344.....	423	IBF-BUSH-212112.....	297	IBF-T-R-11434114.....	299	IBN12X48.....	301
HS24A345.....	423	IBF-BUSH-212114.....	297	IBF-T-R-114341.....	299	IBN12X512.....	301
HS24A346.....	423	IBF-BUSH-2122.....	297	IBF-T-R-1143434.....	299	IBN12X5.....	301
HS33247.....	422	IBF-BUSH-212.....	297	IBF-T-R-1234.....	299	IBN12X60.....	301
HS5.....	436	IBF-BUSH-21.....	297	IBF-T-R-13412.....	299	IBN12X6.....	301
HS6.....	436	IBF-BUSH-234.....	297	IBF-T-R-1341.....	299	IBN12X7.....	301
HS8.....	436	IBF-BUSH-3114.....	297	IBF-T-R-13434.....	299	IBN12X8.....	301
HTX15.....	244	IBF-BUSH-32.....	297	IBF-T-R-22112.....	299	IBN12X9.....	301
HTX30.....	244	IBF-BUSH-3412.....	297	IBF-T-R-22114.....	299	IBN12XCL.....	301
HTX60.....	244	IBF-BUSH-3414.....	297	IBF-T-R-2212.....	299	IBN1X10.....	301
HTX90.....	244	IBF-BUSH-3418.....	297	IBF-T-R-221.....	299	IBN1X11.....	301
HUH524TA.....	69	IBF-BUSH-42.....	297	IBF-T-R-2234.....	299	IBN1X12.....	301
HVBB48075.....	209	IBF-BUSH-43.....	297	IBF-T-R-341212.....	299	IBN1X18.....	301
HVBB48125.....	209	IBF-CAP-112.....	297	IBF-T-R-341234.....	299	IBN1X212.....	301
HVENT-2.....	200	IBF-CAP-114.....	297	IBF-T-R-343412.....	299	IBN1X2.....	301
HV NFI.....	233	IBF-CAP-12.....	297	IBF-UNION-112.....	300	IBN1X24.....	301
HVPB48125G.....	209	IBF-CAP-1.....	297	IBF-UNION-114.....	300	IBN1X30.....	301
HVSPACER.....	209	IBF-CAP-2.....	297	IBF-UNION-12.....	300	IBN1X312.....	301
HVST1610003.....	209	IBF-CAP-3.....	297	IBF-UNION-1.....	300	IBN1X3.....	301
HW7x1/2Z.....	384	IBF-CAP-34.....	297	IBF-UNION-212.....	299	IBN1X36.....	301
HW7x1/2ZT.....	384	IBF-COUP-112.....	297	IBF-UNION-2.....	300	IBN1X412.....	301
HW8X11/2ZWT.....	384	IBF-COUP-114.....	297	IBF-UNION-34.....	300	IBN1X4.....	301
HYBYL.....	404	IBF-COUP-12.....	297	IBN112X10.....	302	IBN1X48.....	301
HZ311.....	161	IBF-COUP-1.....	297	IBN112X11.....	302	IBN1X512.....	301
HZ311K.....	161	IBF-COUP-212.....	297	IBN112X12.....	302	IBN1X5.....	301
HZ322.....	161	IBF-COUP-2.....	297	IBN112X212.....	302	IBN1X60.....	301
HZ322K.....	161	IBF-COUP-34.....	297	IBN112X2.....	302	IBN1X6.....	301
HZ432.....	160	IBF-COUP-4.....	297	IBN112X24.....	302	IBN1X7.....	301
HZ432K.....	160	IBF-COUP-R-112114.....	298	IBN112X312.....	302	IBN1X8.....	301
IBF-45-112.....	297	IBF-COUP-R-11212.....	298	IBN112X3.....	302	IBN1X9.....	301
IBF-45-114.....	297	IBF-COUP-R-1121.....	298	IBN112X36.....	302	IBN1XCL.....	301
IBF-45-12.....	297	IBF-COUP-R-112.....	298	IBN112X412.....	302	IBN212X10.....	302
IBF-45-1.....	297	IBF-COUP-R-11234.....	298	IBN112X4.....	302	IBN212X12.....	302
IBF-45-2.....	297	IBF-COUP-R-11412.....	298	IBN112X48.....	302	IBN212X3.....	302
IBF-45-3.....	297	IBF-COUP-R-1141.....	298	IBN112X512.....	302	IBN212X412.....	302
IBF-45-34.....	297	IBF-COUP-R-11434.....	298	IBN112X5.....	302	IBN212X4.....	302
IBF-45ST-114.....	297	IBF-COUP-R-1238.....	298	IBN112X60.....	302	IBN212X512.....	302
IBF-45ST-12.....	297	IBF-COUP-R-134.....	298	IBN112X6.....	302	IBN212X5.....	302
IBF-45ST-1.....	297	IBF-COUP-R-2112.....	298	IBN112X7.....	302	IBN212X6.....	302
IBF-45ST-34.....	297	IBF-COUP-R-2114.....	298	IBN112X8.....	302	IBN212XCL.....	302
IBF-90-112.....	298	IBF-COUP-R-212112.....	298	IBN112X9.....	302	IBN2X10.....	302
IBF-90-114.....	298	IBF-COUP-R-2122.....	298	IBN112XCL.....	302	IBN2X11.....	302
IBF-90-12.....	298	IBF-COUP-R-21.....	298	IBN114X10.....	302	IBN2X12.....	302
IBF-90-1.....	298	IBF-COUP-R-234.....	298	IBN114X11.....	302	IBN2X18.....	302
IBF-90-212.....	298	IBF-COUP-R-3114.....	298	IBN114X12.....	302	IBN2X212.....	302
IBF-90-2.....	298	IBF-COUP-R-32.....	298	IBN114X18.....	302	IBN2X24.....	302
IBF-90-3.....	298	IBF-COUP-R-3412.....	298	IBN114X212.....	302	IBN2X312.....	302

Index by Model Number

IBN2X3	302	ICM517	421	L4079B1033	410	M2007	341
IBN2X36	302	IGF-45-34	303	L59-3B-A	409	M30E311	63, 83
IBN2X412	302	IGF-90-12	303	L59-7B-A	409	M36E221	63, 83
IBN2X4	302	IGF-90-34	303	L6006A1145	261	M42E341	63, 83
IBN2X48	302	IGF-BUSH-3412	303	L6006C1018	261	M4AC3018B1000N	55
IBN2X512	302	IGF-CAP-112	303	L8148A1017	262	M4AC3024B1000N	55
IBN2X5	302	IGF-CAP-34	303	L8148E1265	262	M4AC3030B1000N	55
IBN2X60	302	IGF-COUP-34	303	L8148J1009	262	M4AC3036B1000N	55
IBN2X6	302	IGF-COUP-R-134	303	L9M	345	M4AC3042B1000N	55
IBN2X7	302	IGF-COUP-R-3412	303	LCD-8	258	M4AC3048B1000N	55
IBN2X8	302	IGF-PLUG-112	303	LCI122W	98	M4AC3060B1000N	55
IBN2X9	302	IGF-PLUG-12	303	LCI92W	98	M4MHW1509A1NOA	89
IBN2XCL	302	IGF-PLUG-2	303	LCOI22W	98	M4MHW1512A1NOA	89
IBN34X10	301	IGF-PLUG-34	303	LCO92W	98	M4MHW1518A1NOA	89
IBN34X112	301	IGF-T-34	303	LD122B	97	M4MHW1524A1NOA	89
IBN34X11	301	IGF-UNION-12	303	LD122W	97	M4MHW2209A9NOA	89
IBN34X12	301	IGF-UNION-34	303	LD3000	373	M4MHW2212A9NOA	89
IBN34X18	301	IGN12X212	304	LD5000	373	M4PG4024A1060A	59
IBN34X212	301	IGN12X2	304	LD92B	97	M4PG4030A1060A	59
IBN34X2	301	IGN12X312	304	LD92W	97	M4PG4036A1090A	59
IBN34X24	301	IGN12X3	304	LDC4000	373	M4PG4042A1090A	59
IBN34X30	301	IGN12X412	304	LENI22W	98	M4PG4048A1090A	59
IBN34X312	301	IGN1X212	304	LEN92B	98	M4PG4060A1130A	59
IBN34X3	301	IGN1X212	304	LEN92W	98	M4THS1509A11NA	89
IBN34X36	301	IGN1X312	304	LEVI451-I	309	M4THS1512A11NA	89
IBN34X412	301	IGN1X3	304	LEV5320-I	309	M4THS1518A11NA	89
IBN34X4	301	IGN34X10	304	LEVGFTR2-HFW	309	M4THS1524A11NA	89
IBN34X48	301	IGN34X112	304	LEVGFTR2-I	309	M4THS2209A91NA	89
IBN34X512	301	IGN34X12	304	LF-1504/HBB1504	68	M4THS2212A91NA	89
IBN34X5	301	IGN34X212	304	LF4505075	266	M80IP040AU24AA	58
IBN34X60	301	IGN34X2	304	LF4507575	266	M80IP060AD24AA	58
IBN34X6	301	IGN34X312	304	LF4511010	266	M80IP060AD36AA	58
IBN34X7	301	IGN34X3	304	LF4515050	266	M80IP060AU24AA	58
IBN34X8	301	IGN34X412	304	LF4515075	266	M80IP060AU36AA	58
IBN34X9	301	IGN34X4	304	LF4517575	266	M80IP080BD45AA	58
IBN34XCL	301	IGN34X512	304	LF4527575	266	M80IP080BU36AA	58
IBN38X212	301	IGN34X5	304	LF4545050	266	M80IP080BU48AA	58
IBN38X2	301	IGN34X6	304	LF4547575	266	M80IP100BU36AA	58
IBN38XCL	301	IGN34X7	304	LF4805050	266	M80IP100CD48AA	58
IBN3X12	302	IGN34X8	304	LF5632020	266	M80IP100CD60AA	58
IBN3X3	302	IGN34X9	304	LFT2/HBBT2	68	M80IP100CU48AA	58
IBN3X412	302	IGN34XCL	304	LGS4075	432	M80IP100CU60AA	58
IBN3X4	302	INF195	325	LJ122W	97	M80IP120DD60AA	58
IBN3X5	302	IRB43	219	LJ92B	97	M80IP120DU60AA	58
IBN3X6	302	J1005	334	LJ92W	97	M80IP140DD60AA	58
IBN3XCL	302	J207-8CR	334	LK122W	98	M80IP140DU60AA	58
IBN4X4	302	J2100L	339	LK92B	98	M847D-VENT/U	165
IBN4X5	302	J2101R	339	LK92W	98	M847D-ZONE	165
IBN4XCL	302	JCA325S	432	LKF122W	98	M847D1012	165
IBP-012X10FT	296	JGN653T	428	LKF92B	98	M95IP040BD24AA	57
IBP-034X10FT	296	JGN654T	428	LKF92W	98	M95IP040BU24AA	57
IBP-100X10FT	296	JVS100N	228	LMPHGXI105	137	M95IP060BU36AA	57
IBP-112X10FT	296	JVS125N	228	LMPRGPT160T5	137	M95IP065BD42AA	57
IBP-114X10FT	296	JVS160N	228	LP92B	98	M95IP080BU42AB	57
IBP-200X10FT	296	JVS225N	228	LP92W	98	M95IP085CD48AA	57
IBP-212X10FT	296	JVS50N	228	LS-DW-2-50-L-464	231	M95IP100CU48AA	57
IBP-300X10FT	296	JVS75N	228	LS-DW-2-65-L-464	231	M95IP100DU60AA	57
IBPD-012X10FT	296	K120	271	LS-DW-2-80-L	231	M95IP110DD60AA	57
IBPD-100X10FT	296	K12055	335	LT122W	98	M95IP120DU60AA	57
ICM270	399	K42	271	LT92W	98	M952V060BD36AB	57
ICM271C	399	K84	271	LW122W	97	M952V060BU36AB	57
ICM275	399	L-1	360	LW92B	97	M952V080BD36AA	57
ICM280	399	L100	216	LW92W	97	M952V080BU36AB	57
ICM2804	399	L100XL	282	M099 25#	383	M952V100CD48AA	57
ICM2805A	399	L1240	350	M14N	342	M952V100CU48AB	57
ICM2810	399	L1320	350	M14RB	342	M952V120DD60AA	57
ICM281	399	L1407	350	M2-250	329	M952V120DU60AB	57
ICM282A	399	L1411	350	M2-460	329	MA-0360	386
ICM283	399	L150	216	M2-465	329	MA-0363	386
ICM286	399	L1681	350	M2-500	329	MA-0620	349
ICM289	399	L200	216	M2-8-410A	328	MA-12355A	322
ICM2902	399	L300	216	M2-820	329	MA-12815A	320
ICM290A	399	L400	216	M2-825	329	MA-12817B	318
ICM291	399	L4006E1067	260	M2001	341	MA-12822A	319
ICM292	399	L4006H1004	260	M2002	341	MA-12826A	319
ICM295	399	L4064B2210	411	M2004	341	MA-12838A	322
ICM326HN	421	L4064B2228	411	M2005	341	MA-12843B	323
ICM401	421	L4064B2236	411	M2006	341	MA-142A	348

Models and Specifications are Subject to Change Without Notice



Index by Model Number

MA-142MA.....	348	MSH1/4.....	355	P6900R.....	347	POPUP2400.....	127
MA-143A.....	348	MSH3/8.....	355	P90022.....	330	PPF-45-012.....	293
MA-143M.....	348	MSH5/16.....	355	P90513.....	332	PPF-45-034.....	293
MA-149.....	348	MSHC.....	346	PA-110.....	227	PPF-45-100.....	293
MA-157A.....	348	MSHL1/4.....	355	PA-155.....	227	PPF-90-012.....	292
MA-159A.....	348	MSHL5/16.....	355	PA-175.....	227	PPF-90-034.....	292
MA-16509B.....	325	MSHML1/4.....	355	PA-250.....	227	PPF-90-100.....	292
MA-16531B.....	323	MSHML5/16.....	355	PA-299.....	227	PPF-90F-034.....	292
MA-1665B.....	284	MSHXL1/4.....	355	PA-399.....	227	PPF-90M-034.....	293
MA-33C.....	318	MSHXL5/16.....	355	PA-800-RX2.....	258	PPF-90S-012.....	292
MA-49310.....	348	MSTC52.....	365	PA-80.....	227	PPF-90S-034.....	292
MA-49316.....	348	MSTN.....	165	PC200M.....	291	PPF-90S-100.....	292
MA-49318.....	348	MTISRKIT16202.....	29, 31	PC600-2.....	288	PPF-BUSH-1X34.....	293
MA-49858A.....	320	MTISRKIT1620.....	32	PC600DS.....	288	PPF-BUSH-3412.....	293
MA-600CF.....	319	MZV520-RP.....	252	PC600R.....	288	PPF-CAP-034.....	293
MA-69523.....	322	N1R.....	343	PC603.....	288	PPF-COUP-012.....	293
MA-748325A.....	349	N2R.....	343	PC604.....	288	PPF-COUP-034.....	293
MA-8206.....	320	NA10056.....	248	PC606-2.....	288	PPF-COUP-100.....	293
MA-9358.....	347	NBF-22.....	235	PC606.....	288	PPF-COUP-34X12.....	293
MA-AF2000-M.....	333	NBV4236I-B.....	437	PC607-2.....	289	PPF-COUP-R 212X2.....	293
MA-AN84.....	322	NBV4842I-B.....	437	PC607-3.....	289	PPF-FEM-034.....	293
MA-API32.....	349	NC1103US.....	121	PC607.....	289	PPF-MALE-034.....	293
MA-AP8SD.....	347	NC2100ES.....	121	PC611.....	289	PPF-MALE-100.....	293
MA-AT14-5.....	408	NCB-180E.....	229	PC612.....	290	PPF-PLUG-034.....	294
MA-AT18-5.....	408	NCB-210E.....	229	PC617.....	290	PPF-PTRAP-034.....	294
MA-DMT3.....	319	NCB-240E.....	229	PC633-4.....	290	PPF-T-R-34X12.....	292
MA-FB2.....	349	NCPE-418-1010.....	81	PC633.....	290	PPF-T-R-3X3X34FPT.....	292
MA-FL3A.....	349	NCPE-418-3010.....	81	PC712.....	290	PPF-TEE-034.....	292
MA-FL3BUV.....	349	NCPE-424-1010.....	81	PC733-4.....	290	PPF-TEE-100.....	292
MA-FM554A.....	435	NCPE-424-3010.....	81	PC733.....	290	PPF-UNION-034.....	294
MA-IM24.....	348	NCPE-430-1010.....	81	PCBK-L.....	387	PPS-PAC.....	198
MA-IM30.....	348	NCPE-430-3010.....	81	PCBK-XL.....	387	PRO+G40-40N RH62.....	274
MA-IRT203B.....	324	NCVT-2.....	341	PCBU-L.....	388	PRO+G50-40N RH62.....	274
MA-KN74HD.....	348	NCVT-3.....	341	PCBU-XL.....	388	PRO+G75-76N RH.....	274
MA-L42.....	348	NDV3630I.....	437	PCF-90-012.....	295	PRO+G75-76N RH PV.....	276
MA-MFC1.....	358	NDV3933I.....	437	PCF-90-034.....	295	PROE28 S2 RH95.....	277
MA-MFC2.....	358	NDV4236I.....	437	PCF-90DEF-012.....	295	PROE36 S2 RH95.....	277
MA-MFC3.....	358	NDV4842I.....	437	PCF-CO-034.....	295	PROE40 M2 RH95.....	277
MA-MY69.....	318	NETBRAZE-15-22.....	368	PCF-FA-034.....	295	PROE50 T2 RH95.....	277
MA-NAT316-5.....	413	NETBRAZE-15-5.....	368	PCF-MA-034.....	295	PROE6 1 RH POU.....	277
MA-PDT392B.....	324	NFM-TT.....	360	PCF-MA-1.....	295	PROG29-32N RH63.....	273
MA-QP400.....	333	NFT5-4.....	332	PCF-T-012.....	295	PROG40-32P RH62.....	273
MA-RS300.....	386	NFT5-6.....	332	PCF-T-034.....	295	PROG40-38N RH62.....	273
MA-RT335.....	325	NG-R22.....	327	PCRD-L.....	388	PROG40-40N RH67 PV.....	275
MA-RT819.....	325	NGN656T.....	428	PCRD-XL.....	388	PROG40S-32P.....	275
MA-S144.....	386	NHB-110.....	229	PDT550.....	324	PROG40S-32P RH67 PV.....	275
MA-S25.....	348	NHB-150.....	229	PDT650.....	324	PROG40S-38N RH62.....	273
MA-SB35.....	93	NHB-55.....	229	PF413Y.....	291	PROG50-36P RH62V2.....	273
MA-SM7.....	348	NHB-80.....	229	PFC550.....	359	PROG50-38N RH60.....	273
MA-VTC1.....	348	NIPPACK-012B.....	302	PPFP600.....	291	PROG50-42N RH67 PV.....	275
MA05031-2.....	322	NIPPACK-034B.....	302	PFS010.....	406	PROG50-42P RH67 PV.....	275
MC14N.....	342	NIPPACK-034G.....	304	PFS013.....	406	PROG50S-32P RH67 PV.....	275
MC14NRB.....	342	NIPPACK-034G.....	304	PFS014.....	406	PS1201A00/U.....	125
MD6TU.....	218	NIPPACK-100B.....	302	PFS301.....	406	PS1201B25.....	125
MD8TU.....	218	NIPPACK-114B.....	302	PFS401.....	406	PS413Y.....	291
MF200-S.....	243	NIPPACK-200B.....	302	PFS802.....	406	PS495.....	413
MF200.....	243	NP-R410.....	327	PGN655T.....	428	PS498.....	413
MFD10.....	320	NPE-180A.....	281	PGN657T.....	428	PSB-4D.....	225
MIC-9901-0345.....	50	NPE-210A.....	281	PGS618S.....	432	PSB-5D.....	225
MIC-9901-0364.....	50	NPE-240A.....	281	PH-05.....	283	PSB-6D.....	225
MICECD-PRCCECA-DYDB.....	50	NPE180S.....	281	PH-12.....	283	PSB-7D.....	225
MICECD-PRCOBCA-DYDB.....	50	NPE210S.....	281	PL-12A.....	359	PSB-8D.....	225
MICECE-PRCCECA-DYDB.....	50	NPE240S.....	281	PL-12ADLX-B.....	359	PSB-9D.....	225
MICECE-PRCOBCA-DYDB.....	50	NRF-22.....	233	PL-30.....	233	PSRKIT27.....	228
MICROCOR 9901-1619.....	50	NRF-25.....	233	PL-36.....	233	PTD015.....	315
MODSTAT.....	167	NRF-33.....	233	PL-45.....	233	PTD020.....	315
MOTDD-MULTI-115.....	428	NV-MULTI.....	327	PL-5A.....	359	PTD030.....	315
MOTDD-MULTI-230.....	428	P04080.....	239	PL-8A.....	359	PVC-45-2.....	293
MP-18C.....	362	P1000.....	134	PL-8ADLX-B.....	359	PVC-45-3.....	293
MP-2C.....	362	P509.....	332	PL-8ADLX-MC.....	359	PVC-45-4.....	293
MP-4C.....	362	P6510L.....	347	POE100-32.....	383	PVC-45ST-2.....	293
MP-4E.....	362	P6510R.....	347	POF-MA-034.....	294	PVC-45ST-3.....	293
MR-533.....	329	P6510S.....	347	POF-MR-1234.....	294	PVC-45ST-4.....	293
MR-593CM.....	329	P6716B.....	347	POP3.....	314	PVC-90-2-LS.....	292
MR-598.....	329	P6716L.....	347	POP5.....	314	PVC-90-2.....	292
MR-601.....	329	P6716R.....	347	POPUP1625.....	127	PVC-90-3-LS.....	292
MRS83321.....	316	P6716S.....	347	POPUP2025.....	127	PVC-90-3.....	292
MRS83323.....	316	P6900L.....	347	POPUP2200.....	127	PVC-90-4-LS.....	292

Index by Model Number

PVC-90-4.....	292	QSWI5000.....	71	S-437.....	248	SBR-4X10X7-ST.....	180
PVC-90ST-2-LS.....	293	QT2000.....	374	S-438.....	248	SBR-4X12X6-90.....	180
PVC-90ST-2.....	292	QT2810.....	435	S-439.....	249	SBR-4X12X6-CE.....	180
PVC-90ST-3-LS.....	293	QTM-1.....	367	S1-BOSS12503.....	83	SBR-4X12X6-CEL.....	180
PVC-90ST-3.....	292	QUIET R TYPE 475.....	209	S2R.....	343	SBR-4X12X6-CER.....	181
PVC-90ST-4-LS.....	293	R-22 30#.....	383	S3004PWBUS.....	121	SBR-4X12X6-ST.....	180
PVC-90ST-4.....	292	R-410A 25#.....	383	S3005PWLUS.....	121	SBR-4X12X7-90.....	180
PVC-BUSH-3X2.....	293	R-619.....	79	S3R.....	343	SBR-4X12X7-CE.....	180
PVC-BUSH-4X2.....	293	R8225A1017.....	415	S688A1007.....	141	SBR-4X12X7-ST.....	180
PVC-CAP-2.....	293	R8285B1053.....	410	S6R.....	343	SBR-4X12X8-90.....	180
PVC-CAP-3.....	293	R8330D1039.....	415	S8610U3009.....	400	SBR-4X12X8-CE.....	180
PVC-COUP-2.....	293	R8845U1003.....	260	S9200U1000.....	401	SBR-4X12X8-ST.....	180
PVC-COUP-3.....	293	RA-ECL-03.....	271	S9V2B040D3PSBA.....	12	SBR-4X8X6-90.....	180
PVC-COUP-4.....	293	RA-ECR-03.....	271	S9V2B040U3PSBA.....	12	SBR-4X8X6-CE.....	180
PVC-COUP-R-3X2.....	293	RA-ICB-90.....	271	S9V2B060D3PSBA.....	12	SBR-4X10X6-90.....	180
PVC-COUP-R-4X2.....	293	RA-OCF-90.....	271	S9V2B060U3PSBA.....	12	SBR-6X10X6-90BS.....	181
PVC-T-2.....	292	RA-VEL-04.....	271	S9V2B060U4PSBA.....	12	SBR-6X10X6-CE.....	180
PVC-T-3.....	292	RA-VER-04.....	271	S9V2B080D3PSBA.....	12	SBR-6X10X6-CEBS.....	181
PVS-06-90.....	189	RA832A1066.....	260	S9V2B080D4PSBA.....	12	SBR-6X10X6-ST.....	180
PVS-06-SAD.....	189	RA89A1074.....	260	S9V2B080U3PSBA.....	12	SBR-6X10X6-STBS.....	181
PVS-06X10-PIPE.....	189	RB-750-A10.....	271	S9V2B080U4PSBA.....	12	SBR-6X10X7-90.....	180
PVS-08X10-PIPE.....	189	RB-750-A2.....	271	S9V2C080U5PSBA.....	12	SBR-6X10X7-90BS.....	181
PVS-10-90.....	189	RB-750-A3.....	271	S9V2C100D4PSBA.....	12	SBR-6X10X7-CE.....	180
PVS-10-COUP.....	189	RB-750-A4.....	271	S9V2C100D5PSBA.....	12	SBR-6X10X7-ST.....	180
PVS-10X08-RED.....	189	RB-750-A5.....	271	S9V2C100U4PSBA.....	12	SBR-6X10X7-STBS.....	181
PVS-10X10-PIPE.....	189	RB-750-A6.....	271	S9V2C100U5PSBA.....	12	SBR-6X12X6-90.....	180
PVS-12-90.....	189	RB-750-A7.....	271	S9V2D120D5PSBA.....	12	SBR-6X12X6-90BS.....	181
PVS-12X10-PIPE.....	189	RB-750-A8.....	271	S9V2D120U5PSBA.....	12	SBR-6X12X6-CE.....	180
PVS-4X10X6-90.....	189	RB-8-A.....	271	S9X2B040D2PSAA.....	13	SBR-6X12X6-ST.....	180
PVS-4X10X6-CE.....	189	RB-ICF-45.....	271	S9X2B040U2PSA.....	12	SBR-6X12X6-STBS.....	181
PVS-PAINT.....	189	RB-ICF-90.....	271	S9X2B040U3PSA.....	12	SBR-6X12X7-90.....	180
Q313A1188.....	417	RB-JPS-02.....	271	S9X2B060D3PSAA.....	13	SBR-6X12X7-90BS.....	181
Q314A4586.....	407	RB-WEP-03.....	271	S9X2B060U3PSA.....	12	SBR-6X12X7-CE.....	180
Q314A6094.....	407	RC200-HTL.....	438	S9X2B060U4PSA.....	12	SBR-6X12X7-ST.....	180
Q314A6102.....	407	RCT-MLT-HTL.....	438	S9X2B080D4PSAA.....	13	SBR-6X12X7-STBS.....	181
Q314U1001.....	407	REF-50.....	326	S9X2B080U3PSA.....	12	SBR-6X12X8-90.....	180
Q3200U1004.....	405	REF1/2X50.....	366	S9X2B080U4PSA.....	12	SBR-6X12X8-90BS.....	181
Q3200U2002.....	405	REF1/4X10.....	366	S9X2C080U4PSA.....	12	SBR-6X12X8-CE.....	180
Q3400A1024.....	405	REF1/4X50.....	366	S9X2C080U5PSA.....	12	SBR-6X12X8-ST.....	180
Q340A1066.....	417	REF11/8X50.....	366	S9X2C100D5PSAA.....	13	SBR-6X12X8-STBS.....	181
Q340A1074.....	417	REF3/4X50.....	366	S9X2C100U4PSA.....	12	SBR-6X14X6-CE.....	180
Q340A1082.....	417	REF3/8X50.....	366	S9X2C100U5PSA.....	12	SBR-6X14X6-ST.....	180
Q340A1090.....	417	REF5/16X50.....	366	S9X2D120D5PSAA.....	13	SBR-6X14X7-90.....	180
Q340A1108.....	417	REF5/8X50.....	366	S9X2D120U5PSA.....	12	SBR-6X14X7-CE.....	180
Q3450C1185.....	408	REF7/8X50.....	366	SAHB114.....	376	SBR-6X14X7-ST.....	180
Q345A1305.....	407	REM5000R1001.....	116	SAHB34.....	376	SBR-6X14X8-90.....	180
Q345A1313.....	407	RENTALTOOL.....	291	SBR-12X12X8-ST.....	180	SBR-6X14X8-CE.....	180
Q345A1321.....	407	RF12.....	439	SBR-2X10X4-90.....	180	SBR-6X14X8-ST.....	180
Q390A1061.....	418	RF370.....	439	SBR-2X10X4-CE.....	180	SBR-6X14X8-STBS.....	181
Q4020500.....	267	RF371.....	439	SBR-2X10X4-ST.....	180	SBR-8X12X10-ST.....	180
Q4020625.....	267	RF6.....	439	SBR-2X10X6-90.....	180	SBR-8X12X8-ST.....	180
Q4020750.....	267	RG3.....	326	SBR-2X10X6-CE.....	180	SBR-BF-4X10X24.....	188
Q4143275.....	265	RG6.....	326	SBR-2X10X6-CEL.....	180	SBR-BF-4X12X24.....	188
Q4153210.....	265	RH-25-NAT.....	79	SBR-2X10X6-CER.....	181	SBR-BF-6X10X24.....	188
Q4153275.....	265	RH-35-NAT.....	79	SBR-2X10X6-ST.....	180	SBR-BF-6X12X24.....	188
Q4386375.....	266	RH-50B-NAT.....	79	SBR-2X12X6-90.....	180	SBX-12X12X10-BOX.....	188
Q4506375.....	266	RP100BX.....	103	SBR-2X12X6-CE.....	180	SBX-14X14X12-BOX.....	188
Q4516375.....	266	RP200RVNNSL.....	103	SBR-2X12X6-CEL.....	180	SEP100.....	67
Q4526375.....	266	RPS28.....	365	SBR-2X12X6-CER.....	181	SEP115.....	67
Q4546363.....	266	RRD6.....	163	SBR-2X12X6-ST.....	180	SEP145.....	67
Q4690512.....	266	RRD7.....	163	SBR-2X14X6-CE.....	180	SEP175.....	67
Q4690625.....	266	RRD8.....	163	SBR-4X10X4-90.....	180	SEP200.....	67
Q4690756.....	266	RRW316.....	346	SBR-4X10X4-90BS.....	181	SEP230.....	67
Q4691000.....	266	RRW516.....	346	SBR-4X10X4-CE.....	180	SEP250.....	67
Q4691250.....	266	RRW5.....	346	SBR-4X10X4-ST.....	180	SEP300.....	67
Q4775050.....	266	RS100.....	105	SBR-4X10X4-STBS.....	181	SEP400.....	67
Q4776363.....	266	RS200.....	105	SBR-4X10X5-90.....	180	SF-2.....	368
Q4777575.....	266	RSK10.....	213	SBR-4X10X5-CE.....	180	SF5.....	368
Q5806375.....	266	RSK4.....	213	SBR-4X10X5-ST.....	180	SFM7553SP1V.....	430
Q6310500.....	266	RSK6.....	213	SBR-4X10X6-90.....	180	SFM7553SP2V.....	430
Q6310625.....	266	RSK8.....	213	SBR-4X10X6-90BS.....	181	SFMB253SP1V.....	430
Q6310750.....	266	RT70007B.....	353	SBR-4X10X6-CE.....	180	SFMB253SP2V.....	430
QC-S5.....	99	RT70017B.....	353	SBR-4X10X6-CEL.....	180	SFMB333SP1V.....	430
QM6.....	202	RT70021.....	353	SBR-4X10X6-CER.....	181	SFMB333SP2V.....	430
QSMS1201.....	93	RT70402.....	353	SBR-4X10X6-ST.....	180	SFMB503SP1V.....	430
QSMS1801.....	93	RTS3.....	156	SBR-4X10X6-STBS.....	181	SFMC251SP2V.....	434
QSWI1000.....	71	RVHAB4.....	219	SBR-4X10X7-90.....	180	SFMC331SP2V.....	434
QSWI3000.....	71	RVHAW4.....	219	SBR-4X10X7-CE.....	180	SFMC501SP2V.....	434

Models and Specifications are Subject to Change Without Notice



Index by Model Number

SFMMH332V.....	434	SILICONER.....	375	SMM-PL48-16.25.....	186	SP-06-CAP.....	294
SFMMH501VB.....	430	SILICONEW.....	375	SMM-PL48-19.75.....	186	SPG1204.....	207
SFMMH502VB.....	430	SIM-36C-BK.....	437	SMM-PL48-23.25.....	186	SPG1403.....	207
SFMMH751VB.....	430	SIM-42C-BK.....	437	SMM-PLN-16X20-60.....	186	SPG1804.....	207
SG4PR.....	134	SIO553-026W.....	365	SMM-PLN-20X20-36.....	186	SPG2004.....	207
SGF-06-14/18-SAD.....	190	SK101.....	103	SMM-PLN-20X20-48.....	186	SPG2406.....	207
SGF-06-26-90.....	190	SL1112.....	439	SMM-PLN-20X20-60.....	186	SPRD12.....	163
SGF-06-CONN.....	190	SL1118.....	439	SMM-PLN-22X22-36.....	186	SRF-03-26-90.....	175
SGF-08-14/18-SAD.....	190	SL1130.....	439	SMM-PLN-24X24-36.....	186	SRF-03-30-90.....	175
SGF-08-26-90.....	190	SL1136.....	439	SMM-PLN-24X24-48.....	186	SRF-03-EC.....	175
SGF-08-CONN.....	190	SL1148.....	439	SMM-PNG-DBL.....	173	SRF-03-ST-S.....	175
SGF-08X06-RED.....	190	SL1R.....	344	SMM-PNG-SNGL.....	173	SRF-03-ST.....	175
SGF-10-16/20-SAD.....	190	SL306.....	439	SMM-S-008.....	188	SRF-03-TEE.....	176
SGF-10-26-90.....	190	SL312.....	439	SMM-S-010.....	188	SRF-03X04-V.....	215
SGF-10-CONN.....	190	SL318.....	439	SMM-S-012.....	188	SRF-04-26-90.....	175
SGF-10X08-RED.....	190	SL324.....	439	SMM-S-014.....	188	SRF-04-30-90.....	175
SGF-12-26-90.....	190	SL330.....	439	SMM-S-016.....	188	SRF-04-DAM.....	178
SGF-12-CONN.....	190	SL336.....	439	SMM-S-018.....	188	SRF-04-DBCT.....	178
SGF-12X08-RED.....	190	SL348.....	439	SMM-S-020.....	188	SRF-04-EC.....	175
SGF-12X10-RED.....	190	SMART-100.....	231	SMM-S-022.....	188	SRF-04-RR-SAD.....	179
SGF-14-26-90.....	190	SMART-120.....	231	SMM-S-024.....	188	SRF-04-SAD/12.....	176
SGF-14-CONN.....	190	SMART-40.....	231	SMM-S-025.....	188	SRF-04-SAD.....	176
SGF-14X10-RED.....	190	SMART-50.....	231	SMM-S-096.....	188	SRF-04-ST-S.....	175
SGF-14X12-RED.....	190	SMART-60.....	231	SMM-S-120.....	188	SRF-04-ST.....	175
SGF-16-24-90.....	190	SMART-80.....	231	SMM-S-60.....	188	SRF-04-TEE.....	176
SGF-16-CONN.....	190	SMART-BATT-HTL-B.....	438	SMM-S-R-120-1.....	187	SRF-04-WYE.....	176
SGF-16X12-RED.....	190	SMART-STAT-HTL.....	438	SMM-S-R-120-5/8.....	187	SRF-04X03-RED-SC.....	177
SGF-16X14-RED.....	190	SMF.....	206	SMM-S-R-60-5/8.....	187	SRF-04X03-RED.....	177
SGF-18-24-90.....	190	SMM-13.25X24-BOTTOM.....	187	SMM-S-R-60.....	187	SRF-05-26-90.....	175
SGF-18-CONN.....	190	SMM-16X20-EFIL.....	187	SMM-SPEAR.....	188	SRF-05-30-90.....	175
SGF-18X12-RED.....	190	SMM-16X20-FIL.....	187	SOF-4X10X6-45-C.....	182	SRF-05-DAM.....	178
SGF-18X14-RED.....	190	SMM-16X24-BOTTOM.....	187	SOF-4X10X6-45.....	182	SRF-05-EC.....	175
SGF-18X16-RED.....	190	SMM-16X25-EFIL.....	187	SOF-4X10X6-90.....	183	SRF-05-SAD.....	176
SGF-20-24-90.....	190	SMM-16X25-FIL-D.....	187	SOF-4X10X6-SH.....	183	SRF-05-SC.....	179
SGF-20-CONN.....	190	SMM-16X25-FIL.....	187	SOF-4X10X7-90.....	183	SRF-05-ST-S.....	175
SGF-20X16-RED.....	190	SMM-20X20-FIL.....	187	SOF-6-FW45.....	182	SRF-05-ST.....	175
SGF-20X18-RED.....	190	SMM-20X24-BOTTOM.....	187	SOF-6-FW90.....	182	SRF-05-TEE.....	176
SGF-24-24-90.....	190	SMM-20X25-FIL.....	187	SOF-6-OR-90.....	182	SRF-05X03-RED.....	177
SGF-24-CONN.....	190	SMM-23X24-BOTTOM.....	187	SOF-6-OR-CE.....	182	SRF-05X04-RED-SC.....	177
SGF-4X10-RS.....	190	SMM-3X8-24-FS.....	174	SOF-6-OR-ST.....	182	SRF-05X04-RED.....	177
SGF-4X12-RS.....	190	SMM-3X8-26-FS.....	174	SOF-6-ST.....	182	SRF-06-26-90.....	175
SGF-6X10-RS.....	190	SMM-3X8-28-FS.....	174	SOF-6-SW45.....	182	SRF-06-30-90.....	175
SGF-6X12-RS.....	190	SMM-4X10X9-RP.....	187	SOF-6-SW90.....	182	SRF-06-DAM.....	178
SGF-6X14-RS.....	190	SMM-4X8-24-FS.....	174	SOF-6X10X6-DBSH.....	183	SRF-06-DB.....	178
SGMPR.....	134	SMM-4X8-26-FS.....	174	SOF-6X10X6-SH.....	183	SRF-06-DBCT.....	178
SGP-06X10-26.....	190	SMM-4X8-28-FS.....	174	SOF-6X10X7-DBSH.....	183	SRF-06-EC.....	175
SGP-08X10-26.....	190	SMM-ANGLE-96.....	188	SOF-6X10X7-SH.....	183	SRF-06-HTTO.....	179
SGP-10X10-26.....	190	SMM-DP-30X25X2.....	188	SOF-6X12X6-DBSH.....	183	SRF-06-RR-SAD.....	179
SGP-12X10-26.....	190	SMM-DP-30X30X2.....	188	SOF-6X12X6-SH.....	183	SRF-06-SAD/12.....	176
SGP-14X10-26.....	190	SMM-DP-30X60X2.....	188	SOF-6X12X7-DBSH.....	183	SRF-06-SAD/14.....	176
SGP-16X10-26.....	190	SMM-DP-36X36X2.....	188	SOF-6X12X7-SH.....	183	SRF-06-SAD/16.....	176
SGP-18X10-24.....	190	SMM-DP-36X60X2.....	188	SOF-6X12X8-DBSH.....	183	SRF-06-SAD.....	176
SGP-20X10-24.....	190	SMM-DP-36X72X2.....	188	SOF-6X12X8-SH.....	183	SRF-06-SC.....	179
SGP-22X10-24.....	190	SMM-DR-08.....	188	SOF-6X14X8-SH.....	183	SRF-06-SPD.....	179
SGP-24X10-24.....	190	SMM-DR-096.....	188	SOF-7-FW45.....	182	SRF-06-ST-D.....	175
SGT309S.....	432	SMM-DR-10.....	188	SOF-7-FW90.....	182	SRF-06-ST-S.....	175
SH3V.....	345	SMM-DR-12.....	188	SOF-7-OR-90.....	182	SRF-06-ST.....	175
SHL501.....	409	SMM-DR-60.....	188	SOF-7-OR-CE.....	182	SRF-06-TEE.....	176
SHL502.....	409	SMM-FRAME-10X6.....	187	SOF-7-OR-ST.....	182	SRF-06-WYE.....	176
SHL503.....	409	SMM-FRAME-12X12.....	187	SOF-7-ST.....	182	SRF-06.....	179
SHL504.....	409	SMM-FRAME-12X6.....	187	SOF-7-SW45.....	182	SRF-06X03-RED.....	177
SHL505.....	409	SMM-FRAME-14X14.....	187	SOF-7-SW90.....	182	SRF-06X04-RED-SC.....	177
SHL507.....	409	SMM-FRAME-14X6.....	187	SOF-7OV-6RD-90.....	182	SRF-06X04-RED.....	177
SHL508.....	409	SMM-FRAME-14X8.....	187	SOF-8-FW45.....	182	SRF-06X05-RED-SC.....	177
SHL513.....	409	SMM-FRAME-24X6.....	187	SOF-8-FW90.....	182	SRF-06X05-RED.....	177
SHL514.....	409	SMM-FRAME-30X6.....	187	SOF-8-OR-90.....	182	SRF-07-26-90.....	175
SHL515.....	409	SMM-FRAME-30X8.....	187	SOF-8-OR-CE.....	182	SRF-07-30-90.....	175
SHL516.....	409	SMM-FSB-20X30.....	187	SOF-8-OR-ST.....	182	SRF-07-DAM.....	178
SHL517.....	409	SMM-FSB-26X38.....	187	SOF-8-ST.....	182	SRF-07-DB.....	178
SHL518.....	409	SMM-FSB-28X48X12.....	187	SOF-8-SW45.....	182	SRF-07-DBCT.....	178
SHLD-3-Driver.....	327	SMM-FSB-36X28X15.....	187	SOF-8-SW90.....	182	SRF-07-EC.....	175
SHLD-MULTI.....	327	SMM-FSB-F.....	187	SOP-6X100-OV.....	182	SRF-07-HTTO.....	179
SHLD-P4.....	327	SMM-FSB.....	187	SOP-6X113-OV.....	182	SRF-07-RR-SAD.....	179
SHLD-U4.....	327	SMM-PL36-13.25.....	186	SOP-7X100-OV.....	182	SRF-07-SAD/12.....	176
SIG101.....	404	SMM-PL36-16.25.....	186	SOP-7X113-OV.....	182	SRF-07-SAD/14.....	176
SIG1100.....	404	SMM-PL36-19.75.....	186	SOP-8X100-OV.....	182	SRF-07-SAD.....	176
SILICONEC.....	375	SMM-PL36-23.25.....	186	SOP-8X113-OV.....	182	SRF-07-SC.....	179
SILICONEG.....	375	SMM-PL48-13.25.....	186	SOP-8X60-OV.....	182	SRF-07-ST-D.....	175

Index by Model Number

SRF-07-ST-S.....	175	SRF-12X10-RED.....	177	SRP-06X60-UNBOX.....	174	SSD-30X8X48.....	169
SRF-07-ST.....	175	SRF-12X14-V.....	215	SRP-06X60-WA.....	174	SSF-02-TAP.....	169
SRF-07-TEE.....	176	SRF-14-26-90.....	175	SRP-07X120-UNBOX.....	174	SSF-04-TAP.....	169
SRF-07X03-RED.....	177	SRF-14-DAM-2.....	178	SRP-07X24-26.....	174	SSF-06-TAP.....	169
SRF-07X04-RED.....	177	SRF-14-EC.....	175	SRP-07X24-30.....	174	SSF-08-TAP.....	169
SRF-07X05-RED-SC.....	177	SRF-14-SAD.....	176	SRP-07X60-26.....	174	SSF-08X8-DAM.....	172
SRF-07X05-RED.....	177	SRF-14-ST-D.....	175	SRP-07X60-UNBOXED.....	174	SSF-08X8-EC.....	170
SRF-07X06-RED.....	177	SRF-14-ST-S.....	175	SRP-08X120-UNBOXED.....	174	SSF-08X8-FW45.....	171
SRF-08-26-90.....	175	SRF-14-ST.....	175	SRP-08X24-26.....	174	SSF-08X8-FW90.....	171
SRF-08-30-90.....	175	SRF-14-TEE.....	176	SRP-08X24-30.....	174	SSF-08X8-OST.....	172
SRF-08-DAM.....	178	SRF-14X08-RED.....	177	SRP-08X60-26.....	174	SSF-08X8-ST.....	172
SRF-08-DB.....	178	SRF-14X10-RED.....	177	SRP-08X60-UNBOXED.....	174	SSF-08X8-SW45.....	171
SRF-08-DBCT.....	178	SRF-14X12-RED.....	177	SRP-09X24-26.....	174	SSF-08X8-SW90.....	172
SRF-08-EC.....	175	SRF-16-26-90.....	175	SRP-09X24-WA.....	174	SSF-10X10-EC.....	170
SRF-08-RR-SAD.....	179	SRF-16-DAM.....	178	SRP-09X60-26.....	174	SSF-10X10-FW45.....	171
SRF-08-SAD/12.....	176	SRF-16-EC.....	175	SRP-09X60-30.....	174	SSF-10X10-FW90.....	171
SRF-08-SAD/16.....	176	SRF-16-ST-D.....	175	SRP-10X24-26.....	174	SSF-10X10-SW45.....	171
SRF-08-SAD.....	176	SRF-16-ST-S.....	175	SRP-10X24-WA.....	174	SSF-10X10-SW90.....	172
SRF-08-SC.....	179	SRF-16-ST.....	175	SRP-10X60-26.....	174	SSF-10X8-10X10-JUMPER.....	173
SRF-08-SPD.....	179	SRF-16-TEE.....	176	SRP-10X60-28.....	174	SSF-10X8-8X8-TR.....	173
SRF-08-ST-D.....	175	SRF-16X10-RED.....	177	SRP-10X60-30.....	174	SSF-10X8-DAM.....	172
SRF-08-ST-S.....	175	SRF-16X12-RED.....	177	SRP-12X24-26.....	174	SSF-10X8-EC.....	170
SRF-08-ST.....	175	SRF-16X14-RED.....	177	SRP-12X24-30.....	174	SSF-10X8-FW45.....	171
SRF-08-TEE.....	176	SRF-18-26-90.....	175	SRP-12X60-26.....	174	SSF-10X8-FW90.....	171
SRF-08.....	179	SRF-18-EC.....	175	SRP-12X60-28.....	174	SSF-10X8-OST.....	172
SRF-08X04-RED.....	177	SRF-18-ST-S.....	175	SRP-14X24-26.....	174	SSF-10X8-ST.....	172
SRF-08X05-RED.....	177	SRF-18-ST.....	175	SRP-14X60-26.....	174	SSF-10X8-SW45.....	171
SRF-08X06-RED-SC.....	177	SRF-18-TEE.....	176	SRP-16X24-26.....	174	SSF-10X8-SW90.....	172
SRF-08X06-RED.....	177	SRF-18X16-RED.....	177	SRP-16X48-26.....	174	SSF-12X10-12X8-TR.....	173
SRF-08X07-RED-SC.....	177	SRF-20-ST.....	175	SRP-16X60-26.....	174	SSF-12X10-EC.....	170
SRF-08X07-RED.....	177	SRF-24-EC.....	175	SRP-18X24-26.....	174	SSF-12X10-FW45.....	171
SRF-09-26-90.....	175	SRF-24-ST.....	175	SRP-18X48-26.....	174	SSF-12X10-FW90.....	171
SRF-09-30-90.....	175	SRF-4X3X3-TEE.....	176	SSI5-1.....	368	SSF-12X10-SW45.....	171
SRF-09-DAM.....	178	SRF-4X4X3-TEE.....	176	SSI5.....	368	SSF-12X10-SW90.....	172
SRF-09-EC.....	175	SRF-5X3X3-TEE.....	176	SS42D.....	384	SSF-12X8-10X8-TR.....	173
SRF-09-ST.....	175	SRF-5X4X3-TEE.....	176	SSD-08X8X48.....	169	SSF-12X8-12X12-JUMPER.....	173
SRF-09-TEE.....	176	SRF-5X4X4-TEE.....	176	SSD-08X8X60.....	169	SSF-12X8-8X8-TR.....	173
SRF-09X06-RED.....	177	SRF-5X5X3-TEE.....	176	SSD-08X8X96.....	169	SSF-12X8-DAM.....	172
SRF-09X07-RED.....	177	SRF-5X5X4-TEE.....	176	SSD-10X10X60.....	169	SSF-12X8-EC.....	170
SRF-09X08-RED.....	177	SRF-6X4X3-TEE.....	176	SSD-10X10X96.....	169	SSF-12X8-FW45.....	171
SRF-09X10-V.....	215	SRF-6X4X4-TEE.....	176	SSD-10X8X48.....	169	SSF-12X8-FW90.....	171
SRF-10-26-90.....	175	SRF-6X5X3-TEE.....	176	SSD-10X8X60.....	169	SSF-12X8-OST.....	172
SRF-10-28-90.....	175	SRF-6X5X4-TEE.....	176	SSD-10X8X96.....	169	SSF-12X8-ST.....	172
SRF-10-30-90.....	175	SRF-6X6X3-TEE.....	176	SSD-12X10X60.....	169	SSF-12X8-SW45.....	171
SRF-10-DAM.....	178	SRF-6X6X4-TEE.....	176	SSD-12X10X96.....	169	SSF-12X8-SW90.....	172
SRF-10-DBCT.....	178	SRF-6X6X5-TEE.....	176	SSD-12X8X48.....	169	SSF-14X10-EC.....	170
SRF-10-EC.....	175	SRF-7X4X3-TEE.....	176	SSD-12X8X60.....	169	SSF-14X10-FW45.....	171
SRF-10-RR-SAD.....	179	SRF-7X5X4-TEE.....	176	SSD-12X8X96.....	169	SSF-14X10-FW90.....	171
SRF-10-SAD.....	176	SRF-7X6X3-TEE.....	176	SSD-14X10X60.....	169	SSF-14X10-SW45.....	171
SRF-10-SC.....	179	SRF-7X6X4-TEE.....	176	SSD-14X10X96.....	169	SSF-14X10-SW90.....	172
SRF-10-SPD.....	179	SRF-7X7X3-TEE.....	176	SSD-14X8X48.....	169	SSF-14X8-10X8-TR.....	173
SRF-10-ST-D.....	175	SRF-7X7X4-TEE.....	176	SSD-14X8X60.....	169	SSF-14X8-12X8-TR.....	173
SRF-10-ST-S-UC.....	175	SRF-8X6X4-TEE.....	176	SSD-14X8X96.....	169	SSF-14X8-8X8-TR.....	173
SRF-10-ST-S.....	175	SRF-8X6X6-TEE.....	176	SSD-16X10X60.....	169	SSF-14X8-DAM.....	172
SRF-10-ST.....	175	SRF-8X6X6-WYE.....	176	SSD-16X10X96.....	169	SSF-14X8-EC.....	170
SRF-10-TEE.....	176	SRL130.....	409	SSD-16X8X48.....	169	SSF-14X8-FW45.....	171
SRF-10.....	179	SRL135.....	409	SSD-16X8X60.....	169	SSF-14X8-FW90.....	171
SRF-10X06-RED.....	177	SRL220.....	409	SSD-16X8X96.....	169	SSF-14X8-OST.....	172
SRF-10X07-RED.....	177	SRL240.....	409	SSD-18X10X60.....	169	SSF-14X8-OTST.....	173
SRF-10X08-RED.....	177	SRL250.....	409	SSD-18X10X96.....	169	SSF-14X8-ST.....	172
SRF-10X09-RED.....	177	SRL300.....	409	SSD-18X8X48.....	169	SSF-14X8-SW45.....	171
SRF-12-26-90.....	175	SRL350.....	409	SSD-18X8X60.....	169	SSF-14X8-SW90.....	172
SRF-12-28-90.....	175	SRP-03X24-26.....	174	SSD-18X8X96.....	169	SSF-16X10-16X8-TR.....	173
SRF-12-DAM.....	178	SRP-03X24-30.....	174	SSD-20X10X60.....	169	SSF-16X10-EC.....	170
SRF-12-DBCT.....	178	SRP-03X60-26.....	174	SSD-20X10X96.....	169	SSF-16X10-FW45.....	171
SRF-12-EC.....	175	SRP-03X60-30.....	174	SSD-20X8X48.....	169	SSF-16X10-FW90.....	171
SRF-12-SAD/14.....	176	SRP-04X120-WA.....	174	SSD-20X8X60.....	169	SSF-16X10-OST.....	172
SRF-12-SAD/16.....	176	SRP-04X24-26.....	174	SSD-20X8X96.....	169	SSF-16X10-ST.....	172
SRF-12-SAD.....	176	SRP-04X24-30.....	174	SSD-22X8X60.....	169	SSF-16X10-SW45.....	171
SRF-12-SPD.....	179	SRP-04X60-26.....	174	SSD-22X8X96.....	169	SSF-16X10-SW90.....	172
SRF-12-ST-D.....	175	SRP-04X60-UNBOXED-WA.....	174	SSD-24X10X60.....	169	SSF-16X20-20X10-RAK.....	186
SRF-12-ST-S.....	175	SRP-05X24-26.....	174	SSD-24X10X96.....	169	SSF-16X25-1222-T.....	186
SRF-12-ST.....	175	SRP-05X60-26.....	174	SSD-24X12X60.....	169	SSF-16X25-25X10-RAK.....	186
SRF-12-TEE.....	176	SRP-05X60-UNBOX.....	174	SSD-24X8X48.....	169	SSF-16X8-10X8-TR.....	173
SRF-12.....	179	SRP-06X120-UNBOX.....	174	SSD-24X8X60.....	169	SSF-16X8-12X8-TR.....	173
SRF-12X06-RED.....	177	SRP-06X24-26.....	174	SSD-24X8X96.....	169	SSF-16X8-14X8-TR.....	173
SRF-12X08-RED.....	177	SRP-06X24-30.....	174	SSD-25X10X60.....	169	SSF-16X8-8X8-TR.....	173
SRF-12X09-RED.....	177	SRP-06X60-26.....	174	SSD-25X10X96.....	169	SSF-16X8-DAM.....	172

Models and Specifications are Subject to Change Without Notice



A MUNCH'S SUPPLY COMPANY

Index by Model Number

SSF-16X8-EC.....	170	SSF-24X12-SW90.....	172	SWF-3X10X4-WS-90.....	185	TAM4AOC60S51.....	34
SSF-16X8-FW45.....	171	SSF-24X8-10X8-TR.....	173	SWF-3X10X4-WS-CE.....	185	TAM4AOC60S51ED.....	30
SSF-16X8-FW90.....	171	SSF-24X8-12X8-TR.....	173	SWF-3X10X4-WS-ST.....	185	TAM9A0A24V21.....	34
SSF-16X8-OST.....	172	SSF-24X8-14X8-TR.....	173	SWF-3X10X6-WS-90.....	185	TAM9A0A24V21DA.....	28
SSF-16X8-OTST.....	173	SSF-24X8-16X8-TR.....	173	SWF-3X10X6-WS-CE.....	185	TAM9A0B30V31.....	34
SSF-16X8-ST.....	172	SSF-24X8-18X8-TR.....	173	SWF-3X10X6-WS-ST.....	185	TAM9A0B30V31DA.....	28
SSF-16X8-SW45.....	171	SSF-24X8-20X8-TR.....	173	SWF-3X10X7-WS-90.....	185	TAM9AOC36V31.....	34
SSF-16X8-SW90.....	172	SSF-24X8-24X16-RAB.....	186	SWF-3X10X7-WS-CE.....	185	TAM9AOC36V31DA.....	28
SSF-18X10-EC.....	170	SSF-24X8-25X16-RAB.....	186	SWF-3X10X7-WS-ST.....	185	TAM9AOC42V41.....	34
SSF-18X10-FW45.....	171	SSF-24X8-DAM.....	172	SWF-3X12-6X12-SH.....	185	TAM9AOC42V41DA.....	28
SSF-18X10-FW90.....	171	SSF-24X8-EC.....	170	SWF-3X12-EC.....	184	TAM9AOC48V41.....	34
SSF-18X10-ST.....	172	SSF-24X8-FW45.....	171	SWF-3X12-FW90.....	184	TAM9AOC48V41DA.....	28
SSF-18X10-SW45.....	171	SSF-24X8-FW90.....	171	SWF-3X12-ST.....	185	TAM9AOC60V51.....	34
SSF-18X10-SW90.....	172	SSF-24X8-OTST.....	173	SWF-3X12-SW45.....	184	TAM9AOC60V51DA.....	28
SSF-18X8-10X8-TR.....	173	SSF-24X8-ST.....	172	SWF-3X12-SW90.....	184	TAYBASE260.....	36
SSF-18X8-12X8-TR.....	173	SSF-24X8-SW45.....	171	SWF-3X12X6-WS-90.....	185	TAZ-4.....	161
SSF-18X8-14X8-TR.....	173	SSF-24X8-SW90.....	172	SWF-3X12X6-WS-CE.....	185	TB102K.....	345
SSF-18X8-16X8-TR.....	173	SSF-25X10-20X10-TR.....	173	SWF-3X12X6-WS-ST.....	185	TBI.....	73
SSF-18X8-DAM.....	172	SSF-25X10-25X16-RAB.....	186	SWF-3X12X7-WS-90.....	185	TB2.....	73
SSF-18X8-EC.....	170	SSF-25X10-25X19-RAB.....	186	SWF-3X12X7-WS-CE.....	185	TC-1000.....	353
SSF-18X8-FW45.....	171	SSF-25X10-25X20-RAB.....	186	SWF-3X12X7-WS-ST.....	185	TC-1050.....	353
SSF-18X8-FW90.....	171	SSF-25X10-EC.....	170	SWF-3X12X8-WS-90.....	185	TCIA.....	353
SSF-18X8-OST.....	172	SSF-25X10-FW45.....	171	SWF-3X12X8-WS-CE.....	185	TCIC.....	353
SSF-18X8-OTST.....	173	SSF-25X10-FW90.....	171	SWF-3X12X8-WS-ST.....	185	TCONT200ANTIAA.....	108
SSF-18X8-ST.....	172	SSF-25X10-ST.....	172	SWF-3X14-EC.....	184	TCONT401AN21MA.....	108
SSF-18X8-SW45.....	171	SSF-25X10-SW45.....	171	SWF-3X14X7-WS-CE.....	185	TCONT402AN32DA.....	108
SSF-18X8-SW90.....	172	SSF-25X10-SW90.....	172	SWF-3X14X8-WS-90.....	185	TCONT600AF1MA.....	107
SSF-20X10-16X10-TR.....	173	SSF-25X20-25X10-RAK.....	186	SWF-3X14X8-WS-CE.....	185	TCONT602AF22MA.....	107
SSF-20X10-16X8-TR.....	173	SSF-28X8-OTST.....	173	SWF-3X14X8-WS-ST.....	185	TCONT624AS42DA.....	102
SSF-20X10-20X16-RAB.....	186	SSF-30X8-EC.....	170	SXHT30.....	244	TCONT824AS52DA.....	102
SSF-20X10-20X19.....	186	SSF-30X8-OTST.....	173	SXHT40.....	244	TCONT850AC52UA.....	101
SSF-20X10-20X20-RAB.....	186	SSF-32X8-OTST.....	173	SXHT60.....	244	TCONTB00AS1IAA.....	107
SSF-20X10-20X8-TR.....	173	SSTRPS18.....	365	T-431.....	248	TCONTB02AS32DA.....	107
SSF-20X10-EC.....	170	SSTRPS24.....	365	T-437.....	248	TCONTB03AS32DA.....	107
SSF-20X10-FW45.....	171	SSU.....	315	T-438.....	248	TCONTV10APBCOA.....	153
SSF-20X10-FW90.....	171	SSY.....	315	T-570.....	249	TD69.....	436
SSF-20X10-OTST.....	173	ST-101.....	331	T048052.....	290	TD73.....	436
SSF-20X10-ST.....	172	ST120.....	279	T048056.....	290	TDCIB040A9241A.....	16
SSF-20X10-SW45.....	171	ST9120U1011.....	411	T048058.....	290	TDCIB060A9361A.....	16
SSF-20X10-SW90.....	172	ST94.....	345	T048060.....	290	TDCIB080A9421A.....	16
SSF-20X8-10X8-TR.....	173	STBP14.....	168	T048062.....	290	TDCIC100A9481A.....	16
SSF-20X8-12X8-TR.....	173	STMPD08.....	168	T048064.....	290	TDCID120A9601A.....	16
SSF-20X8-14X8-TR.....	173	STMPD10.....	168	T048066.....	290	TDD1A060A9241B.....	22
SSF-20X8-16X8-TR.....	173	SV9501M2528.....	394	T048070.....	290	TDD1A060A9361B.....	22
SSF-20X8-18X8-TR.....	173	SV9502H2522.....	394	T2-4.....	333	TDD1B060A9361B.....	22
SSF-20X8-20X16-RAB.....	186	SV9520H8513.....	394	T200-59.....	209	TDD1B080A9361B.....	22
SSF-20X8-DAM.....	172	SV9641M4510.....	394	T200.....	209	TDD1B080A9451B.....	22
SSF-20X8-EC.....	170	SVHUB4.....	219	T20275.....	99	TDD1B100A9451B.....	22
SSF-20X8-FW45.....	171	SVHUW3.....	219	T21000.....	353	TDD1C100A9481B.....	22
SSF-20X8-FW90.....	171	SVHUW4.....	219	T3008US.....	121	TDD1C100A9541B.....	22
SSF-20X8-OST.....	172	SWD-2X10X100-WS.....	184	T3016US.....	121	TDD1C120A9541B.....	22
SSF-20X8-OTST.....	173	SWD-2X10X24-WS.....	184	T3017US.....	121	TDD1D120A9601B.....	22
SSF-20X8-ST.....	172	SWD-2X12X100.....	184	T3021US.....	121	TDD1D140A9601B.....	22
SSF-20X8-SW45.....	171	SWD-2X12X24.....	184	T4001ES.....	121	TDD2A040A9242A.....	21
SSF-20X8-SW90.....	172	SWD-3X10X100.....	184	T410A1013.....	115	TDD2A060A9362A.....	21
SSF-22X8-EC.....	170	SWD-3X10X24.....	184	T410B1004.....	115	TDD2B060A9362A.....	21
SSF-22X8-FW45.....	171	SWD-3X10X60.....	184	T425M.....	345	TDD2B060A9V3VA.....	20
SSF-22X8-FW90.....	171	SWD-3X12X100.....	184	T822K1018.....	115	TDD2B060ACV32B.....	20
SSF-22X8-OTST.....	173	SWD-3X12X24.....	184	T834N1002.....	115	TDD2B080A9362A.....	21
SSF-22X8-ST.....	172	SWD-3X12X60.....	184	T8775C1005.....	115	TDD2B080A9V3VA.....	20
SSF-22X8-SW45.....	171	SWD-3X14X100.....	184	T87K1007.....	115	TDD2B080ACV32B.....	20
SSF-22X8-SW90.....	172	SWD-3X14X60.....	184	T87N1000.....	115	TDD2B100A9482A.....	21
SSF-24X10-20X10-TR.....	173	SWF-2X10-6X10-SH.....	185	T87N1026.....	115	TDD2C100A9482A.....	21
SSF-24X10-24X16-RAB.....	186	SWF-2X10-SW45.....	184	TA1AW.....	69	TDD2C100A9602A.....	21
SSF-24X10-24X16.....	186	SWF-2X10-SW90.....	184	TA2AW.....	69	TDD2C100A9V5VA.....	20
SSF-24X10-24X8-TR.....	173	SWF-2X10X6-WS-90.....	185	TAC007-F5.....	235	TDD2C100ACV52B.....	20
SSF-24X10-25X16-RAB.....	186	SWF-2X10X6-WS-CE.....	185	TAM4A0A18S11.....	34	TDD2D120A9602A.....	21
SSF-24X10-EC.....	170	SWF-2X10X6-WS-ST.....	185	TAM4A0A18S11ED.....	30	TDD2D120A9V5VA.....	20
SSF-24X10-FW45.....	171	SWF-2X12-EC.....	184	TAM4A0A24S21.....	34	TDD2D120ACV52B.....	20
SSF-24X10-FW90.....	171	SWF-2X12-SW90.....	184	TAM4A0A24S21ED.....	30	TDD2D140A9602A.....	21
SSF-24X10-OTST.....	173	SWF-2X12X6-WS-90.....	185	TAM4A0A30S21.....	34	TDE1A060A9361A.....	23
SSF-24X10-ST.....	172	SWF-2X12X6-WS-CE.....	185	TAM4A0A30S21ED.....	30	TDE1B060A9361A.....	23
SSF-24X10-SW45.....	171	SWF-3X10-6X10-SH.....	185	TAM4A0A36S31.....	34	TDE1B080A9451A.....	23
SSF-24X10-SW90.....	172	SWF-3X10-EC.....	184	TAM4A0A36S31ED.....	30	TDE1B100A9451A.....	23
SSF-24X12-EC.....	170	SWF-3X10-FW45.....	184	TAM4A0B42S31.....	34	TDEIC100A9601A.....	23
SSF-24X12-FW45.....	171	SWF-3X10-FW90.....	184	TAM4A0B42S31ED.....	30	TDEID120A9601A.....	23
SSF-24X12-FW90.....	171	SWF-3X10-SW45.....	184	TAM4AOC48S41.....	34	TDHIB040A9241C.....	15
SSF-24X12-SW45.....	171	SWF-3X10-SW90.....	184	TAM4AOC48S41ED.....	30	TDHIB040A9H21B.....	16

Index by Model Number

TDH1B065A9421C.....	15	TEM8A0C42V41D.....	38	TLEK0610.....	208	TUE1B100A9361A.....	23
TDH1B065A9H31B.....	16	TEM8A0C42V41DA.....	35	LTW5SAE.....	99	TUE1C100A9481A.....	23
TDH1C085A9481C.....	15	TEM8A0C48V41D.....	38	TMM4A0A18S21SA.....	39	TUE1C100A9601A.....	23
TDH1C085A9H41B.....	16	TEM8A0C48V41DA.....	35	TMM4A0A24S21SA.....	39	TUE1D100A9601A.....	23
TDH1D110A9601C.....	15	TEM8A0C60V51D.....	38	TMM4A0B30S21SA.....	39	TUE1D140A9601A.....	23
TDHMB060BCV3VB.....	15	TEM8A0C60V51DA.....	35	TMM5A0B24M21SA.....	39	TUHB040A9241C.....	15
TDHMB080ACV3VB.....	15	TEM8A0D48V41D.....	38	TMM5A0B30M21SA.....	39	TUHB040A9H21B.....	16
TDHMC100ACV4VB.....	15	TEM8A0D48V41DA.....	35	TMM5A0B36M31SA.....	39	TUHB060A9361C.....	15
TDHMD120BCV5VB.....	15	TEM8A0D60V51D.....	38	TR11.....	439	TUHB060A9H31B.....	16
TDLX2010BAG.....	359	TEM8A0D60V51DA.....	35	TR344.....	439	TUHB080A9421C.....	15
TE1K642D175.....	60	TERVR100A9P00A.....	153	TR40.....	168	TUHB080A9H31C.....	16
TE1K642D175B2522AP.....	60	TERVR200A9P00A.....	153	TREM0TE2AHANDAA.....	85, 87, 88	TUHC080A9601C.....	15
TE1K642D210.....	60	TERVR300A9P00A.....	153	TREPROG2AHANDAA.....	85, 87	TUHC100A9481C.....	15
TE2K648D175.....	60	TFD175CLFR000C.....	123	TREWIRE1AHANDAA.....	85, 87	TUHC100A9H41B.....	16
TE2K648D210.....	60	TFD17DCLFR000C.....	123	TS1.....	354	TUHID100A9601C.....	15
TE2K648D210B2522AP.....	60	TFD210CLFR000C.....	123	TS1RB.....	354	TUHID120A9601C.....	15
TE2K648D245.....	60	TFD21DCLFR000C.....	123	TSHD.....	354	TUHM060ACV3VB.....	15
TE31630D145.....	60	TFD245CLFR000C.....	123	TSHDRB.....	354	TUHM080ACV3VB.....	15
TE31630D175.....	60	TFM145B0FRO.....	124	TTA090A300.....	52	TUHC100ACV4VB.....	15
TE32636D145.....	60	TFM175B0FRO.....	124	TTA090G300.....	52	TUHM120ACV5VB.....	15
TE32636D145B1622AP.....	60	TFM210B0FRO.....	124	TTA090G400.....	52	TWE061D300A.....	54
TE32636D175.....	60	TFM215B0AHO.....	124	TTA120A300.....	52	TWE090D300.....	54
TE32636D175B1622AP.....	60	TFM235B0AHO.....	124	TTA120E300.....	52	TWE120D300.....	54
TE32636D210.....	60	TFM245B0FRO.....	124	TTA120G300.....	52	TWE120E300A.....	54
TE32636D210B1622AP.....	60	TFM260B0AHO.....	124	TTA180E300.....	52	TWPR.....	168
TE33636D175.....	60	TG30924D175.....	61	TTP1-14E.....	228	TX-500.....	361
TE33636D210.....	60	TG31930D175.....	61	TUC1B040A9241A.....	16	TY4G.....	344
TE36636D175.....	60	TG32936D175.....	61	TUC1B060A9361A.....	16	TY6.....	344
TE36636D210.....	60	TG36960D210B250.....	61	TUC1B080A9421A.....	16	TZGRA940ABEZEL.....	157
TE47636D175.....	60	TH1100DH1004/U.....	114	TUC1C100A9481A.....	16	TZON1050AC52ZA.....	101
TE47636D210.....	60	TH1100DV1009.....	114	TUC1D100A9601A.....	16	TZONE940AC52ZA.....	157
TE48660D210.....	60	TH3110D1008.....	114	TUC1D120A9601A.....	16	TZWH7940ABEZEL.....	157
TE48660D245.....	60	TH4110D1007.....	114	TUD1A040A9241B.....	22	UC100E1006.....	137
TE48660D245B2722AP.....	60	TH4110U2005.....	114	TUD1A040A9301B.....	22	UC100E1030.....	137
TE50660D210.....	60	TH6210U2001/U.....	113	TUD1A060A9241B.....	22	UC 1636-2.....	91
TEA-2416.....	294	TH6220U2000/U.....	113	TUD1A060A9361B.....	22	UC18W1004.....	137
TEK313.....	261	TH6220WF2006/U.....	109	TUD1B060A9361B.....	22	UC3030-2.....	362
TEM3A0B18S21S.....	38	TH6320R1004.....	113	TUD1B080A9241B.....	22	UC3036-2.....	362
TEM3A0B24S21S.....	38	TH6320WF1005.....	113	TUD1B080A9361B.....	22	UC3636-2.....	362
TEM3A0B30S31S.....	38	TH6320WF2003/U.....	109	TUD1B080A9481B.....	22	UC3640-2.....	362
TEM3A0B36S31S.....	38	TH8110R1008.....	111	TUD1B100A9361B.....	22	UC36W1006.....	137
TEM3A0C42S41S.....	38	TH8320R1003.....	111	TUD1B100A9451B.....	22	UDAP100.....	70
TEM3A0C48S41S.....	38	TH8321R1001.....	111	TUD1C080A9601B.....	22	UDAP125.....	70
TEM3A0C60S51S.....	38	TH8321WF1001/U.....	112	TUD1C100A9481B.....	22	UDAP150.....	70
TEM4A0B18S21S.....	38	TH8732WFH5002/U.....	109	TUD1C100A9601B.....	22	UDAP175.....	70
TEM4A0B18S21SA.....	35	TH9320WF5003.....	111	TUD1C120A9541B.....	22	UDAP200.....	70
TEM4A0B24S21S.....	38	THM6000R7001/U.....	110, 116	TUD1D100A9721B.....	22	UDAP225.....	70
TEM4A0B24S21SA.....	35	THO12-105.....	312	TUD1D120A9601B.....	22	UDAP250.....	70
TEM4A0B30S31S.....	38	THP2400A1027B.....	111	TUD1D140A9601B.....	22	UDAP300.....	70
TEM4A0B30S31SA.....	35	THP2400A1027G.....	111	TUD2A040A9242A.....	21	UDAP300.....	70
TEM4A0C36S41S.....	38	THP2400A1027W.....	111	TUD2A060A9362A.....	21	UDAP350.....	70
TEM4A0C36S41SA.....	35	THR1.....	244	TUD2B060A9362A.....	21	UDAP400.....	70
TEM4A0C42S41S.....	38	THR15.....	244	TUD2B060A9V3VB.....	20	UDAP45.....	70
TEM4A0C42S41SA.....	35	THR24.....	244	TUD2B060ACV32B.....	20	UDAP60.....	70
TEM4A0C48S41S.....	38	THR30.....	244	TUD2B080A9362A.....	21	UDAP75.....	70
TEM4A0C48S41SA.....	35	THUMD200ABM00B.....	138	TUD2B080A9482A.....	21	UDAS100.....	70
TEM4A0C60S51S.....	38	THUMD300ABA00B.....	138	TUD2B080A9V3VB.....	20	UDAS125.....	70
TEM4A0C60S51SA.....	35	THUMD500APA00B.....	138	TUD2B080ACV32B.....	20	UDAS150.....	70
TEM6A0B24H21S.....	38	THX9421R5021BB/U.....	110	TUD2B100A9362A.....	21	UDAS175.....	70
TEM6A0B24H21SA.....	35	THX9421R5021WW/U.....	110	TUD2B100A9V3VB.....	20	UDAS200.....	70
TEM6A0B30H21S.....	38	TIF9010A.....	99	TUD2B100ACV32B.....	20	UDAS300.....	70
TEM6A0B30H21SA.....	35	TIFRX-1A.....	373	TUD2C080ACV42B.....	20	UDAS30.....	70
TEM6A0C36H31S.....	38	TIFXP-1A.....	373	TUD2C100A9482A.....	21	UDAS400.....	70
TEM6A0C36H31SA.....	35	TIFZX.....	373	TUD2C100ACV52B.....	20	UDAS45.....	70
TEM6A0C42H41S.....	38	TK.....	361	TUD2C100B9V5VB1.....	20	UDAS60.....	70
TEM6A0C42H41SA.....	35	TL3-25.....	208	TUD2C120A9542A.....	21	UDAS75.....	70
TEM6A0C48H41S.....	38	TL3-35.....	208	TUD2D120A9602A.....	21	UP10-16 PM A B5/LC.....	235
TEM6A0C60H51S.....	38	TL4-25.....	208	TUD2D120ACV52B.....	20	UP15-10SU7P TLC.....	235
TEM6A0D48H41S.....	38	TL4-35.....	208	TUD2D120B9V5VB1.....	20	UP26-64F.....	232
TEM6A0D48H41SA.....	35	TL5-25.....	208	TUD2D140A9602A.....	21	UP43-75F.....	232
TEM6A0D60H51S.....	38	TL5-35.....	208	TUD2D140A9V5VB.....	20	UPS15-58 FC.....	232
TEM6A0D60H51SA.....	35	TL6-25.....	208	TUD2D140ACV52B.....	20	UPS26-99FC.....	232
TEM8A0B24V21D.....	38	TL6-35.....	208	TUE1A040A9241A.....	23	UPS43-100F.....	232
TEM8A0B24V21DA.....	35	TL7-25.....	208	TUE1A060A9241A.....	23	UPS43-44FC.....	232
TEM8A0B30V31D.....	38	TL7-35.....	208	TUE1A060A9361A.....	23	UR3-68.....	333
TEM8A0B30V31DA.....	35	TL8-35.....	208	TUE1B060A9361A.....	23	US70678.....	134
TEM8A0C36V31D.....	38	TLEK0410.....	208	TUE1B080A9361A.....	23	US71088.....	134
TEM8A0C36V31DA.....	35	TLEK0510.....	208	TUE1B080A9481A.....	23	UV100A1059.....	136

Models and Specifications are Subject to Change Without Notice

Index by Model Number

UV100E1043.....	136	VPS80-30.....	72	YSC092F3EHA0000.....	45	ZDAMPBMAA086A.....	159
UV100E2009.....	136	VPS80-40.....	72	YSC092F4EHA0000.....	45	ZDAMPBMAA088A.....	159
UV2400U1000.....	136	VPT100-30.....	73	YSC102F3EHA0000.....	45	ZDAMPBMAA1012A.....	159
UV2400U5000.....	136	VPT100-40.....	73	YSC120F3EHA0000.....	45	ZDAMPBMAA1014A.....	159
UV2400XLAM1.....	137	VPT125-30.....	73	YSC120F3EMA0000.....	45	ZDAMPBMAA1016A.....	159
UV2400XPC01.....	136	VPT125-40.....	73	YSC120F4EHA0000.....	45	ZDAMPBMAA1020A.....	159
V664.....	321	VPT125-50.....	73	YSC120F4EMA0000.....	45	ZDAMPBMAA1024A.....	159
V8043F1036.....	252	VPT150-40.....	73	YSD150G3RHA0000.....	46	ZDAMPBMAA1024A.....	159
V8043F1051.....	252	VPT150-50.....	73	YSD150G4RHA0000.....	46	ZDAMPBMAA1024A.....	159
VALBAL-112S.....	305	VPT150-60.....	73	YSD180G3RHA0000.....	46	ZDAMPBMAA1024A.....	159
VALBAL-112T.....	305	VPT170-50.....	73	YSD180G4RHA0000.....	46	ZDAMPBMAA1024A.....	159
VALBAL-114S.....	305	VPT170-60.....	73	YSD210G3RHA0000.....	46	ZDAMPBMAA1008A.....	159
VALBAL-114T.....	305	VPT170-70.....	73	YSD210G4RHA0000.....	46	ZDAMPBMAA1010A.....	159
VALBAL-12S.....	305	VPT200-50.....	73	YSD240G3RHA0000.....	46	ZDAMPBMAA1010A.....	159
VALBAL-12T.....	305	VPT200-60.....	73	YSD240G4RHA0000.....	46	ZDAMPBMAA1010A.....	159
VALBAL-1S.....	305	VPT200-70.....	73	YSD300G3RHA0000.....	46	ZDAMPBMAA1010A.....	159
VALBAL-1T.....	305	VPT60-30.....	73	YSD300G4RHA0000.....	46	ZDAMPBMAA1010A.....	159
VALBAL-2S.....	305	VPT60-40.....	73	YSH150G3RHA0000.....	47	ZDAMPBMAA1010A.....	159
VALBAL-2T.....	305	VPT80-30.....	73	YSH150G4RHA0000.....	47	ZDAMPBMAA1010A.....	159
VALBAL-34S.....	305	VPT80-40.....	73	YSH180G3RHA0000.....	47	ZDAMPBMAA1010A.....	159
VALBAL-34T.....	305	VR8200A2132.....	392	YSH180G4RHA0000.....	47	ZDAMPBMAA1010A.....	159
VALBO1-12.....	305	VR8200H1251.....	392	YSH210G3RHA0000.....	47	ZDAMPBMAA1010A.....	159
VALBO1-34.....	305	VR8300A3500.....	392	YSH210G4RHA0000.....	47	ZDAMPBMAA1010A.....	159
VALBO1-34F.....	305	VR8300A4508.....	392	YSH240G3RHA0000.....	47	ZDAMPBMAA1010A.....	159
VALGAS-012.....	305	VR8304M4507.....	393	YSH240G4RHA0000.....	47	ZDAMPBMAA1010A.....	159
VALGAS-034.....	305	VR8345M4302.....	393	YSH300G3RHA0000.....	47	ZDAMPBMAA1010A.....	159
VALSW1-114S.....	305	VS820A1047.....	391	YSH300G4RHA0000.....	47	ZDAMPBMAA1010A.....	159
VALSW1-114T.....	305	VX-075.....	221	YTH6320R1001.....	112	ZDAMPBMAA1010A.....	159
VALSW1-12S.....	305	VX-100.....	221	YTH6320R1114/U.....	112	ZDAMPBMAA1010A.....	159
VALSW1-1S.....	305	VX-150.....	221	YTH8321R1002.....	111	ZDAMPBMAA1010A.....	159
VALSW1-1T.....	305	VX-200.....	221	YTHX9421R5085WG/U.....	110	ZDAMPBMAA1010A.....	159
VALSW1-34S.....	305	VX1000AM.....	215	YTHX9421R5085WW/U.....	110	ZDAMPBMAA1010A.....	159
VALSW1-34T.....	305	VX1000AMWG.....	215	YTHX9421R5101WG.....	110	ZDAMPBMAA1010A.....	159
VCMA-15ULS.....	370	VXSVRAMWG.....	215	YTHX9421R5101WW.....	110	ZDAMPBMAA1010A.....	159
VCMA-20ULS.....	370	W8150A1001.....	154	YTHX9421R5127WW.....	110	ZDAMPBMAA1010A.....	159
VENT-AIRINTAKE-10-GALV.....	188	WATA-2.....	367	Z151000.....	251	ZDAMPBMAA1010A.....	159
VENT-AIRINTAKE-4-GALV.....	188	WCW200.....	105	Z200537.....	251	ZDAMPBMAA1010A.....	159
VENT-AIRINTAKE-6-GALV.....	188	WFE-24.....	257	Z200637.....	251	ZDAMPBMAA1010A.....	159
VENT-AIRINTAKE-8-GALV.....	188	WG840463.....	429	Z55.....	251	ZDAMPBMAA1010A.....	159
VH1-3.....	220	WG840465.....	433	Z56.....	251	ZDAMPBMAA1010A.....	159
VH1-4.....	220	WG840466.....	429	Z57.....	251	ZDAMPBMAA1010A.....	159
VHR70R.....	156	WG840467.....	429	ZCOMBO-G.....	106	ZDAMPBMAA1010A.....	159
VIRKSG-3S.....	424	WG840468.....	433	ZD10X10TZ/U.....	164	ZDAMPBMAA1010A.....	159
VIRVB.....	387	WG840469.....	433	ZD10X12TZ/U.....	164	ZDAMPBMAA1010A.....	159
VNT5150E1000.....	154	WG840583.....	429	ZD10X14TZ/U.....	164	ZDAMPBMAA1010A.....	159
VNT5150H1000.....	154	WG840585.....	429	ZD10X16TZ/U.....	164	ZDAMPBMAA1010A.....	159
VNT5200E1000.....	154	WG840587.....	429	ZD10X18TZ/U.....	164	ZDAMPBMAA1010A.....	159
VNT5200H1000.....	154	WG840589.....	429	ZD10X20TZ/U.....	164	ZDAMPBMAA1010A.....	159
VP-A.....	73	WG840728.....	433	ZD10X24TZ/U.....	164	ZDAMPBMAA1010A.....	159
VP-B.....	73	WG840729.....	433	ZD10X8TZ/U.....	164	ZDAMPBMAA1010A.....	159
VP-C.....	73	WG840730.....	433	ZD12X8TZ/U.....	164	ZDAMPBMAA1010A.....	159
VP-D.....	73	WPSB-7D.....	223	ZD14X10TZ/U.....	164	ZDAMPBMAA1010A.....	159
VP-E.....	73	WPSB-8D.....	223	ZD14X8TZ/U.....	164	ZDAMPBMAA1010A.....	159
VP-H.....	73	WPSB-9D.....	223	ZD16X10TZ/U.....	164	ZDAMPBMAA1010A.....	159
VP-L.....	73	WS-1.....	371	ZD16X8TZ/U.....	164	ZDAMPBMAA1010A.....	159
VP-U.....	73	WSC8.....	345	ZD18X8TZ/U.....	164	ZDAMPBMAA1010A.....	159
VPS100-30.....	72	XE401.....	215	ZD20X10TZ/U.....	164	ZDAMPBMAA1010A.....	159
VPS100-40.....	72	XE406.....	215	ZD20X12TZ/U.....	164	ZDAMPBMAA1010A.....	159
VPS100-50.....	72	XEB-3.....	223	ZD20X8TZ/U.....	164	ZDAMPBMAA1010A.....	159
VPS125-40.....	72	XEB-4.....	223	ZD24X10TZ/U.....	164	ZDAMPBMAA1010A.....	159
VPS125-50.....	72	XEB-5.....	223	ZD24X8TZ/U.....	164	ZDAMPBMAA1010A.....	159
VPS125-60.....	72	XEB-6.....	223	ZD8X10TZ/U.....	164	ZDAMPBMAA1010A.....	159
VPS150-40.....	72	XXDUOSTAT.....	215	ZD8X12TZ/U.....	164	ZDAMPBMAA1010A.....	159
VPS150-50.....	72	XXFIRESTAT.....	215	ZD8X14TZ/U.....	164	ZDAMPBMAA1010A.....	159
VPS150-60.....	72	Y8150A1017.....	155	ZD8X16TZ/U.....	164	ZDAMPBMAA1010A.....	159
VPS150-70.....	72	Y8610U6006.....	401	ZD8X18TZ/U.....	164	ZDAMPBMAA1010A.....	159
VPS170-50.....	72	YCHW4000W4004/U.....	113	ZD8X20TZ/U.....	164	ZDAMPBMAA1010A.....	159
VPS170-60.....	72	YERM 5220 R832.....	111	ZD8X22TZ/U.....	164	ZDAMPBMAA1010A.....	159
VPS170-70.....	72	YERM 5220 RVPEIM.....	111	ZD8X24TZ/U.....	164	ZDAMPBMAA1010A.....	159
VPS170-80.....	72	YSC036G3EHA0000.....	45	ZD8X8TZ/U.....	164	ZDAMPBMAA1010A.....	159
VPS200-50.....	72	YSC036G4EHA0000.....	45	ZDAMPBMAA0810A.....	159	ZDAMPBMAA1010A.....	159
VPS200-60.....	72	YSC048G3EHA0000.....	45	ZDAMPBMAA0812A.....	159	ZDAMPBMAA1010A.....	159
VPS200-70.....	72	YSC048G4EHA0000.....	45	ZDAMPBMAA0814A.....	159	ZDAMPBMAA1010A.....	159
VPS200-80.....	72	YSC060G3EHA0000.....	45	ZDAMPBMAA0816A.....	159	ZDAMPBMAA1010A.....	159
VPS60-20.....	72	YSC060G4EHA0000.....	45	ZDAMPBMAA0818A.....	159	ZDAMPBMAA1010A.....	159
VPS60-30.....	72	YSC072F3EMA0000.....	45	ZDAMPBMAA0820A.....	159	ZDAMPBMAA1010A.....	159
VPS60-40.....	72	YSC072F4EHA0000.....	45	ZDAMPBMAA0824A.....	159	ZDAMPBMAA1010A.....	159

Index by Part Number

10009.....	302	10558.....	287	10992.....	297	11525.....	302	12208.....	299	12473.....	302
10019.....	297	10566.....	364	10994.....	293	11527.....	171	12212.....	303	12478.....	271
10030.....	176	10578.....	391	11002.....	299	11530.....	79	12227.....	286	12485.....	186
10037.....	298	10589.....	302	11014.....	233	11536.....	287	12231.....	202	124932.....	281
10039.....	241	10590.....	286	11016.....	297	11541.....	192	12232.....	358	12498.....	422
10042.....	173	10593.....	192	11017.....	218	11551.....	298	12237.....	285	12499.....	181
10051.....	302	1059.....	345	11044.....	176	11553.....	357	1224.....	206	124998.....	111
10058.....	302	10596.....	190	11048.....	292	11571.....	176	12242.....	182	125090.....	71
1006.....	285	10599.....	424	11050.....	91, 311	11576.....	202	12243.....	366	125094.....	111
10068.....	172	10610.....	169	1106.....	177	1158.....	171	12257.....	374	125095.....	111
1007.....	194	1061.....	183	11062.....	36	11586.....	428	12267.....	208	12511.....	439
10081.....	292	10617.....	305	11080.....	171	11615.....	299	1227.....	205	1251.....	305
10088.....	133	10619.....	301	11083.....	297	11630.....	202	12274.....	358	12515.....	366
10094.....	292	10625.....	383	11101.....	188	1164.....	301	12280.....	264	125198.....	187
10098.....	292	10626.....	264	11116.....	297	11664.....	202	12294.....	69	125199.....	187
10117.....	182	10630.....	301	1112.....	420	11670.....	202	12296.....	176	12521.....	363
10127.....	267	10637.....	301	11134.....	204	11674.....	303	12297.....	169	12525.....	174
10138.....	254	10645.....	301	11135.....	298	11681.....	385	12298.....	173	12527.....	287
10142.....	188	10655.....	301	11142.....	366	11682.....	202	12307.....	301	12530.....	302
10143.....	415	10665.....	301	1114.....	267	11683.....	299	1231.....	302	12537.....	343
10150.....	302	10674.....	301	11152.....	204	11733.....	202	12313.....	374	125384.....	361
10152.....	185	10675.....	174	11161.....	194	11742.....	202	12314.....	193	12545.....	358
1015.....	233	10677.....	18	11162.....	344	117493.....	316	1232.....	257	12551.....	192
10160.....	302	10686.....	301	11174.....	218	11751.....	287	12326.....	193	125517.....	37
10165.....	286	10699.....	305	1118.....	205	11752.....	422	12328.....	176	125518.....	37
10171.....	293	1070.....	428	1120.....	185	11755.....	194	12331.....	439	125519.....	37
10187.....	134	10714.....	298	11204.....	286	11775.....	202	12333.....	355	12554.....	190
10204.....	172	10719.....	253	11207.....	218	11776.....	298	12334.....	190	12559.....	439
10206.....	165	107.....	211	11208.....	186	11777.....	302	12342.....	193	1256.....	206
10219.....	190	10722.....	298	112.....	211	11787.....	202	12349.....	174	125772.....	96
10228.....	298	1073.....	194	11226.....	292	11789.....	392	12355.....	177	12581.....	302
10230.....	177	10733.....	298	1123.....	194	1180.....	285	12359.....	356	125821.....	4
102.....	302	10735.....	177	11245.....	283	11807.....	307	123676.....	218	125822.....	4
10239.....	363	10736.....	253	11255.....	185	118.....	252	12368.....	344	125823.....	4
10265.....	302	10754.....	174	11256.....	368	11834.....	173	123748.....	163	125824.....	4
10270.....	133	10756.....	172	11257.....	425	11845.....	202	123763.....	294	125834.....	2
10277.....	302	10761.....	1	11260.....	194	11851.....	302	12379.....	439	125835.....	2
10283.....	212	1078.....	297	11273.....	366	11852.....	174	123805.....	163	125836.....	2
10287.....	367	10788.....	424	11278.....	298	11856.....	194	123806.....	163	125837.....	2
10293.....	212	107889.....	1, 7	11283.....	188	11863.....	133	123825.....	163	125838.....	9
10299.....	212	10789.....	309	11289.....	205	11865.....	176	123896.....	104	125839.....	9
10305.....	176	107910.....	1, 7	11300.....	366	11866.....	132	12392.....	358	125840.....	9
10315.....	212	10795.....	172	11303.....	297	11870.....	132	12393.....	303	125841.....	9
10320.....	212	10801.....	298	11304.....	297	11875.....	302	123977.....	71	125842.....	8
10331.....	212	10809.....	176	11305.....	298	11895.....	292	12401.....	299	125843.....	8
10340.....	171	108130.....	18, 25	11307.....	184	11926.....	215	124081.....	110	125844.....	8
1034.....	218	108198.....	32	11308.....	190	11927.....	302	12408.....	179	125845.....	8
10345.....	368	10826.....	362	11316.....	292	1194.....	383	124082.....	111	12591.....	332
10360.....	367	10829.....	287	11318.....	407	11947.....	292	124085.....	110	126017.....	324
10362.....	283	10832.....	412	11321.....	176	1196.....	203	124088.....	110	12603.....	271
10379.....	293	10839.....	356	11340.....	386	11969.....	367	124095.....	110	12604.....	367
10380.....	183	10842.....	412	11348.....	208	1197.....	205	124100.....	110	12608.....	363
10382.....	202	10846.....	298	11356.....	296	1198.....	302	124106.....	110	12613.....	367
10384.....	302	10850.....	412	11381.....	305	11983.....	298	124108.....	111	126154.....	327
10392.....	285	1086.....	297	1140.....	205	12009.....	186	124109.....	111	12615.....	439
10396.....	179	10878.....	302	11407.....	301	12037.....	169	1241.....	302	126180.....	382
1040.....	205	10890.....	169	11420.....	179	12040.....	176	12417.....	190	126391.....	72
10405.....	286	10891.....	173	11422.....	194	12055.....	278	12423.....	285	126392.....	72
10423.....	208	10899.....	375	11423.....	192	12077.....	311	12438.....	193	126393.....	72
10434.....	424	10904.....	188	11426.....	174	12091.....	176	12439.....	298	126395.....	72
10436.....	332	10915.....	188	11449.....	133	121.....	211	12453.....	193	126396.....	72
104590.....	18, 25	10924.....	302	11454.....	302	12121.....	369	12455.....	439	126397.....	72
104591.....	18, 25	10931.....	302	11464.....	302	12136.....	133	12456.....	298	126398.....	72
104592.....	18, 25	1093.....	205	11467.....	190	12161.....	133	12457.....	302	126399.....	72
104593.....	18, 25	10939.....	302	11476.....	285	12162.....	286	124587.....	186	126400.....	72
104596.....	18, 25	10942.....	201	11478.....	302	12166.....	134	12464.....	302	126401.....	72
104597.....	18, 25	10943.....	182	11486.....	285	12167.....	176	124686.....	415	126402.....	72
104598.....	18, 25	10949.....	232	11489.....	302	12173.....	286	12470.....	285	126403.....	72
1046.....	205	10955.....	302	11493.....	243	12176.....	177	124703.....	73	126404.....	72
10486.....	301	10956.....	364	11498.....	286	12180.....	417	124704.....	73	126405.....	72
10490.....	194	10959.....	243	11501.....	302	1218.....	296	124705.....	73	126406.....	72
10491.....	192	10962.....	217	11506.....	173	12184.....	298	124706.....	73	126407.....	72
10505.....	186	10970.....	243	11508.....	286	12187.....	283	124707.....	73	126408.....	72
10519.....	424	10976.....	297	11509.....	302	12191.....	358	124708.....	73	126409.....	72
10521.....	416	10977.....	302	11513.....	298	12200.....	299	124709.....	73	126410.....	72
10526.....	176	10982.....	243	11519.....	302	12205.....	69	124710.....	73	126411.....	72
10541.....	174	10988.....	306	11522.....	388	12206.....	286	124715.....	73	126412.....	72

Models and Specifications are Subject to Change Without Notice



Index by Part Number

126413.....	72	12867.....	358	131204.....	244	13351.....	176	135448.....	198	13696.....	169
126414.....	73	12869.....	364	131205.....	244	13358.....	192	135449.....	198	13701.....	184
126415.....	72	128733.....	88	131206.....	244	13367.....	204	135450.....	198	1370.....	268
126417.....	73	128734.....	88	131207.....	244	13371.....	192	135451.....	199	13704.....	271
126418.....	73	128735.....	88	131208.....	244	13372.....	193	135452.....	200	13710.....	364
126419.....	73	128736.....	88	131209.....	244	13374.....	295	135453.....	199	13720.....	192
126420.....	73	128760.....	188	131210.....	244	13382.....	193	135454.....	199	13728.....	204
126421.....	73	128804.....	136	13133.....	193	133833.....	220	135457.....	199	13731.....	377
126422.....	73	128805.....	136	131336.....	266	13392.....	409	135459.....	199	13735.....	190
126424.....	73	12881.....	185	13135.....	419	13399.....	204	135460.....	199	137358.....	345
126425.....	73	1288.....	188	131361.....	1	13400.....	177	135462.....	198	13736.....	248
126426.....	73	12883.....	171	131362.....	1	13401.....	312	135464.....	198	13739.....	377
126427.....	73	128928.....	319	131363.....	1	134093.....	36	135466.....	198	137422.....	60
126428.....	73	128931.....	318	131364.....	1	134094.....	37	135468.....	197	13742.....	364
126429.....	73	128935.....	136	131365.....	1	134096.....	37	135469.....	197	13745.....	439
126430.....	73	128938.....	137	131367.....	1	134127.....	157	135470.....	197	13747.....	302
126431.....	73	12902.....	271	131368.....	1	134128.....	157	135471.....	197	13750.....	204
126432.....	73	12910.....	401	131369.....	7	134165.....	282	135472.....	197	13751.....	312
126433.....	73	12912.....	302	131370.....	7	134166.....	385	135474.....	198	1375.....	133
126434.....	73	12914.....	173	131371.....	7	134167.....	385	135475.....	197	13753.....	439
12644.....	176	12915.....	365	131372.....	7	134168.....	385	135476.....	197	13755.....	192
12648.....	177	129173.....	255	131373.....	7	134169.....	385	135478.....	198	137564.....	152
126484.....	93	129174.....	255	131375.....	7	13417.....	376	135479.....	198	137652.....	218
126503.....	94	129343.....	32, 36	131376.....	7	1342.....	304	135480.....	199	1377.....	194
126639.....	94	129393.....	129	131406.....	45	13427.....	169	135481.....	198	13772.....	204
12666.....	285	129395.....	128	1314.....	173	134272.....	329	135483.....	198	13774.....	190
126665.....	95	1294.....	285	13146.....	193	13428.....	376	135484.....	198	13783.....	190
126666.....	96	12945.....	189	131495.....	45	13429.....	204	135485.....	199	137854.....	49
126667.....	93	12957.....	286	13151.....	425	134.....	367	135486.....	200	137855.....	49
12671.....	365	12959.....	295	13154.....	193	134438.....	258	135487.....	199	137862.....	49
126724.....	99	12966.....	311	131556.....	324	13458.....	204	135488.....	199	13793.....	204
12683.....	298	129744.....	188	13158.....	177	134584.....	422	135491.....	199	1379.....	356
12684.....	440	129817.....	93	13159.....	295	134585.....	423	135493.....	199	13794.....	193
12685.....	302	129818.....	93	131593.....	321	134586.....	422	135494.....	199	13795.....	419
12687.....	366	129819.....	304	13170.....	192	134587.....	423	135495.....	199	138044.....	85, 87
126889.....	192	129820.....	304	13173.....	182	134588.....	423	135496.....	198	138064.....	102
126890.....	193	129821.....	304	131826.....	196	134589.....	423	135497.....	198	138066.....	102
126961.....	439	129822.....	304	13185.....	184	134590.....	423	13550.....	174	13809.....	178
126977.....	36	12991.....	332	13191.....	283	134591.....	422	135503.....	199	13811.....	425
12706.....	298	129941.....	375	1319.....	194	13459.....	364	135504.....	199	13814.....	204
1271.....	365	13002.....	426	13195.....	46, 50	134594.....	247	135505.....	199	138212.....	274
12722.....	439	13007.....	332	132041.....	210	134595.....	247	135507.....	199	13822.....	173
12723.....	302	13010.....	169	13208.....	175	13461.....	190	135509.....	199	138222.....	179
127.....	379	130.....	211	13226.....	175	13474.....	409	135510.....	199	138225.....	179
127401.....	351	130213.....	111	13233.....	193	13479.....	295	13551.....	172	138226.....	179
127402.....	351	1302.....	284	13235.....	193	134814.....	49	135535.....	198	138227.....	179
127403.....	351	130239.....	93	132431.....	192	134815.....	49	135536.....	200	13823.....	206
127404.....	351	130240.....	93	13243.....	193	134816.....	49	135571.....	354	13825.....	187
127405.....	351	130241.....	93	13249.....	426	134817.....	49	13567.....	204	13834.....	184
127406.....	351	130242.....	93	13251.....	193	134818.....	49	1357.....	304	13842.....	364
127407.....	350	13026.....	314	13259.....	377	134819.....	49	13577.....	286	13850.....	215
127408.....	350	13029.....	175	13260.....	193	134820.....	49	13578.....	367	13851.....	204
127410.....	350	130319.....	71	132616.....	152	134821.....	49	135807.....	407	13856.....	204
127411.....	350	130352.....	281	13262.....	302	13485.....	409	13582.....	204	13859.....	176
127412.....	350	130356.....	281	132641.....	114	13490.....	299	13589.....	312	1386.....	233
127413.....	350	130357.....	281	13270.....	302	13499.....	312	13606.....	204	138635.....	60
12742.....	363	13040.....	204	132718.....	146	13500.....	192	13609.....	182	138647.....	57
127580.....	102	130460.....	7	13274.....	46, 49, 50	13501.....	204	13614.....	184	138648.....	57
127581.....	102	13046.....	79	13282.....	302	13512.....	202	136166.....	49	138649.....	57
12766.....	436	13051.....	193	13283.....	209	1353.....	285	13619.....	204	138650.....	57
127820.....	103	130522.....	223	132840.....	248	135342.....	440	13625.....	312	138651.....	57
127821.....	103	13056.....	204	13295.....	357	135429.....	199	136378.....	128	138652.....	57
127902.....	284	13061.....	330	13297.....	302	135430.....	199	13640.....	193	138653.....	57
127917.....	341	13067.....	278	13302.....	171	135431.....	199	13641.....	174	138654.....	57
12793.....	293	13075.....	184	13307.....	302	135433.....	199	136422.....	331	13871.....	362
12796.....	178	13085.....	174	13313.....	302	135435.....	197	13644.....	364	138740.....	274
12797.....	366	13086.....	193	133166.....	297	135436.....	197	13653.....	204	13875.....	133
12814.....	302	130868.....	275	133167.....	297	135437.....	197	13654.....	343	13879.....	204
128183.....	171	130869.....	275	133211.....	140	135438.....	197	13655.....	248	13880.....	301
128186.....	169	13087.....	343	13328.....	302	135439.....	197	13659.....	193	13881.....	99
1282.....	194	130881.....	277	1333.....	185	135440.....	198	13679.....	243	13888.....	134
12827.....	302	130884.....	275	13335.....	299	135441.....	197	13680.....	190	138895.....	387
12842.....	298	130918.....	370	13337.....	302	135442.....	197	13684.....	204	138896.....	387
12843.....	176	131017.....	143	13340.....	186	135444.....	366	13685.....	376	138897.....	388
12856.....	203	1310.....	257	13343.....	364	135445.....	198	136905.....	358	138899.....	388
128581.....	88	131202.....	283	13348.....	192	135446.....	198	13691.....	376	138900.....	388
128597.....	200	131203.....	283	13349.....	204	135447.....	199	13693.....	193	138901.....	388

Index by Part Number

13891.....	204	14094.....	242	14380.....	301	146820.....	362	15033.....	301	15612.....	355
13892.....	294	14099.....	133	143805.....	264	14691.....	299	15038.....	93	15618.....	384
13893.....	301	14103.....	417	143815.....	264	14694.....	148	15048.....	174	15624.....	384
13896.....	412	141075.....	326	143816.....	264	146964.....	135	1505.....	305	15638.....	314
138982.....	368	14113.....	305	143818.....	264	147062.....	36	15068.....	225	15640.....	195
138983.....	368	14116.....	203	143819.....	264	147072.....	323	15108.....	301	15645.....	180
13903.....	192	14126.....	374	143820.....	264	147079.....	41	15113.....	133	1565.....	174
13904.....	204	141350.....	333	143821.....	264	147080.....	41	15114.....	301	15656.....	384
13905.....	301	14139.....	297	143822.....	264	147082.....	41	15116.....	365	15658.....	301
13907.....	412	14140.....	301	143823.....	264	147083.....	41	15122.....	301	15663.....	285
1391.....	66	14141.....	171	14390.....	301	147113.....	6	15145.....	315	15672.....	175
13917.....	403	141462..	3, 5, 6, 8, 10	144017.....	238	147114.....	6	15152.....	182	15697.....	180
13922.....	204	141660.....	51	144058.....	29, 31	147124.....	6	15166.....	225	15698.....	219
13923.....	297	141708.....	257	144060.....	375	1473.....	185	15167.....	393	15702.....	133
13926.....	403	14176.....	417	144062.....	375	14732.....	262	15168.....	267	15719.....	190
13936.....	417	14177.....	175	14407.....	175	147369.....	35	15177.....	342	15724.....	314
13940.....	403	14180.....	374	14410.....	366	147370.....	35	1518.....	172	15731.....	285
139432.....	197	14181.....	298	144118.....	6	147371.....	35	15186.....	301	15742.....	268
139433.....	197	141880.....	156	144121.....	6	147372.....	35	15190.....	382	1574.....	420
139434.....	197	14195.....	349	144122.....	6	147373.....	35	15203.....	298	15746.....	302
139435.....	198	14197.....	268	144123.....	6	147375.....	35	15227.....	194	15757.....	366
139436.....	198	14205.....	193	144124.....	6	147376.....	9	1523.....	174	15762.....	267
139437.....	198	14207.....	298	144126.....	6	147378.....	9	15.....	232	15779.....	299
139447.....	197	142144.....	110	144127.....	6	147382.....	9	15238.....	366	15784.....	301
139448.....	197	142145.....	111	144137.....	85, 87, 88	147383.....	9	15239.....	189	15790.....	180
139449.....	197	142146.....	340	14417.....	287	147384.....	9	15252.....	301	15799.....	208
139450.....	198	142147.....	340	14422.....	333	147385.....	9	15263.....	301	15807.....	287
139451.....	198	142157.....	229	14425.....	344	147396.....	8	15266.....	225	1582.....	173
139452.....	198	142158.....	229	14432.....	302	147397.....	8	15267.....	307	15828.....	332
13949.....	403	142159.....	229	144329.....	414	147398.....	8	15272.....	384	1583.....	366
13950.....	228	142160.....	229	14433.....	344	147399.....	8	15274.....	344	15847.....	79
13957.....	204	142168.....	387	14434.....	315	147400.....	8	15283.....	384	15851.....	332
13959.....	301	142169.....	387	144350.....	2	147402.....	8	15287.....	304	15858.....	265
13961.....	311	14221.....	286	144362.....	264	14741.....	302	15296.....	384	1586.....	305
13962.....	403	1422.....	233	144431.....	421	1474.....	190	15297.....	307	15868.....	283
1396.....	267	14228.....	299	14458.....	355	14749.....	261	15298.....	194	1587.....	248
13966.....	204	1423.....	260	144659.....	226	14773.....	172	15316.....	301	15888.....	356
13978.....	403	14235.....	193	144663.....	226	14774.....	170	15326.....	203	15903.....	208
1398.....	236	14237.....	374	144674.....	226	14778.....	408	15333.....	133	15907.....	293
13986.....	204	14238.....	201	144675.....	226	14786.....	175	15334.....	205	15908.....	425
13988.....	403	142383.....	49	144678.....	226	14787.....	173	15344.....	384	15910.....	189
139923.....	84, 86	142389.....	257	144679.....	226	14792.....	79	15348.....	174	15913.....	208
139924.....	84, 86	14240.....	297	144680.....	226	14797.....	357	15355.....	205	159149.....	273
139926.....	84, 86	142417.....	106	144681.....	226	14798.....	374	15364.....	384	159151.....	273
139927.....	84, 86	14247.....	201	144682.....	226	14804.....	408	15365.....	194	159152.....	274
139928.....	84	14248.....	174	144684.....	226	14807.....	180	15379.....	238	15916.....	296
13993.....	294	14256.....	201	144685.....	226	148.....	211	15383.....	225	15923.....	172
13994.....	204	142609.....	4	144687.....	226	14821.....	297	15385.....	205	159252.....	44
13996.....	403	14268.....	301	144688.....	226	14824.....	363	15390.....	301	159260.....	273
140033.....	251	14269.....	304	144689.....	226	14829.....	428	15399.....	367	159262.....	276
140034.....	251	14274.....	93	14472.....	177	14830.....	293	1540.....	203	159263.....	275
140035.....	251	142763.....	35	14477.....	297	14832.....	363	15405.....	174	159264.....	273
140036.....	251	142764.....	35	14482.....	333	14833.....	173	15412.....	307	159268.....	273
140037.....	251	142765.....	35	144937.....	265	14843.....	293	15417.....	292	159270.....	277
140038.....	251	142766.....	35	14535.....	366	14847.....	187	15423.....	384	159271.....	277
14008.....	417	142767.....	35	14538.....	297	14855.....	293	15437.....	384	159272.....	277
14009.....	301	142768.....	35	14540.....	190	14864.....	306	15448.....	292	159273.....	277
14011.....	403	142769.....	35	14547.....	363	14881.....	303	15455.....	384	159322.....	437
14018.....	286	14278.....	193	14549.....	304	14886.....	285	15460.....	366	15943.....	286
14019.....	354	1428.....	185	14559.....	287	14887.....	174	15474.....	180	15955.....	366
14023.....	203	14283.....	188	14576.....	297	14913.....	396	15477.....	201	159555.....	44
140252.....	388	14300.....	376	145835.....	106	14928.....	175	15484.....	384	159556.....	44
140265.....	42	14302.....	297	14592.....	174	14929.....	287	15493.....	384	159557.....	44
14031.....	186	14311.....	376	1460.....	190	14930.....	192	15506.....	201	159559.....	44
14033.....	438	14312.....	332	146057.....	101	14946.....	241	15510.....	225	159569.....	373
14034.....	357	14315.....	170	146058.....	101	14953.....	178	15516.....	378	159621.....	165
14042.....	184	14325.....	294	146070.....	102	14954.....	326	15524.....	178	159668.....	135
140499.....	3, 5, 8, 10	14328.....	418	14615.....	297	14955.....	241	15530.....	202	15971.....	428
140536.....	387	14344.....	294	14636.....	172	14957.....	366	15538.....	314	159781.....	328
14057.....	242	14345.....	193	14637.....	185	14976.....	363	15539.....	195	159785.....	329
140600.....	387	14348.....	293	14638.....	244	14978.....	241	15541.....	301	15980.....	172
14071.....	242	143498.....	255	146513.....	388	1499.....	194	15544.....	180	159808.....	234
14073.....	204	14353.....	192	146517.....	355	14995.....	285	1556.....	185	15989.....	302
14074.....	189	14362.....	297	14654.....	299	14997.....	357	15577.....	384	15993.....	180
14076.....	301	14367.....	178	146599.....	320	15002.....	268	15594.....	367	159967.....	221
14081.....	242	14373.....	417	146602.....	281	15003.....	381	15595.....	384	159968.....	221
1408.....	357	143747.....	225	14663.....	363	150.....	202	15606.....	203	159969.....	221
14087.....	297	143752.....	225	146638.....	105	1503.....	282	15611.....	225	159970.....	221

Models and Specifications are Subject to Change Without Notice



Index by Part Number

15998.....	301	161692.....	164	16468.....	298	16931.....	384	172272.....	118	173869.....	211
159986.....	281	161693.....	164	16471.....	267	16935.....	132	172274.....	118	173870.....	211
16001.....	208	16170.....	303	1647.....	184	16948.....	148	172277.....	73	173871.....	211
160099.....	85, 87, 88	16176.....	217	16478.....	248	16960.....	315	17232.....	176	173872.....	211
1601.....	215	161882.....	64	16480.....	298	169673.....	165	17233.....	184	173883.....	334
16012.....	189	16190.....	302	164850.....	146	169674.....	165	172392.....	266	17432.....	305
16013.....	208	16203.....	424	164851.....	146	169675.....	165	17239.....	301	17437.....	367
16018.....	422	1620.....	384	164852.....	146	169701.....	362	17251.....	206	17441.....	425
16019.....	296	16213.....	244	164853.....	146	169702.....	362	1725.....	195	17444.....	292
160212.....	84	162151.....	44	164854.....	116	169703.....	362	172556.....	39	17445.....	184
160226.....	247	162228.....	351	16486.....	383	16971.....	171	172596.....	227	17447.....	305
160382.....	326	162250.....	387	16487.....	299	169763.....	362	172597.....	227	1746.....	285
16038.....	374	162259.....	273	164891.....	251	169764.....	362	172598.....	227	17464.....	306
160468.....	84	1623.....	133	16495.....	424	169776.....	311	172640.....	63	174659.....	43
16047.....	178	16235.....	309	16499.....	183	169777.....	311	1727.....	193	174662.....	43
16048.....	366	16237.....	360	16500.....	359	1698.....	287	17276.....	301	174663.....	43
16052.....	297	162414.....	97	16509.....	180	16988.....	204	172764.....	337	174664.....	43
16059.....	244	162416.....	97	16510.....	186	169920.....	155	172772.....	341	174665.....	43
160602.....	177	162417.....	97	165124.....	146	16996.....	172	172788.....	4	174666.....	43
160603.....	177	162418.....	97	165135.....	39	16998.....	297	172790.....	4	174667.....	43
160604.....	177	162419.....	92	16516.....	355	17001.....	204	172791.....	4	174668.....	43
160605.....	177	16245.....	295	16523.....	383	170026.....	165	172792.....	4	174672.....	43
160607.....	177	16246.....	189	16528.....	303	17005.....	190	17279.....	371	174674.....	43
160608.....	177	16249.....	170	16529.....	370	17008.....	175	172794.....	4	174677.....	175
16067.....	79	16254.....	293	1654.....	187	170123.....	93	172795.....	4	17475.....	182
16071.....	308	16258.....	301	16545.....	366	17015.....	315	172798.....	4	174881.....	40
16084.....	374	1626.....	310	16567.....	411	170174.....	102	172799.....	4	174882.....	40
160844.....	93	162749.....	321	16571.....	174	17021.....	180	172801.....	2	174883.....	40
16093.....	286	162771.....	321	16582.....	292	17026.....	177	172801.....	303	174884.....	40
16095.....	424	16277.....	174	16591.....	178	170329.....	155	172803.....	2	174885.....	40
161003.....	380	162789.....	365	16592.....	172	17034.....	184	172805.....	2	174886.....	40
161004.....	386	16283.....	297	16614.....	174	17045.....	133	172808.....	2	174887.....	40
161007.....	383	16290.....	301	16624.....	180	170497.....	311	172810.....	2	174888.....	40
1610.....	419	16296.....	371	1664.....	182	17051.....	248	172813.....	2	174889.....	40
16106.....	286	16297.....	345	16643.....	295	17055.....	134	172814.....	2	174890.....	40
16108.....	309	16299.....	424	16648.....	149	170563.....	368	172815.....	2	174891.....	40
16123.....	208	163017.....	18	1665.....	173	17057.....	315	17291.....	297	174892.....	40
161275.....	3, 5, 8, 10	16313.....	304	16657.....	299	17065.....	204	17292.....	301	174893.....	40
161357.....	52	16314.....	364	16658.....	180	170763.....	121	17298.....	267	174894.....	40
161358.....	52	163250.....	36	16660.....	175	17081.....	204	173041.....	169	174895.....	40
16149.....	293	163251.....	36	16666.....	299	170870.....	327	173042.....	169	174896.....	40
16155.....	171	163252.....	36	16670.....	286	170871.....	45, 49	17304.....	286	174897.....	40
16156.....	244	163256.....	36	16677.....	241	170872.....	45, 49	173043.....	169	174898.....	40
161567.....	93	163257.....	36	16680.....	296	17091.....	422	173044.....	169	174899.....	40
161641.....	165	163258.....	36	1668.....	171	170924.....	321	173045.....	169	174900.....	40
16164.....	203	163455.....	112	16686.....	180	170928.....	205	173046.....	169	174901.....	40
161644.....	162	16346.....	366	16695.....	286	170929.....	205	173047.....	169	174902.....	40
161645.....	162	163473.....	128	16702.....	299	17099.....	315	173048.....	169	174903.....	40
161646.....	162	163474.....	129	16711.....	203	17100.....	204	17307.....	301	174904.....	40
161647.....	162	163476.....	129	167.....	211	171008.....	59	1731.....	187	174905.....	40
161648.....	162	16353.....	173	16722.....	180	171009.....	59	17314.....	301	174906.....	40
161649.....	162	1636.....	187	1672.....	366	171010.....	59	17323.....	301	174907.....	40
161650.....	162	16369.....	356	16731.....	302	171011.....	59	17331.....	311	174908.....	40
161652.....	164	16372.....	364	16741.....	315	171012.....	59	173344.....	117	174909.....	40
161653.....	164	1637.....	294	16752.....	411	171013.....	59	173347.....	117	174910.....	40
161654.....	164	16375.....	305	16754.....	257	171013.....	292	173349.....	117	174911.....	40
161655.....	164	163845.....	37	16765.....	178	17107.....	175	17335.....	301	174912.....	40
161656.....	164	16387.....	132	16766.....	175	17109.....	299	17339.....	205	174913.....	40
161657.....	164	163926.....	39	16772.....	356	17111.....	287	17340.....	175	174914.....	40
161658.....	164	163930.....	1	16791.....	315	17117.....	360	17342.....	301	174915.....	40
161659.....	164	163946.....	39	1679.....	308	17128.....	247	17349.....	301	174916.....	42
161665.....	164	164102.....	399	16803.....	292	17129.....	287	173511.....	390	174917.....	42
161666.....	164	16410.....	424	16813.....	66	171322.....	36	17354.....	205	174918.....	42
161669.....	164	16413.....	364	16820.....	175	17133.....	175	173551.....	389	174919.....	42
161670.....	164	164148.....	152	16843.....	411	17146.....	133	17358.....	301	174920.....	42
161672.....	164	164189.....	121	16844.....	180	171568.....	366	17377.....	428	174921.....	42
161676.....	164	164253.....	340	16854.....	315	17157.....	202	17379.....	205	174922.....	42
161677.....	164	16429.....	307	16860.....	299	17183.....	172	17382.....	171	17492.....	303
161678.....	164	16437.....	150	16868.....	79	17187.....	315	173845.....	210	174923.....	42
161681.....	164	1644.....	202	16869.....	355	17190.....	356	173847.....	210	174924.....	42
161683.....	164	16446.....	295	16871.....	176	17196.....	174	173848.....	210	174925.....	42
161685.....	164	164497.....	237	16882.....	175	171966.....	398	173849.....	210	174926.....	42
161686.....	164	164514.....	434	16886.....	188	17206.....	301	17386.....	176	174927.....	42
161687.....	164	16455.....	184	16892.....	175	17211.....	190	173863.....	211	174928.....	42
161688.....	164	16456.....	185	16909.....	299	17215.....	393	173865.....	211	17493.....	247
161689.....	164	164670.....	84	16912.....	315	172212.....	216	173866.....	211	17511.....	324
161690.....	164	164671.....	84	16915.....	180	172214.....	216	173867.....	211	17518.....	176
161691.....	164	16467.....	203	1692.....	68	1722.....	287	173868.....	211	175189.....	430

Index by Part Number

175190.....	430	17761.....	300	179571.....	287	182183.....	61	184613.....	328	187882.....	53
175192.....	430	17762.....	202	179574.....	287	182184.....	61	18473.....	293	187885.....	53
175193.....	430	17763.....	172	179575.....	287	1822.....	192	184764.....	224	187886.....	53
175194.....	434	177745.....	326	179576.....	287	18225.....	298	18477.....	193	187899.....	121
175195.....	434	177750.....	328	179577.....	287	182339.....	61	1848.....	218	187910.....	121
175196.....	434	177768.....	109	17962.....	302	182358.....	426	18485.....	217	187911.....	121
175197.....	430	17778.....	180	1798.....	438	18238.....	355	18493.....	287	18792.....	297
175198.....	430	17799.....	203	17991.....	298	18240.....	196, 366	18494.....	217	187972.....	173
175199.....	434	178182.....	1	1799.....	344	18241.....	179	184951.....	281	187973.....	173
175200.....	430	17821.....	356	180086.....	13	18242.....	171	184952.....	281	187974.....	173
175201.....	434	17858.....	180	180201.....	84	18247.....	207	18499.....	175	187975.....	173
17530.....	177	178649.....	39	180202.....	84	18249.....	301	18500.....	163	18798.....	173
17531.....	227	178650.....	39	180203.....	84	18250.....	381	1850.....	204	187983.....	186
175352.....	227	178651.....	39	180204.....	84	182576.....	287	185067.....	73	188000.....	218
175356.....	227	178653.....	39	180205.....	84	182577.....	287	185069.....	188	188001.....	218
175360.....	227	17874.....	316	180206.....	84	182578.....	287	18508.....	175	188003.....	83
17537.....	297	178768.....	359	180207.....	84	18258.....	285	185187.....	45	188004.....	83
175420.....	116	178786.....	348	180208.....	84	182626.....	60	1852.....	438	188005.....	83
175421.....	116	17882.....	133	18027.....	181	182627.....	60	18528.....	180	188006.....	83
17548.....	366	178831.....	176	180427.....	39, 43	18265.....	285	18529.....	247	1880.....	192
175526.....	237	178832.....	176	180428.....	43	182685.....	311	185426.....	188	188037.....	83
175544.....	309	17883.....	298	180429.....	43	18269.....	355	18548.....	356	188038.....	83
175551.....	310	178833.....	176	180430.....	39, 43	18275.....	297	185536.....	109	188039.....	83
175552.....	310	178834.....	176	180431.....	43	18277.....	316	185538.....	109	188042.....	83
175553.....	310	178842.....	9	18043.....	176	18278.....	302	185540.....	113	188043.....	83
17556.....	300	178843.....	9	180432.....	43	18281.....	218	185542.....	113	188044.....	83
17574.....	190	178844.....	9	180478.....	45	18286.....	302	185716.....	6	188045.....	83
17586.....	366	178846.....	9	18049.....	322	1829.....	204	185717.....	6	188047.....	83
17592.....	287	178847.....	9	18053.....	177	18292.....	175	185718.....	6	188048.....	83
17598.....	341	178848.....	9	18054.....	218	18295.....	287	18576.....	180	188049.....	83
176014.....	111	179014.....	437	180543.....	71	18299.....	297	18579.....	216	188064.....	421
176015.....	111	17904.....	187	180545.....	71	182994.....	129	18589.....	425	18816.....	297
176016.....	111	17906.....	286	180549.....	71	18300.....	302	18591.....	287	188172.....	1, 3, 5-8, 10
17606.....	341	17910.....	295	180552.....	93	18307.....	287	18595.....	177	188173.....	1, 3, 5-8, 10
176186.....	309	1791.....	269	180554.....	93	18308.....	175	185978.....	84	18818.....	182
176195.....	437	17920.....	69	18056.....	302	18311.....	302	185981.....	84	188217.....	33
176210.....	154	179241.....	437	18058.....	432	1832.....	193	18604.....	175	188.....	285
176303.....	116	17929.....	52	18060.....	316	183222.....	79	18613.....	366	18829.....	219
176305.....	116	179296.....	39	180628.....	275	18322.....	297	186238.....	6	188347.....	139
1763.....	419	179298.....	39	180703.....	9	18323.....	302	18635.....	333	188348.....	139
176.....	379	179302.....	75	18075.....	217	18326.....	180	18639.....	175	18836.....	173
17638.....	341	17932.....	298	18076.....	287	18328.....	302	18644.....	203	18837.....	171
17640.....	375	179331.....	75	180789.....	113	183339.....	362	186501.....	373	188405.....	192
17642.....	353	179401.....	180	180791.....	113	18339.....	302	18650.....	190	18841.....	252
176503.....	364	179403.....	180	18079.....	170	18353.....	179	18657.....	172	188529.....	84
17652.....	357	1794.....	169	180825.....	41	1835.....	365	186661.....	135	188530.....	84
1765.....	285	179539.....	287	180834.....	235	18364.....	172	18674.....	180	188539.....	80
176606.....	74	179540.....	287	180959.....	437	18367.....	190	186769.....	29, 31, 32	18858.....	133
176607.....	74	179541.....	287	18099.....	217	18372.....	180	18696.....	148	18859.....	133
176608.....	74	179542.....	287	18107.....	203	183732.....	45	18701.....	388	1886.....	364
176667.....	307	179543.....	287	1811.....	133	18373.....	311	18705.....	365	188641.....	147
176669.....	307	179544.....	287	18117.....	217	183733.....	45	18707.....	218	18868.....	134
17671.....	298	179545.....	287	18120.....	149	183734.....	45	18710.....	383	188746.....	50
176738.....	13	179546.....	287	181326.....	45	183770.....	121	1871.....	204	188747.....	50
17675.....	267	179547.....	287	18134.....	169	18381.....	181	18715.....	188	188748.....	50
17680.....	186	179548.....	287	18137.....	172	183907.....	406	187370.....	186	188749.....	50
17693.....	180	179549.....	287	181423.....	329	183908.....	409	187371.....	186	188871.....	12
176969.....	229	179550.....	287	1814.....	379	183909.....	409	187372.....	180	188872.....	12
176970.....	229	179551.....	287	18146.....	217	183910.....	409	187436.....	306	188873.....	12
176971.....	229	179552.....	287	18154.....	190	183911.....	409	187443.....	306	188874.....	12
17698.....	286	179553.....	287	18161.....	217	18391.....	189	187451.....	306	188875.....	12
17700.....	302	179554.....	287	18167.....	186	18392.....	182	187453.....	306	188876.....	12
177037.....	370	179555.....	287	18169.....	190	183989.....	321	187487.....	306	188877.....	12
177181.....	437	179556.....	287	181702.....	41	183990.....	317	18749.....	305	188878.....	12
177185.....	437	179557.....	287	18186.....	292	18402.....	175	187508.....	306	188879.....	12
177.....	188	179558.....	287	182004.....	133	18412.....	203	187510.....	306	188880.....	12
177188.....	437	179559.....	287	182005.....	86	18422.....	309	187515.....	306	188882.....	13
177191.....	437	179560.....	287	182006.....	86	184246.....	309	18755.....	369	188883.....	13
17719.....	180	179561.....	287	182007.....	86	18427.....	216	187594.....	306	188884.....	13
177194.....	437	179562.....	287	182008.....	86	18432.....	180	187656.....	306	188885.....	13
177197.....	437	179563.....	287	18203.....	301	184328.....	224	187657.....	306	188886.....	13
177199.....	437	179564.....	287	18206.....	311	184371.....	1	187659.....	306	188909.....	12
1772.....	192	179565.....	287	182079.....	41	18437.....	356	18766.....	202	188915.....	164
177292.....	293	179566.....	287	182115.....	63	184389.....	121	187688.....	182	18902.....	302
1773.....	379	179567.....	287	182117.....	63, 83	184390.....	121	18769.....	271	18919.....	149
17740.....	148	179568.....	287	182118.....	83	18439.....	181	187867.....	53	18920.....	298
17743.....	184	179569.....	287	182119.....	63, 83	18447.....	169	187869.....	53	18928.....	188
17745.....	297	179570.....	287	182182.....	61	18453.....	271	187880.....	53	189306.....	84

Models and Specifications are Subject to Change Without Notice



Index by Part Number

189308.....	84	190956.....	246	192158.....	363	193974.....	46	19744.....	93	20899.....	237
189526.....	84	19097.....	174	192159.....	363	193975.....	47	19747.....	363	20901.....	233
189527.....	84	190999.....	114	192161.....	94	193976.....	47	197476.....	126	20912.....	190
189693.....	29, 31	19104.....	250	192162.....	94	194296.....	334	197477.....	126	20919.....	134
189838.....	48	19115.....	374	192163.....	94	194297.....	334	197479.....	126	20920.....	134
189839.....	48	19118.....	195	192164.....	94	194298.....	335	197480.....	126	20926.....	172
189840.....	48	191209.....	176	192165.....	94	194300.....	339	19748.....	363	20930.....	170
189841.....	48	19128.....	183	192166.....	94	194301.....	334	1975.....	362	20944.....	174
189842.....	48	191336.....	4	192167.....	94	194304.....	334	197538.....	125	20946.....	341
189843.....	48	191337.....	4	192168.....	94	194305.....	334	197541.....	125	20947.....	341
189845.....	48	191338.....	4	192169.....	94	194306.....	335	197875.....	434	2095.....	425
189847.....	48	191339.....	4	192170.....	94	194307.....	335	197876.....	434	20965.....	388
189850.....	48	191340.....	4	192171.....	94	194308.....	335	197877.....	434	20987.....	133
189926.....	339	191341.....	4	192172.....	94	194331.....	339	197878.....	431	21040.....	66
190103.....	325	191342.....	4	192188.....	29	194332.....	339	197879.....	431	21089.....	396
190115.....	105	191367.....	47	19220.....	175	194346.....	340	197880.....	431	21120.....	371
190.....	211	191370.....	47	19222.....	308	194347.....	386	197881.....	431	21133.....	321
190309.....	340	191388.....	373	192311.....	218	194348.....	339	197882.....	431	21172.....	188
190314.....	345	191392.....	89	192334.....	47	194349.....	339	197883.....	431	21174.....	133
190315.....	339	191393.....	89	19238.....	308	194350.....	339	197885.....	431	21194.....	67
190316.....	337	191394.....	89	19239.....	170	194351.....	387	197886.....	431	2126.....	253
190317.....	336	191395.....	89	19240.....	203	194353.....	387	197887.....	431	21296.....	260
190319.....	322	191396.....	89	192470.....	46	194354.....	319, 325	197888.....	431	2130.....	293
190320.....	99	191397.....	89	19247.....	314	194394.....	365	197889.....	431	21350.....	379
190322.....	373	191398.....	89	192491.....	47	194.....	432	197891.....	434	21351.....	171
190337.....	101	191399.....	89	192516.....	74	194639.....	155	197986.....	430	21352.....	171
190338.....	101	191400.....	89	192519.....	74	194680.....	12	197987.....	430	21416.....	174
190392.....	346	191401.....	89	192521.....	74	194687.....	12	197989.....	430	21467.....	169
190493.....	62	191402.....	89	192540.....	46	194688.....	12	19839.....	174	21468.....	171
190494.....	62	191403.....	89	192560.....	120	194691.....	12	1984.....	304	21469.....	172
190495.....	62	1914.....	174	192561.....	120	194692.....	12	19915.....	187	21470.....	171
190496.....	62	19142.....	375	192565.....	120	194693.....	12	1993.....	304	21471.....	169
190497.....	61	19143.....	310	19260.....	169	194694.....	12	19951.....	184	21472.....	171
190499.....	61	191494.....	153	192674.....	86	194698.....	12	1998.....	238	21473.....	171
190500.....	61	191495.....	153	19270.....	133	194700.....	12	20005.....	190	21474.....	171
190501.....	61	191524.....	46	19272.....	174	194702.....	12	20029.....	133	21475.....	172
190502.....	61	191546.....	50	192722.....	117	194703.....	12	20038.....	271	21476.....	169
190503.....	61	191623.....	43	19273.....	183	194705.....	12	20053.....	217	21477.....	173
190504.....	62	191624.....	43	192760.....	50	194708.....	12	20091.....	134	21484.....	178
190505.....	62	191625.....	43	192793.....	85, 87	194709.....	12	20169.....	203	2158.....	425
190506.....	62	191626.....	43	192815.....	46	194710.....	12	2023.....	428	21594.....	171
190507.....	62	191627.....	43	19283.....	169	194711.....	12	20244.....	171	21604.....	287
190508.....	62	191628.....	43	192846.....	37	194807.....	151	20245.....	172	2161.....	193
190509.....	62	191629.....	43	192847.....	91	194888.....	207	20251.....	217	21626.....	394
190510.....	60	191630.....	43	19296.....	190	194901.....	437	20273.....	203	21647.....	206
190511.....	60	191631.....	43	192977.....	128	194938.....	341	20286.....	173	21783.....	363
190512.....	60	191632.....	43	1930.....	405	194941.....	341	20318.....	233	21791.....	292
190513.....	60	191690.....	47	193066.....	373	19499.....	256	20325.....	438	21824.....	195
190514.....	60	191703.....	47	193067.....	373	194999.....	327	20326.....	438	21863.....	180
190515.....	60	1917.....	287	193115.....	117	195000.....	327	20329.....	438	21883.....	287
190516.....	60	191780.....	50	19313.....	438	195001.....	327	20330.....	438	2189.....	215
190517.....	62	191935.....	47	19330.....	203	19501.....	236	20331.....	438	2191.....	305
190558.....	135	19203.....	243	193387.....	414	195049.....	375	20334.....	438	2195.....	169
190604.....	232	192061.....	230	193388.....	414	195079.....	349	20335.....	438	2196.....	173
190623.....	28	192062.....	230	193389.....	414	195125.....	121	2035.....	293	2197.....	185
190624.....	28	192063.....	230	193412.....	46	195172.....	110, 116	20372.....	189	22008.....	216
190625.....	28	192064.....	230	1934.....	353	1952.....	169	2040.....	304	22010.....	216
190626.....	28	192065.....	230	193456.....	42	195303.....	139	2041.....	171	22011.....	216
190627.....	28	192066.....	230	19351.....	183	1953.....	238	20561.....	235	22012.....	216
190628.....	28	192067.....	230	1935.....	218	19551.....	133	2060.....	422	22017.....	178
190629.....	35	192068.....	230	19369.....	174	195582.....	37	20639.....	66	22018.....	178
190630.....	35	192069.....	230	193749.....	117	195660.....	366	20647.....	396	22019.....	178
190631.....	35	192072.....	222	193759.....	47	19569.....	176	2066.....	203	22020.....	178
190632.....	35	192074.....	222	193770.....	404	195764.....	372	20692.....	75	22020.....	178
190633.....	35	192076.....	222	193771.....	404	1960.....	298	20694.....	75	2203.....	296
190634.....	35	192077.....	222	193780.....	405	196207.....	390	20696.....	75	221.....	185
190635.....	35	192078.....	222	193781.....	384	196215.....	363	20697.....	76	22131.....	192
190636.....	35	192079.....	222	193782.....	384	196296.....	399	2071.....	253	22135.....	192
190687.....	373	192081.....	222	193785.....	384	19641.....	203	2072.....	267	22139.....	193
190708.....	37	19214.....	185	193786.....	384	19648.....	133	2075.....	190	22140.....	193
190709.....	37	192151.....	363	193788.....	384	19665.....	250	2075.....	190	2214.....	299
190710.....	36	192152.....	363	193789.....	384	1967.....	250	2079.....	299	2216.....	193
190711.....	36	192153.....	363	193802.....	338	19672.....	256	20799.....	75	22223.....	196
190751.....	169	192154.....	363	193830.....	39	1967.....	293	20800.....	76	22240.....	190
190850.....	9	192155.....	363	193942.....	46	19673.....	256	2086.....	205	2224.....	299
190899.....	113	192156.....	363	193970.....	46	196802.....	431	20866.....	68	22247.....	344
19095.....	308	192157.....	363	193971.....	46	197313.....	281	20876.....	350	2234.....	170
				193973.....	46	19737.....	363	20897.....	186	2238.....	287

Index by Part Number

2243.....	185	24672.....	266	2702.....	293	2822.....	133	29748.....	267	31478.....	439
22449.....	193	2467.....	402	27024.....	269	282.....	297	29775.....	321	31479.....	439
22450.....	193	24741.....	204	2704.....	265	28240.....	235	2978.....	239	31480.....	439
22523.....	371	24793.....	76	2705.....	169	2824.....	193	29798.....	363	31482.....	439
22556.....	189	24801.....	78	2707.....	52	28243.....	236	29799.....	363	31487.....	439
2261.....	299	24802.....	78	27097.....	425	2826.....	269	29800.....	363	3152.....	261
22621.....	325	24945.....	266	2710.....	285	28275.....	286	29825.....	169	31523.....	342
22624.....	373	2504.....	174	2717.....	362	28276.....	286	29858.....	269	3165.....	285
226.....	301	25106.....	278	27196.....	132	2829.....	425	29870.....	125	31696.....	45
2263.....	193	25126.....	264	27198.....	132	2832.....	239	29874.....	438	31714.....	46
22680.....	202	25259.....	264	27202.....	132	28331.....	205	29951.....	125	3175.....	308
2268.....	148	25265.....	371	2720.....	378	283.....	426	29971.....	178	31834.....	374
22697.....	396	25266.....	371	27208.....	132	2844.....	194	29973.....	190	3198.....	301
22701.....	244	25273.....	249	27209.....	132	28482.....	392	2998.....	366	32047.....	134
22744.....	216	2528.....	310	27223.....	371	28487.....	394	2999.....	306	3205.....	173
2277.....	218	2529.....	184	27235.....	194	28499.....	172	30022.....	438	3208.....	172
22806.....	169	2530.....	185	2732.....	193	28504.....	188	30026.....	438	32177.....	181
22810.....	173	2532.....	364	273434.....	133	285.....	302	30054.....	174	32180.....	134
22811.....	173	2536.....	174	27439.....	189	28535.....	134	30018.....	175	3230.....	285
22824.....	285	25410.....	132	27472.....	134	28608.....	193	30233.....	356	32315.....	181
22900.....	133	25448.....	223	27473.....	134	28609.....	192	30236.....	356	32316.....	181
22901.....	133	2545.....	190	27474.....	134	28611.....	193	30354.....	256	323.....	286
22932.....	133	25461.....	359	27475.....	134	28623.....	134	3038.....	286	32360.....	174
22937.....	367	25467.....	266	27476.....	134	2864.....	297	3039.....	133	32400.....	142
2303.....	292	25478.....	204	27477.....	134	2866.....	287	30402.....	279	32401.....	142
2305.....	299	2551.....	177	2751.....	175	28699.....	169	3040.....	302	3243.....	175
23089.....	195	255.....	285	27582.....	264	28700.....	170	304.....	297	32458.....	181
231.....	183	25554.....	174	27621.....	432	28751.....	312	30434.....	176	32507.....	299
23130.....	195	2569.....	366	2762.....	329	28776.....	124	30435.....	176	3252.....	301
23136.....	264	2571.....	293	27718.....	170	28777.....	124	30436.....	176	3260.....	286
23139.....	267	25747.....	359	27719.....	169	28779.....	124	30437.....	176	32646.....	235
23140.....	267	25750.....	132	27720.....	169	28784.....	127	30439.....	181	32685.....	120
23141.....	267	25766.....	204	27721.....	172	28787.....	127	30463.....	125	32686.....	120
23145.....	25	25800.....	75	27722.....	171	28794.....	127	3047.....	301	32712.....	187
2316.....	182	2581.....	186	27728.....	185	28795.....	127	30547.....	190	3279.....	332
23199.....	185	2584.....	313	27729.....	185	28796.....	127	3056.....	177	328.....	302
23314.....	91, 311	25859.....	388	2773.....	176	28797.....	127	3061.....	301	32834.....	387
23339.....	330	25862.....	268	27741.....	355	28803.....	137	3063.....	364	32856.....	125
23342.....	365	2586.....	241	2778.....	171	28811.....	141	30636.....	137	32860.....	248
23343.....	365	25879.....	196	2785.....	194	28812.....	141	306.....	362	32869.....	384
2335.....	392	25929.....	344	2788.....	185	2881.....	287	30641.....	278	3291.....	299
23357.....	383	25979.....	245	2789.....	220	2882.....	297	30690.....	415	32940.....	132
23434.....	134	26081.....	207	2791.....	363	2883.....	175	3071.....	301	32942.....	134
23455.....	64	26082.....	207	2794.....	310	2885.....	304	30717.....	420	3294.....	413
23496.....	18	26090.....	287	27946.....	66	2893.....	173	30731.....	181	3300.....	299
23562.....	134	26093.....	188	27950.....	133	28943.....	285	30733.....	426	3302.....	176
2363.....	305	26095.....	188	2795.....	220	28975.....	125	30734.....	330	3307.....	299
23660.....	209	26097.....	188	2797.....	265	28976.....	125	30748.....	178	33077.....	136
2370.....	310	26116.....	189	28072.....	272	28977.....	142	30766.....	345	33078.....	136
23710.....	205	26125.....	382	28073.....	272	28978.....	142	30827.....	181	33085.....	196
23719.....	359	26157.....	233	28074.....	272	28982.....	142	30828.....	174	33088.....	196
23756.....	330	26165.....	330	28075.....	272	28988.....	142	30832.....	181	3311.....	295
23769.....	239	26326.....	209	28076.....	272	28994.....	371	30833.....	181	3313.....	301
23770.....	239	26328.....	175	28077.....	272	28995.....	141	30842.....	219	33242.....	181
2386.....	185	2633.....	193	28079.....	272	29030.....	141	30896.....	174	33260.....	267
23986.....	239	2638.....	286	28082.....	272	29035.....	173	30897.....	174	33323.....	183
2406.....	367	2641.....	176	2808.....	378	29036.....	173	309.....	302	33335.....	187
2407.....	384	26423.....	266	28085.....	272	29105.....	262	3095.....	304	33357.....	438
24131.....	169	2643.....	395	28086.....	272	29117.....	175	3098.....	299	33358.....	438
24140.....	170	26473.....	241	28087.....	272	2913.....	174	31043.....	119	33394.....	187
24163.....	266	26490.....	134	28089.....	272	29219.....	142	31044.....	119	334.....	362
24164.....	266	2655.....	311	28091.....	272	292.....	297	31061.....	173	33447.....	286
24167.....	267	26560.....	279	28093.....	272	29244.....	180	3106.....	287	33502.....	364
24168.....	267	26565.....	322	28094.....	272	2926.....	192	31101.....	45	33756.....	321
24210.....	175	26708.....	204	28095.....	272	2933.....	395	3111.....	304	3378.....	310
24213.....	177	2671.....	285	28096.....	272	29386.....	243	31219.....	133	33834.....	327
2425.....	190	2672.....	298	28099.....	272	2943.....	193	31303.....	362	3385.....	304
24297.....	266	26727.....	133	28103.....	272	29437.....	255	313374.....	7	33876.....	175
2436.....	286	2673.....	287	28104.....	272	2944.....	298	313377.....	7	33882.....	212
2438.....	304	26757.....	354	28105.....	272	294.....	432	31.....	362	33896.....	175
24385.....	388	2677.....	194	28107.....	272	29459.....	133	31364.....	255	33951.....	173
24445.....	179	26794.....	179	28108.....	272	295.....	302	3142.....	301	3398.....	285
24450.....	133	26800.....	294	28115.....	272	2961.....	302	31433.....	183	340.....	171
24550.....	204	2691.....	193	28116.....	272	29695.....	268	31434.....	177	34028.....	174
24578.....	206	2697.....	425	28117.....	272	29696.....	267	31472.....	287	34080.....	373
24601.....	187	2698.....	218	28120.....	272	29710.....	133	3147.....	369	34138.....	268
24671.....	266	2699.....	362	28122.....	272	29743.....	178	31477.....	439	3414.....	310

Models and Specifications are Subject to Change Without Notice



Index by Part Number

34152.....	132	36288.....	130	37306.....	218	38752.....	46	40.....	133	4168.....	185
3415.....	305	3630.....	294	37315.....	362	38784.....	321	4014.....	206	4175.....	298
34160.....	181	36313.....	397	373.....	205	38821.....	133	40207.....	231	41786.....	266
34213.....	293	3634.....	204	3736.....	192	38827.....	266	40251.....	359	4179.....	169
3423.....	303	3635.....	193	3737.....	439	38828.....	266	403.....	133	41801.....	172
3426.....	310	36387.....	402	3738.....	378	38829.....	266	40317.....	436	41802.....	171
34.....	305	36398.....	75	3739.....	304	38833.....	267	40360.....	76	41803.....	171
34329.....	161	36399.....	75	3745.....	192	38856.....	345	4037.....	206	41804.....	171
3436.....	301	3644.....	271	3746.....	192	38920.....	439	40406.....	373	41805.....	172
34363.....	187	365.....	362	3747.....	304	39078.....	210	40407.....	373	41806.....	171
34366.....	385	36568.....	142	3749.....	362	39082.....	210	40421.....	353	41807.....	171
34368.....	426	3657.....	174	37508.....	279	39083.....	210	40422.....	353	41808.....	171
3438.....	176	36579.....	70	3759.....	304	3912.....	193	40423.....	353	41835.....	132
34394.....	324	36591.....	64, 83	3760.....	169	391.....	271	40424.....	353	41860.....	331
3445.....	182	36592.....	64, 83	37624.....	298	39149.....	438	40425.....	353	41889.....	187
34556.....	358	36596.....	354	37655.....	70	39153.....	133	40426.....	331	41891.....	187
3457.....	215	36617.....	354	37659.....	312	39187.....	66	40438.....	354	41892.....	187
34686.....	70	36625.....	70	37660.....	70	39209.....	361	40447.....	326	41893.....	187
34704.....	322	36626.....	70	377.....	188	39218.....	439	40477.....	305	4190.....	298
34708.....	176	3670.....	286	3772.....	298	39220.....	439	40487.....	75	41923.....	78
3471.....	293	36703.....	193	37743.....	210	39239.....	187	40527.....	421	41925.....	78
3472.....	407	36709.....	260	3778.....	310	39248.....	133	4059.....	378	4197.....	194
34732.....	435	36732.....	428	3779.....	253	393.....	190	40609.....	70	42045.....	258
34736.....	188	3674.....	192	378.....	172	39321.....	182	40617.....	264	42120.....	219
34737.....	359	36742.....	264	3783.....	193	39322.....	182	40685.....	282	4222.....	435
3481.....	293	36743.....	267	3784.....	303	39323.....	182	4070.....	194	4223.....	186
34814.....	210	36745.....	268	37854.....	345	39324.....	211	40739.....	296	42283.....	154
34815.....	210	3675.....	194	37873.....	50	39392.....	396	40856.....	426	4229.....	252
34816.....	210	3676.....	304	37874.....	50	3942.....	176	40857.....	426	4238.....	192
34817.....	210	3681.....	172	3790.....	253	39485.....	190	40858.....	426	424.....	219
3486.....	190	3689.....	194	37917.....	439	39516.....	185	40859.....	426	42475.....	410
3496.....	187	3690.....	304	37941.....	186	39517.....	185	40860.....	426	42481.....	352
34966.....	70	36913.....	231	3795.....	308	39518.....	185	40861.....	426	4258.....	186
3497.....	243	36914.....	231	3796.....	192	39519.....	252	4086.....	378	42596.....	265
3498.....	311	36915.....	231	37963.....	316	39583.....	266	4093.....	252	42696.....	256
35013.....	64	36936.....	282	3797.....	193	39608.....	187	40950.....	132	4270.....	192
35020.....	269	36956.....	269	38028.....	3, 5, 6, 8, 10	39609.....	187	4095.....	177	42781.....	388
35029.....	165	36961.....	355	3803.....	253	3965.....	170	41087.....	207	4278.....	271
3508.....	439	3697.....	194	3807.....	193	39712.....	284	41164.....	191	4279.....	436
35099.....	3, 5, 6, 8, 10	3698.....	304	38078.....	265	39816.....	125	41210.....	138	42841.....	78
35155.....	302	36988.....	265	38082.....	264	39817.....	125	41211.....	138	42842.....	78
35175.....	210	36989.....	265	38089.....	330	398.....	185	41212.....	138	4284.....	436
35200.....	64	37001.....	373	38108.....	325	39821.....	183	41214.....	331	42895.....	196
352.....	205	37009.....	387	38115.....	46	39822.....	439	41218.....	138	42931.....	169
35297.....	212	37011.....	212	38116.....	46	3985.....	378	41233.....	64	42932.....	169
35298.....	212	3701.....	174	38117.....	47	39857.....	210	41238.....	278	42966.....	177
35299.....	212	37013.....	212	38118.....	47	39858.....	210	41280.....	330	42967.....	179
3533.....	173	37014.....	212	38119.....	46, 47	39866.....	210	41342.....	271	42984.....	179
35463.....	173	37015.....	212	3813.....	193	39868.....	210	41343.....	271	4300.....	193
3549.....	407	37016.....	212	3816.....	194	39869.....	210	4134.....	378	4304.....	436
35513.....	257	37017.....	212	38177.....	79	39870.....	210	41344.....	271	43087.....	180
3552.....	301	37040.....	262	3819.....	310	39871.....	210	41345.....	271	43115.....	366
3557.....	174	3706.....	360	38266.....	185	39872.....	210	41346.....	271	43183.....	131
35578.....	241	370.....	79	38267.....	184	39873.....	210	41347.....	271	4320.....	435
3561.....	308	37085.....	424	38281.....	133	39874.....	210	41348.....	271	43240.....	438
35655.....	220	37086.....	190	3830.....	366	39875.....	210	41354.....	271	43242.....	438
3572.....	389	37090.....	134	38305.....	269	39876.....	210	41355.....	271	43244.....	356
3577.....	173	3715.....	304	3839.....	285	39914.....	134	41356.....	271	43269.....	182
35779.....	248	37163.....	439	38401.....	70	39923.....	184	41359.....	271	43273.....	182
3583.....	133	37164.....	439	3842.....	304	3993.....	192	41362.....	271	43274.....	347
35832.....	232	37166.....	439	38457.....	210	39947.....	187	4136.....	327	43275.....	347
3585.....	190	37167.....	439	38471.....	330	39948.....	187	41363.....	271	43283.....	361
35860.....	142	37168.....	439	38473.....	366	39949.....	187	4137.....	305	43285.....	361
35925.....	365	37169.....	439	3852.....	174	39950.....	187	41391.....	432	43286.....	361
3594.....	395	37179.....	439	38530.....	249	39951.....	187	4141.....	435	43287.....	361
3597.....	177	37180.....	439	38547.....	248	39952.....	187	41421.....	75	43289.....	361
35997.....	177	37182.....	439	38570.....	248	39969.....	369	4143.....	193	43290.....	361
3605.....	285	37217.....	70	38584.....	267	39970.....	369	41454.....	75	43291.....	361
3610.....	366	3725.....	192	38591.....	115	3997.....	287	41499.....	256	43292.....	361
3611.....	407	3726.....	304	38668.....	271	40007.....	75	4154.....	190	43366.....	76, 77
361.....	346	37265.....	327	38669.....	271	40008.....	75	4157.....	175	43369.....	76, 77
3617.....	438	37267.....	326	3869.....	364	40012.....	75	41584.....	352	43372.....	76
36178.....	260	37275.....	311	38710.....	316	40013.....	75	41598.....	376	43373.....	76
36185.....	267	37276.....	311	38715.....	169	40014.....	76	41599.....	231	43374.....	76
3619.....	305	37283.....	219	38716.....	169	400.....	190	4161.....	193	43376.....	76
3624.....	193	37293.....	71	38717.....	404	4004.....	185	41633.....	108	43378.....	76, 77
36287.....	130	37294.....	70	38720.....	46	40097.....	18, 25	4166.....	193	43379.....	76, 77

Index by Part Number

4349.....	175	44790.....	107	4583.....	181	47960.....	187	49140.....	352	51374.....	209
4350.....	173	44791.....	107	45843.....	136	47997.....	163	4918.....	91, 311	51395.....	259
43546.....	107	44805.....	266	45847.....	146	47998.....	163	4919.....	412	51396.....	328
4356.....	175	44835.....	374	45870.....	218	47999.....	163	49264.....	389	51415.....	438
43572.....	187	44849.....	178	45903.....	147	48016.....	296	4933.....	366	51487.....	188
43573.....	187	44888.....	268	45904.....	147	48017.....	296	49344.....	115	51488.....	188
43576.....	347	449.....	180	4597.....	425	48018.....	300	49345.....	115	51489.....	188
43577.....	347	44930.....	182	46001.....	427	480.....	190	49354.....	400	51505.....	172
43579.....	347	44931.....	182	46012.....	427	48019.....	300	49492.....	439	5153.....	425
43583.....	347	44940.....	183	46013.....	271, 427	48021.....	300	4950.....	364	51632.....	249
43585.....	347	44941.....	272	46034.....	427	48022.....	300	49642.....	62	51633.....	248
43586.....	347	44972.....	203	4604.....	305	48023.....	300	49649.....	63	51677.....	365
43588.....	347	44973.....	203	461.....	190	48025.....	300	49650.....	63	51701.....	172
43591.....	389	44974.....	203	46120.....	146	48027.....	300	4966.....	316	51702.....	171
4362.....	298	44975.....	203	46142.....	146	48028.....	300	4968.....	182	5173.....	307
43625.....	193	44984.....	206	46305.....	410	48029.....	300	49703.....	79	51738.....	91
43686.....	314	44985.....	206	46336.....	435	48030.....	300	50087.....	118	51739.....	91
43687.....	314	44986.....	206	46337.....	99	48041.....	127	50088.....	405	5182.....	239
43752.....	107	44987.....	206	46363.....	218	48042.....	127	50099.....	395	51842.....	172
43754.....	107	44998.....	205	46476.....	182	48045.....	127	50100.....	395	51889.....	373
43794.....	62	44999.....	205	46483.....	379	48046.....	127	50108.....	405	51921.....	426
43894.....	119	45000.....	205	46506.....	294	48065.....	171	50110.....	405	51938.....	212
4392.....	300	45002.....	205	46510.....	44, 50	48066.....	171	50115.....	188	51939.....	212
43931.....	170	45003.....	205	46511.....	44, 50	48070.....	182	50116.....	188	51940.....	212
4394.....	182	45005.....	205	46512.....	44	48116.....	218	50117.....	188	51960.....	45
43951.....	385	4501.....	193	46513.....	44	4817.....	343	50118.....	188	5198.....	435
43960.....	215	45038.....	176	46514.....	44	4825.....	192	50119.....	188	5210.....	190
43980.....	215	4505.....	175	46516.....	146	4828.....	182	50138.....	147	52106.....	399
43997.....	78	45078.....	186	46526.....	44	48340.....	195	50169.....	231	52107.....	399
43998.....	78	45080.....	173	46536.....	177	48361.....	67	5027.....	301	52108.....	399
43999.....	78	45081.....	173	4656.....	175	48362.....	67	50292.....	167	52109.....	399
44000.....	78	45111.....	114	46579.....	44	48387.....	311	50294.....	168	52110.....	399
4402.....	192	45112.....	114	46582.....	44	48389.....	311	50295.....	168	5222.....	209
44027.....	267	4514.....	435	46620.....	268	48393.....	13, 18	50298.....	168	522.....	287
4404.....	300	45152.....	296	46621.....	268	48412.....	424	50305.....	45, 50	5224.....	239
44078.....	389	45207.....	108	46622.....	268	48413.....	424	50306.....	45, 50	52263.....	401
44123.....	210	45288.....	187	46660.....	146	48418.....	129	50344.....	130	52268.....	404
44124.....	210	45297.....	148	46702.....	363	4842.....	206	5037.....	239	5234.....	180
44147.....	207	45339.....	204	4671.....	172	4849.....	364	5039.....	177	52363.....	249
44148.....	207	45386.....	298	46764.....	209	48512.....	118	50473.....	212	52391.....	251
44150.....	207	4540.....	133	46772.....	115	48519.....	79	50474.....	212	52392.....	251
44152.....	207	45498.....	145	46773.....	115	4856.....	361	50475.....	212	52393.....	251
442.....	285	45500.....	147	46774.....	115	48578.....	179	50476.....	212	52394.....	251
4427.....	201	45501.....	147	46794.....	146	48580.....	171	50477.....	212	52395.....	251
44292.....	173	45502.....	147	46823.....	256	48581.....	171	5048.....	332	5244.....	285
44295.....	438	45503.....	129	46824.....	292	48582.....	171	50553.....	332	5245.....	299
44399.....	352	45504.....	129	4686.....	287	48583.....	172	50555.....	331	52460.....	401
44403.....	356	45505.....	129	46986.....	187	4860.....	286	50572.....	438	52469.....	215
44404.....	356	45506.....	145	4699.....	302	4862.....	206	50592.....	94	52471.....	215
44405.....	356	45507.....	145	47011.....	147	4863.....	364	50595.....	94	5247.....	131
44406.....	356	45513.....	128	47120.....	108	4869.....	286	50596.....	94	525.....	205
44449.....	228	45521.....	156	4719.....	302	4875.....	244	50601.....	94	52568.....	191
44450.....	228	4553.....	257	4728.....	396	48766.....	258	50611.....	207	52570.....	191
44451.....	228	45548.....	166	47290.....	102	48772.....	176	5061.....	332	52571.....	191
44452.....	228	45549.....	166	4730.....	187	48787.....	265	5072.....	332	52572.....	191
44453.....	228	45551.....	166	473.....	346	48788.....	265	5076.....	363	52573.....	191
44454.....	228	45555.....	166	47352.....	172	48789.....	265	5082.....	332	52574.....	191
44461.....	102	45571.....	147	47372.....	173	48790.....	265	5088.....	182	52577.....	191
44493.....	422	45572.....	147	47498.....	327	48791.....	265	50895.....	132	52580.....	191
4453.....	201	45573.....	146	47499.....	327	48792.....	265	509.....	205	52630.....	191
44540.....	330	45575.....	147	4750.....	186	48793.....	265	5092.....	332	52632.....	191
44541.....	330	45576.....	146	4751.....	169	48796.....	265	50995.....	264	5263.....	285
4455.....	248	45577.....	146	47527.....	173	48797.....	265	51008.....	362	52633.....	191
44589.....	215	45578.....	146	47546.....	124	48798.....	265	51009.....	362	52634.....	191
44662.....	173	45580.....	147	4755.....	298	4881.....	206	51010.....	362	52640.....	191
44681.....	93	45582.....	146	4759.....	304	48827.....	232	51018.....	94	52670.....	191
44687.....	248	45583.....	147	47627.....	331	48834.....	232	51024.....	94	52710.....	192
44688.....	248	45584.....	146	47635.....	311	48843.....	157	51026.....	94	52730.....	147
44695.....	365, 386	45585.....	146	4766.....	285	4885.....	435	51030.....	94	52732.....	144
44697.....	365	45586.....	145	47738.....	331	48869.....	182	51091.....	170	52733.....	144
44698.....	365	45588.....	130	4775.....	174	48870.....	182	51124.....	404	52734.....	144
44727.....	188	45592.....	130	47789.....	292	48882.....	174	51162.....	167	52735.....	144
44728.....	188	45618.....	192	47897.....	146	4893.....	206	51165.....	168	52736.....	144
44737.....	187	45619.....	193	47898.....	258	4894.....	302	51176.....	209	52737.....	144
44751.....	213	45620.....	193	47899.....	258	4905.....	186	51.....	204	52738.....	144
4475.....	305	4574.....	311	47900.....	258	49052.....	265	51268.....	67	52754.....	160
44768.....	119	45754.....	179	47901.....	258	4906.....	412	5135.....	329	52755.....	161



Index by Part Number

52756.....	161	5467.....	346	55121.....	325	56456.....	160	5766.....	206	6010.....	363
52768.....	259	54702.....	129	55122.....	322	56464.....	207	57667.....	146	6011.....	180
52787.....	142	54703.....	129	55123.....	323	56476.....	255	57707.....	146	60122.....	41
52789.....	162	547.....	180	55124.....	323	56550.....	245	57711.....	93	60179.....	337
52790.....	140	54777.....	215	55125.....	319	56552.....	51	57718.....	237	60199.....	349
52828.....	218	54778.....	215	55126.....	319	56601.....	242	57719.....	237	60205.....	51
52830.....	160	5479.....	172	55167.....	51	56602.....	242	57720.....	237	6035.....	435
52831.....	161	54812.....	132	5517.....	307	56603.....	242	57721.....	237	60431.....	334
52832.....	161	54824.....	334	55195.....	390	56604.....	242	5778.....	292	60453.....	51
5286.....	206	54825.....	334	552.....	188	56620.....	242	5779.....	384	6045.....	390
52875.....	318	54826.....	334	55223.....	329	56622.....	242	5780.....	206	6046.....	186
52876.....	166	54827.....	334	55255.....	266	56623.....	242	57814.....	51	60477.....	411
52888.....	362	54828.....	335	55258.....	172	56635.....	251	5783.....	292	60541.....	214
5303.....	435	54829.....	335	5526.....	298	56692.....	270	5784.....	384	6056.....	315
5304.....	425	54830.....	334	55277.....	51	5672.....	115	5785.....	149	60592.....	214
5311.....	265	54831.....	336	55281.....	51	56745.....	120	57875.....	427	60593.....	214
53117.....	179	54832.....	336	5531.....	204	56752.....	118	57876.....	427	60594.....	214
53119.....	179	54833.....	336	55335.....	45	56753.....	241	5797.....	384	6062.....	177
5317.....	378	54834.....	337	55348.....	371	56759.....	329	57974.....	220	609.....	205
5318.....	173	54835.....	338	55355.....	209	56777.....	292	57985.....	51	6092.....	425
53213.....	272	54836.....	338	55356.....	209	5678.....	384	5799.....	206	6116.....	315
53258.....	137	54837.....	338	55363.....	45	56803.....	220	5810.....	428	6126.....	435
53259.....	137	54838.....	338	5537.....	175	56804.....	220	58105.....	249	6131.....	248
5326.....	298	54839.....	338	55384.....	209	5682.....	435	5818.....	171	6138.....	180
5335.....	357	54840.....	338	55386.....	94	5684.....	384	58223.....	231	6141.....	175
5339.....	68	54843.....	340	5540.....	308	56848.....	160	58232.....	251	6150.....	357
5341.....	298	54844.....	371	5541.....	424	5688.....	365	5826.....	206	6154.....	180
5342.....	308	54845.....	335	55424.....	209	56918.....	160	583.....	177	6183.....	268
5343.....	378	54846.....	335	55445.....	329	56962.....	130	5834.....	172	6191.....	133
5345.....	243	54847.....	335	55599.....	45	5696.....	384	58377.....	428	6193.....	315
5353.....	68	54848.....	335	55630.....	51	56993.....	142	58386.....	386	6196.....	297
53598.....	120	54849.....	336	55657.....	51	56997.....	248	58387.....	386	6198.....	305
5362.....	68	54850.....	371	55663.....	51	57041.....	394	58388.....	386	6203.....	297
53639.....	145	54851.....	387	55686.....	102	5704.....	307	58389.....	386	6208.....	435
5368.....	79	5485.....	303	55698.....	317	5705.....	345	5846.....	366	6212.....	356
5370.....	378	54855.....	387	55719.....	99	5706.....	313	5847.....	44	6224.....	185
5372.....	133	54858.....	341	55740.....	307	5710.....	286	5849.....	435	62331.....	119
5374.....	68	5487.....	295	55745.....	51	57103.....	67, 83	5852.....	364	6237.....	208
5380.....	131	54881.....	380	5579.....	177	5717.....	349	585.....	307	62418.....	242
53839.....	421	54882.....	372	5585.....	375	5718.....	287	5862.....	428	6242.....	294
5387.....	13, 18	54883.....	381	55894.....	51	57226.....	113	58642.....	243	6244.....	342
53903.....	137	54884.....	381	5591.....	365	57227.....	116	58678.....	155	6245.....	208
5390.....	68	54886.....	382	55923.....	51	57228.....	116	58698.....	396	62471.....	342
5394.....	187	54887.....	369	55925.....	51	57233.....	202	58699.....	396	62499.....	118
53945.....	171	54890.....	382	55926.....	382	57234.....	202	58782.....	147	625.....	287
53951.....	219	54891.....	382	55949.....	329	57235.....	202	588.....	181	6253.....	332
53952.....	219	54893.....	382	5596.....	435	57236.....	202	5894.....	359	6254.....	342
5401.....	18, 25	54896.....	382	5597.....	375	57248.....	395	5899.....	384	6257.....	292
540.....	205	54898.....	376	55985.....	251	5727.....	349	59013.....	137	62577.....	64
54094.....	171	54899.....	376	56058.....	51	5728.....	287	59118.....	241	62624.....	214
54095.....	169	54900.....	376	56059.....	51	57285.....	130	59127.....	369	62626.....	220
54096.....	169	54901.....	381	56080.....	51	57339.....	112	5922.....	307	62632.....	213
5411.....	68	54902.....	374	56082.....	64	5734.....	304	59.....	240	62633.....	214
5412.....	435	54903.....	380	56099.....	51	57356.....	370	5930.....	206	62634.....	429
5415.....	187	54904.....	380	5610.....	203	57381.....	151	5936.....	364	6265.....	175
5417.....	260	54905.....	383	56152.....	51	5738.....	313	594.....	115	6266.....	332
5418.....	171	54908.....	374	56153.....	51	5739.....	367	59454.....	192	6267.....	342
5423.....	239	54924.....	369	56.....	173	57401.....	144	5945.....	435	62730.....	405
54291.....	51	54935.....	285	5617.....	390	5740.....	307	59455.....	193	62731.....	405
5432.....	307	54987.....	376	56175.....	329	57446.....	193	5947.....	206	6274.....	292
5437.....	285	54988.....	376	56264.....	172	5746.....	206	595.....	180	62747.....	210
5440.....	248	54989.....	376	5628.....	390	57468.....	248	59531.....	213	62760.....	399
54418.....	132	54990.....	376	56300.....	176	57469.....	248	59532.....	213	6276.....	332
5441.....	99	54994.....	377	56311.....	128	57485.....	256	59533.....	213	62763.....	399
54503.....	387	54996.....	377	56313.....	128	57524.....	233	59549.....	214	62772.....	134
54514.....	133	54997.....	377	56323.....	251	57529.....	241	59550.....	214	62773.....	134
54532.....	149	5501.....	435	56324.....	251	57565.....	234	59551.....	214	62774.....	150
5453.....	239	55053.....	51	56325.....	242	57568.....	234	59552.....	214	62775.....	150
54559.....	355	55056.....	92	56326.....	242	57569.....	234	59567.....	257	62776.....	150
54560.....	169	55057.....	92	56327.....	242	57570.....	234	59617.....	250	6283.....	292
54561.....	51	55059.....	92	56330.....	242	5757.....	170	5962.....	306	62834.....	44
5456.....	346	55065.....	327	56331.....	242	57585.....	298	59874.....	328	62888.....	429
5457.....	311	55066.....	327	56332.....	246	5763.....	435	60009.....	380	62889.....	429
5459.....	386	55067.....	327	56333.....	241	57635.....	394	60010.....	381	62890.....	429
5462.....	425	5509.....	286	56379.....	386	5764.....	349	60046.....	214	6289.....	435
54625.....	323	55116.....	322	56433.....	67, 83	5765.....	368	60067.....	266	62912.....	116
54633.....	278	55120.....	349	56441.....	141	57654.....	142	60074.....	64	62915.....	116

Index by Part Number

62946.....	52	64376.....	70	65317.....	331	65735.....	288	65887.....	290	6741.....	372
6296.....	202	64377.....	70	65353.....	97	65736.....	288	65896.....	289	6745.....	293
6299.....	364	64378.....	70	65354.....	97	65737.....	288	65908.....	290	6747.....	285
63060.....	54	64379.....	70	65355.....	98	65738.....	288	65909.....	290	67513.....	95
63061.....	52	64380.....	70	65356.....	98	65739.....	288	65910.....	290	67522.....	98
6310.....	239	64384.....	70	65357.....	97	65743.....	289	65911.....	290	67542.....	426
63135.....	214	64386.....	70	65359.....	97	65744.....	289	65913.....	290	67543.....	425
6316.....	202	64408.....	214	65360.....	98	65746.....	289	65914.....	290	67544.....	426
63200.....	54	6441.....	202	65361.....	98	65747.....	289	65915.....	290	67641.....	212
63202.....	54	64434.....	398	65362.....	98	65748.....	289	65916.....	290	67657.....	116
63205.....	220	64460.....	337	65363.....	98	65749.....	289	65917.....	290	67658.....	133
63313.....	249	64461.....	339	65365.....	98	65750.....	289	65918.....	290	67699.....	306
6332.....	202	64462.....	339	65366.....	98	65751.....	289	65926.....	290	67702.....	306
6333.....	332	64468.....	338	65368.....	98	65753.....	289	65927.....	290	67703.....	306
63335.....	270	64469.....	338	65369.....	97	65754.....	289	65928.....	290	67704.....	306
63352.....	270	64481.....	336	65371.....	97	65755.....	289	65929.....	290	67705.....	306
63353.....	270	64482.....	336	65373.....	76	65756.....	289	65930.....	290	67707.....	306
63354.....	270	64532.....	251	6540.....	422	65757.....	289	65935.....	291	67709.....	306
63355.....	270	64550.....	413	6541.....	202	65758.....	289	65936.....	291	67710.....	306
63357.....	270	6457.....	202	65449.....	372	65759.....	289	65937.....	291	6781.....	313
63358.....	270	64579.....	94	65450.....	372	65760.....	289	65938.....	291	6784.....	292
63359.....	270	64617.....	341	65461.....	373	65770.....	289	65939.....	291	67849.....	249
63360.....	270	6467.....	180	65462.....	373	65771.....	289	65940.....	291	67851.....	432
6341.....	180	64726.....	343	65473.....	373	65772.....	289	65942.....	291	6785.....	172
6344.....	208	64727.....	344	65519.....	266	65773.....	289	65943.....	291	6790.....	419
63451.....	67	64728.....	343	6552.....	202	65774.....	289	65946.....	291	6795.....	175
63461.....	52	64729.....	346	65531.....	259	65775.....	289	65961.....	291	6802.....	435
63466.....	54	64730.....	346	65615.....	288	65776.....	289	65962.....	291	68034.....	353
6351.....	332	64731.....	346	65623.....	288	65777.....	289	65963.....	291	68061.....	363
6353.....	208	6473.....	208	65624.....	288	65778.....	289	6597.....	435	6808.....	180
6356.....	306	64733.....	346	65646.....	288	65779.....	289	6599.....	205	68165.....	238
63571.....	238	64743.....	356	65647.....	288	65780.....	289	66025.....	290	68166.....	238
6359.....	174	64746.....	357	65648.....	288	65781.....	289	66026.....	290	68185.....	237
63611.....	416	64748.....	357	65649.....	288	65782.....	289	66028.....	290	6820.....	243
63629.....	50	64760.....	352	65650.....	288	65783.....	289	66029.....	290	68233.....	294
63643.....	142	64762.....	353	65651.....	288	65784.....	289	66030.....	290	68278.....	375
63649.....	142	64764.....	352	65652.....	288	65785.....	289	66031.....	290	68279.....	375
63878.....	171	64800.....	333	65653.....	288	65786.....	289	66034.....	290	68280.....	375
63879.....	171	64801.....	333	65655.....	288	65787.....	289	66036.....	290	68297.....	140
63880.....	170	64805.....	330	65656.....	288	65788.....	289	66080.....	363	68298.....	140
63905.....	399	64806.....	330	65657.....	288	65789.....	289	66081.....	363	68299.....	140
63907.....	251	64813.....	322	65658.....	288	65790.....	289	66100.....	147	68300.....	140
6391.....	435	6483.....	184	65659.....	288	65791.....	289	6610.....	202	68301.....	140
63917.....	343	64875.....	438	65660.....	288	65792.....	289	66111.....	156	6840.....	362
63918.....	343	64895.....	243	65661.....	288	65793.....	289	661.....	187	6843.....	192
63919.....	343	64896.....	243	65662.....	288	65794.....	289	6612.....	372	6853.....	192
63920.....	343	6497.....	435	65665.....	288	65795.....	289	6617.....	297	68623.....	237
63937.....	366	64993.....	329	65666.....	288	65796.....	289	6618.....	313	68625.....	237
6394.....	297	6501.....	202	65689.....	288	65797.....	289	6620.....	355	68626.....	238
6399.....	185	65021.....	122	65691.....	288	65798.....	289	662.....	366	68627.....	238
640.....	169	65022.....	122	65692.....	288	65799.....	289	66279.....	382	68628.....	238
64049.....	437	65023.....	122	65693.....	288	65800.....	289	66305.....	160	68629.....	238
64050.....	437	65024.....	122	65694.....	288	65801.....	289	66315.....	238	68630.....	238
6405.....	202	65025.....	122	65695.....	288	65802.....	289	6632.....	356	68631.....	237
64086.....	413	65026.....	122	65696.....	288	65803.....	289	6636.....	171	68634.....	237
6411.....	364	65027.....	122	65698.....	288	65804.....	289	66401.....	404	6865.....	94
641.....	172	65028.....	122	65699.....	288	65812.....	289	66414.....	97	6866.....	192
64155.....	51	65034.....	353	65700.....	288	6581.....	407	6655.....	285	68680.....	342
64209.....	413	65036.....	353	65703.....	288	65815.....	289	6658.....	249	68681.....	342
64215.....	305	65038.....	353	65704.....	288	65817.....	289	6662.....	407	68683.....	143
64224.....	196	65102.....	153	65708.....	288	65846.....	289	6664.....	175	6871.....	313
64255.....	70	6515.....	355	65710.....	288	65847.....	289	6667.....	313	68765.....	414
64256.....	70	65160.....	283	65711.....	288	65848.....	289	6670.....	302	68768.....	414
64257.....	70	65161.....	382	65712.....	288	65850.....	289	66754.....	333	68771.....	414
64258.....	70	65173.....	433	65713.....	288	65851.....	289	6679.....	364	68772.....	414
64259.....	70	65175.....	433	65714.....	288	6585.....	177	66803.....	150	68776.....	414
64260.....	70	65176.....	433	65716.....	288	65852.....	289	6682.....	205	68779.....	414
64263.....	71	65209.....	76	657.....	180	65869.....	290	6684.....	426	68787.....	97
64264.....	71	6525.....	202	65719.....	288	65870.....	290	6690.....	46	68788.....	98
6426.....	68	6527.....	189	65721.....	288	65871.....	290	6692.....	435	68789.....	97
64336.....	231	65277.....	266	65725.....	288	65872.....	290	6695.....	306	68790.....	97
6434.....	202	65285.....	186	65726.....	288	65880.....	290	6698.....	364	68791.....	98
64344.....	201	65287.....	214	65727.....	288	65881.....	290	67003.....	228	68804.....	175
64346.....	70	65296.....	186	65728.....	288	65882.....	290	6707.....	262	68808.....	414
64348.....	438	65314.....	328	65729.....	288	65883.....	290	67.....	204	6882.....	205
64359.....	214	65315.....	330	65730.....	288	65884.....	290	6733.....	293	688.....	240
64373.....	142	65316.....	330	65734.....	288	65885.....	290	67389.....	383	6883.....	286



Index by Part Number

68849.....	408	69843.....	53	69934.....	22	70385.....	385	72122.....	395	74044.....	221
68947.....	209	69846.....	53	69935.....	22	7040.....	376	7213.....	180	74045.....	221
68950.. 3, 5, 6, 8, 10		69847.....	53	69936.....	22	70681.....	266	7216.....	360	74046.....	221
6895.....	175	69848.....	53	69937.....	22	7068.....	190	7226.....	312	7414.....	416
6898.....	435	69860.....	23	69938.....	22	70691.....	191	723.....	188	7.....	418
6899.....	286	69861.....	23	69939.....	22	70692.....	191	72324.....	325	74207.....	45
690.....	205	69862.....	23	69940.....	22	70723.....	71	72327.....	266	7421.....	204
69042.....	231	69863.....	23	69941.....	22	70747.....	33	72349.....	168	7423.....	292
6905.....	176	69864.....	23	69942.....	22	70748.....	33	7239.....	249	74250.....	45
6907.....	389	69865.....	23	69943.....	22	70749.....	33	72401.....	374	74278.....	189
6908.....	297	69866.....	23	69944.....	22	70750.....	33	7251.....	176	7428.....	299
69097.....	154	69867.....	23	69945.....	22	70751.....	33	72524.....	62	74315.....	45
69098.....	154	69868.....	23	69946.....	22	70752.....	33	7255.....	178	7434.....	298
69099.....	154	69869.....	23	69947.....	22	70788.....	195	72567.....	266	74346.....	308
69100.....	154	69870.....	23	69948.....	22	7082.....	313	72576.....	362	7438.....	204
69113.....	30	69871.....	23	69949.....	22	70857.....	160	7259.....	298	7441.....	175
69114.....	30	69872.....	23	69950.....	22	70858.....	160	7262.....	175	7442.....	312
69115.....	30	69873.....	23	69951.....	22	7097.....	180	72662.....	212	7448.....	297
69116.....	30	69874.....	23	69952.....	22	70981.....	186	72679.....	134	74591.....	159
69117.....	30	69875.....	23	69953.....	22	7098.....	172	7273.....	358	74592.....	159
69118.....	30	69876.....	23	69954.....	22	71083.....	146	72750.....	321	74635.....	341
69120.....	30	69877.....	16	69955.....	22	71157.....	62	72783.....	174	74684.....	64
6915.....	180	69878.....	16	69956.....	22	7117.....	416	72803.....	200	74685.....	64
69163.....	256	69879.....	16	69957.....	22	71181.....	146	72811.....	157	74733.....	158
69180.....	243	69880.....	16	69958.....	15	71183.....	145	7289.....	173	74744.....	159
69182.....	243	69881.....	16	69959.....	15	71206.....	62	72894.....	373	74745.....	159
69186.....	291	69882.....	16	69960.....	15	71207.....	62	72896.....	156	74746.....	159
6920.....	378	69883.....	16	69961.....	15	71208.....	145	7291.....	171	74747.....	159
69210.....	259	69884.....	16	69962.....	15	71211.....	60	7292.....	172	74751.....	159
6922.....	362	69885.....	16	69963.....	15	71212.....	60	72954.....	368	74752.....	159
6924.....	184	69886.....	16	69964.....	15	71215.....	60	72957.....	98	74753.....	159
69242.....	214	69887.....	16	69965.....	15	71216.....	60	72958.....	98	74754.....	159
6933.....	176	69888.....	20	69966.....	15	712.....	205	72974.....	103	74755.....	159
69340.....	409	69889.....	20	69967.....	15	71221.....	60	72976.....	103	74756.....	159
69341.....	409	69890.....	20	69968.....	15	7127.....	178	72979.....	104	74757.....	159
69342.....	409	69891.....	20	69981.....	20	7128.....	175	73010.....	62	74759.....	159
69343.....	409	69892.....	20	69982.....	20	7129.....	416	73025.....	174	74763.....	159
69344.....	409	69893.....	20	69983.....	20	713.....	283	73128.....	175	74764.....	159
69345.....	409	69894.....	20	69984.....	20	71342.....	60	73129.....	175	74765.....	159
69346.....	409	69895.....	20	69985.....	20	71343.....	60	73130.....	174	74766.....	160
69347.....	409	69896.....	20	69989.....	20	71344.....	60	7324.....	384	74769.....	266
69348.....	409	69897.....	20	69991.....	20	7144.....	133	7325.....	358	74777.....	195
69349.....	409	69898.....	20	69992.....	20	7145.....	182	73255.....	104	74779.....	64
69350.....	409	69899.....	15	7000.....	372	71482.....	30	73256.....	104	74781.....	64
69351.....	409	69900.....	15	70022.....	108	71483.....	30	7328.....	176	74782.....	64
69352.....	409	69901.....	15	70023.....	108	71484.....	30	7338.....	194	74783.....	64
69356.....	409	69902.....	15	70024.....	108	71485.....	30	7341.....	175	74784.....	64
69357.....	409	69903.....	15	70025.....	107	71486.....	30	7342.....	184	74785.....	64
69358.....	409	69904.....	15	70026.....	107	71487.....	30	73515.....	291	74787.....	64
69394.....	414	69905.....	15	70027.....	107	71488.....	30	7352.....	180	74788.....	64
69396.....	414	69906.....	15	70028.....	107	71499.....	29, 31	73529.....	41	7483.....	312
69409.....	414	69907.....	21	70029.....	107	71500.....	29, 31	7353.....	182	74847.....	258
69435.....	414	69908.....	21	70032.....	153	71501.....	29, 31	7363.....	358	74860.....	380
69437.....	414	69909.....	21	70035.....	153	71502.....	29, 31, 32	736.....	426	74870.....	157
69444.....	414	69910.....	21	70036.....	123	71503.....	29, 31	73644.....	133	74871.....	157
69446.....	414	69911.....	21	70038.....	123	71504.....	29, 31	737.....	205	74884.....	266
6945.....	312	69912.....	21	70039.....	123	71510.....	31, 32	7373.....	358	7510.....	202
6948.....	367	69913.....	21	70040.....	123	71511.....	29, 31, 32	73745.....	45	75288.....	418
69495.....	379	6991.....	376	70041.....	123	71512.....	29, 31	7375.....	187	75322.....	266
69496.....	379	69914.....	21	70044.....	123	71518.....	29, 31, 32	7376.....	293	7538.....	307
69554.....	142	69915.....	21	70079.....	124	71519.....	29	73794.....	159	75390.....	404
69583.....	372	69916.....	21	70081.....	124	71537.....	196	73799.....	158	75399.....	212
69590.....	249	69917.....	21	70082.....	124	716.....	181	7385.....	369	75413.....	320
69593.....	142	69918.....	21	70083.....	124	7164.....	180	73876.....	436	75431.....	399
69594.....	142	69919.....	21	70084.....	124	71756.....	399	73877.....	436	7549.....	212
69595.....	142	69920.....	21	7008.....	435	71759.....	399	73878.....	436	75509.....	92
69596.....	142	69921.....	21	70085.....	124	7176.....	133	7390.....	293	75510.....	92
69609.....	414	6992.....	172	70086.....	138	71761.....	399	73926.....	433	755.....	190
6961.....	298	69922.....	21	70087.....	138	71762.....	399	73927.....	433	7555.....	307
69628.....	98	69924.....	21	70088.....	138	7184.....	293	73928.....	429	75589.....	305
69661.....	18	69926.....	21	70110.....	20	71860.....	165	73929.....	429	7561.....	212
69662.....	238	69927.....	21	70118.....	116	7195.....	293	73930.....	429	756.....	305
6971.....	428	69928.....	20	701.....	287	7198.....	176	73967.....	127	7565.....	177
6973.....	180	69930.....	22	7013.....	175	7199.....	312	73969.....	380	75675.....	142
6975.....	313	69931.....	22	70279.....	129	72053.....	129	7397.....	293	7573.....	212
6978.....	298	69932.....	22	70280.....	130	7208.....	293	7399.....	422	7574.....	303
69842.....	53	69933.....	22	70363.....	266	72121.....	368	740.....	202	7576.....	183

Index by Part Number

7578.....	389	78098.....	16	80252.....	55	81903.....	60	84126.....	435	87662.....	242
7580.....	174	78099.....	16	80253.....	55	8192.....	186	84134.....	320	877.....	245
75807.....	397	78100.....	16	80254.....	55	81938.....	58	8418.....	299	87854.....	207
75808.....	397	7814.....	378	80255.....	55	81947.....	80	84187.....	187	8799.....	293
7581.....	170	78152.....	71	80256.....	55	81963.....	32	84.....	204	8802.....	367
75833.....	386	7818.....	369	80257.....	55	8201.....	175	8444.....	312	881.....	205
75834.....	380	7819.....	169	80258.....	55	8206.....	312	84466.....	125	88134.....	300
75836.....	159	78211.....	122	80276.....	58	82142.....	116	84542.....	361	8824.....	236
75837.....	160	78248.....	261	80277.....	58	8214.....	299	8479.....	367	8825.....	250
75839.....	159	7842.....	285	80278.....	58	82150.....	166	8480.....	264	88259.....	183
75840.....	159	78436.....	365	80279.....	58	82151.....	166	84842.....	29, 31	8828.....	367
75841.....	159	78443.....	91, 316	80280.....	58	82152.....	166	84843.....	29, 31	88338.....	168
75842.....	159	7846.....	176	80281.....	58	82158.....	128	84965.....	129	8834.....	363
75851.....	159	78537.....	242	80282.....	58	8225.....	292	8507.....	424	8836.....	236
75860.....	98	78538.....	242	80283.....	58	8228.....	133	8511.....	182	8837.....	287
75923.....	414	78595.....	328	80284.....	58	82291.....	223	8523.....	175	88416.....	71
75945.....	227	78624.....	169	80286.....	58	82297.....	360	8524.....	375	8845.....	175
7600.....	212	7874.....	176	80287.....	58	8236.....	292	8526.....	182	8846.....	236
76108.....	377	7880.....	366	80288.....	58	8237.....	186	85279.....	318	8848.....	367
76109.....	377	788.....	344	80289.....	58	82404.....	223	8532.....	184	8855.....	177
76110.....	379	78853.....	399	80290.....	58	82405.....	223	8536.....	367	8859.....	236
7611.....	185	78870.....	369	80291.....	58	82406.....	223	8537.....	307	88628.....	113
76113.....	379	78871.....	369	80292.....	58	82407.....	223	8539.....	171	8871.....	180
76114.....	98	7887.....	206	80293.....	57	8243.....	180	8555.....	358	8883.....	190
7620.....	212	78990.....	266	80294.....	57	8247.....	292	85569.....	248	8887.....	303
76212.....	51	7902.....	378	80295.....	57	82491.....	316	8557.....	182	8898.....	366
76221.....	406	79086.....	128	80296.....	57	82492.....	294	8563.....	210	8904.....	190
76222.....	406	79087.....	128	80297.....	57	82493.....	294	8567.....	179	8925.....	301
76223.....	406	79088.....	116	80298.....	57	82497.....	387	8568.....	248	8937.....	301
76224.....	406	79089.....	116	80299.....	57	82571.....	60	8572.....	240	8939.....	312
76225.....	406	79115.....	171	80300.....	57	82572.....	60	8577.....	210	8942.....	343
7626.....	307	7914.....	306	80301.....	57	82574.....	60	85778.....	242	8950.....	301
76277.....	116	79167.....	80	80302.....	57	82577.....	60	85807.....	281	89516.....	146
76278.....	112	79169.....	80	8032.....	307	826.....	205	85808.....	281	89525.....	242
76297.....	64	79170.....	80	80325.....	75	8263.....	283	85809.....	281	8953.....	286
76348.....	399	79171.....	80	8035.....	292	8269.....	176	8582.....	278	8957.....	301
76390.....	404	79172.....	80	8048.....	307	8271.....	378	8587.....	210	8959.....	175
7647.....	299	79173.....	80	8054.....	180	8280.....	364	8590.....	299	89656.....	383
7652.....	233	7921.....	188	8059.....	425	8282.....	173	86001.....	210	89658.....	242
76645.....	18, 25	7923.....	378	806.....	303	82883.....	62	8600.....	210	8968.....	301
7679.....	203	7924.....	312	8063.....	186	82884.....	359	86002.....	210	8970.....	67
7682.....	173	79254.....	269	8070.....	180	829.....	245	8609.....	240	89754.....	333
76869.....	133	79274.....	114	8071.....	182	8296.....	286	8613.....	210	8977.....	301
76922.....	159	7928.....	303	80736.....	29, 31	8298.....	299	8625.....	175	8985.....	301
7692.....	312	79369.....	81	8074.....	299	8299.....	175	8627.....	210	89862.....	247
76994.....	16	7937.....	203	8078.....	184	83040.....	122	8631.....	170	8986.....	357
76995.....	16	79490.....	93	80785.....	325	83041.....	122	8638.....	301	8989.....	172
76996.....	16	79498.....	382	80822.....	80	83042.....	122	86416.....	350	8994.....	286
76997.....	16	79499.....	382	8084.....	286	8305.....	201	86445.....	200	8995.....	301
7703.....	132	7950.....	172	8089.....	169	8306.....	180	86447.....	200	9000.....	286
7706.....	132	79564.....	129	8091.....	175	8309.....	177	8645.....	210	9013.....	287
7710.....	171	7959.....	194	80972.....	433	83117.....	319	8657.....	294	9016.....	385
77153.....	414	7960.....	378	81078.....	354	8312.....	175	86599.....	435	9022.....	367
77154.....	414	79617.....	81	81107.....	53	8314.....	392	8664.....	250	90226.....	246
77155.....	414	7963.....	190	81190.....	232	8319.....	425	86656.....	171	9025.....	180
7716.....	176	7964.....	312	8119.....	175	83.....	211	86657.....	171	9026.....	186
7722.....	356	79706.....	81	81311.....	169	8322.....	307	86658.....	172	9027.....	176
77262.....	207	79708.....	81	8137.....	180	8324.....	286	8668.....	173	9029.....	300
77263.....	207	79709.....	81	8147.....	357	8329.....	194	8673.....	210	90330.....	346
77264.....	207	79710.....	81	81544.....	432	8330.....	378	867.....	379	90331.....	346
77265.....	207	7972.....	357	81545.....	432	8336.....	133	8677.....	67	90332.....	355
77266.....	207	7973.....	176	81555.....	381	83374.....	425	8678.....	250	90335.....	345
77306.....	234	7976.....	366	8161.....	184	8345.....	378	8682.....	179	90337.....	345
7737.....	186	79789.....	91, 316	81702.....	32	8357.....	176	8685.....	210	90338.....	342
7745.....	312	79807.....	51	81703.....	32	83682.....	125	86876.....	247	90347.....	346
775.....	205	7982.....	180	81704.....	32	8380.....	194	86981.....	130	90350.....	377
7753.....	305	79828.....	29, 31	81705.....	32	8382.....	294	8701.....	184	90353.....	374
77574.....	142	79829.....	345	81709.....	32	83890.....	84	8704.....	355	90354.....	338
77620.....	150	7984.....	175	81714.....	42	8394.....	327	8707.....	305	90356.....	337
776.....	370	79876.....	80	81758.....	62	8396.....	312	871.....	174	90357.....	133
77677.....	154	79885.....	80	81759.....	62	83974.....	187	8713.....	210	90358.....	337
77820.....	127	7993.....	176	81760.....	62	83975.....	187	87190.....	45	90360.....	336
7783.....	184	79960.....	130	81762.....	62	83976.....	187	87281.....	363	90361.....	336
77871.....	364	79961.....	129	81764.....	60	83977.....	187	87339.....	71	90362.....	336
7795.....	287	8009.....	262	8177.....	180	8399.....	186	8735.....	210	9036.....	298
7799.....	303	8014.....	212	8178.....	184	84035.....	414	8746.....	175	90363.....	337
7802.....	177	8023.....	212	8181.....	241	8412.....	175	8763.....	425	90364.....	339



Index by Part Number

90366.....	339	9162.....	264	97363.....	42
90392.....	375	9164.....	173	97365.....	42
90395.....	375	91687.....	13, 18, 25	9737.....	203
90396.....	375	9190.....	141	9738.....	205
90398.....	375	9191.....	190	9748.....	297
90401.....	357	9196.....	440	9759.....	180
90402.....	357	9204.....	386	9762.....	367
90404.....	352	9222.....	268	9764.....	205
9043.....	311	9224.....	67	9773.....	297
90439.....	335	9234.....	169	9775.....	239
90467.....	105	9236.....	367	9777.....	367
90471.....	105	9247.....	175	9792.....	205
9050.....	300	9251.....	219	9798.....	66
9051.....	311	925.....	188	9805.....	302
9054.....	362	9254.....	79	9816.....	302
9062.....	387	9255.....	320	9827.....	302
9068.....	367	9256.....	185	9830.....	177
90714.....	247	9262.....	180	9855.....	180
90797.....	318	9272.....	203	9869.....	302
90799.....	322	9277.....	254	9871.....	190
90800.....	318	9281.....	297	9895.....	367
90801.....	320	9285.....	171	9901.....	302
90802.....	322	9286.....	254	9907.....	133
90803.....	320	9288.....	203	9913.....	299
90805.....	322	9292.....	248	9914.....	180
90806.....	284	9297.....	286	9915.....	302
90807.....	325	9302.....	381	9927.....	302
90808.....	324	9303.....	176	9941.....	194
90809.....	324	9304.....	174	9944.....	302
9081.....	172	9306.....	286	9946.....	91, 311
90814.....	304	9316.....	249	9948.....	297
90815.....	304	9317.....	248	9952.....	367
90816.....	304	9323.....	306	9965.....	367
90817.....	304	9325.....	302	9968.....	299
90818.....	304	9326.....	181	9970.....	302
90819.....	333	9342.....	297	9975.....	286
90821.....	348	9365.....	170	9977.....	297
90822.....	347	937.....	304	999.....	205
90823.....	333	9376.....	268	9993.....	367
90824.....	348	9386.....	179	9996.....	218
90825.....	348	9387.....	360	99989.....	44
90827.....	348	9393.....	202		
90828.....	347	9400.....	180		
90829.....	348	9420.....	367		
90830.....	348	944.....	169		
90831.....	358	9448.....	175		
90832.....	358	9452.....	67		
9083.....	293	9455.....	181		
90833.....	358	9467.....	183		
90835.....	348	9476.....	297		
90838.....	348	9481.....	297		
90839.....	349	9492.....	79		
90840.....	348	9503.....	367		
90842.....	349	9507.....	169		
90843.....	348	951.....	287		
90844.....	348	952.....	307		
90845.....	348	9523.....	432		
90846.....	348	9540.....	301		
90847.....	320	9565.....	79		
90848.....	348	9574.....	174		
90856.....	348	9583.....	357		
90857.....	348	9596.....	439		
9086.....	356	9597.....	385		
9091.....	174	9608.....	180		
9093.....	293	961.....	205		
9096.....	293	9619.....	267		
90992.....	292	96.....	211		
9110.....	172	9632.....	264		
91161.....	196	9685.....	171		
9119.....	190	9707.....	67		
9129.....	201	9713.....	192		
9131.....	190	9714.....	177		
9136.....	186	9717.....	367		
9144.....	173	97196.....	42		
915.....	187	9721.....	170		
9154.....	286	9724.....	299		

Refrigeration Information

Basic Refrigeration Cycle

Mechanical refrigeration is accomplished by a continuously circulating, evaporating and condensing a fixed supply of refrigerant in a closed system. Evaporation occurs at a low temperature and low pressure while condensation occurs at a high temperature and high pressure. Thus, it is possible to transfer heat from an area of low temperature (i.e., refrigerator cabinet) to an area of high temperature (i.e., kitchen).

Beginning the cycle at the evaporator inlet (1) the low pressure liquid expands, absorbs heat and evaporates, changing to a low pressure gas at the evaporator outlet (2).

The compressor (4) pumps this gas from the evaporator through the accumulator (3), increases its pressure, and discharges the high pressure gas to the condenser (5). The accumulator is designed to protect the compressor by preventing slugs of liquid refrigerant from passing directly into the compressor. An accumulator should be included on all systems subjected to varying load conditions or frequent compressor cycling. In the condenser, heat is removed from the gas, which then condenses and becomes a high pressure liquid. In some systems, this high pressure liquid drains from the condenser into a liquid storage or receiver tank (6). On other systems, both the receiver and the liquid line valve (7) are omitted.

A heat exchanger (8) between the liquid line and the suction line is also an optional item, which may or may not be included in a given system design.

Between the condenser and the evaporator an expansion device (10) is located. Immediately preceding this device is a liquid line strainer/drier (9), which prevents plugging of the valve or tube by retaining scale, dirt and moisture. The flow of refrigerant into the evaporator is controlled by the pressure differential across the expansion device or, in the case of a thermal expansion valve, by the degree of superheat of the suction gas. Thus, the thermal expansion valve shown requires a sensor bulb located at the evaporator outlet. In any case, the flow of refrigerant into the evaporator normally increases as the evaporator load increases.

As the high pressure liquid refrigerant enters the evaporator, it is subjected to a much lower pressure due to the suction of the compressor and the pressure drop across the expansion device. Thus, the refrigerant tends to expand and evaporate. In order to evaporate, the liquid must absorb heat from the air passing over the evaporator.

Eventually, the desired air temperature is reached and the thermostat or cold control (11) will break the electrical circuit to the compressor motor and stop the compressor.

As the temperature of the air through the evaporator rises, the thermostat or cold control remakes the electrical circuit. The compressor starts, and the cycle continues.

In addition to the accumulator, a compressor crankcase heater (12) is included on many systems. This heater prevents accumulation of refrigerant in the compressor crankcase during the nonoperating periods and prevents liquid slugging or oil pump-out on startup.

Additional protection to the compressor and system is afforded by a high and low pressure cutout (13). This control is set to stop the compressor in the event that the system pressures rise above or fall below the design operating range.

Other controls not indicated on the basic cycle which may be part of a system include: evaporator pressure regulators, hot gas by-pass regulators, electric solenoid valves, suction pressure regulators, condenser pressure regulators, low side or high side float refrigerant controllers, oil separators, etc.

It is extremely important to analyze completely every system and understand the intended function of each component before attempting to determine the cause of a malfunction or failure.

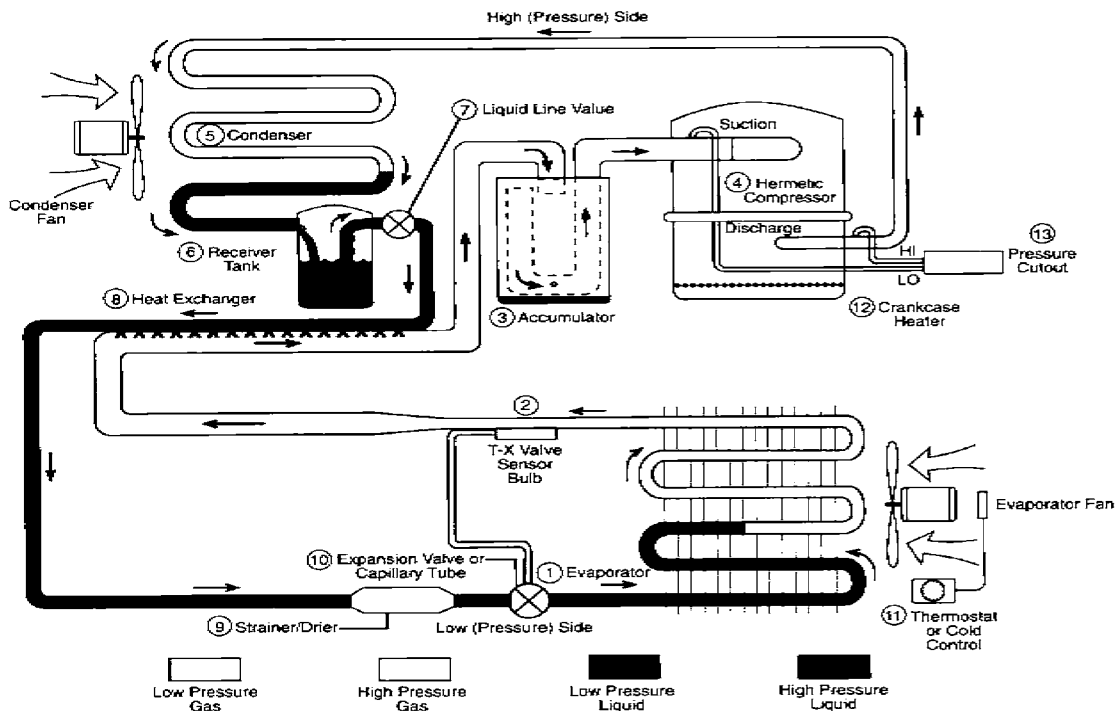

Split Troubleshooting AC Guide

Company name _____ Technician name _____ Date _____

Customer name _____ Indoor wet bulb _____ Indoor dry bulb _____ Outdoor dry bulb _____

Design suction pressure on charging chart _____ Design discharge pressure on charging chart _____

Outdoor temp next to condenser _____ Primary voltage (loaded) _____ Secondary (low) voltage _____

Amps to outdoor motor _____ Compressor amps: Common _____ Run _____ Start _____

Capacitor rating _____

Return temp at grill _____ Return temp at unit _____

Supply temp at unit _____ Supply temp at registers _____

shortest run middle run furthest run

Blower speed tap for PSC & CTM
Cooling CFM setting on VS motor
Heating CFM setting on VS motor

Number of green CFM flashes at air handler _____

Leaving air temp _____

Temp drop across dryer and check valve _____

Discharge temp _____

Discharge press _____

Suction press _____

Temp rise on suction lines across valve _____

Liquid pressure _____

Vapor pressure _____



Line set length _____

Line sizes _____

Lift & # elbows _____

Vapor line temp _____

Liquid line temp _____

Superheat _____

Subcooling _____

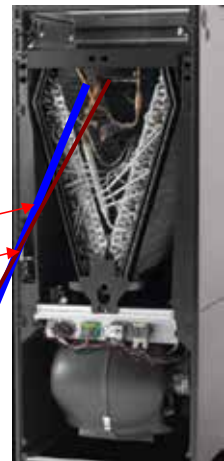

Liquid line temp _____

Vapor line temp _____

Return static with filter _____ Return static w/o filter _____ Filter type _____ Filter size _____

Supply static with filter _____

Condenser Model # _____ Condenser Serial # _____

Air Handler Model # _____ Air Handler Serial # _____

Coil Model # _____ Coil Serial # _____

Furnace Model # _____ Furnace Serial # _____

Refer to manufacturer's instructions and local codes.

AC/Refrigeration: Measuring Liquid Subcooling Level

You must measure the liquid subcooling level to confirm there is adequate refrigerant charge in the condenser coil.

Inadequate subcooling could cause flash gas to form in the liquid line.
Excessive shooting is an indication of an overcharged system.

REQUIRED TOOLS: DIGITAL TEMPERATURE PROBE, REFRIGERATION GAUGES

1. Run the condensing unit until pressures and temperature stabilize.
2. Read and record the liquid pressure at the liquid line pressure port fitting at the condensing unit.
3. Place a digital temperature probe against the liquid line near the liquid gauge pressure port. Read and record the temperature.
4. Reference the face of your high pressure gauge or use a temperature/pressure chart and convert the measured liquid pressure to the corresponding condenser coil saturation temperature for the refrigerant being used. Record this value.
5. Next, subtract the measured liquid line temperature from saturation temperature. The result is your actual liquid subcooling level.



FORMULA:

$$\frac{\text{Saturation Temperature} - \text{Liquid Line Temperature}}{\text{Liquid Subcooling}}$$

EXAMPLE:

Refrigerant: R-410A

Liquid Line Pressure: 320 PSIG

Corresponding Condenser Saturation Temperature 100°F

Liquid Line Temperature: 90°F

100°F - 90°F = Liquid Subcooling

Liquid Subcooling = 10°F

Refrigeration Troubleshooting

PROBLEM	POSSIBLE CAUSES	POSSIBLE CORRECTIVE STEPS
Compressor will not run	<ol style="list-style-type: none"> 1. Main switch open. 2. Fuse blown. 3. Thermal overloads tripped. 4. Defective contactor or coil. 5. System shut down by safety devices. 6. No cooling required. 7. Liquid line solenoid will not open. 8. Motor electrical trouble. 9. Loose wiring. 10. Phase loss monitor inoperative. 	<ol style="list-style-type: none"> 1. Close switch. 2. Check electrical circuits and motor winding for shorts or grounds. Investigate for possible overloading. Replace fuse after fault is corrected. 3. Overloads are automatically reset. Check unit closely when unit comes back on line. 4. Repair or replace. 5. Determine type and cause of shutdown and correct it before resetting safety switch. 6. None. Wait until calls for cooling. 7. Repair or replace coil. 8. Check motor for open windings, short circuit or burn out. 9. Check all wire junctions. Tighten all terminal screws. 10. Refer to page 18.
Compressor noisy or vibrating	<ol style="list-style-type: none"> 1. Flooding of refrigerant into crankcase. 2. Improper piping support on suction or liquid line. 3. Worn compressor. 4. Scroll compressor rotation reversed. 	<ol style="list-style-type: none"> 1. Check setting of expansion valves. 2. Relocate, add or remove hangers. 3. Replace. 4. Rewire for phase change.
High discharge pressure	<ol style="list-style-type: none"> 1. Non-condensables in system. 2. System overcharges with refrigerant. 3. Discharge shutoff valve partially closed. 4. Fan not running. 5. Head pressure control setting. 6. Dirty condenser coil. 	<ol style="list-style-type: none"> 1. Remove the non-condensables. 2. Remove excess. 3. Open valve. 4. Check electrical circuit. 5. Adjust. 6. Clean.
Low discharge pressure	<ol style="list-style-type: none"> 1. Faulty condenser temperature regulation. 2. Suction shutoff valve partially closed. 3. Insufficient refrigerant in system. 4. Low suction pressure. 5. Variable head pressure valve. 	<ol style="list-style-type: none"> 1. Check condenser control operation. 2. Open valve. 3. Check for leaks. Repair and add charge. 4. See corrective steps for low suction pressure. 5. Check valve setting.
High suction pressure	<ol style="list-style-type: none"> 1. Excessive load. 2. Expansion valve overfeeding. 	<ol style="list-style-type: none"> 1. Reduce load or add additional equipment. 2. Check remote bulb. Regulate superheat.
Low suction pressure	<ol style="list-style-type: none"> 1. Lack of refrigerant. 2. Evaporator dirty or iced. 3. Clogged liquid line filter drier. 4. Clogged suction line or compressor suction gas strainers. 5. Expansion valve malfunctioning. 6. Condensing temperature too low. 7. Improper TXV. 	<ol style="list-style-type: none"> 1. Check for leaks. Repair and add charge. 2. Clean. 3. Replace cartridge(s). 4. Clean strainers. 5. Check and reset for proper superheat. 6. Check means for regulating condensing temperature. 7. Check for proper sizing.
Little or no oil pressure	<ol style="list-style-type: none"> 1. Clogged suction oil strainer. 2. Excessive liquid in crankcase. 3. Low oil pressure safety switch defective. 4. Worn oil pump. 5. Oil pump reversing gear stuck in wrong position. 6. Worn bearings. 7. Low oil level. 8. Loose fitting on oil lines. 9. Pump housing gasket leaks. 	<ol style="list-style-type: none"> 1. Clean. 2. Check crankcase heater. Reset expansion valve for higher superheat. Check liquid line solenoid valve operation. 3. Replace. 4. Replace. 5. Reverse direction of compressor rotation. 6. Replace compressor. 7. Add oil and/or through defrost. 8. Check and tighten system. 9. Replace gasket.
Compressor loses oil	<ol style="list-style-type: none"> 1. Lack of refrigerant. 2. Excessive compression ring blowby. 3. Refrigerant flood back. 4. Improper piping or traps. 	<ol style="list-style-type: none"> 1. Check for leaks and repair. Add refrigerant. 2. Replace compressor. 3. Maintain proper superheat at compressor. 4. Correct piping.
Compressor thermal protector switch open.	<ol style="list-style-type: none"> 1. Operating beyond design conditions. 2. Discharge valve partially shut. 3. Blown valve plate gasket. 4. Dirty condenser coil. 5. Overcharged system. 	<ol style="list-style-type: none"> 1. Add facilities so that conditions are within allowable limits. 2. Open valve. 3. Replace gasket. 4. Clean coil. 5. Reduce charge.

Furnace Troubleshooting Guide

Company name _____ Technician name _____ Date _____

Customer name _____

Flash code _____ Elevation of home _____ High altitude kit used _____ Natural or LP gas _____

Primary voltage: Hot to neutral _____ Hot to ground _____

Neutral to ground _____ Line neutral to 24 V common _____ Flame rectification _____

Secondary voltage _____ Is secondary physically grounded _____ Low fire pressure _____

Inlet gas pressure _____ High fire pressure _____

Return temp at grill _____ Return temp at unit _____

Supply temp at unit _____ Supply temp at registers _____
shortest run middle run furthest run

Blower speed tap for PSC & CTM
Cooling CFM setting on VS motor
Heating CFM setting on VS motor

Number of green CFM flashes at furnace _____

Combustion blower amps _____ System blower amps _____ Flue size _____

Length of flue _____ # of elbows _____ # of 45's _____

Combustion length _____ # of elbows _____ # of 45's _____



High fire vent pressure on 80% _____

High fire vent pressure differential between combustion box and secondary heat exchanger on 90+% _____

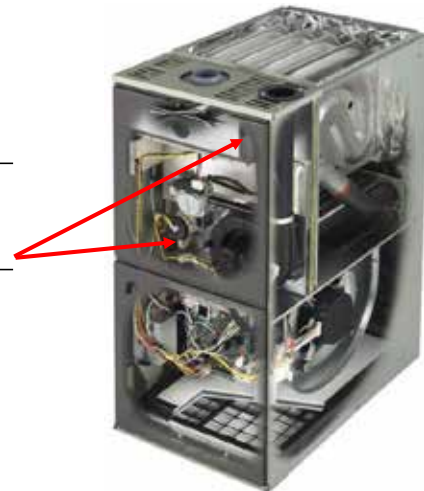

Return static with filter _____ Return static w/o filter _____ Filter type _____ Filter size _____

Furnace position: Upflow _____ Downflow _____

Supply static above coil (w/filter in place) _____ Supply static between furnace & coil if possible (w/filter) _____

Horizontal laying on left side _____ Horizontal laying on right side _____

Furnace Model # _____ Furnace Serial # _____

Coil Model # _____ Condenser Model # _____

Models and Specifications are Subject to Change Without Notice

Air Flow in CFM Gas Fired Furnace

$$\text{CFM} = \frac{\text{BTU OUTPUT}}{\text{TEMP RISE} \times 1.08}$$

EXAMPLE:

SUPPLY AIR = 150°

RETURN AIR = 75°

TEMP RISE = 75°

75 x 1.08 = 81°

FURNACE OUTPUT = 100,000 BTU

$$\frac{100,000}{81} = 1235 \text{ CFM}$$

NOTES:

- Switch cooling and heating speeds on board
- Make sure furnace gas pressure = 3.5" BTU
- Wait ten minutes before measuring temperature

Furnace Fault Diagnostics

LED FLASH	LED FLASH
Slow Flash	Normal standby
Fast Flash	Normal with a call for heat.
Continuous ON	Internal fault in the IFC.
2 Flashes	System lockout - no flame. Total of three tries. Automatic reset in one hour.
3 Flashes	Pressure switch error. (Fault may be caused by a vent problem or a wiring connection in the switch circuit.) On two speed furnaces, if there is a high heat pressure switch fault, the IFC will not lock out. It will go back to low heat, cancel the three flash indication for ten minutes and again try high heat.
4 Flashes	Thermal protection device open.
5 Flashes	Flame being sensed with gas valve de-energized (stuck open). Vent motor and indoor blower will be energized.
6 Flashes	No ground or power leads to furnace reversed, or line voltage too low.
7 Flashes	20VAC at gas valve with no call for heat or if no flame is present; keep vent motor on.
8 Flashes	Low flame sense signal.
9 Flashes	Ignitor fault or improper ground or low voltage.

2 Flash code:

- HSI Check (sini) 11-18 ohms & 85 volts
- Flame sensor 2-4 DCMA 1 MIN
- Inlet & Manifold pressure 5' min. inlet
- 1.4" - 1.7" 1st stage 3.5" 2nd stage nat.
- 6.0" 1st stage 10.5" - 11" 2nd stage lp

3 Flash code:

- Monitor negative pressure developed by inducer
- Check against pressure switch rating
- Check for restriction in vent
- Check to see if inducer is running at correct speed

4 Flash code:

- Check filter
- Check blower operation
- Check supply and return registers
- Measure static pressure
- For flame rollout check inducer, vent pipe
- Combustion air

5 Flash code:

- DO NOT TURN OFF POWER
- Check for grounded flame sensor
- Replace gas valve

6 Flash code:

- Voltage check 120 hot to neutral
- Neutral to ground should be 0 volts
- Check furnace grounds
- IFC CNT4677 & 4678 ohm & volt check
- On HSI

7 Flash code:

- Check for 24 volts at gas valve & IFC
- Valve energized before HSI replace IFC

8 Flash code:

- Check flame sensor, clean

9 Flash code:

- Ohm ignitor 11 - 18 for sini
- Check ground
- Check voltage between neutral & b/c term on IFC less than 2 vac
- CNT4677 & 4678 boards inducer limit open



Furnace Fault Diagnostics

The diagnostics will indicate the specific fault through the following code:

GREEN LED FLASH	AMBER LED FLASH	RED LED FLASH	ERROR
		1	Flame sensed when no flame should be present
		2	Pressure switch stuck closed
		3	1st stage pressure switch is open / not closing
		4	Open thermal limit or open rollout
		5	Open low voltage fuse
		6	1st stage pressure switch opened 5 times within one cycle—1 hour lockout
		7	System lockout - retry
		8	System lockout - recycle
		9	Reverse polarity or poor grounding
		10	Gas valve energized without call for heat
		12	Ignitor relay failure internal in board. Replace IFC
		Solid	Gas valve relay failure internal board. Replace IFC
		3 Double	2nd stage pressure switch open; system reverts back to 1st stage heat
	1		1st stage call for heat
	2		2nd stage call for heat
	3		W2 call present without W1
	4		Y call present withough G
	Rapid		Low flame sense current
1			Standby mode or call for cooling

Gas Piping Information

TABLE 402.3(1)
MAXIMUM CAPACITY OF PIPE IN CUBIC FEET OF GAS PER HOUR FOR GAS PRESSURES OF 0.5 PSI OR LESS AND A PRESSURE DROP OF 0.3-INCH WATER COLUMN
Based on a 0.60 Specific Gravity Gas

NOMINAL IRON PIPE SIZE (inches)	INTERNAL DIAMETER (inches)	LENGTH OF PIPE (feet)													
		10	20	30	40	50	60	70	80	90	100	125	150	175	200
1/4	.364	32	22	18	15	14	12	11	11	10	9	8	8	7	6
3/8	.493	72	49	40	34	30	27	25	23	22	21	18	17	15	14
1/2	.622	132	92	73	63	56	50	46	43	40	38	34	31	28	26
3/4	.824	278	190	152	130	115	105	96	90	84	79	72	64	59	55
1	1.049	520	350	285	245	215	195	180	170	160	150	130	120	110	100
1 1/4	1.380	1,050	730	590	500	440	400	370	350	320	305	275	250	225	210
1 1/2	1.610	1,600	1,100	890	760	670	610	560	530	490	460	410	380	350	320
2	2.067	3,050	2,100	1,650	1,450	1,270	1,150	1,050	990	930	870	780	710	650	610
2 1/2	2.469	4,800	3,300	2,700	2,300	2,000	1,850	1,700	1,600	1,500	1,400	1,250	1,130	1,050	980
3	3.068	8,500	5,900	4,700	4,100	3,600	3,250	3,000	2,800	2,600	2,500	2,200	2,000	1,850	1,700
4	4.026	17,500	12,000	9,700	8,300	7,400	6,800	6,200	5,800	5,400	5,100	4,500	4,100	3,800	3,500

For SI: 1 inch = 25.4 mm, 1 foot = 304.8 mm, 1 cubic foot per hour = 0.0283 m³/h, 1 pound per square inch = 6.895 kPa, 1-inch water column = 0.2488 kPa.

TABLE 402.3(2)
MAXIMUM CAPACITY OF PIPE IN CUBIC FEET OF GAS PER HOUR FOR GAS PRESSURES OF 0.5 PSI OR LESS AND A PRESSURE DROP OF 0.5-INCH WATER COLUMN
Based on a 0.60 Specific Gravity Gas

NOMINAL IRON PIPE SIZE (inches)	INTERNAL DIAMETER (inches)	LENGTH OF PIPE (feet)													
		10	20	30	40	50	60	70	80	90	100	125	150	175	200
1/4	.364	43	29	24	20	18	16	15	14	13	12	11	10	9	8
3/8	.493	95	65	52	45	40	36	33	31	29	27	24	22	20	19
1/2	.622	175	120	97	82	73	66	61	57	53	50	44	40	37	35
3/4	.824	360	250	200	170	151	138	125	118	110	103	93	84	77	72
1	1.049	680	465	375	320	285	260	240	220	205	195	175	160	145	135
1 1/4	1.380	1,400	950	770	660	580	530	490	460	430	400	360	325	300	280
1 1/2	1.610	2,100	1,460	1,180	990	900	810	750	690	650	620	550	500	460	430
2	2.067	3,950	2,750	2,200	1,900	1,680	1,520	1,400	1,300	1,220	1,150	1,020	950	850	800
2 1/2	2.469	6,300	4,350	3,520	3,000	2,650	2,400	2,250	2,050	1,950	1,850	1,650	1,500	1,370	1,280
3	3.068	11,000	7,700	6,250	5,300	4,750	4,300	3,900	3,700	3,450	3,250	2,950	2,650	2,450	2,280
4	4.026	23,000	15,800	12,800	10,900	9,700	8,800	8,100	7,500	7,200	6,700	6,000	5,500	5,000	4,600

For SI: 1 inch = 25.4 mm, 1 foot = 304.8 mm, 1 cubic foot per hour = 0.0283 m³/h, 1 pound per square inch = 6.895 kPa, 1-inch water column = 0.2488 kPa.



Meter Clocking Method

Meter Clocking Method

Caution: Make certain there is no gas flow through the meter other than to the appliance being checked.
Use Table to determine exact rate of gas flow to appliance.

METER FLOW RATE – CUBIC FEET PER HOUR (cfh).

To convert cfh to cubic meter per hour (M³/hr) multiply by .0283.

Sec for One Rev.	Meter Dial Used - Cu. Ft. per Rev.		Sec for One Rev.	Meter Dial Used - Cu. Ft. per Rev.			Sec for One Rev.	Meter Dial Used - Cu. Ft. per Rev.		
	1/2	1		1/2	1	2		1	2	5
10	180	360	35	52	103	206	60	60	120	300
11	164	327	36	50	100	200	62	58	116	290
12	150	300	37	49	97	195	64	56	112	281
13	139	277	38	48	95	189	66	55	109	273
14	129	257	39	46	92	185	68	53	106	265
15	120	240	40	45	90	180	70	52	103	257
16	113	225	41	44	88	176	72	50	100	250
17	106	212	42	43	86	172	74	49	97	243
18	100	200	43	42	84	167	76	48	95	237
19	95	189	44	41	82	164	78	46	92	231
20	90	180	45	40	80	160	80	45	90	225
21	86	171	46	39	78	157	84	43	86	214
22	82	164	47	38	77	153	88	41	82	205
23	78	157	48	38	75	150	92	39	78	196
24	75	150	49	37	74	147	96	38	75	188
25	72	144	50	36	72	144	100	36	72	180
26	69	138	51	35	71	141	105	34	69	172
27	67	133	52	35	69	138	110	33	66	164
28	64	129	53	34	68	136	120	30	60	150
29	62	124	54	33	67	133	130	28	55	138
30	60	120	55	33	66	131	140	26	52	129
31	58	116	56	32	64	129	150	24	48	120
32	56	113	57	32	63	126	160	23	45	113
33	55	109	58	31	62	124	170	21	43	106
34	53	106	59	31	61	122	180	20	40	100

To convert meter flow rate (cfh) to BTU per hour, multiply cfh (from table above) by the BTU heat content of the gas being used.

To convert input rating (BTU per hour as stamped on appliance nameplate) to meter flow rate (cfh).

Input rating in BTU per hour.

Input BTU/Hr. Per Spud	Natural Gas 1020 BTU - .65 SG 3-1/2" WC Manifold		Propane 2500 BTU - 1.5 SG 11" WC Manifold	
	Drill Size	Decimal Tolerance	Drill Size	Decimal Tolerance
12,000	51	.064 - .067	60	.038 - .040
15,000	48	0.73 - .076	58	.040 - .042
20,000	43	.086 - .089	55	.050 - .052
25,000	41	.093 - .096	53	.056 - .059
27,500	39	.097 - .100	53	.060 - .063
40,000	32	.113 - .116	49	.070 - .073
50,000	30	.124 - .128	46	.078 - .081
60,000	27	.140 - .144	43	.086 - .089
70,000	22	.153 - .157	42	.090 - .093
80,000	20	.156 - .161	40	.095 - .098
90,000	17	.168 - .173	38	.098 - .101
100,000	13	.180 - .185	35	.107 - .110
105,000	11	.186 - .191	34	.108 - .111
110,000	10	.188 - .193	33	.109 - .113
125,000	5	.200 - .205	1/8	.121 - .125
135,000	3	.208 - .213	30	.124 - .128
140,000	7/32	.214 - .219	30	.124 - .128
150,000	1	.223 - .228	29	.132 - .136
160,000	A	.229 - .234	28	.136 - .140
175,000	C	.237 - .242	27	.140 - .144
190,000	E	.245 - .250	25	.145 - .149
200,000	F	.252 - .257	23	.150 - .154
210,000	H	.261 - .266	21	.154 - .159
220,000	I	.267 - .272	20	.156 - .161
240,000	K	.276 - .281	18	.164 - .169
260,000	M	.290 - .295	16	.172 - .177
280,000	5/16	.307 - .312	13	.180 - .185
300,000	O	.311 - .316	11	.186 - .191
310,000	P	.318 - .323	9	.191 - .196
320,000	21/64	.323 - .328	7	.196 - .201

Meter Flue Venting

HEIGHT FOOTING	LATERAL	DIAMETER - "D" (inches)															
		3"		4"		5"		6"		7"							
		APPLIANCE INPUT RATING (Thousands of BTU per Hour)															
		FAN		NAT		FAN		NAT		FAN		NAT					
		MIN	MAX	MIN	MAX	MIN	MAX	MIN	MAX	MIN	MAX	MIN	MAX				
15'	Double	9"	22	52	38	30	104	70	38	179	114	48	284	174	84	370	240
	10"	29	47	33	40	97	66	51	165	108	64	252	166	94	356	230	
25'	Double	9"	50	51	35	75	102	68	182	173	112	144	261	174	182	367	238
	10"	-	-	-	31	93	95	63	128	161	105	182	246	162	228	350	227
30'	Double	9"	21	60	41	29	121	82	37	207	135	46	316	206	60	448	289
	10"	28	54	38	38	113	77	49	197	129	61	383	196	79	432	227	
35'	Double	9"	40	57	40	73	119	80	99	204	132	139	312	204	175	444	282
	10"	-	-	-	95	109	74	124	191	126	174	297	193	218	425	274	
40'	Double	9"	21	62	43	28	128	86	36	229	141	45	337	218	58	480	308
	10"	27	56	40	37	120	82	48	219	137	50	324	209	77	464	297	
45'	Double	9"	21	63	32	28	132	88	36	228	148	45	380	225	57	501	319
	10"	27	57	36	37	124	84	47	217	141	56	337	216	76	484	308	
50'	Double	9"	40	60	-	72	129	87	97	224	143	135	347	224	168	496	317
	10"	-	-	-	91	118	83	121	212	138	169	331	213	211	476	305	
55'	Double	9"	21	66	-	28	139	93	36	243	156	44	377	239	57	542	340
	10"	27	60	-	36	121	89	47	232	149	58	364	231	75	525	330	
60'	Double	9"	40	63	-	71	136	92	96	239	153	134	373	238	168	537	338
	10"	-	-	-	90	125	82	120	227	146	157	356	227	208	517	326	

HEIGHT FOOTING	COMMON	Common Vent Diameter - "D" (inches)														
		3"		4"		5"		6"		7"						
		APPLIANCE INPUT RATING (Thousands of BTU per Hour)														
		FAN		NAT		FAN		NAT		FAN		NAT				
		MIN	MAX	MIN	MAX	MIN	MAX	MIN	MAX	MIN	MAX	MIN	MAX			
15'	Double	100	90	73	153	131	115	227	182	165	342	282	224	445	355	292
	Single	97	86	70	151	127	112	220	177	160	333	274	219	435	347	286
25'	Double	116	104	88	184	157	138	270	221	198	409	341	268	537	434	350
	Single	111	100	84	178	152	134	262	214	192	398	332	261	524	423	342
30'	Double	122	110	94	195	168	148	289	238	213	438	367	288	576	468	376
	Single	116	106	90	189	162	143	280	229	206	426	357	279	562	456	367
35'	Double	125	113	98	202	175	154	301	249	222	457	385	300	603	492	392
	Single	119	109	93	195	168	148	291	239	214	444	374	291	588	479	382
45'	Double	151	119	104	216	189	166	325	271	240	494	420	326	656	541	424
	Single	124	114	99	208	180	158	314	260	229	480	407	316	640	526	413

REQUIREMENTS FOR GENERAL VENTING

- 1) Tru-Life™ systems are UL Listed for masonry chimneys that serve Category I appliances fired with propane or natural gas.
- 2) A "listed" liner or a tile liner that conforms to code must be used when venting gas-fired appliances into unlined masonry chimneys. Cracked or misaligned tiles do not qualify as a "code" liner.
- 3) A "listed" lining system must be installed when venting "fan assisted" appliance, on their own, into tile-lined chimneys.
- 4) Other appliances must not be vented into the air space around an installed Tru-Life™ system.
- 5) The outlet of the appliance being served may be larger in diameter than the Tru-Life™ system only if:
 - a) the vent is at least ten feet high.
 - b) the liner is no less than one table size smaller.
 - c) fan-assisted appliances reduced the "FAN MAX" by 10%.
 - d) "natural draft" appliances have an outlet larger than 4 inches.
- 6) A Tru-Life™ system that vents multiple appliances must have a diameter no smaller than the largest appliance outlet.
- 7) The smallest allowable Tru-Life™ diameter is preferred if the tables permit a choice.
- 8) In a vent system with more than two 90° elbows, each additional elbow or equivalent offset requires reducing the system's maximum capacity by 10%.
- 9) The installation of vent connectors must conform to the current National Fuel Gas Code: NFPA-54.
- 10) Gas vent installations must meet local code requirements.

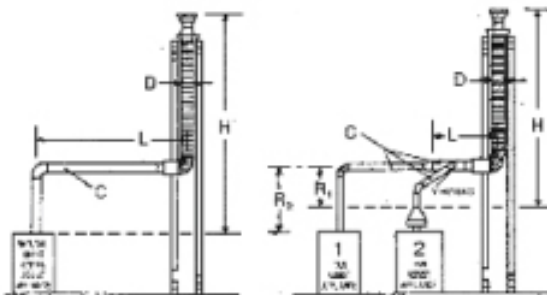

Furnace Quick Check Motor Will Not Run

These service procedures will work on ECM-2™ motors and their motor control board and their 16 wire low voltage control cable.

1. Jumper 24 Volt A.C. "R" terminal to "G" terminal on the low voltage terminal board.

Does motor run?

No: Go to step #2

Yes: Motor runs, check comfort control and comfort control wire.

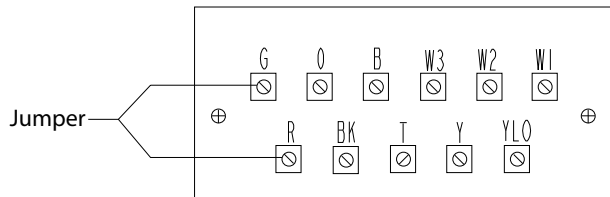

3. Unplug 16 wire low voltage harness from the motor. Jumper 24 volts A.C. to motor low voltage plug pins #12 and #15 and pins #1 and #3 which are common.

Does motor run?

No: Got to step #4.

Yes: Fault is in the 16 wire low voltage harness. Repair or replace it.

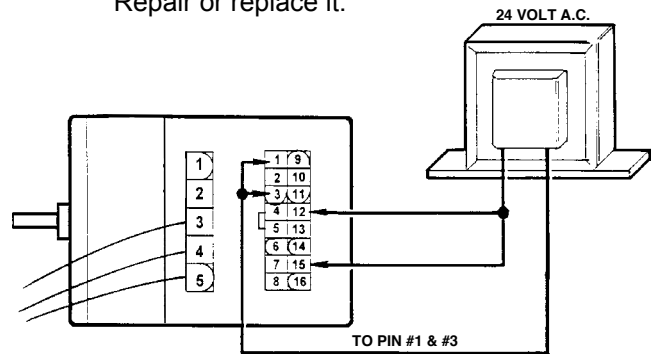

2. Unplug 16 wire low voltage harness from the interface board. Jumper 24 volts A.C. to pins #12, #15 and common pins #1 and #3.

Does the motor run?

No: Go to step #3.

Yes: Replace the variable speed interface board on the furnace.

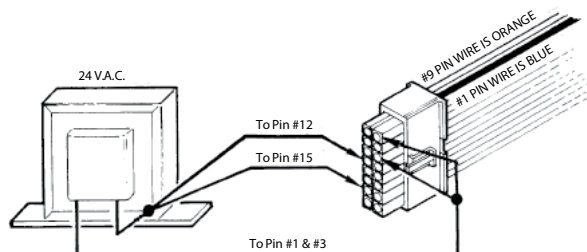

4. Is the line voltage to the motor high voltage power plug pin #4 and pin #5 correct?

No: Correct line voltage fault.

Yes: Live voltage correct and motor will not run. Replace module.

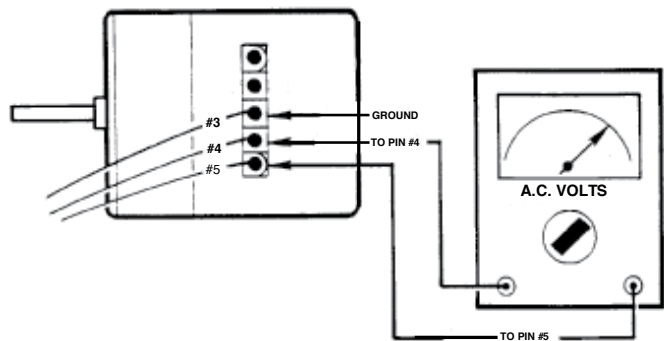

Hydronic Formulas

COMPUTING FLOW FROM BTU/h	
Simplified formula	$GPM = BTU/h \div (\Delta t \times 500)$
Example: Determine the flow of 286,000 BTU/h at a 20°F differential temperature.	$GPM = 286,000 \div (20 \times 500)$ $GPM = 286,000 \div 10,000$ $GPM = 28.6$

CALCULATING ACTIVE LOOP LENGTH	
Note: The leader length must be added to the active loop length in order to obtain the total loop length.	Room ft ² x 1.0 = active loop at 12" o.c. Room ft ² x 1.2 = active loop at 10" o.c. Room ft ² x 1.33 = active loop at 9" o.c. Room ft ² x 1.5 = active loop at 8" o.c. Room ft ² x 1.7 = active loop at 7" o.c. Room ft ² x 2.0 = active loop at 6" o.c.

AMOUNT OF JOIST TRAK™ PANELS (A5080375, A5080500)
Active loop length x 0.2125

AMOUNT OF QUIK TRAK™ PANELS (A5060701) AND RETURNS (A5060702)
Room ft ² x 0.386 (panels)
Room ft ² x 0.386 (panels)

AMOUNT OF PEX CLIPS (F7060375, F7051258, F7057500, F7051001)
Active Loop Length ÷ 3

FLOOR SURFACE TEMPERATURE
$(BTU/h / ft^2 \div 2.0) + \text{Room setpoint}$

SUPPLY FLUID TEMP. AFTER FIRST INJECTION POINT ON PRIMARY LOOP	
$(F_A \times T_A) + (F_B \times T_B) = (F_C \times T_C)$	
F_A = Primary flow rate after injection leg F_B = Flow rate for return injection leg F_C = Primary flow rate after return leg T_A = Primary temp. after injection leg T_B = Return temp. on return injection leg T_C = Primary temp. after return leg	
Example: Given the detail above, calculate the primary loop (boiler loop) temperature after the first injection location.	$(7 \times 180) + (3 \times 160) = 10x$ $1260 + 480 = 10x$ $1740 = 10x$ The primary loop temperature after the first injection location is 174°F.

INJECTION PUMP FLOW RATES	
$F_V = (F_1 \times T_D) \div (T_1 - T_R)$	
F_V = Flow rate (injection loop) in gpm F_1 = Radiant (secondary loop) flow rate in gpm T_1 = Boiler (primary loop) supply temp. T_2 = Radiant (secondary loop) supply temp. T_R = Radiant (secondary loop) return temp. T_D = Radiant (secondary loop) differential temp.	
Example: If values at design condition are: $F_1 = 30$ gpm $T_1 = 180^\circ\text{F}$ $T_2 = 130^\circ\text{F}$ $T_R = 120^\circ\text{F}$ $T_D = 10^\circ\text{F}$	Find the injection pump flow rate. $F_V = (30 \times 10) \div (180 - 120)$ $F_V = (300) \div (60)$ $F_V = 5$ gpm

LOADED FOR MOTORIZED VALVE ACTUATORS (MVA)
Computed at a minimum 10% line loss
MVA draw: 0.29 amps
Amps x volts = current
$0.29 \times 24 = 6.96$ VA per MVA
Example: $50 \text{ VA} \div 6.96 \text{ VA} = 7.18 \times 0.9 = 6.5$ (10%) 6 MVA per 50 VA transformer 40VAC transformer = 5 MVA 50VAC transformer = 6 MVA 75VAC transformer = 9 MVA 100VAC transformer = 12 MVA

LOADED FOR THERMAL ACTUATORS (TA)
Computed at a minimum 10% line loss
TA initial draw: 0.1458 amps
Amps x volts = current
$0.1458 \times 24 = 3.5$ VA per TA
Example: $50 \text{ VA} \div 3.5 \text{ VA} = 14.29$ $14.29 \times 0.9 = 12.83$ (10% reduction) 12 TAs per 50 VA transformer 40VAC transformer = 10 TA 50VAC transformer = 12 TA 75VAC transformer = 19 TA 100VAC transformer = 25 TA

Continued on next page

Hydronic Formulas

Continued ...

LOADED FOR THERMAL ACTUATORS (TA) Computed at a minimum 10% line loss
Fuel consumption based on degree day:
$F = \frac{HL \times 24 \times DD}{E \times P \times TD}$
HL = Heating load (BTU/h)
24 = Hours in a day
DD = Degree day
E = Boiler efficiency (AFUE)
P = Heating value of fuel (BTU)
TD = Temperature differential
F = Annual fuel consumption
<p>Example: A 40,000 square-foot hangar in Bangor, Maine using an 82% AFUE oil boiler (Number 2 fuel oil). The heat load for the hangar is 1,288,128 BTU/h at design. Outside design temperature is -11°F with an indoor setpoint temperature of 65°F. Number 2 fuel oil is priced at \$0.80 per gallon.</p>
$F = \frac{1,288,128 \times 24 \times 8,220}{0.82 \times 138,000 \times 76}$
$F = \frac{254,121,891.840}{8,662,480}$
F = 29,335.93 gallons of fuel oil
F = 29,335.93 x 0.80 = \$23,469/season

FUEL COMPARISON IN BTU	
Natural Gas	100,000 BTU per 1 CCF (1 therm.)
Propane	91,800 BTU per gallon
No. 2 Fuel Oil	139,000 BTU per gallon
Kerosene	134,000 BTU per gallon
Electric	3,412 BTU per Kilowatt Hour (KWH)
Wood	14,000,000 BTU per cord (mixed)

SUPPLY AND RETURN PIPE SIZING (AT A 10°F Δt)			
Tubing	BTU/h	GPM	Pipe Size (in.)
Copper	10K - 20K	2-4	¾"
	20K - 45K	4-9	1"
	30K - 80K	6-16	1 ¼"
	50K - 105K	10-21	1 ½"
	100K - 225K	20-45	2"
Multi-layer Composite (MLC)	10K - 20K	2-4	¾"
	20K - 45K	4-8	1"
PEX (Wirsbo hePEX™ and Uponor AquaPEX®)	2.5K - 10K	0.5-2	½"
	5K - 15K	1-3	¾"
	15K - 25K	3-5	1"
	20K - 45K	4-9	1 ¼"
	30K - 70K	6-14	1 ½"
High-density Polyethylene (HDPE)	75K - 205K	15-41	2"
	150K - 575K	30-115	3"
	250K - 1,125K	50-225	4"

BOILER MAIN PIPE SIZING (AT A 20°F Δt)			
Tubing	BTU/h	GPM	Pipe Size (in.)
Copper	20K - 40K	2-4	¾"
	40K - 90K	4-9	1"
	60K - 160K	6-16	1 ¼"
	100K - 210K	10-21	1 ½"
	200K - 450K	20-45	2"

Square Feet of Radiation Per Section

Radiator Ratings

All dimensions and ratings are approximate.

Radiator output ratings should be used for checking the total radiation on an existing heating plant.

Shown below are the relative sizes of radiator styles. All are 4 tube (column), 8 section radiators. Each rating is different.

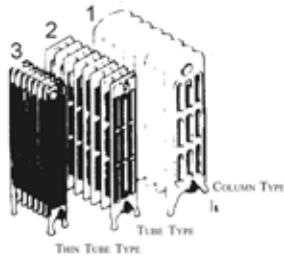

To identify the style of a radiator, count the number of tubes or columns. Then, check the width. When you have identified the style (1, 2, or 3) read the radiation per section beneath the radiator style.

Example: Radiator shown below is a 4-tube, 8-section, style 2 (tube type) radiator, 7" wide and 20" high. Multiplying the 2.2 square feet of radiation per section by 8 equals 17.6 square feet of radiation per radiator.

Radiator Enclosures

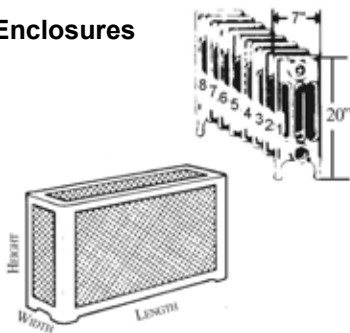

To determine the number of sections:

Divide length of cover in inches by 2, for example if length of cover is 24", then the radiator has 12 sections.



HEIGHT	SQUARE FT. RADIATION PER SECTION
37"	2 ½
28 ½"	1 ½
21 ½"	1 ½
15"	1
13 ¾"	¾

COLUMNS OR TUBES	1	2	3	4	5	6	7
OLD STYLE COLUMN RADIATORS WIDTH							
HEIGHT	4 ½"	7 ¾"	9"	11 ½"	12 ½"	12 ½"	
45"	3.5	5.0	6.0	10.0			
38"	3.0	4.0	5	8.0	10.0		
32"	2.5	3.3	4.5	6.5	8.5		
26"	2.0	2.6	3.7	5.0	7.0	7.0	
23"	1.6	2.3	3.2	4.5			
22"	1.6	2.2	3.0	4.0	6.0	6.0	
20"	1.5	2.0	2.7	3.5	5.0	5.0	
18"	1.3	1.7	2.2	3.0	5.0	4.3	
17"						4.0	
16"					4.0	3.7	
15"		1.5					
14"					4.0	3.0	
13"					3.0	3.0	
TUBE TYPE							
WIDTH HEIGHT			5"	7"	8 ¼"	9 ¼"	12 ½"
38"			3.5	4.2	5.0	6.0	
36"			3.5	4.2	5.0	6.0	7.0
32"			3.0	3.5	4.3	5.0	6.0
26"			2.3	2.7	3.5	4.3	5.0
23"			2.0	2.5	3.0	3.5	4.5
22"							4.5
20"			1.7	2.2	2.6	3.0	3.6
18"							3.5
17"							3.0
16"							3.0
14"							2.5
THIN TUBE							
WIDTH HEIGHT		3 ½"	4"	4 ¼"	6"	7 ¾"	
38"		2.5	2.8				
32"		2.0	2.6				
26"			2.4	2.4	3.0	3.4	
25"		1.5	1.8	2.1	2.4	3.0	
23"			1.7	2.0	2.3		
22"		1.3	1.6	1.8	2.2		
20"			1.5	1.7	2.1	2.3	
19"		1.1	1.4	1.6		2.3	

Coverison Factors

One sq. ft. of steam radiation = 240 Net BTHh

One sq. ft. of forced hot water = 185 Net BTUf at 190°F



Replacement Boiler Sizing Chart

Type of system Steam Forced hot water Gravity hot water

Type of fuel Natural Gas Oil

Output (Heating capacity) _____ **BTUh**

STANDING RADIATION				BASEBOARD RADIATION
ROOM	SQUARE FT. X PER SECTION (SEE PREVIOUS PAGE)	NUMBER OF = SECTIONS	RADIATION IN SQUARE FEET	LINEAL FEET (LENGTH OF FINNED TUBE ONLY)
TOTAL SQUARE FEET OF RADIATION _____			TOTAL LINEAL FEET _____	
X COVERSION FACTOR (SEE BELOW) _____			X 600 BTU/FT. _____	
TOTAL BTUh LOAD _____			_____	

Input _____ **Heating capacity** _____
(Should be equal to or slightly greater than load.)

Conversion Factors
 One sq. ft. of steam radiation = 240 Net BTHh
 One sq. ft. of forced hot water = 185 Net BTUf at 190°F

Hydronic Formulas

ZONING MADE EASY RULES OF THUMB

FLOW RATE

$$\frac{\text{NET BTUh LOAD}}{10,000} = \text{FLOW RATE}$$

MAXIMUM FLOW RATE

Pipe size (Copper) 1/2"	Maximum Flow Rate
3/4"	1 1/2 gpm
1"	4 gpm
1 1/4"	8 gpm
	14 gpm

MAXIMUM FLOW RATE & HEAT CARRYING CAPACITY

Pipe size (Copper)	Maximum Flow Rate	Heat Carrying Capacity
1/2"	1 1/2 gpm	15,000 BTUh
3/4"	4 gpm	40,000 BTUh
1"	8 gpm	80,000 BTUh
1 1/4"	14 gpm	140,000 BTUh

(Based on 20°F temperature drop across the system.)

MAXIMUM LENGTH OF FIN-TUBE BASEBOARD LOOP

Baseboard Size (Copper)	Typical BTUh per Linear Foot	Maximum Length of Baseboard Loop
1/2"	600	25'
3/4"	600	67'
1"	770	104'
1 1/4"	790	107'

(Based on 180°F average water temperature and a 20°F temperature drop across the system.)

MAXIMUM LENGTH OF FIN-TUBE BASEBOARD LOOP

1. Measure the longest run in feet.
2. Add 50% to this.
3. Multiply that by .04 ... and that's the pump head!



Formulas

Formulas - Electrical

$$\text{Amps} \times \text{Ohms} = \frac{\text{VOLTS} = \frac{\text{Watts}}{\text{Amps}}}{\sqrt{\text{Watts} \times \text{Ohms}}}$$

$$\frac{\text{Volts}}{\text{Ohms}} = \frac{\text{AMPS} = \frac{\text{Watts}}{\text{Volts}}}{\sqrt{\frac{\text{Watts}}{\text{Ohms}}}}$$

$$\text{Volts} \times \text{Amps} = \text{WATTS} = \frac{\text{Amps}^2 \times \text{Ohms}}{\frac{\text{Volts}^2}{\text{Ohms}}}$$

$$\frac{\text{Volts}}{\text{Amps}} = \text{OHMS} = \frac{\frac{\text{Volts}^2}{\text{Watts}}}{\frac{\text{Watts}}{\text{Amps}^2}}$$

$$\text{Power Factor} = \frac{\text{KW}}{\text{KVA}} = \text{Cos } \Theta$$

Single Phase

$$\text{KW} = \frac{\sqrt{3} \times \text{A} \times \text{PF}}{1000}$$

$$\text{KVA} = \frac{\text{V} \times \text{A}}{1000}$$

$$\text{AMPS} = \frac{\text{KVA} \times 1000}{\text{V}}$$

Three Phase

$$\text{KW} = \frac{\sqrt{3} \times \text{V} \times \text{A} \times \text{PF}}{1000}$$

$$\text{KVA} = \frac{\sqrt{3} \times \text{V} \times \text{A}}{1000}$$

$$\text{AMPS} = \frac{\text{KVA} \times 1000}{\sqrt{3} \times \text{V}}$$

$$\sqrt{3} = 1.73$$

Approx. Motor KVA = Motor Horsepower (At Full Load)

Capacitors Connected In Parallel $C_1 + C_2 + C_3 = C \text{ Total}$

Capacitors Connected In Series

For Two

$$\frac{C_1 \times C_2}{C_1 + C_2} = C \text{ Total}$$

More Than Two

$$\frac{1}{\frac{1}{C_1} + \frac{1}{C_2} + \frac{1}{C_3}} = C \text{ Total}$$

VOLTAGE UNBALANCE

$$\% \text{ Voltage Unbalance} =$$

$$\frac{100 \times \text{Max. Voltage Deviation From Average Voltage}}{\text{Average Voltage}}$$

BOOST TRANS.:

$$\text{Rating Plate F.L.A.} \times \text{Rating Plate VOLTS} = \text{KVA}$$

$$\frac{\text{Rating Plate VOLTS}}{\text{Rating Plate VOLTS} - \text{Norm. Line VOLTS}} = \text{FACTOR}$$

$$\frac{\text{KVA}}{\text{FACTOR}} = \text{Trans. KVA Rating}$$

$$\left(\frac{V_2}{V_1}\right)^2 \times \text{Heater Rating} = \text{Rating @ New Voltage}$$

$$V_1 \text{ Rated Volts } \quad V_2 = \text{Measured Volts}$$

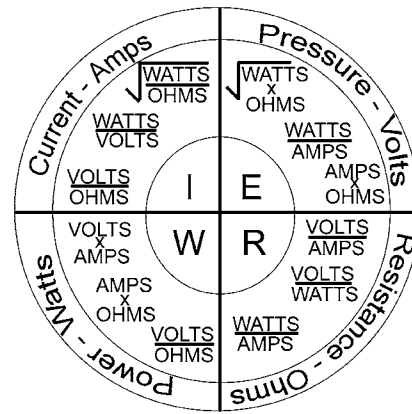

This chart shows four ways to figure each value: Amps (I), Volts (E), Ohms (R) or Watts (W).

Example: A 4800 Watt electric heat element is connected to a 240 Volt circuit. How many Amps does it draw?

Solution: Locate Amps section of chart: $\frac{\text{Watts (W)}}{\text{Volts (E)}} = \text{Amps (I)}$

Thus $4800 \div 240 = 20$ Amps. Carried further, what is the resistance?

$$\frac{\text{Volts}^2 \text{ E}^2}{\text{Watts (W)}} = \text{Ohms (R)} \quad 240 \times 240 \div 4800 = 12 \text{ Ohms.}$$

Conversion Table For
Watts - Amperes - Volts

Watts	Voltage (C - Single Phase)			
	120	208	240	277
	Amperes			
500	4.2	2.4	2.1	1.8
1000	8.3	4.8	4.2	3.8
1500	12.5	7.2	6.3	5.4
2000	16.7	9.6	8.3	7.2
2500	20.9	12.0	10.4	9.0
3000	25.0	14.4	12.5	10.6
3500	29.2	16.8	14.5	12.6

Airflow Versus Temperature Rise

Airflow Versus Temperature Rise

HEAT OUTPUT		AIRFLOW - CUBIC FEET PER MINUTE																															
KW	BTU	400	500	600	700	800	900	1000	1100	1200	1300	1400	1500	1600	1700	1800	1900	2000	2100	2200	2300	2400	2500	2600	2700	2800	2900	3000	3100	3200	3300		
		TEMPERATURE RISE - DEGREES FAHRENHEIT																															
3	10242	24	19	16	14	12																											
4	13658	32	25	21	18	16	14	13																									
5	17070	39	32	26	23	20	18	16	14	13																							
6	20484	47	38	32	27	24	21	19	17	16	15	14																					
7	23898	55	44	37	32	28	25	22	20	18	17	16	15	14																			
8	27312	63	51	42	36	32	28	25	23	21	19	18	17	16	15	14																	
9	30726	71	57	47	41	36	32	28	26	24	22	20	19	18	17	16	15	14															
10	34140	79	63	53	45	39	35	32	29	26	24	22	21	20	19	18	17	16	15	14													
11	37554	87	69	58	50	43	39	35	32	29	27	25	23	22	20	19	18	17	16	15	14	13											
12	40968	95	76	63	54	47	42	38	34	32	29	27	25	24	22	21	20	19	18	17	16	15	14										
13	44382		82	68	58	51	46	41	37	34	32	29	27	26	24	23	22	21	20	19	18	17	16	15									
14	47796		89	74	63	55	49	44	40	37	34	32	30	28	26	25	23	22	21	20	19	18	17	16	15								
15	51210		95	79	68	59	53	47	43	39	36	34	32	30	28	26	25	24	23	22	21	20	19	18	17	16							
16	54624			84	72	64	56	50	46	42	38	36	34	32	30	28	27	25	24	23	22	21	20	19	18	17	16						
17	58038			89	77	67	60	54	49	45	41	38	36	34	32	30	28	27	26	24	23	22	21	20	19	18	17	16					
18	61452			95	82	72	64	56	52	48	44	40	38	36	34	32	30	28	27	26	25	24	23	22	20	19	18	17	16				
19	64866				86	75	67	60	55	50	46	42	40	38	36	34	32	30	29	27	26	25	24	23	22	21	20	19	18	17			
20	68280				90	79	70	63	57	53	49	45	42	40	37	35	33	32	30	29	27	26	25	24	23	22	21	20	19	18	17		
21	71694				95	83	74	66	60	55	51	47	44	41	39	37	35	33	32	30	29	28	27	26	25	24	23	22	21	20	19	18	
22	75108				99	87	77	69	63	58	53	50	46	43	41	39	37	35	33	32	30	29	28	27	26	25	24	23	22	21	20	19	
23	78522					91	81	73	66	61	56	52	48	45	43	40	38	36	35	33	32	30	29	28	27	26	25	24	23	22	21	20	
24	81936					95	84	76	69	63	58	54	51	47	45	42	40	38	36	34	33	32	30	29	28	27	26	25	24	23	22	21	
25	85350					99	88	79	72	66	61	56	53	49	46	44	42	40	38	36	34	33	32	30	29	28	27	26	25	24	23	22	
26	88764						91	82	75	68	63	59	55	51	48	46	43	41	39	37	36	34	33	32	30	29	28	27	26	25	24	23	
27	92178						95	85	78	71	66	61	57	53	50	47	45	43	41	39	37	36	34	33	32	30	29	28	27	26	25	24	
28	95592						98	88	80	74	68	63	59	55	52	49	47	44	42	40	38	37	35	34	33	32	31	30	29	28	27	26	
29	99006							92	83	76	71	65	61	57	54	51	48	46	44	42	40	38	37	35	34	33	32	31	30	29	28	27	
30	102420							95	86	79	73	68	63	59	56	53	50	47	45	43	41	40	38	36	35	34	33	32	31	30	29	28	

Capacity of Gas Piping Cu. Ft. Per Hour

(At pressure drop of 0.3 in. water. Specific gravity - 0.60.)

Pipe Lgth. Ft.	Iron Pipe Size (IPS) Inches									
	1/2	3/4	1	1-1/4	1-1/2	2	2-1/2	3	4	
10	132	278	520	1050	1600	3050	4800	8500	17,500	
20	92	190	350	730	1100	2100	3300	5900	12,000	
30	73	152	285	590	890	1650	2700	4700	9700	
40	63	130	245	500	760	1450	2300	4100	8300	
50	56	115	215	440	670	1270	2000	3600	7400	
60	50	105	195	400	610	1150	1850	3250	6800	
70	46	96	180	370	560	1050	1700	3000	6200	
80	43	90	170	350	530	990	1600	2800	5800	
90	40	84	160	320	490	930	1500	2600	5400	
100	38	79	150	305	460	870	1400	2500	5100	
125	34	72	130	275	410	780	1250	2200	4500	
150	31	64	120	250	380	710	1130	2000	4100	
175	28	59	110	225	350	650	1050	1850	3800	
200	26	55	100	210	320	610	980	1700	3500	

Models and Specifications are Subject to Change Without Notice



Drill Sizes & Decimal Equivalents

Drill Sizes

Drill number or Letter*	Decimal Equiv.	Drill number or Letter*	Decimal Equiv.	Drill number or Letter*	Decimal Equiv.
80	0.0135	40	0.098	T	0.228
79	0.0415	39	0.0995	A	0.234
1/64	0.0156	38	0.1015	15/64	0.2344
78	0.016	37	0.104	B	0.238
77	0.018	36	0.1065	C	0.242
76	0.020	7/64	0.1094	C	0.242
75	0.021	35	0.110	D	0.246
74	0.0225	34	0.111	E & 1/4	0.250
73	0.024	33	0.113	F	0.257
72	0.025	32	0.116	G	0.261
71	0.026	31	0.120	17/64	0.2656
70	0.028	1/8	0.1250	H	0.266
69	0.0292	30	0.1285	I	0.272
68	0.031	29	0.136	J	0.277
1/32	0.0312	28	0.1405	K	0.281
67	0.032	9/64	0.1406	9/32	0.2812
66	0.033	27	0.144	L	0.290
65	0.035	26	0.147	M	0.295
64	0.036	25	0.1495	19/64	0.2969
63	0.037	24	0.152	N	0.302
62	0.038	23	0.154	5/16	0.3125
61	0.039	5/32	0.1562	O	0.316
60	0.040	22	0.157	P	0.323
59	0.041	21	0.159	21/64	0.3281
58	0.042	20	0.161	Q	0.332
57	0.043	19	0.166	R	0.339
56	0.0465	18	0.1695	11/32	0.3437
3/64	0.0468	11/64	0.1719	S	0.348
55	0.052	17	0.173	T	0.358
54	0.055	16	0.177	23/64	0.3594
53	0.0595	15	0.180	U	0.368
1/16	0.0625	14	0.182	3/8	0.375
52	0.0635	13	0.185	V	0.377
51	0.067	3/16	0.1875	W	0.386
50	0.070	12	0.189	25/64	0.3906
49	0.073	11	0.191	X	0.397
48	0.075	9	0.196	Y	0.404
5/64	0.0781	8	0.199	13/32	0.4062
47	0.0785	7	0.201	Z	0.413
46	0.081	13/64	0.2031	27/64	0.4219
45	0.082	6	0.204	7/16	0.4375
44	0.086	5	0.2055	29/64	0.4531
43	0.089	4	0.209	15/32	0.4687
42	0.0935	3	0.213	31/64	0.4844
3/32	0.0937	7/32	0.2187	1/2	0.5000
41	0.095	2	0.221		

NOTE: The shank of a numbered drill makes a good gauge to determine the inside diameter of capillary tubing or to measure gas burner orifices.

Decimal and Metric Equivalents

Equivalents of Common Fractions of An Inch

64ths	32nds	16ths	8ths	Decimal	Mm	—	64ths	32nds	16ths	8ths	Decimal	Mm
1/64				0.01562	0.397		33/64				0.51562	13.097
3/64	1/32			0.03125	0.794		35/64	17/32			0.53125	13.494
		1/16		0.04688	1.191				9/16		0.54688	13.891
				0.06250	1.588						0.56250	14.288
5/64				0.07812	1.984		37/64				0.57812	14.684
7/64	3/32			0.09375	2.381		39/64	19/32			0.59375	15.081
			1/8	0.10938	2.778					5/8	0.60938	15.478
				0.12500	3.175						0.62500	15.875
9/64				0.14062	3.572		41/64				0.64062	16.272
11/64	5/32			0.15625	3.969		43/64	21/32			0.65625	16.669
		3/16		0.17188	4.366				11/16		0.67188	17.066
				0.18750	4.763						0.68750	17.463
13/64				0.20312	5.159		45/64				0.70312	17.859
15/64	7/32			0.21875	5.556		47/64	23/32			0.71875	18.256
			1/4	0.23438	5.953					3/4	0.73438	18.653
				0.25000	6.350						0.75000	19.050
17/64				0.26562	6.747		49/64				0.76562	19.447
19/64	9/32			0.28125	7.144		51/64	25/32			0.78125	19.844
		5/16		0.29688	7.541					13/16	0.79688	20.241
				0.31250	7.938						0.81250	20.638
21/64				0.32812	8.334		53/64				0.82812	21.034
23/64	11/32			0.34375	8.731		55/64	27/32			0.83475	21.431
			3/8	0.35938	9.128					7/8	0.85938	21.828
				0.37500	9.525						0.87500	22.225
25/64				0.39062	9.922		57/64				0.89062	22.622
27/64	13/32			0.40625	10.319		59/64	29/32			0.90625	23.019
		7/16		0.42188	10.716					15/16	0.92188	23.416
				0.43750	11.113						0.93750	23.813
29/64				0.45312	11.509		61/64				0.95312	24.209
31/64	15/32			0.46875	11.906		63/64	31/32			0.96875	24.606
				0.48438	12.303						0.98438	25.003
			1/2	0.50000	12.700						1.00000	25.400

Duct Sizing Guide

Residential Duct Sizing Guide

The following duct sizes are based on a friction drop of .10 inches per 100 feet of lineal duct. This "Equal-Friction" method of duct sizing should be adequate for normal residential furnace heating and air conditioning applications. Larger air volumes or higher static pressures should be dealt with on an individual job basis.

Rectangular and Round Duct

Air Volume CFM	Duct Height Inches					Equivalent Round Duct'	Air Volume CFM
	4"	6"	8"	10"	12"		
50	6 x 4					5	50
75	6 x 4					6	75
100	8 x 4	6 x 6				6	100
125	10 x 4	6 x 6				7	125
150	10 x 4	8 x 6				7	150
175	12 x 4	8 x 6				8	175
200	14 x 4	8 x 6				8	200
225	16 x 4	10 x 6				8	220
250	16 x 4	10 x 6				9	250
275		12 x 6	8 x 8			9	275
300		12 x 6	8 x 8			9	300
400		14 x 6	10 x 8			10	400
500		18 x 6	12 x 8	10 x 10		11	500
600		20 x 6	14 x 8	12 x 10		12	600
700		24 x 6	16 x 8	12 x 10		12	700
800		26 x 6	18 x 8	14 x 10	12 x 12	13	800
900		30 x 6	20 x 8	16 x 10	12 x 12	14	900
1000			22 x 8	16 x 10	14 x 12	14	1000
1100			24 x 8	18 x 10	16 x 12	15	1100
1200			26 x 8	20 x 10	16 x 12	15	1200
1300			28 x 8	20 x 10	18 x 12	16	1300
1400			30 x 8	22 x 10	18 x 12	16	1400
1500				24 x 10	20 x 12	16	1500
1600				24 x 10	20 x 12	17	1600
1700				26 x 10	22 x 12	17	1700
1800				28 x 10	22 x 12	18	1800
1900				30 x 10	22 x 12	18	1900
2000					24 x 12	18	2000

Suggested Air Changes

Type of Building	Minute Air Change
Assembly halls	3 - 10
Auditoriums	4 - 15
Bakeries	1 - 3
Banks	3 - 10
Bars	2 - 4
Beauty parlors	2 - 5
Boiler rooms	2 - 4
Bowling alleys	2 - 8
Churches	4 - 15
Corridors	6 - 20
Dry cleaners	1 - 5
Engine rooms	1 - 15
Factor (gen. vent.)	5 - 10
Factory (fumes)	1 - 5
Forge shops	1 - 2
Foundries	1 - 4
Garages (repairs)	2 - 10
Generating rooms	2 - 5
Glass plants	1 - 2
Gymnasiums	2 - 10
Heat treat rooms	0.5 - 1
Kitchens	1 - 3
Laundries	2 - 5
Locker rooms	2 - 5
Machine shops	3 - 5
Mills (paper)	2 - 3
Mills (textile)	5 - 15
Offices	2 - 8
Packing houses	2 - 5
Production rooms	1 - 2
Projection rooms	1 - 3
Recreation rooms	2 - 8
Residences	2 - 5
Restaurants	5 - 10
Retail stores	3 - 10
Sales rooms	3 - 10
Shops (gen. vent.)	3 - 10
Stores	5 - 10
Theaters	3 - 8
Toilets	2 - 5
Transformer rooms	1 - 5
Turbine room elec.	2 - 6
Waiting rooms	10
Warehouses	2 - 10

In selecting the size and capacity of a fan, find the total cubic feet of air space of the building and divide by the number of air changes necessary to give proper ventilation.

$$CFM = \frac{\text{Building volume in cubic feet}}{\text{Minute air change}}$$

Example:

A building 100' long x 60' wide with a 20' ceiling: Multiply 100 x 60 x 20 = 120,000 cubic feet. Assuming a 6 minute air change is required: 120,000 cubic feet of air divided by 6 gives you 20,000 CFM required to change the air every 6 minutes.



Conversions

Conversion Factors

MULTIPLY	BY	OBTAIN
Atmospheres (Std.) 760 MM of Mercury at 32°F	14.696	lbs./sq. in.
Atmospheres	76.0	cms mercury
atm	29.92	ins mercury
atm	33.90	ft. water
atm	1.0333	kgs/sq. cm.
atm	14.70	lbs./sq. in.
atm	1.058	tons/sq. ft.
Barrels-Oil	42	gals-oil
BT Units	0.2520	kgs-calories
BTUs	777.5	ft.-lbs.
BTUs	0.000393	hp-hrs
BTUs	107.5	kg-meters
BTUs	0.293	w-hrs
BTU/Min.	12.96	ft.-lbs./sec.
BTU/min	0.2356	hp
BTU/min	0.01757	kw
BTU/min	17.57	watts
Calorie	0.003968	BTU
Centimeters	0.3937	inches
cm	0.0328	feet
cm	0.01	meters
cm	10	mm
Cms Mercury	0.01316	atm
cms mercury	0.4461	ft. water
cms mercury	136.0	kgs/sq. meter
cms mercury	27.85	lbs./sq. ft.
cms mercury	0.1934	lbs./sq. in.
Cms/Second	1.969	ft./min.
cms/second	0.03281	ft. sec.
cms/second	0.036	km/hr.
cms/second	0.6	meters/min.
cms/second	0.02237	miles/hr.
cms/second	0.0003728	miles/min.
Cms/Sec/Sec	0.03281	ft./sec./sec.
Cubic Cms	0.00003531	cu. ft.
cu cms	0.06102	cu. in.
cu cms	0.000001	cu meters
cu cms	0.00001308	cu. yds.
cu cms	0.0002642	gals
cu cms	0.001	liters
cu cms	0.002113	pints (liq.)
cu cms	0.001057	quarts (liq.)
Cubic Feet	28320	cubic cms
cu. ft.	1728	cu. inches
cu. ft.	0.02832	cu. meters
cu. ft.	0.03704	cu. yds.
cu. ft.	7.48052	gals
cu. ft.	28.32	liters
cu. ft.	59.84	pints (liq.)
cu. ft.	29.92	quarts (liq.)
Cubic Ft./Min.	472.0	cu. cms/sec.
cu. ft./min.	0.1247	gals/sec.
cu. ft./min.	0.4720	liters/sec
cu. ft./min.	62.43	lbs. w/min.

MULTIPLY	BY	OBTAIN
Cubic Ft./Sec.	0.646317	million gals/day
cu. ft./sec.	448.831	gals./min.
Cubic Ft. Water	62.4	lbs. @ 60°F
Cubic Inches	16.39	cc
cu. ins.	0.0005787	cu. ft.
cu ins.	0.00001639	cu. meters
cu. ins.	0.00002143	cu. yds.
cu. ins.	0.004329	gals
cu. ins.	0.01639	liters
cu. ins.	0.03463	pints (liq.)
cu. ins.	0.01732	quarts (liq.)
Cubic Meters	100,000	cc
cu. meters	35.31	cu. ft.
cu. meters	61.023	cu. ins.
cu. meters	1.308	cu. yds.
cu. meters	264.2	gals
cu. meters	1000	liters
cu. meters	2113	pints (liq.)
cu. meters	1057	quarts (liq.)
Cubic Yards	764,600	cu. cms
cu. yds	27	cu. ft.
cu. yds	46.656	cu. ins.
cu. yds	0.7646	cu. meters
cu. yds	202.0	gals
cu. yds	764.6	liters
cu. yds	1616	pints (liq.)
cu. yds.	807.9	quarts (liq.)
Decimeters	0.1	meters
Degrees (Angle)	60	minutes
degs (angle)	0.01745	radians
degs (angle)	3600	secs
Degrees/Sec.	0.01745	radians/sec.
degs/sec.	0.1667	revs/min.
degs/sec.	0.002778	revs/sec.
Fathoms	6	ft.
Feet	30.48	cms
ft.	12	ins
ft.	0.3048	meters
ft.	1/3	yds
Feet of Water	0.02950	atms
ft. of w	0.8876	ins mercury
ft. of w	0.03048	kgs/sq. cm
ft. of w	62.43	lbs./sq. ft.
ft. of w	0.4335	lbs./sq. in.
Feet/Min.	0.5080	cms/sec
ft./min.	0.01667	ft./sec.
ft./min.	0.01829	kms/hrs
ft./min	0.3040	meters/min.
ft./min.	0.01136	miles/hr.
Ft./Sec./Sec.	30.48	cms/sec./sec.
ft./sec./sec.	0.3048	ms/sec./sec.
Foot-Pounds	0.001286	BTUs
ft.-lbs.	0.000000505	hp-hrs
ft.-lbs.	0.0003241	kg-calories
ft.-lbs.	0.1383	kg-meters
ft.-lbs.	0.0000003766	kw-hrs

Conversions

MULTIPLY	BY	OBTAIN
Ft.-Lbs./Min.	0.001286	BTUs/min.
ft.-lbs./min.	0.01667	ft.-lbs./sec.
ft.-lbs./min.	0.0000303	hp
ft.-lbs./min.	0.0003241	kg-calories/min.
ft.-lbs./min.	0.0000226	kws
Ft.-Lbs./Sec.	0.007717	BTUs/min
ft.-lbs./sec.	0.001818	hp
ft.-lbs./sec.	0.01945	kg-calories/min.
ft.-lbs./sec.	0.001356	kws
Gallons	3785	ccs
gals	0.1337	cu. ft.
gals	231	cu. ins
gals	128	fl. ozs.
gals	0.003784	cu. meters
gals	3.785	liters
gals	8	pints (liq.)
gals	4	quarts (liq.)
Gallons, Imp	1.20095	US gals
Gallons, US	0.83267	Imp gals
Gallons Water	8.3453	lbs. water
Gallons/Min.	0.002228	cu. ft./sec.
gals/min.	0.06308	liter/sec.
gals/min.	8.0208	cu. ft./hr.
Gals Water/Min.	6.0086	tons water/24 hrs
Grams	15.432	grains
grams	.001	kgs
grams	1000	milligrams
grams	0.03527	ozs
grams	0.03215	ozs (troy)
grams	0.002205	lbs.
Grams/Cm	0.0056	lbs./in.
Grams/Cu. Cm	62.43	lbs./cu. ft.
grams/cu. cm	0.03613	lbs./cu. in.
Grams/Liter	58.417	grains/gal
grams/liter	8.345	lbs./1000 gals
grams/liter	0.062427	lbs./cu. ft.
grams/liter	1000	parts/million
Horsepower	42.44	BTUs/min.
hp	33.000	ft.-lbs./min.
hp	550	ft.-lbs./sec.
hp	1.014	hp (metric)
hp	10.70	kg-calories/min.
hp	0.7457	kws
hp	745.7	watts
Horsepower (boiler)	33,479	BTU/hr.
hp (boiler)	9,803	kws
HP-Hours	2547	BTUs
hp-hrs	1,980,000	ft.-lbs.
hp-hrs	641.7	kg-calories
hp-hrs	273,700	kg-meters
hp-hrs	0.7457	kw-hrs
Inches	2540	cms
ins	25.4	mm
ins	0.0254	M
ins	0.0833	ft.
Inches of Mercury	0.03342	atms

MULTIPLY	BY	OBTAIN
ins mercury	1.133	ft. water
ins mercury	13.57	in. water
ins mercury	0.03453	kgs/sq. cm
ins mercury	70.73	lbs./sq. ft.
ins mercury	0.4912	lbs./sq. in.
Inches of Water	0.002458	atms
ins of w	0.07355	ins mercury
ins of w	0.002540	kgs/sq. cm
ins of w	0.5781	ozs/sq. in.
ins of w	5.202	lbs./sq. ft.
ins of w	0.03613	lbs./sq. in.
Kilograms	980.665	dynes
kgs	2.205	lbs.
kgs	0.001102	tons (short)
kgs	1000	grams
Kgs/Sq. Cm	0.9678	atms
kgs/sq. cm	32.81	ft. water
kgs/sq. cm	28.96	ins mercury
kgs/sq. cm	20.48	lbs./sq. ft.
kgs/sq. cm	14.22	lbs./sq. ft.
Kiloliters	1000	liters
Kilometers	100,000	cms
kms	3281	ft.
kms	1000	meters
kms	0.6214	miles
Kms/Hr.	27.78	cms/sec.
kms/hr.	54.68	ft./min.
kms/hr.	0.9113	ft./sec.
kms/hr.	16.67	meters/min.
kms/hr.	0.6214	miles/hr.
Kms/Hr. Sec.	27.78	cms/sec./sec.
kms/hr. sec.	0.9113	ft./sec./sec.
kms/hr. sec.	0.2778	meters/sec./sec.
Kilowatts	56.92	BTUs/min
kws	44,250	ft.-lbs./min.
kws	737.6	ft.-lbs./sec.
kws	1.341	hp
kws	14.34	kg-calories/min.
kws	1000	watts
Kilowatt-Hrs.	3415	BTUs
kw-hrs.	2,665,500	ft.-lbs.
kw-hrs.	1.341	hp-hours
kw-hrs.	860.5	kg-calories
kw-hrs.	367,100	kg-meters
Liters	100	ccs
liters	0.03531	cu. ft.
liters	61.02	cu. ins
liters	0.01	cu. meters
liters	0.2642	gals
liters	2.113	pints (liq.)
liters	1.057	quarts (liq.)
Liters/Min.	0.004403	gals/sec.
Meters	100	cms
meters	3.281	ft.
meters	39.37	ins
meters	0.001	kms

Conversions

MULTIPLY	BY	OBTAIN
meters	1000	mms
meters	1.094	yards
Meters/Min.	1.667	cms/sec.
meters/min.	3.281	ft./min.
meters/min.	0.05468	ft./sec.
meters/min.	0.06	kms/hr.
meters/min.	0.03728	miles/hr.
Meters/Sec.	196.8	ft./min.
meters/sec.	3.281	ft./sec.
meters/sec.	3.6	kms/hr.
meters/sec.	0.06	kms/min.
meters/sec.	2.237	miles/hr.
meters/sec.	0.03728	miles/min.
Microns	0.000001	meters
microns	25.400	in.
Miles/Hr.	44.70	cms/sec.
miles/hr.	88	ft./min.
miles/hr.	1.467	ft./sec.
miles/hr.	1.609	kms/hr.
miles/hr.	0.8684	knots
miles/hr.	26.82	meters/min.
Millimeters	0.1	cms
mms	0.03937	ins
Mins (Angle)	0.0002909	radians
Ounces	16	drams
ozs	437.5	grains
ozs	0.0625	lbs.
ozs	28.349527	grams
ozs	0.9115	ozs (troy)
ozs	0.0000279	tons (long)
ozs	0.00002835	tons (metric)
Ounces (Fluid)	1.805	cu. in.
ozs (fluid)	0.02957	liters
Pints	0.4732	liters
Pounds	16	ozs
lbs	256	drams
lbs	7000	grains
lbs	0.0005	tons (short)
lbs	453.5924	grams
lbs	1.21528	lbs. (troy)
lbs	14.5833	ozs (troy)
Lbs. of Water	0.01602	cu. ft.
lbs. of water	27.68	cu. in.
lbs. of water	0.1198	gals
Lbs. of Water/Min.	0.0002679	cu. ft./sec.
Pounds/Cu. Ft.	0.0005787	lbs./cu. in.
Pounds/Cu. In.	1728	lbs./cu. ft.
Pounds/Sq. Ft.	0.01602	ft. of water
Pounds/Sq. Ft.	0.006945	lbs./sq. in.
Pounds/Sq. In.	0.06804	atms
lbs./sq. in.	2.307	ft. water
lbs./sq. in.	2.036	in. mercury
lbs./sq. in.	27.68	in. water
lbs./sq. in.	0.07031	kgs/sq. cm
Radians	57.29578	degrees
Temp. (°C) +273	1	abs. temp. (°C)

MULTIPLY	BY	OBTAIN
Temp. (°C) +17.78	1.8	temp. (°F)
Temp. (°F) +460	1	abs. temp. (°F)
Temp. (°F) -32	5/9	temp. (°C)
Therm	100,000	BTUs
Tons (Long)	1016	kgs
tons (long)	2240	lbs
tons (long)	1.12000	tons (short)
Tons, Refrigeration	12,000	BTU/hr.
Tons (Short)	2000	lbs.
tons (short)	907.18486	kgs
tons (short)	2430.56	lbs. (troy)
tons (short)	0.89287	tons (long)
tons (short)	29,166.66	ozs (troy)
tons (short)	0.90718	tons (metric)
Watts	0.05692	BTUs/min.
watts	44.26	ft.-lbs./min.
watts	0.7376	ft.-lbs./sec.
watts	0.001341	hp
watts	0.01434	kg-calories/min.
watts	0.001	kws
Watt-Hours	3.415	BTU/hr.
watt-hrs.	2655	ft.-lbs.
watt-hrs.	0.001341	hp-hrs
watt-hrs.	0.8605	kg-calories
watt-hrs.	367.1	kg-meters
watt-hrs.	0.001	kw-hrs

Five Basic Laws of Nature

Law 1: Heat exists in the air at all temperatures – below freezing as well as above – all the way down to absolute zero (-460° F).

Law 2: Heat flows from a higher temperature to a lower temperature regardless of how small the temperature difference might be.

Law 3: All gases become warmer when compressed.

Law 4: Most matter can be in a solid (ice), liquid (water) or gaseous (steam) state.

Law 5: The temperature at which a material changes from a liquid to a gas (evaporates or boils) or from a gas to a liquid (condenses or liquefies) depends on the pressure at which it is contained.

Terminology

DEFINITIONS OF TERMS Refrigeration and Air Conditioning

ABSOLUTE HUMIDITY: The weight of water vapor in a given amount of air. Grains per cubic foot.

ABSOLUTE PRESSURE: Pressure measured with a base of zero.

ABSOLUTE TEMPERATURE: A temperature scale expressed in degrees, F or C, using absolute zero as a base. Referred to as the Rankin or Kelvin scale.

ABSOLUTE ZERO: The temperature at which molecular activity theoretically ceases (-459.69°F or -273.16°C)

AFUE %: AFUE stands for "annual fuel utilization efficiency". This rating is based on average usage, including on and off cycling, as set out in the standardized Department of Energy test procedures.

AIR CONDITIONING: The process of controlling the temperature, humidity, cleanliness and distribution of the air.

AIR STANDARD CONDITIONS: Conditioning at which BTU ratings for summer air conditioning equipment is rated. 95°F dry bulb, 75°F wet bulb at the condenser inlet and 80°F dry bulb, 67°F wet bulb at the evaporator inlet.

AIR: Atmospheric air is composed of approximately 78% Nitrogen, 21% Oxygen and 1% rare gases including Carbon Dioxide, Krypton, Neon, Argon, Ozone, Helium and Ammonia. Over the sea, traces of salt are present, and over the land, traces of sulfates. Dust and micro-organisms are also present.

ATMOSPHERIC PRESSURE: The weight of 1 square inch column of the earth's atmosphere. At sea level this pressure is 14.696 pounds per square inch.

BIMETAL: Two metals with different rates of expansion fastened together. When heated or cooled they will warp and can be made to open or close a switch or valve.

BOILING POINT: The temperature at which the addition of any heat will begin a change of state from a liquid to a vapor.

BRITISH THERMAL UNIT (BTU): The amount of heat necessary to raise the temperature of 1 pound of pure water (about 1 pint) by 1° Fahrenheit.

CAPILLARY TUBE: A refrigerant control consisting of a small diameter tube which controls flow by restriction. They are carefully sized by inside diameter and length for each particular application.

CENTIGRADE: A temperature scale with the freezing point of water 0° and the boiling point 100° at atmospheric pressure.

COEFFICIENT OF PERFORMANCE (COP): A ratio calculated by dividing the total heating capacity provided by the refrigeration system, including circulating fan heat but excluding supplementary resistance (BTUs per hour), by the total electric input (watts) x 3.412.

COMPRESSION: The reduction of volume of a vapor or gas by mechanical means.

COMPRESSOR: A mechanical device used to compress gases. Four main types are: Reciprocating; Centrifugal, Rotary and Scroll.

CONDENSATION POINT: The temperature at which removal of any heat will begin a change of state from a vapor to a liquid.

CONDENSER: A device in which the superheat and latent heat of condensation are removed to effect a change of state from a vapor to a liquid. Some sub-cooling is also usually accomplished.

CONDENSING MEDIUM: The substance, usually air or water, to which the heat in a condenser is transferred.

CONDENSING UNIT: The portion of a refrigeration system where the compression and condensation of refrigerant is accomplished. Sometimes referred to as the "high side".

CONDUCTION: The transfer of heat from molecule to molecule within a substance.

CONTACTOR: An electro-magnetic actuated relay. Usually used to refer to the relay which closes the circuit to a compressor.

CONVECTION: The transfer of heat by a moving fluid.

COOLING ANTICIPATOR: A resistance heater (usually not adjustable) in parallel with the cooling circuit. It is "on" when the circuit is "off" adding heating to shorten the off cycle.

CYCLE: The complete course of operation of a refrigerant back to a selected starting point in a system. Also used to describe alternating current through 360 space degrees.

DENSITY: Mass or weight per unit of volume, i.e.: Standard air .075 pounds per cubic foot.

DISCHARGE LINE: A tube used to convey the compressed refrigerant vapor from the compressor to the condenser inlet.

DISCHARGE PRESSURE: The pressure read at the compressor outlet. Also called head pressure or high pressure.

DOE: Department of Energy.

DRY BULB TEMPERATURE: Temperature read with an ordinary thermometer.

ENERGY EFFICIENT RATIO (EER): A ratio calculated by dividing the cooling capacity in BTUs per hour (BTUH) by the power input in watts or any given set of rating conditions, expressed in BTUH per watt (BTUH/watt).

EVAPORATIVE COOLING: The cooling effect of vaporization of a liquid in a moving air system.

EVAPORATOR SUPERHEAT: The actual temperature of the refrigerant vapor at the evaporator exit as compared to the saturated vapor temperature indicated by the suction pressure.

EVAPORATOR: A device in which a liquid refrigerant is vaporized. Some superheating usually takes place.

FAHRENHEIT: A temperature scale with freezing point of water 32° and the boiling point 212° at atmospheric pressure.

FREEZING POINT: The temperature at which the removal of any heat will begin a change of state from liquid to a solid.

GAUGE PRESSURE: Pressure measured with atmospheric pressure as a base.

Terminology

HEAT EXCHANGER: A device for the transfer of heat energy from the source to the conveying medium.

HEAT FLOW: Heat flows from a warmer to a cooler substance. The rate depends upon the temperature difference, the area exposed and the type of material.

HEAT OF COMPRESSION: The heat added to a vapor by the work done on it during compression.

HEAT OF THE LIQUID: The increase in total heat (Enthalpy) per pound of saturated liquid as its temperature is increased above a chosen base temperature. (Usually -40°F for refrigerants). It is expressed in BTUs.

HEAT TRANSFER: The three methods of heat transfer are conduction, convection and radiation.

HEAT: A form of energy causing the agitation of molecules within a substance.

HEATING SEASONAL PERFORMANCE FACTOR (HSPF): The total heating output of a heat pump during its normal annual usage period for heating divided by the total electric power input in watt-hours during the same period.

INCHES OF MERCURY: Atmospheric pressure is equal to 29.92 inches of mercury.

LATENT HEAT OF CONDENSATION: The amount of heat energy, in BTUs, that must be removed to change the state of 1 pound of a vapor to 1 pound of liquid at the same temperature.

LATENT HEAT OF FUSION: The amount of heat energy, in BTUs, required to change the state of 1 pound of a liquid to 1 pound of solid at the same temperature.

LATENT HEAT OF MELTING: The amount of heat energy, in BTUs, that must be removed to change the state of 1 pound of a solid to 1 pound of liquid at the same temperature.

LATENT HEAT OF VAPORIZATION: The amount of heat energy, in BTUs, required to change the state of 1 pound of liquid to 1 pound of vapor at the same temperature.

LATENT HEAT: Heat that produces a change of state without a change in temperature. i.e.: Ice to water at 32°F; Water to steam at 212°.

LIQUID LINE: A tube used to convey the liquid refrigerant from the condenser outlet to the refrigerant control device of the evaporator.

MANOMETER: A tube filled with liquid used to measure pressure.

MELTING POINT: The temperature at which the addition of any heat will begin a change of state from a solid to a liquid.

MERCURY MANOMETER: Used to measure vacuum in inches of mercury.

MICRON: A unit used to measure high vacuums. One micron equals 1/25,400 of 1 inch mercury.

PARTIAL PRESSURE: The pressure exerted by an individual gas in a mixture.

PRESSURE - TEMPERATURE RELATIONSHIP: The change effected in temperature when pressure is changed or visa versa. Only used at saturated conditions. An increase in pressure results in a temperature increase. A decrease in temperature results in a pressure decrease.

PRESSURE DROP: The decrease in pressure due to friction of a fluid or vapor as it passes through a tube or duct.

PSYCHROMETER: A device having both a dry and a wet bulb thermometer. It is used to determine the relative humidity in a conditioned space. Most have an indexed scale to allow direct conversion from the temperature readings to the percentage of relative humidity.

PSYCHROMETRIC CHART: A chart on which can be found the properties of air under varying conditions of temperature, water vapor content, volume, etc.

RADIATION: The transfer of heat without an intervening medium. It is absorbed on contact with a solid surface.

REFRIGERANT CONTROL: A device used to meter the amount of refrigerant to an evaporator. It also serves as a dividing point between the high and low pressure sides of the system.

REFRIGERANT: A substance which produces a refrigerating effect while expanding or vaporizing.

REFRIGERATION: The transfer of heat from a place where it is not wanted to a place where its presence is not undesirable.

RELATIVE HUMIDITY: The percentage of water vapor present in a given quantity of air compared to the amount it can hold at its temperature.

RELAY: A device used to open and close an electrical circuit. The relay may be actuated by a bimetal electrically heated strip, a rod wrapped with a fine resistance wire causing expansion when energized, a bellows actuated by expansion of a fluid or gas or an electromagnetic coil.

SATURATED VAPOR: Vapor in contact with a liquid.

SATURATION: A condition of stable equilibrium of a vapor and a liquid.

SEASONAL ENERGY EFFICIENCY RATIO (SEER): The total cooling of a central unitary air conditioner or unitary heat pump in BTUs during its normal annual period for cooling divided by the total electric energy input in watt-hours during the same period.

SENSIBLE HEAT: Heat that can be measured or felt. Sensible heat always causes a temperature rise.

SOUND RATING (SR): A tone corrected A-weighted sound power level expressed in bels. The Sound Rating is based on tests performed at Standard Rating Conditions (cooling).

SPECIFIC HEAT: The amount of heat necessary to change the temperature of 1 pound of substance 1°F.

SPECIFIC VOLUME: The volume of a substance per unit of mass. i.e.: standard air 13.33 cubic feet per pound. The reciprocal of density.

STANDARD AIR DENSITY: .075 pounds per cubic foot. Equivalent to dry air at 70°F and at sea level pressure.

STATE CONDITION: Substances can exist in three states – Solid, Liquid or Vapor.

SUB-COOLING: Cooling of a liquid, at a constant pressure, below the point at which it was condensed.

SUCTION LINE: A tube used to convey the refrigerant vapor from the evaporator outlet to the suction inlet of a compressor.

SUCTION PRESSURE: The pressure read at the inlet side of a compressor. Also called back pressure or low side pressure.

SUPERHEAT: Heat added to a vapor after all liquid has been vaporized.

TEMPERATURE: A measure of heat intensity.

THERMOSTAT: A switch to close and open a circuit to indicate or terminate operation of a heating or air conditioning system.

THERMOSTATIC EXPANSION VALVE: Refrigerant control which monitors the flow rate according to the superheat at the evaporator outlet.

TON OF REFRIGERATION: The amount of heat necessary to completely melt 1 ton of 32°F ice in 24 hours. 200 BTUs per minute; 12,000 BTUs per hour; 288,000 BTUs in 24 hours. This is based on the latent heat fusion for ice which is 144 BTUs per pound.

TOTAL HEAT: (Enthalpy) The total heat energy in a substance. The sum of sensible and latent heat.

TOTAL PRESSURE: The sum of all partial pressures in a mixture of gases.

VACUUM: Any pressure below atmosphere pressure.

WATER MANOMETER: Used to measure pressure in inches of water.

WET BULB TEMPERATURE: Temperature read with a thermometer whose bulb is encased in a wetted wick.

Alternate Ways To Size ERVS / HRVS

Traditionally, square footage of a home was needed to correctly size an ERV or HRV (Energy Recovery Ventilator, Heat Recovery Ventilator). If you don't know the square footage of your home, there is an easier way to size the ERV or HRV that you need to get the job done.

Either of the methods below give a result that relates to the CFMs (cubic feet per minute) that the ventilator unit can move with it's internal fans. For example, the HONEYWELL HR150B 1005 Heat Recovery Ventilator is rated 150 CFM. The Fantech Heat Recovery Ventilator Model SHR 2005R will do 168 CFM.

Traditional Method - Square Footage

ERVs/HRVs are typically sized to ventilate the whole house at a minimum of .35 air changes per hour. To calculate minimum CFM requirements, simply take the square footage of the house (including basement) and multiply by the height of the ceiling to get cubic volume. Then, divide by 60 and multiply by .35.

Alternate Method - Room Count

With the room count method, each room in the home is assigned a certain number of CFMs. When the values from the rooms are added together - the total number of required CFMs are the result. Use the chart below to figure the number of CFMs needed to properly size your ERV or HRV.

ROOM	NO. OF ROOMS	CFM (L/s)	CFMs REQUIRED
Master Bedroom		x 20 CFM (10 L/s)	
Basement	Yes or No	If yes add CFM (10 L/s)	
Bedrooms		x 10 CFM (5 L/s)	
Living Room		x 10 CFM (5 L/s)	
Other		x 10 CFM (5 L/s)	
Kitchen		x 10 CFM (5 L/s)	
Bathroom		x 10 CFM (5 L/s)	
Laundry Room		x 10 CFM (5 L/s)	
Utility Room		x 10 CFM (5 L/s)	

Total Ventilation Required (add last column) _____

Exhaust Fans

PART NO.	DOWN BLAST, ROOF MOUNTED, DIRECT DRIVE FAN	VOLTAGE	MAX CFM	WEIGHT LBS.	ROOF MOUNTED DAMPER	FLAT ROOF CURB, INSULATED	115V		230V	
64408	FAN 5DDD085A 8"	115V 1 PH	417	26	5ACC12RD	5ACC17FT	5ACC03SC		x	
59551	FAN 5DDD10AA 10"	115V 1 PH	944	44	5ACC12RD	5ACC17FT	5ACC03SC		x	
59549	FAN 5DDD12CA 12"	115V 1 PH	1744	55	5ACC15RD	5ACC20FT	5ACC06SC		x	
62624	FAN 5DDD13DB 13"	115/230V 1 PH	2223	66	5ACC15RD	5ACC20FT	RPE10			RPE210
65287	FAN 5DDD16DB 16"	115/230V 1 PH	2913	149	5ACC15RD	5ACC24FS	RPE10			RPE210
69242	FAN 5DDD18EB 18"	115/230V 1 PH	4030	164	5ACC19RD	5ACC28FS	RPE10			RPE210

*Call for pricing.

Dimensions

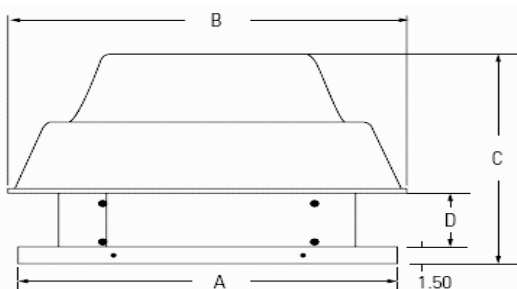

5ACC..RD

Roof Mount Damper

Manufactured from 19-gauge galvanized steel fram 2" deep with 1" flange. For quiet operation aluminum blades have felted edges. Pre-punched conduit hole knock-out.



Specification Data

MODEL	A	B	C	D
5DDD 085A	19"	18 7/8"	13 1/4"	3 1/2"
5DDD 106A	19"	22 3/8"	16 1/2"	3 3/8"
5DDD 10AA	19"	22 3/8"	16 1/2"	3 3/8"
5DDD 12CA	22"	24 1/4"	17 1/8"	4"
5DDD 13DB	22"	25 5/8"	18 1/8"	4 3/8"
5DDD 15CA	26"	27 1/8"	18 1/2"	4 3/8"
5DDD 16DB	26"	29 3/4"	20 1/4"	4 3/4"
5DDD 18EB	30"	31 5/8"	21 3/8"	5 5/8"

MODEL	FAN SIZE	RECOMMENDED ROOF OPENING	OUTSIDE FLANGE	WEIGHT, LBS	ITEM #
5ACC12RD	10"	12 1/2" x 12 1/2"	12" x 12"	3	47196
5ACC15RD	12", 13"	15 1/2" x 15 1/2"	15" x 15"	4	47203
5ACC19RD	15", 16"	19 1/2" x 19 1/2"	19" x 19"	5	47210
5ACC23RD	18", 20"	23 1/2" x 23 1/2"	23" x 23"	9	47215



Geothermal Verification Sheet

All geothermal units are built to order based on your specifications. Therefore, they are non-returnable and non-cancellable. Please review this sheet carefully before signing.

Customer name: _____ PO #: _____

Ship to: _____

Unit model number: _____

Compressor stages: single stage two stage

Tonnage: _____ Unit voltage: _____

Heat transfer type: water-to-air water-to-water

Unit configuration: packaged interior split exterior split

Heat exchanger: copper cupronickel

Supply location: top rear bottom
 end side N/A

Return location: left right

Blower type: PSC ECM X-13 (5 spd. ECM)
 oversized PSC oversized ECM

Back-up heat: _____

Accessories: _____

Options:

- no hot water, no Intellistart
- hot water with pump and no Intellistart
- hot water with pump and Intellistart
- Intellistart only

I agree that the unit ordered is correct and understand that geo-thermal products are non-returnable and non-cancellable once ordered.

Signature: _____ Date: _____

Printed name: _____

Metal Flue Venting

Integrated Furnace Control Menu

CLEARING THE LAST 6 FAULTS:
To clear the stored faults, scroll to the last 6 faults menu, enter the menu by scrolling to the right and hold the "Option" key for at least 5 seconds. Release and a set of 3 dashes will be seen 3 times. This confirms the faults have been cleared

SETTING UP YOUR SYSTEM:
To change any factory default value, first remove any "call" from the furnace and allow any fan off delays to finish. (1 dL should be seen on the display)
Scroll to the selected Menu item by momentarily depressing the "MENU" key and then depress the "OPTION" key to the desired setting. Then momentarily depress the "MENU" key again to save the change.

Gas Heating CFM shown is 2nd stage airflow, 1st stage airflow is ~80% of the selected 2nd stage airflow and cannot be adjusted.
Gas heating CFM can be adjusted while the unit is operating in gas heat mode to enable the technician to quickly adjust to the manufacturer's suggested heat rise across the heat exchanger.
Multiply the value shown by 10 for actual airflow

Model	Gas Heating CFM []=Default
S9V2B040J3PS	088 [088], 140, 065, 083
S9V2B060J3PS	103 [103], 113, 146, 080
S9V2B060J4PS	116 [116], 159, 099, 109
S9V2B080J3PS	138 [138], 148, 120, 133
S9V2B080J4PS	126 [126], 133, 146, 120
S9V2B080J5PS	145 [145], 156, 208, 119
S9V2C100J4PS	183 [183], 190, 145, 162
S9V2C100J5PS	198 [198], 215, 225, 159
S9V2D120J5PS	195 [195], 225, 156, 185

Model	Downflow
S9V2B040D3PS	088 [088], 095, 140, 065
S9V2B060D3PS	103 [103], 113, 146, 080
S9V2B080D3PS	138 [138], 148, 120, 133
S9V2B080D4PS	126 [126], 133, 148, 120
S9V2C100D4PS	175 [175], 189, 131, 167
S9V2C100D5PS	187 [187], 225, 152, 180
S9V2D120D5PS	225 [225], 175, 185, 195

Model	ODT Options []= Default
S9V2B040J3PS	3T[3T], 1.5T, 2T, 2.5T
S9V2B060J3PS	3T[3T], 1.5T, 2T, 2.5T
S9V2B060J4PS	4T[4T], 2.5T, 3T, 3.5T
S9V2B080J3PS	3T[3T], 3.5T, 2T, 2.5T
S9V2B080J4PS	4T[4T], 2.5T, 3T, 3.5T
S9V2C100J4PS	5T[5T], 3.5T, 4T, 4.5T
S9V2C100J5PS	5T[5T], 3.5T, 4T, 4.5T
S9V2D120J5PS	5T[5T], 3.5T, 4T, 4.5T

Model	Downflow
S9V2B040D3PS	3T[3T], 1.5T, 2T, 2.5T
S9V2B060D3PS	3T[3T], 1.5T, 2T, 2.5T
S9V2B080D3PS	3T[3T], 3.5T, 2T, 2.5T
S9V2B080D4PS	4T[4T], 2.5T, 3T, 3.5T
S9V2C100D4PS	4T[4T], 2.5T, 3T, 3.5T
S9V2C100D5PS	5T[5T], 3.5T, 4T, 4.5T
S9V2D120D5PS	5T[5T], 3.5T, 4T, 4.5T

CFM per Ton selections range from 290 – 450
Important:
When applied with zoning or a VSPD outdoor unit, the CFM/Ton must be set to 400

S9V2 Control System Menu

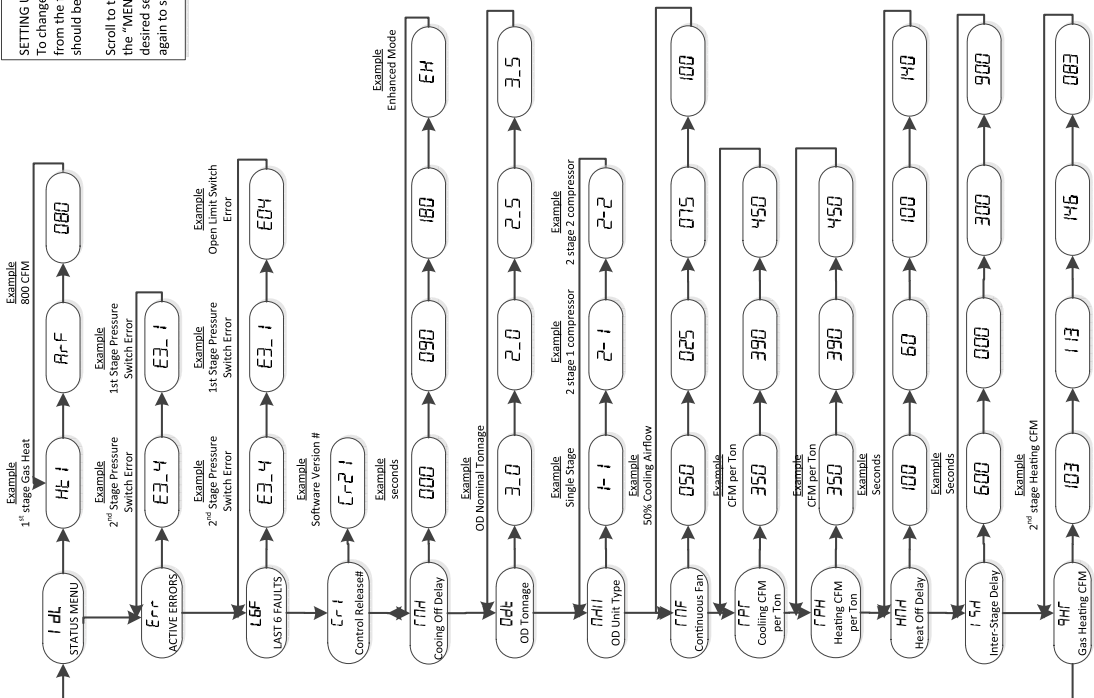

Metal Flue Venting

S9V2 Examples of System Status

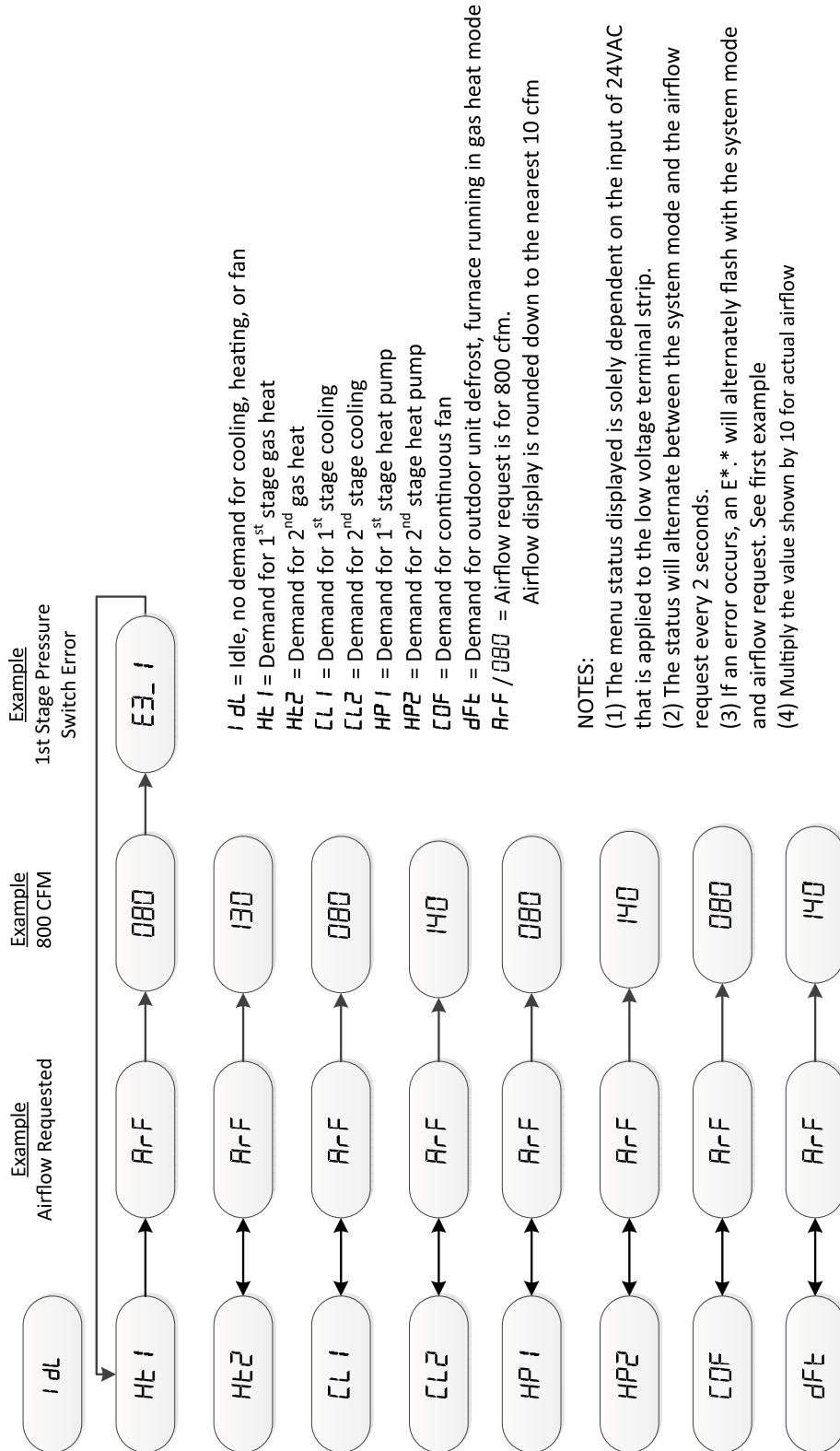

Metal Flue Venting

Note: During run test mode, depressing the option key will allow the user to hold (HLD) that test sequence if measurements want to be taken. The exception is RU3 (ignitor).



Run Test Mode:

To enter Run Test Mode, scroll to *rUn* using the Menu key, then push the option key. The LED will flash *rUn* three times, then begin the test.

To exit the test mode, momentarily push the Menu key, cycle power to the furnace, or make a valid thermostat call for capacity or fan.

Sequence of Run Test Mode

rU1 - Turns the inducer on in 1st stage for 30 seconds

rU2 - Turns on the inducer on 2nd stage for 30 seconds

rU3 - Turns the ignitor on for 10 seconds

rU4 - Turns the circulating blower on 1st stage compressor speed for 10 seconds

rU5 - Turns the circulating blower on 2nd stage compressor speed for 10 seconds

rU6 - Turns the circulating blower on 1st stage gas heat speed for 10 seconds

rU7 - Turns on the circulating blower on 2nd stage gas heat speed for 10 seconds

The above sequence will repeat two more times unless the Run Test Mode is exited, see above

Important: The Run Test Mode does not test fire the furnace or bring the outdoor unit on. It is designed to allow the technician to observe each mode to ensure the IFC, inducer, and circulating blower are performing as intended.

Troubleshooting Flowchart Index

IFC Component Layout

Getting Started

Error Codes

E2.1 – Retries Exceeded (flame never sensed)

E2.2 – Recycles Exceeded (loss of flame after being sensed)

E3.1 – Shorted Pressure Switch, 1st Stage

E3.2 – Open Pressure Switch, 1st Stage

E3.3 – Shorted Pressure Switch, 2nd Stage

E3.4 – Open Pressure Switch, 2nd Stage

E04 – Open Thermal Limit

E04 – Flame Rollout

E05 – Flame Detected , should not be present

E6.1 – Reversed Polarity (High Voltage)

E6.2 – Faulty Ground

E6.3 – Igniter Circuit

E7.1 – 1st Stage Gas Valve (MVL) energized when it should not be

E08 – Flame Current Low, operation allowed

E09 – Open Inducer Limit OR Condensate Switch

E11 – See troubleshooting Instructions

E13 – Blower HP / OEM Mismatch

E15 – PM Data and Local copy corrupted

E18 – Blower Communication failure on the IFC

Metal Flue Venting

FLEXI-LINER®

FLEXI-LINER® SIZER Corrugated Chimney Liner for Gas Fired Appliances

SINGLE APPLIANCE

Height, Ft "H"	Connector Type: Double or Single Wall "C"	Lateral Offset "L"	FLEXI-LINER Diameter "D" (inches)																				
			3"			4"			5"			5.5"			6"			7"			8"		
			Appliance Input Rating Limits (x1000 BTU/h) Reduced 20% from Type B Vent Tables																				
		FAN		NAT		FAN		NAT		FAN		NAT		FAN		NAT		FAN		NAT			
		Min	Max	Min	Max	Min	Max	Min	Max	Min	Max	Min	Max	Min	Max	Min	Max	Min	Max	Min	Max		
15'	Double	2"	11	55	38	15	109	74	20	181	120	21	226	150	22	271	180	38	380	253	45	506	331
		5"	22	52	36	30	104	70	39	175	114	44	220	144	49	264	174	64	370	240	76	496	322
		10"	29	47	33	40	97	66	51	165	108	58	208	137	64	252	166	84	356	230	99	480	309
	Single	2"	38	55	38	57	109	74	80	180	119	98	225	149	115	270	179	148	378	251	187	505	330
		5"	51	50	35	75	102	69	102	173	112	123	217	143	144	261	174	182	367	238	231	493	320
		10"	NA	NA	NA	95	93	63	128	161	105	155	204	134	182	246	162	228	350	227	284	474	305
25'	Double	2"	10	62	43	14	126	85	16	213	140	18	268	176	19	324	212	30	458	296	37	615	402
		5"	21	59	41	29	21	82	37	207	134	42	261	170	46	315	206	60	448	289	71	603	394
		10"	28	54	38	38	113	76	49	196	128	55	249	162	61	302	196	79	432	277	93	585	380
	Single	2"	37	62	42	56	125	84	77	212	139	94	267	175	111	322	211	142	455	294	179	612	400
		5"	50	57	40	73	119	80	99	204	132	119	258	168	139	312	204	175	444	286	220	599	391
		10"	NA	NA	NA	92	109	74	124	191	126	149	244	159	174	296	192	218	424	273	271	577	375
30'	Double	2"	9	65	45	13	133	90	14	226	148	16	286	186	18	346	224	27	490	315	33	661	428
		5"	21	62	43	28	128	86	36	220	141	41	278	180	45	337	218	58	480	308	69	649	419
		10"	27	56	40	37	120	82	48	210	137	54	267	173	59	324	209	77	464	297	91	630	406
	Single	2"	37	64	45	55	131	89	76	225	146	93	284	185	109	343	223	139	488	314	175	658	426
		5"	49	59	42	72	126	85	98	217	138	117	275	178	136	334	217	171	476	306	215	645	417
		10"	NA	NA	NA	91	115	78	122	204	134	147	261	170	171	318	206	213	456	294	265	622	401
35'	Double	2"	9	66	46	13	136	92	14	234	152	16	296	192	17	359	231	26	511	325	31	691	444
		5"	21	63	NA	28	131	89	36	227	146	40	289	186	45	350	225	57	500	319	68	679	435
		10"	27	57	NA	37	124	84	47	217	141	53	277	178	58	337	216	76	484	308	90	660	422
	Single	2"	37	65	46	55	135	91	75	232	151	92	294	190	108	356	230	138	508	324	173	688	442
		5"	49	60	NA	72	129	87	97	224	143	116	285	184	135	347	224	169	496	316	212	674	433
		10"	NA	NA	NA	91	118	NA	121	211	138	145	271	175	169	330	213	211	476	304	262	651	417
45'	Double	2"	8	68	48	12	143	96	14	249	161	15	317	203	16	385	244	23	552	346	28	750	476
		5"	20	65	NA	27	138	93	35	242	155	39	309	197	44	376	239	56	541	340	66	738	468
		10"	26	60	NA	36	131	89	46	232	148	51	298	190	57	364	231	74	525	330	87	719	455
	Single	2"	36	66	48	54	141	95	74	247	160	90	315	201	105	383	243	135	549	344	170	747	474
		5"	48	63	NA	71	136	91	95	239	153	114	306	195	132	373	237	168	537	337	207	733	465
		10"	NA	NA	NA	90	125	NA	119	228	145	142	291	186	164	356	227	206	517	325	256	709	450

MULTIPLE APPLIANCES

Height, Ft "H"	Connector Type: Double or Single Wall "C"	FLEXI-LINER Diameter "D" (inches)																	
		4"			5"			5.5"			6"			7"			8"		
		Combined Appliance Input Rating Limits (x1000 BTU/h) Reduced 20% from Vertical Common Vent																	
		FAN Only		FAN & NAT Only		FAN Only		FAN & NAT Only		FAN Only		FAN & NAT Only		FAN Only		FAN & NAT Only			
		Min	Max	Min	Max	Min	Max	Min	Max	Min	Max	Min	Max	Min	Max	Min	Max		
15'	Double	100	90	73	156	131	115	191	157	140	226	182	165	342	282	224	445	355	292
	Single	97	86	70	151	127	112	186	152	136	220	177	160	333	274	219	435	347	286
25'	Double	116	104	88	184	157	138	227	189	168	270	221	198	409	341	268	537	434	350
	Single	111	100	84	178	152	135	220	183	163	262	214	192	398	332	261	524	423	342
30'	Double	122	110	94	195	168	148	242	203	181	289	238	213	438	367	288	576	468	376
	Single	116	106	90	189	162	144	235	196	175	280	229	206	426	357	279	562	456	367
35'	Double	125	113	97	202	175	154	252	212	188	301	249	222	457	385	301	603	492	392
	Single	119	109	93	195	168	150	243	204	182	291	239	214	444	374	291	588	479	382
45'	Double	131	119	104	216	188	165	271	230	202	325	271	239	494	420	326	656	541	424
	Single	124	114	99	208	180	161	261	220	195	314	260	229	480	407	316	640	526	413

See Rigid Connector Sizing Table below for Multiple Appliance Systems

Metal Flue Venting

FLEXI-LINER®

Aluminum Flexible Chimney Liner and Gas Vent Connector

Installation Instructions

RIGID CONNECTOR - SIZING INFORMATION

VENT CONNECTOR CAPACITIES

FOR MULTIPLE CATEGORY 1 APPLIANCES CONNECTED TO A COMMON VENT

System Height, Ft	Connector Type: Double or Single Wall	Connector Rise, Ft	3"			4"			5"			6"		
			Fan		Nat	Fan		Nat	Fan		Nat	Fan		Nat
			Min	Max	Max	Min	Max	Max	Min	Max	Max	Min	Max	Max
15	Double	1	21	50	30	33	89	53	47	142	83	64	220	120
		2	22	53	35	35	96	63	49	153	99	66	235	142
		3	24	55	40	36	102	71	51	163	111	68	248	160
	Single	1	NA	NA	29	79	87	52	116	138	81	177	214	116
		2	NA	NA	34	83	94	62	121	150	97	185	230	138
		3	NA	NA	39	87	100	70	127	160	109	193	243	157
25	Double	1	21	58	32	32	106	58	46	169	90	61	267	130
		2	22	61	38	34	112	68	48	179	107	63	279	154
		3	23	63	43	35	117	77	49	187	120	65	290	173
	Single	1	48	58	31	78	104	56	114	164	87	172	258	125
		2	52	61	37	82	109	66	119	174	104	180	271	148
		3	55	63	41	86	113	74	124	183	117	188	282	168
30	Double	1	20	62	33	31	113	59	45	181	93	60	288	134
		2	21	64	39	33	118	70	47	190	110	62	299	158
		3	22	66	44	34	123	79	48	198	124	64	309	178
	Single	1	47	60	31	77	110	57	112	175	89	169	278	129
		2	51	62	37	81	115	67	117	185	106	177	290	152
		3	54	64	42	85	119	76	122	193	120	185	300	172
35	Double	1	20	64	34	31	118	60	45	190	95	59	303	137
		2	21	66	40	33	123	72	47	198	112	61	314	162
		3	22	68	45	34	128	81	48	206	127	63	323	182
	Single	1	47	62	32	77	115	58	111	183	91	167	293	131
		2	51	64	38	81	119	68	116	193	108	175	304	155
		3	54	66	43	85	123	78	121	200	121	183	313	176
45	Double	1	19	69	35	30	128	63	44	207	99	58	334	142
		2	21	71	42	32	132	75	46	215	117	60	343	169
		3	22	73	47	33	137	84	47	221	132	62	352	190
	Single	1	46	67	33	76	124	59	110	199	94	164	322	135
		2	50	69	39	80	128	71	115	208	111	172	331	161
		3	53	70	44	84	132	81	120	214	122	180	340	183

NA means "Not Allowed"

Metal Flue Venting

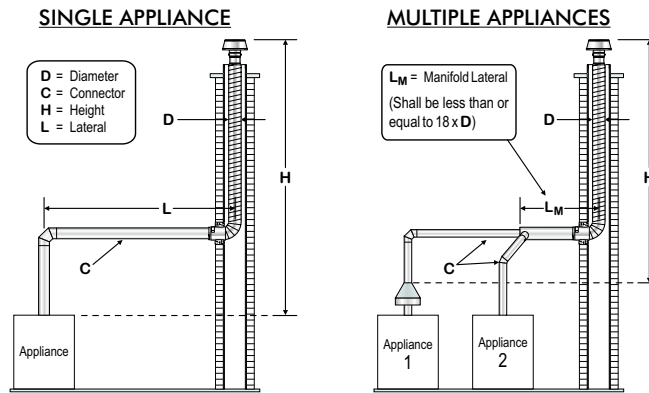

GENERAL VENTING REQUIREMENTS

- A1. The air space around an installed Flexi-Liner System must not be used to vent other appliances.
- A2. A Flexi-Liner System venting more than one appliance shall not be smaller in diameter than the outlet of the largest appliance being served.
- A3. For single appliance installations, the Flexi-Liner System may be smaller in diameter than the outlet of the appliance being served, providing:
 - a) the vent height is at least 10ft.
 - b) the liner size is not more than one size smaller.
 - c) the "FAN MAX" is reduced by 10% if the appliance is "fan assisted".
 - d) the outlet is larger than 4" if the appliance is "natural draft".
- A4. Reduce Flexi-Liner capacity for elbows (turns) as follows:
 - A4.1. Single Appliance (two 90° elbows for total vent system are factored into chart)
 - a) In USA - for each additional elbow up to 45°, reduce capacity by 5%.
- for each additional elbow 45°-90°, reduce capacity by 10%.
 - b) In CDA - for each additional elbow 90° reduce capacity by 10% for NAT and 15% for FAN.
 - A4.2. Multiple Appliances (90° turn at the bottom of liner is factored into chart)
 - a) In USA - for each elbow in the common vent up to 45°, reduce capacity by 5%.
- for each elbow 45°-90°, reduce capacity by 10%.
 - b) In CDA - for each 90° elbow in the common vent, reduce capacity by 10% for NAT and 15% for FAN.

Common Vent manifold fitting is part of the connector sizing coming to it.
- A5. Do not use these tables if the vent system contains any device (such as a vent damper, draft regulator or heat reclaimer, etc.), which retards the flow of vent gases. Refer to instructions provided by the manufacturer of the device for vent instructions.
- A6. Interpolation between the table entries is permitted, extrapolation beyond the table entries is not permitted.
- A7. Vent connector sizes for multiple appliances are derived from tables included in the following national gas codes: NFPA 54 (USA) and B149.1 (CDA).
- A8. These tables are derived from the National Fuel Gas Code (NFPA 54 & CSA-B149). Current code data and information will supercede these sizing instructions if there is any discrepancy between them.

ADDITIONAL COMMENTS

- B1. Flexi-Liner System is UL/ULC Listed for relining existing masonry or factory-built chimneys and vents serving Category I natural gas or propane fired appliances.
- B2. Insulating of Flexi-Liner System is a benefit to the installation but not always essential to effective operation of this venting system. Consult the Flexi-Sleeve installation instructions for application guidelines.
- B3. The use of a "Y" fitting rather than a "T" fitting is recommended when common venting into a manifold system.
- B4. AVOID CONDENSATION and/or SPILLAGE OF FLUE GASES:
 - a) Install Flexi-Liner as per installation instructions.
 - b) Set up appliances as per appliance installation instructions.
- B5. Contact local authorities for restrictions and regulations in your area.
- B6. Venting gas fired appliances into masonry chimneys is prohibited, unless a Listed liner such as Flexi-Liner, or a tile liner conforming to Code is utilized. Oversized, misaligned and/or cracked tiles DO NOT constitute a Code liner.

Printed in Canada

FLEXI-LINER®



A MUNCH'S SUPPLY COMPANY

WE'RE EVERYWHERE YOU NEED US!

HVAC for Residential, Commercial, Geothermal, Radiant

Trusted brands from a trusted distributor

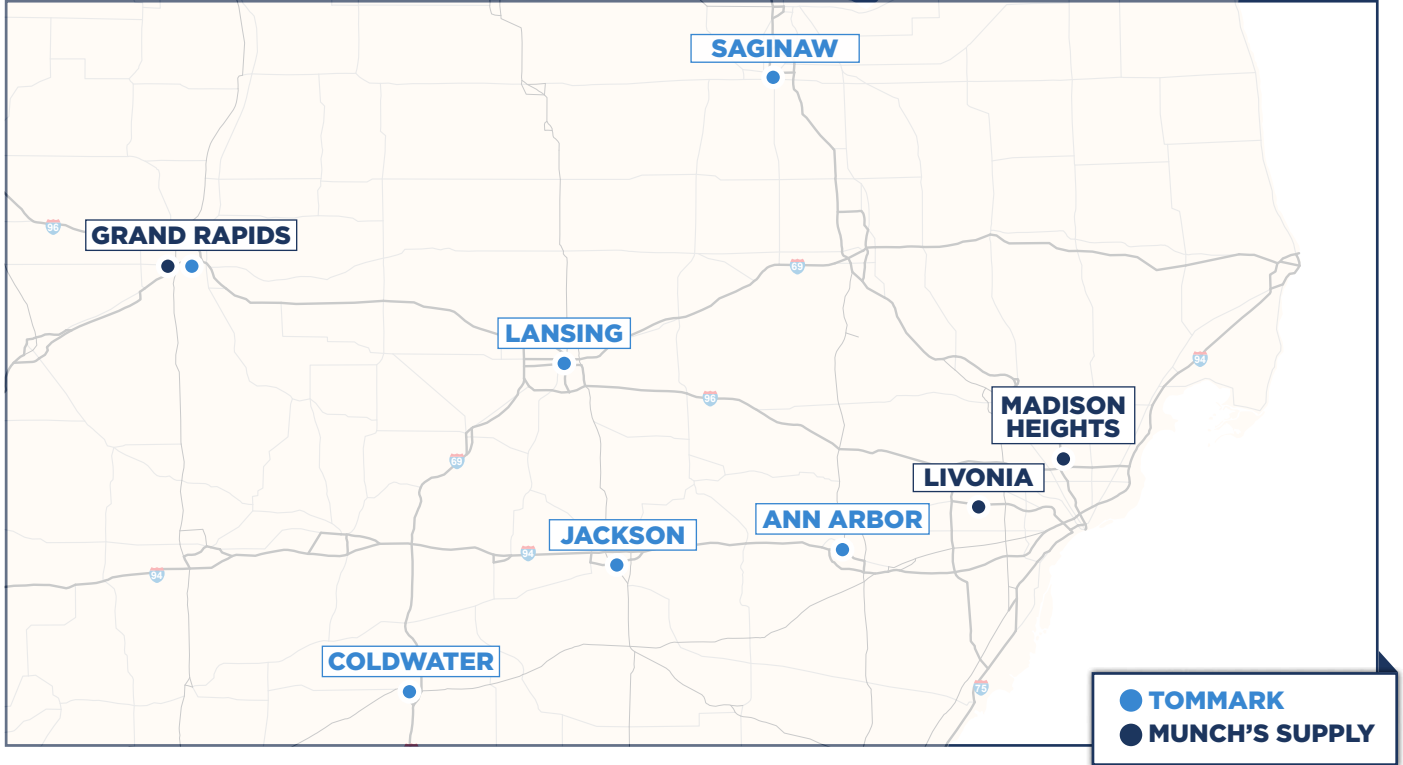

A MUNCH'S SUPPLY COMPANY

ANN ARBOR

141 Jackson Industrial
Ann Arbor, MI 48103
P (800) 665-1452
F (734) 665-0679

M-F: 7:30 a.m. - 4:30 p.m.

COLDWATER

36 Mill Street
Coldwater, MI 49036
P (800) 922-5180
F (517) 279-7350

M-F: 7:30 a.m. - 4:30 p.m.

GRAND RAPIDS

130 Graham S.W.
Grand Rapids, MI 49503
P (800) 541-1144
F (616) 247-0283

M-F: 7:30 a.m. - 4:30 p.m.

JACKSON

1021 Belden Road
Jackson, MI 49203
P (800) 333-8005
F (517) 782-1155

M-F: 7:30 a.m. - 4:30 p.m.

LANSING

1115 S. Pennsylvania
Lansing, MI 48912
P (800) 487-4836
F (517) 487-1119

M-F: 7:30 a.m. - 4:30 p.m.

SAGINAW

219 Atwater
Saginaw, MI 48601
P (800) 292-0233
F (989) 754-4241

M-F: 7:30 a.m. - 4:30 p.m.



WE MAKE IT EASY™

GRAND RAPIDS

5805 Weller Ct. Ste C
Wyoming, MI 49509
P (616) 559-0076
F (616) 534-2358

M-F 6:30 a.m. - 5 p.m.
Sat. 7 - 11 a.m.

LIVONIA

32713 Schoolcraft Rd.
Livonia, MI 48150
P (734) 742-5350
F (734) 742-5360

M-F 6:30 a.m. - 5 p.m.
Sat. 7 - 11 a.m.

MADISON HEIGHTS

30000 Stephenson Hwy Unit C
Madison Heights, MI 48071
P (248) 826-6882
F (248) 544-3699

M-F 6:30 a.m. - 5 p.m.
Sat. 7 - 11 a.m.