

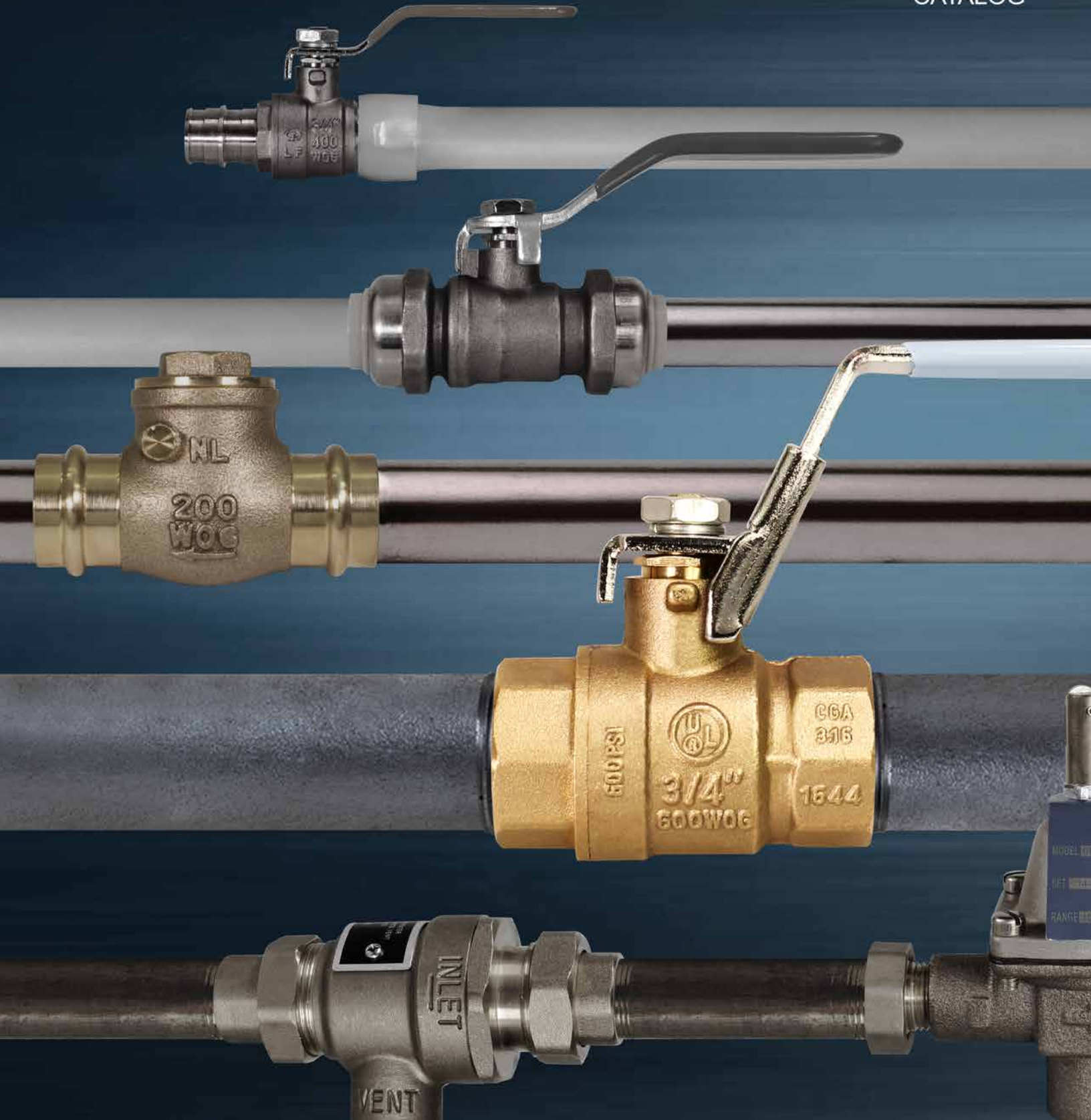

EVERFLOW™

VALVES & HYDRONICS

CATALOG



Trusted Quality. Premium Performance.

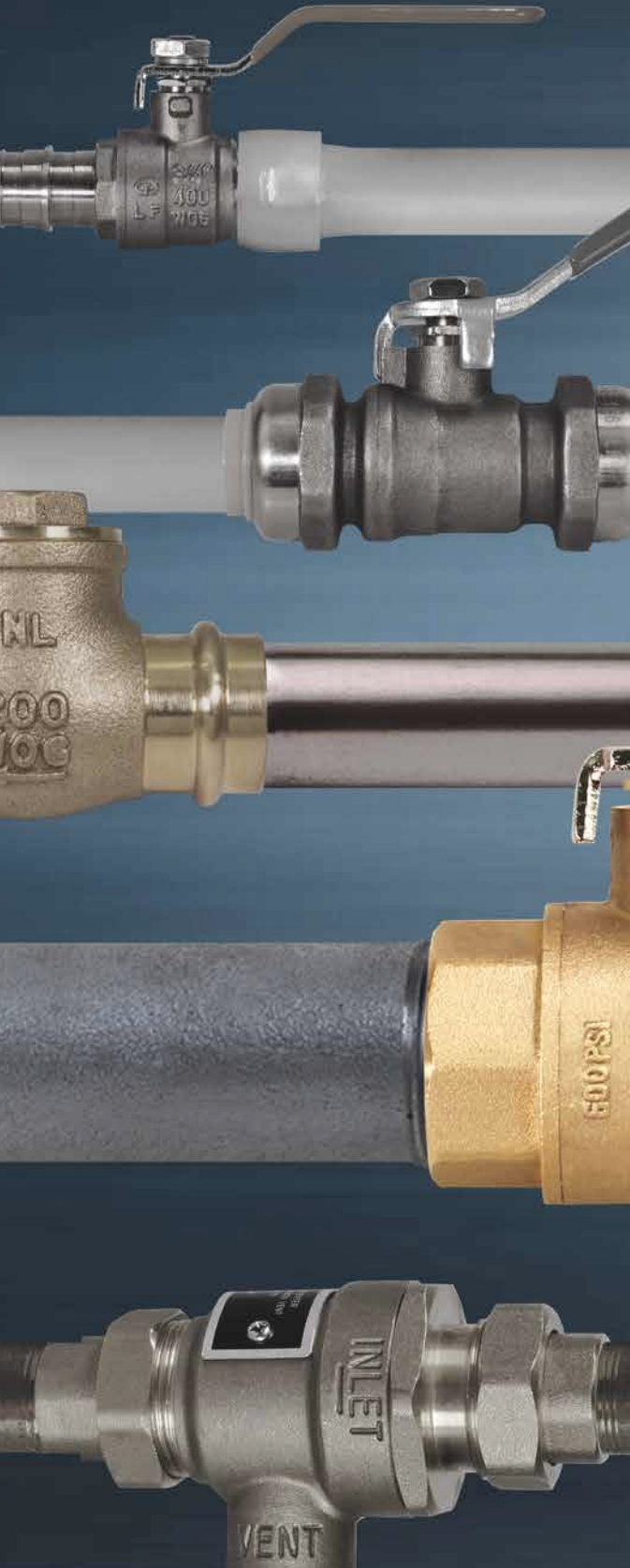

For 3 Generations, our team has worked diligently to build strong products with maximum quality, reliability & endurance.

Everflow's New Valve & Hydronics Catalog provides you access to our comprehensive range of valves and related products for commercial and residential applications.

We pride ourselves in providing the finest quality PVF products combined with integrity and dedication to superior customer support. Our national network of distribution centers, allows for increased inventory, shorter shipping times, while providing our customers with the most efficient and cost effective solutions.

Our products meet and exceed national standards, and are approved by many applicable approval agencies.

Our Brands



Our Flagship Brand of Quality Valves & Plumbing Products



Specialty Valves & Hydronic Solutions



Gas Appliance Valves & Connectors



Push to Connect Valves & Fittings

Table of Contents

BALL VALVES

| | |
|----------------------------|-----------|
| Threaded/Sweat Ball Valves | Pg. 4-12 |
| Gas Ball Valves | Pg. 14-15 |
| Press Ball Valves | Pg. 16-20 |
| Compression Ball Valves | Pg. 13 |
| Push Fit Ball Valves | Pg. 21 |
| Pex F1807 Ball Valves | Pg. 22-26 |
| Pex F1960 Ball Valves | Pg. 26-29 |
| Mini Ball Valves | Pg. 34 |

SPECIALTY BALL VALVES

| | |
|-----------------------------------|-----------|
| Hose Ball Valves | Pg. 11 |
| Flanged Ball Valves | Pg. 30-31 |
| Tankless water Heater Valves | Pg. 32 |
| Hi-Flow 3-Way Drain Valves | Pg. 33 |
| Purge Station Valves | Pg. 35 |
| Expansion Tank Valves | Pg. 34 |
| OP45 One Piece Gas Ball Valve | Pg. 15 |
| Gas Ball Valve w/Screwdriver Slot | Pg. 10 |

CHECK VALVES

| | |
|---------------------------|--------|
| Swing Check Valves | Pg. 36 |
| Press Swing Check Valves | Pg. 36 |
| Inline Swing Check Valves | Pg. 37 |
| Press Swing Check Valves | Pg. 37 |
| Y-Strainer | Pg. 37 |

GATE VALVES

| | |
|------------------------------|-----------|
| Brass Gate Valves | Pg. 38 |
| Heavy Duty Brass Gate Valves | Pg. 39 |
| Long Bonnet Gate Valves | Pg. 40-41 |

COMPRESSION STOP VALVES

| | |
|-----------------------------|-----------|
| Straight Short Globe Valves | Pg. 40 |
| Angle Short Globe Valves | Pg. 41 |
| Stop and Waste Valves | Pg. 40-41 |
| Long Bonnet Stop Valves | Pg. 41 |

DRAIN VALVES & SILLCOCKS

| | |
|----------------------------|-----------|
| Boiler Drains | Pg. 42-43 |
| Hose Bibs | Pg. 44 |
| Sillcocks | Pg. 44-45 |
| Frost Free Sillcocks | Pg. 46-48 |
| Sillcock Replacement Parts | Pg. 46-48 |

HYDRONIC HEATING & COMPONENTS

| | |
|-------------------------------|-----------|
| Feed Pressure Water Regulator | Pg. 57 |
| Backflow Preventer | Pg. 57 |
| Heating Boiler Air Scoop | Pg. 57 |
| Automatic Air Vent | Pg. 57 |
| Spiral Air Vent | Pg. 58 |
| Thermal & Hydronic Tanks | Pg. 59 |
| Pex Manifolds & Accessories | Pg. 66-67 |
| Steel Manifolds | Pg. 66 |
| Copper Manifolds | Pg. 67 |
| Radiator Valves | Pg. 60-61 |
| Union Elbow | Pg. 62 |
| Monoflow Tees | Pg. 62 |
| Radiator Valve Tools & Parts | Pg. 63 |

WATER SUPPLY

| | |
|-----------------------|-----------|
| Multi Turn Stops | Pg. 50 |
| Quarter Turn Stops | Pg. 51-54 |
| Push-Fit Stops | Pg. 54 |
| Washing Machine Valve | Pg. 55 |
| Ice Maker Valve | Pg. 55 |
| Dishwasher Valve | Pg. 55 |
| Anti-Sweat Valve | Pg. 55 |

SPECIALTY FITTINGS & ACCESSORIES

| | |
|-----------------------------|--------|
| Compression Couplings | Pg. 13 |
| Dielectric Unions & Nipples | Pg. 72 |
| CPVC Transition Fittings | Pg. 71 |
| Water Meter Couplings | Pg. 73 |
| Meter Bars | Pg. 73 |
| Safety Signs | Pg. 74 |



Built to Perform.





610 Series Premium Ball Valve

UL Listed • CSA Certified • Lead Free • Full Port • 600 WOG

The 610 Series Premium Ball Valves are used in commercial, industrial and residential applications for a full range of liquids and gases. The body is constructed of durable lead free DZR brass material. The valve features a bottom-loaded blowout-out stem. Stainless steel ball and PTFE seats create a positive seal, reducing friction and minimizing wear.



- Available in 1/4"- 4" Threaded & Sweat
- UL Listed 842,125 125 psig
- Certified For FM1140 600 psig 1/4"- 2" IPS, 1/2"- 2" SWT
- CSA Certified 1/2 psig / 5 psig / 125 psig 1/4"- 4"
- Lead Free
- Temperature Range: -20°F to 300°F
- Threaded end connections comply with ANSI/ASME B1.20.1
- Solder end connections comply with ANSI/ASME B16.18

610 SERIES SPECIFICATIONS

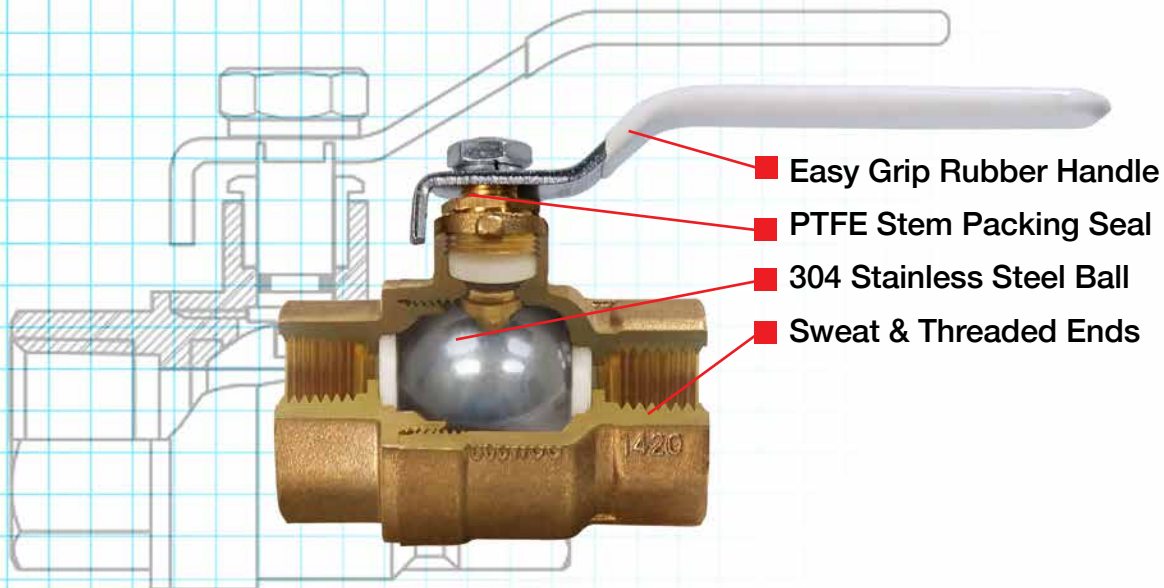

- Easy Grip Rubber Handle
- PTFE Stem Packing Seal
- 304 Stainless Steel Ball
- Sweat & Threaded Ends



BALL VALVES



605 Series Premium Brass Ball Valve

CSA Approved • Lead Free • Full Port • 600 WOG



- Dezincification Resistant (DZR) Lead Free Brass Material
- Stainless Steel Ball 1-1/4" - 2", Chrome Plated Ball 1/2" - 1"
- PTFE Stem Packing Seal and Seats
- Blow Out Proof Stem
- Ends Conform to ANSI B1.20.1 / ASME B16.22
- CSA Certified Threaded 1/4" - 2"
- Conforms to NSF/ANSI-61, NSF/ANSI-372, IGC-157
- 600 psi WOG 150 psi WSP
- Temperature Range: -20°F to 300°F
- ISO:9001 Approved Manufacturer



| THREADED PART # | SWEAT PART # | SIZE | DESCRIPTION | INNER | MASTER |
|-----------------|--------------|--------|----------------------|-------|--------|
| 605T012-NL | 605C012-NL | 1/2" | Full Port Ball Valve | 10 | 100 |
| 605T034-NL | 605C034-NL | 3/4" | Full Port Ball Valve | 10 | 100 |
| 605T001-NL | 605C001-NL | 1" | Full Port Ball Valve | 5 | 50 |
| 605T114-NL | 605C114-NL | 1-1/4" | Full Port Ball Valve | 5 | 25 |
| 605T112-NL | 605C112-NL | 1-1/2" | Full Port Ball Valve | 5 | 25 |
| 605T002-NL | 605C002-NL | 2" | Full Port Ball Valve | 2 | 12 |
| 605T212-NL | 605C212-NL | 2-1/2" | Full Port Ball Valve | 2 | 8 |
| 605T003-NL | 605C003-NL | 3" | Full Port Ball Valve | 2 | 6 |
| 605T004-NL | 605C004-NL | 4" | Full Port Ball Valve | 2 | 4 |

610 Series Premium Brass Ball Valve

UL Listed • CSA Certified • Lead Free • Full Port • 600 WOG



- Dezincification Resistant (DZR) Lead Free Brass Material
- Stainless Steel Ball
- PTFE Stem Packing Seal and Seats
- Blow Out Proof Stem Design
- Ends Conform to ANSI B1.20.1 / ASME B16.22
- Conforms to NSF/ANSI-61, NSF/ANSI-372, IGC-157
- UL Listed 842,125 125 psig
- Certified to FM1140 600 psig 1/4" - 2" IPS, 1/2" - 2" SWT
- CSA Certified 1/2 psig / 5 psig / 125 psig 1/4" - 4"
- 600 psi WOG 150 psi WSP
- Temperature Range: -20°F to 300°F
- ISO:9001 Approved Manufacturer



| THREADED PART # | SWEAT PART # | SIZE | DESCRIPTION | INNER | MASTER |
|-----------------|--------------|--------|----------------------|-------|--------|
| 610T014-NL | - | 1/4" | Full Port Ball Valve | 12 | 144 |
| 610T038-NL | - | 3/8" | Full Port Ball Valve | 12 | 144 |
| 610T012-NL | 610C012-NL | 1/2" | Full Port Ball Valve | 10 | 100 |
| 610T034-NL | 610C034-NL | 3/4" | Full Port Ball Valve | 10 | 100 |
| 610T001-NL | 610C001-NL | 1" | Full Port Ball Valve | 5 | 50 |
| 610T114-NL | 610C114-NL | 1-1/4" | Full Port Ball Valve | 12 | 24 |
| 610T112-NL | 610C112-NL | 1-1/2" | Full Port Ball Valve | 5 | 25 |
| 610T002-NL | 610C002-NL | 2" | Full Port Ball Valve | 2 | 12 |
| 610T212-NL | 610C212-NL | 2-1/2" | Full Port Ball Valve | 3 | 6 |
| 610T003-NL | 610C003-NL | 3" | Full Port Ball Valve | 2 | 6 |
| 610T004-NL | 610C004-NL | 4" | Full Port Ball Valve | 2 | 4 |

BALL VALVES



800 Series High-Grade Ball Valve

Stainless Steel Handle • CSA Certified • Lead Free • Full Port • 600 WOG



800C012-NL



800T012-NL

- Dezincification Resistant (DZR) Lead Free Brass Material
- Stainless Steel Ball
- PTFE Stem Packing Seal and Seats
- Blow Out Proof Bottom Loaded Stem
- Vinyl Grip Lever Handle
- Stainless Steel Handle
- Ends Conform to ANSI B1.20.1 / ASME B16.22
- Conforms to NSF/ANSI-61, NSF/ANSI-372, IGC-157
- UL Listed Threaded
- CSA Certified Threaded
- 600 psi WOG 150 psi WSP
- Temperature Max: 400°F
- ISO:9001 Approved Manufacturer



| THREADED PART # | SWEAT PART # | SIZE | DESCRIPTION | INNER | MASTER |
|-----------------|--------------|--------|----------------------|-------|--------|
| 800T014-NL | 800C014-NL | 1/4" | Full Port Ball Valve | 12 | 144 |
| 800T038-NL | 800C038-NL | 3/8" | Full Port Ball Valve | 12 | 144 |
| 800T012-NL | 800C012-NL | 1/2" | Full Port Ball Valve | 10 | 100 |
| 800T034-NL | 800C034-NL | 3/4" | Full Port Ball Valve | 10 | 100 |
| 800T001-NL | 800C001-NL | 1" | Full Port Ball Valve | 5 | 50 |
| 800T114-NL | 800C114-NL | 1-1/4" | Full Port Ball Valve | 12 | 24 |
| 800T112-NL | 800C112-NL | 1-1/2" | Full Port Ball Valve | 5 | 25 |
| 800T002-NL | 800C002-NL | 2" | Full Port Ball Valve | 2 | 12 |
| 800T212-NL | 800C212-NL | 2-1/2" | Full Port Ball Valve | 3 | 6 |
| 800T003-NL | 800C003-NL | 3" | Full Port Ball Valve | 2 | 6 |
| 800T004-NL | 800C004-NL | 4" | Full Port Ball Valve | 2 | 4 |

615 Series Lead Free T-Handle Brass Ball Valve



CSA Approved • Lead Free • T-Handle with Vinyl Grip • Full Port • 600 WOG



615T001-NL



615C001-NL

- Dezincification Resistant (DZR) Lead Free Brass Material
- Forged Brass Body
- Blow Out Proof Stem Design
- Packing Nut & Packing On The Stem Seal
- Stainless Steel Ball
- Vinyl Grip T-Handle
- Ends Conform to ANSI B1.20.1 / ASME B16.22
- CSA Certified to: NSF/ANSI-61, NSF/ANSI-372, IGC-157
- 600 psi WOG 150 psi WSP
- Temperature Range: -20°F to 300°F
- ISO:9001 Approved Manufacturer



| THREADED PART # | SWEAT PART # | SIZE | DESCRIPTION | INNER | MASTER |
|-----------------|--------------|------|----------------------|-------|--------|
| 615T014-NL | - | 1/4" | Full Port Ball Valve | 10 | 100 |
| 615T012-NL | 615C012-NL | 1/2" | Full Port Ball Valve | 10 | 100 |
| 615T034-NL | 615C034-NL | 3/4" | Full Port Ball Valve | 10 | 100 |
| 615T001-NL | 615C001-NL | 1" | Full Port Ball Valve | 5 | 50 |

BALL VALVES

L-610 Series Premium Lock Handle Ball Valve

RAVEN
SPECIALTY PRODUCTS

UL Listed • CSA Certified • Lead Free • Full Port • 600 WOG



- Dezincification Resistant (DZR) Lead Free Brass Material
- Latch Lock Handle with Vinyl Grip
- Forged Brass Body
- Stainless Steel Ball
- PTFE Stem Packing Seal and Seats
- Blow Out Proof Stem Design
- Ends Conform to ANSI B1.20.1 / ASME B16.22
- Conforms to NSF/ANSI-61, NSF/ANSI-372, IGC-157
- UL Listed 842,125 125 psig
- Certified to FM1140 600 psig 1/4" - 2" IPS, 1/2" - 2" SWT
- CSA Certified 1/2 psig / 5 psig / 125 psig 1/4" - 4"
- 600 psi WOG 150 psi WSP
- Temperature Range: -20°F to 300°F
- ISO:9001 Approved Manufacturer



| THREADED PART # | SWEAT PART # | SIZE | DESCRIPTION | INNER | MASTER |
|-----------------|--------------|--------|------------------------|-------|--------|
| L-610T012-NL | L-610C012-NL | 1/2" | Lock Handle Ball Valve | 10 | 100 |
| L-610T034-NL | L-610C034-NL | 3/4" | Lock Handle Ball Valve | 10 | 100 |
| L-610T001-NL | L-610C001-NL | 1" | Lock Handle Ball Valve | 5 | 50 |
| L-610T114-NL | L-610C114-NL | 1-1/4" | Lock Handle Ball Valve | 5 | 25 |
| L-610T112-NL | L-610C112-NL | 1-1/2" | Lock Handle Ball Valve | 5 | 25 |
| L-610T002-NL | L-610C002-NL | 2" | Lock Handle Ball Valve | 2 | 12 |
| L-610T212-NL | L-610C212-NL | 2-1/2" | Lock Handle Ball Valve | 2 | 8 |
| L-610T003-NL | L-610C003-NL | 3" | Lock Handle Ball Valve | 2 | 6 |
| L-610T004-NL | L-610C004-NL | 4" | Lock Handle Ball Valve | 2 | 4 |

405 Series Lead Free Brass Ball Valve with Drain



Purge Drain • CSA Approved • Lead Free • Full Port • 600 WOG



- Dezincification Resistant (DZR) Lead Free Brass Material
- Brass Drain Cap with EPDM Washer
- Forged Brass Body
- Stainless Steel Ball
- PTFE Seats and Seals
- Blow Out Proof Stem
- Ends Conform to ANSI B1.20.1 / ASME B16.22
- Conforms to NSF/ANSI-61/372, IGC-157
- 600 psi WOG 150 psi WSP Service
- Temperature Range: -20°F to 300°F
- CSA Certified
- ISO:9001 Approved Manufacturer



| THREADED PART # | SWEAT PART # | SIZE | DESCRIPTION | INNER | MASTER |
|-----------------|--------------|------|-----------------------|-------|--------|
| 405T012-NL | 405C012-NL | 1/2" | Ball Valve With Drain | 10 | 100 |
| 405T034-NL | 405C034-NL | 3/4" | Ball Valve With Drain | 10 | 100 |
| 405T001-NL | 405C001-NL | 1" | Ball Valve With Drain | 5 | 50 |

BALL VALVES

855 Series High-Grade T-Handle Ball Valve

RAVEN
SPECIALTY PRODUCTS

Stainless Steel T-Handle • CSA Certified • Lead Free • Full Port • 600 WOG



- Dezincification Resistant (DZR) Lead Free Brass Material
- Stainless Steel Ball
- PTFE Stem Packing Seal and Seats
- Blow Out Proof Bottom Loaded Stem
- Vinyl Grip T-Handle
- Stainless Steel Handle
- Ends Conform to ANSI B1.20.1 / ASME B16.22
- Conforms to NSF/ANSI-61, NSF/ANSI-372, IGC-157
- UL Listed
- CSA Certified
- ISO:9001 Approved Manufacturer

| THREADED PART # | SWEAT PART # | SIZE | DESCRIPTION | INNER | MASTER |
|-----------------|--------------|------|----------------------|-------|--------|
| 855T012-NL | 855C012-NL | 1/2" | Full Port Ball Valve | 10 | 100 |
| 855T034-NL | 855C034-NL | 3/4" | Full Port Ball Valve | 10 | 100 |

825 Series Ball Valve with Drain

RAVEN
SPECIALTY PRODUCTS

Purge Drain • CSA Certified • Lead Free • Full Port • 600 WOG



- Dezincification Resistant (DZR) Lead Free Brass Material
- Brass Drain Cap with EPDM Washer
- Forged Brass Body
- Stainless Steel Ball
- PTFE Seats and Seals
- Blow Out Proof Stem
- Vinyl Grip Lever Handle
- Ends Conform to ANSI B1.20.1 / ASME B16.22
- Conforms to NSF/ANSI-61/372, IGC-157
- 600 psi WOP 150 psi WSP Service
- Temperature Range: -20°F to 300°F
- CSA Certified
- ISO:9001 Approved Manufacturer



| THREADED PART # | SWEAT PART # | SIZE | DESCRIPTION | INNER | MASTER |
|-----------------|--------------|------|----------------------|-------|--------|
| 825T012-NL | 825C012-NL | 1/2" | Full Port Ball Valve | 10 | 100 |
| 825T034-NL | 825C034-NL | 3/4" | Full Port Ball Valve | 10 | 100 |
| 825T001-NL | - | 1" | Full Port Ball Valve | 5 | 50 |

BALL VALVES

Screwdriver Slotted Ball Valves

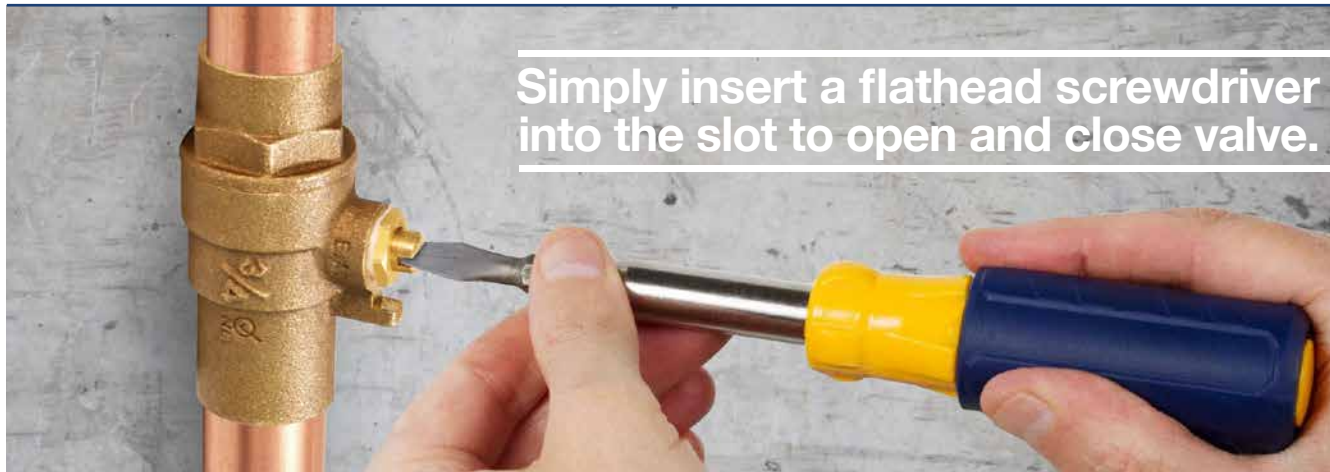

620 Series Ball Valve



Lead Free • Screwdriver Slotted Handle • Cast Brass Body •



- Dezincification Resistant (DZR) Lead Free Brass Material
- Screwdriver Slotted Handle
- Cast Brass Body
- Blow Out Proof Stem Design
- Stainless Steel Ball
- Conforms to NSF/ANSI 372
- Pressure Rating is 400 WOG Non Shock
- Temperature Rating is 250°F



| PART # | SIZE | DESCRIPTION | INNER | MASTER |
|------------|------|--------------------------------|-------|--------|
| 620S012-NL | 1/2" | Ball Valve W/Screw Driver Slot | 10 | 100 |
| 620S034-NL | 3/4" | Ball Valve W/Screw Driver Slot | 10 | 120 |
| 620S001-NL | 1" | Ball Valve W/Screw Driver Slot | 6 | 60 |

53 Series Long Bonnet Ball Valve



Lead Free • Standard Port • Forged Brass Body • T-Handle With Vinyl Grip



- Long Bonnet T-Handle allows easy shutoff access
- Forged Brass Body
- Chrome Plated Ball
- 175 psi Steam 600 psi WOG
- Temperature Range is -20°C to 120°C
- CSA Approved



| THREADED PART # | SWEAT PART # | SIZE | DESCRIPTION | INNER | MASTER |
|-----------------|--------------|------|------------------------|-------|--------|
| 53122-NL | 53121-NL | 1/2" | Long Bonnet Ball Valve | 10 | 100 |
| 53342-NL | 53341-NL | 3/4" | Long Bonnet Ball Valve | 10 | 100 |

Press Long Bonnet Ball Valve

| PRESS PART # | SIZE | DESCRIPTION | INNER | MASTER |
|--------------|------|------------------------------|-------|--------|
| 530R012-NL | 1/2" | Press Long Bonnet Ball Valve | 10 | 100 |
| 530R034-NL | 3/4" | Press Long Bonnet Ball Valve | 10 | 100 |

BALL VALVES

MIP x FIP Ball Valve

RAVEN
SPECIALTY PRODUCTS

Lead Free • Full Port • 600 WOG



IPS

- Dezincification Resistant (DZR) Lead Free Brass Material
- Brass Body
- Blow Out Proof Stem Design
- Packing Nut, O-Ring & PTFE Seal on the Seal
- Stainless Steel Ball
- Vinyl Grip Lever Handle
- Ends Conform to ANSI B1.20.1 / ASME B16.22
- CSA Certified to NSF/ANSI-61, NSF/ANSI-372, IGC-157
- Pressure Rating: 600 psi WOG 150 psi WSP
- Temperature range -20°F to 300°F
- ISO:9001 Approved Manufacturer

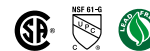

| PART # | SIZE | DESCRIPTION | INNER | MASTER |
|-------------|------|----------------------|-------|--------|
| 600MF012-NL | 1/2" | Full Port Ball Valve | 10 | 100 |
| 600MF034-NL | 3/4" | Full Port Ball Valve | 10 | 100 |
| 600MF001-NL | 1" | Full Port Ball Valve | 5 | 50 |

Hose Ball Valve with Cap

RAVEN
SPECIALTY PRODUCTS

Lead Free • Hose Connection • Includes Cap & Chain • Full Port • 600 WOG



IPS

- Dezincification Resistant (DZR) Lead Free Brass Material
- Cap and Seal for Easy Drain and Hose Connection
- Brass Body
- Blow Out Proof Stem Design
- Packing Nut, O-Ring & PTFE Seal on the Seal
- Stainless Steel Ball
- Vinyl Grip Lever Handle
- Ends Certified to ANSI B1.20.1 / ASME B16.22
- Press Ends conform to ANSI Z1157
- CSA Approved to NSF/ANSI-61, NSF/ANSI-372, IGC-157
- Pressure Rating: 600 psi WOG 150 psi WSP
- Temperature range -20°F to 300°F
- ISO:9001 Approved Manufacturer



| THREADED PART # | SWEAT PART # | SIZE | DESCRIPTION | INNER | MASTER |
|-----------------|--------------|------|----------------------|-------|--------|
| THBV-012-NL | CHBV-012-NL | 1/2" | Full Port Ball Valve | 10 | 100 |
| THBV-034-NL | CHBV-034-NL | 3/4" | Full Port Ball Valve | 10 | 100 |



SWT



PRESS

PRESS
CONNECT

Press x Hose Ball Valve with Cap

| PRESS PART # | SIZE | DESCRIPTION | INNER | MASTER |
|--------------|------|------------------|-------|--------|
| RHBV-012-NL | 1/2" | Press Ball Valve | 10 | 100 |
| RHBV-034-NL | 3/4" | Press Ball Valve | 10 | 100 |

BALL VALVES & ACCESSORIES



300 Series Premium Gas Ball Valve

UL & CSA Certified • Full Port • For Gas and Non Potable Water Use • 600 WOG



- Forged Brass Body
- Stainless Steel Ball
- PTFE Stem Packing Seal and Seats
- Blow Out Proof Stem Design
- Ends Conform to ANSI B1.20.1 / ASME B16.22
- Conforms to NSF/ANSI-61, NSF/ANSI-372, IGC-157
- UL Listed 842,125 125 psig
- Certified to FM1140 600 psig 1/4" - 2" IPS, 1/2" - 2" SWT
- CSA Certified 1/2 psig / 5 psig / 125 psig 1/4" - 4"
- 600 psi WOG 150 psi WSP
- Temperature Range : -20°F to 300°F
- ISO:9001 Approved Manufacturer



| THREADED PART # | SWEAT PART # | SIZE | DESCRIPTION | INNER | MASTER |
|-----------------|--------------|--------|----------------------|-------|--------|
| 300T012 | 300C012 | 1/2" | Full Port Ball Valve | 10 | 100 |
| 300T034 | 300C034 | 3/4" | Full Port Ball Valve | 10 | 100 |
| 300T001 | 300C001 | 1" | Full Port Ball Valve | 5 | 50 |
| 300T114 | 300C114 | 1-1/4" | Full Port Ball Valve | 5 | 25 |
| 300T112 | 300C112 | 1-1/2" | Full Port Ball Valve | 5 | 25 |
| 300T002 | 300C002 | 2" | Full Port Ball Valve | 2 | 12 |
| 300T212 | 300C212 | 2-1/2" | Full Port Ball Valve | 2 | 8 |
| 300T003 | 300C003 | 3" | Full Port Ball Valve | 1 | 6 |
| 300T004 | 300C004 | 4" | Full Port Ball Valve | 1 | 4 |

Ball Valve Stem Extension

Solid Brass • Easily Mounts on Ball Valve



- Easy Installation
- Extends Handle Stem for Easy Shutoff Access

| PART # | SIZE | DESCRIPTION | INNER | MASTER |
|----------|------------------|---------------------------|-------|--------|
| STEX1-NL | 1/4" 3/8" 1/2" | Ball Valve Stem Extension | 1 | 100 |
| STEX2-NL | 3/4" X 1" | Ball Valve Stem Extension | 1 | 100 |
| STEX3-NL | 1-1/4" 1-1/2" 2" | Ball Valve Stem Extension | 1 | 100 |

Stainless Steel Handle w/ Washer & Nut

Stainless Steel with Vinyl Grip Handle



- Stainless Steel Construction
- Vinyl Grip Lever Handle
- Includes Washer and Nut

| PART # | SIZE | DESCRIPTION | INNER | MASTER |
|-------------|--------|------------------------|-------|--------|
| 610HANSS034 | 3/4" | Stainless Steel Handle | 5 | 50 |
| 610HANSS001 | 1" | Stainless Steel Handle | 5 | 40 |
| 610HANSS114 | 1-1/4" | Stainless Steel Handle | 4 | 20 |

COMPRESSION BALL VALVES

600M Series Compression Ball Valve



CSA Approved • Lead Free • Compression Connection • Full Port • Vinyl Grip Handle • 600 WOG



600M001-NL

- Dezincification Resistant (DZR) Lead Free Brass Material
- Compression Connection
- Forged Brass Body
- Stainless Steel Ball
- Blow Out Proof Stem
- CSA approved Per NSF/ANSI-61, NSF/ANSI-372, IGC-157
- 600 psi (WOG) 150 psi (WSP) Service
- Temperature Range : -20°F to 300°F
- ISO:9001 Approved Manufacturer

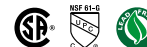

| PART # | SIZE | DESCRIPTION | INNER | MASTER |
|------------|------|-----------------------------|-------|--------|
| 600M012-NL | 1/2" | 1/2" Compression Ball Valve | 10 | 100 |
| 600M034-NL | 3/4" | 3/4" Compression Ball Valve | 10 | 100 |
| 600M001-NL | 1" | 1" Compression Ball Valve | 5 | 50 |

825M Series Compression Ball Valve with Drain



CSA Approved • Lead Free • Compression Connection • Full Port • Vinyl Grip Handle • 600 WOG



825M034-NL

- Dezincification Resistant (DZR) Lead Free Brass Material
- Compression Connection
- Forged Brass Body
- Stainless Steel Ball
- Blow Out Proof Stem
- CSA approved Per NSF/ANSI-61, NSF/ANSI-372, IGC-157
- 600 psi (WOG) 150 psi (WSP) Service
- Temperature Range : -20°F to 300°F



| PART # | SIZE | DESCRIPTION | INNER | MASTER |
|------------|------|-----------------------------|-------|--------|
| 825M012-NL | 1/2" | 1/2" Compression Ball Valve | 10 | 100 |
| 825M034-NL | 3/4" | 3/4" Compression Ball Valve | 10 | 100 |
| 825M001-NL | 1" | 1" Compression Ball Valve | 5 | 50 |

Compression Coupling Short

Lead Free • Brass

- Brass Body
- 3" Length - Short Pattern
- Brass Packing Nut



| PART # | SIZE | DESCRIPTION | INNER | MASTER |
|-------------|--------|----------------------|-------|--------|
| BRCS0012-NL | 1/2" | Compression Coupling | 10 | 100 |
| BRCS0034-NL | 3/4" | Compression Coupling | 12 | 120 |
| BRCS0100-NL | 1" | Compression Coupling | 12 | 96 |
| BRCS0114-NL | 1-1/4" | Compression Coupling | 12 | 96 |
| BRCS0112-NL | 1-1/2" | Compression Coupling | 12 | 48 |
| BRCS0200-NL | 2" | Compression Coupling | 1 | 1 |

Compression Coupling long

Lead Free • Brass

- Brass Body
- 5" Length - Long Pattern
- Brass Packing Nut



| PART # | SIZE | DESCRIPTION | INNER | MASTER |
|-------------|--------|----------------------|-------|--------|
| BRCL0012-NL | 1/2" | Compression Coupling | 24 | 144 |
| BRCL0034-NL | 3/4" | Compression Coupling | 12 | 72 |
| BRCL0100-NL | 1" | Compression Coupling | 12 | 48 |
| BRCL0114-NL | 1-1/4" | Compression Coupling | 12 | 48 |
| BRCL0112-NL | 1-1/2" | Compression Coupling | 12 | 48 |
| BRCL0200-NL | 2" | Compression Coupling | 12 | 24 |

Gas Ball Valves

UL/CSA Approved

Flextron gas ball valves are specially engineered to provide superior performance and reliability. For use with natural, manufactured, mixed liquefied petroleum gases and LP gas-air mixtures.

- Forged Brass Body
- Stainless Steel Ball
- Aluminum Alloy Handle
- Ends conforms to: ANSI B1.20.1
- 600 psi WOG 175 psi WSP
- Temperature Range : -4° F to 149° F
- CSA Approved: ANSI Z21.15/CSA 9.1(1/2psi)
ASME B16.44 / CR91-002 (5psi)
ASME B16.33 / CGA3.16 (175psi)
- UL Listed per: UL 125 (Guide YSDT) 125 WOG



FIP x FIP Gas Ball Valve



| PART # | SIZE | DESCRIPTION | INNER | MASTER |
|--------------------|-------------|--------------------------|-------|--------|
| FTGV-38F38F | 5/8" x 1/2" | FIP x FIP Gas Ball Valve | 10 | 100 |
| FTGV-12F12F | 1/2" x 1/2" | FIP x FIP Gas Ball Valve | 10 | 100 |
| FTGV-34F34F | 3/4" x 3/4" | FIP x FIP Gas Ball Valve | 5 | 100 |
| FTGV-01F01F | 1" x 1" | FIP x FIP Gas Ball Valve | 8 | 60 |

Flare x FIP Gas Ball Valve



| PART # | SIZE | DESCRIPTION | INNER | MASTER |
|--------------------|-------------|----------------------------|-------|--------|
| FTGV-58R12F | 5/8" x 1/2" | Flare x FIP Gas Ball Valve | 10 | 120 |
| FTGV-58R34F | 5/8" x 3/4" | Flare x FIP Gas Ball Valve | 10 | 120 |
| FTGV-12R12F | 1/2" x 1/2" | Flare x FIP Gas Ball Valve | 10 | 120 |
| FTGV-38R12F | 3/8" x 1/2" | Flare x FIP Gas Ball Valve | 5 | 50 |

Angle Gas Ball Valve



| PART # | SIZE | DESCRIPTION | INNER | MASTER |
|--------------------|-------------|-----------------------------|-------|--------|
| FTGV-58R34A | 5/8" x 3/4" | Flare x FIP Angle Gas Valve | 10 | 120 |
| FTGV-12R12A | 1/2" x 1/2" | Flare x FIP Angle Gas Valve | 10 | 120 |
| FTGV-38R12A | 3/8" x 1/2" | Flare x FIP Angle Gas Valve | 10 | 120 |

Flare x Flare Gas Ball Valve



| PART # | SIZE | DESCRIPTION | INNER | MASTER |
|--------------------|-------------|------------------------------|-------|--------|
| FTGV-38R38R | 3/8" x 3/8" | Flare x Flare Gas Ball Valve | 10 | 120 |
| FTGV-12R12R | 1/2" x 1/2" | Flare x Flare Gas Ball Valve | 10 | 120 |

Lever Handle Gas Ball Valve



- Solder Ends
- Forged Brass Body
- Chrome Plated Ball



| PART # | SIZE | DESCRIPTION | INNER | MASTER |
|--------------------|-----------------|---------------------|-------|--------|
| FTGV-14F14F | 1-1/4" x 1-1/4" | FIP x FIP Gas Valve | 12 | 24 |
| FTGV-15F15F | 1-1/2" x 1-1/2" | FIP x FIP Gas Valve | 9 | 18 |
| FTGV-02F02F | 2" x 2" | FIP x FIP Gas Valve | 6 | 12 |

GAS BALL VALVES

45 Series FIP Gas Ball Valve



FIP x FIP • Forged Brass Body



- Forged Brass Body
- Stainless Steel Ball
- Blow Out Proof Brass Stem
- Aluminum Alloy Handle
- Thread Ends Conform to: ANSI B1.20.1
- 600 psi WOG 175 psi WSP
- Temperature Range : -4°F to 149°F
- CSA Approved Per: ANSI Z21.15 / CSA 9.1(1/2psi)
ASME B16.44 / CR91-002 (5psi)
ASME B16.33 / CGA3.16 (175psi)
- UL Listed per: UL 125 (Guide YSDT) 125 WOG



| PART # | SIZE | DESCRIPTION | INNER | MASTER |
|--------|------|----------------|-------|--------|
| 4512 | 1/2" | Gas Ball Valve | 10 | 120 |
| 4534 | 3/4" | Gas Ball Valve | 10 | 120 |
| 4501T | 1" | Gas Ball Valve | 5 | 50 |

45Y Series FIP Gas Ball Valve



FIP x FIP • Forged Brass Body



- Forged Brass Body
- Stainless Steel Ball
- Blow Out Proof Brass Stem
- Aluminum Alloy Yellow Handle
- Thread Ends Conform to: ANSI B1.20.1
- 600 psi WOG 175 psi WSP
- Temperature Range : -4°F to 149°F
- CSA Approved Per: ANSI Z21.15 / CSA 9.1(1/2psi)
ASME B16.44 / CR91-002 (5psi)
ASME B16.33 / CGA3.16 (175psi)
- UL Listed per: UL 125 (Guide YSDT) 125 WOG



| PART # | SIZE | DESCRIPTION | INNER | MASTER |
|--------|------|----------------|-------|--------|
| 4512Y | 1/2" | Gas Ball Valve | 10 | 120 |
| 4534Y | 3/4" | Gas Ball Valve | 10 | 120 |
| 4501T | 1" | Gas Ball Valve | 5 | 50 |

OP45 One Piece Gas Ball Valve



CSA Approved • Female NPT x Female NPT • Brass Body



- Brass Body
- Plated Steel Handle
- PTFE Ball Seats
- Blow Out Proof Brass Stem
- Thread Ends Conform ANSI B1.20.1
- Pressure Rating: 125 psi (GAS) Service
- Temperature Range: -4°F to 149°F
- CSA Approved: ANSI Z21.15/CSA 9.1 for 1/2 psig
ASME B16.44/CR91-002 for 5 psig
ASME B16.33/CGA3.16 for 125 psig



| PART # | SIZE | DESCRIPTION | INNER | MASTER |
|--------|------|----------------|-------|--------|
| OP4512 | 1/2" | Gas Ball Valve | 10 | 120 |
| OP4534 | 3/4" | Gas Ball Valve | 10 | 120 |
| OP4501 | 1" | Gas Ball Valve | 5 | 50 |

S45 Gas Ball Valve w/Screwdriver Slot



CSA & UL Approved • Female NPT x Female NPT • Brass Body



- Brass Body
- Plated Steel Handle
- PTFE Ball Seats
- Blow Out Proof Brass Stem
- Thread Ends Conform ANSI B1.20.1
- Pressure Rating: 125 psi (GAS) Service
- Temperature Range: -4°F to 149°F
- UL Approved 1/2" - 3/4" 125 psig
- CSA Approved: ANSI Z21.15/CSA 9.1 for 1/2 psig
ASME B16.44/CR91-002 for 5 psig
ASME B16.33/CGA3.16 for 125 psig



| PART # | SIZE | DESCRIPTION | INNER | MASTER |
|--------|------|----------------|-------|--------|
| S4512 | 1/2" | Gas Ball Valve | 10 | 120 |
| S4534 | 3/4" | Gas Ball Valve | 10 | 120 |
| S4501 | 1" | Gas Ball Valve | 5 | 50 |



Press Forward.





310R Series Premium Press Ball Valve

Double-O-Ring • Press Ends • Lead Free • 600 WOG

The 310 Series Premium Press Ball Valve is designed to use in press-fit piping systems, eliminating labor and potential fire hazard associated with solder connections. It features Double O-Ring press connections for added leak protection and safety. DZR brass body provides increased durability. Stainless steel ball and PTFE seats creates a positive seal reducing friction and minimizing wear.



- Available 1/2" to 4"
- Pressure Rating: 250 CWP / 150 WSP
- Max Temp: 300°F
- DZR Brass Body
- 304 Stainless Steel Ball
- Lead Free Compliant
- Conforms to NSF/ANSI 61, 372

310R SERIES SPECIFICATIONS

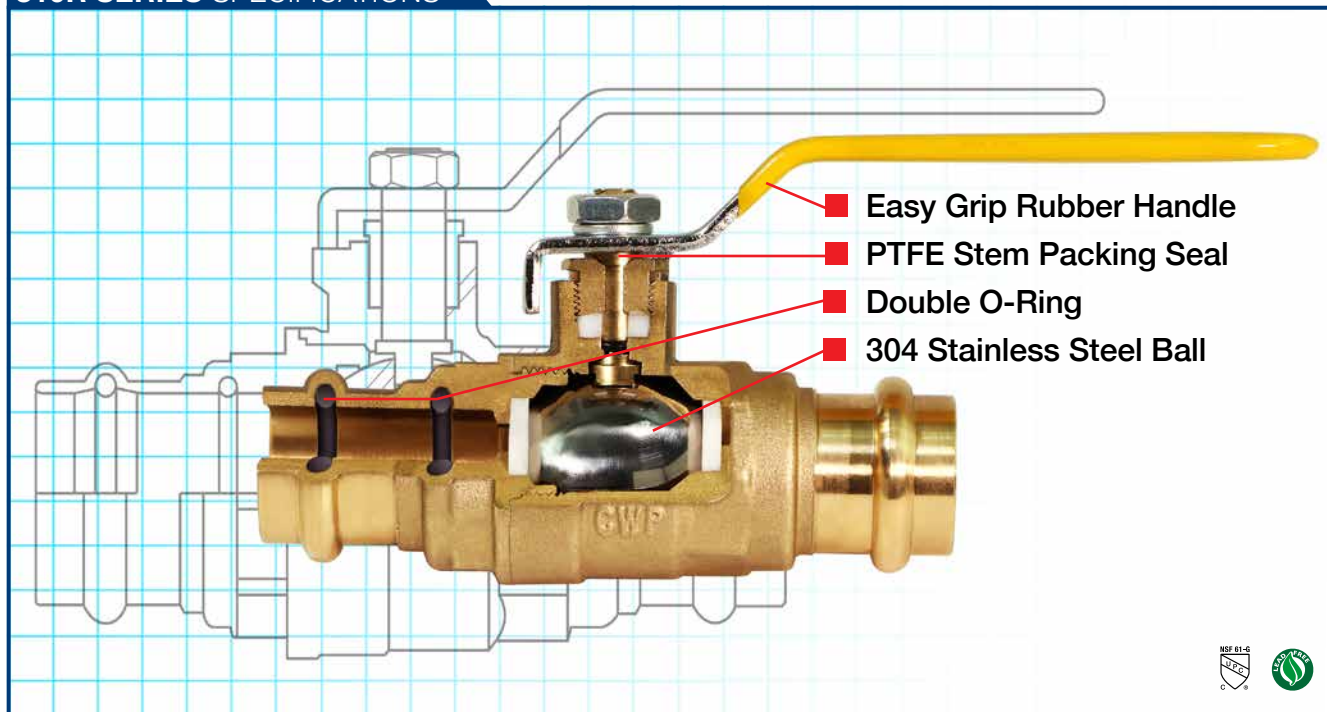

PRESS BALL VALVES



310R Series Premium Press Ball Valve

Double-O-Ring • Press Connections • Lead Free • Full Port • 600 WOG



310R034-NL

- Dezincification Resistant (DZR) Lead Free Brass Material
- Double O-Ring for Added Leak Protection
- Forged Brass Body
- Stainless Steel Ball
- Blow Out Proof Brass Stem
- Vinyl Grip Lever Handle
- Triple Sealing Stem with 2 O-Rings and PTFE Seal
- Max Pressure Rating: 600 psi WOG / 150 psi WSP
- Temperature Range: -20°F to 300°F
- UPC Compliant
- AB1953, NSF61-9, NSF-372, ISO-9002



| PART # | SIZE | DESCRIPTION | INNER | MASTER |
|-------------------|--------|----------------------------|-------|--------|
| 310R012-NL | 1/2" | Full Port Press Ball Valve | 5 | 50 |
| 310R034-NL | 3/4" | Full Port Press Ball Valve | 5 | 40 |
| 310R001-NL | 1" | Full Port Press Ball Valve | 4 | 20 |
| 310R114-NL | 1-1/4" | Full Port Press Ball Valve | 5 | 20 |
| 310R112-NL | 1-1/2" | Full Port Press Ball Valve | 4 | 16 |
| 310R002-NL | 2" | Full Port Press Ball Valve | 2 | 8 |
| 310R003-NL | 3" | Full Port Press Ball Valve | 1 | 4 |
| 310R004-NL | 4" | Full Port Press Ball Valve | 1 | 2 |

810R Series Press Ball Valve



Press Connections • Lead Free • Full Port • 600 WOG



810R003-NL

- Dezincification Resistant (DZR) Lead Free Brass Material
- Forged Brass Body
- Stainless Steel Ball
- Blow Out Proof Brass Stem
- Vinyl Grip Lever Handle
- Triple Sealing Stem with 2 O-Rings and PTFE Seal
- Max Pressure Rating: 600 psi WOG / 150 psi WSP
- Temperature Range: -20°F to 300°F
- UPC Compliant
- AB195, NSF61-9, NSF-372, ISO-9002



| PART # | SIZE | DESCRIPTION | INNER | MASTER |
|-------------------|--------|----------------------------|-------|--------|
| 810R012-NL | 1/2" | Full Port Press Ball Valve | 5 | 50 |
| 810R034-NL | 3/4" | Full Port Press Ball Valve | 5 | 40 |
| 810R001-NL | 1" | Full Port Press Ball Valve | 4 | 20 |
| 810R114-NL | 1-1/4" | Full Port Press Ball Valve | 5 | 20 |
| 810R112-NL | 1-1/2" | Full Port Press Ball Valve | 4 | 16 |
| 810R002-NL | 2" | Full Port Press Ball Valve | 2 | 8 |
| 810R003-NL | 3" | Full Port Press Ball Valve | 1 | 4 |
| 810R004-NL | 4" | Full Port Press Ball Valve | 1 | 2 |

PRESS BALL VALVES

310D Series Press Ball Valve with Drain

RAVEN
SPECIALTY PRODUCTS

Press Connections • Lead Free • Full Port with Drain • 250 CWP

PRESS
CONNECT



- Dezincification Resistant (DZR) Lead Free Brass Material
- Blow Out Proof Brass Stem
- Packing Nut, O-ring & Packing on the Stem Seal
- Max Pressure Rating: 250 CWP / 150 WSP
- Temperature Range: -20°F to 300°F
- IAPMO: NSF/ANSI-61, NSF/ANSI-372, IGC-157
- Press Ends conform to ANSI Z1157



| PART # | SIZE | DESCRIPTION | INNER | MASTER |
|------------|------|-----------------------------|-------|--------|
| 310D012-NL | 1/2" | Press Ball Valve with Waste | 5 | 50 |
| 310D034-NL | 3/4" | Press Ball Valve with Waste | 5 | 40 |
| 310D001-NL | 1" | Press Ball Valve with Waste | 4 | 20 |

320 Series Press Adapter Ball Valve

RAVEN
SPECIALTY PRODUCTS

Press x MIP & Press x FIP • Lead Free • Full Port • Forged Brass Body • 250 CWP

PRESS
CONNECT



- Dezincification Resistant (DZR) Lead Free Brass Material
- Blow Out Proof Brass Stem
- Packing Nut, O-Ring & Packing on the Stem Seal
- Max Pressure Rating: 250 CWP / 150 WSP
- Temperature Range: -20°F to 300°F
- Approved to: NSF/ANSI 61, NSF/ANSI 372, IGC157
- Press Ends conform to ANSI Z1157



320M Series Press x MIP Ball Valve

| PART # | SIZE | DESCRIPTION | INNER | MASTER |
|------------|--------|------------------------|-------|--------|
| 320M112-NL | 1/2" | Press x MIP Ball Valve | 5 | 50 |
| 320M034-NL | 3/4" | Press x MIP Ball Valve | 5 | 40 |
| 320M001-NL | 1" | Press x MIP Ball Valve | 4 | 20 |
| 320M114-NL | 1-1/4" | Press x MIP Ball Valve | 5 | 20 |
| 320M112-NL | 1-1/2" | Press x MIP Ball Valve | 4 | 16 |
| 320M002-NL | 2" | Press x MIP Ball Valve | 2 | 8 |

PRESS
CONNECT



320T Series Press x FIP Ball Valve

| PART # | SIZE | DESCRIPTION | INNER | MASTER |
|------------|--------|------------------------|-------|--------|
| 320T112-NL | 1/2" | Press x FIP Ball Valve | 5 | 50 |
| 320T034-NL | 3/4" | Press x FIP Ball Valve | 5 | 40 |
| 320T001-NL | 1" | Press x FIP Ball Valve | 4 | 20 |
| 320T114-NL | 1-1/4" | Press x FIP Ball Valve | 5 | 20 |
| 320T112-NL | 1-1/2" | Press x FIP Ball Valve | 4 | 16 |
| 320T002-NL | 2" | Press x FIP Ball Valve | 2 | 8 |



Please see the entire line of Press products in our catalog or visit us online at everflowsupplies.com



PRESS BALL VALVES



315R Series Premium Press T-Handle Ball Valve

Double-O-Ring • Press Connections • Lead Free • Full Port • 600 WOG



PRESS
CONNECT



- Dezincification Resistant (DZR) Lead Free Brass Material
- Double O-Ring for Added Leak Protection
- Forged Brass Body
- Stainless Steel Ball
- Blow Out Proof Brass Stem
- Vinyl Grip Lever Handle
- Triple Sealing Stem with 2 O-Rings and PTFE Seal
- Max Pressure Rating: 600 psi WOG / 150 psi WSP
- Temperature Range: -20°F to 300°F
- UPC Compliant
- AB1953, NSF61-9, NSF-372, ISO-9002



| PART # | SIZE | DESCRIPTION | INNER | MASTER |
|------------|------|-------------------------------------|-------|--------|
| 315R012-NL | 1/2" | T-Handle Full Port Press Ball Valve | 5 | 50 |
| 315R034-NL | 3/4" | T-Handle Full Port Press Ball Valve | 5 | 40 |
| 315R001-NL | 1" | T-Handle Full Port Press Ball Valve | 4 | 20 |

PRBL Series F1807 Pex X Press Ball Valve

RAVEN
SPECIALTY PRODUCTS

F1807 Pex X Press Connections • Lead Free

F1807
CRIMP PEX



- Dezincification Resistant (DZR) Lead Free Brass Material
- Blow Out Proof Brass Stem
- Packing Nut, O-ring & Packing on the Stem Seal
- Max Pressure Rating: 250 CWP / 150 WSP
- Temperature Range: -20°F to 300°F
- IAPMO: NSF/ANSI-61, NSF/ANSI-372, IGC-157
- Press Ends conform to ANSI Z1157
- Pex Ends Conform to ASTM F1807



| PART # | SIZE | DESCRIPTION | INNER | MASTER |
|-------------|------|------------------------------|-------|--------|
| PRBL-012-NL | 1/2" | F1807 PEX x Press Ball Valve | 5 | 50 |
| PRBL-034-NL | 3/4" | F1807 PEX x Press Ball Valve | 5 | 40 |
| PRBL-001-NL | 1" | F1807 PEX x Press Ball Valve | 4 | 20 |

FRBL Series F1960 Pex X Press Ball Valve

RAVEN
SPECIALTY PRODUCTS

F1960 Pex X Press Connections • Lead Free

F1960
EXPANSION PEX



- Dezincification Resistant (DZR) Lead Free Brass Material
- Blow Out Proof Brass Stem
- Packing Nut, O-ring & Packing on the Stem Seal
- Max Pressure Rating: 250 CWP / 150 WSP
- Temperature Range: -20°F to 300°F
- IAPMO: NSF/ANSI-61, NSF/ANSI-372, IGC-157
- Press Ends conform to ANSI Z1157



| PART # | SIZE | DESCRIPTION | INNER | MASTER |
|-------------|------|------------------------------|-------|--------|
| FRBL-012-NL | 1/2" | F1960 PEX x Press Ball Valve | 5 | 50 |
| FRBL-034-NL | 3/4" | F1960 PEX x Press Ball Valve | 5 | 40 |
| FRBL-001-NL | 1" | F1960 PEX x Press Ball Valve | 4 | 20 |

PUSH-FIT BALL VALVES

Push-Fit Ball Valve



Lead Free • Full Port • Forged Brass Body •



- Dezincification Resistant (DZR) Lead Free Brass Material
- Full Port Ball Valve Design
- Single Lever Heavy Duty Rust Resistant Handle with Vinyl Grip
- EPDM O-Ring for Leak free seals
- Connects PEX, CPVC or Copper Pipe in any Installation
- Quick and Easy, Removable and Re-Usable Installation
- Certified to 200 PSI WOG and 200° F
- Certified by UPC/IAMPO to Meet Lead Free Potable Water Laws
- ANSI/NSF-61-G Compliant
- AWWA C800 Compliant
- Meets ASME B1.20.1 ASSE 1061
- ISO:9001 Approved Manufacturer

CONNECTS TO
 PEX
 CPVC
 COPPER



Stainless Steel Gripper
 EPDM Rubber O-Ring
 Plastic Release Collar
 Forged Brass Material



Push x Push 1/4 Turn Ball Valve



Lead Free • Full Port • Forged Brass Body



| PART # | SIZE | DESCRIPTION | INNER | MASTER |
|--------|------|-----------------|-------|--------|
| UPBV12 | 1/2" | Push Ball Valve | 5 | 50 |
| UPBV34 | 3/4" | Push Ball Valve | 5 | 40 |
| UPBV1 | 1" | Push Ball Valve | 4 | 20 |

Pex x FIP 1/4 Turn Ball Valve



Lead Free • Full Port • Forged Brass Body



| PART # | SIZE | DESCRIPTION | INNER | MASTER |
|---------|------|-----------------------|-------|--------|
| UPBVF12 | 1/2" | Push x FIP Ball Valve | 5 | 50 |
| UPBVF34 | 3/4" | Push x FIP Ball Valve | 5 | 40 |
| UPBVF1 | 1" | Push x FIP Ball Valve | 4 | 20 |

Please see the entire line of Push Fittings in our catalog or visit us online at everflowsupplies.com/pushlock



F1807 PEX BALL VALVES



600P Series F1807 Pex Valve

CSA Approved • Lead Free • Full Port • 600 WOG

ASTM
F1807
CRIMP PEX



- Dezincification Resistant (DZR) Lead Free Brass Material
- Pex Ends Conform to ASTM F1807
- Blow Out Proof Stem Design
- Stainless Steel Ball
- Vinyl Grip Lever Handle
- 600 psi (WOG) 150 psi (WSP) Service
- Temperature Range : -20°F to 300°F



| PART # | SIZE | DESCRIPTION | INNER | MASTER |
|------------|--------|----------------|-------|--------|
| 600P012-NL | 1/2" | Pex Ball Valve | 10 | 100 |
| 600P034-NL | 3/4" | Pex Ball Valve | 10 | 100 |
| 600P001-NL | 1" | Pex Ball Valve | 5 | 50 |
| 600P114-NL | 1-1/4" | Pex Ball Valve | 5 | 25 |
| 600P112-NL | 1-1/2" | Pex Ball Valve | 5 | 25 |
| 600P002-NL | 2" | Pex Ball Valve | 2 | 12 |

615P Series T-Handle F1807 Pex Ball Valve

T-Handle with Vinyl Grip • CSA Approved • Lead Free • Full Port • 600 WOG

ASTM
F1807
CRIMP PEX



- Dezincification Resistant (DZR) Lead Free Brass Material
- Blow Out Proof Stem Design
- Stainless Steel Ball
- Pex Ends Conform to ASTM F1807
- 600 psi WOG 150 psi WSP
- Temp Range : -20°F to 300°F
- CSA Approved 3/8" - 2"
- Conforms to NSF/ANSI-61,372, NSF/ANSI-14 , IGC-157
- ISO:9001 Approved Manufacturer



| PART # | SIZE | DESCRIPTION | INNER | MASTER |
|------------|------|-------------------------|-------|--------|
| 615P012-NL | 1/2" | Pex T-Handle Ball Valve | 10 | 100 |
| 615P034-NL | 3/4" | Pex T-Handle Ball Valve | 10 | 100 |
| 615P001-NL | 1" | Pex T-Handle Ball Valve | 5 | 50 |

405P Series F1807 Pex Ball Valve with Drain

Purge Drain • CSA Approved • Lead Free • Full Port • 600 WOG

ASTM
F1807
CRIMP PEX



- Dezincification Resistant (DZR) Lead Free Brass Material
- Blow Out Proof Stem Design
- Stainless Steel Ball
- Pex Ends Conform to ASTM F1807
- 600 psi (WOG) 150 psi (WSP) Service
- Temperature Range : -20°F to 300°F



| PART # | SIZE | DESCRIPTION | INNER | MASTER |
|------------|------|-------------------------|-------|--------|
| 405P012-NL | 1/2" | Pex Ball Valve w/ Drain | 10 | 100 |
| 405P034-NL | 3/4" | Pex Ball Valve w/ Drain | 10 | 100 |
| 405P001-NL | 1" | Pex Ball Valve w/ Drain | 5 | 50 |

F1807 PEX BALL VALVES



G-600P Series F1807 Pex Ball Valve

Lead Free • Full Port • 400 WOG

ASTM
F1807
CRIMP PEX



- Dezincification Resistant (DZR) Lead Free Brass Material
- Blow Out Proof Stem Design
- Stainless Steel Ball
- PTFE Seats
- Vinyl Grip Lever Handle
- Pex Ends Conform to ASTM F1807
- Pressure Rating: 400PSI
- Complies with IGC157
- Meets NSF/ANSI 61-8



| PART # | SIZE | DESCRIPTION | INNER | MASTER |
|--------------|------|----------------|-------|--------|
| G-600P012-NL | 1/2" | Pex Ball Valve | 10 | 100 |
| G-600P034-NL | 3/4" | Pex Ball Valve | 10 | 100 |
| G-600P001-NL | 1" | Pex Ball Valve | 5 | 50 |

G-615P Series T-Handle F1807 Pex Ball Valve

T-Handle • Lead Free • Full Port • 400 WOG

ASTM
F1807
CRIMP PEX



- Dezincification Resistant (DZR) Lead Free Brass Material
- Blow Out Proof Stem Design
- Stainless Steel Ball
- PTFE Seats
- Pex Ends Conform to ASTM F1807
- Pressure Rating: 400 psi WOG
- Complies with IGC157
- Meets NSF/ANSI 61-8



| PART # | SIZE | DESCRIPTION | INNER | MASTER |
|--------------|------|----------------------------|-------|--------|
| G-615P012-NL | 1/2" | Pex Ball Valve w/ T-Handle | 10 | 100 |
| G-615P034-NL | 3/4" | Pex Ball Valve w/ T-Handle | 10 | 100 |
| G-615P001-NL | 1" | Pex Ball Valve w/ T-Handle | 5 | 50 |

PMBV Series F1807 Pex X MIP Ball Valve

T-Handle With Vinyl Grip • Lead Free • 600 WOG

ASTM
F1807
CRIMP PEX



- Dezincification Resistant (DZR) Lead Free Brass Material
- Blow Out Proof Stem Design
- Stainless Steel Ball
- Pex Ends Conform to ASTM F1807
- Vinyl Grip T-Handle
- 600 psi (WOG) 150 psi (WSP) Service
- Temperature Range : -20°F to 300°F



| PART # | SIZE | DESCRIPTION | INNER | MASTER |
|-------------|------|----------------------|-------|--------|
| PMBV-012-NL | 1/2" | Pex X MIP Ball Valve | 10 | 100 |
| PMBV-034-NL | 3/4" | Pex X MIP Ball Valve | 10 | 100 |

F1807 PEX BALL VALVES



PSBL Series F1807 Pex X SWT Ball Valve

Lead Free • Vinyl Grip Handle • 600 WOG

ASTM
F1807
CRIMP PEX



- Dezincification Resistant (DZR) Lead Free Brass Material
- Forged Brass Body
- Blow Out Proof Stem Design
- Stainless Steel Ball
- Pex Ends Conform to ASTM F1807
- Solder-Joint conform ASME B16.22
- 600 psi WOG 150 psi WSP Service
- Temperature Range : -20°F to 300°F
- Conforms to NSF/ANSI-61, NSF/ANSI-372 , NSF/ANSI-14



| PART # | SIZE | DESCRIPTION | INNER | MASTER |
|-------------|------|----------------------|-------|--------|
| PSBL-012-NL | 1/2" | Pex X SWT Ball Valve | 10 | 100 |
| PSBL-034-NL | 3/4" | Pex X SWT Ball Valve | 10 | 100 |
| PSBL-001-NL | 1" | Pex X SWT Ball Valve | 10 | 100 |

PSBV Series F1807 Pex X SWT T-Handle Ball Valve

T-Handle With Vinyl Grip • Lead Free • 600 WOG

ASTM
F1807
CRIMP PEX



- Dezincification Resistant (DZR) Lead Free Brass Material
- Blow Out Proof Stem
- Stainless Steel Ball
- 600 psi WOG 150 psi WSP
- Temperature Range : -20°F to 300°F
- Pex Ends Conform to ASTM F1807
- Sweat end conforms to ASME B16.22
- Conforms to NSF/ANSI-61, NSF/ANSI-372, NSF/ANSI-14
- CSA Approved
- ISO:9001 Approved Manufacturer



| PART # | SIZE | DESCRIPTION | INNER | MASTER |
|-------------|------|-------------------------------|-------|--------|
| PSBV-012-NL | 1/2" | Pex X SWT T-Handle Ball Valve | 10 | 100 |
| PSBV-034-NL | 3/4" | Pex X SWT T-Handle Ball Valve | 10 | 100 |

848PS Series Pex X SWT T-Handle Ball Valve with Drain

RAVEN
SPECIALTY PRODUCTS

Purge Drain • T-Handle With Vinyl Grip • Lead Free • 600 WOG

ASTM
F1807
CRIMP PEX



- Dezincification Resistant (DZR) Lead Free Brass Material
- Blow Out Proof Stem Design
- Stainless Steel Ball
- Pex Ends Conform to ASTM F1807
- Vinyl Grip T-Handle
- 600 psi (WOG) 150 psi (WSP) Service
- Temperature Range : -20°F to 300°F



| PART # | SIZE | DESCRIPTION | INNER | MASTER |
|-------------|------|-------------------------------|-------|--------|
| 848PS012-NL | 1/2" | Pex X SWT Ball Valve w/ Drain | 10 | 100 |

F1807 PEX BALL VALVES

800P Series F1807 Pex Ball Valve

RAVEN
SPECIALTY PRODUCTS

CSA Approved • Lead Free • Full Port • 600 WOG

ASTM
F1807
CRIMP PEX



- Dezincification Resistant (DZR) Lead Free Brass Material
- Pex Ends Conform to ASTM F1807
- Blow Out Proof Stem Design
- Stainless Steel Ball
- Vinyl Grip Lever Handle
- 600 psi (WOG) 150 psi (WSP) Service
- Temperature Range : -20° F to 300°F



| PART # | SIZE | DESCRIPTION | INNER | MASTER |
|------------|------|----------------|-------|--------|
| 800P012-NL | 1/2" | Pex Ball Valve | 10 | 100 |
| 800P034-NL | 3/4" | Pex Ball Valve | 10 | 100 |
| 800P001-NL | 1" | Pex Ball Valve | 5 | 50 |

800PT Series F1807 Pex T-Handle Ball Valve

RAVEN
SPECIALTY PRODUCTS

T-Handle with Vinyl Grip • CSA Approved • Lead Free • Full Port • 600 WOG

ASTM
F1807
CRIMP PEX



- Dezincification Resistant (DZR) Lead Free Brass Material
- Blow Out Proof Stem Design
- Stainless Steel Ball
- Pex Ends Conform to ASTM F1807
- Vinyl Grip T-Handle
- 600 psi (WOG) 150 psi (WSP) Service
- Temperature Range : -20°F to 300°F



| PART # | SIZE | DESCRIPTION | INNER | MASTER |
|-------------|------|-------------------------|-------|--------|
| 800P012T-NL | 1/2" | Pex T-Handle Ball Valve | 10 | 100 |
| 800P034T-NL | 3/4" | Pex T-Handle Ball Valve | 10 | 100 |
| 800P001T-NL | 1" | Pex T-Handle Ball Valve | 5 | 50 |

825P Series F1807 Pex Ball Valve with Drain

RAVEN
SPECIALTY PRODUCTS

Purge Drain • CSA Approved • Lead Free • Full Port • 600 WOG

ASTM
F1807
CRIMP PEX



- Dezincification Resistant (DZR) Lead Free Brass Material
- Blow Out Proof Stem Design
- Stainless Steel Ball
- Pex Ends Conform to ASTM F1807
- Vinyl Grip Lever Handle
- 600 psi (WOG) 150 psi (WSP) Service
- Temperature Range : -20° F to 300°F



| PART # | SIZE | DESCRIPTION | INNER | MASTER |
|------------|------|-------------------------|-------|--------|
| 825P012-NL | 1/2" | Pex Ball Valve w/ Drain | 10 | 100 |
| 825P034-NL | 3/4" | Pex Ball Valve w/ Drain | 10 | 100 |
| 825P001-NL | 1" | Pex Ball Valve w/ Drain | 5 | 50 |

F1807 & F1960 PEX BALL VALVES

806P Series F1807 Pex Drop Ear Ball Valve

RAVEN
SPECIALTY PRODUCTS

Solid Brass Drop Ears • Lead Free • 600 WOG

ASTM
F1807
CRIMP PEX



- Dezincification Resistant (DZR) Lead Free Brass Material
- Elongated Mounting Ears For Easy Installation
- Stainless Steel Ball
- PTFE Seats
- Pex Ends Conform to ASTM F1807
- Conforms to NSF/ANSI-61, NSF/ANSI-372, NSF/ANSI-14
- 600 psi (WOG) 150 psi (WSP) Service
- Temperature Range : -20°F to 300°F



| PART # | SIZE | DESCRIPTION | INNER | MASTER |
|------------|------|------------------------------|-------|--------|
| 806P012-NL | 1/2" | Pex Ball Drop Ear Ball Valve | 20 | 100 |
| 806P034-NL | 3/4" | Pex Ball Drop Ear Ball Valve | 10 | 60 |
| 806P001-NL | 1" | Pex Ball Drop Ear Ball Valve | 10 | 60 |

807P Series F1807 Pex Drop Ear Ball Valve w/Drain

RAVEN
SPECIALTY PRODUCTS

Purge Drain • Solid Brass Drop Ears • Lead Free • 600 WOG

ASTM
F1807
CRIMP PEX



- Dezincification Resistant (DZR) Lead Free Brass Material
- Elongated Mounting Ears For Easy Installation
- Stainless Steel Ball
- PTFE Seats
- Pex Ends Conform to ASTM F1807
- Conforms to NSF/ANSI-61, NSF/ANSI-372, NSF/ANSI-14
- 600 psi (WOG) 150 psi (WSP) Service
- Temperature Range : -20°F to 300°F



| PART # | SIZE | DESCRIPTION | INNER | MASTER |
|------------|------|-------------------------|-------|--------|
| 807P012-NL | 1/2" | Pex Ball Valve w/ Drain | 20 | 100 |
| 807P034-NL | 3/4" | Pex Ball Valve w/ Drain | 10 | 60 |
| 807P001-NL | 1" | Pex Ball Valve w/ Drain | 10 | 60 |

800W Series F1960 Pex Ball Valve

RAVEN
SPECIALTY PRODUCTS

CSA Approved • Lead Free • Full Port • 600 WOG

ASTM
F1960
EXPANSION PEX



- Dezincification Resistant (DZR) Lead Free Brass Material
- Blow Out Proof Stem Design
- Forged Brass
- Stainless Steel Ball
- Expansion Pex Ends Conform to ASTM F1960
- Vinyl Grip Lever Handle
- 600 psi (WOG) 150 psi (WSP) Service
- Temperature Range : -20°F to 300°F



| PART # | SIZE | DESCRIPTION | INNER | MASTER |
|------------|------|----------------------|-------|--------|
| 800W012-NL | 1/2" | F1960 Pex Ball Valve | 10 | 100 |
| 800W034-NL | 3/4" | F1960 Pex Ball Valve | 10 | 100 |
| 800W001-NL | 1" | F1960 Pex Ball Valve | 10 | 100 |

F1960 PEX BALL VALVES



600F Series F1960 Pex Ball Valve

CSA Approved • Lead Free • Full Port • 600 WOG

ASTM
F1960
EXPANSION PEX



- Dezincification Resistant (DZR) Lead Free Brass Material
- Blow Out Proof Stem Design
- Stainless Steel Ball
- Vinyl Grip Lever Handle
- Expansion Pex Ends Conform to ASTM F1960
- Conforms to NSF/ANSI-61, NSF/ANSI-372, NSF/ANSI-14
- 400 psi WOG 150 psi WSP Service
- Temperature Range : -20°F to 300°F



| PART # | SIZE | DESCRIPTION | INNER | MASTER |
|------------|--------|----------------------|-------|--------|
| 600F012-NL | 1/2" | F1960 Pex Ball Valve | 10 | 100 |
| 600F034-NL | 3/4" | F1960 Pex Ball Valve | 10 | 100 |
| 600F001-NL | 1" | F1960 Pex Ball Valve | 10 | 100 |
| 600F112-NL | 1-1/2" | F1960 Pex Ball Valve | 10 | 100 |
| 600F134-NL | 1-3/4" | F1960 Pex Ball Valve | 10 | 100 |
| 600F002-NL | 2" | F1960 Pex Ball Valve | 10 | 100 |



615F Series F1960 Pex T-Handle Ball Valve

CSA Approved • Lead Free • Full Port • 600 WOG

ASTM
F1960
EXPANSION PEX



- Dezincification Resistant (DZR) Lead Free Brass Material
- Blow Out Proof Stem Design
- Stainless Steel Ball
- Vinyl Grip T-Handle
- Expansion Pex Ends Conform to ASTM F1960
- Conforms to NSF/ANSI-61, NSF/ANSI-372, NSF/ANSI-14
- 400 psi WOG 150 psi WSP Service
- Temperature Range : -20°F to 300°F



| PART # | SIZE | DESCRIPTION | INNER | MASTER |
|------------|------|-------------------------------|-------|--------|
| 615F012-NL | 1/2" | F1960 Pex t-Handle Ball Valve | 10 | 100 |
| 615F034-NL | 3/4" | F1960 Pex t-Handle Ball Valve | 10 | 100 |
| 615F001-NL | 1" | F1960 Pex t-Handle Ball Valve | 10 | 100 |



405 Series F1960 Pex Ball Valve w/ Drain

Purge Drain • CSA Approved • Lead Free • Full Port • 600 WOG

ASTM
F1960
EXPANSION PEX



- Dezincification Resistant (DZR) Lead Free Brass Material
- Blow Out Proof Stem Design
- Stainless Steel Ball
- Vinyl Grip Lever Handle
- Expansion Pex Ends Conform to ASTM F1960
- Conforms to NSF/ANSI-61, NSF/ANSI-372, NSF/ANSI-14
- 400 psi WOG 150 psi WSP Service
- Temperature Range : -20°F to 300°F



| PART # | SIZE | DESCRIPTION | INNER | MASTER |
|------------|------|----------------------|-------|--------|
| 405F012-NL | 1/2" | F1960 Pex Ball Valve | 10 | 100 |
| 405F034-NL | 3/4" | F1960 Pex Ball Valve | 10 | 100 |
| 405F001-NL | 1" | F1960 Pex Ball Valve | 10 | 100 |

F1960 PEX BALL VALVES

825W Series F1960 Ball Valve w/ Drain

RAVEN
SPECIALTY PRODUCTS

Purge Drain • CSA Approved • Lead Free • Full Port • 600 WOG

ASTM
F1960
EXPANSION PEX



- Dezincification Resistant (DZR) Lead Free Brass Material
- Blow Out Proof Stem Design
- Stainless Steel Ball
- Expansion Pex Ends Conform to ASTM F1960
- Vinyl Grip Lever Handle
- 600 psi WOG 150 psi WSP Service
- Temperature Range : -20°F to 300°F



| PART # | SIZE | DESCRIPTION | INNER | MASTER |
|-------------|------|------------------------------|-------|--------|
| 825W-012-NL | 1/2" | F1960 Pex Ball Valve w/Drain | 20 | 100 |
| 825W-034-NL | 3/4" | F1960 Pex Ball Valve w/Drain | 20 | 100 |
| 825W-034-NL | 1" | F1960 Pex Ball Valve w/Drain | 10 | 100 |

806W Series F1960 Drop Ear Pex Valve

RAVEN
SPECIALTY PRODUCTS

Solid Brass Drop Ears • Lead Free • 600 WOG

ASTM
F1960
EXPANSION PEX



- Dezincification Resistant (DZR) Lead Free Brass Material
- Elongated Mounting Ears For Easy Installation
- Stainless Steel Ball
- PTFE Seats
- Expansion Pex Ends Conform to ASTM F1960
- Conforms to NSF/ANSI-61, NSF/ANSI-372, NSF/ANSI-14
- 600 psi WOG 150 psi (WSP) Service
- Temperature Range : -20°F to 300°F



| PART # | SIZE | DESCRIPTION | INNER | MASTER |
|-------------|------|-------------------------------|-------|--------|
| 806W-012-NL | 1/2" | F1960 Pex Drop Ear Ball Valve | 10 | 100 |
| 806W-034-NL | 3/4" | F1960 Pex Drop Ear Ball Valve | 10 | 100 |

807W Series F1960 Drop Ear Pex Valve w/ Drain

RAVEN
SPECIALTY PRODUCTS

Purge Drain • Solid Brass Drop Ears • Lead Free • 600 WOG

ASTM
F1960
EXPANSION PEX



- Dezincification Resistant (DZR) Lead Free Brass Material
- Elongated Mounting Ears For Easy Installation
- Stainless Steel Ball
- PTFE Seats
- Expansion Pex Ends Conform to ASTM F1960
- Conforms to NSF/ANSI-61, NSF/ANSI-372, NSF/ANSI-14
- 600 psi WOG 150 psi WSP Service
- Temperature Range : -20°F to 300°F



| PART # | SIZE | DESCRIPTION | INNER | MASTER |
|-------------|------|----------------------|-------|--------|
| 807W-012-NL | 1/2" | F1960 Pex Ball Valve | 20 | 100 |
| 807W-034-NL | 3/4" | F1960 Pex Ball Valve | 10 | 50 |

F1960 PEX BALL VALVES

FSBL Series F1960 Pex x SWT Ball Valve

RAVEN
SPECIALTY PRODUCTS

Lead Free • Vinyl Grip Handle • 600 WOG

ASTM
F1960
EXPANSION PEX



- Dezincification Resistant (DZR) Lead Free Brass Material
- Forged Brass Body
- Blow Out Proof Stem Design
- Stainless Steel Ball
- Expansion Pex Ends Conform to ASTM F1960
- Solder-Joint Conforms to ASME B16.22
- 600 psi WOG 150 psi WSP Service
- Temperature Range : -20°F to 300°F
- Conforms to NSF/ANSI-61, NSF/ANSI-372 , NSF/ANSI-14



| PART # | SIZE | DESCRIPTION | INNER | MASTER |
|-------------|------|----------------------------|-------|--------|
| FSBL-012-NL | 1/2" | F1960 Pex X SWT Ball Valve | 10 | 100 |
| FSBL-034-NL | 3/4" | F1960 Pex X SWT Ball Valve | 10 | 100 |
| FSBL-001-NL | 1" | F1960 Pex X SWT Ball Valve | 5 | 50 |

FFBL Series F1960 Pex x FIP Ball Valve

RAVEN
SPECIALTY PRODUCTS

Lead Free • Vinyl Grip Handle • 600 WOG

ASTM
F1960
EXPANSION PEX



- Dezincification Resistant (DZR) Lead Free Brass Material
- Forged Brass Body
- Blow Out Proof Stem Design
- Stainless Steel Ball
- Expansion Pex Ends Conform to ASTM F1960
- 600 psi WOG 150 psi WSP Service
- Temperature Range : -20°F to 300°F
- Conforms to NSF/ANSI-61, NSF/ANSI-372 , NSF/ANSI-14



| PART # | SIZE | DESCRIPTION | INNER | MASTER |
|-------------|------|----------------------------|-------|--------|
| FFBL-012-NL | 1/2" | F1960 Pex X FIP Ball Valve | 10 | 100 |
| FFBL-034-NL | 3/4" | F1960 Pex X FIP Ball Valve | 10 | 100 |
| FFBL-001-NL | 1" | F1960 Pex X FIP Ball Valve | 5 | 50 |

FMBL Series F1960 Pex x MIP Ball Valve

RAVEN
SPECIALTY PRODUCTS

Lead Free • Vinyl Grip Handle • 600 WOG

ASTM
F1960
EXPANSION PEX



- Dezincification Resistant (DZR) Lead Free Brass Material
- Forged Brass Body
- Blow Out Proof Stem Design
- Stainless Steel Ball
- Expansion Pex Ends Conform to ASTM F1960
- 600 psi WOG 150 psi WSP Service
- Temperature Range : -20°F to 300°F
- Conforms to NSF/ANSI-61, NSF/ANSI-372 , NSF/ANSI-14



| PART # | SIZE | DESCRIPTION | INNER | MASTER |
|-------------|------|----------------------------|-------|--------|
| FMBL-012-NL | 1/2" | F1960 Pex X MIP Ball Valve | 10 | 100 |
| FMBL-034-NL | 3/4" | F1960 Pex X MIP Ball Valve | 10 | 100 |
| FMBL-001-NL | 1" | F1960 Pex X MIP Ball Valve | 5 | 50 |

FLANGE BALL VALVES



510 Series Flange Ball Valve Set with Purge

With Purge Drain • Full Port • Two Valve Set



- Includes Gaskets and Nuts
- Vinyl Grip Lever Handle with Optional T-Handle Included
- Heavy Duty Rust Resistant Brass Body
- Full Port
- Blow Out Proof Stem Design
- PTFE Seats and Seals
- Ends Comply With ANSI.B.20.1, ANSI.B.16.18
- 600 psi WOG 150 psi WSP Service

| THREADED PART # | SWEAT PART # | SIZE | DESCRIPTION | INNER | MASTER |
|-----------------|--------------|--------|------------------------------|-------|--------|
| 510T034 | 510C034 | 3/4" | Flange Ball Valve Wlth Purge | 1 set | 12 |
| 510T001 | 510C001 | 1" | Flange Ball Valve Wlth Purge | 1 set | 12 |
| 510T114 | 510C114 | 1-1/4" | Flange Ball Valve Wlth Purge | 1 set | 8 |
| 510T112 | 510C112 | 1-1/2" | Flange Ball Valve Wlth Purge | 1 set | 8 |
| 510T002 | - | 2" | Flange Ball Valve Wlth Purge | 1 set | 4 |

505 Series Flange Ball Valve Set

Full Port • Two Valve Set



- Includes Gaskets and Nuts
- Vinyl Grip Lever Handle with Optional T-Handle Included
- Heavy Duty Rust Resistant Brass Body
- Full Port
- Blow Out Proof Stem Design
- PTFE Seats and Seals
- Ends Comply With ANSI.B.20.1, ANSI.B.16.18
- 600 psi WOP 150 psi WSP Service

| THREADED PART # | SWEAT PART # | SIZE | DESCRIPTION | INNER | MASTER |
|-----------------|--------------|--------|------------------------------|-------|--------|
| 505T034 | 505C034 | 3/4" | Flange Ball Valve Less Purge | 1 set | 12 |
| 505T001 | 505C001 | 1" | Flange Ball Valve Less Purge | 1 set | 12 |
| 505T114 | 505C114 | 1-1/4" | Flange Ball Valve Less Purge | 1 set | 8 |
| 505T112 | 505C112 | 1-1/2" | Flange Ball Valve Less Purge | 1 set | 8 |
| 505T002 | 505C002 | 2" | Flange Ball Valve Less Purge | 1 set | 4 |

FLANGE BALL VALVES

895 Series Flange Ball Valve with Purge

RAVEN
SPECIALTY PRODUCTS

With Purge Drain • Full Port



- Includes Gaskets and Nuts
- Vinyl Grip Lever Handle with Optional T-Handle Included
- Purge Drain with Mini Vinyl Grip Lever Handle
- Heavy Duty Rust Resistant Brass Body
- Full Port
- Blow Out Proof Stem Design
- PTFE Seats and Seals
- Ends Comply With ANSI.B.20.1, ANSI.B.16.18
- 400 psi WOG 150 psi WSP Service

| THREADED PART # | SWEAT PART # | SIZE | DESCRIPTION | INNER | MASTER |
|-----------------|--------------|--------|------------------------------|-------|--------|
| 895T034 | 895C034 | 3/4" | Flange Ball Valve Wlth Purge | 2 | 24 |
| 895T001 | 895C001 | 1" | Flange Ball Valve Wlth Purge | 2 | 24 |
| 895T114 | 895C114 | 1-1/4" | Flange Ball Valve Wlth Purge | 2 | 16 |
| 895T112 | 895C112 | 1-1/2" | Flange Ball Valve Wlth Purge | 2 | 16 |
| 895T002 | - | 2" | Flange Ball Valve Wlth Purge | 2 | 8 |

890 Series Flange Ball Valve

RAVEN
SPECIALTY PRODUCTS

Full Port



- Includes Gaskets and Nuts
- Vinyl Grip Lever Handle with Optional T-Handle Included
- Purge Drain with Mini Vinyl Grip Lever Handle
- Heavy Duty Rust Resistant Brass Body
- Full Port
- Blow Out Proof Stem Design
- PTFE Seats and Seals
- Ends Comply With ANSI.B.20.1, ANSI.B.16.18
- 400 psi WOG 150 psi WSP Service

| THREADED PART # | SWEAT PART # | SIZE | DESCRIPTION | INNER | MASTER |
|-----------------|--------------|--------|------------------------------|-------|--------|
| 890T034 | 890C034 | 3/4" | Flange Ball Valve Less Purge | 2 | 24 |
| 890T001 | 890C001 | 1" | Flange Ball Valve Less Purge | 2 | 24 |
| 890T114 | 890C114 | 1-1/4" | Flange Ball Valve Less Purge | 2 | 16 |
| 890T112 | 890C112 | 1-1/2" | Flange Ball Valve Less Purge | 2 | 16 |
| 890T002 | 890C002 | 2" | Flange Ball Valve Less Purge | 2 | 8 |

BALL VALVES

Tankless Water Heater Valves

FLEXTRON®
NSF Compliant • Lead Free • Full Port Main Flow Channel • Available in Press, Pex, IPS & SWT

- Set of 2 Heavy Duty Forged Brass Ball Valves
- Full Port Main Flow Channel
- Large Drain Port Outlets
- Easy Identification of Hot & Cold Valves
- Lead Free Compliant
- NSF Compliant



IPS



PRESS



SWT



PEX

PRESS
CONNECT

ASTM
F1807
CRIMP PEX

PRESS
CONNECT

ASTM
F1807
CRIMP PEX

Tankless Water Heater Isolation Valve Kit

Hot/Cold Tankless Isolation Valves & Pressure Relief Valve

| PART # | SIZE | CONNECTION | DESCRIPTION | QTY |
|---------------------|------|------------|---|-------|
| FTGV-ISO34-T-KIT-LF | 3/4" | Threaded | 1 Set H/C Iso. Valves + 3/4" Relief Valve | 1 Set |
| FTGV-ISO1-T-KIT-LF | 1" | Threaded | 1 Set H/C Iso. Valves + 3/4" Relief Valve | 1 Set |
| FTGV-ISO34-S-KIT-LF | 3/4" | Sweat | 1 Set H/C Iso. Valves + 3/4" Relief Valve | 1 Set |
| FTGV-ISO1-S-KIT-LF | 1" | Sweat | 1 Set H/C Iso. Valves + 3/4" Relief Valve | 1 Set |
| FTGV-ISO34-R-KIT-LF | 3/4" | Press | 1 Set H/C Iso. Valves + 3/4" Relief Valve | 1 Set |
| FTGV-ISO1-R-KIT-LF | 1" | Press | 1 Set H/C Iso. Valves + 3/4" Relief Valve | 1 Set |
| FTGV-ISO34-P-KIT-LF | 3/4" | PEX | 1 Set H/C Iso. Valves + 3/4" Relief Valve | 1 Set |
| FTGV-ISO1-P-KIT-LF | 1" | PEX | 1 Set H/C Iso. Valves + 3/4" Relief Valve | 1 Set |

Tankless Water Heater Isolation Valve

Set of Hot/Cold Tankless Isolation Valves

| PART # | SIZE | CONNECTION | DESCRIPTION | QTY |
|-----------------|------|------------|-----------------------|-------|
| FTGV-ISO34-T-LF | 3/4" | Threaded | 1 Set H/C Iso. Valves | 1 Set |
| FTGV-ISO1-T-LF | 1" | Threaded | 1 Set H/C Iso. Valves | 1 Set |
| FTGV-ISO34-S-LF | 3/4" | Sweat | 1 Set H/C Iso. Valves | 1 Set |
| FTGV-ISO1-S-LF | 1" | Sweat | 1 Set H/C Iso. Valves | 1 Set |
| FTGV-ISO34-R-LF | 3/4" | Press | 1 Set H/C Iso. Valves | 1 Set |
| FTGV-ISO1-R-LF | 1" | Press | 1 Set H/C Iso. Valves | 1 Set |
| FTGV-ISO34-P-LF | 3/4" | PEX | 1 Set H/C Iso. Valves | 1 Set |
| FTGV-ISO1-P-LF | 1" | PEX | 1 Set H/C Iso. Valves | 1 Set |

Pressure Relief Valve

- Fully automatic valve reseats itself after relieving pressure
- Suitable for tankless or closed-loop hot water systems



| PART # | SIZE | CONNECTION | DESCRIPTION | QTY |
|-------------|------|------------|-------------------------|-----|
| FTGV-PRV034 | 3/4" | Threaded | 1 Pressure Relief Valve | 1 |

706 Series High Flow Drain Ball Valve

RAVEN
SPECIALTY PRODUCTS

Full Port • Reversible Handle • 3 Way Adjustable • Hose Drain
PRESS
CONNECT

The 706 Series Ball Drain Valve enables quick isolation & drainage of any portion of a piped system. Ideal to install directly after a water meter to winterize a home and purge entire system with a simple quarter turn action. Reversible Handle allows for draining from either side of ball. Eliminates many leak paths and saves significant labor.

- Dezincification Resistant (DZR) Lead Free Brass Material
- Available in Sweat and Press Ends
- Heavy Duty Forged Brass Construction
- High Flow Hose Drain
- Reversible Handle
- Blow-out Proof Stem
- Individually controlled drain outlets
- Adjustable Packing Gland

SWT High Flow Drain Ball Valve



| PART # | SIZE | DESCRIPTION | INNER | MASTER |
|------------|--------|----------------|-------|--------|
| 706C034-NL | 3/4" | SWT Ball Valve | 6 | 36 |
| 706C001-NL | 1" | SWT Ball Valve | 5 | 30 |
| 706C114-NL | 1-1/4" | SWT Ball Valve | 5 | 20 |
| 706C112-NL | 1-1/2" | SWT Ball Valve | 5 | 20 |
| 706C002-NL | 2" | SWT Ball Valve | 2 | 12 |



Press High Flow Drain Ball Valve



| PART # | SIZE | DESCRIPTION | INNER | MASTER |
|------------|--------|------------------|-------|--------|
| 706R034-NL | 3/4" | Press Ball Valve | 6 | 36 |
| 706R001-NL | 1" | Press Ball Valve | 5 | 30 |
| 706R114-NL | 1-1/4" | Press Ball Valve | 5 | 20 |
| 706R112-NL | 1-1/2" | Press Ball Valve | 5 | 20 |
| 706R002-NL | 2" | Press Ball Valve | 2 | 12 |



Valves with 3-Way adjustable flow path may be quickly and easily reconfigured to drain from either side of the ball. Simply remove the handle, turn the stem 180° and replace the handle.

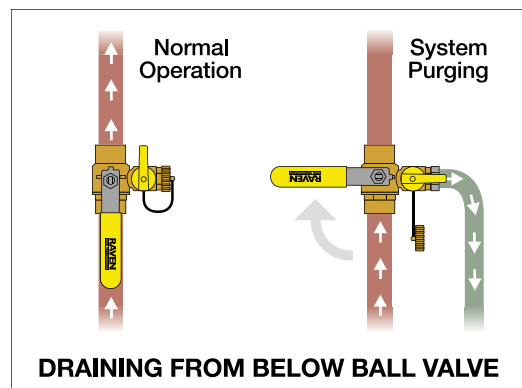
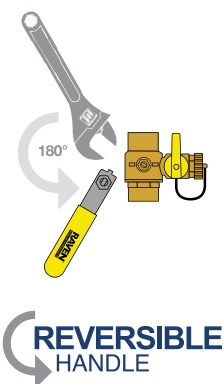
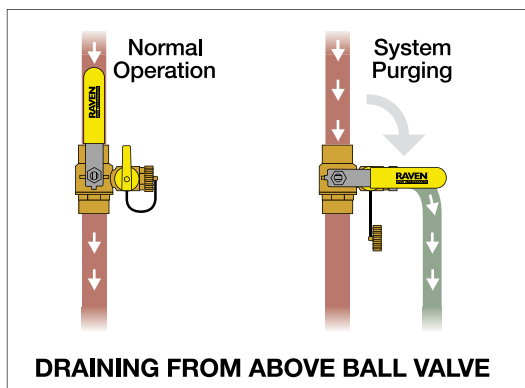

BALL VALVES

Navien® Style Manifold Assembly **RAVEN** SPECIALTY PRODUCTS

For Navien® Tank With Water Heater



- Eliminates 25 Leak Paths
- Saves Over 3.5 Hours of Labor
- Eliminates Costly Field Fabrication
- Avoids Precise Calculations
- Simplifies Future Maintenance
- Easy Installation for Navien® Systems
- Installation Kits Fit Over 200 Different Boilers

| PART # | SIZE | DESCRIPTION | INNER | MASTER |
|--------|--------|--------------------------|-------|--------|
| NCM112 | 1-1/2" | Copper Manifold Assembly | 1 | 1 |

Expansion Tank Isolator w/ Waste **RAVEN** SPECIALTY PRODUCTS

FIP x FIP • Forged Brass Body



- Isolates Allowing Release of Pressure for Tank Removal
- Prevents Hazardous Water Spray
- Avoids Need to Drain System

| PART # | SIZE | DESCRIPTION | INNER | MASTER |
|--------|---------------|---------------|-------|--------|
| 1127 | 1/2"M x 1/2"F | Tank Isolator | 10 | 100 |

Mini Ball Valve

Lead Free • Full Port • Butterfly Handle • Forged Brass Body



- Dezincification Resistant (DZR) Lead Free Brass Material
- Blow Out Proof Stem Design
- Forged Brass Body
- Double EPDM O-Rings
- Lead Free
- Thread End Complies with ANSI B1.20.1
- 600 psi WOG 150 psi WSP Service
- Temperature Range : 100 PSI at 180°F



| PART # | SIZE | DESCRIPTION | INNER | MASTER |
|-------------|---------------------|-----------------|-------|--------|
| 615MF014-NL | 1/4" MIP x 1/4" FIP | Mini Ball Valve | 10 | 120 |
| 615MF018-NL | 1/8" MIP x 1/8" FIP | Mini Ball Valve | 10 | 120 |
| 615MT014-NL | 1/4" MIP x 1/4" MIP | Mini Ball Valve | 5 | 50 |
| 615MT018-NL | 1/8" MIP x 1/8" MIP | Mini Ball Valve | 5 | 50 |

Boiler Trim Isolation Valves **RAVEN** SPECIALTY PRODUCTS

Air Vent & Gauge Isolator • Forged Brass Body



- Extended Design for Airvent Isolation
- Vent Flag Won't Interfere with Ball Valve Operation
- Ball Pressure Rating 125 Lbs.
- Maximum Temperature 180°F
- Avoids Need to Drain System to Swap Gauges

| PART # | SIZE | DESCRIPTION | INNER | MASTER |
|--------|---------------|-------------------|-------|--------|
| 1818MF | 1/8"M x 1/8"F | Air Vent Isolator | 21 | 336 |
| 1414MF | 1/4"M x 1/4"F | Gauge Isolator | 21 | 336 |
| 3838MF | 3/8"M x 3/8"F | Gauge Isolator | 21 | 336 |
| 1212MF | 1/2"M x 1/2"F | Gauge Isolator | 16 | 320 |

Purge Station with Boiler Drain

RAVEN
SPECIALTY PRODUCTS

Heavy Duty Forged Brass Body • Reversible Steel Lever Handle

- Designed for Easy Purge of Water System
- For Residential & Commercial Use with WOG
- IPS End Complies with ANSI B1.20.1
- Heavy Duty Forged Brass Body
- Chrome Plated Brass Ball w/ PTFE Seats
- Blowout Proof Stem
- Adjustable Packing Nut
- Reversible Vinyl Coated Steel Lever Handle
- Includes Purge Station & Boiler Drain
- Winterizes Your House with Single 1/4 Turn Action
- Hose End Complies with ANSI B1.20.7
- Conforms to Federal Spec WWV-35C
- Assembly Required



| PART # | SIZE | DESCRIPTION | INNER | MASTER |
|--------|------------|-------------------------------|-------|--------|
| PS34CC | 3/4" C x C | Purge Station w/ Boiler Drain | 1 | 25 |
| PS34CF | 3/4" C x F | Purge Station w/ Boiler Drain | 1 | 25 |
| PS34CM | 3/4" C x M | Purge Station w/ Boiler Drain | 1 | 25 |
| PS1CC | 1" C x C | Purge Station w/ Boiler Drain | 1 | 25 |
| PS1CF | 1" C x F | Purge Station w/ Boiler Drain | 1 | 25 |

Single Shut Off Expansion Tank Valve

Labor Saving Design • Brass Body

- Isolates Expansion Tank & Allows the Boiler to Fill at 0 Pressure
- Installs Between Expansion Tank & Air Scoop
- Labor Saving Design - Saves at Least 8 Soldered Joints
- Allows for Easy Maintenance of Heating System

| PART # | SIZE | DESCRIPTION | INNER | MASTER |
|--------|------|---------------------------------|-------|--------|
| 1129 | 1/2" | Male x Female w/ Waste & Branch | 10 | 50 |

Double Shut Off Expansion Tank Valve

Labor Saving Design • Brass Body • Branch with Shutoff

- Isolates Expansion Tank & Allows the Boiler to Fill at 0 Pressure
- Installs Between Expansion Tank & Air Scoop
- Labor Saving Design - Saves at Least 8 Soldered Joints
- Allows for Easy Maintenance of Heating System

| PART # | SIZE | DESCRIPTION | INNER | MASTER |
|--------|------|---|-------|--------|
| 1130 | 1/2" | Male x Female w/ Waste & Branch w/shutoff | 1 | 1 |

CHECK VALVES



210 Series Swing Check Valve

CSA Approved • Cast Brass Body • Cast Brass Disc • Prevent Backflow



- 200 PSI WOG 125 PSI SWP
- Threaded Ends Comply with ANSI B2.1
- Solder Ends Comply with ANSI B16.18
- CSA Certified
- Conforms to NSF/ANSI-61/ 372

Lead Free Swing Check Valve



| THREADED PART # | SWEAT PART # | SIZE | DESCRIPTION | INNER | MASTER |
|-----------------|--------------|--------|-----------------------------|-------|--------|
| 210T012-NL | 210C012-NL | 1/2" | Lead Free Swing Check Valve | 10 | 100 |
| 210T034-NL | 210C034-NL | 3/4" | Lead Free Swing Check Valve | 10 | 100 |
| 210T001-NL | 210C001-NL | 1" | Lead Free Swing Check Valve | 5 | 50 |
| 210T114-NL | 210C114-NL | 1-1/4" | Lead Free Swing Check Valve | 5 | 30 |
| 210T112-NL | 210C112-NL | 1-1/2" | Lead Free Swing Check Valve | 5 | 30 |
| 210T002-NL | 210C002-NL | 2" | Lead Free Swing Check Valve | 2 | 12 |
| 210T212-NL | 210C212-NL | 2-1/2" | Lead Free Swing Check Valve | 1 | 8 |
| 210T003-NL | 210C003-NL | 3" | Lead Free Swing Check Valve | 1 | 5 |
| 210T004-NL | 210C004-NL | 4" | Lead Free Swing Check Valve | 1 | 4 |

Swing Check Valve



| THREADED PART # | SWEAT PART # | SIZE | DESCRIPTION | INNER | MASTER |
|-----------------|--------------|--------|-------------------|-------|--------|
| 210T012 | 210C012 | 1/2" | Swing Check Valve | 10 | 100 |
| 210T034 | 210C034 | 3/4" | Swing Check Valve | 10 | 100 |
| 210T001 | 210C001 | 1" | Swing Check Valve | 5 | 50 |
| 210T114 | 210C114 | 1-1/4" | Swing Check Valve | 5 | 25 |
| 210T112 | 210C112 | 1-1/2" | Swing Check Valve | 5 | 25 |
| 210T002 | 210C002 | 2" | Swing Check Valve | 2 | 12 |
| 210T212 | 210C212 | 2-1/2" | Swing Check Valve | 1 | 8 |
| 210T003 | 210C003 | 3" | Swing Check Valve | 1 | 5 |
| 210T004 | 210C004 | 4" | Swing Check Valve | 1 | 4 |

400 Series Press Swing Check Valve



Cast Brass Body • Cast Brass Disc • Press Ends • Prevent Backflow



- 200 PSI WOG 125 PSI SWP
- CSA Certified
- Conforms to NSF/ANSI-61/ 372
- Press Ends conform to ANSI Z1157



| PART # | SIZE | DESCRIPTION | INNER | MASTER |
|------------|--------|-----------------------------|-------|--------|
| 400R012-NL | 1/2" | Press Fit Swing Check Valve | 10 | 160 |
| 400R034-NL | 3/4" | Press Fit Swing Check Valve | 10 | 120 |
| 400R001-NL | 1" | Press Fit Swing Check Valve | 5 | 60 |
| 400R114-NL | 1-1/4" | Press Fit Swing Check Valve | 5 | 40 |
| 400R112-NL | 1-1/2" | Press Fit Swing Check Valve | 5 | 30 |
| 400R002-NL | 2" | Press Fit Swing Check Valve | 2 | 24 |



Inline Spring Loaded Check Valve

Lead Free • Cast Brass Body



- Can be Installed in a Horizontal or Vertical Position
- Temperature Rating 180°F
- Cold Working Pressure (CWP): 200 psi. Non Shock
- Threaded Ends Comply ANSI B2.1
- Solder Ends Comply with ANSI B16.18
- Conforms to NSF/ANSI-61/372



| THREADED PART # | SWEAT PART # | SIZE | DESCRIPTION | INNER | MASTER |
|-----------------|--------------|--------|--------------------|-------|--------|
| 150T012-NL | 150C012-NL | 1/2" | Inline Check Valve | 10 | 100 |
| 150T034-NL | 150C034-NL | 3/4" | Inline Check Valve | 10 | 80 |
| 150T100-NL | 150C100-NL | 1" | Inline Check Valve | 6 | 60 |
| 150T112-NL | 150C112-NL | 1-1/4" | Inline Check Valve | 4 | 40 |
| 150T114-NL | 150C114-NL | 1-1/2" | Inline Check Valve | 5 | 30 |
| 150T200-NL | 150C200-NL | 2" | Inline Check Valve | 5 | 20 |

Press Inline Spring Check Valve

Lead Free • Cast Brass Body



- Can be Installed in a Horizontal or Vertical Position
- Temperature Rating 180°F
- Cold Working Pressure (CWP): 200 psi. Non Shock
- Press Ends conform to ANSI Z1157
- Conforms to NSF/ANSI-61/372



| PRESS PART # | SIZE | DESCRIPTION | INNER | MASTER |
|--------------|--------|--------------------------|-------|--------|
| 150R012-NL | 1/2" | Press Inline Check Valve | 10 | 100 |
| 150R034-NL | 3/4" | Press Inline Check Valve | 10 | 80 |
| 150R100-NL | 1" | Press Inline Check Valve | 6 | 60 |
| 150R114-NL | 1-1/4" | Press Inline Check Valve | 4 | 40 |
| 150R112-NL | 1-1/2" | Press Inline Check Valve | 5 | 30 |
| 150R200-NL | 2" | Press Inline Check Valve | 5 | 20 |

Y-Strainer

With Plug • Cast Brass Body and Plug • Stainless Steel Mesh Screen



- Screwed Cap with Plug
- Stainless Steel Mesh Screen
- Temperature Rating 180F
- Pressure rating 150 SWP
- Threaded Ends Comply with ANSI B2.1
- Solder Ends Comply with ANSI B16.18
- Conforms to NSF/ANSI-61/372



| THREADED PART # | SWEAT PART # | SIZE | DESCRIPTION | INNER | MASTER |
|-----------------|--------------|--------|-------------|-------|--------|
| 100T012-NL | 100C012-NL | 1/2" | Y-Strainer | 12 | 48 |
| 100T034-NL | 100C034-NL | 3/4" | Y-Strainer | 8 | 48 |
| 100T100-NL | 100C100-NL | 1" | Y-Strainer | 8 | 32 |
| 100T114-NL | 100C114-NL | 1-1/4" | Y-Strainer | 6 | 24 |
| 100T112-NL | 100C112-NL | 1-1/2" | Y-Strainer | 2 | 16 |
| 100T200-NL | 100C200-NL | 2" | Y-Strainer | 2 | 8 |

GATE VALVES



205 Series Brass Gate Valve

Cast Brass Body & Disc • 200 WOG



- Cast Brass Body and Disc
- Non Rising Stem
- Cast Iron Wheel Handle
- Threaded Ends Comply with ANSI B1.20.1
- Solder Ends Comply with ANSI B16.18
- 200 WOG Non Shock
- Temperature Range : 180°F
- Conforms to NSF/ANSI-61/ 372 Standards

Lead Free Brass Gate Valve



| THREADED PART # | SWEAT PART # | SIZE | DESCRIPTION | INNER | MASTER |
|-----------------|--------------|--------|------------------|-------|--------|
| 205T014-NL | - | 1/4" | Brass Gate Valve | 10 | 100 |
| 205T038-NL | - | 3/8" | Brass Gate Valve | 10 | 100 |
| 205T012-NL | 205C012-NL | 1/2" | Brass Gate Valve | 10 | 100 |
| 205T034-NL | 205C034-NL | 3/4" | Brass Gate Valve | 10 | 80 |
| 205T001-NL | 205C001-NL | 1" | Brass Gate Valve | 5 | 50 |
| 205T114-NL | 205C114-NL | 1-1/4" | Brass Gate Valve | 5 | 40 |
| 205T112-NL | 205C112-NL | 1-1/2" | Brass Gate Valve | 5 | 30 |
| 205T002-NL | 205C002-NL | 2" | Brass Gate Valve | 2 | 20 |
| 205T212-NL | 205C212-NL | 2-1/2" | Brass Gate Valve | 1 | 8 |
| 205T003-NL | 205C003-NL | 3" | Brass Gate Valve | 1 | 6 |
| 205T004-NL | 205C004-NL | 4" | Brass Gate Valve | 1 | 4 |

Brass Gate Valve



| THREADED PART # | SWEAT PART # | SIZE | DESCRIPTION | INNER | MASTER |
|-----------------|--------------|--------|-------------|-------|--------|
| 205T014 | - | 1/4" | Gate Valve | 10 | 100 |
| 205T038 | - | 3/8" | Gate Valve | 10 | 100 |
| 205T012 | 205C012 | 1/2" | Gate Valve | 10 | 100 |
| 205T034 | 205C034 | 3/4" | Gate Valve | 10 | 80 |
| 205T001 | 205C001 | 1" | Gate Valve | 5 | 50 |
| 205T114 | 205C114 | 1-1/4" | Gate Valve | 5 | 40 |
| 205T112 | 205C112 | 1-1/2" | Gate Valve | 5 | 30 |
| 205T002 | 205C002 | 2" | Gate Valve | 2 | 20 |
| 205T212 | 205C212 | 2-1/2" | Gate Valve | 1 | 8 |
| 205T003 | 205C003 | 3" | Gate Valve | 1 | 6 |
| 205T004 | 205C004 | 4" | Gate Valve | 1 | 4 |



207 Series Heavy Duty Gate Valve

Cast Brass Body & Disc • 200 WOG

**HEAVY
DUTY**



- Heavy Duty Construction
- Cast Brass Body and Disc
- Non Rising Stem
- Cast Iron Wheel Handle
- Threaded Ends Comply with ANSI B1.20.1
- Solder Ends Comply with ANSI B16.18
- 200 WOG Non Shock
- Temperature Range : 180°F
- Conforms to NSF/ANSI-61/ 372 Standards

Lead Free Brass Gate Valve



| PART # | SIZE | DESCRIPTION | INNER | MASTER |
|------------|--------|---------------------------|-------|--------|
| 207T112-NL | 1-1/2" | IPS Heavy Duty Gate Valve | 5 | 30 |
| 207T002-NL | 2" | IPS Heavy Duty Gate Valve | 2 | 20 |

Brass Gate Valve



| PART # | SIZE | DESCRIPTION | INNER | MASTER |
|---------|--------|---------------------------|-------|--------|
| 207T012 | 1/2" | IPS Heavy Duty Gate Valve | 10 | 100 |
| 207T034 | 3/4" | IPS Heavy Duty Gate Valve | 10 | 80 |
| 207T001 | 1" | IPS Heavy Duty Gate Valve | 5 | 50 |
| 207T114 | 1-1/4" | IPS Heavy Duty Gate Valve | 5 | 40 |
| 207T112 | 1-1/2" | IPS Heavy Duty Gate Valve | 5 | 30 |
| 207T002 | 2" | IPS Heavy Duty Gate Valve | 2 | 20 |
| 207T212 | 2-1/2" | IPS Heavy Duty Gate Valve | 1 | 8 |
| 207T003 | 3" | IPS Heavy Duty Gate Valve | 1 | 6 |
| 207T004 | 4" | IPS Heavy Duty Gate Valve | 1 | 4 |

205 Series Comp Brass Gate Valve

200 WOG Non Shock • Cast Brass Body & Disc • Compression Connection



- Cast Brass Body and Disc
- Non Rising Stem
- Cast Iron Wheel Handle
- Compression Ends
- 200 WOG Non Shock
- Temperature Range : 180°F
- Conforms to NSF/ANSI-61/ 372 Standards

Lead Free Comp Brass Gate Valve



| PART # | SIZE | DESCRIPTION | INNER | MASTER |
|------------|------|------------------------------|-------|--------|
| 205P012-NL | 1/2" | Comp X Comp Brass Gate Valve | 10 | 80 |
| 205P034-NL | 3/4" | Comp X Comp Brass Gate Valve | 10 | 60 |
| 205P001-NL | 1" | Comp X Comp Brass Gate Valve | 5 | 40 |

Comp Brass Gate Valve



| PART # | SIZE | DESCRIPTION | INNER | MASTER |
|---------|------|------------------------------|-------|--------|
| 205P012 | 1/2" | Comp X Comp Brass Gate Valve | 10 | 80 |
| 205P034 | 3/4" | Comp X Comp Brass Gate Valve | 10 | 60 |

GATE & STOP VALVES



Long Bonnet Gate Valve

Lead Free • Cast Brass Body • 200 WOG



- Cast Brass
- Long Bonnet Allows Ease of Access
- 200 PSI WOG
- Threaded Ends Comply with ANSI B2.1
- Sweat Ends Conform to ASME B16.18
- Conforms to NSF/ANSI-61/ 372 Standards
- Temperature Rating 245°F



| THREADED PART # | SWEAT PART # | SIZE | DESCRIPTION | INNER | MASTER |
|-----------------|--------------|------|------------------------|-------|--------|
| 44122-NL | 44121-NL | 1/2" | Long Bonnet Gate Valve | 10 | 80 |
| 44342-NL | 44341-NL | 3/4" | Long Bonnet Gate Valve | 10 | 60 |

822 Series Heavy Duty Long Bonnet Gate Valve



Lead Free • Cast Brass Body • 300 WOG

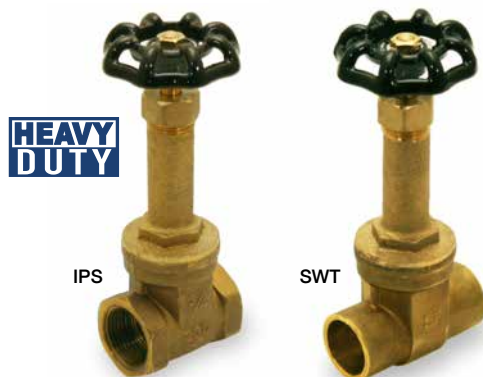

- Cast Brass
- Long Bonnet Allows Ease of Access
- Rising Stem
- Conforms to Federal Specs MSS-SP80
- Threaded Ends Comply with ANSI B2.1
- Sweat Ends Conform to ASME B16.18
- Conforms to NSF/ANSI-61/ 372 Standards
- 300 WOG - 150 SWP



| THREADED PART # | SWEAT PART # | SIZE | DESCRIPTION | INNER | MASTER |
|-----------------|--------------|------|-----------------------------------|-------|--------|
| 822T012-NL | 822C012-NL | 1/2" | Heavy Duty Long Bonnet Gate Valve | 10 | 80 |
| 822T034-NL | 822C034-NL | 3/4" | Heavy Duty Long Bonnet Gate Valve | 10 | 60 |

Straight Short Globe Style Stop Valve



Lead Free • Forged Brass Body • 125 WOG



- Forged Brass Body
- Compression Style Stop Valve
- Threaded Ends Comply with ANSI B2.1
- Sweat Ends Conform to ASME B16.18
- Conforms to NSF/ANSI-61/ 372 Standards
- 125 WOG



| THREADED PART # | SWEAT PART # | SIZE | DESCRIPTION | INNER | MASTER |
|-----------------|--------------|------|-------------------|-------|--------|
| 73122-NL | 73121-NL | 1/2" | Short Globe Valve | 10 | 100 |
| 73342-NL | 73341-NL | 3/4" | Short Globe Valve | 10 | 100 |

GATE & STOP VALVES

Angle Short Globe Style Stop Valve



Lead Free • Forged Brass Body • 125 WOG



- Forged Brass Body
- Compression Style Stop Valve
- Threaded Ends Comply with ANSI B2.1
- Sweat Ends Conform to ASME B16.18
- Conforms to NSF/ANSI-61/ 372 Standards
- 125 WOG



| THREADED PART # | SWEAT PART # | SIZE | DESCRIPTION | INNER | MASTER |
|-----------------|--------------|------|-------------------|-------|--------|
| 74122-NL | 74121-NL | 1/2" | Short Globe Valve | 10 | 100 |
| 74342-NL | 74341-NL | 3/4" | Short Globe Valve | 10 | 100 |

410 Series Stop and Waste Valve



Purge Drain • Lead Free • Forged Brass Body • 125 WOG



- Forged Brass Body
- Compression Style Stop Valve
- Threaded Ends Comply with ANSI B2.1
- Sweat Ends Conform to ASME B16.18
- Conforms to NSF/ANSI-61/ 372 Standards
- 125 WOG



| THREADED PART # | SWEAT PART # | SIZE | DESCRIPTION | INNER | MASTER |
|-----------------|--------------|------|----------------------|-------|--------|
| 410T012-NL | 410C012-NL | 1/2" | Stop and Waste Valve | 10 | 80 |
| 410T034-NL | 410C034-NL | 3/4" | Stop and Waste Valve | 10 | 60 |

43 Series Long Bonnet Stop Valve



Lead Free • Forged Brass Body • 125 WOG



- Brass Body
- Long Bonnet Allows Ease of Access
- Rising Stem
- Compression Style Stop Valve
- Threaded Ends Comply with ANSI B2.1
- Sweat Ends Conform to ASME B16.18
- Conforms to NSF/ANSI-61/ 372 Standards
- 125 WOG Non Shock
- Temperature Rating 180°F



| THREADED PART # | SWEAT PART # | SIZE | DESCRIPTION | INNER | MASTER |
|-----------------|--------------|------|------------------------|-------|--------|
| 43122-NL | 43121-NL | 1/2" | Long Bonnet Stop Valve | 10 | 100 |
| 43342-NL | 43341-NL | 3/4" | Long Bonnet Stop Valve | 10 | 100 |

BOILER DRAINS

FIP Boiler Drain w/Stuffing Box



FIP X Hose • 125 WOG • Brass Body



- Brass Body
- Angle Pattern Boiler Drain with Stuffing Box
- CSA and Truesdail Approved
- Lead Free Models Conform to NSF/ANSI 61-8 /372
- Maximum Temperature: 180°F
- ISO:9001 Approved Manufacturer



| LEAD FREE PART # | PART # | SIZE | DESCRIPTION | INNER | MASTER |
|------------------|--------|------|--------------|-------|--------|
| 4612F-NL | 4612F | 1/2" | Boiler Drain | 10 | 100 |
| 4634F-NL | 4634F | 3/4" | Boilre Drain | 10 | 100 |

1/4 Turn Boiler Drain



MIP X Hose • Brass Body



- Brass Body
- Chrome Plated Brass Ball
- Quarter Turn Butterfly Style Aluminum T-handle
- Lead Free Models Conform to NSF/ANSI 61-8 /372
- Conforms to ASME A112.18.1-2011
- Pressure Rating is 125 PSI
- Temperature Rating 160°F



| LEAD FREE PART # | PART # | SIZE | DESCRIPTION | INNER | MASTER |
|------------------|--------|------|-----------------------|-------|--------|
| 46122-NL | 46122 | 1/2" | 1/4 Turn Boiler Drain | 10 | 100 |
| 46342-NL | 46342 | 3/4" | 1/4 Turn Boiler Drain | 10 | 100 |

MIP Boiler Drain w/Stuffing Box



MIP X Hose • 125 WOG • Brass Body



- Brass Body
- Angle Pattern Boiler Drain with Stuffing Box
- 1/2" Inlet is Dual MIP & Sweat
- Lead Free Models Conform to NSF/ANSI 61-8 /372
- CSA Approved - ASME A112.18.1/CSA B125.1
- Maximum Temperature: 180°F
- ISO:9001 Approved Manufacturer



| LEAD FREE PART # | PART # | SIZE | DESCRIPTION | INNER | MASTER |
|------------------|--------|------|--------------|-------|--------|
| 4612-NL | 4612 | 1/2" | Boiler Drain | 10 | 100 |
| 4634-NL | 4634 | 3/4" | Boilre Drain | 10 | 100 |

1/4 Turn Boiler Drain



High Temperature • Ceramic Disc • MIP X Hose • Brass Body



- Brass Body
- 45° Angle Prevents Hose Kinking
- 300 PSI 32°- 300°F
- Ceramic Disc Allow for High Temperatures
- Extended Threads on Bib Spout for Secure Connection
- Low Operating Torque
- Lead Free Meets NSF-61 Standard



| LEAD FREE PART # | SIZE | DESCRIPTION | INNER | MASTER |
|------------------|------|-----------------------|-------|--------|
| 12CCBD-NL | 1/2" | 1/4 Turn Boiler Drain | 5 | 60 |
| 34CCBD-NL | 3/4" | 1/4 Turn Boiler Drain | 5 | 60 |

BOILER DRAINS



Boiler Drains

Lead Free • Forged Brass Body •

- 45° Angle Prevents Hose Kinking
- Adjustable Stem Packing Gland
- 300 PSI at 32° to 300°F
- Forged Brass
- Low Operating Torque
- Lead Free Meets NSF-61 Standard
- Leaded Meets ANSI/NSF 14 Standard
- Extended Threads on Bib Spout for Secure Connection



T-Handle Brass Boiler Drain



| LEAD FREE PART # | PART # | SIZE | INNER | MASTER |
|------------------|--------|-----------------|-------------|--------|
| 12BDBT-NL | 12BDBT | 1/2" | 10 | 100 |
| 34BDBT-NL | 34BDBT | 3/4" | 5 | 50 |
| | | 1/2" in MIP/SWT | 3/4" in MIP | |

Lever Handle Brass Boiler Drain



| LEAD FREE PART # | SIZE | INNER | MASTER | |
|------------------|------|-----------------|-------------|--|
| 12BDBL-NL | 1/2" | 10 | 100 | |
| 34BDBL-NL | 3/4" | 5 | 50 | |
| | | 1/2" in MIP/SWT | 3/4" in MIP | |

T-Handle Chrome Plated Boiler Drain



| LEAD FREE PART # | SIZE | INNER | MASTER | |
|------------------|------|-----------------|-------------|--|
| 12BDBT-NL | 1/2" | 10 | 100 | |
| 34BDBT-NL | 3/4" | 5 | 50 | |
| | | 1/2" in MIP/SWT | 3/4" in MIP | |

Lever Handle Chrome Plated Boiler Drain



| PART # | PART # | SIZE | INNER | MASTER |
|-----------|--------|-----------------|-------------|--------|
| 12BDCL-NL | | 1/2" | 10 | 100 |
| 34BDCL-NL | 34BDCL | 3/4" | 5 | 50 |
| | | 1/2" in MIP/SWT | 3/4" in MIP | |

T-Handle Long Body Boiler Drain



| LEAD FREE PART # | SIZE | INNER | MASTER | |
|------------------|------|-----------------|-------------|--|
| 12LBBD-NL | 1/2" | 10 | 100 | |
| 34LBBD-NL | 3/4" | 5 | 50 | |
| | | 1/2" in MIP/SWT | 3/4" in MIP | |

Street End Boiler Drain

- New Design with Dimensions of Our Acclaimed 1/4 Turn Boiler Drain
- Street Ends Enable Sweating Valve Directly into Wrot Fitting
- Offers a Nice Clean Look When Installed

Loose Key Boiler Drains with Cap

Ceramic Cartridge



| PART # | SIZE | DESCRIPTION | INNER | MASTER |
|--------|------|-------------------|-------|--------|
| R1670 | 3/4" | Rough Brass MIP | 10 | 100 |
| R1671 | 3/4" | Chrome Plated MIP | 10 | 100 |

Street End Lever



| LEAD FREE PART # | SIZE | INNER | MASTER |
|------------------|---------------|-------|--------|
| 12BDBT#2-NL | 1/2" Male Swt | 10 | 100 |

Long Body Street End



| LEAD FREE PART # | SIZE | INNER | MASTER |
|------------------|---------------|-------|--------|
| 12BDBTLB-NL | 1/2" Male Swt | 10 | 100 |
| 34BDBTLB-NL | 3/4" Male Swt | 5 | 50 |

HOSE BIBS & SILLCOCKS

1/4 Turn Hose Bib



MIP X Hose • Aluminum Handle



- Cast Brass Body
- NSF/ANSI 372 Compliant
- Conforms to AMSE A112.18/CSA B125
- Pressure Rating 125 PSI
- Maximum Temperature: 200°F
- Manufactured in an ISO-9002 compliant facility



| LEAD FREE PART # | PART # | SIZE | DESCRIPTION | INNER | MASTER |
|------------------|--------|------|------------------|-------|--------|
| 46121-NL | 46121 | 1/2" | MIP/SWT Hose Bib | 10 | 100 |
| 46341-NL | 46341 | 3/4" | MIP/FIP Hose bib | 10 | 100 |

1/4 Turn No Kink Hose Bib



MIP X Hose • Brass Body



- Brass Body
- Chrome Plated Brass Ball
- Butterfly style aluminum T-handle
- Conforms to ASME A112.18.1-2011
- Conforms to NSF 61-G
- Pressure rating is 125 PSI
- Temperature rating is 160°F



| LEAD FREE PART # | PART # | SIZE | DESCRIPTION | INNER | MASTER |
|------------------|--------|------|------------------|-------|--------|
| 46123-NL | 46123 | 1/2" | No Kink Hose Bib | 10 | 100 |
| 46343-NL | 46343 | 3/4" | No Kink Hose Bib | 10 | 100 |

1/4 Turn No Kink Hose Bib



MIP X Hose • Brass Body



- Brass Body
- Butterfly style aluminum T-handle
- NSF/ANSI 372 Compliant
- Compliant to ASME A112.18.1-2011/CSA B125.1-11
- Pressure rating is 125 PSI WWP Non Shock
- Temperature rating is 200°F



| LEAD FREE PART # | SIZE | DESCRIPTION | INNER | MASTER |
|------------------|------|------------------------------|-------|--------|
| 46124-NL | 1/2" | MIP/SWT X Plain End 1/4 Turn | 10 | 100 |

Multi-Turn Sillcock



MIP X Hose • Brass Body



- Cast Brass Body
- Multi Turn Sillcock with Stuffing Box
- 1/4 Turn Wheel Handle
- Complies with NSF/ANSI 372-2011
- Conforms to ASME A112.18.5/CSA B125.1
- Pressure rating is 125 PSI WWP Non Shock
- Temperature rating is 180°F



| LEAD FREE PART # | PART # | SIZE | DESCRIPTION | INNER | MASTER |
|------------------|--------|------|--------------|-------|--------|
| 4712-NL | 4712 | 1/2" | IPS Sillcock | 10 | 100 |
| 4734-NL | 4734 | 3/4" | IPS Sillcock | 10 | 100 |
| 4722-NL | 4722 | 3/4" | SWT Sillcock | 10 | 100 |

1/4 Turn Sillcock



MIP X Hose • Brass Body



- Brass Body
- Chrome Plated Brass Ball
- Aluminum T-handle
- NSF/ANSI 372 Compliant
- Complies with ASME A112.18.1-2011/CSA B125.1-11



| LEAD FREE PART # | PART # | SIZE | DESCRIPTION | INNER | MASTER |
|------------------|--------|------|-----------------------|-------|--------|
| 47122-NL | 47122 | 1/2" | 1/4 Turn IPS Sillcock | 10 | 100 |
| 47342-NL | 47342 | 3/4" | 1/4 Turn IPS Sillcock | 10 | 100 |
| 47122P-NL | | 1/2" | 1/4 Turn Pex Sillcock | 10 | 100 |
| 47342P-NL | | 3/4" | 1/4 Turn Pex Sillcock | 10 | 100 |

Ceramic Cartridge Sillcock



1/4 Turn • Rough Brass •



- Rough Brass
- 1/4 Turn Wheel Handle Design
- Ceramic Cartridge



| LEAD FREE PART # | PART # | SIZE | DESCRIPTION | INNER | MASTER |
|------------------|----------|------|--------------|-------|--------|
| 1167IPS-NL | 1167-IPS | 1/2" | IPS Sillcock | 10 | 100 |
| 1168IPS-NL | 1168-IPS | 3/4" | IPS Sillcock | 10 | 100 |
| 1167C-NL | 1167-C | 1/2" | SWT Sillcock | 10 | 100 |



Chrome Plated Lever Handle Sillcock

Oversized Flange • 1/4 Turn On/Off • High Grade Corrosion Resistant Material



- Available in Threaded, Sweat, Pex F1807 & Pex F1960
- Design for Multi Purpose Outdoor and Indoor Installations
- High Grade Construction Provides Added Resistance to Corrosion
- Stainless Steel Handle & Nuts
- Suitable For a Full Range of Liquids
- Adjustable Stem Sacking Gland
- Extended Bib Threads for Secure Connection
- Oversized Flange for Added Protection and Ease of Installation
- Easy Grip Lever Handle Provides Quick 1/4 Turn On/Off Operation
- Operating Temp 33°F - 300°F
- Max. Operating Pressure 360 PSI
- Patented Item
- Lead Free Models Conform to NSF/ANSI-61/372



IPS

SWT



PEX F1960

PEX F1807

| LEAD FREE PART # | PART # | SIZE | DESCRIPTION | INNER | MASTER |
|------------------|----------|------|----------------------------|-------|--------|
| 1165-IPS-NL | 1165-IPS | 1/2" | IPS Chrome Plated Sillcock | 10 | 100 |
| 1166-IPS-NL | 1166-IPS | 3/4" | IPS Chrome Plated Sillcock | 5 | 100 |
| 1165-C-NL | 1165-C | 1/2" | SWT Chrome Plated Sillcock | 10 | 100 |
| 1166-C-NL | 1166-C | 3/4" | SWT Chrome Plated Sillcock | 5 | 100 |
| 1165WIR-NL | 1165-WIR | 1/2" | Pex F1960 | 10 | 50 |
| 1165PEX-NL | | 1/2" | Pex F1807 | 10 | 50 |

Chrome Plated Sillcock SPECIFICATIONS

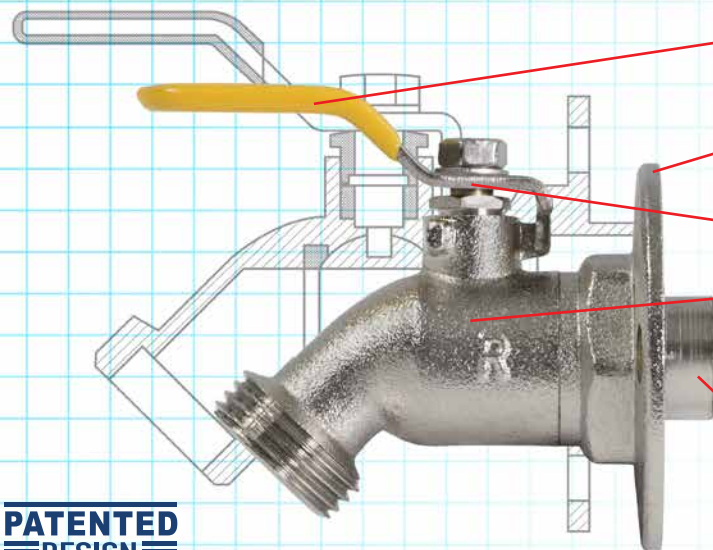

- Easy Grip Lever Handle For Quick On/Off Operation
- Extra Wide Flange For Added Surface Coverage & Protection
- Stainless Steel Handle & Nut
- High Grade Corrosion Resistant Material Provides A Longer Lasting Protection For A Variety Outdoor & Indoor Applications
- Available in Threaded, Sweat, Pex F1807 & Pex F1960

PATENTED
DESIGN

FROST FREE SILLCOCKS



Multi Turn Frost Free Sillcock

3/4" Hose x 1/2" • Available In MIP/SWT, F1807 PEX & F1960 PEX Ends



- Durable Chrome-Plated Body Offers Superior Corrosion Resistance
- Extended-Hub Handwheel Allows for Easy On/Off Operation
- Includes Tapered Sill Wedge, for Easier Installation at Proper Angle
- NL Models Certified to Meet Federal Lead Free Requirements
- Cold Working Pressure 125 PSI
- Truesdale Labs Certified to ANSI/NSF Standard 61-9/372
- MIP/SWT Ends Conform to ANSI / ASME B1.20.1, ANSI / ASME B16.18
- Crimp Pex Ends Conform to ASTM F1807
- Expansion Pex Ends Conform to ASTM F1960
- ISO:9001 Approved Manufacturer
- Replacement Cartridge and Handle Available



MIP/SWT Frost Free Sillcock



| LEAD FREE PART # | PART # | SIZE | DESCRIPTION | INNER | MASTER |
|------------------|--------|------|--------------------------------|-------|--------|
| 6204-NL | 6204 | 4" | MIP/SWT Chrome Plated Hose Bib | 2 | 40 |
| 6206-NL | 6206 | 6" | MIP/SWT Chrome Plated Hose Bib | 2 | 40 |
| 6208-NL | 6208 | 8" | MIP/SWT Chrome Plated Hose Bib | 2 | 40 |
| 6210-NL | 6210 | 10" | MIP/SWT Chrome Plated Hose Bib | 2 | 40 |
| 6212-NL | 6212 | 12" | MIP/SWT Chrome Plated Hose Bib | 2 | 40 |
| 6214-NL | 6214 | 14" | MIP/SWT Chrome Plated Hose Bib | 2 | 40 |



F1807 Pex Frost Free Sillcock



| LEAD FREE PART # | SIZE | DESCRIPTION | INNER | MASTER |
|------------------|------|----------------------------------|-------|--------|
| 6204P-NL | 4" | F1807 Pex Chrome Plated Hose Bib | 2 | 40 |
| 6206P-NL | 6" | F1807 Pex Chrome Plated Hose Bib | 2 | 40 |
| 6208P-NL | 8" | F1807 Pex Chrome Plated Hose Bib | 2 | 40 |
| 6210P-NL | 10" | F1807 Pex Chrome Plated Hose Bib | 2 | 40 |
| 6212P-NL | 12" | F1807 Pex Chrome Plated Hose Bib | 2 | 40 |
| 6214P-NL | 14" | F1807 Pex Chrome Plated Hose Bib | 2 | 40 |



F1960 Pex Frost Free Sillcock



| LEAD FREE PART # | SIZE | DESCRIPTION | INNER | MASTER |
|------------------|------|----------------------------------|-------|--------|
| 6204F-NL | 4" | F1960 Pex Chrome Plated Hose Bib | 2 | 40 |
| 6206F-NL | 6" | F1960 Pex Chrome Plated Hose Bib | 2 | 40 |
| 6208F-NL | 8" | F1960 Pex Chrome Plated Hose Bib | 2 | 40 |
| 6210F-NL | 10" | F1960 Pex Chrome Plated Hose Bib | 2 | 40 |
| 6212F-NL | 12" | F1960 Pex Chrome Plated Hose Bib | 2 | 40 |
| 6214F-NL | 14" | F1960 Pex Chrome Plated Hose Bib | 2 | 40 |

Replacement Handle



PART #

62HANDLE

Replacement Cartridge



PART #

6204CAR 4" 6206CAR 6" 6208CAR 8" 6210CAR 10" 6212CAR 12" 6214CAR 14"

FROST FREE SILLCOCKS

Multi Turn Frost Free Sillcock with Vacuum Breaker



3/4" Hose x 1/2" • Available In MIP/SWT, F1807 PEX & F1960 PEX Ends



- Anti-Siphon Vacuum Breaker and Internal Check Valve, Prevent Backflow
- Durable Chrome-Plated Body Offers Superior Corrosion Resistance
- Extended-Hub Handwheel Allows for Easy On/Off Operation
- Includes Tapered Sill Wedge, for Easier Installation at Proper Angle
- Certified to A.S.S.E. Standard 1019, Type A
- NL Models Certified to Meet Federal Lead Free Requirements
- Cold Working Pressure 125 PSI
- Truesdale Labs Certified to ANSI/NSF Standard 61-9/372
- CSA Certified
- MIP/SWT Ends Conform to ANSI / ASME B1.20.1, ANSI / ASME B16.18
- Crimp Pex Ends Conform to ASTM F1807
- Expansion Pex Ends Conform to ASTM F1960
- ISO:9001 Approved Manufacturer
- Replacement Cartridge, Handle and Cap Available

MIP/SWT Frost Free Sillcock



| LEAD FREE PART # | PART # | SIZE | DESCRIPTION | INNER | MASTER |
|------------------|--------|------|--------------------------------|-------|--------|
| 62041-NL | | 4" | MIP/SWT Chrome Plated Hose Bib | 2 | 40 |
| 62061-NL | 62061 | 6" | MIP/SWT Chrome Plated Hose Bib | 2 | 40 |
| 62081-NL | 62081 | 8" | MIP/SWT Chrome Plated Hose Bib | 2 | 40 |
| 62101-NL | 62101 | 10" | MIP/SWT Chrome Plated Hose Bib | 2 | 40 |
| 62121-NL | 62121 | 12" | MIP/SWT Chrome Plated Hose Bib | 2 | 40 |



F1807 Pex Frost Free Sillcock



| LEAD FREE PART # | SIZE | DESCRIPTION | INNER | MASTER |
|------------------|------|----------------------------------|-------|--------|
| 62041P-NL | 4" | F1807 Pex Chrome Plated Hose Bib | 2 | 40 |
| 62061P-NL | 6" | F1807 Pex Chrome Plated Hose Bib | 2 | 40 |
| 62081P-NL | 8" | F1807 Pex Chrome Plated Hose Bib | 2 | 40 |
| 62101P-NL | 10" | F1807 Pex Chrome Plated Hose Bib | 2 | 40 |
| 62121P-NL | 12" | F1807 Pex Chrome Plated Hose Bib | 2 | 40 |



F1960 Pex Frost Free Sillcock



| LEAD FREE PART # | SIZE | DESCRIPTION | INNER | MASTER |
|------------------|------|----------------------------------|-------|--------|
| 62041F-NL | 4" | F1960 Pex Chrome Plated Hose Bib | 2 | 40 |
| 62061F-NL | 6" | F1960 Pex Chrome Plated Hose Bib | 2 | 40 |
| 62081F-NL | 8" | F1960 Pex Chrome Plated Hose Bib | 2 | 40 |
| 62101F-NL | 10" | F1960 Pex Chrome Plated Hose Bib | 2 | 40 |
| 62121F-NL | 12" | F1960 Pex Chrome Plated Hose Bib | 2 | 40 |



Replacement Handle

Replacement Cap



PART #
62HANDLE



PART #
62CAP

Replacement Cartridge



PART #
62041CAR 4" 62061CAR 6" 62081CAR 8" 62101CAR 10" 62121CAR 12" 62141CAR 14"

FROST FREE SILLCOCKS

RAVEN
SPECIALTY PRODUCTS

1/2 Turn Frost Free Sillcock with Vacuum Breaker

3/4" Hose x 1/2" MIP/SWT • Quick 1/2 Turn Shutoff • Ceramic Cartridge



- Integral Backflow Device Protects Up to 125 PSI of Back Pressure
- EPDM Rubber Packing Helps Prevent Leaking Behind Packing Nut
- Will Not Rupture from Freezing When Valve is Shut Off and Hose is Removed
- Full Circle Operating Threads on the Valve Body & Retainer for a Secure Fit
- 1/2 Turn design Allows for Easy On/Off Operation
- ISO:9001 Approved Manufacturer



| PART # | SIZE | DESCRIPTION | INNER | MASTER |
|-------------|------|----------------------------------|-------|--------|
| FP-1132-4C | 4" | F1960 Pex Chrome Plated Hose Bib | 1 | 24 |
| FP-1132-6C | 6" | F1960 Pex Chrome Plated Hose Bib | 1 | 24 |
| FP-1132-8C | 8" | F1960 Pex Chrome Plated Hose Bib | 1 | 24 |
| FP-1132-10C | 10" | F1960 Pex Chrome Plated Hose Bib | 1 | 24 |
| FP-1132-12C | 12" | F1960 Pex Chrome Plated Hose Bib | 1 | 24 |
| FP-1132-14C | 14" | F1960 Pex Chrome Plated Hose Bib | 1 | 24 |



Sillcock Ceramic Replacement Cartridge

| PART # | SIZE | DESCRIPTION | INNER | MASTER |
|----------|------|-------------|-------|--------|
| FP-CC-8 | 8" | | | |
| FP-CC-10 | 10" | | | |
| FP-CC-12 | 12" | | | |
| FP-CC-14 | 14" | | | |

Multi Turn Frost Free Sillcock

RAVEN
SPECIALTY PRODUCTS

3/4" Hose x 1/2" MIP/SWT • Anti-Siphon Protection



- Durable Chrome-Plated Body Offers Superior Corrosion Resistance
- Extended-Hub Handwheel Allows for Easy On/Off Operation
- Includes Tapered Sill Wedge, for Easier Installation at Proper Angle
- NL Models Certified to Meet Federal Lead Free Requirements
- Cold Working Pressure 125 PSI
- Truesdale Labs Certified to ANSI/NSF Standard 61-9/372
- MIP/SWT Ends Conform to ANSI / ASME B1.20.1, ANSI / ASME B16.18
- ISO:9001 Approved Manufacturer



Frost Free Sillcock

| LEAD FREE PART # | PART # | SIZE | DESCRIPTION | INNER | MASTER |
|------------------|------------|------------|---------------------|-------|--------|
| FP-1142-4-NL | FP-1142-4 | 1/2" x 4" | Frost Free Sillcock | 1 | 24 |
| FP-1142-6-NL | FP-1142-6 | 1/2" x 6" | Frost Free Sillcock | 1 | 24 |
| FP-1142-8-NL | FP-1142-8 | 1/2" x 8" | Frost Free Sillcock | 1 | 24 |
| FP-1142-10-NL | FP-1142-10 | 1/2" x 10" | Frost Free Sillcock | 1 | 24 |
| FP-1142-12-NL | FP-1142-12 | 1/2" x 12" | Frost Free Sillcock | 1 | 24 |
| FP-1142-14-NL | FP-1142-14 | 1/2" x 14" | Frost Free Sillcock | 1 | 24 |



Frost Free Sillcock w/ Vacuum Breaker



| LEAD FREE PART # | PART # | SIZE | DESCRIPTION | INNER | MASTER |
|------------------|-------------|------------|----------------------------|-------|--------|
| FP-1142V-4-NL | | 1/2" x 4" | Sillcock w/ Vacuum Breaker | 1 | 24 |
| FP-1142V-6-NL | FP-1142V-6 | 1/2" x 6" | Sillcock w/ Vacuum Breaker | 1 | 24 |
| FP-1142V-8-NL | FP-1142V-8 | 1/2" x 8" | Sillcock w/ Vacuum Breaker | 1 | 24 |
| FP-1142V-10-NL | FP-1142V-10 | 1/2" x 10" | Sillcock w/ Vacuum Breaker | 1 | 24 |
| FP-1142V-12-NL | FP-1142V-12 | 1/2" x 12" | Sillcock w/ Vacuum Breaker | 1 | 24 |

ACCESSORIES

Hose Bib Vacuum Breaker



Lead Free • Backflow Preventor



- Prevents Water from Siphoning Back Into the Drinking Water System
- Available in Rough Brass and Chrome Finish



| LEAD FREE PART # | PART # | SIZE | DESCRIPTION | INNER | MASTER |
|------------------|--------|------|---------------|-------|--------|
| VB3400-NL | VB3400 | 3/4" | Rough Brass | 20 | 200 |
| 88C-NL | | 3/4" | Chrome Finish | 20 | 200 |

Sump Pump Check Valve



Rubber Flexible Couplings



- Stainless Steel Clamps
- ASTM C1173
- For Plastic, Cast Iron or Steel Pipes

| PART # | SIZE | DESCRIPTION | INNER | MASTER |
|---------|-----------------|-----------------------|-------|--------|
| SPCV112 | 1-1/2" X 1-1/4" | Sump Pump Check Valve | 1 | 50 |
| SPCV22 | 2" X 2" | Sump Pump Check Valve | 1 | 50 |

Trap Primer

Pressure Drop Activated • EPPM Seals

Routinely delivers potable water to seldom used floor drains. Activates with a 10 psig pressure drop between 25-125 psi. Designed to be installed on a cold water line serving a frequently used fixture.

- Built in Vacuum Breaker Ports
- Threaded Inlet and Outlet Connection
- Lead Free Brass Material
- Maintains Water in the Trap
- Maximum Supply Pressure: 125 psi
- Minimum Supply Pressure Must Exceed 25 psi
- CSA & ASSE Certified
- EPDM Seals



| PART # | SIZE | DESCRIPTION | INNER | MASTER |
|----------|------|-------------|-------|--------|
| EFTP300T | 1/2" | Trap Primer | 1 | 24 |

Ball Drip Valve



NPT Thread x NPT Thread • Lead Free • Brass Body



- Two Piece
- Solid Brass Ball
- For Horizontal Use Only



| PART # | SIZE | DESCRIPTION | INNER | MASTER |
|------------|------|-----------------|-------|--------|
| 681T012-NL | 1/2" | Ball Drip Valve | 10 | 100 |
| 681T034-NL | 3/4" | Ball Drip Valve | 10 | 100 |

Water Tester Cap & Valve



Jim Cap with Ball Valve •



- Stainless Steel Band & Clamp
- Made from Durable Rubber Material
- Rubber Cap W/ 1/4 Turn Hose Fitting
- Allows for Easy Testing & Draining of System

| PART # | SIZE | DESCRIPTION | INNER | MASTER |
|--------|--------|--------------------------|-------|--------|
| WTC112 | 1-1/2" | Water Tester Cap & Valve | 1 | 1 |
| WTC2 | 2" | Water Tester Cap & Valve | 1 | 1 |
| WTC3 | 3" | Water Tester Cap & Valve | 1 | 1 |

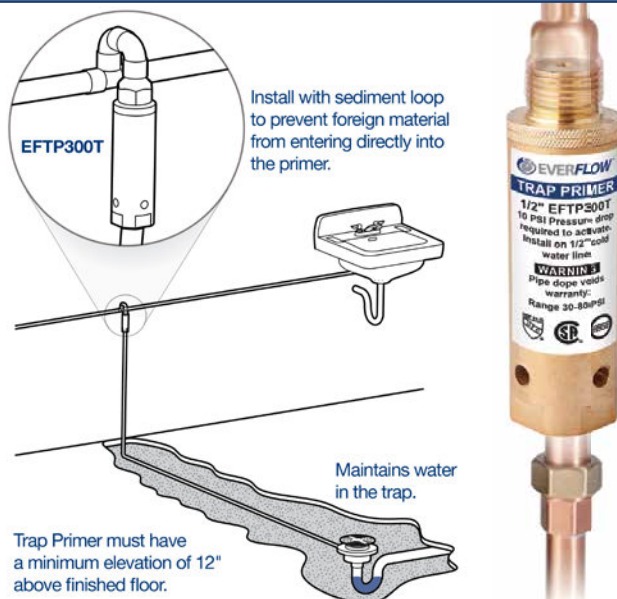

WATER SUPPLY STOP VALVES

Multi Turn Supply Stops

Lead Free • Multi Turn On / Off Design • One-piece Chrome Plated Brass Body

- One-Piece Chrome Plated Brass Body Provides Strength, Durability and Long-Lasting Performance
- Oval Chrome Plated Zinc Handle Provides a Secure Grip and Smooth On/Off Operation
- Easy-to-Remove Handle with Screw Attachment
- Lead Free Compliant
- 125 psi, Max Temperature 160°F
- Conforms to ASME A112.18.1-2011, NSF / ANSI 61 / 372
- Individually Bagged and Barcoded

Available in:

FIP/ SWT/ COMP/ CPVC/ PEX F1807



Multi Turn Angle Stop



| PART # | END TYPE | SIZE / DESCRIPTION | INNER | MASTER |
|------------|-----------|-----------------------------|-------|--------|
| 71114PR-NL | FIP | 1/2" FIP x 1/4" OD COMP | 10 | 200 |
| 71138PR-NL | FIP | 3/8" FIP x 3/8" OD COMP | 10 | 200 |
| 71112PR-NL | FIP | 1/2" FIP x 3/8" OD COMP | 10 | 200 |
| 71214PR-NL | SWEAT | 1/2" SWT x 1/4" OD COMP | 10 | 200 |
| 71212PR-NL | SWEAT | 1/2" SWT x 3/8" OD COMP | 10 | 200 |
| 71514PR-NL | COMP | 5/8" OD COMP x 1/4" OD COMP | 10 | 200 |
| 71358PR-NL | COMP | 5/8" OD COMP x 3/8" OD COMP | 12 | 144 |
| 71412PR-NL | CPVC | 1/2" CPVC x 3/8" OD COMP | 10 | 200 |
| 71512PR-NL | PEX F1807 | 1/2" PEX x 3/8" OD COMP | 10 | 200 |



Multi Turn Straight Stop



| PART # | END TYPE | SIZE / DESCRIPTION | INNER | MASTER |
|------------|-----------|-----------------------------|-------|--------|
| 72112PR-NL | FIP | 1/2" FIP x 3/8" OD COMP | 10 | 200 |
| 72138PR-NL | FIP | 3/8" FIP x 3/8" OD COMP | 10 | 200 |
| 72212PR-NL | SWEAT | 1/2" SWT x 3/8" OD COMP | 10 | 200 |
| 72358PR-NL | COMP | 5/8" OD COMP x 3/8" OD COMP | 10 | 200 |
| 72412PR-NL | CPVC | 1/2" CPVC x 3/8" OD COMP | 10 | 200 |
| 72512PR-NL | PEX F1807 | 1/2" PEX 3/8" OD COMP | 10 | 200 |



Multi Turn Stop W/5" Extension Tube



| PART # | END TYPE | SIZE / DESCRIPTION | INNER | MASTER |
|------------|----------|------------------------------------|-------|--------|
| 73212PR-NL | SWEAT | 1/2" SWT x 3/8" COMP Angle Stop | 10 | 100 |
| 74212PR-NL | SWEAT | 1/2" SWT x 3/8" COMP Straight Stop | 10 | 100 |



Multi Turn Dual Outlet Stop



| PART # | END TYPE | SIZE / DESCRIPTION | INNER | MASTER |
|------------|----------|-------------------------|-------|--------|
| 76358PR-NL | COMP | 5/8" x 3/8" x 3/8" COMP | 10 | 100 |

WATER SUPPLY STOP VALVES



1/4 Turn Supply Stops

Lead Free • 1/4 Turn Ball Valve Design • Chrome Plated Brass Body

- One-piece Chrome Plated Brass Body Provides Strength, Durability and Long-Lasting Performance
- Oval Chrome Plated Zinc Handle Provides a Secure Grip and Smooth On/Off Operation
- Easy-to-Remove Handle with Screw Attachment
- Self Lubricating PTFE Seats and Double O-Ring for Added Safety
- 100 psi, Normal Working Temperature 120°F
- Conforms to NSF/ANSI 61/372
- CSA & Truesdale Certified
- Individually Boxed and Barcoded

Available in:

FIP/ SWT/ COMP/ CPVC/ PEX F1807 & PEX F1960



1/4 Turn Angle Stop



| PART # | END TYPE | SIZE / DESCRIPTION | INNER | MASTER |
|--------------|-----------|-----------------------------|-------|--------|
| 81112PR-NL | FIP | 1/2" FIP x 3/8" OD COMP | 12 | 144 |
| 81114PR-NL | FIP | 1/2" FIP x 1/4" OD COMP | 12 | 144 |
| 81138PR-NL | FIP | 3/8" FIP x 3/8" OD COMP | 12 | 144 |
| 81212PR-NL | SWEAT | 1/2" SWT x 3/8" OD COMP | 12 | 144 |
| 81214PR-NL | SWEAT | 1/2" SWT x 1/4" OD COMP | 12 | 144 |
| 81358PR-NL | COMP | 5/8" OD COMP x 3/8" OD COMP | 12 | 144 |
| 81514PR-NL | COMP | 5/8" OD COMP x 1/4" OD COMP | 12 | 144 |
| 81412PR-NL | CPVC | 1/2" CPVC x 3/8" OD COMP | 12 | 144 |
| 81512PR-NL | PEX F1807 | 1/2" PEX 3/8" OD COMP | 12 | 144 |
| 81515PR-NL | PEX F1807 | 1/2" PEX 1/4" OD COMP | 12 | 144 |
| F-82512PR-NL | PEX F1960 | 1/2" F1960 x 3/8" COMP | 12 | 144 |



1/4 Turn Straight Stop



| PART # | END TYPE | SIZE / DESCRIPTION | INNER | MASTER |
|--------------|-----------|-----------------------------|-------|--------|
| 82112PR-NL | FIP | 1/2" FIP x 3/8" OD COMP | 12 | 144 |
| 82138PR-NL | FIP | 3/8" FIP x 3/8" OD COMP | 12 | 144 |
| 82212PR-NL | SWEAT | 1/2" SWT x 3/8" OD COMP | 12 | 144 |
| 82358PR-NL | COMP | 5/8" OD COMP x 3/8" OD COMP | 12 | 144 |
| 82412PR-NL | CPVC | 1/2" CPVC x 3/8" OD COMP | 12 | 144 |
| 82512PR-NL | F1807 PEX | 1/2" PEX 3/8" OD COMP | 12 | 144 |
| 82515PR-NL | F1807 PEX | 1/2" PEX 1/4" OD COMP | 12 | 144 |
| F-81512PR-NL | F1960 PEX | 1/2" F1960 x 3/8" COMP | 12 | 144 |



1/4 Turn Dual Outlet Stop



| PART # | SIZE | DESCRIPTION | INNER | MASTER |
|------------|------|-----------------------------------|-------|--------|
| 86314PR-NL | FIP | 1/2" FIP x 3/8" Comp x 1/4" Comp | 10 | 100 |
| 86311PR-NL | FIP | 1/2" FIP x 3/8" Comp x 3/8" Comp | 10 | 80 |
| 86312PR-NL | SWT | 1/2" SWT X 3/8" Comp X 1/4" Comp | 5 | 50 |
| 86324PR-NL | SWT | 1/2" SWT X 3/8" Comp X 3/8" Comp | 5 | 40 |
| 86351PR-NL | PEX | 5/8" Comp x 3/8" Comp x 3/8" Comp | 5 | 30 |
| 86358PR-NL | COMP | 1/2" PEX x 3/8" Comp x 3/8" Comp | 2 | 20 |

WATER SUPPLY STOP VALVES

1/4 Turn Supply Stops continued



Lead Free • 1/4 Turn Ball Valve Design • Chrome Plated Brass Body



1/4 Turn Stop W/5" Extension Tube



| PART # | END TYPE | SIZE / DESCRIPTION | INNER | MASTER |
|------------|----------|------------------------------------|-------|--------|
| 83212PR-NL | SWEAT | 1/2" SWT x 3/8" COMP Angle Stop | 10 | 100 |
| 84212PR-NL | SWEAT | 1/2" SWT x 3/8" COMP Straight Stop | 10 | 100 |



1/4 Turn Loose Key Angle Stop



| PART # | END TYPE | SIZE / DESCRIPTION | INNER | MASTER |
|------------|----------|-----------------------------|-------|--------|
| 91112PR-NL | FIP | 1/2" FIP x 3/8" OD COMP | 12 | 144 |
| 91212PR-NL | SWEAT | 1/2" SWT x 3/8" COMP | 12 | 144 |
| 91358PR-NL | COMP | 5/8" OD COMP x 3/8" OD COMP | 12 | 144 |



1/4 Turn Loose Key Straight Stop



| PART # | END TYPE | SIZE / DESCRIPTION | INNER | MASTER |
|------------|----------|-----------------------------|-------|--------|
| 92112PR-NL | FIP | 1/2" FIP x 3/8" OD COMP | 12 | 144 |
| 92212PR-NL | SWEAT | 1/2" SWT x 3/8" COMP | 12 | 144 |
| 92358PR-NL | COMP | 5/8" OD COMP x 3/8" OD COMP | 12 | 144 |
| 93212PR-NL | SWEAT | 1/2" SWT x 3/8" COMP | 25 | 100 |



FIP x MIP Add On Valve



| PART # | END TYPE | SIZE / DESCRIPTION | INNER | MASTER |
|------------|----------|--------------------------------|-------|--------|
| 82314PR-NL | COMP | 3/8" COMP FEM X 1/4" COMP Male | 12 | 144 |
| 82338PR-NL | COMP | 3/8" COMP FEM X 3/8" COMP Male | 12 | 144 |

Easy Connect Supply Stop Tee



Lead Free • Brass Construction



Easy Connect Tee



| PART # | END TYPE | SIZE / DESCRIPTION | INNER | MASTER |
|----------|----------|---------------------------------------|-------|--------|
| 73314-NL | COMP | 3/8" FEM COMP x 3/8" MALE x 1/4" MALE | 12 | 144 |
| 73338-NL | COMP | 3/8" FEM COMP x 3/8" MALE x 3/8" MALE | 12 | 144 |

WATER SUPPLY STOP VALVES

RAVEN
 SPECIALTY PRODUCTS

1/4 Turn Supply Stop Valves

Lead Free • 1/4 Turn Ball Valve Design • Chrome Plated Brass Body

- One-Piece Chrome Plated Brass Body Provides Strength, Durability and Long-Lasting Performance
- Oval Chrome Plated Zinc Handle Provides a Secure Grip and Smooth On/Off Operation
- Easy-to-Remove Handle with Screw Attachment
- Self Lubricating PTFE Seats and Double O-Ring for Added Safety
- 100 psi, Normal Working Temperature 120°F
- Conforms to NSF/ANSI 61/372
- Individually Boxed and Barcoded

Available in:

FIP/ SWT/ COMP/ CPVC/ PEX F1807 & PEX F1960



1/4 Turn Angle Stop



| PART # | END TYPE | SIZE / DESCRIPTION | INNER | MASTER |
|--------------|-----------|------------------------|-------|--------|
| 27-CA14-NL | COMP | 1/4" COMP x 3/8" COMP | 12 | 144 |
| 27-CA58-NL | COMP | 5/8" COMP X 3/8" COMP | 12 | 144 |
| 27-CPA12-NL | CPVC | 11/2" CPVC X 3/8" COMP | 12 | 144 |
| 27-PA1214-NL | F1807 PEX | 1/2" PEX 1/4" COMP | 12 | 144 |
| 27-PA12-NL | F1807 PEX | 1/2" PEX 3/8" COMP | 12 | 144 |



1/4 Turn Straight Stop



| PART # | END TYPE | SIZE / DESCRIPTION | INNER | MASTER |
|--------------|-----------|------------------------|-------|--------|
| 27-CS14-NL | F1960 PEX | 1/4" COMP x 3/8" COMP | 12 | 144 |
| 27-CS58-NL | F1960 PEX | 5/8" COMP X 3/8" COMP | 12 | 144 |
| 27-CPS12-NL | F1960 PEX | 11/2" CPVC X 3/8" COMP | 12 | 144 |
| 27-PS1214-NL | F1960 PEX | 1/2" PEX 1/4" COMP | 12 | 144 |
| 27-PS12-NL | F1960 PEX | 1/2" PEX 3/8" COMP | 12 | 144 |



1/4 Turn Stop W/5" Extension Tube



| PART # | END TYPE | SIZE / DESCRIPTION | INNER | MASTER |
|-------------|----------|-------------------------------|-------|--------|
| 27-ESS12-NL | COMP | 1/2" SWT X 3/8" COMP Staright | 12 | 144 |
| 27-ESA12-NL | COMP | 1/2" SWT X 3/8" COMP Angle | 12 | 144 |



1/4 Turn Loose Key Angle Stop



| PART # | END TYPE | SIZE / DESCRIPTION | INNER | MASTER |
|-------------|-----------|-----------------------|-------|--------|
| 27-KPA12-NL | F1807 PEX | 1/2" PEX X 3/8" COMP | 20 | 240 |
| 27-KSA12-NL | SWEAT | 1/2" SWT x 3/8" COMP | 20 | 240 |
| 27-KCA58-NL | COMP | 5/8" COMP x 3/8" COMP | 20 | 240 |

WATER SUPPLY STOP VALVES

1/4 Turn Supply Stop Valves continued

RAVEN
SPECIALTY PRODUCTS

Lead Free • 1/4 Turn Ball Valve Design • Chrome Plated Brass Body



1/4 Turn Loose Key Straight Stop



| PART # | END TYPE | SIZE / DESCRIPTION | INNER | MASTER |
|-------------|-----------|-----------------------|-------|--------|
| 27-KPS12-NL | F1807 PEX | 1/2" PEX X 3/8" COMP | 20 | 240 |
| 27-KSS12-NL | SWEAT | 1/2" SWT x 3/8" COMP | 20 | 240 |
| 27-KCS58-NL | COMP | 5/8" COMP x 3/8" COMP | 20 | 240 |



F1960 Pex Water Supply Stop



| PART # | END TYPE | SIZE / DESCRIPTION | INNER | MASTER |
|--------------|-----------|---------------------------------|-------|--------|
| 27-WA1214-NL | F1960 PEX | 1/2" F1960 x 1/4" Comp Angle | 10 | 100 |
| 27-WA12-NL | F1960 PEX | 1/2" F1960 x 3/8" Comp Angle | 10 | 100 |
| 27-WS12-NL | F1960 PEX | 1/2" F1960 x 3/8" Comp Staright | 10 | 100 |



Fix-A-Valve Water Supply Stop



| PART # | END TYPE | SIZE / DESCRIPTION | INNER | MASTER |
|------------|----------|----------------------|-------|--------|
| 27-FS38-NL | FIP | 3/8" FIP X 3/8" MALE | 12 | 144 |

Push-Fit Supply Stop Valves



Lead Free • 1/4 Turn Ball Valve Design • Chrome Finish

- Chrome Plated brass Body Provides Strength, Durability and Long-Lasting Performance
- Metal Handle
- Slim Fitting Design
- 200 PSI WOG



CONNECTS TO



Push Fit 1/4 Turn Angle Stop



| PART # | END TYPE | SIZE / DESCRIPTION | INNER | MASTER |
|-----------|-------------|-----------------------|-------|--------|
| UPASC1214 | Push X Comp | 1/2" Push x 1/4" Comp | 5 | 30 |
| UPASC1238 | Push X Comp | 1/2" Push x 3/8" Comp | 5 | 30 |
| UPASP1212 | Push X Push | 1/2" Push x 1/2" Push | 5 | 30 |



Push Fit 1/4 Turn Straight Stop



| PART # | END TYPE | SIZE / DESCRIPTION | INNER | MASTER |
|-----------|-------------|-----------------------|-------|--------|
| UPSSC1214 | Push X Comp | 1/2" Push x 1/4" Comp | 5 | 30 |
| UPSSC1238 | Push X Comp | 1/2" Push x 3/8" Comp | 5 | 30 |
| UPSSP1212 | Push X Push | 1/2" Push x 1/2" Push | 5 | 30 |

SPECIALTY SUPPLY VALVES

Dual Washing Machine Valve

RAVEN
SPECIALTY PRODUCTS

Ball Style



- Cast Brass Construction
- For Use with Washing Machine Shut Off
- Single On/Off Lever Controls Hot & Cold Water Simultaneously

| PART # | SIZE / DESCRIPTION | INNER | MASTER |
|--------|------------------------|-------|--------|
| WMV12 | 1/2" Sweat X 3/4" Hose | 1 | 24 |

Pex Drop Ear Ice Maker Valve

RAVEN
SPECIALTY PRODUCTS

Ball Style Dishwasher Valve



- 1/4 Turn
- Lead Free
- Compatible with F1807 PEX and F1960 PEX
- Drop Ears for Secure Mounting

| PART # | SIZE / DESCRIPTION | INNER | MASTER |
|-----------|----------------------------|-------|--------|
| WIMV12-NL | 1/2" F1960 PEX x 1/4" Comp | 10 | 100 |
| PIMV12-NL | 1/2" F1807 PEX x 1/4" Comp | 10 | 100 |

Ice Maker/Humidifier Valve

RAVEN
SPECIALTY PRODUCTS

Comp x Comp Ice Maker Valve



- 1/4 Turn
- Lead Free
- Connect Ice Maker to 1/2" copper pipe

| PART # | SIZE / DESCRIPTION | INNER | MASTER |
|----------|--|-------|--------|
| IMV58-NL | 5/8" comp / 1/2" Sweat end x 1/4" Comp | 10 | 100 |
| IMV78-NL | 7/8" comp / 3/4" Sweat end x 1/4" Comp | 10 | 100 |
| IMV38 | 3/8" comp / 1/4" Sweat end x 1/4" Comp | 10 | 100 |

Dishwasher Valve

RAVEN
SPECIALTY PRODUCTS

Ball Style Dishwasher Valve



- 1/4 Turn
- Lead Free
- Connect Dishwasher to 1/2" & 3/8" Copper Pipe

| PART # | SIZE / DESCRIPTION | INNER | MASTER |
|----------|--|-------|--------|
| DWV38-NL | 5/8" comp / 1/2" Sweat end x 3/8" Comp | 1 | 1 |

Brass Anti-Sweat Valve

RAVEN
SPECIALTY PRODUCTS

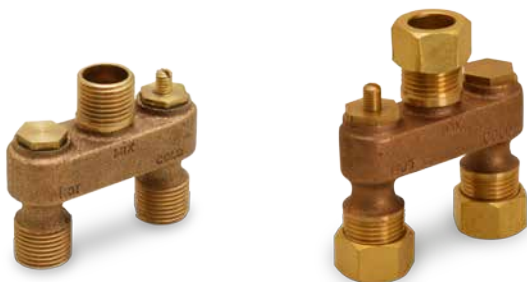

| PART # | SIZE / DESCRIPTION | INNER | MASTER |
|--------|-------------------------------------|-------|--------|
| R1290 | 1/2" Brass Anti-Sweat Valve | 1 | 36 |
| R1291 | 1/2" Brass Anti-Sweat Valve w/ Nuts | 1 | 24 |

Chrome Plated Anti-Sweat Valve

RAVEN
SPECIALTY PRODUCTS



| PART # | SIZE / DESCRIPTION | INNER | MASTER |
|--------|---|-------|--------|
| R1293 | 1/2" Chrome Plated Anti-Sweat Valve | 10 | 50 |
| R1292 | 1/2" Chrome Plated Anti-Sweat Valve w/ Nuts | 1 | 36 |

Anti-Sweat Valve Repair Kit

| PART # | SIZE / DESCRIPTION | INNER | MASTER |
|--------|-----------------------------|-------|--------|
| R1296 | Anti-Sweat Valve Repair Kit | 1 | 1 |

RAVEN™
SPECIALTY PRODUCTS

Hydronic Heating Components

High Grade Performance



NOW AVAILABLE
THERMAL & HYDRONIC EXPANSION TANKS MADE IN ITALY



FLEXTROL

HEATING SPECIALTIES

Feed Pressure Water Regulator

RAVEN
SPECIALTY PRODUCTS

High Capacity • Purge Lever For Manual Purging



- High Capacity
- Tight Seating Check Valve
- Purge Lever for Manual Purging
- Choice of Inlet Connection (Threaded, Union Solder)
- Stainless Steel Strainer to Protect the Valve Disc from Fouling

| PART # | SIZE | DESCRIPTION | INNER | MASTER |
|----------|------|-------------------------------|-------|--------|
| 186TS012 | 1/2" | Feed Pressure Water Regulator | 1 | 40 |
| 186TS034 | 3/4" | Feed Pressure Water Regulator | 1 | 40 |

Backflow Preventer

RAVEN
SPECIALTY PRODUCTS

High Capacity • Stainless Steel Internal Parts



- True Line Size Construction
- Stainless Steel Internal Parts
- Maximum Flow at Low Pressure Drop
- Install Vertically or Horizontally
- Furnished with Union Connectors to Facilitate Removal

| PART # | SIZE | DESCRIPTION | INNER | MASTER |
|---------|------|--------------------|-------|--------|
| 190T012 | 1/2" | Backflow Preventer | 1 | 60 |
| 190T034 | 3/4" | Backflow Preventer | 1 | 60 |

Heating Boiler Air Scoop

RAVEN
SPECIALTY PRODUCTS

Cast Iron Construction • Air Eliminator



- One Piece Design
- Engineered Baffle to Separate Air From Water
- Never Requires Servicing
- Cast Iron Construction

| PART # | SIZE | DESCRIPTION | INNER | MASTER |
|---------------|--------|-----------------------|-------|--------|
| ETP-T15-AS34 | 3/4" | 3/4" Air Eliminator | 10 | 60 |
| ETP-T15-AS1 | 1" | 1" Air Eliminator | 25 | 100 |
| ETP-T15-AS114 | 1 1/4" | 1 1/4" Air Eliminator | 10 | 40 |
| ETP-T15-AS112 | 1 1/2" | 1 1/2" Air Eliminator | 10 | 60 |

Automatic Air Vent

RAVEN
SPECIALTY PRODUCTS

Nickel Plated Brass body



- Perfect for Tight Spaces
- Removes Trapped Air
- For Use on Heating and Air Conditioning Systems

| PART # | SIZE | DESCRIPTION | INNER | MASTER |
|--------|------|--------------------|-------|--------|
| AV-T18 | 1/8" | Automatic Air Vent | 1 | 68 |

HEATING SPECIALTIES



Ravent Jr. Spiral Air Eliminator

Micro Bubble Separator • Maintenance Free • Eliminates 99.6% of the Disolved Air



IPS



SWT

- Simple to Install with a Atraight In-Line Design
- Designed for Radiant Heat and Hydronic Systems
- Solid Brass Body Construction for Extended Service Life
- Traps Smallest Microbubbles with Little Resistance
- Spiral Tube Vent Eliminates Air from the System Fluid
- Specially Constructed Air Chamber to Protect the Valve Mechanism from Dirt
- Unique Valve Mechanism is Guaranteed Not to Leak and Cannot be Shut Off
- Standard Thread for Vent Pipe Connection or Pressure Testing
- Vent Head is Designed to Stay Dry
- Male Thread Vent Head Port for Presuure Testing and Remote Venting
- No Venting Required
- Dirt and Leak Resistant
- Quiet Operation
- Available in Threaded & Sweat Connection
- Max Pressure 150 PSI
- Max Temperature 270°F

| THREADED PART # | SWEAT PART # | SIZE | DESCRIPTION | INNER | MASTER |
|-----------------|--------------|--------|-----------------------|-------|--------|
| RAV-SP034T | RAV-SP034S | 3/4" | Spiral Air Eliminator | 10 | 100 |
| RAV-SP001T | RAV-SP001S | 1" | Spiral Air Eliminator | 10 | 100 |
| RAV-SP114T | RAV-SP114S | 1-1/4" | Spiral Air Eliminator | 10 | 100 |
| RAV-SP112T | RAV-SP112S | 1-1/2" | Spiral Air Eliminator | 10 | 80 |
| RAV-SP002T | RAV-SP002S | 2" | Spiral Air Eliminator | 5 | 50 |

Z1000 Series Motorized Zone Valve



2 Way On/Off • Low Voltage



- Brass Body
- Hydronic Control
- Designed for Cycling
- Static Pressure 125 PSI
- EPDM O-Rings

| PART # | SIZE | DESCRIPTION | INNER | MASTER |
|--------|------|---------------------------------------|-------|--------|
| Z1000 | | Motorized 2-way on-off Zone Valve | 1 | 1 |
| Z1010 | | Replacement Head for Z1000 Zone Valve | 1 | 1 |

EXPANSION TANKS

Thermal Expansion Tanks For Hot Water Heaters

FLEXTROL®

Prevent Dangerous Pressure Build Up • Protect Appliances and Fixtures • Save Energy and Water



- Shell and Connection Made of Carbon Steel
- All Tanks are NSF61 Certified
- MIG Welding Eliminates Interior Rough Spots and Sharp Edges
- Each Tank is Factory Leak Tested
- External Baked Epoxy-Polyester Coating Provides a Durable Appliance Finish
- Exclusive Polypropylene Liner Eliminates Internal Corrosion
- Protected Precharge Valve Eliminates Potential Leak Path
- Max. Operating Pressure 150 PSI
- Operating Temperature 210°F



| PART # | SIZE | DESCRIPTION | INNER | MASTER |
|--------|---------|------------------------|-------|--------|
| FTT5 | 2.1 gal | Thermal Expansion Tank | 1 | 1 |
| FTT12 | 4.8 gal | Thermal Expansion Tank | 1 | 1 |
| FTT18 | 6.3 gal | Thermal Expansion Tank | 1 | 1 |

Hydronic Expansion Tanks For Heating Systems

FLEXTROL®

Prevent Dangerous Pressure Build Up • Protect Safety Valves from Failing • Save Energy and Water



- Shell and Connection Made of Carbon Steel
- Certified Synthetic SBR Rubber Diaphragm
- MIG Welding Eliminates Interior Rough Spots and Sharp Edges
- Each Tank is Factory Leak Tested to Ensure Tank Integrity
- All Diaphragms Designed to Maximize Drawdown
- External Baked Epoxy-Polyester Coating Provides a Durable Appliance Finish
- Welded Side Outlet Allows Easy and Quick Installation
- Protected Pre Charge Valve Eliminates Potential Leak Path
- Low Profile Tank Design with Full Membrane Depth Eliminates Stretching of Diaphragm, Providing Increased Life Cycle
- Max. Operating Pressure 2.1 gal 75 PSI 3.2, 4.8 & 13.2 gal 60 PSI
- Operating Temperature 210°F
- Factory Precharge 12 PSI
- Max. Operating Pressure 13.2 gal 60 PSI
- The FTH90 is Designed with Built-In Stand



| PART # | TANK SIZE | DESCRIPTION | INNER | MASTER |
|--------|-----------|--|-------|--------|
| FTH15 | 2.1 gal | Hydronic Expansion Tank | 1 | 1 |
| FTH30 | 4.8 gal | Hydronic Expansion Tank | 1 | 1 |
| FTH60 | 6.3 gal | Hydronic Expansion Tank | 1 | 1 |
| FTH90 | 13.2 gal | Hydronic Expansion Tank w/Built In Stand | 1 | 1 |

RADIATOR VALVES

Steam Angle Radiator Valve



FIP X Male Union • 15 WSP - 60 WOG



- Brass Body
- Includes Nut and Tailpiece
- Molded Thermal Plastic Handle
- ISO:9001 Approved Manufacturer

| PART # | SIZE | DESCRIPTION | INNER | MASTER |
|--------|--------|----------------------------|-------|--------|
| 48712 | 1/2" | Angle Steam Radiator Valve | 10 | 60 |
| 48342 | 3/4" | Angle Steam Radiator Valve | 8 | 48 |
| 48120 | 1" | Angle Steam Radiator Valve | 6 | 36 |
| 48142 | 1-1/4" | Angle Steam Radiator Valve | 4 | 24 |
| 48112 | 1-1/2" | Angle Steam Radiator Valve | 3 | 18 |
| 48200 | 2" | Angle Steam Radiator Valve | 2 | 12 |

Steam Radiator Gate Valve



FIP X Male Union • 125 WSP - 200 WOG



- Brass Body
- Temperature rating 300°F
- Includes Nut and Tailpiece
- Molded Thermal Plastic Handle
- ISO:9001 Approved Manufacturer

| PART # | SIZE | DESCRIPTION | INNER | MASTER |
|--------|--------|---------------------------|-------|--------|
| 48612 | 1/2" | Steam Radiator Gate Valve | 10 | 60 |
| 48341 | 3/4" | Steam Radiator Gate Valve | 8 | 48 |
| 48111 | 1" | Steam Radiator Gate Valve | 6 | 36 |
| 48141 | 1-1/4" | Steam Radiator Gate Valve | 4 | 24 |
| 48121 | 1-1/2" | Steam Radiator Gate Valve | 3 | 18 |

Hot Water Angle Radiator Valve



FIP or SWT X Male Union • Heavy Pattern • 15 WSP - 60 WOG



- Brass Body
- Includes Nut and Tailpiece
- Molded Thermal Plastic Handle
- ISO:9001 Approved Manufacturer

| THREADED PART # | SWEAT PART # | SIZE | DESCRIPTION | INNER | MASTER |
|-----------------|--------------|--------|----------------------|-------|--------|
| HWV-T012 | HWV-S012 | 1/2" | Radiator Angle Valve | 10 | 80 |
| HWV-T034 | HWV-S034 | 3/4" | Radiator Angle Valve | 6 | 60 |
| HWV-T001 | HWV-S001 | 1" | Radiator Angle Valve | 6 | 36 |
| HWV-T114 | | 1-1/4" | Radiator Angle Valve | 4 | 24 |

Steam Radiator Converter Valve



Female Union x FIP Connection • 15 WSP 60 WOG



- Brass Body
- Includes Nut and Tailpiece
- Molded Thermal Plastic Handle
- ISO:9001 Approved Manufacturer

| PART # | SIZE | DESCRIPTION | INNER | MASTER |
|--------|--------|--------------------------------|-------|--------|
| 48130 | 1" | Steam Radiator Converter Valve | 6 | 36 |
| 48143 | 1-1/4" | Steam Radiator Converter Valve | 4 | 24 |

RADIATOR VALVES

Steam Angle Radiator Valve

RAVEN
SPECIALTY PRODUCTS

PTFE Seats • FIP X Male Union • 15 WSP - 60 WOG

HEAVY DUTY

- Heavy Duty Brass Body
- Includes Nut and Tailpiece
- Molded Thermal Plastic Handle
- ISO:9001 Approved Manufacturer

| PART # | SIZE | DESCRIPTION | INNER | MASTER |
|--------|--------|----------------------------|-------|--------|
| RSA012 | 1/2" | Angle Steam Radiator Valve | 10 | 60 |
| RSA034 | 3/4" | Angle Steam Radiator Valve | 8 | 48 |
| RSA001 | 1" | Angle Steam Radiator Valve | 6 | 36 |
| RSA114 | 1-1/4" | Angle Steam Radiator Valve | 4 | 24 |
| RSA112 | 1-1/2" | Angle Steam Radiator Valve | 3 | 18 |

Steam Radiator Gate Valve

RAVEN
SPECIALTY PRODUCTS

FIP X Male Union • 125 WSP - 200 WOG

HEAVY DUTY

- Heavy Duty Brass Body
- Temperature rating 300°F
- Includes Nut and Tailpiece
- Molded Thermal Plastic Handle
- ISO:9001 Approved Manufacturer

| PART # | SIZE | DESCRIPTION | INNER | MASTER |
|--------|--------|---------------------------|-------|--------|
| RSS034 | 3/4" | Steam Radiator Gate Valve | 8 | 48 |
| RSS001 | 1" | Steam Radiator Gate Valve | 6 | 36 |
| RSS114 | 1-1/4" | Steam Radiator Gate Valve | 4 | 24 |
| RSS112 | 1-1/2" | Steam Radiator Gate Valve | 3 | 18 |

Hot Water Angle Radiator Valve

RAVEN
SPECIALTY PRODUCTS

FIP or SWT X Male Union • Heavy Pattern • 15 WSP - 60 WOG

HEAVY DUTY

-
-
-
-

| THREADED PART # | SWEAT PART # | SIZE | DESCRIPTION | INNER | MASTER |
|-----------------|--------------|------|----------------------|-------|--------|
| RWA012T | RWA012S | 1/2" | Radiator Angle Valve | 10 | 80 |
| RWA034T | RWA034S | 3/4" | Radiator Angle Valve | 6 | 60 |
| RWA001T | RWA001S | 1" | Radiator Angle Valve | 6 | 36 |

Steam Radiator Converter Valve

RAVEN
SPECIALTY PRODUCTS

PTFE Seats • Female Union x FIP Connection • 15 WSP 60 WOG

HEAVY DUTY

- Heavy Duty Brass Body
- Includes Nut and Tailpiece
- Molded Thermal Plastic Handle
- ISO:9001 Approved Manufacturer

| PART # | SIZE | DESCRIPTION | INNER | MASTER |
|--------|--------|--------------------------------|-------|--------|
| RSC001 | 1" | Steam Radiator Converter Valve | 6 | 36 |
| RSC114 | 1-1/4" | Steam Radiator Converter Valve | 4 | 24 |

HEATING SPECIALTIES

IPS & SWT Union Elbow



Includes Nut & Tailpiece •



- Brass Body
- Available in Sweat and Threaded Ends
- ISO:9001 Approved Manufacturer

| THREADED PART # | SWEAT PART # | SIZE | DESCRIPTION | INNER | MASTER |
|-----------------|--------------|--------|-------------|-------|--------|
| 48212 | 48312 | 1/2" | Union Elbow | 10 | 150 |
| 48234 | 48334 | 3/4" | Union Elbow | 10 | 100 |
| 4821 | | 1" | Union Elbow | 7 | 70 |
| 48214 | | 1-1/4" | Union Elbow | 5 | 50 |

Sweat Monoflow Tee



Brass Body



- Brass Body
- Used in One Pipe Hot Water Heating Systems
- Supplies Radiators, Convectors, Baseboards & Kick Space Heaters
- ISO:9001 Approved Manufacturer

| PART # | SIZE | DESCRIPTION | INNER | MASTER |
|--------|---------------|------------------|-------|--------|
| 3412 | 3/4" X 1/2" | SWT Monoflow Tee | 40 | 160 |
| 0112 | 1" X 1/2" | SWT Monoflow Tee | 25 | 100 |
| 0134 | 1" X 3/4" | SWT Monoflow Tee | 25 | 100 |
| 11412 | 1-1/4" X 1/2" | SWT Monoflow Tee | 20 | 80 |

Pex Monoflow Tee



Available in Crimp PEX & Expansion Pex



- Crimp Pex Ends Conform to ASTM F1807
- Expansion Pex Ends Conform to ASTM F1960
- Supplies Radiators, Convectors, Baseboards & Kick Space Heaters

| PART # | SIZE / DESCRIPTION | INNER | MASTER |
|----------|---|-------|--------|
| MFPT0058 | 5/8" F1807 Pex | 10 | 100 |
| MFPS3412 | 3/4" F1807 Pex x 3/4" F1807 Pex x 1/2" Swt | 10 | 100 |
| MFPT3412 | 3/4" F1807 Pex x 3/4" F1807 Pex x 1/2" F1807 Pex | 10 | 100 |
| MFWT3412 | 3/4" F1960 Pex x 3/4" F1960 Pex" x 1/2" F1960 Pex | 10 | 100 |

Pigtails



| PART # | SIZE / DESCRIPTION | INNER | MASTER |
|----------|--------------------------------|-------|--------|
| BRPS0014 | 1/4" Straight Pigtail Brass | 10 | 100 |
| BRPA0014 | 1/4" Angle Pigtail Brass | 10 | 100 |
| BLPT0014 | 1/4" Angle Pigtail Black Steel | 10 | 100 |

Baseboard Connector



Coupling x Coupling Connector

| PART # | SIZE | DESCRIPTION | INNER | MASTER |
|--------|-----------|---------------------|-------|--------|
| R1644 | 3/4" x 6" | Baseboard Connector | 1 | 24 |

Tubing x Tubing Connector

| PART # | SIZE | DESCRIPTION | INNER | MASTER |
|--------|------------|---------------------|-------|--------|
| R1641 | 3/4" x 18" | Baseboard Connector | 1 | 24 |

Tubing x Coupling Connector

| PART # | SIZE | DESCRIPTION | INNER | MASTER |
|--------|---------------|---------------------|-------|--------|
| R1643 | 3/4" x 8" | Baseboard Connector | 1 | 12 |
| R1640 | 3/4" x 18" | Baseboard Connector | 1 | 24 |
| R1642 | 3/4" x 18" AC | Baseboard Connector | 1 | 24 |

HEATING SPECIALTIES

Radiator Spud Wrench



The Radiator Spud Wrench goes inside of the pipe to easily remove and replace an old radiator valve.

Radiator Spud Wrench



Inner Pipe Wrench • For Radiator Valve Repairs



- Use to Remove and Install Radiator Valve Spuds from Radiator
- Made of Durable Cast Malleable Iron
- Insert in Radiator Nipple Until Proper Size Reached

| PART # | SIZE | DESCRIPTION | INNER | MASTER |
|--------|-----------------------|-------------|-------|--------|
| 402443 | 1-1/2" x 2" x 10-1/4" | Spud Wrench | 10 | 60 |

3 in 1 Radiator Repair Tool



HVAC Tool • For Radiator Air Valve Repairs



- Black Steel
- Extracts, Re-taps, and Rethreads Broken Valves in Radiators
- Steel Construction

| PART # | SIZE | DESCRIPTION | INNER | MASTER |
|--------|--------------------|----------------------|-------|--------|
| 48612 | 3/4" x 3" x 2-3/4" | Radiator Repair Tool | 10 | 60 |

Radiator Handle Replacement Kit



Molded Thermal Plastic Handle

- Molded Embossed Direction Arrow
- Designed to Work with a Hot-Water or Steam Valve
- 3-Step Metal insert
- Fits All Popular Stems



| PART # | SIZE | DESCRIPTION | INNER | MASTER |
|--------|----------|-------------------------|-------|--------|
| 48403 | Fits All | Plastic Radiator Handle | 12 | 144 |

Radiator Handle Replacement



Molded Thermal Plastic Handle

- Molded Embossed Direction Arrow
- Designed to Work with a Hot-Water or Steam Valve
- Fits All Popular Stems



| PART # | SIZE | DESCRIPTION | INNER | MASTER |
|--------|----------|-------------------------|-------|--------|
| 4800 | Fits All | Plastic Radiator Handle | 12 | 144 |

RADIATOR AIR VALVES

Radiator Air Valve



- Chrome Plated Steam Air Valves
- Max Pressure - 10 PSI



| PART # | SIZE | DESCRIPTION | INNER | MASTER |
|--------|------|---------------------------------|-------|--------|
| 49182 | 1/8" | Angle Steam Air Vent | 12 | 144 |
| 49183 | 1/8" | Angle Adjustable Steam Air Vent | 12 | 144 |
| 49181 | 1/8" | Straight Steam Air Vent | 12 | 144 |
| 49141 | 1/4" | Straight Steam Air Vent | 12 | 144 |
| 49341 | 3/4" | Straight Steam Air Vent | 12 | 144 |

Radiator Air Valve Gorton Style



- Max Operating Pressure - 5 PSI
- Max Pressure - 10 PSI



| PART # | SIZE | DESCRIPTION | INNER | MASTER |
|----------|------|-------------------------|-------|--------|
| GAV-4A18 | 1/8" | Angle Steam Air Vent | 12 | 144 |
| GAV-5A18 | 1/8" | Angle Steam Air Vent | 12 | 144 |
| GAV-6A18 | 1/8" | Angle Steam Air Vent | 12 | 144 |
| GAV-CA18 | 1/8" | Angle Steam Air Vent | 12 | 144 |
| GAV-DA18 | 1/8" | Angle Steam Air Vent | 12 | 144 |
| GAV-6S18 | 1/8" | Straight Steam Air Vent | 12 | 144 |
| GAV-CS18 | 1/8" | Straight Steam Air Vent | 12 | 144 |
| GAV-DS18 | 1/8" | Straight Steam Air Vent | 12 | 144 |

Radiator Air Valve



- Max Operating Pressure - 5 PSI
- Max Pressure - 10 PSI



| PART # | SIZE | DESCRIPTION | INNER | MASTER |
|-----------|-------------|-------------------------|-------|--------|
| HAV-A0018 | 1/8" | Angle Steam Air Vent | 12 | 144 |
| HAV-S0018 | 1/8" | Straight Steam Air Vent | 12 | 144 |
| HAV-S0014 | 1/4" | Straight Steam Air Vent | 12 | 144 |
| HAV-S3412 | 3/4" X 1/2" | Straight Steam Air Vent | 12 | 144 |

Automatic Air Valve w/ Plastic Knob



| PART # | SIZE | DESCRIPTION | INNER | MASTER |
|--------|------|---------------|-------|--------|
| 48500 | 1/8" | Male Threaded | 10 | 100 |

Automatic Air Valve w/ Slot Knob



| PART # | SIZE | DESCRIPTION | INNER | MASTER |
|--------|------|---------------|-------|--------|
| 48503 | 1/8" | Male Threaded | 10 | 100 |

Radiator Air Valve Hoffman Style



- Float-Type Vent
- Highly Durable



| PART # | SIZE | DESCRIPTION | INNER | MASTER |
|-----------|-------------|---------------------------------|-------|--------|
| RAVHA18 | 1/8" | Angle Steam Air Vent | 12 | 144 |
| RAVHA18A | 1/8" | Angle Adjustable Steam Air Vent | 12 | 144 |
| RAVHS18 | 1/8" | Straight Steam Air Vent | 12 | 144 |
| RAVHS14 | 1/4" | Straight Steam Air Vent | 12 | 144 |
| RAVHS3412 | 3/4" X 1/2" | Straight Steam Air Vent | 12 | 144 |

Radiator Air Valve Gorton Style



- Steam Air Vent



| PART # | SIZE | DESCRIPTION | INNER | MASTER |
|----------|---------|-------------------------|-------|--------|
| RAVG18-4 | #4 1/8" | Angle Steam Air Vent | 10 | 60 |
| RAVG18-5 | #5 1/8" | Angle Steam Air Vent | 8 | 48 |
| RAVG18-6 | #6 1/8" | Angle Steam Air Vent | 6 | 36 |
| RAVG18-D | #C 1/8" | Angle Steam Air Vent | 10 | 60 |
| RSVG18-6 | #D 1/8" | Angle Steam Air Vent | 10 | 60 |
| RSVG18-6 | #6 1/8" | Straight Steam Air Vent | 6 | 36 |
| RSVG18-C | #C 1/8" | Straight Steam Air Vent | 10 | 60 |
| RSVG18-D | #D 1/8" | Straight Steam Air Vent | 10 | 60 |

Float Valves



- Perfect for Tight spaces
- 50 PSI
- For Use on Convector Radiators, Radiant Baseboard & Radiant Panels



| PART # | SIZE | DESCRIPTION | INNER | MASTER |
|---------|------|-------------|-------|--------|
| LF-FV18 | 1/8" | Float Vent | 10 | 50 |

Coin Key Air Valve



| PART # | SIZE | DESCRIPTION | INNER | MASTER |
|--------|------|---------------|-------|--------|
| 48400 | 1/8" | Male Threaded | 10 | 100 |

Key For Coin Air Valve



| PART # | SIZE | DESCRIPTION | INNER | MASTER |
|--------|------|----------------------|-------|--------|
| 48401 | 1/8" | Key for Part # 48400 | 10 | 100 |

HEATING SPECIALTIES

Ductile Iron Circulator Flange Kit

RAVEN
SPECIALTY PRODUCTS



- For Taco/Grundfos
- All Circulator Flanges are Packaged with Nuts & Bolts
- New High Grip Surface
- Ideal for Use with Pipe Wrench

| GREEN PART # | RED PART # | SIZE | DESCRIPTION | INNER | MASTER |
|--------------|------------|--------|-------------|-------|--------|
| DIFLNG34G | DIFLNG34R | 3/4" | Flange Kit | 25 | 100 |
| DIFLNG1G | DIFLNG1R | 1" | Flange Kit | 12 | 12 |
| DIFLNG114G | DIFLNG114R | 1-1/4" | Flange Kit | 12 | 12 |
| DIFLNG112G | DIFLNG112R | 1-1/2" | Flange Kit | 12 | 12 |

Brass Circulator Flange Kit

RAVEN
SPECIALTY PRODUCTS

Lead Free



- Sold in Pairs
- KIT Includes: 2 Flanges, 2 Neoprene Gaskets & 4 Nuts & Bolts



| SWT PART # | IPS PART # | SIZE | DESCRIPTION | INNER | MASTER |
|-------------|-------------|--------|-------------|-------|--------|
| CFSWT34-NL | CFIPS34-NL | 3/4" | Flange Kit | 25 | 100 |
| CFSWT1-NL | CFIPS1-NL | 1" | Flange Kit | 12 | 12 |
| CFSWT114-NL | CFIPS114-NL | 1-1/4" | Flange Kit | 12 | 12 |
| CFSWT112-NL | | 1-1/2" | Flange Kit | 12 | 12 |

Flange Gaskets

| PART # | SIZE | DESCRIPTION | INNER | MASTER |
|----------|------|-------------------------|-------|--------|
| CFGASKET | 3/4" | 1 Set of Flange Gaskets | 10 | 1000 |

Nuts & Bolts For Circulator Flange

| PART # | SIZE | DESCRIPTION | INNER | MASTER |
|--------|------|-------------------------|-------|--------|
| CFNUTS | Xx" | 1 Set of Nuts and Bolts | 1 | 45 |

Heavy Duty Oil Tank Legs

RAVEN
SPECIALTY PRODUCTS

Used to Support Oil Tank



| PART # | SIZE | | | |
|------------|--------------|-------------|---|----|
| TANKLEGS10 | 1-1/4" X 10" | | | |
| TANKLEGS12 | 1-1/4" X 12" | | | |
| TANKLEGS13 | 1-1/4" X 13" | Union Elbow | 1 | 24 |
| TANKLEGS14 | 1-1/4" X 14" | Union Elbow | 1 | 24 |

Heavy Duty Oil Tank Elbow

RAVEN
SPECIALTY PRODUCTS

Used to Connect Isolation Valve



- Heavy Duty Sch 40 Steel Elbow
- Will Not Break with Pressure from Ice or if Stepped On
- Extends 2" Past the Outside of Tank for Easy Connection
- Inline Fusible Oil Valve Can be Placed After Isolation Valve

| PART # | SIZE | DESCRIPTION | INNER | MASTER |
|---------|-------------|--------------------|-------|--------|
| OTL1238 | 3/8" X 1/2" | 2" x 6" Tank Elbow | 12 | 60 |

Oil Vent Cap & Screen

RAVEN
SPECIALTY PRODUCTS

Zinc Plated Galvanized Steel



- Use On Oil Tank Vent Pipes
- Lightweight Design
- Includes Screen to Prevent Debris from Entering Vent Pipe
- Zinc Plated Galvanized Steel to Prevent Rust

Vent Cap w/ Screen

| PART # | SIZE | DESCRIPTION | INNER | MASTER |
|--------|--------|-----------------------------|-------|--------|
| VCS114 | 1-1/4" | Oil Tank Vent Cap w/ Screen | 1 | 100 |
| VCS112 | 1-1/2" | Oil Tank Vent Cap w/ Screen | 1 | 100 |
| VCS2 | 2" | Oil Tank Vent Cap w/ Screen | 1 | 50 |

Vent Cap

| PART # | SIZE | DESCRIPTION | INNER | MASTER |
|--------|--------|-------------------|-------|--------|
| VC114 | 1-1/4" | Oil Tank Vent Cap | 1 | 100 |

 **EVERFLOW™**

 **PEXFLOW™**
PRO SERIES

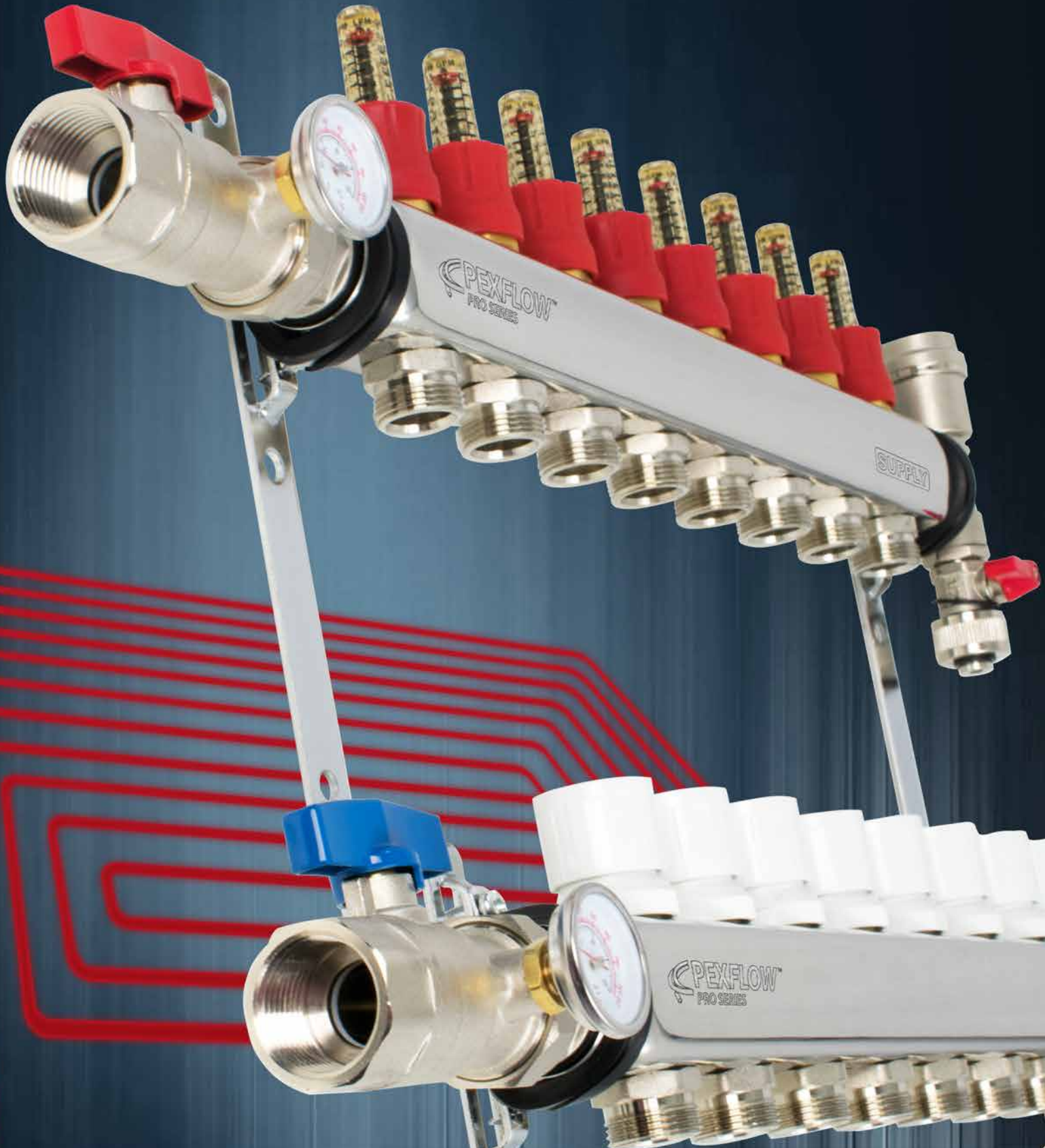

PEX MANIFOLDS & ACCESSORIES

Pex Pro Series Radiant Heat Manifolds



Stainless Steel All-In-One Pre-Assembled Manifold Sets For Radiant Heating

- Packaged with 1/2" PEX Adapters. Other Size Options Available
- Includes: Balancing Valves, Air Vent, Fill/Drain Valves, Shut-Off Valves w/ Temp Gauges & Brackets
- Pressure Tested. Maximum Flow Per Branch is 1.4 GPM. Max Operating Temperature is 158°F
- Stainless Steel Supply & Return Manifolds with Flow Meters
- Pre-Assembled with Valves & Mounting Brackets
- Available from 2 Branch to 12 Branch

| PART # | DESCRIPTION | INNER | MASTER |
|--------|------------------------|-------|--------|
| MPS102 | 2-Branch Pex Manifold | 1 | 4 |
| MPS103 | 3-Branch Pex Manifold | 1 | 4 |
| MPS104 | 4-Branch Pex Manifold | 1 | 4 |
| MPS105 | 5-Branch Pex Manifold | 1 | 4 |
| MPS106 | 6-Branch Pex Manifold | 1 | 4 |
| MPS107 | 7-Branch Pex Manifold | 1 | 4 |
| MPS108 | 8-Branch Pex Manifold | 1 | 2 |
| MPS109 | 9-Branch Pex Manifold | 1 | 2 |
| MPS110 | 10-Branch Pex Manifold | 1 | 2 |
| MPS112 | 12-Branch Pex Manifold | 1 | 2 |

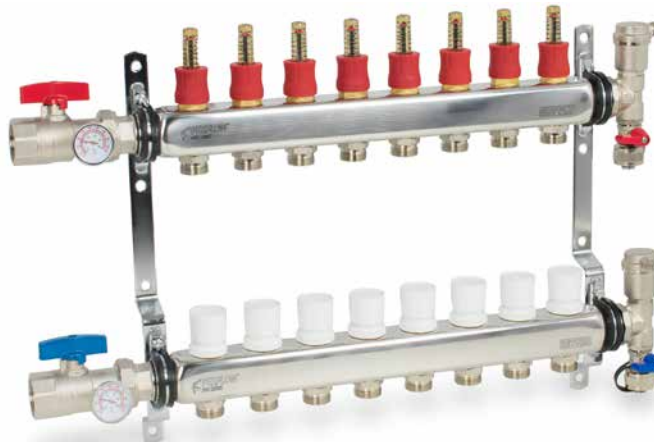

Thermostatic Acuator Valve



For Pex Manifolds • 24 V • 2 Wire and 4 Wire



| PART # | DESCRIPTION | INNER | MASTER |
|--------|---|-------|--------|
| MPA200 | 24V 2 Wire Thermstatic Actuator for Pex | 1 | 50 |
| MPA400 | 24V 4 Wire Thermstatic Actuator for Pex | 1 | 50 |

Pex Manifold Ball Valve



With Temperature Gauge



| BLUE PART # | RED PART # | DESCRIPTION | INNER | MASTER |
|-------------|------------|------------------------------------|-------|--------|
| MPV-SB | MPV-SR | Manifold Ball Valve w/ Gauge | 1 | 15 |
| MPV-AB | MPV-AR | Angle Manifold Ball Valve w/ Gauge | 1 | 15 |

Pex Manifold Adapter



Nickel



| PART # | DESCRIPTION | INNER | MASTER |
|--------|----------------------------------|-------|--------|
| MPX012 | 1/2" Pex X 3/4" Manifold Adapter | 42 | 336 |
| MPX038 | 3/8" Pex X 3/4" Manifold Adapter | 42 | 336 |
| MPX058 | 5/8" Pex X 3/4" Manifold Adapter | 42 | 336 |

Pex Manifold Air Vent Drain Valve



Nickel End Piece



| PART # | DESCRIPTION | INNER | MASTER |
|--------|-------------------------------------|-------|--------|
| MPE200 | Pex Manifold Air Vent & Drain Valve | 1 | 15 |
| MPE100 | Pex Manifold Drain Valve End Piece | 1 | 15 |

STEEL MANIFOLDS

RAVEN
 SPECIALTY PRODUCTS

The Original EZ Header Steel Manifolds

Schedule 40 Pipe Meets ASTM A53 Standard • Threaded Ends Comply With ANSI/ASME B 1.20.1

- Angular Deviation Between Main Pipe & Branch pipe is 30°
- Used in a Boiler Room to Act as a Hub for Heating System
- Threaded Ends Comply with ANSI/ASME B 1.20.1
- Pipe Meets Standard ASTM A53 Sch.40
- Free of Burrs and Fins



Product shipped with thread protectors on all ends

2 Zone

| PART # | SPACE | MAIN DIAMETER | BRANCH DIAMETER | INNER | MASTER |
|------------|-------|---------------|-----------------|-------|--------|
| SH2-1034-6 | 6" | 1" | 3/4" | 1 | 6 |
| SH2-1034-7 | 7" | 1" | 3/4" | 1 | 6 |
| SH2-1434-6 | 6" | 1-1/4" | 3/4" | 1 | 6 |
| SH2-1434-7 | 7" | 1-1/4" | 3/4" | 1 | 6 |
| SH2-1410-6 | 6" | 1-1/4" | 1" | 1 | 6 |
| SH2-1410-7 | 7" | 1-1/4" | 1" | 1 | 6 |
| SH2-1534-7 | 7" | 1-1/2" | 3/4" | 1 | 6 |
| SH2-1510-6 | 6" | 1-1/2" | 1" | 1 | 6 |
| SH2-1510-7 | 7" | 1-1/2" | 1" | 1 | 6 |

3 Zone

| PART # | SPACE | MAIN DIAMETER | BRANCH DIAMETER | INNER | MASTER |
|------------|-------|---------------|-----------------|-------|--------|
| SH3-1034-6 | 6" | 1" | 3/4" | 1 | 6 |
| SH3-1034-7 | 7" | 1" | 3/4" | 1 | 6 |
| SH3-1434-6 | 6" | 1-1/4" | 3/4" | 1 | 6 |
| SH3-1434-7 | 7" | 1-1/4" | 3/4" | 1 | 6 |
| SH3-1410-6 | 6" | 1-1/4" | 1" | 1 | 6 |
| SH3-1410-7 | 7" | 1-1/4" | 1" | 1 | 6 |
| SH3-1421-6 | 6" | 1-1/4" | 3/4" & one 1" | 1 | 6 |
| SH3-1421-7 | 7" | 1-1/4" | 3/4" & one 1" | 1 | 6 |
| SH3-1534-6 | 6" | 1-1/2" | 3/4" | 1 | 6 |
| SH3-1534-7 | 7" | 1-1/2" | 3/4" | 1 | 6 |
| SH3-1510-6 | 6" | 1-1/2" | 1" | 1 | 6 |
| SH3-1510-7 | 7" | 1-1/2" | 1" | 1 | 6 |

4 Zone

| PART # | SPACE | MAIN DIAMETER | BRANCH DIAMETER | INNER | MASTER |
|------------|-------|---------------|-----------------|-------|--------|
| SH4-1034-6 | 6" | 1" | 3/4" | 1 | 6 |
| SH4-1034-7 | 7" | 1" | 3/4" | 1 | 6 |
| SH4-1434-6 | 6" | 1-1/4" | 3/4" | 1 | 6 |
| SH4-1434-7 | 7" | 1-1/4" | 3/4" | 1 | 6 |

4 Zone continued

| PART # | SPACE | MAIN DIAMETER | BRANCH DIAMETER | INNER | MASTER |
|------------|-------|---------------|-----------------|-------|--------|
| SH4-1431-6 | 6" | 1-1/4" | 3/4" & one 1" | 1 | 6 |
| SH4-1431-7 | 7" | 1-1/4" | 3/4" & one 1" | 1 | 6 |
| SH4-1410-6 | 6" | 1-1/4" | 1" | 1 | 6 |
| SH4-1410-7 | 7" | 1-1/4" | 1" | 1 | 6 |
| SH4-1534-6 | 6" | 1-1/2" | 3/4" | 1 | 6 |
| SH4-1534-7 | 7" | 1-1/2" | 3/4" | 1 | 6 |
| SH4-1510-6 | 6" | 1-1/2" | 1" | 1 | 6 |
| SH4-1510-7 | 7" | 1-1/2" | 1" | 1 | 6 |
| SH4-2010-7 | 7" | 2" | 1" | 1 | 6 |
| SH4-2014-7 | 7" | 2" | 1-1/4" | 1 | 6 |

5 Zone

| PART # | SPACE | MAIN DIAMETER | BRANCH DIAMETER | INNER | MASTER |
|------------|-------|---------------|-----------------|-------|--------|
| SH5-1434-6 | 6" | 1-1/4" | 3/4" | 1 | 6 |
| SH5-1434-7 | 7" | 1-1/4" | 3/4" | 1 | 6 |
| SH5-1431-7 | 7" | 1-1/4" | 3/4" & one 1" | 1 | 6 |
| SH5-1534-7 | 7" | 1-1/2" | 3/4" | 1 | 6 |
| SH5-1510-6 | 6" | 1-1/2" | 1" | 1 | 6 |
| SH5-1510-7 | 7" | 1-1/2" | 1" | 1 | 6 |

6 Zone

| PART # | SPACE | MAIN DIAMETER | BRANCH DIAMETER | INNER | MASTER |
|------------|-------|---------------|-----------------|-------|--------|
| SH6-1434-7 | 7" | 1-1/4" | 3/4" | 1 | 6 |
| SH6-1410-6 | 6" | 1-1/4" | 1" | 1 | 6 |
| SH6-1410-7 | 7" | 1-1/4" | 1" | 1 | 6 |
| SH6-1534-7 | 7" | 1-1/2" | 3/4" | 1 | 6 |
| SH6-1510-6 | 6" | 1-1/2" | 1" | 1 | 6 |
| SH6-1510-7 | 7" | 1-1/2" | 1" | 1 | 6 |
| SH6-2014-7 | 7" | 2" | 1-1/4" | 1 | 6 |

7 Zone

| PART # | SPACE | MAIN DIAMETER | BRANCH DIAMETER | INNER | MASTER |
|------------|-------|---------------|-----------------|-------|--------|
| SH7-2010-7 | 7" | 2" | 1" | 1 | 6 |

COPPER MANIFOLDS

RAVEN
 SPECIALTY PRODUCTS

Copper Manifolds

- Applications: Zone Manifolds, Radiant Manifolds
Return Manifolds and Boiler Headers
- Packaged with Metal Sheet to Prevent Damage During Shipping
- Standard SWT Ends
- Individually Boxed for Easy Shipping



24 Copper Branch Manifold Type K

- 3" Center
- 72" Long

| PART # | SIZE | INNER | MASTER |
|---------------|---------------|-------|--------|
| CM-1C2412-K | 1" x 1/2" | 1 | 1 |
| CM-1C2434-K | 1" x 3/4" | 1 | 1 |
| CM-114C2412-K | 1-1/4" x 1/2" | 1 | 1 |
| CM-114C2434-K | 1-1/4" x 3/4" | 1 | 1 |

18 Copper Branch Manifold Type L

- 4" Center
- 72" Long

| PART # | SIZE | INNER | MASTER |
|-------------|---------------|-------|--------|
| CM-1C1812 | 1" x 1/2" | 1 | 1 |
| CM-1C1834 | 1" x 3/4" | 1 | 1 |
| CM-114C1812 | 1-1/4" x 1/2" | 1 | 1 |
| CM-114C1834 | 1-1/4" x 3/4" | 1 | 1 |
| CM-112C1834 | 1-1/2" x 3/4" | 1 | 1 |
| CM-2C1834 | 2" x 3/4" | 1 | 1 |

12 Copper Branch Manifold Type L

- 6" Center
- 72" Long

| PART # | SIZE | INNER | MASTER |
|-------------|---------------|-------|--------|
| CM-1C1212 | 1" x 1/2" | 1 | 1 |
| CM-1C1234 | 1" x 3/4" | 1 | 1 |
| CM-114C1212 | 1-1/4" x 1/2" | 1 | 1 |
| CM-114C1234 | 1-1/4" x 3/4" | 1 | 1 |
| CM-114C121 | 1-1/4" x 1" | 1 | 1 |
| CM-112C1234 | 1-1/2" x 3/4" | 1 | 1 |
| CM-112C121 | 1-1/2" x 1" | 1 | 1 |
| CM-2C1234 | 2" x 3/4" | 1 | 1 |
| CM-2C121 | 2" x 1" | 1 | 1 |

6 Copper Branch Manifold Type L

- 4" Center
- 24" Long

| PART # | SIZE | INNER | MASTER |
|------------|---------------|-------|--------|
| CM-1C612 | 1" x 1/2" | 1 | 1 |
| CM-114C634 | 1-1/4" x 3/4" | 1 | 1 |

5 Copper Branch Manifold Type L

- 4" Center
- 20" Long

| PART # | SIZE | INNER | MASTER |
|------------|---------------|-------|--------|
| CM-114C534 | 1-1/4" x 3/4" | 1 | 1 |

4 Copper Branch Manifold Type L

- 4" Center
- 20" Long

| PART # | SIZE | INNER | MASTER |
|------------|---------------|-------|--------|
| CM-114C434 | 1-1/4" x 3/4" | 1 | 1 |

3 Copper Branch Manifold Type L

- 6" Center
- 18" Long

| PART # | SIZE | INNER | MASTER |
|-------------|---------------|-------|--------|
| CM-1C3346 | 1" x 3/4" | 1 | 1 |
| CM-114C3346 | 1-1/4" x 3/4" | 1 | 1 |

3 Copper Branch Manifold Type L

- 4" Center
- 12" Long

| PART # | SIZE | INNER | MASTER |
|------------|---------------|-------|--------|
| CM-1C334 | 1" x 3/4" | 1 | 1 |
| CM-114C334 | 1-1/4" x 3/4" | 1 | 1 |

ACCESSORIES

Water Meter Flange Kit



Lead Free Bronze Oval

- 2 Flanges & Gaskets
- 4 Nuts & Bolts
- Forged Bronze
- Oval Design



| PART # | SIZE | DESCRIPTION | INNER | MASTER |
|-------------|--------|----------------|-------|--------|
| WMFS112K-NL | 1-1/2" | SWT Flange Kit | 1 | 12 |
| WMFS200K-NL | 2" | SWT Flange Kit | 1 | 10 |
| WMFT112K-NL | 1-1/2" | IPS Flange Kit | 1 | 12 |
| WMFT200K-NL | 2" | IPS Flange Kit | 1 | 10 |

Gasket For Water Meter Flange Set

| PART # | SIZE | DESCRIPTION | INNER | MASTER |
|---------|--------|-------------|-------|--------|
| WMFG112 | 1-1/2" | 2 Gaskets | 1 | 1 |
| WMFG002 | 2" | 2 Gaskets | 1 | 1 |

Water Meter Flange

| PART # | SIZE | DESCRIPTION | INNER | MASTER |
|------------|--------|------------------------|-------|--------|
| WMFS112-NL | 1-1/2" | IPS Water Meter Flange | 4 | 32 |
| WMFS200-NL | 2" | IPS Water Meter Flange | 6 | 24 |
| WMFT112-NL | 1-1/2" | SWT Water Meter Flange | 4 | 32 |
| WMFT200-NL | 2" | SWT Water Meter Flange | 6 | 24 |

Water Meter Flange Nuts & Bolts

| PART # | DESCRIPTION | INNER | MASTER |
|----------|--|-------|--------|
| WMFN1000 | Pack of 4 Nuts & Bolts | 5 | 20 |
| WMFN2000 | pack of 4 Stainless Steel Nuts & Bolts | 5 | 20 |

F x F x C EZ Long x Water Tee



- 3/4" Long Female End Threads Directly Into Cold Water Inlet of Water Heater



| PART # | SIZE | DESCRIPTION | INNER | MASTER |
|----------|-------------------------------|-------------|-------|--------|
| R1396-NL | 3/4" F Long x 1/2" F x 1/2" C | Tee | 10 | 60 |
| R1397-NL | 3/4" F Long x 1/2" F x 3/4" C | Tee | 10 | 60 |

M x F x C EZ Long x Water Tee



- 1/2" or 3/4" Female End Receives Vacuum Relief Valve and 1/2" or 3/4" C Branch to Connect Cold Water Supply



| PART # | SIZE | DESCRIPTION | INNER | MASTER |
|----------|-------------------------------|-------------|-------|--------|
| R1394-NL | 3/4" M Long x 1/2" F x 1/2" C | Tee | 10 | 60 |
| R1395-NL | 3/4" M Long x 1/2" F x 3/4" C | Tee | 10 | 60 |

Brass Water Meter Coupling



Lead Free • With Washer

- Brass Nipple & Nut with Rubber Gasket



| PART # | SIZE | DESCRIPTION | INNER | MASTER |
|------------|---------------------|----------------------|-------|--------|
| WMC0012-NL | 1/2" MIP X 3/4" FIP | Water Meter Coupling | 20 | 160 |
| WMC0034-NL | 3/4" MIP X 1" FIP | Water Meter Coupling | 20 | 100 |
| WMC1011-NL | 1" MIP X 1-1/4" FIP | Water Meter Coupling | 10 | 80 |
| WMC1520-NL | 1-1/2" MIP X 2" FIP | Water Meter Coupling | 2 | 24 |
| WMC2025-NL | 2" MIP X 2-1/2" FIP | Water Meter Coupling | 2 | 24 |

Water Service Straight Coupling



Lead Free Compliant • Flare x MIP

- Bronze Construction
- Conforms to A.W.W.A.
- Male Pipe Thread to Flare Copper



| PART # | SIZE | DESCRIPTION | INNER | MASTER |
|------------|--------------------|-------------------|-------|--------|
| WS-AFM0034 | 3/4" FLARE X MIP | Straight Coupling | 10 | 100 |
| WS-AFM0100 | 1" FLARE X MIP | Straight Coupling | 6 | 60 |
| WS-AFM0112 | 1-1/2" FLARE X MIP | Straight Coupling | 2 | 24 |
| WS-AFM0200 | 2" FLARE X MIP | Straight Coupling | 1 | 12 |

Water Service 1/4 Bend Elbow



Lead Free • Flare x MIP

- Bronze Construction
- Conforms to A.W.W.A.
- Male Pipe Thread to Flare Copper



| PART # | SIZE | DESCRIPTION | INNER | MASTER |
|------------|--------------------|-------------|-------|--------|
| WMC0012-NL | 3/4" FLARE X MIP | L Coupling | 4 | 40 |
| WMC0034-NL | 1" FLARE X MIP | L Coupling | 3 | 30 |
| WMC1011-NL | 1-1/2" FLARE X MIP | L Coupling | 1 | 10 |
| WMC1520-NL | 2" FLARE X MIP | L Coupling | 1 | 6 |

Male Long x SWT Adapter



- Connects Hot Water Outlet to 1/2" or 3/4" Copper Pipe
- Takes the Place of One Fitting & One Nipple Assembly



| PART # | SIZE | DESCRIPTION | INNER | MASTER |
|----------|----------------------|-------------|-------|--------|
| R1398-NL | 3/4" M Long x 1/2" C | Adapter | 10 | 60 |
| R1399-NL | 3/4" M Long x 3/4" C | Adapter | 10 | 60 |



CPVC Transition Fittings

- Lead Free Brass & Stainless Steel
- Durable Over Molded One-Piece
- Pressure Rating 100 PSI at 180°F
- Pressure Rating 150 PSI at 100°F



Made with Lubrizol licensed FlowGuard Gold CPVC compound. Product manufacturing design, materials & production, all meet or exceed industry standards. IAPMO listed, meeting cUPC, ANSI/NSF/61 and AB1953 standards. Manufactured in ISO 9001 approved facilities.

FLOWGUARD GOLD
PIPE & FITTINGS

Male x CPVC Adapter

Lead Free Brass



| PART # | SIZE | DESCRIPTION | INNER | MASTER |
|-------------|--------|-------------|-------|--------|
| BRCPM012-NL | 1/2" | Adapter | 16 | 384 |
| BRCPM034-NL | 3/4" | Adapter | 8 | 240 |
| BRCPM100-NL | 1" | Adapter | 6 | 150 |
| BRCPM114-NL | 1 1/4" | Adapter | 4 | 40 |
| BRCPM112-NL | 1 1/2" | Adapter | 4 | 40 |
| BRCPM200-NL | 2" | Adapter | 6 | 30 |

Male x CPVC Adapter

Lead Free Stainless Steel



| PART # | SIZE | DESCRIPTION | INNER | MASTER |
|-------------|--------|-------------|-------|--------|
| SSCPM012-NL | 1/2" | Adapter | 40 | 400 |
| SSCPM034-NL | 3/4" | Adapter | 30 | 300 |
| SSCPM100-NL | 1" | Adapter | 20 | 120 |
| SSCPM114-NL | 1 1/4" | Adapter | 10 | 60 |
| SSCPM112-NL | 1 1/2" | Adapter | 10 | 40 |
| SSCPM200-NL | 2" | Adapter | 8 | 32 |

Female x CPVC Adapter

Lead Free Brass



| PART # | SIZE | DESCRIPTION | INNER | MASTER |
|-------------|--------|-------------|-------|--------|
| BRCPF012-NL | 1/2" | Adapter | 16 | 384 |
| BRCPF034-NL | 3/4" | Adapter | 8 | 240 |
| BRCPF100-NL | 1" | Adapter | 6 | 150 |
| BRCPF114-NL | 1 1/4" | Adapter | 7 | 70 |
| BRCPF112-NL | 1 1/2" | Adapter | 7 | 70 |
| BRCPF200-NL | 2" | Adapter | 6 | 30 |

Female x CPVC Adapter

Lead Free Stainless Steel



| PART # | SIZE | DESCRIPTION | INNER | MASTER |
|-------------|--------|-------------|-------|--------|
| SSCPF012-NL | 1/2" | Adapter | 40 | 400 |
| SSCPF034-NL | 3/4" | Adapter | 30 | 300 |
| SSCPF100-NL | 1" | Adapter | 20 | 120 |
| SSCPF114-NL | 1 1/4" | Adapter | 10 | 60 |
| SSCPF112-NL | 1 1/2" | Adapter | 10 | 40 |
| SSCPF200-NL | 2" | Adapter | 8 | 32 |

CPVC Drop Ear Elbow

Lead Free Brass



| PART # | SIZE | DESCRIPTION | INNER | MASTER |
|-------------|------|-------------|-------|--------|
| BRCPD012-NL | 1/2" | Adapter | 50 | 200 |

CPVC Drop Ear Elbow

Lead Free Stainless Steel



| PART # | SIZE | DESCRIPTION | INNER | MASTER |
|-------------|------|---------------------|-------|--------|
| SSCPD012-NL | 1/2" | Plastic Ear Adapter | 20 | 200 |
| SSDP012-NL | 3/4" | Steel Ear Adapter | 20 | 200 |

DIELECTRIC UNIONS & NIPPLES

Dielectric Unions



Lead Free • ISO 9001

- Lead Free
- Meets ASTM F492-95
- Rated Up to 230°F



Female x Female Dielectric Unions



| PART # | SIZE | DESCRIPTION | INNER | MASTER |
|-------------|----------------|-------------|-------|--------|
| DUFF0012-NL | 1/2" | Union | 15 | 120 |
| DUFF0034-NL | 3/4" | Union | 12 | 96 |
| DUFF0100-NL | 1" | Union | 6 | 48 |
| DUFF0114-NL | 1-1/4" | Union | 6 | 36 |
| DUFF0112-NL | 1-1/2" | Union | 4 | 24 |
| DUFF0200-NL | 2" | Union | 3 | 18 |
| DUFF0212-NL | 2-1/2" Flanged | Union | 1 | 4 |
| DUFF0300-NL | 3" Flanged | Union | 1 | 4 |
| DUFF0400-NL | 4" Flanged | Union | 1 | 2 |



Female x SWT Dielectric Unions



| PART # | SIZE | DESCRIPTION | INNER | MASTER |
|-------------|----------------|-------------|-------|--------|
| DUFS0012-NL | 1/2" | Union | 12 | 144 |
| DUFS0034-NL | 3/4" | Union | 15 | 120 |
| DUFS3412-NL | 3/4" X 1/2" | Union | 15 | 120 |
| DUFS0100-NL | 1" | Union | 12 | 72 |
| DUFS0114-NL | 1-1/4" | Union | 6 | 48 |
| DUFS0112-NL | 1-1/2" | Union | 6 | 36 |
| DUFS0200-NL | 2" | Union | 3 | 18 |
| DUFS0212-NL | 2-1/2" Flanged | Union | 1 | 4 |
| DUFS0300-NL | 3" Flanged | Union | 1 | 4 |



Male x SWT Dielectric Unions



| PART # | SIZE | DESCRIPTION | INNER | MASTER |
|-------------|-------------|-------------|-------|--------|
| DUMS0012-NL | 1/2" | Union | 12 | 96 |
| DUMS0034-NL | 3/4" | Union | 12 | 72 |
| DUMS3412-NL | 3/4" X 1/2" | Union | 12 | 72 |

Dielectric Nipples



Lead Free • ISO 9001

- 300 PSI
- Rated Up to 230° F
- ASTM A53, ANSI B1.20.1 & ASTM F492-95
- Galvanized Dielectric Nipples
- Pex Liner
- Metal to Metal Design



Thread x Thread Dielectric Nipples



| PART # | SIZE | DESCRIPTION | INNER | MASTER |
|----------|---------------|-------------|-------|--------|
| DNTT3425 | 3/4" X 2-1/2" | Nipples | 25 | 300 |
| DNTT3430 | 3/4" X 3" | Nipples | 25 | 200 |
| DNTT3440 | 3/4" X 4" | Nipples | 25 | 200 |
| DNTT1025 | 1" X 2-1/2" | Nipples | 25 | 100 |
| DNTT1030 | 1" X 3" | Nipples | 25 | 100 |
| DNTT1040 | 1" X 4" | Nipples | 25 | 100 |
| DNTT1140 | 1-1/4" X 4" | Nipples | 25 | 100 |
| DNTT1540 | 1-1/2" X 4" | Nipples | 25 | 50 |
| DNTT2040 | 2" X 4" | Nipples | 1 | 40 |
| DNTT2560 | 2-1/2" X 6" | Nipples | 1 | 20 |
| DNTT3060 | 3" X 6" | Nipples | 1 | 10 |
| DNTT4060 | 4" X 6" | Nipples | 1 | 8 |



Grooved x Grooved Dielectric Nipples



| PART # | SIZE | DESCRIPTION | INNER | MASTER |
|----------|-------------|-------------|-------|--------|
| DNGG2040 | 2" X 4" | Nipples | 1 | 1 |
| DNGG2560 | 2-1/2" X 6" | Nipples | 1 | 1 |
| DNGG3060 | 3" X 6" | Nipples | 1 | 10 |
| DNGG4060 | 4" X 6" | Nipples | 1 | 1 |



Threaded x Grooved Dielectric Nipples



| PART # | SIZE | DESCRIPTION | INNER | MASTER |
|----------|-------------|-------------|-------|--------|
| DNTG2040 | 2" X 4" | Nipples | 1 | 40 |
| DNTG2560 | 2-1/2" X 6" | Nipples | 1 | 20 |
| DNTG3060 | 3" X 6" | Nipples | 1 | 10 |
| DNTG4060 | 4" X 6" | Nipples | 1 | 8 |

METER BARS & ACCESSORIES

Meter Bars



Side-Inlet-Top-Outlet

Meter Bars - Keyspan®



| PART # | LENGTH | INLET | OUTLET | SWIVEL | FINISH |
|----------|--------|--------|--------|--------|--------|
| GSTB6111 | 6" | 1" | 1" | 1" | Black |
| GSTB6121 | 6-1/2" | 1" | 1" | 1" | Black |
| GSTB7114 | 7" | 1-1/4" | 1-1/4" | 1-1/4" | Black |
| GSTG6111 | 6" | 1" | 1" | 1" | Galv. |
| GSTG6121 | 6-1/2" | 1" | 1" | 1" | Galv. |
| GSTG7114 | 7" | 1-1/4" | 1-1/4" | 1-1/4" | Galv. |

Side-Inlet-Outlet

Meter Bars



| PART # | LENGTH | INLET | OUTLET | SWIVEL | FINISH |
|----------------------|--------|-------|--------|--------|--------|
| GSSB6111 | 6" | 1" | 1" | 1" | Black |
| GSSB8141 Con Edison® | 8-1/4" | 1" | 1-1/4" | 1-1/4" | Black |
| GSSG6111 | 6" | 1" | 1" | 1" | Galv. |
| GSSG8141 Con Edison® | 8-1/4" | 1" | 1-1/4" | 1-1/4" | Galv. |

Ball Valve

Meter Bars - Con Edison® Con Edison®



| PART # | LENGTH | INLET | OUTLET | SWIVEL | FINISH |
|----------|--------|-------|--------|--------|--------|
| GBVB6111 | 6" | 1" | 1" | 1" | Black |
| GBVG6111 | 6" | 1" | 1" | 1" | Galv. |

S-Inlet S-Outlet

Meter Bars - Keyspan®



| PART # | LENGTH | INLET | OUTLET | SWIVEL | FINISH |
|--------------|--------|--------|--------|--------|--------|
| GSSG-KS-6111 | 6" | 1" | 1" | 1" | Galv. |
| GSSG-KS-7114 | 7" | 1-1/4" | 1-1/4" | 1-1/4" | Galv. |

Meter Plugs

With Tap



| PART # | SIZE | LT. | FINISH |
|----------|--------|-----|--------|
| GMPT1201 | 1" | 20 | Black |
| GMPT1143 | 1-1/4" | 30 | Black |

Offset Swivels



| PART # | SIZE | LT. | FINISH |
|----------|--------|-----|--------|
| GOFB1205 | 1/2" | 5 | Black |
| GOFB3410 | 3/4" | 10 | Black |
| GOFB1201 | 1" | 20 | Black |
| GOFB1143 | 1-1/4" | 30 | Black |
| GOFG3410 | 3/4" | 10 | Galv. |
| GOFG1201 | 1" | 20 | Galv. |
| GOFG1143 | 1-1/4" | 30 | Galv. |

Nuts for Gas Meters



| PART # | SIZE | LT. | FINISH |
|----------|--------|-----|--------|
| GMNB1205 | 1/2" | 5 | Black |
| GMNB3410 | 3/4" | 10 | Black |
| GMNB1200 | 1" | 20 | Black |
| GMNB1143 | 1-1/4" | 30 | Black |
| GMNG3410 | 3/4" | 10 | Galv. |
| GMNG1200 | 1" | 20 | Galv. |
| GMNG1143 | 1-1/4" | 30 | Galv. |

Straight Swivels

For Gas Meter Bars



| PART # | SIZE | LT. | FINISH |
|----------|--------|-----|--------|
| GSTB3410 | 3/4" | 10 | Black |
| GSTB1200 | 1" | 20 | Black |
| GSTB1143 | 1-1/4" | 30 | Black |
| GSTG3410 | 3/4" | 10 | Galv. |
| GSTG1200 | 1" | 20 | Galv. |
| GSTG1143 | 1-1/4" | 30 | Galv. |

Gas Regulator Vents

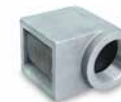

| PART # | DESCRIPTION |
|----------|--------------------|
| GGRV3400 | 3/4" With screen |
| GGRV1000 | 1" With Screen |
| GGRV0114 | 1-1/4" With Screen |
| GGRV0112 | 1-1/2" With Screen |

Support Bracket

For Meter Bars & Risers



| PART # | DESCRIPTION |
|----------|---------------------------|
| GMBS3420 | "A" Bracket for meter bar |

Safety Signs



GAS VENT DIRECTLY BELOW KEEP CLEAR OF ALL OBSTRUCTIONS

| PART # | MATERIAL | COLOR | SIZE |
|---------------|---------------|--------|---------|
| SIGN#1 | Rigid Plastic | Yellow | 3" x 7" |
| SIGN#2 | Rigid Plastic | Clear | 3" x 7" |

EXHAUST

| PART # | MATERIAL | COLOR | SIZE |
|---------------|--|--------|-------------|
| SIGN#3 | Pressure Sensitive Vinyl - Adhesive Backed | Yellow | 3" x11-1/2" |

AIR INTAKE

| PART # | MATERIAL | COLOR | SIZE |
|---------------|--|--------|-------------|
| SIGN#4 | Pressure Sensitive Vinyl - Adhesive Backed | Yellow | 3" x11-1/2" |

SPRINKLERS THROUGHOUT BUILDING

| PART # | MATERIAL | COLOR | SIZE |
|---------------|---------------|-------|---------|
| SIGN#5 | Rigid Plastic | White | 7" x 9" |

THIS VALVE CONTROLS AUTOMATIC SPRINKLER SYSTEM AND MUST ALWAYS BE KEPT OPEN

| PART # | MATERIAL | COLOR | SIZE |
|---------------|---------------|-------|---------|
| SIGN#6 | Rigid Plastic | Red | 7" x 9" |

AUTOMATIC SPRINKLER SHUT OFF VALVE LOCATED ___ FT. OPPOSITE THIS SIGN

| PART # | MATERIAL | COLOR | SIZE |
|---------------|---------------|-------|---------|
| SIGN#7 | Rigid Plastic | White | 7" x 9" |

FIRE ALARM WHEN BELL RINGS CALL FIRE DEPT OR 911

| PART # | MATERIAL | COLOR | SIZE |
|---------------|---------------|-------|---------|
| SIGN#8 | Rigid Plastic | Red | 7" x 9" |

FIRE ALARM WHEN BELL RINGS CALL FIRE DEPT OR 911

| PART # | MATERIAL | COLOR | SIZE |
|---------------|---------------|-------|---------|
| SIGN#9 | Rigid Plastic | White | 7" x 9" |

INSPECTORS TEST

| PART # | MATERIAL | COLOR | SIZE |
|----------------|---------------|-------|---------|
| SIGN#10 | Rigid Plastic | White | 2" x 7" |

MAIN DRAIN

| PART # | MATERIAL | COLOR | SIZE |
|----------------|---------------|-------|---------|
| SIGN#11 | Rigid Plastic | White | 2" x 7" |

The Complete Package.



everflowsupplies.com | 908.436.1100



Sales & Support

Everflow Supplies Inc.

Carteret NJ 07008

T: 908.436.1100

F: 908.436.1162

sales@everflowsupplies.com

Distribution

Eastern Region

100 Middlesex Ave.

Carteret NJ 07008

Midwest Region

150 S. Fairbank St.

Addison, Illinois 60101

South Central & Western Region

2300 E. Bardin Rd.

Arlington, Texas 76018

www.everflowsupplies.com



EFV0618V1

