

Features

- Vitreous china
- Compact elongated bowl
- Comfort Height®
- AquaPiston® flushing system
- Includes Glenbury™ Q3 seat, cover [K-4733] and left-hand polished chrome trip lever
- 12" (305 mm) rough-in
- 1.28 gpf (4.8 lpf)
- Skirted trapway
- 2 1/8" (54 mm) plastic trapway

Technology

- Single-flush gravity uses the force of gravity and a precision-engineered tank, bowl, and trapway to create a strong siphon during flushing
- AquaPiston® canister allows water to flow into the bowl from all sides (360 degrees), increasing the power and effectiveness of the flush
- Flush valve's 3:2 ratio harnesses the natural force of gravity and optimizes flush performance
- Durable canister design has 90% less exposed seal material than a 3" flapper, for leak-free performance
- Light-touch canister flush requires a lower actuation force than a flapper

Installation

- Standard 12" rough-in

Water Conservation & Rebates

- WaterSense® toilets meet strict EPA flushing guidelines, including using at least 20 percent less water than 1.6 gpf toilets
- Eligible for consumer rebates in some municipalities

Optional Accessories

- K- 5383 10" Rough-in Full Skirt Trap and Attachment System
- K- 5381 14" Rough-in Full Skirt Trap and Attachment System



Codes/Standards











ASME A112.19.2/CSA B45.1
DOE - Energy Policy Act 1992
EPA WaterSense®

KOHLER® One-Year Limited Warranty

See website for detailed warranty information.

Available Color/Finishes

Color tiles intended for reference only.

Color	Code	Description
	0	White
	96	Biscuit
	47	Almond
	NY	Dune
	95	Ice™ Grey
	G9	Sandbar
	33	Mexican Sand™
	K4	Cashmere
	58	Thunder™ Grey
	7	Black Black™

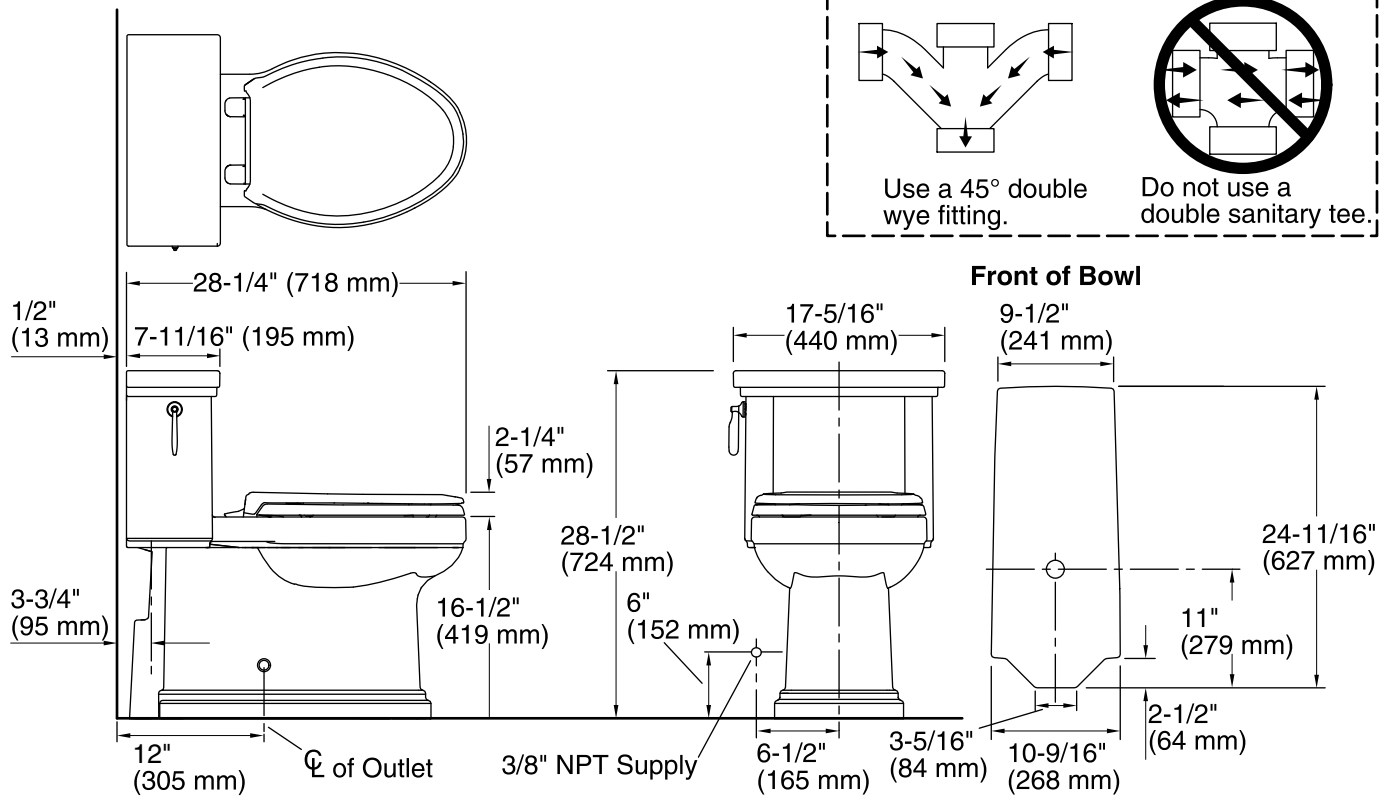
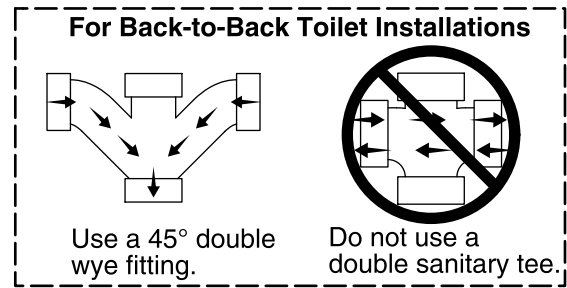

Technical Information

All product dimensions are nominal.

- Toilet type: One-piece
- Bowl shape: Compact Elongated front
- Seat hinge type: Quick-Attach®, Quiet-Close™, Quick-Release™
- Trap passageway: 2-1/8" (54 mm)
- Water Consumption
 - Full: 1.28 gpf (4.8 lpf)
- Water surface size: 9-5/8" x 6-7/8" (245 mm x 174 mm)
- Rim to water surface: 5-3/8" (137 mm)
- Rough-in: 12" (305 mm)
- Seat-mounting holes: 5-1/2" (140 mm)

Notes

- Install this product according to the installation guide.
- For back-to-back toilet installations: Use only a 45° double wye fitting.