

# TOILETS

---

# SERVICE PARTS BOOK

OCTOBER 2017



GENUINE PARTS  
**STERLING**  
A KOHLER COMPANY

**KOHLER**<sup>®</sup>  
GENUINE PARTS



# KOHLER® Toilets Service Parts

## Tips for Finding the Right Part

### Know if Your Toilet Is a One-Piece or Two-Piece Toilet



One-piece toilets integrate tank and bowl into a seamless design.



Two-piece toilets feature the traditional design of a separate tank and bowl.

### Determine Your Toilet's Flushing Technology

All KOHLER flushing technologies are described, along with their common replacement parts, on pages 4–11. To determine your toilet's flushing technology, look inside the tank and compare your flushing mechanisms with those pictured in this catalog.

### Look for Model and Service Information

Many toilets have service information on the underside of the tank lid.



The toilet tank number is imprinted on the inside back of the tank.

For toilet and tank K-number reference, see index on pages 12–13.

### Find Your Toilet in the Matrix

If you do not find the part you need pictured on pages 4–11, use the information you have gathered to find your toilet in the corresponding section of the matrix. The replacement part numbers for the float/fill valve, flush valve, tank gasket and flush ball/flapper are listed for each toilet. To view all the service parts for your toilet, visit [KOHLER.com/ServiceParts](http://KOHLER.com/ServiceParts) for the expanded service parts pages.

<b>Toilets – Flushing Technologies</b> .....	4–11
<b>Index by Toilet Model Number</b> .....	12–13
<b>Toilets – Detailed Parts Matrix</b>	

<b>Canister (Single-Fush) One-Piece Toilets</b> .....	14–17
---	-------

<b>Canister (Single-Fush) Two-Piece Toilets</b> .....	18–23
---	-------

<b>Canister (Dual-Flush) One- and Two-Piece Toilets</b> .....	24–27
---	-------

<b>Touchless Toilets</b> .....	28–29
--------------------------------	-------

<b>2-Inch Flapper One-Piece Toilets</b> .....	30–39
---	-------

<b>2-Inch Flapper Two-Piece Toilets</b> .....	40–49
---	-------

<b>3¼-Inch Flapper One-Piece Toilets</b> .....	50–51
--	-------

<b>3¼-Inch Flapper Two-Piece Toilets</b> .....	52–53
--	-------

<b>Power Lite® One-Piece Toilets</b> .....	54–55
--	-------

<b>Intelligent Toilets</b> .....	56–57
----------------------------------	-------

<b>Pressure Lite® One- and Two-Piece Toilets</b> .....	58–59
--	-------

<b>STERLING® Toilets</b> .....	60–61
--------------------------------	-------

## Power Lite® One-Piece Toilets

**POWER LITE®**  
KOHLER®

If you have a Power Lite toilet, there will be an electrical cord extending from the toilet to a power outlet.



Power Lite toilets have specific replacement parts for each model.

See pages 54–55 for parts related to Power Lite toilets.

For detailed parts listings, see pages 54–55.

---

## Pressure Lite® One- and Two-Piece Toilets

**PRESSURE LITE®**  
KOHLER®

If you have a Pressure Lite toilet, you will see a holding vessel within the tank.



Pressure Lite toilets have specific replacement parts for each model.

See pages 58–59 for parts related to Pressure Lite toilets.

For detailed parts listings, see pages 58–59.

# Canister (Single-Flush) Toilets

CLASS SIX<sup>®</sup>  
KOHLER.

CLASS FIVE<sup>®</sup>  
KOHLER.

If you have a single-flush canister toilet, you will see a cylinder-shaped flush valve inside the tank instead of a flapper. The seal in the canister works similar to a flapper. **If your toilet is leaking water into the bowl, the seal needs to be replaced, not the canister.**

**AquaPiston<sup>®</sup>**  
The AquaPiston canister allows water to flow into the bowl from all sides (360 degrees), increasing the power and effectiveness of the flush.

Guide Kit  
(Includes center guide, cap and chain)  
GP1229656



**YOUR CAP COLOR DOES NOT MATTER.**

Match stem color and insert size.

-If stem is grey with small insert, use GP1138930.



-If stem is black with large insert, use GP1083167.



Must use proper valve for optimal performance.

Proprietary Formulated Yellow Seal  
GP1059291



Replaces Red Seal



Two-piece canister toilets will have triangle gasket kit or DryLock<sup>™</sup> gaskets.

GP51487



GP1018165-F  
(3" gasket)



1024390  
(bolts)



GP1112256  
(2" gasket)



1024390  
(bolts)



# Canister (Dual-Flush) Toilets

DUAL FLUSH  
KOHLER.

If you have a dual-flush toilet, you will see a two-button actuator on the top or a two-part trip lever on the side rather than a standard trip lever. You will see a cylinder-shaped flush valve inside the tank instead of a flapper. The seal in the canister works similar to a flapper. **If your toilet is leaking water into the bowl, the seal needs to be replaced, not the canister.**



Flush Valve Seal  
1131496

Flush Valve Seal  
1270755

YOUR CAP COLOR  
DOES NOT MATTER.

Use GP1138930



The innovative two-tone trip lever features two flush options. The longer green lever provides a light 1.1-gallon flush; the full lever provides a full 1.6-gallon flush.



Flush Valve Seal  
1203764

YOUR CAP COLOR  
DOES NOT MATTER.

Use GP1138930



# Touchless Flush Toilets



KOHLER® touchless toilets offer a no-touch flush. Just hold your hand over the tank sensor to activate the flush. No handle to touch means fewer germs to pick up or leave behind.

Guide Kit  
(Includes center guide,  
cap and chain)  
GP1229656



Proprietary  
Formulated  
Yellow Seal  
GP1059291



Touchless Unit



## YOUR CAP COLOR DOES NOT MATTER.

Match stem color and insert size.

-If stem is grey with small insert,  
use GP1138930.



-If stem is black with large insert,  
use GP1083167.



Must use proper valve for  
optimal performance.

## Touchless Conversion Kit

### K-1954

Upgrade your toilet to a no-touch flush. This easy-to-install retrofit kit brings a KOHLER touchless flush to almost any toilet. Once it's installed, just hold your hand over the tank sensor to activate the flush.



Visit us.[KOHLER.com](http://KOHLER.com) to see if your toilet is compatible.

# 2-Inch Flapper One-Piece Toilets

INGENIUM<sup>®</sup>  
KOHLER<sup>®</sup>

Toilets manufactured prior to 2004 most commonly have a 2-inch flapper.



**YOUR CAP COLOR  
DOES NOT MATTER.**

Use GP1138930  
GP1060294M (Mexico)



For your toilet,  
see pages 30–39.

Must use proper valve for  
optimal performance.



## Flappers

GP84995



Replaces flapper  
with rubber bar



GP83064



GP1078440



Replaces discontinued  
flappers 88925, 85655,  
84138, 84314

GP89825 –  
For Portrait<sup>®</sup> toilets



GP88921





# 2-Inch Flapper Two-Piece Toilets

Toilets manufactured prior to 2004 most commonly have a 2-inch flapper. All two-piece toilets that have a 2-inch flapper use fill valve GP1138930.



**YOUR CAP COLOR DOES NOT MATTER.**

Use GP1138930  
GP106094M (Mexico)



Must use proper valve for optimal performance.

Most two-piece flapper toilets will have:

Tank gasket GP51487



## Flappers

GP87449



Replaces these discontinued flappers



GP85160



Replaces these discontinued flappers



GP49114

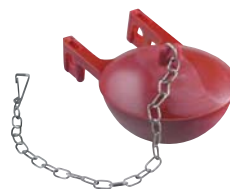

Older toilets may have a black flapper; replace with GP49114.

# 3¼-Inch Flapper One-Piece Toilets

**CLASS FIVE®**  
KOHLER®

Toilets that have a 3¼-inch flapper are Class Five® toilets.  
All Class Five toilets use fill valve GP1083167.



**YOUR CAP COLOR  
DOES NOT MATTER.**

Fill valve  
GP1083167  
GP10060299 (Mexico)



Must use this valve for  
optimal performance.

## Flappers

**GP1039444** – For Cimarron®  
and Memoirs®



**GP1067183** – For Gabrielle™



**GP1060740** – For Portrait®



# 3¼-Inch Flapper Two-Piece Toilets

CLASS FIVE<sup>®</sup>  
KOHLER<sup>®</sup>

Toilets that have a 3¼-inch flapper are Class Five<sup>®</sup> toilets. All Class Five toilets use fill valve GP1083167.



## Flapper

GP1078441



**YOUR CAP COLOR  
DOES NOT MATTER.**

Fill valve  
GP1083167  
GP1060299M (Mexico)



Must use this valve for optimal performance.

3" DryLock™ system  
gasket GP1018165-F



1024390  
(bolts)



# INDEX

## KOHLER® Toilet Model Numbers

K-10491.....	16	K-14343.....	50	K-3440.....	40	K-3505.....	58
K-10492.....	16	K-14344.....	50	K-3441.....	46	K-3506.....	50
K-10493.....	20	K-14345 (Canister) .....	14	K-3444.....	44	K-3509 (Canister) .....	20
K-10494.....	22	K-14345 (Flapper) .....	50	K-3445.....	42	K-3509 (Flapper) .....	52
K-10495.....	18	K-14346 (Canister) .....	14	K-3446.....	46	K-3510.....	48
K-11450.....	46	K-14346 (Flapper) .....	50	K-3447.....	42	K-3511 (Canister) .....	22
K-11451.....	18	K-14509.....	18	K-3448.....	42	K-3511 (Flapper) .....	52
K-11452.....	20	K-14797.....	22	K-3449.....	42	K-3512.....	48
K-11453.....	18	K-14799.....	22	K-3450.....	40	K-3513.....	50
K-11456.....	20	K-14824.....	18	K-3451 (2" Flapper) .....	32	K-3514.....	48
K-11460 (Canister) .....	22	K-15410.....	18	K-3451 (3¼" Flapper) ...	50	K-3515 (Canister) .....	20
K-11460 (Flapper) .....	52	K-3322.....	30	K-3452.....	44	K-3515 (Flapper) .....	52
K-11461 (Canister) .....	20	K-3323.....	38	K-3453 (2" Flapper) .....	32	K-3517.....	18
K-11461 (Flapper) .....	52	K-3324.....	30	K-3453 (3¼" Flapper) ...	50	K-3519.....	58
K-11465.....	52	K-3357.....	34	K-3454.....	42	K-3520.....	46
K-11470.....	46	K-3360.....	34	K-3455.....	44	K-3521.....	46
K-11471.....	22	K-3378.....	32	K-3456.....	42	K-3524.....	54
K-11473.....	22	K-3379.....	54	K-3457.....	42	K-3526 (Canister) .....	22
K-11492.....	22	K-3383.....	32	K-3458.....	58	K-3526 (Flapper) .....	52
K-11497.....	22	K-3384.....	38	K-3461.....	44	K-3527.....	46
K-11498.....	22	K-3385.....	36	K-3462.....	44	K-3530.....	40
K-11499.....	22	K-3386.....	34	K-3463.....	42	K-3531.....	58
K-11813.....	18	K-3390.....	30	K-3464.....	44	K-3532 (Canister) .....	20
K-11821.....	22	K-3393.....	54, 58	K-3465.....	44	K-3532 (Flapper) .....	52
K-11823.....	18	K-3394.....	58	K-3466.....	38	K-3533 (Canister) .....	22
K-11844.....	20	K-3395.....	38	K-3467.....	38	K-3533 (Flapper) .....	52
K-11889.....	50	K-3397.....	38	K-3468.....	44	K-3535.....	40
K-11899.....	38	K-3398.....	54	K-3470.....	40	K-3536.....	40
K-11968.....	22	K-3400.....	32	K-3471.....	40	K-3542 (Canister) .....	20
K-12697.....	18	K-3401.....	30	K-3472.....	40	K-3542 (Flapper) .....	52
K-12698.....	18	K-3402.....	34	K-3475.....	40	K-3544.....	58
K-12767.....	20	K-3404.....	58	K-3477.....	40	K-3546.....	58
K-14076.....	46	K-3405.....	32	K-3478.....	40	K-3548 (Canister) .....	22
K-14110.....	40	K-3406.....	36	K-3479.....	40	K-3548 (Flapper) .....	52
K-14128.....	40	K-3407.....	46	K-3480.....	40	K-3551.....	18
K-14133.....	46	K-3408.....	30	K-3481.....	46	K-3554.....	58
K-14143.....	46	K-3410.....	44	K-3482.....	44	K-3555.....	44
K-14150.....	40	K-3411.....	44	K-3483.....	44	K-3556.....	40
K-14178.....	44	K-3412.....	44	K-3484.....	42	K-3557.....	40
K-14210.....	46	K-3414.....	46	K-3485.....	44	K-3564.....	26
K-14213.....	40	K-3415.....	46	K-3486.....	44	K-3574.....	22
K-14230.....	34	K-3417.....	42	K-3487.....	52	K-3575.....	22
K-14239.....	44	K-3419.....	42	K-3488.....	30	K-3576.....	22
K-14247.....	44	K-3420.....	42	K-3489.....	50	K-3577.....	22
K-14250.....	40	K-3421.....	46	K-3490.....	44	K-3588.....	24
K-14257.....	30	K-3422.....	46	K-3491.....	44	K-3589.....	18
K-14258.....	30	K-3423.....	46	K-3492.....	54	K-3591.....	44
K-14261.....	34	K-3427.....	46	K-3493.....	58	K-3597.....	58
K-14268.....	30	K-3428.....	46	K-3496 (Canister) .....	18	K-3598.....	26
K-14286.....	30	K-3429.....	44	K-3496 (Flapper) .....	52	K-3600.....	32
K-14289.....	36	K-3432.....	46	K-3497 (Canister) .....	18	K-3607.....	54, 58
K-14290.....	36	K-3433.....	46	K-3497 (Flapper) .....	52	K-3608.....	50
K-14291.....	36	K-3434.....	34	K-3499.....	52	K-3609.....	18
K-14338.....	26	K-3435.....	36	K-3500.....	48	K-3611.....	22
		K-3437.....	54	K-3502.....	48	K-3612.....	34
		K-3438.....	46	K-3503.....	52	K-3615.....	14
		K-3439.....	44	K-3504.....	48	K-3619.....	14

K-3639.....	14
K-3651.....	44
K-3652.....	58
K-3654.....	24
K-3655.....	30
K-3667.....	22
K-3668.....	22
K-3669.....	22
K-3670.....	30
K-3678.....	18
K-3713.....	22
K-3722.....	16
K-3723.....	26
K-3753.....	24
K-3754.....	20
K-3755.....	20
K-3797.....	26
K-3802.....	50
K-3803.....	38
K-3804.....	34
K-3810.....	16
K-3811.....	16
K-3812.....	14
K-3813.....	14
K-3816.....	20
K-3817.....	22
K-3818.....	20
K-3819.....	22
K-3825.....	14
K-3827.....	18
K-3828.....	14
K-3837.....	18
K-3851.....	18
K-3887.....	18
K-3888.....	18
K-3889.....	22
K-3933.....	22
K-3900.....	56
K-3901.....	56
K-3940.....	14
K-3946.....	14
K-3947.....	22
K-3948.....	22
K-3949.....	22
K-3950.....	22
K-3977.....	22
K-3978.....	22
K-3979.....	22
K-3981.....	16
K-3986.....	20
K-3987.....	26
K-3988.....	26
K-3989.....	26
K-3997.....	22
K-3998.....	22
K-3999.....	22
K-4000.....	28
K-4007.....	16

K-45979.....	24
K-45989.....	24
K-5172.....	16
K-5692.....	28
K-5693.....	28
K-6303.....	26
K-6418.....	28
K-6419.....	28
K-6424.....	16
K-6428.....	16
K-6669.....	22
K-6925.....	14
K-6999.....	22
K-98864.....	26
K-98976.....	18
K-98977.....	18
K-98992.....	18
K-98993.....	16
K-98994.....	22

**KOHLER® Tank Model Numbers**

K-14078.....	46
K-14108.....	40
K-14129.....	40
K-14137.....	46
K-14147.....	46
K-14154.....	40
K-14179.....	44
K-14212.....	46
K-14215.....	40
K-14241.....	44
K-14249.....	44
K-14252.....	40
K-3613.....	44
K-4136.....	24
K-4137.....	24
K-4166.....	18
K-4167.....	18
K-4209.....	46
K-4383.....	18
K-4401.....	42
K-4403.....	42
K-4418.....	18
K-4419.....	24
K-4421.....	18
K-4431.....	18
K-4433.....	20
K-4434.....	22
K-4436.....	22
K-4437.....	22
K-4438.....	18
K-4441.....	26
K-4442.....	24
K-4445.....	42
K-4446.....	18
K-4447.....	42
K-4454.....	44

K-4456.....	40
K-4458.....	26
K-4464.....	44
K-4467.....	22
K-4468.....	22
K-4469.....	20
K-4470.....	58
K-4472.....	24
K-4473 (Canister).....	22
K-4473 (Flapper).....	52
K-4474.....	20
K-4484.....	58
K-4485 (Canister).....	20
K-4485 (Flapper).....	52
K-4491 (Tank).....	20
K-4491 (Flapper).....	52
K-4492 (Tank).....	22
K-4492 (Flapper).....	52
K-4493.....	18
K-4501.....	40
K-4504.....	46
K-4505.....	40
K-4509.....	40, 48
K-4512.....	46
K-4515.....	44
K-4516.....	44
K-4518.....	46
K-4519.....	46
K-4524.....	48
K-4586.....	42
K-4590.....	44
K-4591.....	40
K-4597.....	46
K-4605.....	40
K-4606.....	42
K-4608.....	44
K-4609.....	44
K-4619.....	42
K-4620.....	46
K-4621.....	46
K-4628.....	44
K-4632.....	22
K-4633.....	52
K-4634 (Canister).....	18
K-4634 (Flapper).....	52
K-4641.....	20
K-4642.....	22
K-4645.....	58
K-4646.....	46
K-4708.....	52
K-4742.....	26
K-4807.....	44
K-4835.....	18
K-4841.....	22
K-4899.....	22
K-5380.....	20
K-6284.....	26

**STERLING® Toilet & Tank Model Numbers**

402014.....	60
402015.....	60
402020.....	60
402024.....	60
402025.....	60
402027.....	60
402028.....	60
402075.....	60
402076.....	60
402077.....	60
402078.....	60
402079.....	60
402080.....	60
402081.....	60
402082.....	60
402083.....	60
402084.....	60
402085.....	60
402087.....	60
402088.....	60
402093.....	60
402212.....	60
402213.....	60
402214.....	60
402215.....	60
402220.....	60
402315.....	60
402375.....	60
402502.....	60
402522.....	60
402532.....	60
403080.....	60
403081.....	60
403082.....	60
404700.....	60
404701.....	60
404702.....	60
404705.....	60
402022.....	60
402023.....	60
402071.....	60
402091.....	60
404514.....	60
404515.....	60
404520.....	60
404544.....	60
404551.....	60
404552.....	60
404555.....	60

# Canister (Single-Flush) One-Piece Toilets

## Toilet













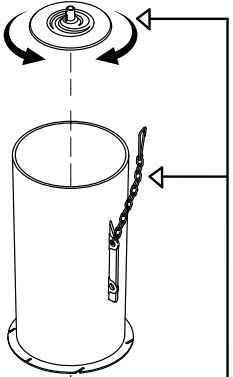

## Toilet Details

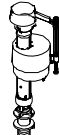
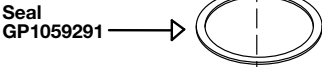
### Canister (Single-Flush) Toilets

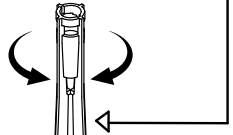
Product Name	Model Number	Tank Cover	Trip Lever
Adair® 	K-3946 K-6925	1180586* 	1034693* LH 1036058* RH 
Archer® 	K-3639	1046467* 	1067577* 
Cimarron® 	K-3828	1036367* 	1034693* LH 1036058* RH 
Cimarron With Concealed Trapway 	K-3619	1036367* 	1034693* LH 1036058* RH 
Gabrielle™ 	K-3615 K-3825  Artist Editions®: K-14345, K-14346	85407* 	1025329* LH 1025330* RH  1068627* LH 1080378* RH 
Kathryn® 	K-3940	1006066* 	1211496* LH 1264712* RH 
Memoirs® Classic   Memoirs Stately	K-3812 (Classic) K-3813 (Stately)	1220279* Classic   1220280* Stately 	1160316* LH   1160317* RH 

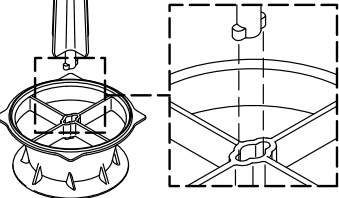
**Canister (Single-Flush) One-Piece Toilets**  
**KOHLER® Genuine Parts**

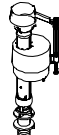
**Canister**  
**(Single-Flush) Toilets**

Float/Fill Valve	Chain/Guide/Seal	Canister	Tank Gasket
GP1083167 		1218038	GP83996 
GP1083167 	<p><b>NOTE: The canister should not fail. If leaking occurs, replace seal GP1059291.</b></p>	1216616	GP83996 
GP1060299M (Mexico Only)			
GP1083167 		1216624	GP83996 
GP1060299M (Mexico Only)			
GP1083167 		1255785	GP83996 
GP1083167 		1216611	GP83996 
GP1083167 		1211498	GP83996 
GP1083167 	<p><b>If tabs on guide or cap break, replace with GP1229656</b></p>	1216612	GP83996 







Note: Part numbers that have a "GP" prefix refer to a blister package. For example, GP1059291 is the same part as previous part number 1059291 but in a blister package.

# Canister (Single-Flush) One-Piece Toilets

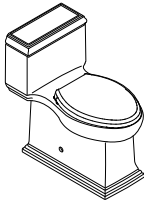
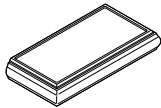
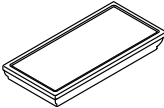
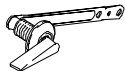
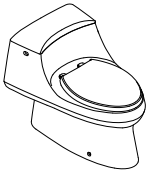
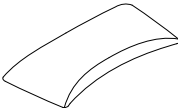
## Toilet

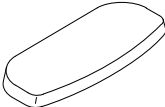
## Toilet Details

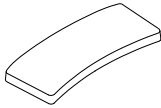

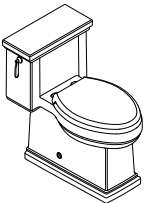
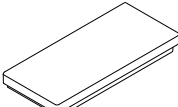
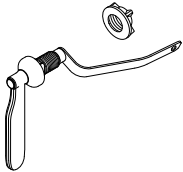





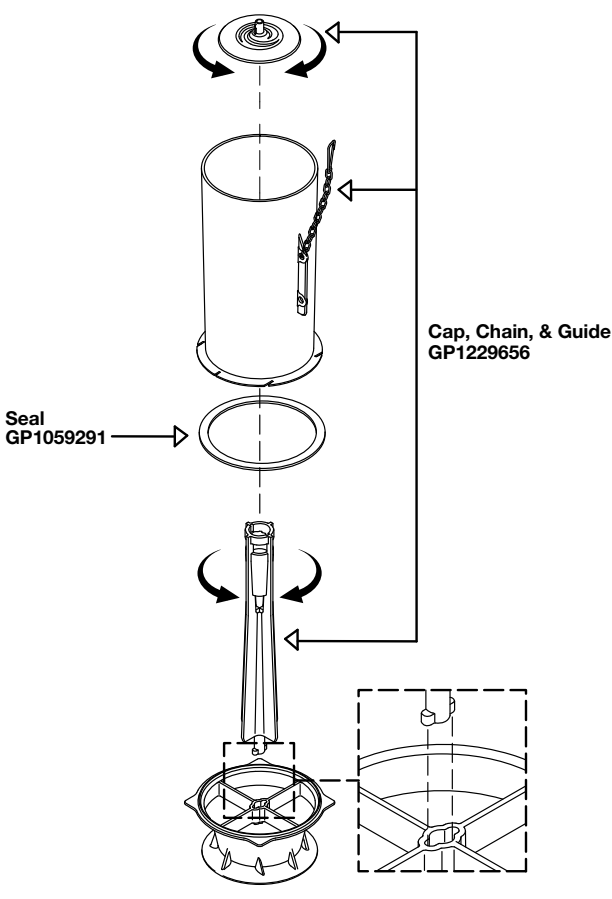

### Canister (Single-Flush) Toilets

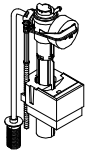
Product Name	Model Number	Tank Cover	Trip Lever
Memoirs® Skirted 	K-6424 (Classic) K-6428 (Stately)	1220279* Classic  1220280* Stately 	1160316* 
San Raphael® 	K-3722	1126374* 	1128497* 
Santa Rosa™ 	<b>1.28 GPF</b> <b>1.6 GPF</b> K-3810    K-3811 K-10491    K-10492 K-98993	88497* 	1158701* LH 1245886* RH 
San Souci® 	K-5172 (Elongated) K-4007 (Round-Front)	1182368* (Elongated)  1242241* (Round-Front)	1238613* LH (Elongated) 1241200* RH (Elongated)  1241416* LH (Round-Front)
Tresham® 	K-3981	1223375* 	1161319* 

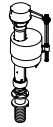

**Canister (Single-Flush) One-Piece Toilets**  
**KOHLER® Genuine Parts**

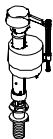
**Canister**  
 (Single-Flush) Toilets

Float/Fill Valve	Chain/Guide/Seal	Canister	Tank Gasket
GP1138930 	<p align="center"><b>NOTE: The canister should not fail. If leaking occurs, replace seal GP1059291.</b></p>  <p align="center"><b>Cap, Chain, &amp; Guide</b>                      GP1229656</p> <p><b>Seal</b>                      GP1059291</p> <p align="center"><b>If tabs on guide or cap break, replace with Kit GP1229656</b></p>	1244399	GP83996 
1128657 		1238986 Flapper 1138648 	GP83996 
GP1083167  GP1060299M (Mexico Only)		<p align="center"><b>1.6 GPF</b>                      1216619</p> <p align="center"><b>1.28 GPF</b>                      1216612                      1216625 (Mexico)</p>	GP83996 
1237539 (Elongated)  1241415 (Round)		1237538 (Elongated) 1227235 (Round-Front)	GP83996 
GP1083167 		1244399	GP83996 











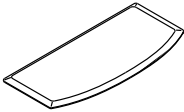

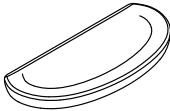

Note: Part numbers that have a "GP" prefix refer to a blister package. For example, GP1059291 is the same part as previous part number 1059291 but in a blister package.

# Canister (Single-Flush) Two-Piece Toilets

## Toilet



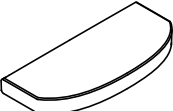

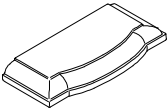
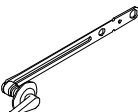





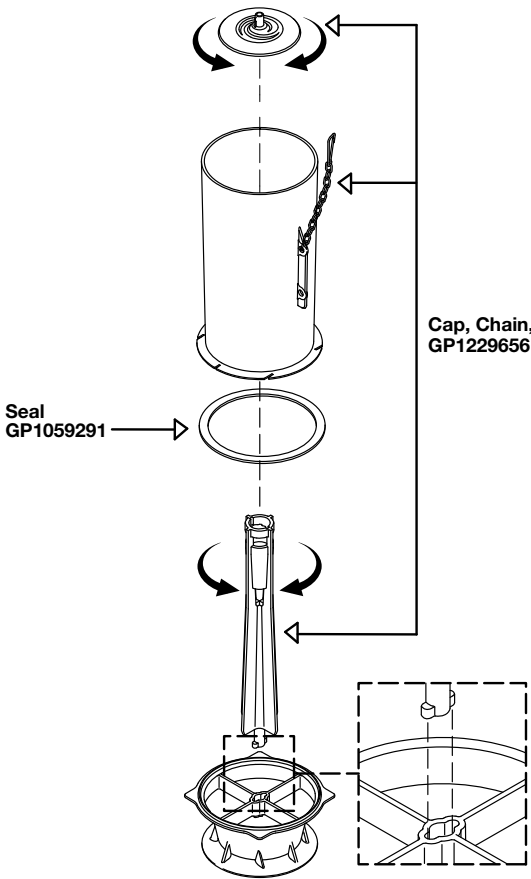

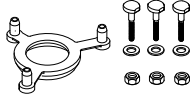

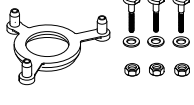

## Toilet Details

Canister  
(Single-Flush) Toilets

Product Name	Model Number	Tank Cover	Trip Lever
Archer <sup>®</sup> 	<b>1.28 GPF</b> K-3551, K-10495 Tank: K-4431  <b>1.6 GPF</b> K-3517 Tank: K-4493	1046467* 	1067577* 
Bancroft <sup>®</sup> 	K-3827 Tank: K-4383	1033723* 	1042212* 
Cavata <sup>®</sup> 	K-12697 K-12698 Tank: K-4835	1145294* 	1154764* 
Cimarron <sup>®</sup> 	<b>Elongated</b>  <b>1.28 GPF</b> K-3609, K-11451, K-11813, K-98977 Tank: K-4421  <b>1.6 GPF</b> K-3589, K-11456, K-11823 Tank: K-4418	1086929* 	1034693* LH 1116014* RH 
	<b>Round-Front</b>  <b>1.28 GPF</b> K-3851, K-3887, K-14509, K-15410, K-98976 Tank: K-4166  <b>1.6 GPF</b> K-3888 Tank: K-4167		
	<b>Elongated</b> <b>1.28 GPF</b> K-3496-HE, K-3496, K-3497, K-3499 Tank: K-4634-HE, K-4634		
Cimarron With Skirted Trapway 	K-5310 Tank: K-4369	1086929* 	1034693* LH 1116014* RH 
Devonshire <sup>®</sup> 	<b>1.28 GPF</b> K-3837, K-14824, K-98992 Tank: K-4438	1044820* 	1160316* LH 1160317* RH 
	<b>1.28 GPF</b> K-3678 Tank: K-4446		

# Canister (Single-Flush) Two-Piece Toilets KOHLER® Genuine Parts

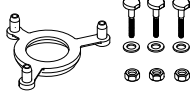
Canister  
(Single-Flush) Toilets











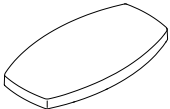
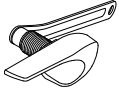
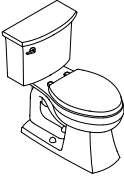
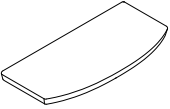

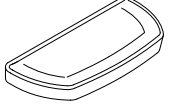
Float/Fill Valve	Chain/Guide/Seal	Canister	Tank Gasket	
GP1083167  GP1060299M (Mexico Only)	<p style="text-align: center;"><b>NOTE: The canister should not fail. If leaking occurs, replace seal GP1059291.</b></p>  <p style="text-align: center;"><b>Cap, Chain, &amp; Guide GP1229656</b></p> <p style="text-align: center;"><b>Seal GP1059291</b></p> <p style="text-align: center;"><b>If tabs on guide or cap break, replace with GP1229656</b></p>	<b>1.28 GPF</b> 1216613 1216621 (Mexico)	GP1018165-A (1.6 GPF) GP1018165-F (1.28 GPF)  1024390	
GP1083167  GP1060299M (Mexico Only)		1216614	GP51487 	
GP1083167  GP1060299M (Mexico Only)		1161447	GP51487 	
GP1083167  GP1060299M (Mexico Only)		1188999 1190386 (Lined Tank)	<b>1.28 GPF</b> 1188999 <b>1.6 GPF</b> 1188998	GP1112256 
GP1083167  GP1060299M (Mexico Only)		1189000 1191371 (Lined Tank)	<b>1.28 GPF</b> 1189000 <b>1.6 GPF</b> 1189001	1024390 
GP1138930 		1059288 (HE) 1083980	<b>1.28 GPF</b> 1059288 (HE) 1083980	GP1112256 
GP1138930 		1188998	1188998	1024390 
GP1083167  GP1060299M (Mexico Only)		1216615	1216615	GP51487 
GP1083167  GP1060299M (Mexico Only)		1126916	1126916	GP1018165-F  1024390

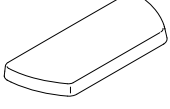
Note: Part numbers that have a "GP" prefix refer to a blister package.  
For example, GP1059291 is the same part as previous part number 1059291 but in a blister package.

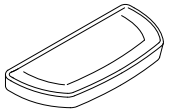
Canister (Single-Flush) Two-Piece Toilets  
Toilet

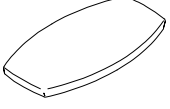
Toilet Details

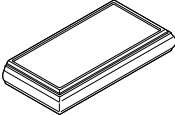









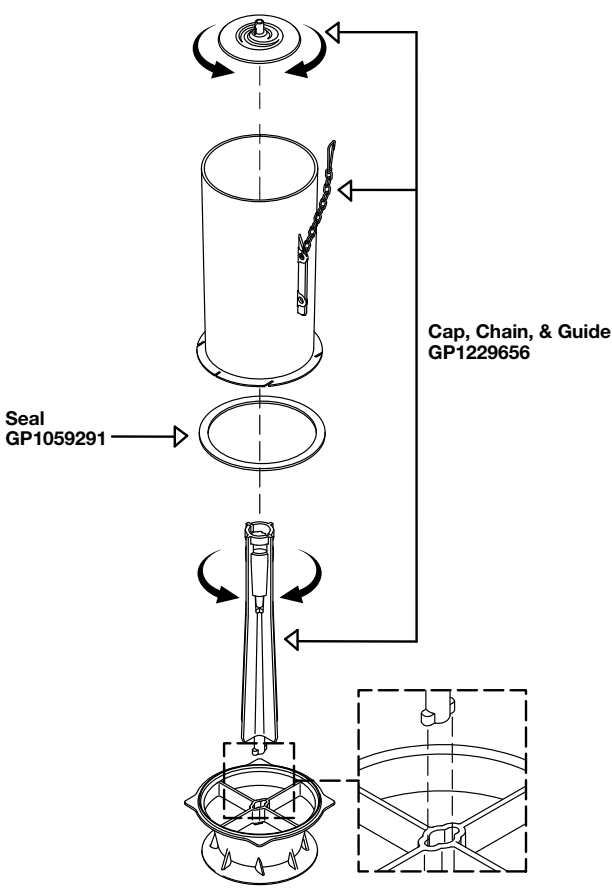

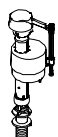

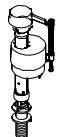
Canister  
(Single-Flush) Toilets

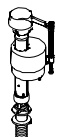
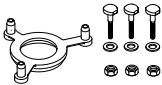
Product Name	Model Number	Tank Cover	Trip Lever	
Elliston® 	K-12767 Tank: K-5380	1211811* 	1213839* 	
Elmbrook™ 	K-45983 Complete Solution	1282458* 	1288036* 	
Highline® 	K-5298 Tank: K-5308	1138565* 	1142713* 	
Highline Classic 	K-5299 Tank: K-5307	84591* 	1117207* LH 1133133* RH 	
Highline With Concealed Trapway 	K-76301 Tank: K-5311	1138565* 	1142713* 	
Kelston® 	<b>1.28 GPF</b> K-11453, K-11844, K-3755 Tank: K-4469	<b>1.6 GPF</b> K-3754, K-11452 Tank: K-4474	1070414* 	1075394* 
Memoirs® Classic 	<b>1.28 GPF</b> K-3986, K-3816, K-10493 Tank: K-4433	1052861* Classic 	1160316* LH 1160317* RH 	
	<b>1.6 GPF</b> K-3818 Tank: K-4641			
	K-11461, K-3509, K-3515 Tank: K-4491			
	K-3532, K-3542 Tank: K-4485 (Lined)			

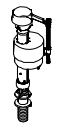
# Canister (Single-Flush) Two-Piece Toilets

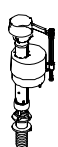
## KOHLER® Genuine Parts

Canister  
(Single-Flush) Toilets

Float/Fill Valve	Chain/Guide/Seal	Canister	Tank Gasket
GP1083167 	<p><b>NOTE: The canister should not fail. If leaking occurs, replace seal GP1059291.</b></p>  <p style="text-align: center;"><b>Cap, Chain, &amp; Guide GP1229656</b></p> <p style="text-align: center;"><b>Seal GP1059291</b></p> <p style="text-align: center;"><b>* If tabs on guide or cap break, replace with GP1229656</b></p>	1216610	GP1018165-F  1024390 
GP1083167 		1288037	GP1018165  1024390 
GP1083167 		1294218	GP51487 
GP1083167 		<b>1.0 GPF</b> 1294217	GP51487 
GP1138930 		1294219	GP51487 
GP1083167 		<b>1.28 GPF</b> 1216610 <b>1.6 GPF</b> 1216609	GP1018165-F 
GP1060299M (Mexico Only) 		<b>1.28 GPF</b> 1116617 1216622 (Lined Tank) <b>1.6 GPF</b> 1152861 (Lined Tank) 1216620 (K-4641) 1080961 (K-4491)	<b>1.28 GPF</b> GP51487  <hr/> <b>1.6 GPF</b> GP1018165-F   1024390











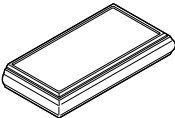

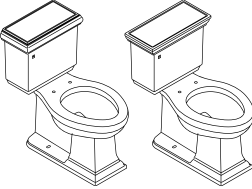

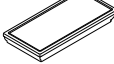
Note: Part numbers that have a "GP" prefix refer to a blister package. For example, GP1059291 is the same part as previous part number 1059291 but in a blister package.

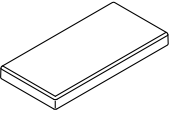
# Canister (Single-Flush) Two-Piece Toilets

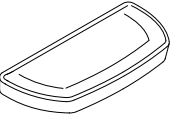
## Toilet

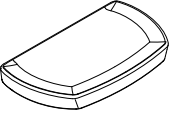
## Toilet Details

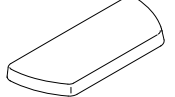
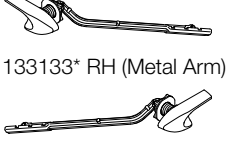

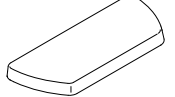
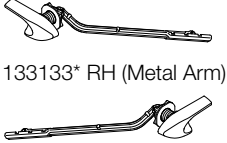







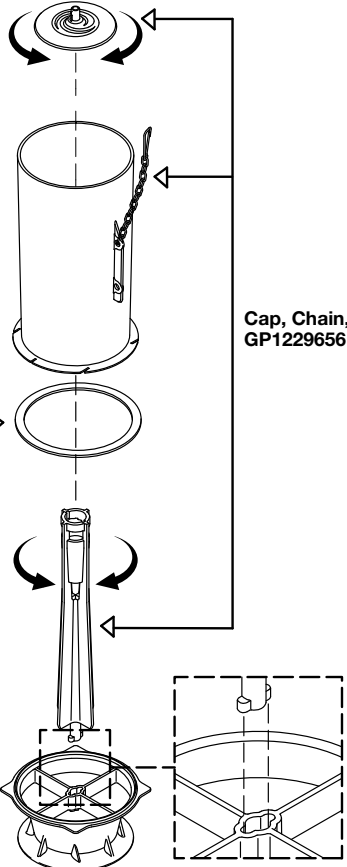
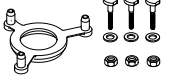
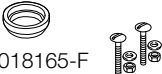

### Canister (Single-Flush) Toilets

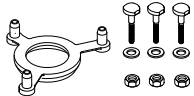
Product Name	Model Number	Tank Cover	Trip Lever
Memoirs® Stately 	<b>1.28 GPF</b> K-3933, K-3817, K-10494, K-98994 Tank: K-4434  <b>1.6 GPF</b> K-3819 Tank: K-4642  K-3511, K-3526, K-11460 Tank: K-4492  K-3533, K-3548, K-11968 Tank: K-4473 (Lined Tank)	1052862* Stately 	1160316* LH 1160317* RH 
Memoirs With Concealed Trapway 	<b>Classic</b> K-6999 Tank: K-4433  <b>Stately</b> K-6669 Tank: K-4434	1052861* Classic  1052862* Stately 	1160316* LH 1160317* RH 
Tresham® 	K-3950 Tank: K-4899	1146775* 	1161319* 
Wellworth®, Highline® 	<b>1.28 GPF</b> K-3997, K-3998, K-3999, K-3889, K-5481 Tank: K-4467  <b>1.6 GPF</b> K-3977, K-3978, K-3979 Tank: K-4468	1138565* 	1142713* 
Wellworth, Highline 	K-3947, K-3948, K-3949 Tank: K-4841	1145223* 	1142713* 
Wellworth Classic, Highline Classic 	<b>1.28 GPF</b> K-3658, K-3713 Tank: K-4436  <b>1.6 GPF</b> K-11821, K-11471, K-11473, K-11492, K-3574, K-3576, K-3611 Tank: K-4632	84591* 84095* (14" Tank) 	1117207* LH (Metal Arm) 1069723* LH (Plastic Arm)  1133133* RH (Metal Arm) 
Wellworth Classic 	<b>1.28 GPF</b> K-3575, K-3577, K-11497, K-11498, K-11499, K-14797, K-14799, K-11464, K-76407, K-5296, K-17068 Tank: K-4436  <b>1.6 GPF</b> K-3667, K-3668, K-3669 Tank: K-4437	84591* 84095* (14" Tank) 	1117207* LH (Metal Arm)  1133133* RH (Metal Arm) 

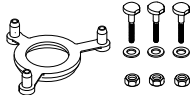
# Canister (Single-Flush) Two-Piece Toilets

## KOHLER® Genuine Parts

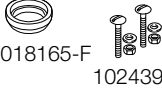
Canister  
(Single-Flush) Toilets

Float/Fill Valve	Chain/Guide/Seal	Canister	Tank Gasket		
GP1083167 	<p><b>NOTE: The canister should not fail. If leaking occurs, replace seal GP1059291.</b></p>  <p><b>Cap, Chain, &amp; Guide GP1229656</b></p> <p><b>Seal GP1059291</b></p> <p><b>If tabs on guide or cap break, replace with GP1229656</b></p>	<p><b>1.28 GPF</b> 1116617 1216622 (Lined Tank)</p> <p><b>1.6 GPF</b> 1152861 (Lined Tank) 1216620 (K-4642) 1080961 (K-4492)</p>	<p><b>1.28 GPF</b> GP51487</p>  <hr/> <p><b>1.6 GPF</b> GP1018165-F 1024390</p> 		
GP1083167 		1216617	GP51487		
GP1083167 GP1060299M (Mexico Only) 		1216618	GP51487		
GP1083167 GP1060299M (Mexico Only) 		1.28 GPF 1142714 115553 (Lined Tank)	1.6 GPF 1145365	GP51487	
GP1083167 		1151862 1160809 (Lined Tank)	GP51487		
GP1083167 		1.28 GPF 1117210	1.6 GPF 1069722 (Plastic Arm)	GP51487	
GP1083167 		1.28 gpf 1117210 1130564 (Lined Tank)	1.6 gpf 1158795 1158796 (Lined Tank)	GP51487	

Note: Part numbers that have a "GP" prefix refer to a blister package.  
For example, GP1059291 is the same part as previous part number 1059291 but in a blister package.

Canister (Dual-Flush) One- and Two-Piece Toilets





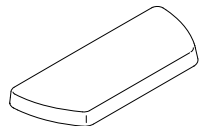
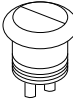





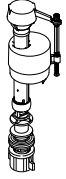
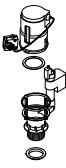

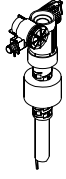
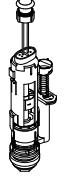

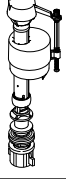

Toilet Details

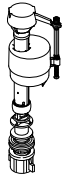
Canister  
(Dual-Flush) Toilets

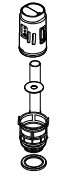
Product Name	Model Number	Tank Cover	Trip Lever/Flush Actuator
Cavata <sup>®</sup> 	K-45989 Tank: K-4137	1145294* 	1203699* 
Escala <sup>®</sup> 	K-3588 Tank: K-4472	1045184* 	1266856* 
Highline <sup>®</sup> 	K-45979 Tank: K-4136	84591* 	1208884* 
Persuade <sup>®</sup> 	K-3654 Tank: K-4419	Discontinued Service With 1260938* & 1265519*  Hole: 1 <sup>1</sup> / <sub>16</sub> " (40 mm)	1266856*  For use with 1 <sup>1</sup> / <sub>16</sub> " hole
		1260938*  Hole: 2" (51 mm)	1265519*  For use with 2" hole
Persuade Circ 	K-3753 Tank: K-4442	Discontinued Service With 1238836* & 1265519*  Hole: 1 <sup>1</sup> / <sub>16</sub> " (40 mm)	1266856*  For use with 1 <sup>1</sup> / <sub>16</sub> " hole
		1238836*  Hole: 2" (51 mm)	1265519*  For use with 2" hole

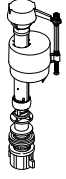

Canister (Dual-Flush) One- and Two-Piece Toilets  
**KOHLER®** Genuine Parts

Float/Fill Valve	Flush Valve	Tank Gasket	Canister Seal
GP1083167 	1203698 	GP51487 	1203764 
1246185 	1095687* 	1036170 	1131496 
GP1083167 	1208883 	GP51487 	1203764 
GP1138930 	Service with 1266856* flush actuator and 1269696 flush valve	1107584 	1131496 
	1269696 		1270755 
GP1138930 	Service with 1266856* flush actuator and 1269696 flush valve	1107584 	1131496 
	1269696 		1270755 









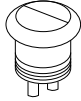
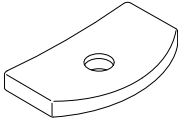

Canister  
 (Dual-Flush) Toilets

Note: Part numbers that have a "GP" prefix refer to a blister package.  
 For example, GP1059291 is the same part as previous part number 1059291 but in a blister package.

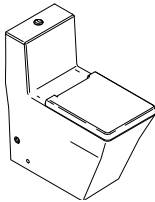
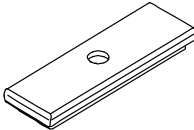
Canister (Dual-Flush) One- and Two-Piece Toilets  
Toilet

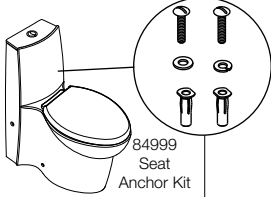
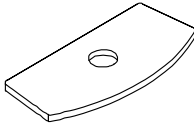
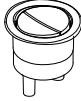
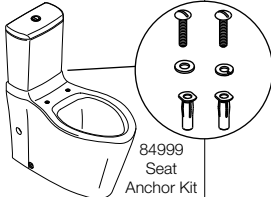

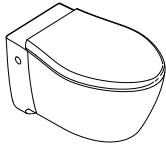
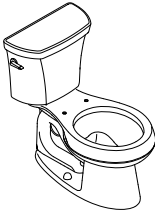
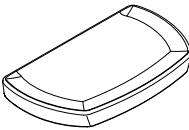







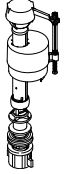



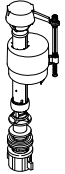

Toilet Details

Canister  
(Dual-Flush) Toilets

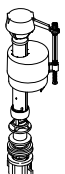
Product Name	Model Number	Tank Cover	Trip Lever/Flush Actuator
Persuade® Curv 	K-3723, K-98864 Tank: K-4441	Discontinued Service With 1217371* & 1265519*  Hole: 1 1/16" (40 mm)	1266856*  For use with 1 1/16" hole
		1217371*  Hole: 2" (51 mm)	1265519*  For use with 2" hole
Réve® 	K-3797	1113930* 	1266856* 
Saile® 	K-3564 Artist Editions®: K-14338	1081363* 	1266856* 
Strela® 	K-3598 Tank: K-4742	Discontinued	1266856* 
Veil® 	K-6300, 6303, 6304 In-Wall Tank: K-6284, K-18829	N/A	K-6298* 
Wellworth® 	K-3987, K-3988, K-3989 Tank: K-4458	1138565* 	1208884* LH 1203699* RH 

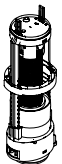
\*Include the color or finish code after the part number when ordering.

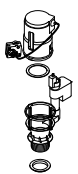
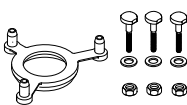
Canister (Dual-Flush) One- and Two-Piece Toilets  
 KOHLER® Genuine Parts

Float/Fill Valve	Flush Valve	Tank Gasket	Canister Seal
GP1138930 	Service with 1266856* flush actuator and 1269696 flush valve <hr/> 1269696 	1107584 	1131496  <hr/> 1270755 
GP1138930 	1119360 	1118481 	1131496 
GP1138930 	1097231 	GP83996 	1131496 
GP1138930 	Use 1269696* & 1266856* 	1107584 	1131496 
1155514 	1155519 	1150348 	N/A
GP1083167 	1208885 LH 1224140 RH 	GP51487 	1203764 

Canister  
 (Dual-Flush) Toilets







Note: Part numbers that have a "GP" prefix refer to a blister package.  
 For example, GP1059291 is the same part as previous part number 1059291 but in a blister package.

# Touchless Toilets



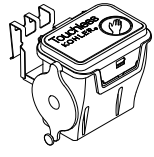

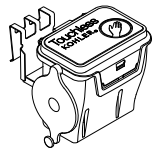

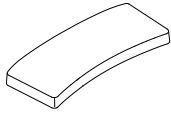
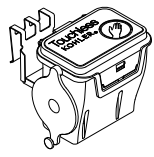
## Toilet

## Toilet Details

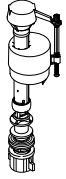
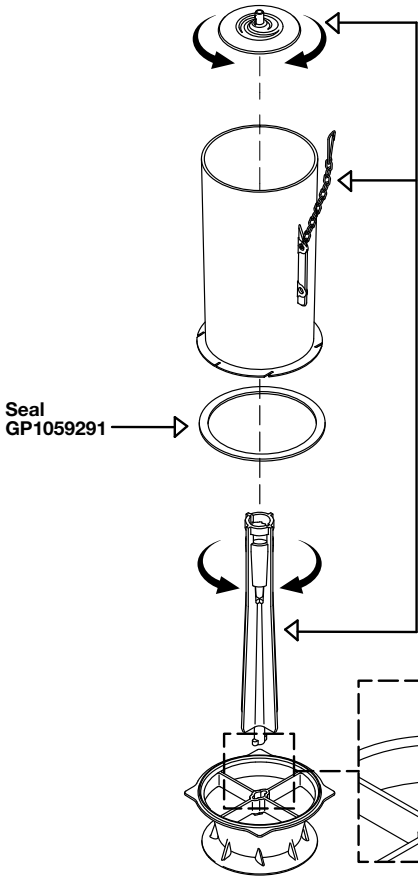
Touchless Toilets

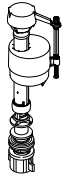
Product Name	Model Number	Tank Cover	Touchless
<p>Cimarron® Elongated</p> 	<p>K-6418 Tank: K-5692</p>	<p>1086929*</p> 	<p>1256315</p> 
<p>Cimarron Round-Front</p> 	<p>K-6419 Tank: K-5693</p>	<p>1086929*</p> 	<p>1256315</p> 
<p>San Souci®</p> 	<p>K-4000</p>	<p>1182368*</p> 	<p>1256315</p> 

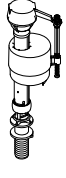
# Touchless Toilets KOHLER® Genuine Parts

Float/Fill Valve	Chain/Chain/Seal	Canister	Tank Gasket
<p>GP1083167</p> 	<p><b>NOTE: The canister should not fail. If leaking occurs, replace seal GP1059291.</b></p>  <p style="text-align: center;">Cap, Chain, &amp; Guide GP1229656</p> <p>Seal GP1059291</p> <p style="text-align: center;">If tabs on guide or cap break, replace with GP1229656</p>	<p>1241992</p>	<p>GP1112256</p> 
<p>GP1138930</p> 		<p>1241991</p>	<p>GP1112256</p> 
<p>1237539</p> 		<p>1227235</p>	<p>GP83996</p> 









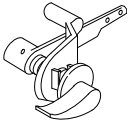
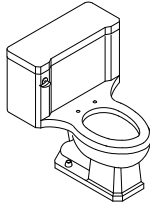

Touchless Toilets

Note: Part numbers that have a "GP" prefix refer to a blister package. For example, GP1059291 is the same part as previous part number 1059291 but in a blister package.

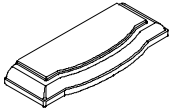
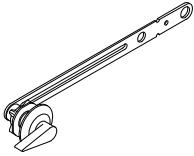
## 2-Inch Flapper One-Piece Toilets

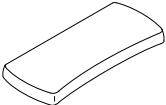

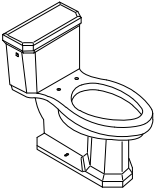
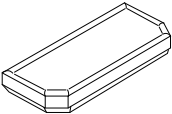



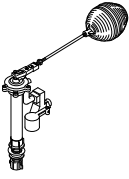
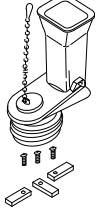
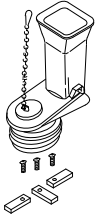
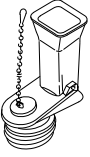
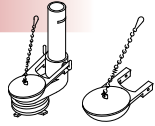
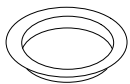

### Toilet

### Toilet Details

Product Name	Model Number	Tank Cover	Trip Lever
Cabernet™  	K-3401 K-3408	Discontinued	Various trip levers; visit <a href="http://KOHLER.com/ServiceParts">KOHLER.com/ServiceParts</a> .
Champlain™  	K-3390	Discontinued	77046* 
Channel™, Bolton™  	K-3655 K-3670	Discontinued	500195* 
Devonshire®  	K-3488	1021921* 	1031599* 
Gabrielle™  	K-3322 Artist Editions®: K-14257, K-14258, K-14286	85407* 	1025329* LH  1025330* RH 
Kathryn®  	K-3324 Artist Editions: K-14268	1006066* 	K-9451*  85085* 

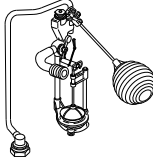
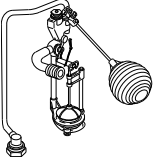
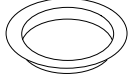
**2-Inch Flapper  
One-Piece Toilets**

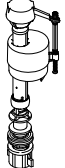
## 2-Inch Flapper One-Piece Toilets KOHLER® Genuine Parts

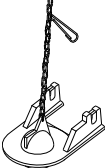
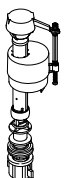
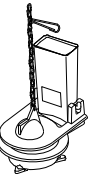
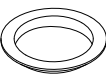
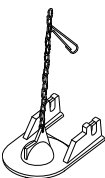
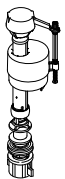
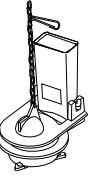
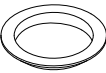
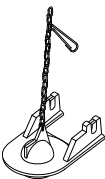
Float/Fill Valve	Flush Valve	Tank Gasket	Flush Ball/Flapper
<p>84499</p>  	<p>83650</p>  <hr/> <p>83094</p>  <p><b>DISCONTINUED</b> Use 83094</p>  <p>If your toilet currently has this style flush valve and flapper, we recommend they be replaced with flush valve 83094 to prevent potential water damage.</p>	<p>GP53410</p>  <p>GP83888</p> 	<p>GP83064</p>  <p>GP83064</p> 
<p>30669</p> 	<p>30669</p> 	<p>GP53410</p> 	<p>GP88921</p> 
<p>Discontinued</p>	<p>Discontinued</p>	<p>N/A</p>	
<p>GP1138930</p> 	<p>1032640</p> 	<p>GP83996</p> 	<p>GP1078440</p> 
<p>GP1138930</p> 	<p>87998</p> 	<p>GP83996</p> 	<p>GP1078440</p> 
<p>GP1138930</p> 	<p>87998</p> 	<p>GP83996</p> 	<p>GP1078440</p> 







2-Inch Flapper  
One-Piece Toilets

Note: Part numbers that have a "GP" prefix refer to a blister package.  
For example, GP1059291 is the same part as previous part number 1059291 but in a blister package.

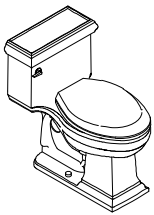
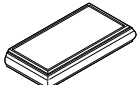
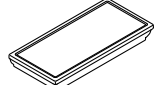
## 2-Inch Flapper One-Piece Toilets

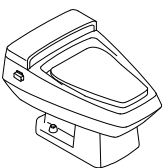
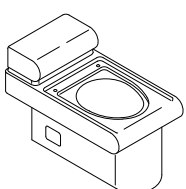
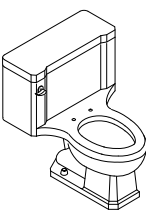
### Toilet

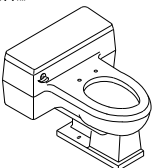









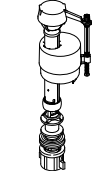
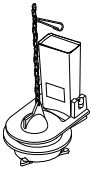
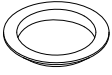
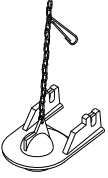

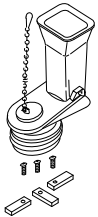
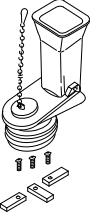
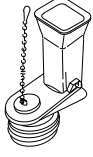
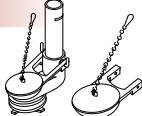
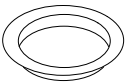
### Toilet Details

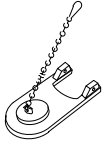
Product Name	Model Number	Tank Cover	Trip Lever
Memoirs <sup>®</sup> 	K-3451 K-3453	1220279* Classic  1220280* Stately 	1039863* 
Palarre <sup>™</sup> 	K-3383	Discontinued	Various trip levers; visit <a href="http://KOHLER.com/ServiceParts">KOHLER.com/ServiceParts</a> .
Pillow Talk <sup>™</sup> 	K-3378	Discontinued	Various trip levers; visit <a href="http://KOHLER.com/ServiceParts">KOHLER.com/ServiceParts</a> .
Placid <sup>™</sup> 	K-3405 K-3600	Discontinued	51170* 
Pompton <sup>™</sup> 	K-3400	Discontinued	51170* 

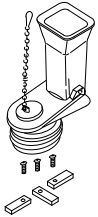
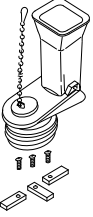
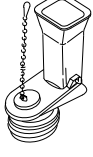
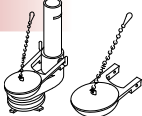
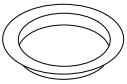
2-Inch Flapper One-Piece Toilets

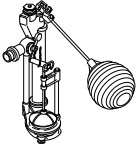

## 2-Inch Flapper One-Piece Toilets KOHLER® Genuine Parts

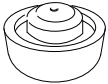
Float/Fill Valve	Flush Valve	Tank Gasket	Flush Ball/Flapper
<p>GP1138930</p> 	<p>87998</p> 	<p>GP83996</p> 	<p>GP1078440</p> 
<p>84499</p>  	<p>83650</p>  <hr style="border-top: 1px dashed black;"/> <p>83094</p>  <p><b>DISCONTINUED</b> Use 83094</p>  <p>If your toilet currently has this style flush valve and flapper, we recommend they be replaced with flush valve 83094 to prevent potential water damage.</p>	<p>GP53410</p>  <hr style="border-top: 1px dashed black;"/> <p>GP83888</p> 	<p>GP83064</p>  <hr style="border-top: 1px dashed black;"/> <p>GP83064</p> 
<p>84499</p>  	<p>83650</p>  <hr style="border-top: 1px dashed black;"/> <p>83094</p>  <p><b>DISCONTINUED</b> Use 83094</p>  <p>If your toilet currently has this style flush valve and flapper, we recommend they be replaced with flush valve 83094 to prevent potential water damage.</p>	<p>GP53410</p>  <hr style="border-top: 1px dashed black;"/> <p>GP83888</p> 	<p>GP83064</p>  <hr style="border-top: 1px dashed black;"/> <p>GP83064</p> 
<p>Discontinued</p>	<p>Discontinued</p>	<p>Discontinued</p>	<p>N/A</p>
<p>30668</p> 	<p>30668</p> 	<p>1145626</p> 	<p>GP88921</p> 







**2-Inch Flapper  
One-Piece Toilets**

Note: Part numbers that have a "GP" prefix refer to a blister package.  
For example, GP1059291 is the same part as previous part number 1059291 but in a blister package.

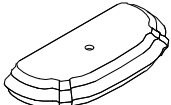
# 2-Inch Flapper One-Piece Toilets

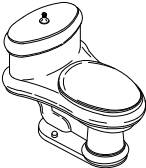
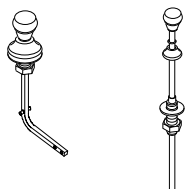
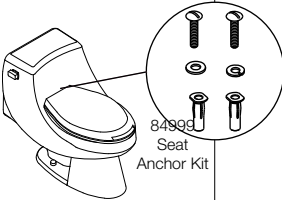

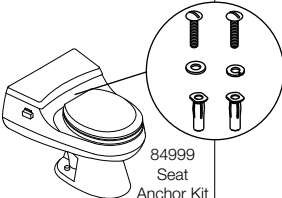
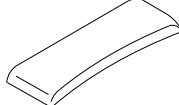

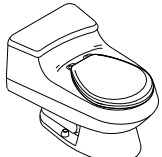





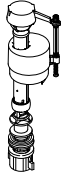
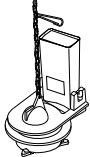

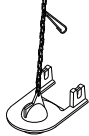
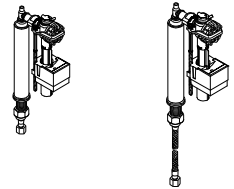





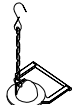
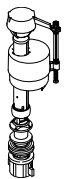

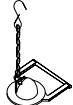

## Toilet

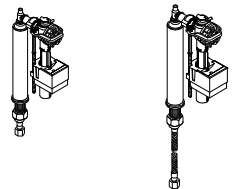
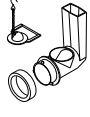
## Toilet Details

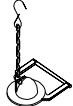
Product Name	Model Number	Tank Cover	Trip Lever
Portrait® 	K-3357 Artist Editions®: K-14261	89809* 	83725* 
Revival® 	K-3360, K-3612 Artist Editions: K-14230	Discontinued	1000833*    83725* 
Rosario™ 	K-3434	Discontinued	78423* 
Rialto® 	K-3386 K-3804	84252* 	85114* 
Rialto 	K-3402	Discontinued	Various trip levers; visit <a href="http://KOHLER.com/ServiceParts">KOHLER.com/ServiceParts</a> .

2-Inch Flapper One-Piece Toilets

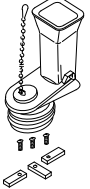
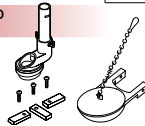
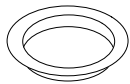
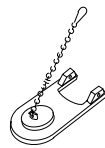
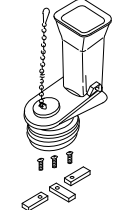
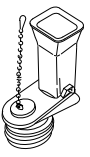
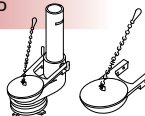
## 2-Inch Flapper One-Piece Toilets KOHLER® Genuine Parts

Float/Fill Valve	Flush Valve	Tank Gasket	Flush Ball/Flapper
<p>GP1138930</p> 	<p>89827 1060862</p> 	<p>GP83996</p> 	<p>GP89825</p> 
<p>1007490 (Brass Shank) GP1068030 (Plastic Shank)</p> <p>For Rigid Connection      For Flex Connection</p> 	<p>84305</p> 	<p>GP83996</p> 	<p>GP1078440</p> 
	<p>1000837</p> 	<p>84676</p> 	<p>GP84995</p> 
<p>GP1138930</p> 	<p>86972</p> 	<p>84676</p> 	<p>GP84995</p> 
	<p>83093</p> 	<p>GP83888</p> 	<p>GP83064</p> 
<p>GP1068030      1068033</p> <p>For Rigid Connection      For Flex Connection</p> 	<p>1078578</p> 	<p>84676</p> 	<p>GP84995</p> 
	<p>84302</p> 	<p>GP83996</p> 	<p>GP1078440</p> 
<p>84499</p> 	<p>83650</p>  <p><b>DISCONTINUED</b> Use 83650</p>  <p>If your toilet currently has this style flush valve and flapper, we recommend they be replaced with flush valve 83650 to prevent potential water damage.</p>	<p>GP53410</p> 	<p>GP83064</p> 
	<p>83095</p>  <p><b>DISCONTINUED</b> Use 83095</p>  <p>If your toilet currently has this style flush valve and flapper, we recommend they be replaced with flush valve 83095 to prevent potential water damage.</p>	<p>GP83888</p> 	<p>GP83064</p> 



2-Inch Flapper One-Piece Toilets

Note: Part numbers that have a "GP" prefix refer to a blister package. For example, GP1059291 is the same part as previous part number 1059291 but in a blister package.

# 2-Inch Flapper One-Piece Toilets



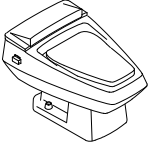
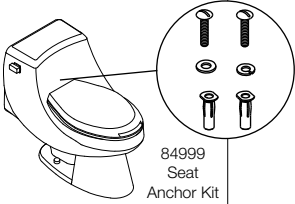









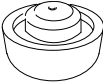
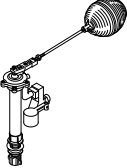
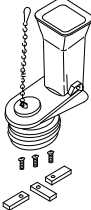
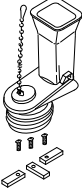

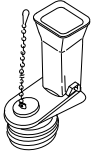
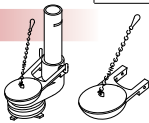

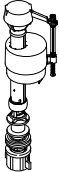
## Toilet

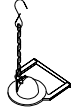
## Toilet Details

Product Name	Model Number	Tank Cover	Trip Lever
<p>Rochelle™</p> 	<p>K-3385</p>	<p>Discontinued</p>	<p>Various trip levers; visit <a href="http://KOHLER.com/ServiceParts">KOHLER.com/ServiceParts</a>.</p>
<p>San Martine®</p>  <p>84999 Seat Anchor Kit</p>	<p>K-3435 Artist Editions®: K-14289, K-14290, K-14291</p>	<p>Discontinued</p>	<p>Various trip levers; visit <a href="http://KOHLER.com/ServiceParts">KOHLER.com/ServiceParts</a>.</p>
<p>San Miguel™</p> 	<p>K-3406</p>	<p>Discontinued</p>	<p>Various trip levers; visit <a href="http://KOHLER.com/ServiceParts">KOHLER.com/ServiceParts</a>.</p>

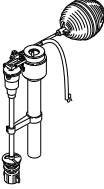
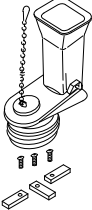
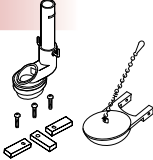
2-Inch Flapper  
One-Piece Toilets

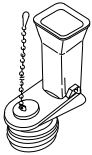
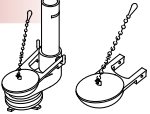
## 2-Inch Flapper One-Piece Toilets KOHLER® Genuine Parts

Float/Fill Valve	Flush Valve	Tank Gasket	Flush Ball/Flapper
<p>30668 (prior to 1990)</p> 	<p>30668</p> 	<p>1145626</p> 	<p>GP88921</p> 
<p>84499</p>  	<p>83650</p> 	<p>GP53410</p> 	<p>GP83064</p> 
	<p>83094</p>  <p><b>DISCONTINUED</b> Use 83094</p>  <p>If your toilet currently has this style flush valve and flapper, we recommend they be replaced with flush valve 83094 to prevent potential water damage.</p>	<p>GP83888</p> 	<p>GP83064</p> 
<p>GP1138930</p> 	<p>86972</p> 	<p>84676</p> 	<p>GP84995</p> 
	<p>83093</p> 	<p>GP83888</p> 	<p>GP83064</p> 
<p>30671</p> 	<p>84216</p>  <p><b>DISCONTINUED</b> Use 84216</p>  <p>If your toilet currently has this style flush valve and flapper, we recommend they be replaced with flush valve 84216 to prevent potential water damage.</p>	<p>GP53410</p> 	<p>GP49114</p> 
	<p>84217</p>  <p><b>DISCONTINUED</b> Use 84217</p>  <p>If your toilet currently has this style flush valve and flapper, we recommend they be replaced with flush valve 84217 to prevent potential water damage.</p>	<p>GP83888</p> 	<p>GP49114</p> 







2-Inch Flapper  
One-Piece Toilets

Note: Part numbers that have a "GP" prefix refer to a blister package.  
For example, GP1059291 is the same part as previous part number 1059291 but in a blister package.

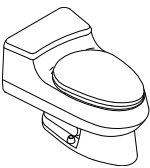
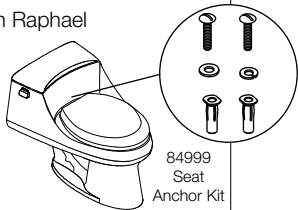
## 2-Inch Flapper One-Piece Toilets

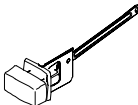
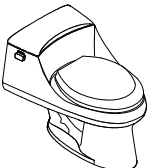

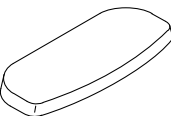







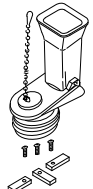

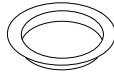

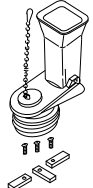

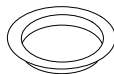

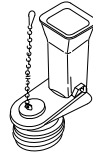
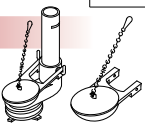

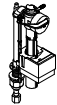
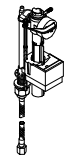
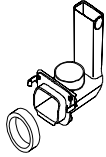

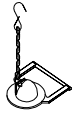
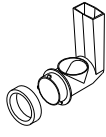
### Toilet

### Toilet Details

Product Name	Model Number	Tank Cover	Trip Lever
San Raphael® 	K-3395	Discontinued	Various trip levers; visit <a href="http://KOHLER.com/ServiceParts">KOHLER.com/ServiceParts</a> .
San Raphael 	K-3397	Discontinued	Various trip levers; visit <a href="http://KOHLER.com/ServiceParts">KOHLER.com/ServiceParts</a> .
San Raphael  <p style="font-size: small;">84999 Seat Anchor Kit</p>	K-3466 K-3467	1010658* 	1013521* 
San Raphael 	K-3384	Discontinued	85114* 
Santa Rosa™ 	K-3323 K-3803 K-11899	88497* 	87115* 

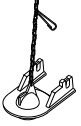
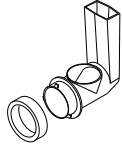
2-Inch Flapper One-Piece Toilets

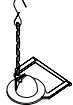
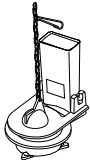
## 2-Inch Flapper One-Piece Toilets KOHLER® Genuine Parts

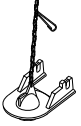
Float/Fill Valve	Flush Valve	Tank Gasket	Flush Ball/Flapper	
Discontinued	<p>83650</p>  <p><b>DISCONTINUED</b> Use 83650</p> 	<p>GP53410</p>  <p>If your toilet currently has this style flush valve and flapper, we recommend they be replaced with flush valve 83650 to prevent potential water damage.</p>	<p>GP83064</p> 	
84499	<p>83650</p>  <p><b>DISCONTINUED</b> Use 83650</p> 	<p>GP53410</p>  <p>If your toilet currently has this style flush valve and flapper, we recommend they be replaced with flush valve 83650 to prevent potential water damage.</p>	<p>GP83064</p> 	
	<p>83095</p>  <p><b>DISCONTINUED</b> Use 83095</p> 	<p>GP83888</p>  <p>If your toilet currently has this style flush valve and flapper, we recommend they be replaced with flush valve 83095 to prevent potential water damage.</p>	<p>GP83064</p> 	
<p>1013282 For Rigid Connection</p> 	<p>1068031 For Flex Connection</p> 	<p>1013944</p>  	<p>84676</p> 	<p>GP84995</p> 
GP1068030	<p>1016123</p>  	<p>84676</p> 	<p>1010376</p> 	
	<p>84284</p>  	<p>GP83996</p> 	<p>GP1078440</p> 	
	<p>84996</p>  	<p>84676</p> 	<p>GP84995</p> 	
GP1138930	<p>87998</p> 	<p>GP83996</p> 	<p>GP1078440</p> 	







2-Inch Flapper One-Piece Toilets

Note: Part numbers that have a "GP" prefix refer to a blister package.  
For example, GP1059291 is the same part as previous part number 1059291 but in a blister package.

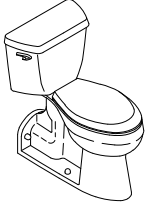
## 2-Inch Flapper Two-Piece Toilets

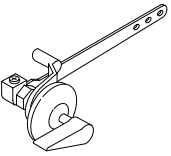
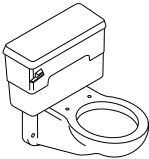
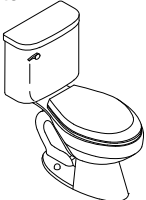
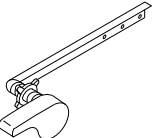
### Toilet











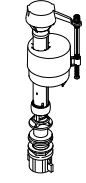
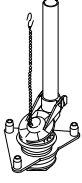

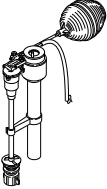
### Toilet Details

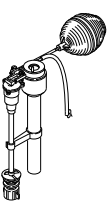
Product Name	Model Number	Tank Cover	Trip Lever
Barrington® Water-Guard® 	K-3530, K-3535, K-3536 Tank: K-4519	Discontinued	Various trip levers; visit <a href="http://KOHLER.com/ServiceParts">KOHLER.com/ServiceParts</a> .
Bolton Aqua Vent 	K-3450 Tank: K-4505 K-3475 Tank: K-4509	Discontinued	500189* 
Cayuga 	K-3440 Tank: K-4509	Discontinued	Various trip levers; visit <a href="http://KOHLER.com/ServiceParts">KOHLER.com/ServiceParts</a> .
Confidante 	K-3556, K-3557 Tank: K-4456	Discontinued	84625* 
Couture 	K-3471, K-3472 Tank: K-4591 Artist Editions®: K-14213 Tank: K-14215 K-14250 Tank: K-14252	Discontinued	Various trip levers; visit <a href="http://KOHLER.com/ServiceParts">KOHLER.com/ServiceParts</a> .
Couture 	K-3477, K-3478, K-3479, K-3480 Tank: K-4605	Discontinued	Various trip levers; visit <a href="http://KOHLER.com/ServiceParts">KOHLER.com/ServiceParts</a> .
Couture Water-Guard 	K-3470 Tank: K-4501 Artist Editions: K-14110 Tank: K-14108 K-14150 Tank: K-14154 K-14128 Tank: K-14129	Discontinued	Various trip levers; visit <a href="http://KOHLER.com/ServiceParts">KOHLER.com/ServiceParts</a> .

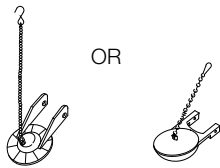
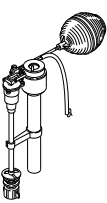
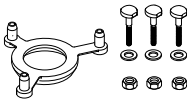
2-Inch Flapper Two-Piece Toilets

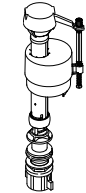
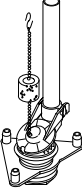
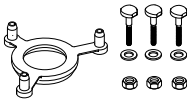
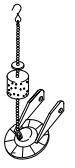
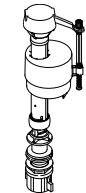
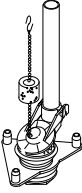
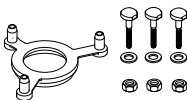

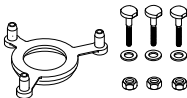
## 2-Inch Flapper Two-Piece Toilets KOHLER® Genuine Parts

Float/Fill Valve	Flush Valve	Tank Gasket	Flush Ball/Flapper
<p>GP1138930</p> 	<p>85406</p> 	<p>GP51487</p> 	<p>GP87449</p> 
<p>30671</p> 	<p>Discontinued</p>	<p>Discontinued</p>	<p>GP87449</p> 
<p>30671</p> 	<p>Discontinued</p>	<p>51531 GP52050</p> 	<p>GP87449      GP49114</p> <p>OR</p> 
<p>30671</p> 	<p>Discontinued</p>	<p>GP51487</p> 	<p>GP85160</p> 
<p>GP1138930</p> 	<p>1003068</p> 	<p>GP51487</p> 	<p>GP85160</p> 
<p>GP1138930</p> 	<p>1007489</p> 	<p>GP51487</p> 	<p>GP85160</p> 
<p>Discontinued</p>	<p>Discontinued</p>	<p>GP51487</p> 	<p>GP87449</p> 







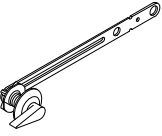

2-Inch Flapper  
Two-Piece Toilets

Note: Part numbers that have a "GP" prefix refer to a blister package.  
For example, GP1059291 is the same part as previous part number 1059291 but in a blister package.

## 2-Inch Flapper Two-Piece Toilets

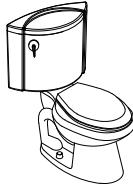



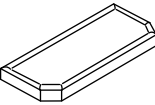



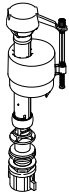
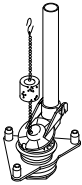

### Toilet

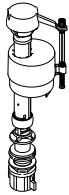
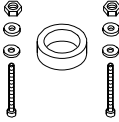
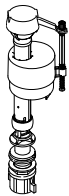
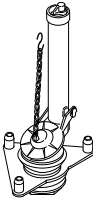
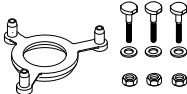
### Toilet Details

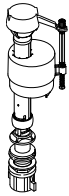
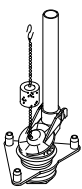
Product Name	Model Number	Tank Cover	Trip Lever
Devonshire® 	K-3457 Tank: K-4619	Discontinued	85086* 
Fleur 	K-3417 Tank: K-4586	Discontinued	Various trip levers; visit <a href="http://KOHLER.com/ServiceParts">KOHLER.com/ServiceParts</a> .
Fleur 	K-3447 Tank: K-4606	Discontinued	83725* 
Folio 	K-3419, K-3445, K-3448, K-3449, K-3454 Tank: K-4447	Discontinued	Various trip levers; visit <a href="http://KOHLER.com/ServiceParts">KOHLER.com/ServiceParts</a> .
Iron Works® 	K-3456, K-3463 Tank: K-4401	89970* 	1010199* 
Kathryn® 	K-3484 Tank: K-4403	1015781* 	Discontinued

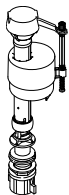
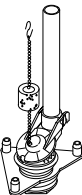
2-Inch Flapper Two-Piece Toilets

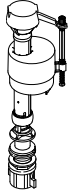
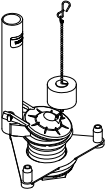
## 2-Inch Flapper Two-Piece Toilets KOHLER® Genuine Parts

Float/Fill Valve	Flush Valve	Tank Gasket	Flush Ball/Flapper
GP1138930 	84665 	GP51487 	GP85160 
GP1138930 	Discontinued	84539 	N/A
GP1138930 	85302 	GP51487 	GP87449 
GP1138930 	1004808 	GP51487 	GP85160 
GP1138930 	1003068 	GP51487 	GP85160 
GP1138930 	1020751 	GP51487 	GP85160 











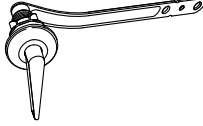

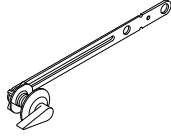
2-Inch Flapper  
Two-Piece Toilets

Note: Part numbers that have a "GP" prefix refer to a blister package.  
For example, GP1059291 is the same part as previous part number 1059291 but in a blister package.

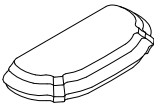
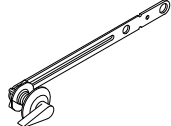
## 2-Inch Flapper Two-Piece Toilets

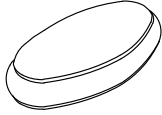



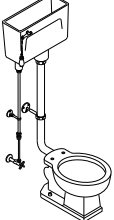





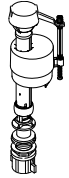
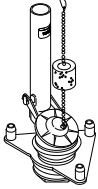

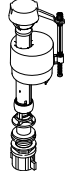
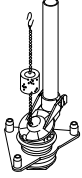
### Toilet

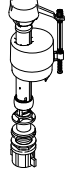
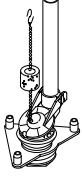
### Toilet Details

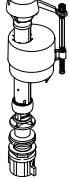
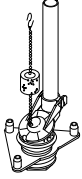
Product Name	Model Number	Tank Cover	Trip Lever
Leighton® 	K-3486, K-3651 Tank: K-4628	Discontinued	1022562* 
Memoirs® 	<p style="text-align: center;"><b>Classic</b> K-3429, K-3452 Tank: K-4454</p> <p style="text-align: center;"><b>Stately</b> K-3439, K-3462 Tank: K-4464</p>	Discontinued	85086* 
Pinoir® 	K-3465, K-3482, K-3483, K-3485 Tank: K-4609	Discontinued	85085* LH    1007913* RH 
Portrait® Lite 	K-3591, K-3490, K-3491 Tank: K-4590, K-4807  Artist Editions®: K-14178 Tank: K-14179 K-14247 Tank: K-14249	80625* 	85086* 
Revival® 	K-3555 Tank: K-3613  K-3455 Tank: K-4445  Artist Editions: K-14239 Tank: K-14241	83834* 	83725* 
Serif® 	K-3444, K-3461, K-3464, K-3468 Tank: K-4608	Discontinued	83725* 
Vintage® 	K-3410 Tank: K-4515  <hr style="border-top: 1px dashed black;"/> K-3411, K-3412 Tank: K-4516	Discontinued	Discontinued

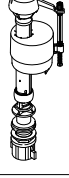
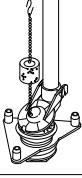
2-Inch Flapper Two-Piece Toilets

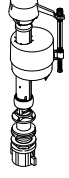
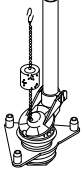
## 2-Inch Flapper Two-Piece Toilets KOHLER® Genuine Parts

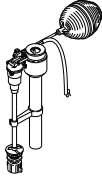
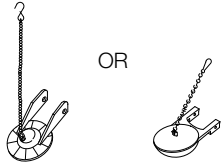
Float/Fill Valve	Flush Valve	Tank Gasket	Flush Ball/Flapper
GP1138930 	1022551 	GP51487 	GP85160 
GP1138930 	1042831 	GP51487 	GP85160 
GP1138930 	1015139 	GP51487 	GP87449 
GP1138930 	87373 (1.6 GPF) 	GP51487 	GP85160 
GP1138930 	85159 	GP51487 	GP85160 
GP1138930 	1004808 	GP51487 	GP85160 
76171 	Discontinued	Discontinued	GP87449      GP49114 ? OR 











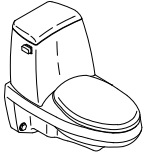
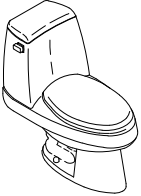

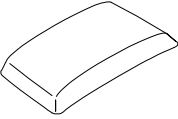
2-Inch Flapper  
Two-Piece Toilets

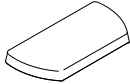
Note: Part numbers that have a "GP" prefix refer to a blister package.  
For example, GP1059291 is the same part as previous part number 1059291 but in a blister package.

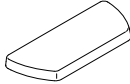
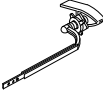
## 2-Inch Flapper Two-Piece Toilets



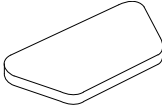







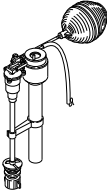

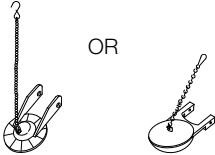
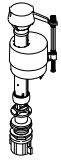

### Toilet

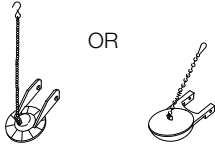
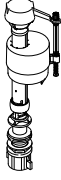
### Toilet Details

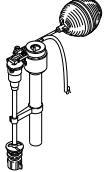
Product Name	Model Number	Tank Cover	Trip Lever
Wellesley Water-Guard® 	K-3441 Tank: K-4209	Discontinued	Various trip levers; visit <a href="http://KOHLER.com/ServiceParts">KOHLER.com/ServiceParts</a> .
Wellington  	K-3446 Tank: K-4646 Artist Editions®: K-14210 Tank: K-14212	83584* 	Various trip levers; visit <a href="http://KOHLER.com/ServiceParts">KOHLER.com/ServiceParts</a> .
	K-3415 Tank: K-4504 Artist Editions: K-14133 Tank: K-14137 K-14143 Tank: K-14147 K-14076 Tank: K-14078	Discontinued	Various trip levers; visit <a href="http://KOHLER.com/ServiceParts">KOHLER.com/ServiceParts</a> .
Wellworth®, Highline® 	K-3433, K-3438 Tank: K-4621	84095* 	30324* 
	K-11450, K-11470, K-3422, K-3423, K-3432, K-3427, K-3481 Tank: K-4620	84591* 	87114* 
Highline Water-Guard 	K-3527 Tank: K-4518	Discontinued	87115* 
Wellworth 	K-3407, K-3420, K-3421, K-3428 Tank: K-4512 K-3414 Tank: K-4597	82869* (7 <sup>3</sup> / <sub>4</sub> " Discontinued 80625* (10") 	Various trip levers; visit <a href="http://KOHLER.com/ServiceParts">KOHLER.com/ServiceParts</a> .
Wellworth, Northline Water-Guard 	K-3520, K-3521 Tank: K-4519	Discontinued	Various trip levers; visit <a href="http://KOHLER.com/ServiceParts">KOHLER.com/ServiceParts</a> .

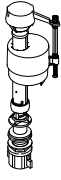
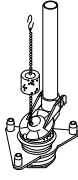
2-Inch Flapper  
Two-Piece Toilets

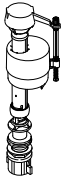
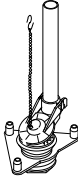
## 2-Inch Flapper Two-Piece Toilets KOHLER® Genuine Parts

Float/Fill Valve	Flush Valve	Tank Gasket	Flush Ball/Flapper
<p>30652</p> 	<p>Discontinued</p>	<p>GP51487</p> 	<p>GP87449    GP49114</p> <p>OR</p> 
<p>GP1138930</p> 	<p>Discontinued</p>	<p>GP51487</p> 	<p>GP87449</p> 
<p>30652</p> 	<p>Discontinued</p>	<p>GP51487</p> 	<p>GP87449    GP49114</p> <p>OR</p> 
<p>GP1138930</p> 	<p>Discontinued</p>	<p>GP51487</p> 	<p>GP85160</p> 
<p>30671</p> 	<p>Discontinued</p>	<p>GP51487</p> 	<p>GP49114</p> 
<p>GP1138930</p> 	<p>1003068</p> 	<p>GP51487</p> 	<p>GP85160</p> 
<p>GP1138930</p> 	<p>85406</p> 	<p>GP51487</p> 	<p>GP87449</p> 

2-Inch Flapper  
Two-Piece Toilets

Note: Part numbers that have a "GP" prefix refer to a blister package.  
For example, GP1059291 is the same part as previous part number 1059291 but in a blister package.

## 2-Inch Flapper Two-Piece Toilets

### Toilet



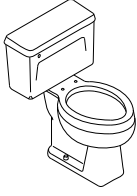
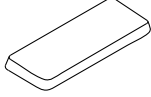
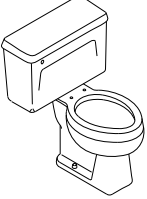
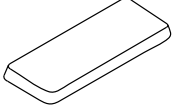



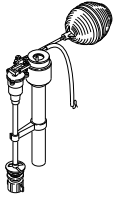

### Toilet Details

Product Name	Model Number	Tank Cover	Trip Lever
Wellworth®, Highline®, Tylon, Barlow 	K-3510, K-3512, K-3514 Tank: K-4524	81187* 	Various trip levers; visit <a href="http://KOHLER.com/ServiceParts">KOHLER.com/ServiceParts</a> .
Wellworth Water-Guard® 	K-3500, K-3502, K-3504 Tank: K-4509	81509* 	Various trip levers; visit <a href="http://KOHLER.com/ServiceParts">KOHLER.com/ServiceParts</a> .

**NOTES:**

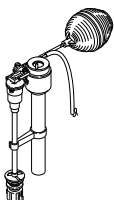

## 2-Inch Flapper Two-Piece Toilets KOHLER® Genuine Parts

Float/Fill Valve	Flush Valve	Tank Gasket	Flush Ball/Flapper
<p>30671</p> 	<p>N/A</p>	<p>51531</p>  <p>GP52050</p> 	<p>GP87449      GP49114</p> <p>OR</p>  
<p>30672</p> 	<p>N/A</p>	<p>51531</p>  <p>GP52050</p> 	<p>GP87449      GP49114</p> <p>OR</p>  







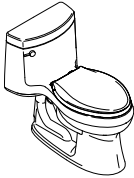
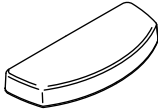
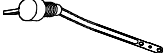

**NOTES:**

Note: Part numbers that have a “GP” prefix refer to a blister package.  
For example, GP1059291 is the same part as previous part number 1059291 but in a blister package.

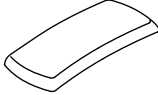
# 3/4-Inch Flapper One-Piece Toilets

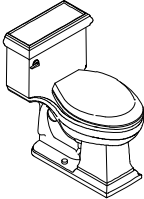
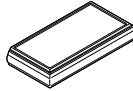
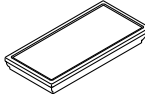
## Toilet

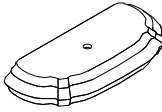





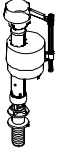
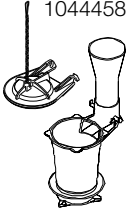

## Toilet Details

Product Name	Model Number	Tank Cover	Trip Lever
Cimarron® 	K-3489 K-3802 K-11889	1036367* 	1034693* LH  1036058* RH 
Gabrielle™ 	K-3513, K-3608 Artist Editions®: K-14343, K-14344, K-14345, K-14346	85407* 	1068627* LH  1080378* RH 
Memoirs® 	<b>Classic</b> K-3451 <b>Stately</b> K-3453	1220279* Classic  1220280* Stately 	1039863* 
Portrait® 	K-3506	89809* 	83725* 

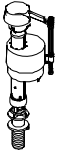
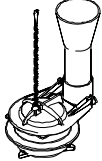
### NOTES:

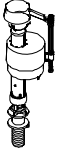
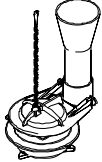
3/4-Inch Flapper  
One-Piece Toilets

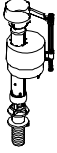
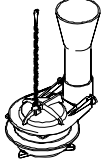
3/4-Inch Flapper One-Piece Toilets  
 KOHLER® Genuine Parts

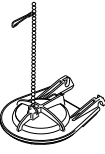
Float/Fill Valve	Flush Valve	Tank Gasket	Flush Ball/Flapper
GP1083167 	1044458 	GP83996 	GP1039444 
GP1083167 	1068622 	GP83996 	GP1067183 
GP1083167 	1039861 	GP83996 	GP1039444 
GP1083167 	1060862 	GP83996 	GP1060740 









**NOTES:**

Note: Part numbers that have a "GP" prefix refer to a blister package.  
 For example, GP1059291 is the same part as previous part number 1059291 but in a blister package.

# 3/4-Inch Flapper Two-Piece Toilets

## Toilet

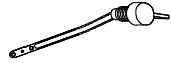
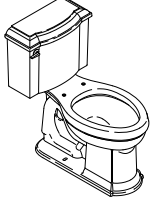
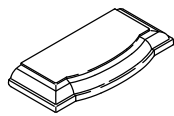
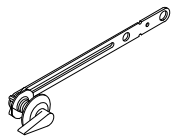
## Toilet Details

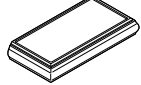
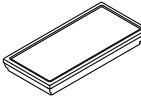
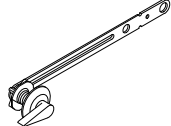
Product Name	Model Number	Tank Cover	Trip Lever
Bancroft® 	K-3487 Tank: K-4633	1033723* 	1042212* 
Cimarron 	<b>1.28 GPF</b> K-3496-HE Tank: K-4634-HE <b>1.6 GPF</b> K-3496, K-3497, K-3499, K-11465 Tank: K-4634	1015867* 	1034693* LH  1036058* RH 
Devonshire® 	K-3503 Tank: K-4708	1044820* 	85086* 
Memoirs® 	<b>Classic</b> K-3532, K-3542 Tank: K-4485 K-11461, K-3509, K-3515 Tank: K-4491 <b>Stately</b> K-11460, K-3511, K-3526 Tank: K-4492 K-3533, K-3548 Tank: K-4473	1052861* Classic  1052862* Stately 	85086* 

3/4-Inch Flapper  
Two-Piece Toilets

### NOTES:

# 3/4-Inch Flapper Two-Piece Toilets KOHLER® Genuine Parts

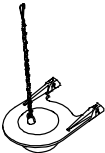



Float/Fill Valve	Flush Valve	Tank Gasket	Flush Ball/Flapper
<p>GP1083167</p> 	<p>1042499</p> 	<p>GP1018165-F    1024390</p> 	<p>GP1078441</p> 
<p>GP1083167</p> 	<p>1024385</p> 	<p>GP1018165-F    1024390</p> 	<p>GP1078441</p> 
<p>GP1083167</p> 	<p>1042499</p> 	<p>GP1018165-F    1024390</p> 	<p>GP1078441</p> 
<p>GP1083167</p> 	<p>1060218</p> 	<p>GP1018165-F    1024390</p> 	<p>GP1078441</p> 

**NOTES:**



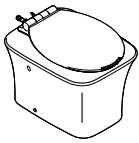
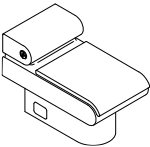
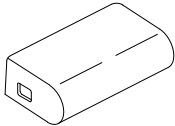
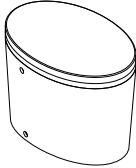

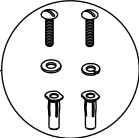
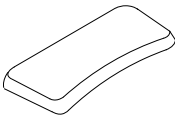
Note: Part numbers that have a "GP" prefix refer to a blister package.  
For example, GP1059291 is the same part as previous part number 1059291 but in a blister package.

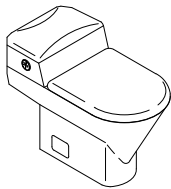
Toilet

Toilet Details

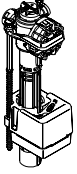
Product Name	Model Number	Tank Cover	Trip Lever
Fountainhead 	K-3524	N/A	N/A
Call Technical Support 800-4KOHLER			
Pillow Talk 	K-3379	83675* 	Various trip levers; visit <a href="http://KOHLER.com/ServiceParts">KOHLER.com/ServiceParts</a> .
Call Technical Support 800-4KOHLER			
Purist® Hatbox 	K-3492	N/A	N/A
Call Technical Support 800-4KOHLER			
San Raphael®   <p>84999 Seat Anchor Kit</p>	K-3607 K-3393 K-3398	1055954* 	81996* 
Call Technical Support 800-4KOHLER			
Trocadero 	K-3437	N/A	Various trip levers; visit <a href="http://KOHLER.com/ServiceParts">KOHLER.com/ServiceParts</a> .
Call Technical Support 800-4KOHLER			

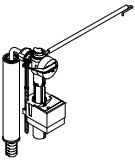
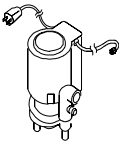
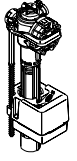
Power Lite® One-Piece Toilets  
 KOHLER® Genuine Parts

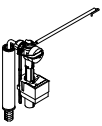
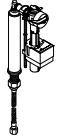
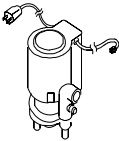
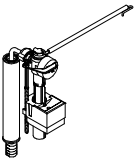
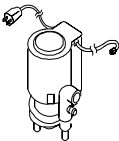
Float/Fill Valve	Flush Valve	Seat
1097551 	1044465 (Pump) 	1057635*
Call Technical Support 800-4KOHLER		
1007489 	84153 (Pump) 	74929*
Call Technical Support 800-4KOHLER		
1043213 	1044465 (Pump) 	1022679*
Call Technical Support 800-4KOHLER		
1007489 For Rigid Connection 	1068034 For Flex Connection 	84153 (Pump) 
Call Technical Support 800-4KOHLER		
1007489 	84153 (Pump) 	K-4612*
Call Technical Support 800-4KOHLER		

Power Lite®  
 One-Piece Toilets

# Intelligent Toilets

## Toilet

## Toilet Details

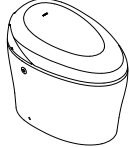
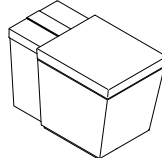
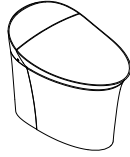
Product Name	Model Number	Tank Cover	Trip Lever
Karing® 	K-4026	N/A	1188925 (Remote Assembly)
	Call Technical Support 800-4KOHLER		
Numi® 	K-3900	N/A	1183987* (User Interface)
	K-3901	N/A	K-7420* (User Interface)
Call Technical Support 800-4KOHLER			
Veil® 	K-5401	N/A	1235953 (Remote Assembly)
	Call Technical Support 800-4KOHLER		

### NOTES:













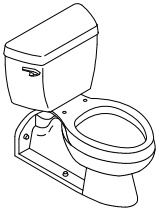
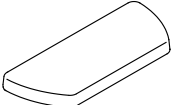

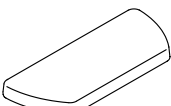

Intelligent Toilets  
 KOHLER® Genuine Parts

Float/Fill Valve	Flush Valve	Seat
N/A	N/A	N/A
Call Technical Support 800-4KOHLER		
N/A	N/A	1183995*
N/A	N/A	1214139*
Call Technical Support 800-4KOHLER		
N/A	N/A	K-6299
Call Technical Support 800-4KOHLER		

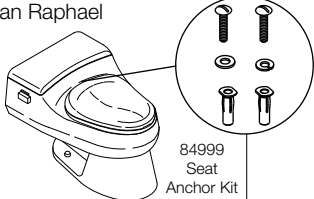
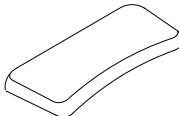
**NOTES:**

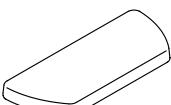
# Pressure Lite® One- and Two-Piece Toilets

## Toilet Details

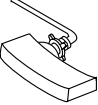
Product Name	Model Number	Tank Cover	Trip Lever
Barrington™ 	K-3652 Tank: K-4484	1036375* 	1045276* LH  1045277* RH 
Call Technical Support 800-4KOHLER			
Highline® 	K-3493, K-3554 Tank: K-4645 K-3519, K-3531 Tank: K-4484	1036375* 	1045276* LH  1045277* RH 
Call Technical Support 800-4KOHLER			
Rialto® 	K-3404	Discontinued	Discontinued
Call Technical Support 800-4KOHLER			
San Raphael® 	K-3394	Discontinued	Discontinued
Call Technical Support 800-4KOHLER			
San Raphael  <p>84999 Seat Anchor Kit</p>	K-3393 K-3597 K-3607	1055954* 	1089001* 
Call Technical Support 800-4KOHLER			
Wellworth® 	K-3505 Tank: K-4645	1036375* 	1045276* LH  1045277* RH 
Call Technical Support 800-4KOHLER			
Wellworth, Highline, Barrington 	K-3458, K-3544, K-3546 Tank: K-4470	Discontinued	84874* 
Call Technical Support 800-4KOHLER			

**Pressure Lite® One- and Two-Piece Toilets**  
**KOHLER® Genuine Parts**

Float/Fill Valve	Flush Valve	Seat	Flush Ball/Flapper	
N/A	N/A	84460 	GP52050 	N/A
Call Technical Support 800-4KOHLER				
N/A	N/A	GP51487 	N/A	
Call Technical Support 800-4KOHLER				
N/A	N/A	N/A	N/A	
Call Technical Support 800-4KOHLER				
N/A	N/A	N/A	N/A	
Call Technical Support 800-4KOHLER				
N/A	N/A	1104621 	N/A	
Call Technical Support 800-4KOHLER				
N/A	N/A	84460 	GP52050 	N/A
Call Technical Support 800-4KOHLER				
N/A	N/A	1037307 	GP52050 	N/A
Call Technical Support 800-4KOHLER				













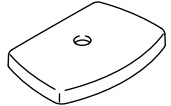
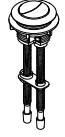

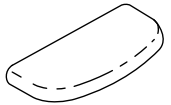
Pressure Lite®  
One- and Two-Piece Toilets

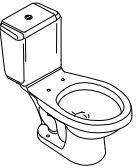
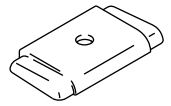
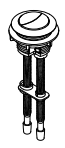
Note: Part numbers that have a "GP" prefix refer to a blister package.  
For example, GP1059291 is the same part as previous part number 1059291 but in a blister package.

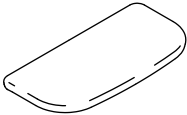
Toilet

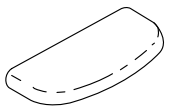









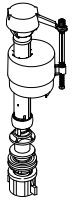

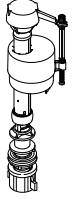
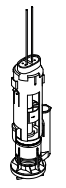



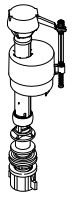
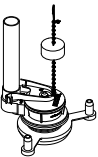

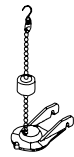
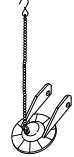
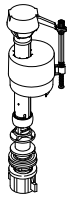
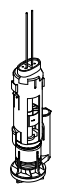

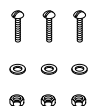
Toilet Details

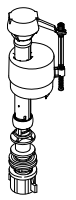
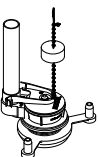
STERLING Toilets

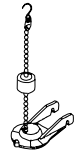
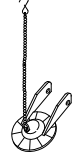
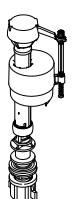
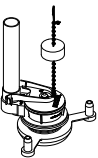
Product Name	Model Number	Tank Cover	Trip Lever																				
Cordova 	402020 402220 Tank: 404520	Discontinued	Discontinued																				
Karsten® 	402025 402087 402028 Tank: 402023	1040340* 	1266856* 																				
Riverton™ 	<table border="0"> <tr> <td><b>1.28 GPF</b></td> <td><b>1.6 GPF</b></td> </tr> <tr> <td>402083</td> <td>402502</td> </tr> <tr> <td>402084</td> <td>402522</td> </tr> <tr> <td>402085</td> <td>402532</td> </tr> <tr> <td>404701</td> <td></td> </tr> <tr> <td>Tank: 404552</td> <td>Tank: 404522</td> </tr> </table>	<b>1.28 GPF</b>	<b>1.6 GPF</b>	402083	402502	402084	402522	402085	402532	404701		Tank: 404552	Tank: 404522	1169890* (1.28 GPF) 84624* (1.6 GPF) 	84625-CP (Chrome) 1166878-0 (White) 85086-VF (Brass) 								
<b>1.28 GPF</b>	<b>1.6 GPF</b>																						
402083	402502																						
402084	402522																						
402085	402532																						
404701																							
Tank: 404552	Tank: 404522																						
Rockton® 	402024 402027 402088 Tank: 402022	1045794* 	1266856* 																				
Stinson® 	<table border="0"> <tr> <td><b>1.28 GPF</b></td> <td><b>1.6 GPF</b></td> </tr> <tr> <td>402076</td> <td>402075</td> </tr> <tr> <td>402077</td> <td>402375</td> </tr> <tr> <td>404702</td> <td>Tank: 402071</td> </tr> <tr> <td>404704</td> <td></td> </tr> <tr> <td>Tank: 402091</td> <td></td> </tr> </table>	<b>1.28 GPF</b>	<b>1.6 GPF</b>	402076	402075	402077	402375	404702	Tank: 402071	404704		Tank: 402091		1068490* 	1185068* 								
<b>1.28 GPF</b>	<b>1.6 GPF</b>																						
402076	402075																						
402077	402375																						
404702	Tank: 402071																						
404704																							
Tank: 402091																							
Windham™ 	<table border="0"> <tr> <td><b>1.28 GPF</b></td> <td><b>1.6 GPF</b></td> </tr> <tr> <td>402080</td> <td>402015</td> </tr> <tr> <td>402081</td> <td>402215</td> </tr> <tr> <td>402082</td> <td>402315</td> </tr> <tr> <td>404700</td> <td>Tank: 404515</td> </tr> <tr> <td>Tank: 404555</td> <td></td> </tr> <tr> <td>402078</td> <td>402014</td> </tr> <tr> <td>402079</td> <td>402214</td> </tr> <tr> <td>Tank: 404544</td> <td>402315</td> </tr> <tr> <td></td> <td>Tank: 404514</td> </tr> </table>	<b>1.28 GPF</b>	<b>1.6 GPF</b>	402080	402015	402081	402215	402082	402315	404700	Tank: 404515	Tank: 404555		402078	402014	402079	402214	Tank: 404544	402315		Tank: 404514	84537* 	84625-CP (Chrome) 1166878-0 (White) 85086-VF (Brass) 
<b>1.28 GPF</b>	<b>1.6 GPF</b>																						
402080	402015																						
402081	402215																						
402082	402315																						
404700	Tank: 404515																						
Tank: 404555																							
402078	402014																						
402079	402214																						
Tank: 404544	402315																						
	Tank: 404514																						
Windham 	<table border="0"> <tr> <td><b>1.28 GPF</b></td> <td><b>1.6 GPF</b></td> </tr> <tr> <td>403080</td> <td>402211</td> </tr> <tr> <td>403081</td> <td>402212</td> </tr> <tr> <td>403082</td> <td>402213</td> </tr> <tr> <td>404705</td> <td>Tank: 402093</td> </tr> <tr> <td>Tank: 404551</td> <td></td> </tr> </table>	<b>1.28 GPF</b>	<b>1.6 GPF</b>	403080	402211	403081	402212	403082	402213	404705	Tank: 402093	Tank: 404551		1203861* 	84625-CP (Chrome) 1166878-0 (White) 85086-VF (Brass) 								
<b>1.28 GPF</b>	<b>1.6 GPF</b>																						
403080	402211																						
403081	402212																						
403082	402213																						
404705	Tank: 402093																						
Tank: 404551																							

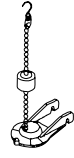
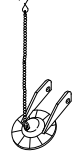
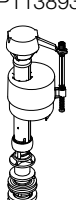
STERLING® Toilets  
KOHLER® Genuine Parts

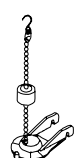
STERLING Toilets

Float/Fill Valve	Flush Valve	Tank Gasket	Flush Ball/Flapper
GP1138930 	N/A	GP51487 	GP87449 1.6 GPF 
GP1138930 	1072320 	1032265  30419 	1131496 
GP1138930 	1110262 (1.28 GPF) 84910 (1.6 GPF) 	GP51487 	GP1105825 1.28 GPF  OR GP87449 1.6 GPF 
GP1138930 	1072320 	1032265  30419 	1131496 
GP1138930 	1110262 (1.28 GPF) 84910 (1.6 GPF) 	GP51487 	GP1105825 1.28 GPF  OR GP87449 1.6 GPF 
GP1138930 	1110262 (1.28 GPF) 85073 (1.6 GPF) 	GP51487 	GP1105825 1.28 GPF  OR GP87449 1.6 GPF 
GP1138930 	1212845 (1.28 GPF) 1284420 (1.6 GPF) 	GP51487 	GP1105825 1.28 GPF  OR GP87449 1.6 GPF 

Note: Part numbers that have a "GP" prefix refer to a blister package.  
For example, GP1059291 is the same part as previous part number 1059291 but in a blister package.





[KOHLER.com/ServiceParts](http://KOHLER.com/ServiceParts)

GENUINE PARTS  
**STERLING**  
A KOHLER COMPANY

**KOHLER**  
GENUINE PARTS

Form 10-1099-1017  
© 2017 by Kohler Co.  
Kohler, Wisconsin 53044  
Printed in U.S.A.  
1-800-4-KOHLER  
(1-800-456-4537)