

WARNINGS AND APPLICATION INSTRUCTIONS FOR HOIST HOOKS

The Crosby Group, Inc.

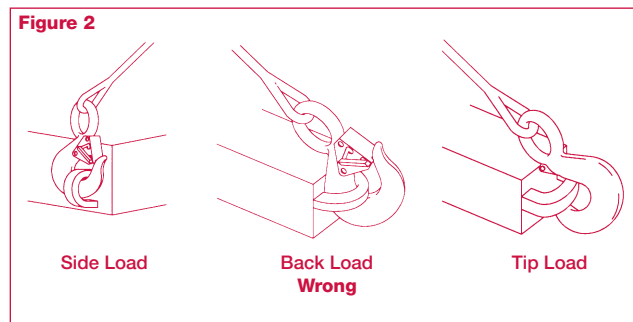
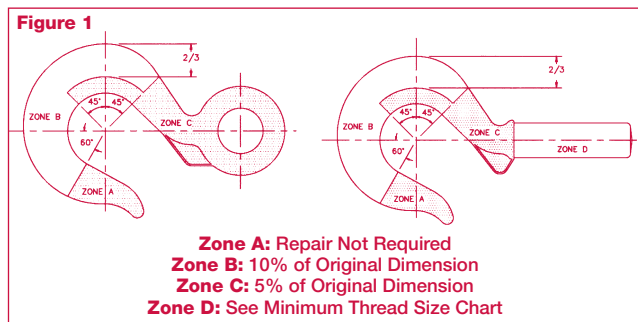

Important Safety Information — Read and Follow

- A visual periodic inspection for cracks, nicks, wear, gouges and deformation as part of a comprehensive documented inspection program, should be conducted by trained personnel in compliance with the schedule in ANSI B30. 10.
- For hooks used in frequent load cycles or pulsating loads, the hook and threads should be periodically inspected by Magnetic Particle or Dye Penetrant. (Note: Some disassembly may be required.)
- Never use a hook whose throat opening has been increased, or whose tip has been bent more than 10 degrees out of plane from the hook body, or is in any other way distorted or bent. Note: A latch will not work properly on a hook with a bent or worn tip.
- Never use a hook that is worn beyond the limits shown in Figure 1.
- Remove from service any hook with a crack, nick, or gouge. Hooks with a crack, nick, or gouge shall be repaired by grinding lengthwise, following the contour of the hook, provided that the reduced dimension is within the limits shown in Figure 1.
- Never repair, alter, rework, or reshape a hook by welding, heating, burning, or bending.
- Never side load, back load, or tip load a hook. (See Figure 2.)
- Eye hooks, shank hooks and swivel hooks are designed to be used with wire rope or chain. Efficiency of assembly may be reduced when used with synthetic material.
- Do not swivel the S-322 swivel hook while it is supporting a load.
- The use of a latch may be mandatory by regulations or safety codes; e.g., OSHA, MSHA, ANSI/ASME

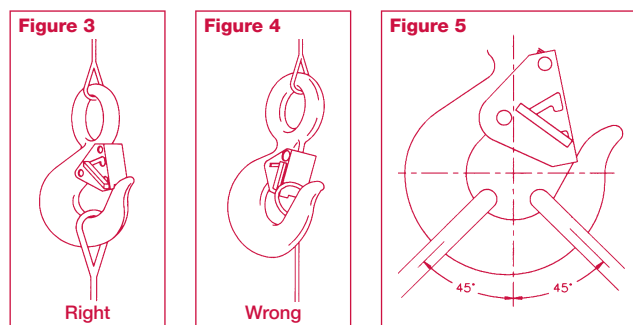

B30, Insurance, etc. (Note: When using latches, see instructions in “Understanding: The Crosby Group Warnings” for further information.)

- Always make sure the hook supports the load. (See Figure 3). The latch must never support the load (See Figure 4).
- When placing two (2) sling legs in hook, make sure the angle from the vertical to the outermost leg is not greater than 45 degrees, and the included angle between the legs does not exceed 90 degrees* (See Figure 5).
- See ANSI/ASME B30.10 “Hooks” for additional information.

* For angles greater than 90 degrees, or more than (2) legs, a master link or bolt type anchor shackle should be used to attach the legs of the sling to the hook.

WARNING:

- Loads may disengage from hook if proper procedures are not followed.
- A falling load may cause serious injury or death.
- See OSHA Rule 1926.550(g) for personnel hoisting by cranes or derricks. A Crosby 319, 320, or 322 hook with a PL Latch attached (when secured with bolt, nut and pin) may be used for lifting personnel. A Crosby S-320N Hook with a S-4320 Latch attached (when secured with cotter pin or bolt, nut and pin) may be used for lifting personnel.
- Threads may corrode and/or strip and drop the load.
- Hook must always support the load. The load must never be supported by the latch.
- Never apply more force than the hook’s assigned Working Load Limit (WLL) rating.
- Read and understand these instructions before using hook.

HOIST HOOKS

The Crosby Group, Inc.

Basic Machining & Thread Information

- Wrong thread and/or shank size can cause stripping and loss of load.
- The maximum diameter is the largest diameter, after cleanup, that could be expected after allowing for straightness, pits, etc.
- All threads must be Class 2 or better.
- The minimum thread length engaged in the nut should not be less than (1) thread diameter.
- Hook shanks are not intended to be swaged on wire rope or rod.
- Hook shanks are not intended to be drilled and internally threaded.
- Crosby cannot assume responsibility for, (A) the quality of machining, (B) the type of application, or (C) the means of attachment to the power source or load.
- Consult the Crosby Hook Identification & Working Load Limit Chart (See below) for the minimum thread size for assigned Working Load Limits (WLL).†
- Remove from service any Hook which has threads corroded more than 20% of the nut engaged length.

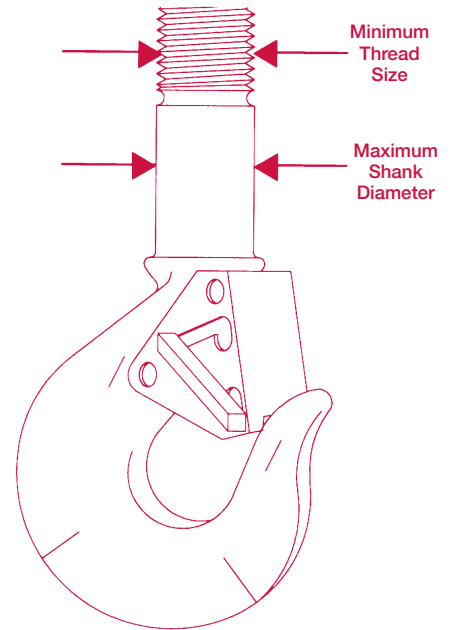

Crosby Hook Identification & Working Load Limit Chart†

Hook Identification			Working Load Limit (tons)			Maximum Shank Diameter after Machining (in.)	Minimum Thread Size	
319-C 320-CN 320-C 322-C	319-A 320-AN 320-A 322-A	319-B	319-C 320-CN 320-C 322-C	319-A 320-AN 320-A 322-A	319-B		319-C (Carbon)	319-A (Alloy) 319-B (Bronze)
DC	DA	DB	.75	1	.5	.53	1/2-13 unc	1/2-13 unc
FC	FA	FB	1	1.5	.6	.62	5/8-11 unc	5/8-11 unc
GC	GA	GB	1.5	2	1	.66	5/8-11 unc	5/8-11 unc
HC	HA	HB	2	3	1.4	.81	3/4-10 unc	3/4-10 unc
IC	IA	IB	3	*4.5/5	2.0	1.03	7/8-9 unc	7/8-9 unc
JC	JA	JB	5	7	3.5	1.27	1 1/8-7 unc	1 1/8-7 unc
KC	KA	KB	7.5	11	5.0	1.52	1 1/4-7 unc	1 3/8-6 unc
LC	LA	LB	10	15	6.5	1.75	1 5/8-8 un	1 5/8-8 un
NC	NA	NB	15	22	10	2.00	2-8 un	2-8 un
OC	OA	OB	20	30	13	2.50	2 1/4-8 un	2 1/4-8 un
PC	PA	—	25	37	—	3.50	2 3/4-8 un	2 3/4-8 un
SC	SA	—	30	45	—	3.50	3-8 un	3-8 un
TC	TA	—	40	60	—	4.00	3 1/4-8 un	3 1/2-8 un
UC	UA	—	50	75	—	4.50	3 3/4-8 un	4-4 unc
—	WA	—	—	100	—	6.12	—	4 1/2-8 un
—	XA	—	—	150	—	6.38	—	5 1/2-8 un
—	YA	—	—	200	—	7.00	—	6 1/4-8 un
—	ZA	—	—	300	—	8.62	—	7 1/2-8 un

* 320-AN is rated at 5 tons

† Working Load Limit—The maximum mass or force which the product is authorized to support in general service when the pull is applied in-line, unless noted otherwise, with respect to the centerline of the product. The term is used interchangeably with the following terms:

1. WLL 2. Rated Load Value 3. SWL 4. Safe Working Load 5. Resultant Safe Working Load.

HOIST HOOKS

The Crosby Group, Inc.

Shank Hooks

Patented trademark indicates QUIC-CHECK™ product.

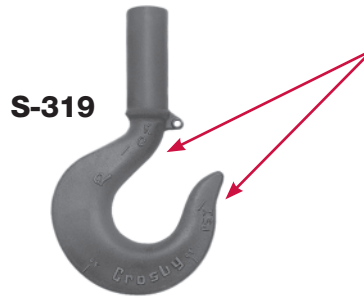

Hoist hooks incorporate markings forged into the product which address two (2) QUIC-CHECK™ features:

Deformation Indicators — Two strategically placed marks, one just below the shank or eye and the other on the hook tip, which allows for a QUIC-CHECK™ measurement to determine if the throat opening has changed, thus indicating abuse or overload.

To check, use a measuring device (i.e., tape measure) to measure the distance between the marks. The marks should align to either an inch or half-inch increment on the measuring device. If the measurement does not meet this criteria, the hook should be inspected further for possible damage.

Angle Indicators — Indicates the maximum included angle which is allowed between two (2) sling legs in the hook. These indicators also provide the opportunity to approximate other included angles between two sling legs.



Working Load Limit* (tons)			Hook Identification Code			Shank Hooks Stock No.					Shank** Length Type	Weight Each (lbs.)	
Carbon	Alloy	Bronze	319-C 319CN 320-C 320-CN 322-C	319-A 319AN 320-A 320AN 322-A	319-BN	CERTEX Cat. Ref. No.	Crosby Carbon S-319-C S-319CN S.C.	CERTEX Cat. Ref. No.	Crosby Alloy S-319-A S-319AN S.C.	CERTEX Cat. Ref. No.			Crosby Bronze S-319-B S.C.
3/4	1	.5	DC	DA	DB	CX05-0001	†1028505	CX05-0020	†1028701	CX05-0044	†1028900	Std.	.50
1	1-1/2	.6	FC	FA	FB	CX05-0002	†1028514	CX05-0021	†1028710	CX05-0045	†1028909	Std.	.75
1-1/2	2	1	GC	GA	GB	CX05-0003	†1028523	CX05-0022	†1028723	CX05-0046	†1028918	Std.	1.00
2	3	1.4	HC	HA	HB	CX05-0004	†1028532	CX05-0023	†1028732	CX05-0047	†1028927	Std.	1.82
3	5	2	IC	IA	IB	CX05-0005	†1028541	CX05-0024	†1028741	CX05-0048	†1028936	Std.	3.69
5	7	3-1/2	JC	JA	JB	CX05-0006	†1028550	CX05-0025	†1028750	CX05-0049	†1028945	Std.	7.25
7-1/2	11	5	KC	KA	KB	CX05-0007	†1028563	CX05-0026	†1028765	CX05-0050	†1028954	Std.	13.49
10	15	6-1/2	LC	LA	LB	CX05-0008	†1028572	CX05-0027	†1028774	CX05-0051	†1028963	Std.	18.00
15	22	10	NC	NA	NB	CX05-0009	†1028581	CX05-0028	†1028783	CX05-0052	†1028972	Std.	35.33
20	30	—	OC	OA	—	CX05-0010	1024386	CX05-0029	1024803	—	—	Std.	72.00
20	30	—	OC	OA	—	CX05-0011	1024402	CX05-0030	1024821	—	—	Long	85.50
25	37	—	PC	PA	—	CX05-0012	1024420	CX05-0031	1024849	—	—	Std.	134.00
25	37	—	PC	PA	—	CX05-0013	1024448	CX05-0032	1024867	—	—	Long	172.00
30	45	—	SC	SA	—	CX05-0014	1024466	CX05-0033	1024885	—	—	Std.	182.00
30	45	—	SC	SA	—	CX05-0015	1024484	CX05-0034	1024901	—	—	Long	214.00
40	60	—	TC	TA	—	CX05-0016	1024509	CX05-0035	1024929	—	—	Std.	268.00
40	60	—	TC	TA	—	CX05-0017	1024545	CX05-0036	1024965	—	—	Long	312.00
50	75	—	UC	UA	—	CX05-0018	1024563	CX05-0037	1024983	—	—	Std.	390.00
50	75	—	UC	UA	—	CX05-0019	1024581	CX05-0038	1025009	—	—	Long	426.00
—	100	—	—	WA	—	—	—	CX05-0039	1025027	—	—	Std.	610.00
—	100	—	—	WA	—	—	—	CX05-0040	1025045	—	—	Long	675.00
—	150	—	—	XA	—	—	—	CX05-0041	1025063	—	—	Std.	735.00
—	200	—	—	YA	—	—	—	CX05-0042	1025081	—	—	Std.	1020.00
—	300	—	—	ZA	—	—	—	CX05-0043	1025090	—	—	Std.	1390.00

** See column "Y" on next page for actual length. † New 319N Style Hook.

Hook I.D. Codes: A—Alloy Steel, B—Bronze High Strength, C—Carbon Steel.

* NOTE: Proof load is 2 times Working Load Limit. All carbon hooks—average straightening load (ultimate load) is 5 times Working Load Limit. Alloy eye hooks 1 ton through 22 ton—average straightening load (ultimate load) is 5 times Working Load Limit. Alloy eye hooks 30 tons through 60 tons—average straightening load (ultimate load) is 4.5 times Working Load Limit. Alloy Shank Hooks 1 ton thru 22 ton—average straightening load (ultimate load) is 5 times the Working Load Limit. Alloy Shank hooks 30 ton through 300 ton ultimate load is 4.5 times the Working Load Limit. All Bronze hooks—average straightening load (ultimate load) is 4 times Working Load Limit.

SEE APPLICATION AND WARNING INFORMATION

HOIST HOOKS

The Crosby Group, Inc.

Shank Hooks

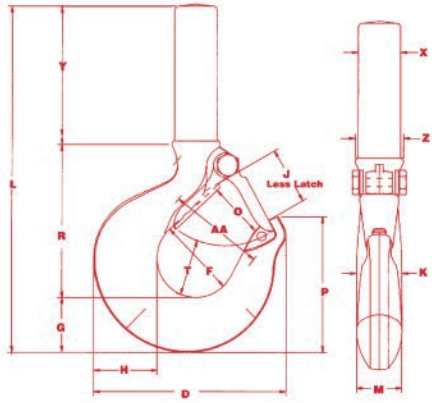

- The most complete line of shank hoist hooks. Available 3/4 to 300 tons.
- Available in carbon steel, alloy steel, and bronze.
- Quenched and Tempered.
- Proper design, careful forging, and precision controlled quench and tempering give maximum strength without excessive weight and bulk.
- Every Crosby Shank Hook has a pre-drilled cam which can be equipped with a latch. Simply purchase the latch assemblies listed and shown on following pages. Even years after purchase of the original hook, latch assemblies can be added.
- Load Rating code stamped on each hook.

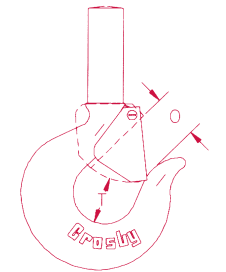
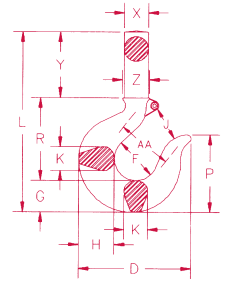

Shank Hook dimension with PL Latch Assembled



Dimensions (inches)																
Hook I.D. Code	D	F	G	H	J	K	L	M	O	P	R	T	X††	Y	Z	Deformation Indicator AA
D	2.86	1.25	.73	.81	.93	.63	5.14	.63	† .93	1.96	2.35	.97	.59	2.06	.69	1.50
F	3.16	1.38	.84	.94	.97	.71	5.68	.71	† .97	2.22	2.59	.97	.66	2.25	.78	2.00
G	3.59	1.50	1.00	1.16	1.06	.88	6.35	.88	† 1.06	2.44	2.76	1.03	.72	2.59	.88	2.00
H	4.00	1.62	1.14	1.31	1.19	.94	7.14	.94	† 1.16	2.78	3.16	1.16	.88	2.84	1.00	2.00
I	4.84	2.00	1.44	1.63	1.50	1.31	8.63	1.13	† 1.41	3.47	3.85	1.53	1.16	3.34	1.25	2.50
J	6.28	2.50	1.82	2.06	1.78	1.66	10.43	1.44	† 1.69	4.59	4.77	1.94	1.41	3.84	1.56	3.00
K	7.54	3.00	2.26	2.63	2.41	1.88	12.52	1.63	† 2.22	5.25	5.88	2.46	1.81	4.38	1.94	4.00
L	8.34	3.25	2.60	2.94	2.62	2.19	13.47	1.94	† 2.41	5.96	6.37	2.59	2.00	4.50	2.19	4.00
N	10.34	4.25	3.01	3.50	3.41	2.69	16.65	2.38	† 3.19	6.88	8.14	2.81	2.56	5.50	2.63	5.00
O	13.62	5.00	3.62	4.62	4.00	3.00	23.09	—	3.25	8.78	9.44	3.44	3.12	10.00	3.12	6.50
O	13.62	5.00	3.62	4.62	4.00	3.00	31.09	—	3.25	8.78	9.44	3.44	3.12	18.00	3.12	6.50
P	14.06	5.38	4.56	5.00	4.25	3.62	32.12	—	3.00	11.38	12.56	3.88	4.00	15.00	4.00	7.00
P	14.06	5.38	4.56	5.00	4.25	3.62	41.12	—	3.00	11.38	12.56	3.88	4.00	24.00	4.00	7.00
S	15.44	6.00	5.06	5.50	4.75	3.72	34.12	—	3.38	12.63	14.00	4.75	4.00	15.00	4.00	8.00
S	15.44	6.00	5.06	5.50	4.75	3.72	43.12	—	3.38	12.63	14.00	4.75	4.00	24.00	4.00	8.00
T	18.50	7.00	6.00	6.50	5.75	4.44	36.06	—	4.12	14.81	15.50	5.69	4.50	14.50	4.50	10.00
T	18.50	7.00	6.00	6.50	5.75	4.44	47.56	—	4.12	14.81	15.50	5.69	4.50	26.00	4.50	10.00
U	20.62	7.75	6.69	7.25	6.50	4.81	41.16	—	5.38	16.53	19.38	6.00	5.00	15.00	5.00	11.50
U	20.62	7.75	6.69	7.25	6.50	4.81	49.16	—	5.38	16.53	19.38	6.00	5.00	23.00	5.00	11.50
W	23.00	6.81	8.59	9.88	5.88	5.50	42.12	—	4.50	17.38	18.41	7.00	7.00	15.00	7.00	12.00
W	23.00	6.81	8.59	9.88	5.88	5.50	48.12	—	4.50	17.38	18.41	7.00	7.00	21.00	7.00	12.00
X	24.38	6.75	9.12	10.94	6.00	6.00	45.75	—	4.50	18.00	18.38	7.00	7.25	18.00	7.25	13.00
Y	26.69	7.50	9.75	11.81	6.60	7.00	50.50	—	5.00	19.25	20.50	8.00	8.00	20.00	8.00	13.00
Z	30.12	9.50	10.62	12.94	8.00	7.25	54.69	—	6.25	22.69	23.50	8.25	9.50	20.00	9.50	15.00

† Dimensions shown are for S-4320 Latch kits. Dimensions for sizes 20 ton carbon and larger are for PL Latch Kits.

†† Dimension before machining (as forged).

* NOTE: Proof load is 2 times Working Load Limit. All carbon hooks—average straightening load (ultimate load) is 5 times Working Load Limit. Alloy eye hooks 1 ton through 22 ton—average straightening load (ultimate load) is 5 times Working Load Limit. Alloy eye hooks 30 tons through 60 tons—average straightening load (ultimate load) is 4.5 times Working Load Limit. Alloy Shank Hooks 1 ton thru 22 ton—average straightening load (ultimate load) is 5 times the Working Load Limit. Alloy Shank hooks 30 ton through 300 ton ultimate load is 4.5 times the Working Load Limit. All Bronze hooks—average straightening load (ultimate load) is 4 times Working Load Limit.

SEE APPLICATION AND WARNING INFORMATION

HOIST HOOKS

The Crosby Group, Inc.

Eye Hooks

All Crosby 320 Eye Hoist Hooks incorporate the following features:

- The most complete line of Eye hoist hooks.
- Available in carbon steel and alloy steel.
- Designed with a 5:1 Design Factor for (Carbon Steel); 4.5:1 Design Factor for 30t - 60t (Alloy Steel).
- Eye hooks are load rated.
- Proper design, careful forging and precision controlled quenched and tempering give maximum strength without excessive weight and bulk.
- Every Crosby Eye Hook has a pre-drilled cam which can be equipped with a latch. Even years after purchase of the original hook, latch assemblies can be added. (See pages 116, 118, & 120)
- Chemical analysis and tensile tests performed on each PIC to verify chemistry and mechanical properties.
- Type Approval certification in accordance with ABS 2007 Steel Vessel Rules 1-11-17.7 and ABS Guide for Certification on Cranes available. Certificates available when requested at time of order and may include additional charges.
- Hoist hooks incorporate two types of strategically placed markings forged into the product which address two (2) **QUIC-CHECK®** features:
 - Deformation Indicators and Angle Indicators (see following page for detailed definition).



**S-320
EYE HOOK**



**S-320N
EYE HOOK**

The following additional features have been incorporated in the new Crosby S-320N Eye Hoist Hooks. (Sizes 3/4 metric ton Carbon through 22 metric ton Alloy.)

- Metric Rated at 5:1 Design Factor for (Carbon Steel); 5:1 Design Factor for 1t - 22t (Alloy Steel).
- Can be proof tested to 2 times the Working Load Limit.
- Low profile hook tip.
- New integrated latch (S-4320) meets the world-class standard for lifting.
 - Heavy duty stamped latch interlocks with the hook tip.
 - High cycle, long life spring.
 - When secured with proper cotter pin through the hole in the tip of hook, meets the intent of OSHA Rule 1926.1431(g) and 1926.1501(g) for personnel hoisting.



Working Load Limit (t)		Hook ID Code	Eye Hook Stock No.					Weight Each (lbs.)	Replacement Latch Kits		
Carbon	Alloy		Carbon S-320C S.C.	Carbon L-320C L-320CN S.C.	Carbon G-320CN Galv.	Alloy S-320A S-320AN S.C.	Alloy L-320A L-320AN S.C.		S-4320 Stock No.	PL Stock No.	SS-4055 Stock No.
3/4	1	†D	1022200	1022205	1022208	1022375	1022380	.61	1096325	-	-
1	1-1/2	†F	1022211	1022216	1022219	1022386	1022391	.89	1096374	-	-
1-1/2	2	†G	1022222	1022227	1022230	1022397	1022402	1.44	1096421	-	-
2	3	†H	1022233	1022238	1022241	1022406	1022413	2.07	1096468	-	-
3	5	†I	1022244	1022246	1022249	1022419	1022424	4.30	1096515	1092000	-
5	7	†J	1022255	1022260	1022262	1022430	1022435	8.30	1096562	1092001	-
7-1/2	11	†K	1022264	1022271	1022274	1022441	1022446	15.00	1096609	1092002	-
10	15	†L	1022277	1022282	1022285	1022452	1022457	20.77	1096657	1092003	-
15	22	†N	1022288	1022293	1022296	1022465	1022468	39.50	1096704	1092004	-
20	30	O	1023289	1022302	-	1023546	1022479	60.00	-	1093716	1090161
25	37	P	1023305	-	-	1023564	-	105.00	-	1093717	1090189
30	45	S	1023323	-	-	1023582	-	148.00	-	1093718	1090189
40	60	T	1023341	-	-	1023608	-	228.00	-	1093719	1090205

*Eye Hooks (3/4 TC - 22TA), Proof load is 2 times Working Load Limit. Eye Hooks (20 TC - 60TA). All carbon hooks-average straightening load (ultimate load) is 5 times Working Load Limit. Alloy eye hooks 1 ton through 22 ton-average straightening load (ultimate load) is 5 times Working Load Limit. Alloy eye hooks 30 tons through 60 tons-average straightening load (ultimate load) is 4.5 times Working Load Limit. † New 320N style hook.

SEE APPLICATION AND WARNING INFORMATION

HOIST HOOKS

The Crosby Group, Inc.

Eye Hooks

Load Rated

Fatigue Rated

QUIC-CHECK®

TYPE APPROVED

QUENCHED & TEMPERED



**L-320
EYE HOOK**

- Hoist hooks incorporate markings forged into the product which address two (2) **QUIC-CHECK®** features.
 - **Deformation Indicators** — Two strategically placed marks, one just below the shank or eye and the other on the hook tip, which allows for a **QUIC-CHECK®** measurement to determine if the throat opening has changed, thus indicating abuse or overload. To check, use a measuring device (i.e. tape measure) to measure the distance between the marks. The marks should align to either an inch or half-inch increment on the measuring device. If the measurement does not meet this criteria, the hook should be inspected further for possible damage.
 - **Angle Indicators** — Indicates the maximum included angle which is allowed between two (2) sling legs in the hook. These indicators also provide the opportunity to approximate other included angles between two sling legs.

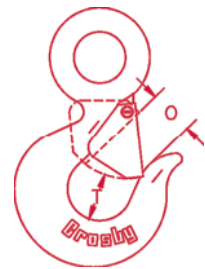
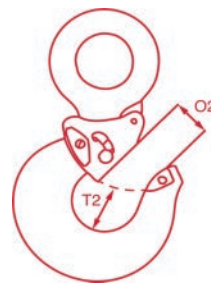
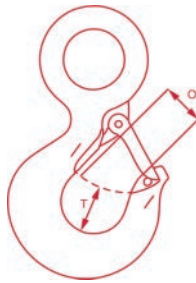
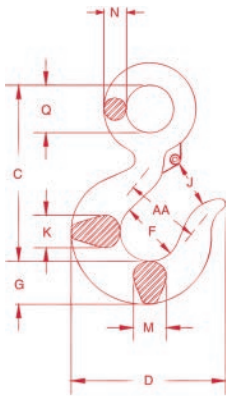

S-320 / S-320N Eye Hooks

Hook ID Code*	Dimensions (in.)													
	C	D	F	G	J	K	M	N	O †	O2 ††	Q	T †	T2 ††	AA**
D	3.34	2.83	1.25	.73	.90	.63	.63	.36	.89	-	.75	.87	-	1.50
F	3.81	3.11	1.38	.84	.93	.71	.71	.42	.91	-	.91	.98	-	2.00
G	4.14	3.53	1.50	1.00	1.00	.88	.88	.55	1.00	-	1.13	1.03	-	2.00
H	4.69	3.97	1.63	1.13	1.13	.94	.94	.58	1.09	-	1.25	1.16	-	2.00
I	5.77	4.81	2.00	1.44	1.47	1.31	1.31	.72	1.36	1.00	1.56	1.53	1.50	2.50
J	7.37	6.27	2.50	1.81	1.75	1.66	1.66	.90	1.61	1.31	2.00	1.96	1.88	3.00
K	9.07	7.45	3.00	2.25	2.29	1.88	1.63	1.11	2.08	1.81	2.44	2.47	2.25	4.00
L	10.08	8.30	3.25	2.59	2.50	2.19	1.94	1.27	2.27	2.00	2.84	2.62	2.31	4.00
N	12.53	10.30	4.25	3.00	3.30	2.69	2.38	1.56	3.02	2.75	3.50	2.83	2.56	5.00
O	14.06	13.62	5.00	3.62	4.00	3.00	3.00	1.75	3.25	-	3.50	3.44	-	6.50
P	18.19	14.06	5.38	4.56	4.25	3.75	3.19	2.00	3.00	-	4.50	3.88	-	7.00
S	20.12	15.44	6.00	5.06	4.75	4.50	3.25	2.18	3.38	-	4.94	4.75	-	8.00
T	23.72	18.50	7.00	6.00	5.75	5.50	3.91	2.53	4.12	-	5.69	5.69	-	10.00

*Eye Hooks (3/4 TC-22TA), Proof load is 2 times Working Load Limit. Eye Hooks (20 TC-60TA). All carbon hooks - average straightening load (ultimate load) is 5 times Working Load Limit.

Alloy eye hooks 1t through 22t - average straightening load (ultimate load) is 5 times Working Load Limit. Alloy eye hooks 30t through 60t - average straightening load (ultimate load) is 4.5 times Working Load Limit.

** Deformation Indicators. † 3/4TC - 22tA dimensions shown are for S-4320 Latch Kits. Dimensions for sizes 20t carbon and larger are for PL Latch Kits.

†† Dimensions are for PL-N latch kits.

SEE APPLICATION AND WARNING INFORMATION

HOIST HOOKS

The Crosby Group, Inc.

Swivel Hooks

Hoist hooks incorporate markings forged into the product which address two (2) **QUIC-CHECK™** features:

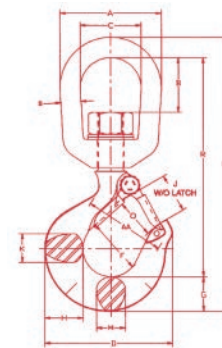

Patented trademark indicates **QUIC-CHECK™** product.

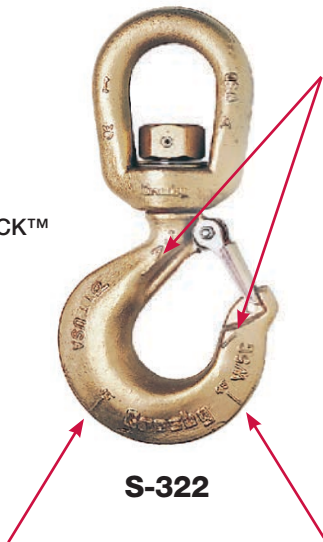

S-322

Deformation Indicators — Two strategically placed marks, one just below the shank or eye and the other on the hook tip, which allows for a **QUIC-CHECK™** measurement to determine if the throat opening has changed, thus indicating abuse or overload.

To check, use a measuring device (i.e., tape measure) to measure the distance between marks. The marks should align to either an inch or half-inch increment on the measuring device. If the measurement does not meet this criteria, the hook should be inspected further for possible damage.

- Forged — Quenched and Tempered.
- Proper design, careful forging, and precision controlled quench and tempering gives maximum strength without excessive weight and bulk.
- Every Crosby Swivel hoist hook has a pre-drilled cam which can be equipped with a latch. Simply purchase the latch assemblies listed and shown beginning on page 116. Even years after purchase of the original hook, latch assemblies can be added.
- Load rating codes stamped on each hook. 322 Swivel Hooks use the same load rating code as 319 Shank Hooks, see page 104 for proper Hook Identification Codes.

Angle Indicators — Indicates the maximum included angle which is allowed between two (2) sling legs in the hook. These indicators also provide the opportunity to approximate other included angles between two sling legs.

U.S. Patents 5,381,650 & 5,193,480 & 5,103,755 and foreign equivalents.

Working Load Limit* (Tons)		CERTEX Cat. Ref. No.	Crosby 322 CN Stock No.	CERTEX Cat. Ref. No.	Crosby 322 AN Stock No.	Weight Each (lbs)	Dimensions (in.)														Deformation Indicator AA
322C	322A						A	B	C	D	F	G	H	J	K	L	M	O†	R	S	
3/4	1	CX05-0088	1048600	CX05-0096	1048804	.75	2.00	.82	1.25	2.86	1.25	.75	.81	.93	.63	5.66	.56	.89	4.53	.38	1.50
1	1-1/2	CX05-0089	1048609	CX05-0097	1048813	1.25	2.50	1.25	1.50	3.15	1.38	.84	.94	.97	.71	6.71	.63	.91	5.37	.50	2.00
1-1/2	2	CX05-0090	1048618	CX05-0098	1048822	2.25	3.00	1.50	1.75	3.59	1.50	1.00	1.16	1.06	.88	7.75	.75	1.00	6.12	.63	2.00
2	3	CX05-0091	1048627	CX05-0099	1048831	2.30	3.00	1.50	1.75	3.99	1.62	1.13	1.31	1.19	.94	8.25	.85	1.09	6.50	.63	2.00
3	5	CX05-0092	1048636	CX05-0100	1048837	4.96	3.50	1.64	2.00	4.84	2.00	1.44	1.63	1.50	1.31	9.69	1.13	1.36	7.50	.75	2.50
5	7	CX05-0093	1048645	CX05-0101	1048854	10.29	4.50	2.29	2.50	6.27	2.50	1.81	2.06	1.78	1.66	12.47	1.38	1.61	9.66	1.00	3.00
7-1/2	11	CX05-0094	1048654	CX05-0102	1048865	16.18	5.00	2.37	2.75	7.54	3.00	2.25	2.63	2.41	1.88	14.54	1.63	2.08	11.16	1.13	4.00
10	15	CX05-0095	1048663	CX05-0103	1048877	23.25	5.62	2.48	3.12	8.33	3.25	2.59	2.94	2.62	2.19	16.09	1.94	2.27	12.00	1.25	4.00
15	22	CX05-0653	1048672	CX05-0104	1048886	47.00	7.10	3.76	4.10	10.38	4.25	3.00	3.50	3.41	2.69	21.22	2.38	3.02	16.59	1.50	5.00
—	30	—	—	CX05-0105	1025688	70.50	7.00	3.75	4.00	13.62	—	3.66	—	4.00	2.86	23.22	2.86	3.25	18.06	1.50	6.50

322C—Carbon Steel 322A—Hook and Bail-Alloy Steel.

† Dimensions for hooks 3/4-ton carbon thru 22-ton alloy are for 4320 latch kit. Dimensions for hooks 30-ton alloy and larger are for PL latch kit.

* NOTE: Proof load is 2 times Working Load Limit. All carbon swivel hooks—average straightening load (ultimate load) is 5 times Working Load Limit. All Alloy swivel hooks—average straightening load (ultimate load) is 4.5 times the Working Load Limit.

This hook is a positioning device and is not intended to rotate under load. Use in salt water requires shank and nut inspection in accordance with A.S.M.E., B30.10-1.2.1(b)(2)(c) 1996.

SEE APPLICATION AND WARNING INFORMATION

HOIST HOOKS

The Crosby Group, Inc.



SEE APPLICATION AND WARNING INFORMATION



S-1316

- Forged Alloy Steel — Quenched and Tempered.
- 25% stronger than Grade 80.
- Individually Proof Tested to 2-1/2 times the Working Load Limit with certification.
- Recessed trigger design is flush with the hook body, protecting the trigger from potential damage.
- Easy to operate with enlarged thumb access.
- Positive Lock Latch is Self-Locking when hook is loaded.
- Eye style is designed with “Engineered Flat” to connect to S-1325 chain coupler.

- Suitable for use with Grade 100 and Grade 80 chain.
- The SHUR-LOC® hook, if properly installed and locked, can be used for personnel lifting applications and meets the intent of OSHA.
- Rule 1926.1431(g)(1)(i)(A) and 1926.1501(g)(4)(iv)(B).
- Fatigue rated at 1-1/2 times the Working Load Limit at 20,000 cycles.
- “Look for the Platinum Color - Crosby Grade 100 Alloy Products”.



S-1317

SHUR-LOC® Hook Series with Positive Locking Latch

S-1316 Eye Hook

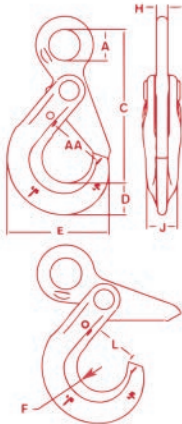

Chain Size		Working Load Limit (lbs)*	S-1316 Stock No.	Weight Each (lbs.)	Dimensions (in.)								
(in.)	(mm)				A	B	C	F	E	H	J	L	AA
-	6	3200	1022896	.85	.78	3.95	.79	2.60	.67	.31	.63	1.14	1.50
1/4-5/16	7-8	5700	1022914	1.80	1.08	5.31	1.10	3.50	.87	.39	.81	1.48	2.00
3/8	10	8800	1022923	3.40	1.30	6.57	1.17	4.39	1.10	.51	.94	1.83	2.50
1/2	13	15000	1022932	6.00	1.65	8.23	1.67	5.45	1.26	.67	1.16	2.22	3.00
5/8	16	22600	1022941	15.1	2.20	10.06	2.04	6.56	1.50	.87	1.50	2.65	3.50
3/4	18-20	35300	1022942	19.0	2.60	10.77	2.22	7.76	2.01	.87	2.03	3.52	-
7/8	22	42700	1022943	28.0	2.87	12.49	2.45	8.75	2.27	.98	2.20	3.83	-
1	26	59700	1022944	49.5	3.15	14.60	3.21	9.87	2.46	1.26	2.68	4.09	-

* Minimum Ultimate Load is 4 times the Working Load Limit.

S-1317 Clevis Hook

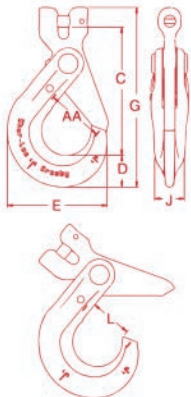

Chain Size		Working Load Limit (lbs.)	S-1317 Stock No.	Weight Each (lbs.)	Dimensions (in.)						
(in.)	(mm)				C	D	E	G	J	L	AA
-	6	3200	1028991	.77	3.44	.79	2.60	4.75	.63	1.16	1.50
1/4	7	4300	1029000	1.80	4.48	1.10	3.51	6.25	.81	1.48	2.00
5/16	8	5700	1029009	1.80	4.47	1.10	3.51	6.25	.81	1.48	2.00
3/8	10	8800	1029018	3.66	5.53	1.17	4.39	7.54	.94	1.83	2.50
1/2	13	15000	1029027	6.80	6.81	1.67	5.49	9.52	1.16	2.22	3.00
5/8	16	22600	1029036	11.9	8.22	2.04	6.55	11.61	1.50	2.65	3.50
3/4	18-20	35300	1029071	15.0	9.42	2.22	7.76	13.21	2.03	3.52	-
7/8	22	42700	1029080	28.0	11.14	2.45	8.75	15.45	2.20	3.83	-
1	26	59700	1029089	49.5	12.56	3.21	9.87	18.44	2.68	4.09	-

* Minimum Ultimate Load is 4 times the Working Load Limit.

HOIST HOOKS

The Crosby Group, Inc.



Crosby 8/10™

Fatigue Rated®

SEE APPLICATION AND WARNING INFORMATION



S-1326

- Forged Alloy Steel — Quenched and Tempered.
- Individually Proof Tested at 2-1/2 times the Working Load Limit with certification.
- Recessed trigger design is flush with the hook body, protecting the trigger from potential damage.
- Easy to operate with enlarged thumb access.
- Positive Lock Latch is Self-Locking when hook is loaded.
- Rated for both Wire Rope, and use with Grade 80/100 Chain.
- G-414 Heavy Thimble should be used with wire rope slings.

- Trigger repair Kit available (S-4316). Consists of spring, roll pin and trigger.
- S-13326 Swivel Hook utilizes anti-friction bearing design which allows hook to rotate freely under load.
- Fatigue rated.
- The SHUR-LOC® hook, if properly installed and locked, can be used for personnel lifting applications and meets the intent of OSHA Rule 1926.1431(g)(1)(i)(A) and 1926.1501(g)(4)(iv)(B).
- “Look for the Platinum Color – Crosby Grade 100 Alloy Products”.
- U.S. Patent 5,381,650 and foreign equivalents.



S-13326

Use in corrosive environment requires shank and nut inspection in accordance with ASME B30.10-1.10.4(b)(5)(c)2009.

S-1326 SHUR-LOC® Swivel Hooks

- Suitable for infrequent, non-continuous rotation under load.

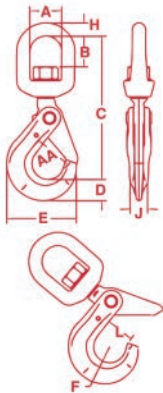

Chain Size		S-1326 Stock No.	Grade 100 Alloy Chain Working Load Limit (lbs.) 4:1*	Weight Each (lbs.)	Dimensions (in.)									
(in.)	(mm)				A	B	C	D	E	F	H	J	L	AA
—	6	1004304	3200	1.26	1.50	1.32	6.13	.79	2.60	.67	.50	.63	1.13	1.50
1/4-5/16	7-8	1004313	5700	2.62	1.75	1.59	7.60	1.10	3.50	.87	.63	.81	1.38	2.00
3/8	10	1004322	8800	4.70	2.00	1.73	8.83	1.17	4.39	1.10	.75	.94	1.75	2.50
1/2	13	1004331	15000	8.64	2.50	2.38	11.20	1.67	5.45	1.26	1.00	1.16	2.11	3.00
5/8	16	1004340	22600	17.00	2.75	2.53	12.98	2.05	6.56	1.50	1.13	1.50	2.49	3.50
3/4	18-20	1004349	35300	24.00	2.83	2.52	17.42	2.22	7.76	2.01	1.10	2.03	3.52	5.00
7/8	22	1004358	42700	29.00	3.44	3.19	16.47	2.45	8.75	2.26	1.30	2.20	3.83	6.00

*Ultimate Load is 4 times the Working Load Limit.

S-13326 SHUR-LOC® Swivel Hooks with Bearing

- Suitable for frequent rotation under load.

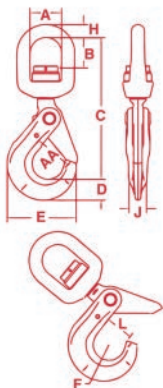

Chain Size		S-13326 Stock No.	Grade 100 Alloy Chain Working Load Limit (lbs.) 4:1*	Weight Each (lbs.)	Dimensions (in.)									
(in.)	(mm)				A	B	C	D	E	F	H	J	L	AA
—	6	1004404	3200	1.50	1.50	1.14	6.17	.79	2.60	.67	.50	.63	1.13	1.50
1/4-5/16	7-8	1004413	5700	3.10	1.75	1.52	7.54	1.10	3.50	.87	.63	.81	1.44	2.00
3/8	10	1004422	8800	5.26	2.00	1.61	8.88	1.16	4.35	1.10	.75	.94	1.83	2.50
1/2	13	1004431	15000	11.22	2.50	2.03	11.11	1.66	5.45	1.26	1.00	1.16	2.19	3.00
5/8	16	1004440	22600	17.32	2.75	1.98	12.61	2.05	6.56	1.50	1.13	1.50	2.61	3.50

*Ultimate Load is 4 times the Working Load Limit.

OTHER HOOKS

NEWCO Manufacturing Company, Inc.

Sliding Choker Hooks

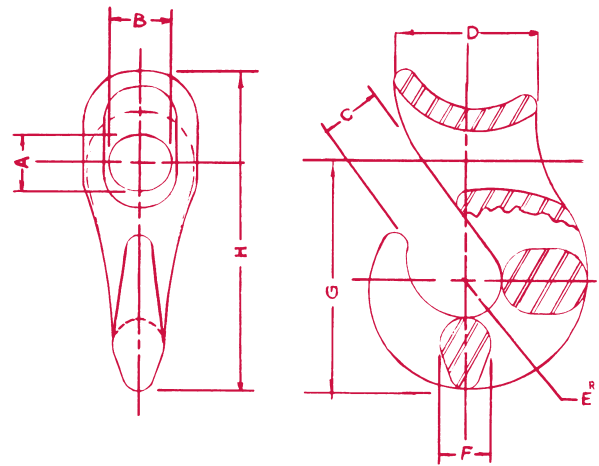

NEWCO sliding hooks afford faster handling on factory made slings for handling pipe, logging, machinery, and in stevedoring. Its free movement permits rapid adjustment of the sling to varying sized loads. "Saddle is rounded to minimize wear" Hook opening is large enough to take a galvanized plow steel thimble the same size as hook size.

All Choker Hooks manufactured by Newco Mfg. Co., Inc., used in any other way than the Choker Configuration, will not be warrantied.

Flat or Braided Sliding Hooks

CERTEX Cat. Ref. No.	HOOK NO.	6 PARTS	WT. LBS.	8 PARTS	W.L.L.	A	B	C	D	E	F	G	H
CX05-0106	0	3/32	1	1/16	1,500	9/16	9/16	1/2	1 3/4	3/8	5/8	2 3/4	3 3/4
CX05-0107	1	1/8	1.4	3/32	2,600	11/16	11/16	5/8	2	7/16	11/16	3 1/8	4 1/4
CX05-0108	2	3/16	1.75	1/8	3,400	13/16	15/16	7/8	2 1/8	17/32	3/4	3 11/32	4 11/16
CX05-0109	3	—	3.25	3/16	5,100	1 3/16	1 1/4	1 1/16	2 3/4	5/8	15/16	3 31/32	5 5/8
CX05-0110	4	1/4	5	1/4	7,000	1 7/16	1 7/16	1 5/32	3	5/8	1 1/8	4 5/8	6 1/4
CX05-0111	5	5/16	6.5	5/16	13,000	1 3/4	1 3/4	1 7/16	3-1/8	3/4	1 3/8	5 1/16	7 3/16
CX05-0112	6	3/8	11	3/8	15,000	2	2	1 17/32	4-1/4	7/8	1 9/16	6 5/16	8 5/8
CX05-0113	7	7/16	26	7/16	23,000	2-5/16	2-5/16	1-3/4	5-5/8	1	1 3/4	8 11/16	11 5/8
CX05-0114	8	1/2-9/16	50	1/2	30,000	2-13/16	2-13/16	2-3/16	7	1-1/4	2	10-5/8	14-1/2

* Manganese Bronze Alloy

Round or Regular Sliding Hooks

CERTEX Cat. Ref. No.	HOOK NO.	ROPE SIZE	WT. LBS.	W.L.L.	THIMBLE SIZE	A	B	C	D	E	F	G	H
CX05-0115	1/4-5/16	1/4-5/16	1	1,500	1/4-5/16	9/16	9/16	1/2	1 3/4	3/8	5/8	2 3/4	3 3/4
CX05-0116	3/8	3/8	1.4	2,600	3/8	11/16	11/16	5/8	2	7/16	11/16	3 1/8	4 1/4
CX05-0117	1/2	1/2	1.85	3,400	1/2	3/4	3/4	7/8	2 1/8	1/2	3/4	3 5/8	4 13/16
CX05-0118	5/8	5/8	4	5,100	5/8	7/8	7/8	1 1/8	2 3/4	9/16	15/16	4 7/16	5 15/16
CX05-0119	3/4	3/4	4.5	8,000	3/4	1	1	1 1/8	3 1/8	11/16	1 1/4	4 11/16	6 7/16
CX05-0120	7/8-1	7/8-1	10	15,000	7/8-1	1 1/4	1 1/4	1 1/4	4 1/4	7/8	1 9/16	6 1/16	8 1/8
CX05-0121	1 1/8-1 1/4	1 1/8-1 1/4	26	23,000	1 1/8-1 1/4	2 5/16	2 5/16	1 3/4	5 5/8	1	1 3/4	8 11/16	11 5/8
CX05-0122	1 3/8-1 1/2	1 3/8-1 1/2	50	30,000	1 3/8-1 1/2	2 13/16	2 13/16	2 3/8	7	1 1/4	2	10 5/8	14 1/2

* Manganese Bronze Alloy

OTHER HOOKS

NEWCO Manufacturing Company, Inc.

Sliding Latch Type Choker Hooks

This hook is designed to choke a secure hold on a load in position. A latch prevents the eye of the sling from disengaging from the hook.

Sizes available 3/8" thru 3/4".

Latch Kits Available



CERTEX Cat. Ref. No.	Hook No.	Rope Size	Wt. Lbs.	W.W.L.	Thimble Size	A	B	C	D	ER	F	G	H
CX05-0123	S 3/8	3/8	1 1/4	2,600	3/8	11/16	11/16	5/8	2	7/16	11/16	3 1/8	4 1/4
CX05-0124	S 1/2	1/2	1 3/4	3,400	1/2	3/4	3/4	7/8	2 1/8	1/2	3/4	3 5/8	4 13/16
CX05-0125	S 5/8	5/8	3 1/4	5,100	5/8	7/8	7/8	1 1/8	2 3/4	9/16	15/16	4 7/16	5 15/16
CX05-0126	S 3/4	3/4	5	8,000	3/4	1	1	1 1/8	3 1/8	11/16	1 1/4	4 11/16	6 7/16

The Crosby Group, Inc.

Sliding Choker Hooks

- Forged Alloy Steel —
Quenched and Tempered

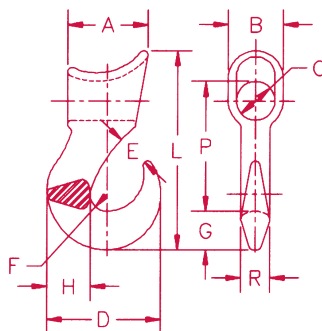

A-350

Single Part Rope Size (in.)	Eight Part Rope Size (in.)	CERTEX Cat. Ref. No.	Crosby A-350 Stock No. S.C.	Working Load Limit* (lbs.)	Weight Each (lbs.)	Dimensions (in.)										
						A	B	C	D	E	F	G	H	L	P	R
3/8	—	CX05-0127	1028042	2500	.77	2.06	1.13	.63	2.41	.63	.38	.84	.91	4.28	2.59	.63
1/2	1/8	CX05-0128	1028060	3300	1.19	2.25	1.31	.75	2.97	.78	.50	.97	1.06	4.97	3.09	.75
† 5/8	3/16	CX05-0129	1028088	5000	2.89	3.06	1.63	.75	3.56	.94	.56	1.13	1.31	6.38	3.88	1.00
† 5/8	3/16	CX05-0130	1028104	5000	2.70	3.06	1.63	1.00	3.56	.94	.56	1.13	1.31	6.38	4.00	1.13
† 3/4	1/4	CX05-0131	1028122	8000	2.95	3.38	2.13	1.00	4.25	1.16	.63	1.44	1.63	7.66	4.56	1.13
† 3/4	1/4	CX05-0132	1028140	8000	5.00	3.38	2.13	1.44	4.25	1.16	.63	1.44	1.63	7.66	4.78	1.13

* Ultimate Load is 5 times the Working Load Limit.
† When ordering, EYE diameter "C" should be specified.

OTHER HOOKS

The Crosby Group, Inc.

Snap Hooks

- Forged Carbon Steel — Quenched and Tempered.
- Pressed steel latches and stainless steel springs, bolts and nuts.
- For replacement latch kit, order Stock No. 9900299.



G-3315

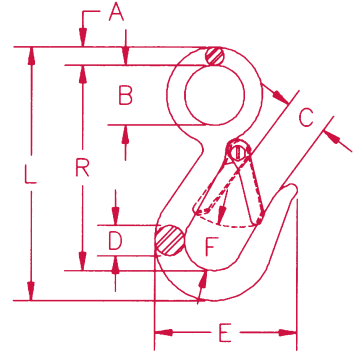

Hook Size (in.)	CERTEX Cat. Ref. No.	Crosby G-3315 Stock No. Galv.	Working Load Limit* (lbs.)	Weight Each (lbs.)	Dimensions (in.)							
					A	B	C	D	E	F	L	R
7/16	CX05-0133	1023056	750	.23	.25	.75	.75	.44	2.25	.75	3.94	3.25
9/16	CX05-0134	1023074	1000	.52	.34	1.12	.81	.56	2.69	.88	4.75	3.84

* Ultimate Load is 4 times the Working Load Limit.

Round Reverse Eye

- Forged Carbon Steel — Galvanized.



1210

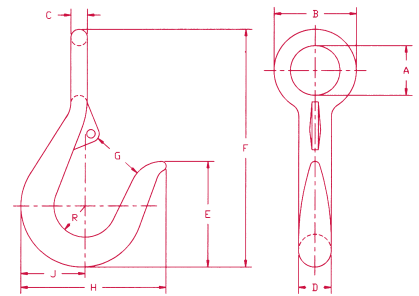

Size (in.)	CERTEX Cat. Ref. No.	Crosby Stock No. Galv.	Working Load Limit (lbs.)	Weight Each (lbs.)	Latch No.	Dimensions (in.)									
						A	B	C	D	E	F	G	H	J	R
1/2	CX05-0135	919019	300	0.4	1090027	.81	1.38	.28	.50	1.62	4.00	.75	2.25	.97	.47
5/8	CX05-0136	919037	400	0.6	1090027	.94	1.56	.31	.62	2.00	4.50	.94	2.75	1.22	.59
3/4	CX05-0137	919055	700	1.1	1090045	1.12	1.88	.38	.75	2.25	5.25	1.06	3.00	1.44	.69
7/8	CX05-0138	919073	1200	1.6	1090063	1.19	2.06	.44	.88	3.00	6.50	1.25	3.38	1.63	.75
1 - 1 1/8	CX05-0139	919091	1800	2.0	1090081	1.50	2.75	.62	1.12	3.50	8.00	1.50	4.38	2.00	.94
1 1/4 - 1 3/8	CX05-0140	919135	2700	5.5	1090081	1.88	3.50	.81	1.38	4.00	9.12	1.62	5.00	2.38	1.06

* Ultimate Load is 4 times the Working Load Limit.

OTHER HOOKS

The Crosby Group, Inc.

Barrel Hooks



S-377

- Forged Carbon Steel

Meets the performance requirements of Federal Specification RR-C-271D, Type V, Class 6, except for those provisions required of the contractor.

CERTEX Cat. Ref. No.	Crosby Stock No. (Per Pair) S-377 S.C.	Working Load Limit* Per Pair (tons)	Weight Each Per Pair (lbs.)	Dimensions (in.)			
				I.D. of Eye	O.D. of Eye	Overall Length	Width of Lip
CX05-0141	1028248	1	3.56	1.56	2.81	5.00	2.88

* Ultimate Load is 4 times the Working Load Limit.

Sorting Hook



A-378

- Forged Alloy Steel —
Quenched and Tempered.
- Deep straight throat permits efficient handling of flat plates or large cylindrical shapes.
- The long tapered point allows easy grab in rings, pear links, eye bolts or lifting holes.

Working Load Limit* at tip of Hook (tons)	Working Load Limit* at bottom of Hook (tons)	CERTEX Cat. Ref. No.	Crosby A-378 Stock No. S.C.	Weight Each (lbs.)	Dimensions (in.)			
					I.D. of Eye	Overall Length	Opening at top of Hook	Radius at bottom of Hook
2	7 1/2	CX05-0142	1028024	6.42	1.38	9.69	2.81	.625

* Ultimate Load is 5 times the Working Load Limit.

WARNINGS AND APPLICATION INSTRUCTIONS S-4320 HOOK LATCH KIT

The Crosby Group, Inc.

(For Crosby 319N, 320N, and 322N Hooks)

Important Safety Information — Read & Follow

- Always inspect hook and latch before using.
- Never use a latch that is distorted or bent.
- Always make sure spring will force the latch against the tip of the hook.
- Always make sure hook supports the load. The latch must never support the load. (See Figure 1 & 2.)
- When placing two (2) sling legs in hook, make sure the angle between the legs is less than 90° and if the hook or load is tilted, nothing bears against the bottom of this latch. (See Figure 3 & 4.)
- Latches are intended to retain loose sling or devices under slack conditions.
- Latches are not intended to be an anti-fouling device.
- When using latch for personnel lifting, select proper cotter pin (See Figure 5 on the following page). See Step 7 for proper installation instructions.
 - Never reuse a bent cotter pin.
 - Never use a cotter pin with a smaller diameter or different length than recommended in Figure 5.
 - Never use a nail, a welding rod, wire, etc., in place of recommended cotter pin.
 - Always ensure cotter pin is bent so as not to interfere with sling operation.
 - Periodically inspect cotter pin for corrosion and general adequacy.

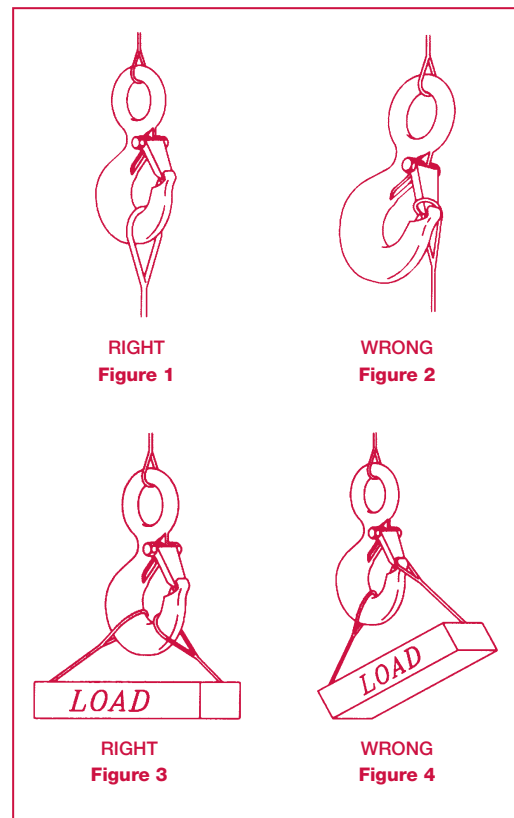

Hook Working Load Limit† (tons)		Hook Identification Code		Recommended Cotter Pin Dimensions (in.)	
Carbon	Alloy	Carbon	Alloy	Diameter	Length
3/4	1	DC	DA	1/8	3/4
1	1 1/2	FC	FA	1/8	3/4
1 1/2	2	GC	GA	1/8	1
2	3	HC	HA	3/16	1 1/4
3	5	IC	IA	1/4	1 1/2
5	7	JC	JA	5/16	2
7 1/2	11	KC	KA	5/16	2
10	15	LC	LA	3/8	3
15	22	NC	NA	3/8	3

† The current SS-4055 latch kit and the PL latch will not fit new 319N, 320N, or 322N hooks. They will continue to be offered in both styles to service existing hooks. Important – The new S4320 latch kit will not fit the old 319, 320, or 322 hooks.

WARNING:

- Loads may disengage from hook if proper procedures are not followed.
- A falling load may cause serious injury or death.
- Hook must always support the load. The load must never be supported by the latch.
- See OSHA Rule 1926.550 (g) for personnel hoisting by crane or Derricks. A Crosby S-319N, S-320N, S-322N Hook with an S-4320 latch attached (When secured with cotter pin) may be used for lifting personnel.
- An S-4320 Latch is only to be used with a Crosby S-319N, S-320N and S-322N Hook.
- DO NOT use this latch in applications requiring non sparking.
- Read and understand these instructions before using hook and latch.

WARNINGS AND APPLICATION INSTRUCTIONS FOR S-4320 HOOK LATCH KIT

The Crosby Group, Inc.

Figure 5: IMPORTANT — Instructions for Assembling S-4320 Latch on Crosby 320N Hooks

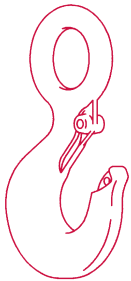

Step 1

Place hook at approximately a 45 degree angle with the cam up.

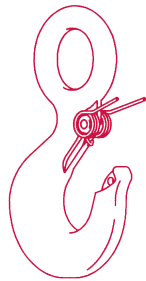

Step 2

Position coils of spring over cam with legs of spring pointing toward point of hook and loop of spring positioned down and lying against the hook.



Step 3

Position latch to side of hook points. Slide latch onto spring legs between lockplate and latch body until latch is partially over hook cam. Then depress latch and spring until latch clears point of hook.

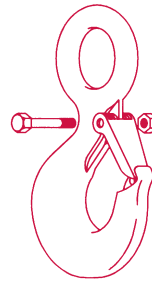

Steps 4, 5, & 6

4. Line up holes in latch with hook cam.
5. Insert bolt through latch, spring, and cam.
6. Tighten self-locking nut on one end of bolt.

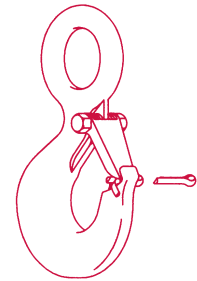

Step 7 — For Personnel Lifting

With latch in closed position and rigging resting in bowl of hook, insert cotter pin through hook tip and secure by bending prongs.



HOOK LATCHES

The Crosby Group, Inc.

Crosby S-4320 Latch Kit

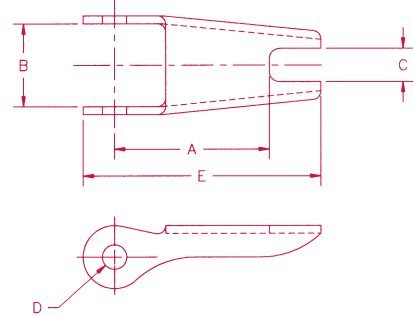

S-4320

Latch Kits shipped unassembled and individually packaged with instructions.

Replacement Latch Kit for New 320N Hooks

- Heavy duty stamped latch interlocks with the hook tip.
- High cycle, long life spring.
- Can be made into a “Positive Locking” Hook when proper cotter pin is utilized.

IMPORTANT: The new S-4320 Latch Kit will not fit the old style 320 and 319 hooks.

Hook Size (Tons)		CERTEX Cat. Ref. No.	Crosby S-4320 Stock No.	Weight Each (lbs.)	Dimensions (in.)				
Carbon	Alloy				A	B	C	D	E
3/4	1	CX05-0143	1096325	.03	.94	.50	.20	.15	1.44
1	1 1/2	CX05-0144	1096374	.04	1.00	.54	.22	.17	1.56
1 1/2	2	CX05-0145	1096421	.04	1.09	.63	.23	.17	1.66
2	3	CX05-0146	1096468	.06	1.21	.66	.28	.17	1.91
3	5	CX05-0147	1096515	.10	1.53	.83	.35	.20	2.31
5	7	CX05-0148	1096562	.15	1.88	1.04	.44	.20	2.88
7 1/2	11	CX05-0149	1096609	.28	2.38	1.25	.53	.27	3.44
10	15	CX05-0150	1096657	.33	2.62	1.35	.59	.27	3.81
15	22	CX05-0151	1096704	.84	3.44	1.66	.66	.39	5.18

SEE APPLICATION AND
WARNING INFORMATION

WARNINGS AND APPLICATION INSTRUCTIONS FOR CROSBY MODEL PL HOOK LATCH KIT

The Crosby Group, Inc.



RIGHT
Figure 1



WRONG
Figure 2



RIGHT
Figure 3

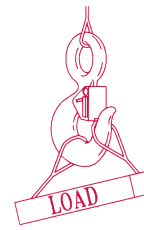

WRONG
Figure 4

IMPORTANT – Instructions for Assembling Model PL Latch on Crosby or McKissick Hooks

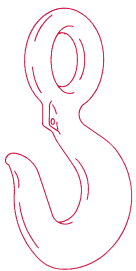

Step 1

Place hook at approximately a 45 degree angle with the cam up.

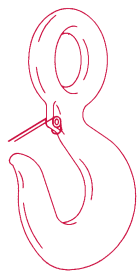

Step 2

Position coils of spring over cam with legs of spring pointing toward point of hook and loop of spring positioned down and lying against the hook.

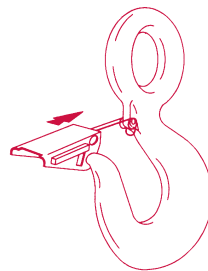

Step 3

Position latch to side of hook points. Slide latch onto spring legs between lockplate and latch body until latch is partially over hook cam. Then depress latch and spring until latch clears point of hook.

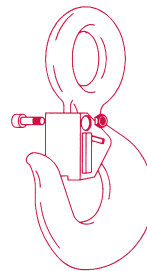

Steps 4, 5, & 6

4. Line up holes in latch with hook cam.
5. Insert bolt through latch, spring, and cam.
6. Tighten self-locking nut on one end of bolt.

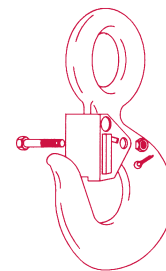

Step 7 — For Personnel Lifting

With latch in closed position and rigging resting in bowl of hook, insert cotter pin through hook tip and secure by bending prongs.

Important Safety Information — Read & Follow

- Always inspect hook and latch before using.
- Never use a latch that is distorted or bent.
- Always make sure spring will force the latch against the tip of the hook.
- Always make sure hook supports the load. The latch must never support the load. (See Figure 1 & 2.)
- When placing two (2) sling legs in hook, make sure the angle between the legs is less than 90° and if the hook or load is tilted, nothing bears against the bottom of this latch. (See Figure 3 & 4.)
- Latches are intended to retain loose sling or devices under slack conditions.
- Latches are not intended to be an anti-fouling device.

* The Model PL Latch Replaces Model G-5066

WARNING:

- Loads may disengage from hook if proper procedures are not followed.
- A falling load may cause serious injury or death.
- See OSHA Rule 1926.550 (g) for Personnel Hoisting by Cranes or Derricks. A Crosby or McKissick Hook with a positive Locked PL or S-4320 Latch may be used to Lift Personnel.
- Hook must always support the load. The load must never be supported by the latch.
- Read and understand these instructions before using hook and latch.

HOOK LATCHES

The Crosby Group, Inc.

Positive Locking Flapper Latch

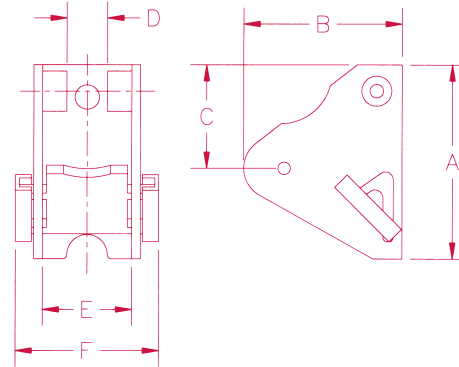
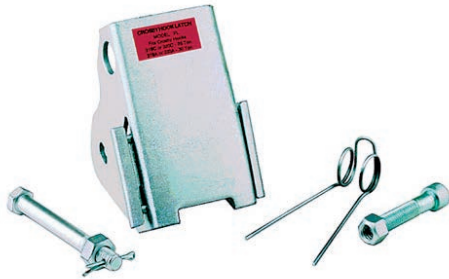

PL Latch

(Patented in U.S.A. & Canada)

- Heavy duty latch with easy operating features.
- Hot Dip galvanized.
- Flapper lever indicates locked or unlocked position.
- Assembly instructions included with each latch.
- Meets the intent of OSHA Rule 1926.550 (g) (when secured with the bolt, nut and pin) for lifting personnel.

Latch Ordering Instructions

1. Specify PL latch kit stock number from chart below.
2. Specify capacity of hook to which latch will be assembled.
3. Specify hook material (carbon or alloy).

* NOTE: The PL latch will not work on 320N Hooks.

Hook Size (tons)		CERTEX Cat. Ref. No.	Crosby PL Latch Kit Stock No.	Weight Each (lbs.)	Dimensions (in.)					
Carbon	Alloy				A	B	C	D	E	F
3	4 1/2	CX05-0152	1093711	.54	2.57	2.34	1.94	.56	1.13	2.00
5	7	CX05-0153	1093712	.66	3.00	2.34	2.00	.63	1.38	2.22
7 1/2	11	CX05-0154	1093713	1.00	3.63	2.77	2.38	.63	1.63	2.38
10	15	CX05-0155	1093714	1.25	4.00	3.22	2.69	.63	1.88	3.38
15	22	CX05-0156	1093715	2.96	5.31	4.00	2.91	.84	2.38	3.44
20	30	CX05-0157	1093716	4.05	6.00	4.44	3.19	1.06	2.88	4.25
25	37	CX05-0158	1093717	8.63	7.00	6.63	4.06	2.24	4.50	6.12
30	45	CX05-0159	1093718	10.00	6.75	7.00	4.03	2.24	4.75	6.38
40	60	CX05-0160	1093719	14.30	8.00	7.66	4.38	3.46	5.50	7.25
50	75	CX05-0161	1093720	27.00	9.88	8.19	5.13	3.38	6.50	8.88
—	100 - 150	CX05-0162	1093721	33.25	10.88	11.06	6.38	3.38	7.50	10.00
—	200	CX05-0163	1093723	45.00	11.88	11.19	6.38	3.38	8.75	11.25
—	300	CX05-0164	1093724	55.00	12.50	12.19	8.00	3.38	9.75	13.00

Patented in USA & Canada

**SEE APPLICATION AND
WARNING INFORMATION**

HOOK LATCHES

The Crosby Group, Inc.

Warnings and Application Instructions Hook Latch Kit



RIGHT
Figure 1



WRONG
Figure 2



RIGHT
Figure 3



WRONG
Figure 4

IMPORTANT – Instructions for Assembling SS-4055 Latch on Crosby Hooks



Step 1

Place hook at approximately a 45 degree angle with a cam up.



Step 2

Position coils of spring over cam with tines of spring pointing toward point of hook and loop of spring positioned down and lying against the hook.

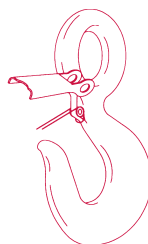

Step 3

Position latch over tines of spring with ears partially over hook cam. Swing latch to one side of hook, point and depress latch and spring until latch clears point of hook.

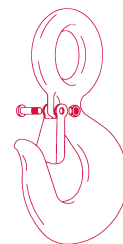

Steps 4, 5, & 6

4. Line up holes in latch with hook cam.
5. Insert bolt through latch, spring, and cam.
6. Tighten self-locking nut on one end of bolt.

Important Safety Information — Read and Follow

- Always inspect hook and latch before using.
- Never use a latch that is distorted or bent.
- Always make sure spring will force the latch against the tip of the hook.
- Always make sure hook supports the load. The latch must never support the load. (See Figure 1 & 2)
- When placing two (2) sling legs in hook, make sure the angle between legs is small enough and the legs are not tilted so that nothing bears against the bottom of the latch. (See Figure 3 & 4)
- Latches are intended to retain loose sling or devices under slack conditions.
- Latches are not intended to be an anti-fouling device.

WARNING:

- Loads may disengage from hook if proper procedures are not followed.
- A falling load may cause serious injury or death.
- See OSHA Rule 1926.550 (g) for Personnel Hoisting by Cranes or Derricks. A Crosby or McKissick Hook with a positive Locked PL or S-4320 Latch may be used to Lift Personnel.
- Hook must always support the load. The load must never be supported by the latch.
- Read and understand these instructions before using hook and latch.

HOOK LATCHES

The Crosby Group, Inc.

Crosby Latch Kit



SS-4055

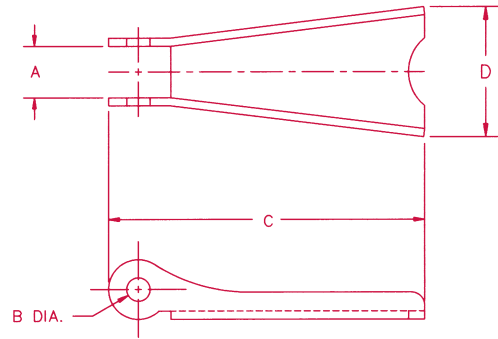

- Stainless steel construction with cadmium plated steel nuts.
- Shipped packaged and unassembled.
- Instructions included for easy field assembly.

Latch Ordering Instructions

1. Specify latch kit stock number.
2. Specify capacity of hook to which latch will be assembled.
3. Specify hook material (carbon or alloy).

* NOTE: These latches will not work on 320N Hooks

Hook Size (tons)			CERTEX Cat. Ref. No.	Crosby SS-4055 Stock No.	Weight Each (lbs.)	Dimensions (in.)			
Carbon	Alloy	Bronze				A	B	C	D
3/4	1	.5	CX05-0165	1090027	.02	.38	.16	1.44	.59
1	1 1/2	.6	CX05-0166	1090045	.02	.38	.16	1.60	.59
1 1/2 - 2	2 - 3	1.0 - 1.4	CX05-0167	1090063	.03	.47	.19	1.84	.82
3	4 1/2	2.0	CX05-0168	1090081	.06	.56	.17	2.41	1.00
5	7	3.5	CX05-0169	1090107	.11	.58	.20	2.97	1.21
7 1/2 - 10	11 - 15	5.0 - 6.5	CX05-0170	1090125	.17	.59	.27	3.66	1.50
15	22	10.0	CX05-0171	1090143	.39	.83	.39	4.94	1.90
20	30	—	CX05-0172	1090161	.63	.94	.52	5.88	2.56
25 - 30	37 - 45	—	CX05-0173	1090189	1.12	2.19	.39	6.50	3.84
40	60	—	CX05-0174	1090205	1.77	3.31	.52	7.88	4.12

**SEE APPLICATION AND
WARNING INFORMATION**

SWIVELS

The Crosby Group, Inc.

Equipped with Tapered Roller Thrust Bearing
(For Swiveling Under Loads)



S-1
Jaw & Hook



S-3
Jaw & Eye



S-5
Eye & Eye

Swivel Number (type)	CERTEX Cat. Ref. No.	Crosby Stock No. S.C.	Working Load Limit* (metric tons)	Wire Rope Size (in.)	Weight Each (lbs.)
3-S-1	CX05-0251	297011	3	1/2	9.81
3-S-2	CX05-0252	297020	3	1/2	9.63
3-S-3	CX05-0253	297039	3	1/2	9.12
3-S-4	CX05-0254	297048	3	1/2	9.00
3-S-5	CX05-0255	297057	3	1/2	8.50
3-S-6	CX05-0256	297066	3	1/2	9.32
5-S-1	CX05-0257	297217	5	5/8	15.51
5-S-2	CX05-0258	297226	5	5/8	13.69
5-S-3	CX05-0259	297235	5	5/8	13.50
5-S-4	CX05-0260	297244	5	5/8	12.33
5-S-5	CX05-0261	297253	5	5/8	11.30
5-S-6	CX05-0262	297262	5	5/8	14.24
8 1/2-S-1	CX05-0263	297413	8 1/2	3/4	29.42
8 1/2-S-2	CX05-0264	297422	8 1/2	3/4	26.16
8 1/2-S-3	CX05-0265	297431	8 1/2	3/4	24.90
8 1/2-S-4	CX05-0266	297440	8 1/2	3/4	29.00
8 1/2-S-5	CX05-0267	297459	8 1/2	3/4	29.25
8 1/2-S-6	CX05-0268	297468	8 1/2	3/4	32.00
10-S-1	CX05-0269	297618	10	7/8	46.75
10-S-2	CX05-0270	297627	10	7/8	45.75
10-S-3	CX05-0271	297636	10	7/8	43.50
10-S-4	CX05-0272	297645	10	7/8	44.00
10-S-5	CX05-0273	297654	10	7/8	42.00
10-S-6	CX05-0274	297663	10	7/8	45.50
15-S-1	CX05-0275	297814	15	1	73.75
15-S-2	CX05-0276	297823	15	1	62.75
15-S-3	CX05-0277	297832	15	1	61.00
15-S-4	CX05-0278	297841	15	1	61.00
15-S-5	CX05-0279	297850	15	1	49.00
15-S-6	CX05-0280	297869	15	1	63.00
25-S-1	CX05-0281	298118	25	—	140.00
25-S-2	CX05-0282	298127	25	—	140.00
25-S-3	CX05-0283	298136	25	—	135.00
25-S-4	CX05-0284	298145	25	—	135.00
25-S-5	CX05-0285	298154	25	—	130.00
25-S-6	CX05-0286	298163	25	—	135.00
35-S-1	CX05-0287	298216	35	—	220.00
35-S-2	CX05-0288	298225	35	—	155.00
35-S-3	CX05-0289	298234	35	—	150.00
35-S-4	CX05-0290	298243	35	—	150.00
35-S-5	CX05-0291	298252	35	—	145.00
35-S-6	CX05-0292	298261	35	—	215.00
45-S-1	CX05-0293	298314	45	—	251.00
45-S-2	CX05-0294	298323	45	—	235.00
45-S-3	CX05-0295	298332	45	—	225.00
45-S-4	CX05-0296	298341	45	—	225.00
45-S-5	CX05-0297	298350	45	—	215.00
45-S-6	CX05-0298	298369	45	—	270.00

* Individually Proof tested to 2 times the Working Load Limit. Ultimate Load is 5 times the Working Load Limit.



S-2
Jaw & Jaw



S-4
Eye & Jaw



S-6
Eye & Hook

SWIVELS

The Crosby Group, Inc.

Equipped with Tapered Roller Thrust Bearing

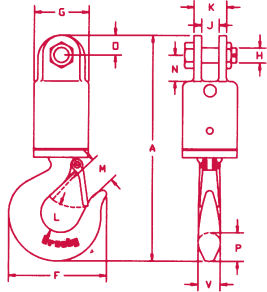

S-1
Jaw & Hook

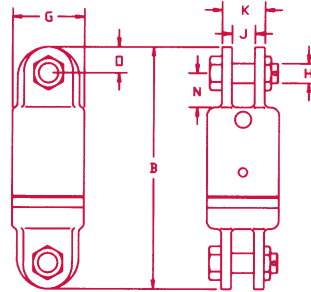

S-2
Jaw & Jaw

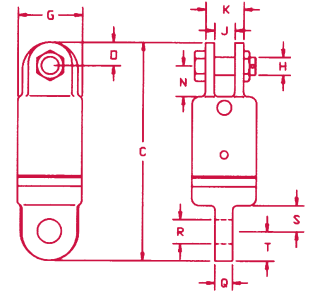

S-3
Jaw & Eye

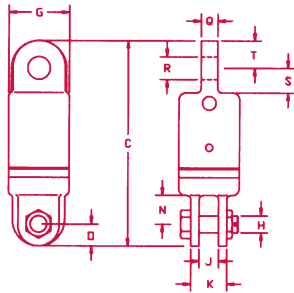

S-4
Eye & Jaw

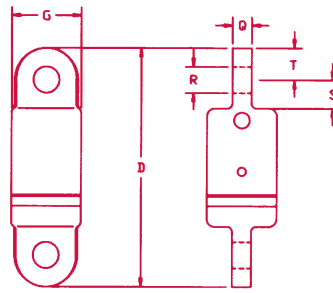

S-5
Eye & Eye

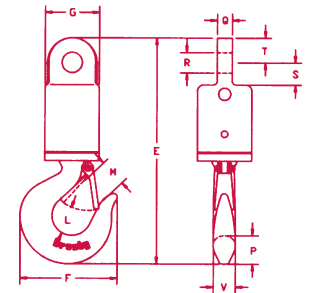

S-6
Eye & Hook

- Designed to swivel under load.
- All swivels individually proof tested with certification.
- All hooks furnished with latches assembled.
- All jaws complete with bolts, nuts and cotter pins.
- Pressure lube fitting provided.
- NOT TO BE USED ON DEMOLITION (WRECKING) BALLS.
- Other types and capacities up to 600 tons, available to meet your requirements.

Working Load Limit* (Metric Tons)	Dimensions (in.)																			
	A	B	C	D	E	F	G	H	J	K	L	M	N	P	Q	R	S	T	V	O
3	11.38	9.28	9.34	9.41	11.44	4.94	2.75	.75	.88	1.62	1.38	1.34	1.31	1.44	.75	1.03	1.12	1.25	1.12	1.00
5	13.31	10.31	10.06	9.81	13.06	6.50	3.00	.88	1.00	2.25	1.78	1.69	1.62	1.81	1.00	1.28	1.25	1.25	1.38	1.12
8 1/2	16.44	12.62	12.25	11.88	16.06	7.56	4.00	1.00	1.56	2.81	2.12	2.06	2.12	2.25	1.25	1.41	1.62	1.50	1.62	1.38
10	19.72	16.75	16.12	15.50	19.09	8.69	4.50	1.50	1.75	3.38	2.56	2.25	3.50	2.59	1.69	1.69	2.75	1.88	1.94	1.75
15	22.00	17.12	16.75	16.38	21.62	11.00	5.00	1.50	1.75	3.38	2.88	3.00	3.50	3.00	1.94	2.03	2.75	2.12	2.38	1.75
25	26.78	20.75	21.50	22.25	27.53	13.62	6.00	2.00	2.00	4.62	3.44	3.62	3.69	3.66	2.25	2.31	3.88	2.38	3.00	2.38
35	29.94	20.75	21.50	22.25	30.69	14.06	6.50	2.00	2.00	4.62	3.88	3.75	3.69	4.56	2.25	2.31	3.88	2.38	3.19	2.38
45	35.06	25.25	25.88	26.50	35.69	15.44	7.00	2.25	2.50	5.00	4.75	4.25	4.00	5.06	2.50	2.53	4.00	3.00	3.25	3.00

* Individually Proof tested to 2 times the Working Load Limit. Ultimate load is 5 times the Working Load Limit.

IMPORTANT:

Crosby Swivels should only be used with the recommended wire rope. Contact the wire rope manufacturer for the proper wire rope to be used with Crosby Swivels.

SWIVELS

The Crosby Group, Inc.

Chain Swivels

- Hot Dip Galvanized
- Quenched & Tempered



G-401

Meets the performance requirements of Federal Specifications RR-C-271D, Type VII, Class 1 except for those provisions required of the contractor.

Size (in.)	CERTEX Cat. Ref. No.	Crosby G-401 Stock No. Galv.	Working Load Limit* (lbs.)	Weight Each (lbs.)	Dimensions (in.)											
					A	B	C	D	E	G	J	M	R	T	U	V
1/4	CX05-0299	1016233	850	.13	1.25	.69	.75	.62	1.12	.25	.69	.31	2.25	2.75	1.69	1.25
5/16	CX05-0300	1016251	1250	.25	1.63	.81	1.00	.75	1.38	.31	.81	.38	2.72	3.34	2.06	1.47
3/8	CX05-0301	1016279	2500	.54	2.00	.94	1.25	1.00	1.75	.38	1.00	.50	3.44	4.19	2.50	1.88
1/2	CX05-0302	1016297	3600	1.12	2.50	1.31	1.50	1.25	2.25	.50	1.31	.63	4.25	5.25	3.19	2.44
5/8	CX05-0303	1016313	5200	2.09	3.00	1.56	1.75	1.50	2.75	.62	1.50	.75	5.13	6.31	3.88	2.94
3/4	CX05-0304	1016331	7200	3.09	3.50	1.75	2.00	1.75	3.25	.75	1.88	.88	5.78	7.22	4.94	3.46

* Ultimate Load is 5 times the Working Load Limit

Regular Swivels

- Hot Dip Galvanized
- Quenched & Tempered

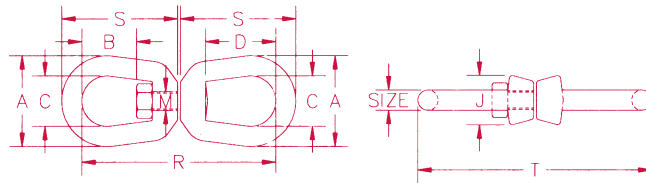

G-402

Meets the performance requirements of Federal Specifications RR-C-271D, Type VII, Class 1 except for those provisions required of the contractor.

Size (in.)	CERTEX Cat. Ref. No.	Crosby G-402 Stock No. Galv.	Working Load Limit* (lbs.)	Weight Each (lbs.)	Dimensions (in.)								
					A	B	C	D	J	M	R	S	T
1/4	CX05-0305	1016019	850	.21	1.25	.69	.75	1.06	.69	.31	2.94	1.69	3.44
5/16	CX05-0306	1016037	1250	.39	1.63	.81	1.00	1.25	.81	.38	3.56	2.06	4.19
3/8	CX05-0307	1016055	2250	.71	2.00	.94	1.25	1.50	1.00	.50	4.31	2.50	5.06
1/2	CX05-0308	1016073	3600	1.32	2.50	1.31	1.50	2.00	1.31	.63	5.44	3.19	6.44
5/8	CX05-0309	1016091	5200	2.49	3.00	1.56	1.75	2.38	1.50	.75	6.56	3.88	7.81
3/4	CX05-0310	1016117	7200	4.02	3.50	1.75	2.00	2.63	1.88	.88	7.19	4.31	8.69
7/8	CX05-0311	1016135	10000	6.25	4.00	2.06	2.25	3.06	2.13	1.00	8.38	5.00	10.13
1	CX05-0312	1016153	12500	8.95	4.50	2.31	2.50	3.50	2.38	1.13	9.63	5.75	11.63
1 1/4	CX05-0313	1016199	18000	16.37	5.63	2.69	3.13	3.69	3.00	1.38	11.13	6.75	13.36
1 1/2	CX05-0314	1016215	45200	45.79	7.00	4.19	4.00	4.19	4.00	2.25	17.13	10.00	20.13

* Ultimate Load is 5 times the Working Load Limit

SWIVELS

The Crosby Group, Inc.

Jaw End Swivels



G-403

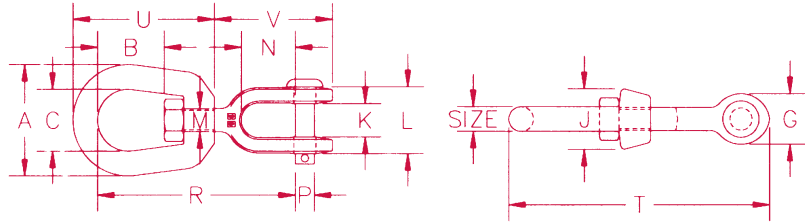

- Hot Dip Galvanized
- Quenched & Tempered

Meets the performance requirements of Federal Specifications RR-C-271D, Type VII, Class 3, except for those provisions required of the contractor.
 401, 402 and 403 swivels are positioning devices and are not intended to rotate under load.
 U.S. Patent 5,381,650 and foreign equivalents

Size (in.)	CERTEX Cat. Ref. No.	Crosby G-403 Stock No. Galv.	Working Load Limit* (lbs.)	Weight Each (lbs.)	Dimensions (in.)													
					A	B	C	G	J	K	L	M	N	P	R	T	U	V
1/4	CX05-0315	1016395	850	.21	1.25	.69	.75	.69	.69	.47	1.03	.31	.88	.25	2.63	3.38	1.69	1.69
5/16	CX05-0316	1016411	1250	.34	1.63	.81	1.00	.81	.81	.50	1.13	.38	.88	.31	2.94	3.88	2.06	1.81
3/8	CX05-0317	1016439	2250	.66	2.00	.94	1.25	1.00	1.00	.63	1.41	.50	1.06	.38	3.63	4.75	2.50	2.25
1/2	CX05-0318	1016457	3600	1.34	2.50	1.31	1.50	1.31	1.31	.75	1.75	.63	1.31	.50	4.50	6.06	3.19	2.88
5/8	CX05-0319	1016475	5200	2.48	3.00	1.56	1.75	1.63	1.50	.94	2.06	.75	1.50	.63	5.31	7.31	3.88	3.44
3/4	CX05-0320	1016493	7200	3.88	3.50	1.75	2.00	1.88	1.88	1.13	2.53	.88	1.75	.75	6.06	8.31	4.31	4.00
7/8	CX05-0321	1016518	10000	5.87	4.00	2.06	2.25	2.13	2.13	1.19	2.75	1.00	2.06	.88	7.00	9.53	5.00	4.53
1	CX05-0322	1016536	12500	9.84	4.50	2.31	2.50	2.63	2.38	1.75	3.72	1.13	2.81	1.13	8.56	11.69	5.75	5.94
1 1/4	CX05-0323	1016572	18000	15.75	5.69	2.69	3.13	3.13	3.00	2.06	4.31	1.50	2.81	1.38	9.44	13.13	6.75	6.38
1 1/2	CX05-0324	1016590	45200	54.75	7.00	4.19	4.00	5.63	4.00	2.88	6.00	2.25	4.44	2.25	14.74	20.84	10.00	10.84

* Ultimate Load is 5 times the Working Load Limit.

WIRE ROPE THIMBLES

The Crosby Group, Inc.

Standard Wire Rope Thimbles

G-411
Standard

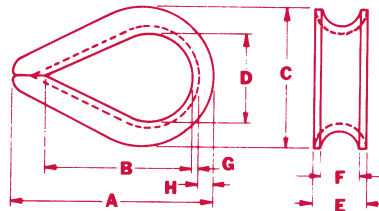

- Recommended for light duty service.
- Hot Dip galvanized Steel.

G-411 meets the performance requirements of Federal Specification FF-T-276b Type II, except for those provisions required of the contractor.

Rope Dia (in.)	CERTEX Cat. Ref. No.	Crosby G-411 Stock No. Galv.	Weight Per 100 (lbs.)	Dimensions (in.)							
				A	B	C	D	E	F	G	H
1/8	CX05-0325	1037256	3.50	1.94	1.31	1.06	.69	.25	.16	.05	.13
3/16	CX05-0326	1037274	3.50	1.94	1.31	1.06	.69	.31	.22	.05	.13
1/4	CX05-0327	1037292	3.50	1.94	1.31	1.06	.69	.38	.28	.05	.13
5/16	CX05-0328	1037318	4.00	2.13	1.50	1.25	.81	.44	.34	.05	.13
3/8	CX05-0329	1037336	6.70	2.38	1.63	1.47	.94	.53	.41	.06	.16
1/2	CX05-0330	1037354	12.50	2.75	1.88	1.75	1.13	.69	.53	.08	.19
5/8	CX05-0331	1037372	34.50	3.50	2.25	2.38	1.38	.91	.66	.13	.34
3/4	CX05-0332	1037390	47.10	3.75	2.50	2.69	1.63	1.08	.78	.14	.34
7/8	CX05-0333	1037416	84.60	5.00	3.50	3.19	1.88	1.27	.94	.16	.44
1	CX05-0334	1037434	97.50	5.69	4.25	3.75	2.50	1.39	1.06	.16	.41
1 1/8 - 1 1/4	CX05-0335	1037452	175.00	6.25	4.50	4.31	2.75	1.75	1.31	.22	.50

Extra Heavy Wire Rope Thimbles

G-414
& **SS-414**

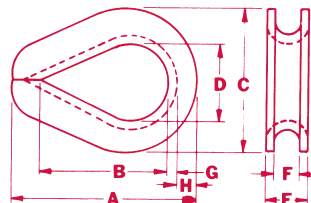

- A rugged rope thimble recommended for heavy duty service.
- Available in Hot Dip galvanized or Stainless Steel.

G-414 meets the performance requirements of Federal Specification FF-T-276b Type III, except for those provisions required of the contractor.

Rope Dia (in.)	Stock No.				Weight Per 100 (lbs.)	Dimensions (in.)							
	CERTEX Cat. Ref. No.	Crosby G-414 Galv.	CERTEX Cat. Ref. No.	Crosby SS-414 Stainless		A	B	C	D	E	F	G	H
* 1/4	CX05-0336	1037639	CX05-0353	1037960	6.50	2.19	1.63	1.50	.88	.41	.28	.06	.23
* 5/16	CX05-0337	1037657	CX05-0354	1037988	11.80	2.50	1.88	1.81	1.06	.50	.34	.08	.28
* 3/8	CX05-0338	1037675	CX05-0355	1038004	21.60	2.88	2.13	2.13	1.13	.63	.41	.11	.34
7/16	CX05-0339	1037693	—	—	34.70	3.25	2.38	2.38	1.25	.72	.47	.13	.38
* 1/2	CX05-0340	1037719	CX05-0356	1038022	51.00	3.63	2.75	2.75	1.50	.81	.53	.14	.41
9/16	CX05-0341	1037737	—	—	51.00	3.63	2.75	2.69	1.50	.88	.59	.14	.41
* 5/8	CX05-0342	1037755	CX05-0357	1038040	75.70	4.25	3.25	3.13	1.75	.97	.66	.16	.50
* 3/4	CX05-0343	1037773	CX05-0655	1038068	158.10	5.00	3.75	3.81	2.00	1.22	.78	.22	.66
7/8	CX05-0344	1037791	—	—	177.80	5.50	4.25	4.25	2.25	1.38	.94	.22	.75
* 1	CX05-0345	1037817	—	—	313.90	6.13	4.50	4.94	2.50	1.56	1.06	.25	.88
1 1/8 - 1 1/4	CX05-0346	1037835	—	—	400.00	7.00	5.13	5.88	2.88	1.81	1.31	.25	1.13
1 1/4 - 1 3/8	CX05-0347	1037853	—	—	811.00	9.06	6.50	6.81	3.50	2.19	1.44	.38	1.13
1 3/8 - 1 1/2	CX05-0348	1037871	—	—	1294.80	9.00	6.25	7.13	3.50	2.56	1.56	.50	1.13
1 5/8	CX05-0349	1037899	—	—	1700.00	11.25	8.00	8.13	4.00	2.72	1.72	.50	1.38
1 3/4	CX05-0350	1037915	—	—	1775.00	12.19	9.00	8.50	4.50	2.84	1.84	.50	1.31
1 7/8 - 2	CX05-0351	1037933	—	—	2775.00	15.13	12.00	10.38	6.00	3.09	2.09	.50	1.50
2 1/4	CX05-0352	1037951	—	—	3950.00	17.13	14.00	11.88	7.00	3.63	2.38	.63	1.63

* SS-414 sizes available in stainless steel type 304.

WIRE ROPE THIMBLES

The Crosby Group, Inc.

Solid Wire Rope Thimbles

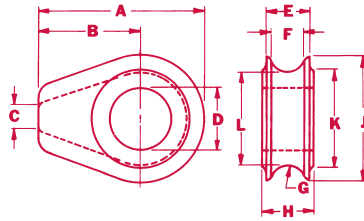
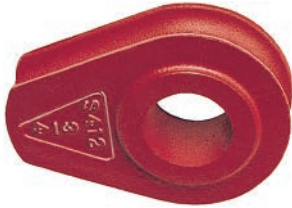

- Fits pin for open wire rope socket, boom pendant clevis and wedge socket.

Rope Dia. (in.)	CERTEX Cat. Ref. No.	Crosby S-412 S.C. Stock No.	Weight Each (lbs.)	Dimensions (in.)											
				A	B	C	D	E	F	G	H	J	K	L	
†1/2	CX05-0358	1037121	.61	2.81	1.75	.25	1.06	.75	.56	.28	.88	2.13	1.63	1.56	
†5/8	CX05-0359	1037149	2.21	4.69	3.00	.38	1.31	1.06	.81	.41	1.13	3.38	2.25	2.56	
†3/4	CX05-0360	1037167	2.32	4.69	3.00	.38	1.50	1.06	.81	.41	1.38	3.38	2.25	2.56	
†7/8	CX05-0361	1037185	5.45	6.06	3.81	.50	1.75	1.38	1.06	.53	1.63	4.50	3.25	3.44	
†1	CX05-0362	1037201	5.25	6.06	3.81	.50	2.13	1.38	1.06	.53	1.81	4.50	3.25	3.44	
†1 1/8	CX05-0363	1037229	9.29	7.25	4.56	.63	2.38	1.75	1.31	.66	2.06	5.38	3.88	4.06	
†1 1/4 - 1 3/8	CX05-0364	1037247	9.81	7.25	4.56	.63	2.63	1.94	1.53	.78	2.31	5.38	3.88	4.13	

† Cast Ductile Iron.

NEWCO Manufacturing Company, Inc.

Slip-Thru Thimbles

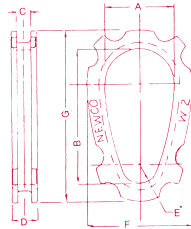

NEWCO SLIP-THRU THIMBLES are designed to allow passage of an identical thimble through its eye. This is a necessity when a regular sling is used as a choker sling. SLIP-THRU THIMBLES also prevent the eye of the sling from mashing together and the top of the eye wearing excessively. The generous inside Dimensions allow the thimbles to fit large crane hooks. Rope retention ears are tapered so they can be bent or peened over wire rope.

CERTEX Cat. Ref. No.	NEWCO No.	Sling Size			Dimensions							Wt. Lbs.
		Single	8 Pts.	6 Pts.	A	B	C	D	E	F	G	
CX05-0365	W-2	5/16-3/8	3/32-1/8	3/32-1/8	2 1/8	4 1/8	7/16	13/16	9/16	3 1/4	5 1/4	1.3
CX05-0366	W-3	1/2-9/16	3/16	3/16	2 3/8	4 3/8	5/8	1	5/8	4	6	1.5
CX05-0367	W-4	5/8-3/4	1/4	1/4-5/16	3 3/8	6 5/8	13/16	1 5/16	5/8	5 3/8	8 1/2	3.11
CX05-0368	W-5	7/8-1	5/16	3/8	3 3/4	7 1/8	1 1/8	1 5/8	7/8	6 1/4	9 3/8	5.5
CX05-0369	W-6	1 1/8-1 1/4	3/8	7/16	4 3/8	8 3/8	1 3/8	1 7/8	1	7 1/8	11	8.6
CX05-0370	W-7	1 3/8-1 1/2	7/16-1/2	1/2	5	9 1/2	1 5/8	2 1/8	1 1/4	8 1/8	12 1/2	10
CX05-0371	W-8	1 5/8-1 3/4	9/16	5/8	6 3/4	11 3/4	1 13/16	2 9/16	1 7/16	9 3/8	14 3/4	17.6
CX05-0372	W-9	1 7/8-2	5/8	3/4	8	14 1/2	2 1/8	3 1/4	1 7/8	13	19 1/4	53
CX05-0373	W-10	2 1/8-2 1/4	3/4	7/8-1	8 1/2	15 1/2	2 1/2	3 3/4	2	13	20 3/8	66
CX05-0374	W-11	2 1/2-3	7/8-1	1 1/8	9	18 1/2	3 3/16	4 11/16	2 1/2	15 3/4	24 3/4	126

Casing and Choker Thimbles



The No. 83 Casing Thimble has been designed for the oil industry. The Choker Thimbles, No. 82, No. 84, No. 85, No. 86 and No. 87 are designed especially for braided choker slings. The ears can be peened over to retain wire rope.

CERTEX Cat. Ref. No.	NEWCO No.	Sling Size		Fits Choker Hook	Dimensions										Wt. Lbs.
		6Pt	8Pt		A	B	C	D	E	F	G	H ^r			
CX05-0375	82	1/8	1/8	#2	1/2	7/8	1 1/4	2 1/8	3 1/4	1/4	3/8	5/16	.7		
CX05-0376	*83	1/4	3/16	#3	5/8	1	1 1/2	2 1/2	3 7/8	1/4	1/2	3/8	1.1		
CX05-0377	84	5/16	1/4	#4	13/16	1 5/16	1 3/4	2 7/8	4 7/16	5/16	5/8	7/16	1.8		
CX05-0378	85	3/8	5/16	#5	15/16	1 7/16	2	3 1/4	5	5/16	3/4	1/2	2.2		
CX05-0379	86	7/16	3/8	#6	1 1/8	1 11/16	2 1/4	3 5/8	5 3/4	3/8	7/8	9/16	3.3		
CX05-0380	87	1/2	7/16	#7	1 3/8	1 15/16	2 3/4	4 1/16	6 3/8	3/8	1	11/16	4.7		

ALLOY MASTER LINKS

The Crosby Group, Inc.



A-342
Alloy Master
Links

- Alloy Steel — Quenched and Tempered.
- Individually Proof Tested to values shown, with certification.
- Proof Tested with 60% inside width special fixtures sized to prevent localized point loading per ASME A-952.
- Forgings have a Product Identification Code (PIC) for material traceability, along with the size, the name Crosby and USA in raised lettering.
- Selected sizes designated with “W” in the size column have enlarged inside dimensions to allow additional room for sling hardware and crane hook.
- Crosby 1 ¼” to 2” 342/345 master links are type approved to DNV Certification Notes 2.7-1- Offshore Containers. These Crosby master links are 100% proof tested, MPI and impact tested. The tests are conducted by Crosby and 3.1 test certification is available upon request. Refer to Crosby Catalog for COLD TUFF® master links that meet the additional requirements of DNV rules for certification of lifting appliances - Loose Gear.
- Incorporates patented **QUIC-CHECK®** deformation indicators.

Size		Crosby A-342 Stock No	Weight Each (lbs.)	Working Load Limit (lbs.)*	Proof Load (lbs.)**	Dimensions (in.)			
(in.)	(mm)					A	B	C	Deformation Indicator
1/2W	13W	1014266	1.3	7400	17200	.62	2.80	5.00	3.50
5/8	16	1014280	1.5	9000	18000	.62	3.00	6.00	3.50
3/4W	19W	1014285	2.0	12300	28400	.73	3.20	6.00	4.00
7/8W	22W	1014319	3.3	15200	35200	.88	3.75	6.38	4.50
1W	26W	1014331	6.1	26000	60000	1.10	4.30	7.50	5.50
1-1/4W	32W	1014348	12.0	39100	90400	1.33	5.50	9.50	7.00
† 1-1/4W	† 32W	1262505	9.2	† 36200	90500	1.25	4.38	8.75	5.50
1-1/2W	38W	1014365	18.6	† 61100	141200	1.61	5.90	10.50	6.50
† 1-1/2W	† 38W	1262514	15.9	54300	135750	1.50	5.25	10.50	7.50
1-3/4	44	1014388	25.2	84900	212250	1.75	6.00	12.00	7.50
† 1-3/4	† 44	1262523	24.8	† 84900	212250	1.75	6.00	12.00	7.50
2	51	1014404	37.0	102600	256500	2.00	7.00	14.00	9.00
† 2	† 51	1262532	37.7	† 102600	256500	2.00	7.00	14.00	9.00
2-1/4	57	1014422	54.1	143100	289200	2.25	8.00	16.00	10.00
2-1/2	63	1014468	68.5	160000	320000	2.50	8.38	16.00	11.00
2-3/4	70	1014440	94.0	216900	433800	2.75	9.88	18.00	12.50
3	76	1014486	115	228000	456000	3.00	9.88	18.00	13.00
3-1/4	83	1014501	145	262200	524400	3.25	10.00	20.00	13.50
3-1/2	89	1014529	200	279000	558000	3.50	12.00	24.00	15.50
3-3/4	95	1015051	198	336000	672000	3.75	10.00	20.00	13.50
4	102	1015060	264	373000	746000	4.00	12.00	24.00	16.00
†† 4-1/4	†† 108	1015067	302	354000	708000	4.25	12.00	24.00	—
†† 4-1/2	†† 114	1015079	345	360000	720000	4.50	14.00	28.00	—
†† 4-3/4	†† 121	1015088	436	389000	778000	4.75	14.00	28.00	—
†† 5	†† 127	1015094	516	395000	790000	5.00	15.00	30.00	—

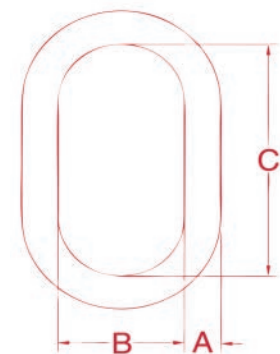

Meets or exceeds all requirements of ASME B30.26 including identification, ductility, design factor, proof load and temperature requirements. Importantly, these links meet other critical performance requirements including fatigue life, impact properties and material traceability, not addressed by ASME B30.26.

*Ultimate Load is 5 times the Working Load Limit. Based on single leg sling (in-line load), or resultant load on multiple legs with an included angle less than or equal to 120 degrees. Applications with wire rope and synthetic sling generally require a design factor of 5. **Proof Test Load equals or exceeds the requirement of ASTM A952(8.1) and ASME B30.9. †Ultimate Load is 4 times the Working Load Limit for Offshore Container Master Links. †Offshore Container Master Links Proof Tested to 2.5 times the Working Load Limit with 70 percent fixtures.

TURNBUCKLES

The Crosby Group, Inc.



HG-223
Hook & Hook

Meets the performance requirements of Federal Specifications FF-T791b, Type 1, Form 1 — Class 5, except for those provisions required of the contractor.



HG-225
Hook & Eye

Meets the performance requirements of Federal Specifications FF-T791b, Type 1, Form 1 — Class 6, except for those provisions required of the contractor.



HG-226
Eye & Eye

Meets the performance requirements of Federal Specifications FF-T791b, Type 1, Form 1 — Class 4, except for those provisions required of the contractor.



HG-227
Jaw & Eye

Meets the performance requirements of Federal Specifications FF-T791b, Type 1, Form 1 — Class 8, except for those provisions required of the contractor.



HG-228
Jaw & Jaw

Meets the performance requirements of Federal Specifications FF-T791b, Type 1, Form 1 — Class 7, except for those provisions required of the contractor.

- Hot Dip galvanized.
- End fittings are Quenched and Tempered, bodies heat treated by normalizing.
- Hooks are forged with a greater cross sectional area that results in a stronger hook with better fatigue properties.
- Modified UNJ thread for improved fatigue properties.
- Turnbuckle eyes are forged elongated, by design, to maximize easy attachment in system and minimize stress in the eye. For turnbuckle sizes 1/4" through 2 1/2", a shackle one size smaller can be reeved through eye.
- Forged jaw ends are fitted with bolts and nuts on sizes 1/4" through 5/8", and pins and cotters on sizes 3/4" through 2 3/4".
- TURNBUCKLES RECOMMENDED FOR STRAIGHT OR IN-LINE PULL ONLY.
- Lock Nuts available for all sizes.
- Crosby's Quenched and Tempered end fittings and normalized bodies have enhanced impact properties for greater toughness at all temperatures.
- Typical hardness levels, Tensile Strengths and Ductility Properties are available for all sizes.
- Turnbuckles can be furnished proof tested or magnaflux inspected with certificates if requested at time of order.
- Turnbuckle assembly combinations include: Eye and Eye, Hook and Hook, Hook and Eye, Jaw and Jaw, Jaw and Eye.

TURNBUCKLES

The Crosby Group, Inc.

HG-223 Hook & Hook

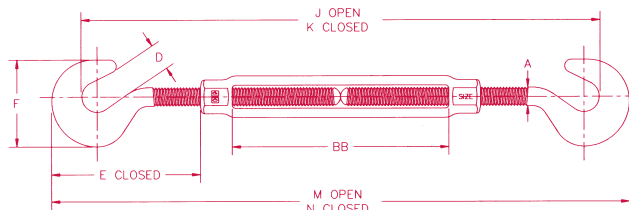

- Hot Dip galvanized steel.
- End fittings are Quenched and Tempered, bodies heat treated by normalizing.
- Hooks are forged with a greater cross sectional area that results in a stronger hook with better fatigue properties.
- TURNBUCKLES RECOMMENDED FOR STRAIGHT OR IN-LINE PULLS ONLY.
- Modified UNJ thread for improved fatigue properties.
- Lock Nuts available for all sizes.

Thread Diameter & Take Up (in.)	CERTEX Cat. Ref. No.	Crosby Stock No. Galv.	Working Load Limit* (lbs.)	Weight Each (lbs.)	Dimensions (in.)								
					A	D	E Closed	F	J Open	K Closed	M Open	N Closed	BB
1/4 x 4	CX05-0423	1030011	400	.30	.25	.45	1.59	1.27	11.12	7.12	11.94	7.94	4.00
5/16 x 4 1/2	CX05-0424	1030039	700	.47	.31	.50	1.94	1.50	12.81	8.31	13.81	9.31	4.50
3/8 x 6	CX05-0425	1030057	1000	.78	.38	.56	2.30	1.77	16.50	10.50	17.72	11.72	6.00
1/2 x 6	CX05-0426	1030075	1500	1.60	.50	.66	2.94	2.28	17.82	11.82	19.38	13.38	6.00
1/2 x 9	CX05-0427	1030093	1500	1.83	.50	.66	2.94	2.28	23.82	14.82	25.38	16.38	9.00
1/2 x 12	CX05-0428	1030119	1500	2.28	.50	.66	2.94	2.28	29.82	17.82	31.38	19.38	12.00
5/8 x 6	CX05-0429	1030137	2250	2.75	.63	.84	3.69	2.81	19.25	13.25	21.25	15.25	6.00
5/8 x 9	CX05-0430	1030155	2250	3.38	.63	.84	3.69	2.81	25.25	16.25	27.25	18.25	9.00
5/8 x 12	CX05-0431	1030173	2250	3.50	.63	.84	3.69	2.81	31.25	19.25	33.25	21.25	12.00
3/4 x 6	CX05-0432	1030191	3000	3.89	.75	.98	4.52	3.33	20.88	14.88	23.28	17.28	6.00
3/4 x 9	CX05-0433	1030217	3000	5.28	.75	.98	4.52	3.33	26.88	17.88	29.28	20.28	9.00
3/4 x 12	CX05-0434	1030235	3000	5.43	.75	.98	4.52	3.33	32.88	20.88	35.28	23.28	12.00
3/4 x 18	CX05-0435	1030253	3000	6.33	.75	.98	4.52	3.33	44.88	26.88	47.28	29.28	18.00
7/8 x 12	CX05-0436	1030271	4000	8.10	.88	1.13	5.19	3.78	34.25	22.25	37.00	25.00	12.00
7/8 x 18	CX05-0437	1030299	4000	9.95	.88	1.13	5.19	3.78	46.25	28.25	49.00	31.00	18.00
1 x 6	CX05-0438	1030315	5000	9.33	1.00	1.25	5.84	4.25	23.63	17.63	26.69	20.69	6.00
1 x 12	CX05-0439	1030333	5000	11.93	1.00	1.25	5.84	4.25	35.63	23.63	38.69	26.69	12.00
1 x 18	CX05-0440	1030351	5000	14.00	1.00	1.25	5.84	4.25	47.63	29.63	50.69	32.69	18.00
1 x 24	CX05-0441	1030379	5000	17.25	1.00	1.25	5.84	4.25	59.63	35.63	62.69	38.69	24.00
1 1/4 x 12	CX05-0442	1030397	6500	20.58	1.25	1.50	7.22	5.13	37.94	25.94	41.56	29.56	12.00
1 1/4 x 18	CX05-0443	1030413	6500	23.00	1.25	1.50	7.22	5.13	49.94	31.94	53.56	35.56	18.00
1 1/4 x 24	CX05-0444	1030431	6500	27.00	1.25	1.50	7.22	5.13	61.94	37.94	65.56	41.56	24.00
1 1/2 x 12	CX05-0445	1030459	7500	27.50	1.50	1.88	8.34	5.75	40.94	28.94	44.44	32.44	12.00
1 1/2 x 18	CX05-0446	1030477	7500	31.00	1.50	1.88	8.34	5.75	52.96	34.94	56.44	38.44	18.00
1 1/2 x 24	CX05-0447	1030495	7500	37.50	1.50	1.88	8.34	5.75	64.94	40.94	68.44	44.44	24.00

* Proof Load is 2.5 times Working Load Limit. Ultimate load is 5 times Working Load Limit. Meets the performance requirements of Federal Specifications FF-T-791b, Type 1 Form 1 — CLASS 5, except for those provisions required of the contractor.

TURNBUCKLES

The Crosby Group, Inc.

HG-225 Hook & Eye

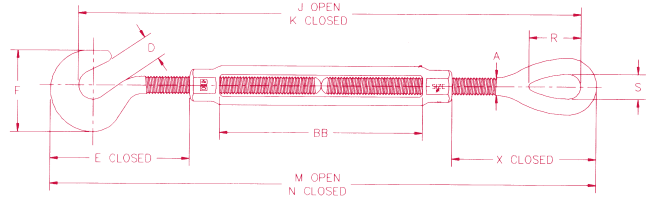

- Hot Dip galvanized steel.
- End fittings are Quenched and Tempered, bodies heat treated by normalizing.
- Turnbuckle eyes are forged elongated, by design, to maximize easy attachment in system and minimize stress in the eye. For turnbuckles sizes 1/4" through 2 1/2", a shackle one size smaller can be reeved through eye.
- Turnbuckle hooks are forged with a greater cross sectional area that results in a stronger hook with better fatigue properties.
- TURNBUCKLES RECOMMENDED FOR STRAIGHT OR IN-LINE PULL ONLY.
- Modified UNJ thread for improved fatigue properties.
- Lock Nuts available for all sizes.

Meets the performance requirements of Federal Specifications FF-T-791b, Type 1, Form 1 — CLASS 6, except for those provisions required of the contractor.

Thread Diameter & Take Up (in.)	CERTEX Cat. Ref. No.	Crosby Stock No. Galv.	Working Load Limit* (lbs.)	Weight Each (lbs.)	Dimensions (in.)											
					A	D	E Closed	F	J Open	K Closed	M Open	N Closed	R	S	X Closed	BB
1/4 x 4	CX05-0448	1030636	400	.29	.25	.45	1.59	1.27	11.46	7.46	12.09	8.09	.78	.34	1.75	4.00
5/16 x 4 1/2	CX05-0449	1030654	700	.49	.31	.50	1.94	1.50	13.19	8.69	13.47	9.47	.94	.44	2.09	4.50
3/8 x 6	CX05-0450	1030672	1000	.78	.38	.56	2.30	1.77	16.98	10.98	17.94	11.94	1.12	.53	2.52	6.00
1/2 x 6	CX05-0451	1030690	1500	1.61	.50	.66	2.94	2.28	18.45	12.45	19.67	13.67	1.44	.72	3.23	6.00
1/2 x 9	CX05-0452	1030716	1500	1.85	.50	.66	2.94	2.28	24.45	15.45	25.67	16.67	1.44	.72	3.23	9.00
1/2 x 12	CX05-0453	1030734	1500	2.26	.50	.66	2.94	2.28	30.45	18.45	31.67	19.67	1.44	.72	3.23	12.00
5/8 x 6	CX05-0454	1030752	2250	2.70	.63	.84	3.69	2.81	19.96	13.96	21.47	15.47	1.75	.88	3.90	6.00
5/8 x 9	CX05-0455	1030770	2250	3.13	.63	.84	3.69	2.81	25.96	16.96	27.47	18.47	1.75	.88	3.90	9.00
5/8 x 12	CX05-0456	1030798	2250	3.78	.63	.84	3.69	2.81	31.96	19.96	33.47	21.47	1.75	.88	3.90	12.00
3/4 x 6	CX05-0457	1030814	3000	3.89	.75	.98	4.52	3.33	21.63	15.63	23.45	17.45	2.09	1.00	4.69	6.00
3/4 x 9	CX05-0458	1030832	3000	4.61	.75	.98	4.52	3.33	27.63	18.63	29.45	20.45	2.09	1.00	4.69	9.00
3/4 x 12	CX05-0459	1030850	3000	5.83	.75	.98	4.52	3.33	33.63	21.63	35.45	23.45	2.09	1.00	4.69	12.00
3/4 x 18	CX05-0460	1030878	3000	6.33	.75	.98	4.52	3.33	45.63	27.63	47.45	29.45	2.09	1.00	4.69	18.00
7/8 x 12	CX05-0461	1030896	4000	8.10	.88	1.13	5.19	3.78	34.78	22.78	36.91	24.91	2.38	1.25	5.10	12.00
7/8 x 18	CX05-0462	1030912	4000	9.95	.88	1.13	5.19	3.78	46.78	28.78	48.91	30.91	2.38	1.25	5.10	18.00
1 x 6	CX05-0463	1030930	5000	9.33	1.00	1.25	5.84	4.25	24.80	18.80	27.20	21.20	3.00	1.44	6.36	6.00
1 x 12	CX05-0464	1030958	5000	11.93	1.00	1.25	5.84	4.25	36.80	24.80	39.20	27.20	3.00	1.44	6.36	12.00
1 x 18	CX05-0465	1030976	5000	14.00	1.00	1.25	5.84	4.25	48.80	30.80	51.20	33.20	3.00	1.44	6.36	18.00
1 x 24	CX05-0466	1030994	5000	17.25	1.00	1.25	5.84	4.25	60.80	36.80	63.20	39.20	3.00	1.44	6.36	24.00
1 1/4 x 12	CX05-0467	1031010	6500	19.00	1.25	1.50	7.22	5.13	39.13	27.13	42.06	30.06	3.56	1.81	7.72	12.00
1 1/4 x 18	CX05-0468	1031038	6500	23.00	1.25	1.50	7.22	5.13	51.13	33.13	54.06	36.06	3.56	1.81	7.72	18.00
1 1/4 x 24	CX05-0469	1031056	6500	24.00	1.25	1.50	7.22	5.13	63.13	39.13	66.06	42.06	3.56	1.81	7.72	24.00
1 1/2 x 12	CX05-0470	1031074	7500	27.50	1.50	1.88	8.34	5.75	41.72	29.72	44.72	32.72	4.06	2.12	8.62	12.00
1 1/2 x 18	CX05-0471	1031092	7500	31.00	1.50	1.88	8.34	5.75	53.72	35.72	56.72	38.72	4.06	2.12	8.62	18.00
1 1/2 x 24	CX05-0472	1031118	7500	37.50	1.50	1.88	8.34	5.75	65.72	41.72	68.72	44.72	4.06	2.12	8.62	24.00

* Proof Load is 2.5 times Working Load Limit. Ultimate load is 5 times Working Load Limit.

TURNBUCKLES

The Crosby Group, Inc.

HG-226 Eye & Eye

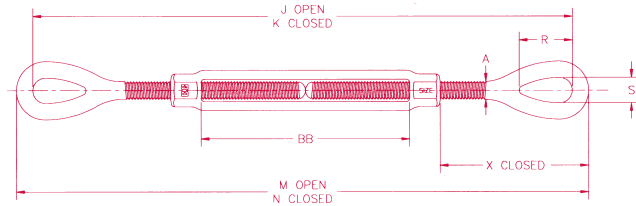

- Hot Dip galvanized steel.
- End fittings are Quenched and Tempered, bodies heat treated by normalizing.
- Modified UNJ thread for improved fatigue properties.
- Turnbuckle eyes are forged elongated, by design, to maximize easy attachment in system and minimize

stress in the eye. For turnbuckle sizes 1/4" through 2 1/2", a shackle one size smaller can be reeved through eye.

- TURNBUCKLES RECOMMENDED FOR STRAIGHT OR IN-LINE PULL ONLY.
- Lock Nuts available for all sizes.

Meets the performance requirements of Federal Specifications FF-T-791b, Type 1, Form 1 — CLASS 4, except for those provisions required of the contractor.

Thread Diameter & Take Up (in.)	CERTEX Cat. Ref. No.	Crosby Stock No Galv.	Working Load Limit* (lbs.)	Weight Each (lbs.)	Dimensions (in.)									
					A	J Open	K Closed	M Open	N Closed	R	S	X Closed	BB	
1/4 x 4	CX05-0473	1031252	500	.26	.25	11.80	7.80	12.25	8.25	.78	.34	1.75	4.00	
5/16 x 4 1/2	CX05-0474	1031270	800	.45	.31	13.56	9.06	14.12	9.62	.94	.44	2.09	4.50	
3/8 x 6	CX05-0475	1031298	1200	.76	.38	17.47	11.47	18.16	12.16	1.12	.53	2.52	6.00	
1/2 x 6	CX05-0476	1031314	2200	1.54	.50	19.08	13.08	19.96	13.96	1.44	.72	3.23	6.00	
1/2 x 9	CX05-0477	1031332	2200	1.13	.50	25.08	16.08	25.96	16.96	1.44	.72	3.23	9.00	
1/2 x 12	CX05-0478	1031350	2200	2.14	.50	31.08	19.08	31.96	19.96	1.44	.72	3.23	12.00	
5/8 x 6	CX05-0479	1031378	3500	3.28	.63	20.68	14.68	21.68	15.68	1.75	.88	3.90	6.00	
5/8 x 9	CX05-0480	1031396	3500	2.83	.63	26.68	17.68	27.68	18.68	1.75	.88	3.90	9.00	
5/8 x 12	CX05-0481	1031412	3500	3.42	.63	32.68	20.68	33.68	21.68	1.75	.88	3.90	12.00	
3/4 x 6	CX05-0482	1031430	5200	3.79	.75	22.38	16.38	23.62	17.62	2.09	1.00	4.69	6.00	
3/4 x 9	CX05-0483	1031458	5200	4.61	.75	28.38	19.38	29.62	20.62	2.09	1.00	4.69	9.00	
3/4 x 12	CX05-0484	1031476	5200	5.48	.75	34.38	22.38	35.62	23.62	2.09	1.00	4.69	12.00	
3/4 x 18	CX05-0485	1031494	5200	7.19	.75	46.38	28.38	47.62	29.62	2.09	1.00	4.69	18.00	
7/8 x 12	CX05-0486	1031519	7200	7.22	.88	35.32	23.32	36.82	24.82	2.38	1.25	5.10	12.00	
7/8 x 18	CX05-0487	1031537	7200	9.95	.88	47.32	29.32	48.82	30.82	2.38	1.25	5.10	18.00	
1 x 6	CX05-0488	1031555	10000	9.04	1.00	25.97	19.97	27.72	21.72	3.00	1.44	6.36	6.00	
1 x 12	CX05-0489	1031573	10000	11.50	1.00	37.97	25.97	39.97	27.72	3.00	1.44	6.36	12.00	
1 x 18	CX05-0490	1031591	10000	14.00	1.00	49.97	31.97	51.72	33.72	3.00	1.44	6.36	18.00	
1 x 24	CX05-0491	1031617	10000	17.25	1.00	61.97	37.97	63.72	39.72	3.00	1.44	6.36	24.00	
1 1/4 x 12	CX05-0492	1031635	15200	19.00	1.25	40.31	28.31	42.56	30.56	3.56	1.81	7.72	12.00	
1 1/4 x 18	CX05-0493	1031653	15200	23.00	1.25	52.31	34.31	54.56	36.56	3.56	1.81	7.72	18.00	
1 1/4 x 24	CX05-0494	1031671	15200	27.00	1.25	64.31	40.31	66.56	42.56	3.56	1.81	7.72	24.00	
1 1/2 x 12	CX05-0495	1031699	21400	27.50	1.50	42.50	30.50	45.00	33.00	4.06	2.12	8.62	12.00	
1 1/2 x 18	CX05-0496	1031715	21400	31.00	1.50	54.50	36.50	57.00	39.00	4.06	2.12	8.62	18.00	
1 1/2 x 24	CX05-0497	1031733	21400	37.50	1.50	66.50	42.50	69.00	45.00	4.06	2.12	8.62	24.00	
1 3/4 x 18	CX05-0498	1031779	28000	52.50	1.75	57.38	39.38	60.38	42.38	4.62	2.38	10.00	18.00	
1 3/4 x 24	CX05-0499	1031797	28000	58.00	1.75	69.38	45.38	72.38	48.38	4.62	2.38	10.00	24.00	
2 x 24	CX05-0500	1031813	37000	85.25	2.00	75.69	51.69	79.19	55.19	5.75	2.69	13.09	24.00	
2 1/2 x 24	CX05-0501	1031831	60000	144.25	2.50	78.62	54.62	82.62	58.62	6.50	3.12	13.78	24.00	
2 3/4 x 24	CX05-0502	1031859	75000	194.00	2.75	81.00	57.00	85.50	61.50	7.00	3.25	15.22	24.00	

* Proof Load is 2.5 times Working Load Limit. Ultimate load is 5 times Working Load Limit.

TURNBUCKLES

The Crosby Group, Inc.

HG-227 Jaw & Eye

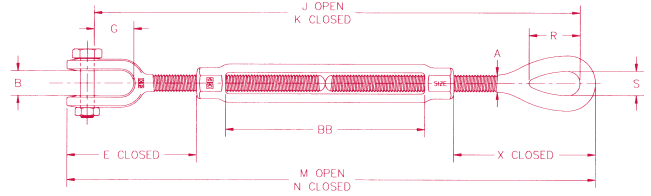

- Hot Dip galvanized steel.
- End fittings are Quenched and Tempered, bodies heat treated by normalizing.
- Turnbuckle eyes are forged and elongated, by design, to maximize easy attachment in system and minimize stress in the eye. For turnbuckle sizes 1/4" through 2 1/2", a shackle one size smaller can be reeved through eye.
- Forged jaw ends are fitted with bolts and nuts for 1/4" through 5/8", and pins and cotters on 3/4" through 2 3/4" sizes.
- Modified UNJ thread for improved fatigue properties.
- TURNBUCKLES RECOMMENDED FOR STRAIGHT OR IN-LINE PULL ONLY.
- Lock Nuts available for all sizes.

Meets the performance requirements of Federal Specifications FF-T-791b, Type 1, Form 1—CLASS 8, except for those provisions required of the contractor.

Thread Diameter & Take Up (in.)	CERTEX Cat. Ref. No.	Crosby Stock No. wGalv.	Working Load Limit* (lbs.)	Weight Each (lbs.)	Dimensions (in.)											
					A	B	E Closed	G	J Open	K Closed	M Open	N Closed	R	S	X Closed	BB
1/4 x 4	CX05-0503	1031877	500	.30	.25	.41	1.58	.62	11.35	7.35	12.07	8.07	.78	.34	1.75	4.00
5/16 x 4 1/2	CX05-0504	1031895	800	.50	.31	.47	1.98	.87	13.71	8.71	14.01	9.51	.94	.44	2.09	4.50
3/8 x 6	CX05-0505	1031911	1200	.80	.38	.50	2.12	.87	16.81	10.81	17.77	11.77	1.12	.53	2.52	6.00
1/2 x 6	CX05-0506	1031939	2200	1.51	.50	.63	2.75	1.06	18.29	12.29	19.48	13.48	1.44	.72	3.23	6.00
1/2 x 9	CX05-0507	1031957	2200	1.71	.50	.63	2.75	1.06	24.29	15.29	25.48	16.48	1.44	.72	3.23	9.00
1/2 x 12	CX05-0508	1031975	2200	2.08	.50	.63	2.75	1.06	30.29	18.29	31.48	19.48	1.44	.72	3.23	12.00
5/8 x 6	CX05-0509	1031993	3500	2.35	.63	.75	3.50	1.31	19.74	13.74	21.28	15.28	1.75	.88	3.90	6.00
5/8 x 9	CX05-0510	1032019	3500	3.17	.63	.75	3.50	1.31	25.74	16.74	27.28	18.28	1.75	.88	3.90	9.00
5/8 x 12	CX05-0511	1032037	3500	3.61	.63	.75	3.50	1.31	31.74	19.74	33.28	21.28	1.75	.88	3.90	12.00
3/4 x 6	CX05-0512	1032055	5200	4.00	.75	.94	4.18	1.50	21.19	15.19	23.11	17.11	2.09	1.00	4.69	6.00
3/4 x 9	CX05-0513	1032073	5200	4.75	.75	.94	4.18	1.50	27.19	18.19	29.11	20.11	2.09	1.00	4.69	9.00
3/4 x 12	CX05-0514	1032091	5200	5.93	.75	.94	4.18	1.50	33.19	21.19	35.11	23.11	2.09	1.00	4.69	12.00
3/4 x 18	CX05-0515	1032117	5200	7.00	.75	.94	4.18	1.50	45.19	27.19	47.11	29.11	2.09	1.00	4.69	18.00
7/8 x 12	CX05-0516	1032135	7200	8.36	.88	1.13	4.85	1.75	34.34	22.34	36.57	24.57	2.38	1.25	5.10	12.00
7/8 x 18	CX05-0517	1032153	7200	9.75	.88	1.13	4.85	1.75	46.34	28.34	48.57	30.57	2.38	1.25	5.10	18.00
1 x 6	CX05-0518	1032171	10000	8.92	1.00	1.19	5.53	2.06	24.34	18.34	26.89	20.89	3.00	1.44	6.36	6.00
1 x 12	CX05-0519	1032199	10000	11.20	1.00	1.19	5.53	2.06	36.34	24.34	38.89	26.89	3.00	1.44	6.36	12.00
1 x 18	CX05-0520	1032215	10000	13.30	1.00	1.19	5.53	2.06	48.34	30.34	50.89	32.89	3.00	1.44	6.36	18.00
1 x 24	CX05-0521	1032233	10000	17.00	1.00	1.19	5.53	2.06	60.34	36.34	62.89	38.89	3.00	1.44	6.36	24.00
1 1/4 x 12	CX05-0522	1032251	15200	19.42	1.25	1.75	7.21	2.81	38.82	26.82	42.05	30.05	3.56	1.81	7.72	12.00
1 1/4 x 18	CX05-0523	1032279	15200	24.18	1.25	1.75	7.21	2.81	50.82	32.82	54.05	36.05	3.56	1.81	7.72	18.00
1 1/4 x 24	CX05-0524	1032297	15200	28.50	1.25	1.75	7.21	2.81	62.82	38.82	66.05	42.05	3.56	1.81	7.72	24.00
1 1/2 x 12	CX05-0525	1032313	21400	28.99	1.50	2.06	7.88	2.81	40.50	28.50	44.25	32.25	4.06	2.12	8.62	12.00
1 1/2 x 18	CX05-0526	1032331	21400	35.00	1.50	2.06	7.88	2.81	52.50	34.50	56.25	38.25	4.06	2.12	8.62	18.00
1 1/2 x 24	CX05-0527	1032359	21400	39.18	1.50	2.06	7.88	2.81	64.50	40.50	68.25	44.25	4.06	2.12	8.62	24.00
1 3/4 x 18	CX05-0528	1032395	28000	53.75	1.75	2.38	9.40	3.38	55.38	37.38	59.78	41.78	4.62	2.38	10.00	18.00
1 3/4 x 24	CX05-0529	1032411	28000	60.68	1.75	2.38	9.40	3.38	67.38	43.38	71.78	47.78	4.62	2.38	10.00	24.00
2 x 24	CX05-0530	1032439	37000	89.00	2.00	2.50	11.86	3.69	72.62	48.62	77.95	53.95	5.75	2.69	13.09	24.00
2 1/2 x 24	CX05-0531	1032457	60000	150.00	2.50	2.88	13.56	4.44	75.80	51.80	82.40	58.40	6.50	3.12	13.78	24.00
2 3/4 x 24	CX05-0532	1032475	75000	183.00	2.75	3.50	15.22	4.19	77.88	53.88	85.50	61.50	7.00	3.25	15.22	24.00

* Proof Load is 2.5 times the Working Load Limit. Ultimate Load is 5 times Working Load Limit.

TURNBUCKLES

The Crosby Group, Inc.

HG-228 Jaw & Jaw

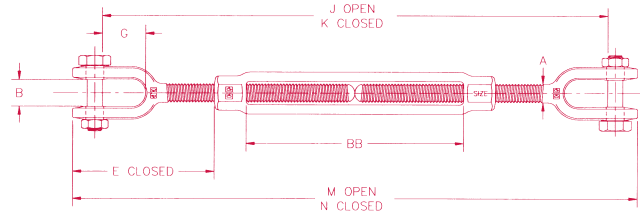

- Hot Dip galvanized steel.
- End fittings are Quenched and Tempered, bodies heat treated by normalizing.
- TURNBUCKLES RECOMMENDED FOR STRAIGHT OR IN-LINE PULL ONLY.
- Forged jaw ends are fitted with bolts and nuts for 1/4" through 5/8", and pins and cotters on 3/4" through 2 3/4" sizes.
- Modified UNJ thread for improved fatigue properties.
- Lock Nuts available for all sizes.

Meets the performance requirements of Federal Specifications FF-T-791b, Type 1, Form 1—CLASS 7, except for those provisions required for the contractor.

Thread Diameter & Take Up (in.)	CERTEX Cat. Ref. No.	Crosby Stock No. Galv.	Working Load Limit* (lbs.)	Weight Each (lbs.)	Dimensions (in.)									
					A	B	E Closed	G	J Open	K Closed	M Open	N Closed	BB	
1/4 x 4	CX05-0533	1032493	500	.36	.25	.41	1.58	.62	10.90	6.90	11.90	7.90	4.00	
5/16 x 4 1/2	CX05-0534	1032518	800	.52	.31	.47	1.98	.87	12.36	8.36	13.90	9.40	4.50	
3/8 x 6	CX05-0535	1032536	1200	.81	.38	.50	2.12	.87	16.14	10.14	17.38	11.38	6.00	
1/2 x 6	CX05-0536	1032554	2200	1.56	.50	.63	2.75	1.06	17.50	11.50	19.00	13.00	6.00	
1/2 x 9	CX05-0537	1032572	2200	1.74	.50	.63	2.75	1.06	23.50	14.50	25.00	16.00	9.00	
1/2 x 12	CX05-0538	1032590	2200	2.40	.50	.63	2.75	1.06	29.50	17.50	31.00	19.00	12.00	
5/8 x 6	CX05-0539	1032616	3500	2.72	.63	.75	3.50	1.31	18.80	12.80	20.88	14.88	6.00	
5/8 x 9	CX05-0540	1032634	3500	3.43	.63	.75	3.50	1.31	24.80	15.80	26.88	17.88	9.00	
5/8 x 12	CX05-0541	1032652	3500	3.91	.63	.75	3.50	1.31	30.80	18.80	32.88	20.88	12.00	
3/4 x 6	CX05-0542	1032670	5200	4.11	.75	.94	4.18	1.50	20.00	14.00	22.60	16.60	6.00	
3/4 x 9	CX05-0543	1032698	5200	5.46	.75	.94	4.18	1.50	26.00	17.00	28.60	19.60	9.00	
3/4 x 12	CX05-0544	1032714	5200	6.43	.75	.94	4.18	1.50	32.00	20.00	34.60	22.60	12.00	
3/4 x 18	CX05-0545	1032732	5200	8.07	.75	.94	4.18	1.50	44.00	26.00	46.60	28.60	18.00	
7/8 x 12	CX05-0546	1032750	7200	8.17	.88	1.13	4.85	1.75	33.36	21.36	36.32	24.32	12.00	
7/8 x 18	CX05-0547	1032778	7200	10.78	.88	1.13	4.85	1.75	45.36	27.36	48.32	30.32	18.00	
1 x 6	CX05-0548	1032796	10000	10.18	1.00	1.19	5.53	2.06	22.72	16.72	26.06	20.06	6.00	
1 x 12	CX05-0549	1032812	10000	12.52	1.00	1.19	5.53	2.06	34.72	22.72	38.06	26.06	12.00	
1 x 18	CX05-0550	1032830	10000	15.14	1.00	1.19	5.53	2.06	46.72	28.72	50.06	32.06	18.00	
1 x 24	CX05-0551	1032858	10000	18.08	1.00	1.19	5.53	2.06	58.72	34.72	62.06	38.06	24.00	
1 1/4 x 12	CX05-0552	1032876	15200	20.59	1.25	1.75	7.21	2.81	37.34	25.34	41.54	29.54	12.00	
1 1/4 x 18	CX05-0553	1032894	15200	24.68	1.25	1.75	7.21	2.81	49.34	31.34	53.54	35.54	18.00	
1 1/4 x 24	CX05-0554	1032910	15200	28.20	1.25	1.75	7.21	2.81	61.34	37.34	65.54	41.54	24.00	
1 1/2 x 12	CX05-0555	1032938	21400	30.69	1.50	2.06	7.88	2.81	38.50	26.50	43.50	31.50	12.00	
1 1/2 x 18	CX05-0556	1032956	21400	36.75	1.50	2.06	7.88	2.81	50.50	32.50	55.50	37.50	18.00	
1 1/2 x 24	CX05-0557	1032974	21400	40.67	1.50	2.06	7.88	2.81	62.50	38.50	67.50	43.50	24.00	
1 3/4 x 18	CX05-0558	1033018	28000	54.00	1.75	2.38	9.40	3.38	53.38	38.38	59.18	41.18	18.00	
1 3/4 x 24	CX05-0559	1033036	28000	63.36	1.75	2.38	9.40	3.38	65.38	41.38	71.18	47.18	24.00	
2 x 24	CX05-0560	1033054	37000	94.25	2.00	2.50	11.86	3.69	69.54	45.54	76.72	52.72	24.00	
2 1/2 x 24	CX05-0561	1033072	60000	165.00	2.50	2.88	13.56	4.44	72.98	48.98	82.18	58.18	24.00	
2 3/4 x 24	CX05-0562	1033090	75000	198.00	2.75	3.50	15.22	4.19	74.75	50.75	85.50	61.50	24.00	

* Proof Load is 2.5 times Working Load Limit. Ultimate load is 5 times Working Load Limit.

WIRE ROPE GRIPS

Klein Tools, Inc.

Klein "Haven" Grips



CERTEX Cat. Ref. No.	Klein Cat. No.	Minimum Cable Size – inches(mm)	Maximum Cable Size – inches (mm)	Maximum Safe Load – lbs (kg)	Approx. Weight Each – lbs. (kg)
CX05-0575	1604-10	14 B&S .06 (1.52)	2 B&S .25 (6.35)	2500 (1134)	1 (.45)
CX05-0576	1604-20	8 B&S .125 (3.18)	Steel Strand .50 (12.70)	5000 (2268)	2 1/2 (1.13)



CERTEX Cat. Ref. No.	Klein Cat. No.	Minimum Cable Size – inches (mm)	Maximum Cable Size – inches (mm)	Maximum Safe Load – lbs (kg)	Approx. Weight Each – lbs. (kg)
CX05-0577	1604-20L	8 B&S .125 (3.18)	Steel Strand .50 (12.70)	5000 (2268)	2 1/2 (1.13)



CERTEX Cat. Ref. No.	Klein Cat. No.	Minimum Cable Size – inches (mm)	Maximum Cable Size – inches (mm)	Maximum Safe Load – lbs (kg)	Approx. Weight Each – lbs. (kg)
CX05-0578	1625-20	1 B&S .28 (7.11)	Wire Rope .75 (19.05)	8000 (3629)	3 1/2 (1.59)
CX05-0579	1625-20 7/8	1 B&S .38 (9.65)	Wire Rope .88 (22.35)	8000 (3629)	3 1/2 (1.59)
CX05-0580	1625-20 1	1 B&S .50 (12.70)	Wire Rope 1.00 (25.40)	8000 (3629)	3 1/2 (1.59)

Designed for use when light, compact grip is desired and where conductor damage is not a factor. Gripping pressure of the knurled jaw is applied to 1/4" (6.35 mm) cable area.

1604-20L and 1625 series have a swing latch to help hold cable in the jaw.

OSHA Information

OSHA requires that all hand tools and equipment be maintained in good working order and that they be free from damage caused by wear or abuse (OSHA Part 1910, Subpart P, Section 1910.242).

In addition, OSHA Part 1926, Subpart V, Section 1926.955, paragraph 7 (ii) and 8 specifically state that:

"The manufacturer's load rating shall not be exceeded for stringing lines, pulling line sock connections, and all load-bearing hardware and accessories.

"Conductor grips shall not be used on wire rope unless designed for this application."

WIRE ROPE GRIPS

Lewis Snake Grips



The Lewis Snake Grip expands or contracts to grip different or identical cable and/or rope sizes as per the customer's needs.

SAVE time stringing up, changing and unstringing because the snake requires no special tools. The swivel and swing link go smoothly through blocks and prevent line twisting.

INSTALL new cable by using old existing cable as pulling line. Always seize the ends of the grips by banding or taping.

Lewis Type Lsg Wire Rope Snakes		
Size	UTS	Wk. Ld.
REGULAR SIZE SNAKES		
LEWIS TYPE LSG 1/4" - 1/2"	4,486	1,200
LEWIS TYPE LSG 1/2" - 1"	7,500	2,500
LEWIS TYPE LSG 1" - 1 1/2"	10,000	3,500
LEWIS TYPE LSG 1 1/2" - 2"	12,000	4,000
LEWIS TYPE LSG 2" - 2 3/4"	16,000	5,000
LEWIS TYPE LSG 2 3/4" - 3 1/2"	20,000	6,500
LEWIS TYPE LSG 3 1/2" - 4 1/4"	24,000	8,000
SPECIAL SIZE SNAKES		
LEWIS TYPE LSG 1/4" - 1 1/2"	4,486/7,500	1,200/2,500
LEWIS TYPE LSG 1/2" - 1 1/2"	7,500/10,000	2,500/3,500
LEWIS TYPE LSG 1/2" - 2"	7,500/12,000	2,500/4,000
LEWIS TYPE LSG 1" - 2"	10,000/12,000	3,500/4,000
LEWIS TYPE LSG 1 1/2" - 2 1/2"	12,000/16,000	4,000/5,000

WIRE ROPE LUBRICATION

FOR Tower Cranes, Mobile Cranes, Dockside Cranes, Fishing Ropes

BRILUBE 30-a semi-dry thin film lubricant with excellent penetration and corrosion resisting properties.

Formulated for frequent use in harsh working conditions, whilst minimizing lubricant build-up and abrasive particle contamination.

BRILUBE 30 is recommended for general outdoor use where corrosion is a major contribution to rope deterioration.

FOR Lifts and Elevators, Friction Hoists

BRILUBE 40-a synthetic lubricant which deposits a slip-resistant film on the wire surfaces.

Formulated for use where frictional grip is vital, it provides internal lubrication whilst avoiding excessive build-up with repeated applications.

BRILUBE 40 is recommended for use on lifts, elevators and similar friction driven rope installations.

FOR Indoor Cranes, Piling Applications, Small Excavators

BRILUBE 50-an oil based lubricant with additives to increase adherence and enhance corrosion protection. It has excellent penetration and lubrication properties for working ropes in normal industrial environments.

BRILUBE 50 is recommended for overhead cranes, hoist ropes and similar working ropes, where fatigue is the major factor in rope deterioration.

FOR Excavators, Guy Ropes, Winch Ropes

BRILUBE 60-a medium thixotropic gel lubricant with excellent corrosion protection and stable properties over a wide temperature range.

Formulated for long life on standing or dynamic ropes.

BRILUBE 60 is recommended for outdoor use providing effective lubrication and corrosion protection where only infrequent lubrication is possible.

FOR Offshore Cranes, Rigging, Mooring & Towing Cables, Fishing Ropes

BRILUBE 70-a medium thixotropic gel lubricant with stable properties over a wide temperature range offering corrosion protection against marine working conditions.

Formulated for long life on static or dynamic ropes in highly aggressive environments.

BRILUBE 70 is recommended for use in off-shore and other hostile environments where effective lubricant and optimum corrosion protection are vital.

FOR Offshore Installations, Lake and River Ferries, Dock Facilities, Water Treatment Operations

BRILUBE 90-a BIODEGRADABLE heavy duty, Marine Quality wire rope lubricant, developed by BRIDON to meet the needs of wire ropes working in highly aggressive conditions and the demand for environmental acceptability.

Formulated for heavy duty applications in environmentally sensitive environments.

BRILUBE 90 is recommended for use wherever rope lubrication is a problem due to environmental concerns.

The BRILUBE range can be applied by dipping, brushing, spraying and BRILUBE 60, 70 and 90 are particularly suitable for use with High Pressure lubricators due to their good pumping characteristics and non-drying nature.

BRIDON recommends the MASTO High Pressure lubricator, an effective, reliable and economical system, ensuring maximum penetration of lubricant with simultaneous removal of most contaminants.

MASTO systems are available from all BRILUBE stockists for ropes up to 3 ins diameter, and will lubricate up to 150 feet per minute, minimising downtime and waste, while maximising the proven benefits of in-service lubrication.

The BRILUBE range of advanced wire rope lubricants has been developed to promote longer safe-working life through effective lubrication and corrosion protection.

WIRE ROPE LUBRICATION

BRILUBE® APPLICATION SYSTEMS

The BRILUBE range can be applied by dipping, brushing, spraying or pumping, and a range of application equipment is available to enable effective treatment under most conditions.

PORTABLE PRESSURIZED SPRAYER

BRILUBE 30, 40 and 50 can be applied by simple trigger sprays or the BRILUBE portable pressurised sprayer.

This handy pressurised spraying unit consists of a pressure-tested galvanised steel vessel with pressure-gauge, pump, relief valve, 2 metres of reinforced hose and 350mm lance with trigger control and built-in filter. All seals are of solvent resistant nitrile material.

The special funnel shaped head ensures easy filling and protects the gauge and valve.

The unit can be carried by either the handle or the shoulder strap and operates at up to 80 p.s.i. (5.47 bar) for maximum penetration of the dressing, making the unit ideal for the application of BRILUBE onto winches or crane drums.

All units are supplied complete with operating and maintenance instructions and a full list of spares which are readily available.

MASTO™ POWERED APPLICATION SYSTEMS

BRILUBE 60 and 70 can be pressure applied using in-line application systems which are available to suit a wide range of rope sizes and constructions.

These systems operate by forcing the dressing into the rope under high pressure, while simultaneously cleaning the rope and removing moisture, residual dressing and contaminants.

The MASTO system, approved by BRIDON, is suitable for ropes from 4mm to 35mm, and 36mm to 76mm diameter.

The pressure heads are light in weight, easy to attach and effective in use with most rope constructions. The low cost seals are easy to replace and have long operational lives.

