

## 1. BEFORE YOU BEGIN

- Please read these instructions carefully to familiarize yourself with the required tools, materials and installation sequences. Follow the sections that pertain to your particular installation sequences. This will help you avoid costly mistakes.
- Read all operating and safety instructions.
- We recommend this bath for drop-in or alcove installations.
- This bath must be installed to an adequately supported, level subfloor.

- Provide properly dimensioned framing.
- CAUTION: Risk of personal injury.** Cast iron baths are very heavy. Get help lifting and moving the bath.
- Carefully uncrate and inspect the bath for damage. Leave the bath in carton during construction to prevent damage.
  - When replacing an existing bath, check flooring under bath for damage and repair if necessary.

## PREPARATION

- Check roughing-in and room dimensions to make sure there is enough room. See cut-out dimensions chart.
- Make sure existing plumbing corresponds to new bath. Bath can be installed as a corner, peninsular, recess, or sunken installation.
- With a new installation position plumbing according to the rough-in dimensions. Cap supplies and check for leaks.
- When doing a replacement installation disconnect drain at the trap. Slip boards under old bath feet to protect floor and slip old bath out.

## CUT-OUT DIMENSIONS

K-770	40-1/2" (102.9cm) x 58-1/2" (148.6cm)
K-790	34-1/2" (87.6cm) x 58-1/2" (148.6cm)
K-810	34-1/2" (87.6cm) x 70-1/2" (179.1cm)
K-839	30-1/2" (77.5cm) x 64-1/2" (163.8cm)
K-840	30-1/2" (77.5cm) x 64-1/2" (163.8cm)
K-850	30-1/2" (77.5cm) x 58-1/2" (148.6cm)
K-863	34-1/2" (87.6cm) x 70-1/4" (178.4cm)

## NEW CONSTRUCTION

- Construct a recess suitable for the chosen type of installation. Studding arrangements are shown. Illustrations shown suggest stud construction. Modifications may be needed for other types of construction.



**CAUTION: Risk of property damage.** Do not support bath by rim. Provide support under the legs on the underside of the bath.

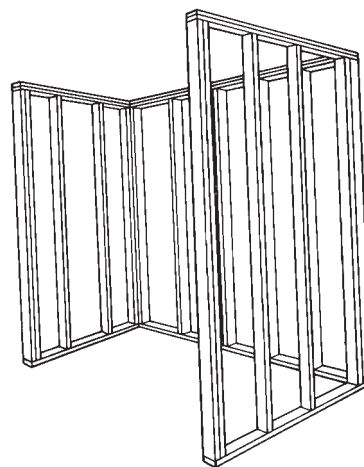

Stud Arrangement

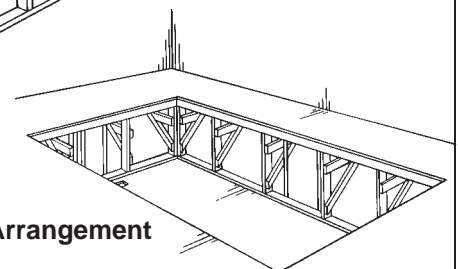

Recessed Stud Arrangement

## ROUGHING-IN DIMENSIONS – FREE-STANDING AND DECK-MOUNT

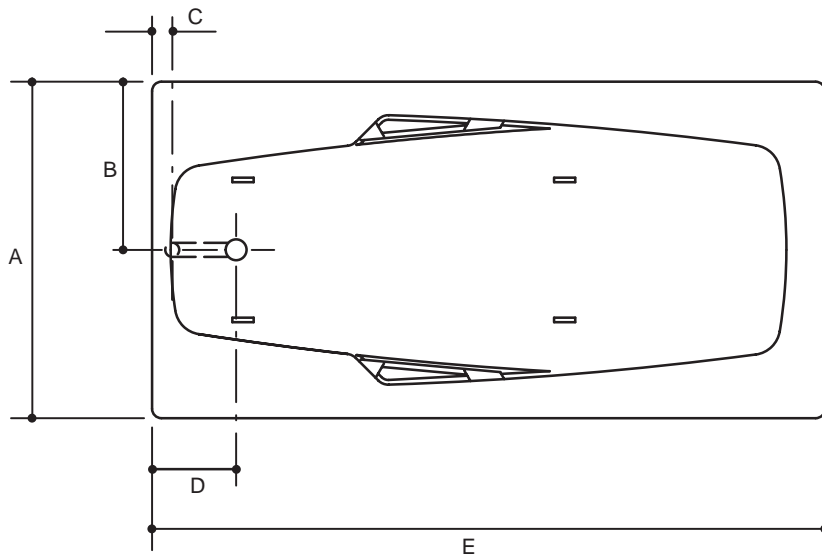

**NOTES**

The tiling-in bead is optional and is recommended when wall material comes in contact with any top surface of the bath.

Some K-1179 tiling-in beads may require trimming of the bottom edge for proper fit.

Fixture dimensions are nominal and conform to tolerances by ANSI standards (A112.19.1)

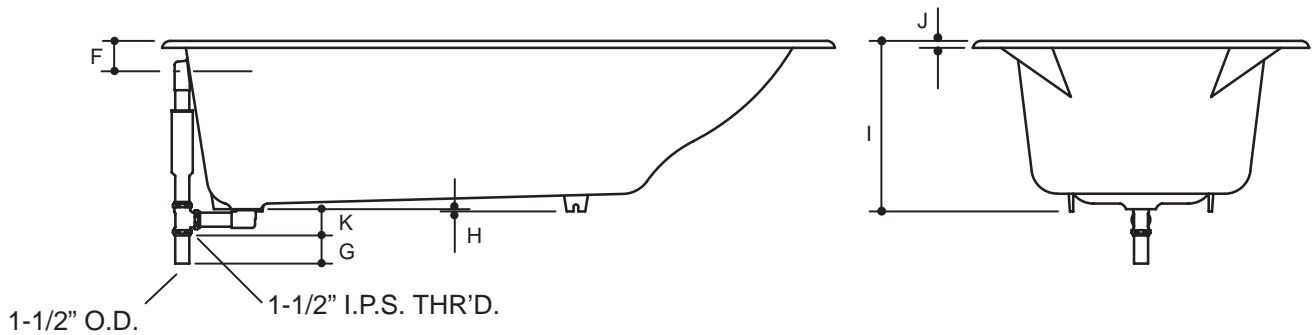

## SPECIFICATIONS

DIMENSIONS (inches)	K-770	K-790	K-810	K-839 &	K-840	K-850	K-863
A	42" (106.7cm)	36" (91.4cm)	36" (91.4cm)	32" (81.3cm)	32" (81.3cm)	32" (81.3cm)	36" (91.4cm)
B	21" (53.3cm)	18" (45.7cm)	18" (45.7cm)	16" (40.6cm)	16" (40.6cm)	16" (40.6cm)	18" (45.7cm)
C	2-1/8" (5.4cm)	2-1/8" (5.4cm)	1-7/8" (4.8cm)	2-1/4" (5.7cm)	2-1/4" (5.7cm)	1-5/8" (4.1cm)	3-1/2" (8.9cm)
D	8-7/8" (22.5cm)	8-7/8" (22.5cm)	9" (22.9cm)	9-1/4" (23.5cm)	9-1/4" (23.5cm)	14" (35.6cm)	15-5/8" (39.7cm)
E	60" (152.4cm)	60" (152.4cm)	72" (182.9cm)	66" (167.6cm)	66" (167.6cm)	60" (152.4cm)	71-3/4" (182.2cm)
F	3-1/4" (8.3cm)	3-1/4" (8.3cm)	3-1/4" (8.3cm)	3-1/4" (8.3cm)	3-1/4" (8.3cm)	2-1/2" (6.4cm)	2-1/2" (6.4cm)
G	3" (7.6cm)	3" (7.6cm)	3" (7.6cm)	3" (7.6cm)	3" (7.6cm)	3" (7.6cm)	3" (7.6cm)
H	1/4" (6mm)	1/4" (6mm)	1/4" (6mm)	1/4" (6mm)	1/4" (6mm)	1/4" (6mm)	1/4" (6mm)
I	20-3/8" (51.8cm)	20-3/8" (51.8cm)	18-1/4" (46.4cm)	18-1/4" (46.4cm)	18-1/4" (46.4cm)	18-1/4" (46.4cm)	20-7/8" (53cm)
J	3/4" (1.9cm)	3/4" (1.9cm)	3/4" (1.9cm)	3/4" (1.9cm)	3/4" (1.9cm)	3/4" (1.9cm)	3/4" (1.9cm)
K	2-7/8" (7.3cm)	2-7/8" (7.3cm)	2-7/8" (7.3cm)	2-7/8" (7.3cm)	2-7/8" (7.3cm)	2-7/8" (7.3cm)	2-7/8" (7.3cm)
Tiling -In Bead	K-1179	K-1179	K-1179	K-1179	K-1179	K-1179	K-1179
Drain	K-7161	K-7161	K-7162	K-7161-AF	K-7161-AF	K-7170 or K-7169-AF	K-7169-AF
Weight	418 lbs.	318 lbs.	380 lbs.	350 lbs.	350 lbs.	250 lbs.	405 lbs.
Capacity	70 gal.	62 gal.	52 gal.	51 gal.	51 gal.	60 gal.	89 gal.

## RECOMMENDED TOOLS AND MATERIALS



Silicone Sealant



Measuring Tape



Pencil



Plumber Putty

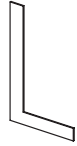

Square

### Plus:

Conventional Woodworking tools and materials

Drop cloth

2x4's



Safety Glasses

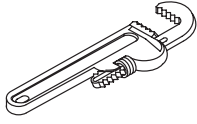

Pipe Wrench



Phillips Screwdriver

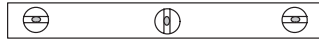

Level

## 2. PREPARE THE BATH

### INSTALL THE DRAIN

Install the drain to the bath according to the drain manufacturer's instructions. Do not connect the trap at this time.

### PROTECT THE BATH SURFACE

Position a clean drop cloth or similar material in the bottom of the bath. Be careful not to scratch the surface of the product.

## 3. POSITION THE BATH



**CAUTION: Risk of property damage.** Do not support bath by rim. Provide support under the legs on the underside of the bath.

Move the bath into position. Insert the drain tailpiece into the trap. Level the bath by fitting metal shims under the bath feet, as needed. The bath must be level and resting on all four feet.

Check for level along the top of the bath, and across the drain side. If the feet are not accessible from the back or side, move the bath in and out of position until it is shimmed properly.

In sunken installations, make sure the bath is supported by supports at the bottom of the bath.

Secure the bath to the floor to prevent shifting.

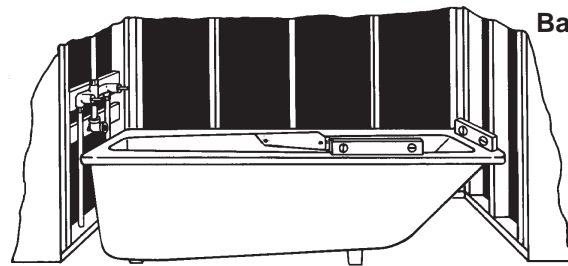

Bath Position

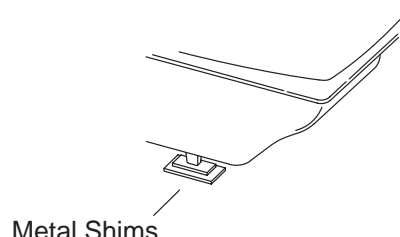

Bath Leveling

Metal Shims

## 4. CONNECT THE PLUMBING



**CAUTION: Risk of property damage.** Ensure a watertight seal on the bath drain connections.

Connect the drain to the trap according to the drain manufacturer's instructions.

Installation of an access panel will simplify future maintenance.

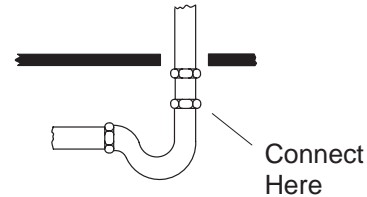

## 5. COMPLETE THE FINISHED WALL

**Important:** Before covering the framing, open hot and cold valves and check all supply connections for leaks. Fill the bath to overflow and check the overflow and drain connections for leaks. Check all connections.

Protect the bath surface.

An optional vinyl tiling-in bead is recommended. Install vinyl bead according to instructions.

When constructing framing, allow for thickness of sub and finished wall materials. If an apron wall without a ledge is desired, the finished apron wall surface must be 1/32" (1mm) under the bath rim.

Cover the framing with water resistant wall material. Seal the joists between the bath rim edge and the water-resistant wall material with silicone sealant.

Tape and mud the water-resistant wall material. Install the finished wall to the water-resistant wall and material. Seal the joints between the bath rim and the finished wall material with silicone sealant.

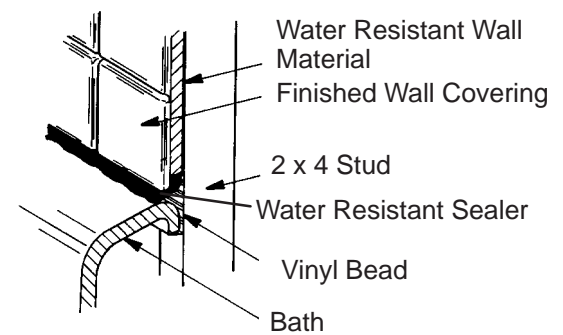
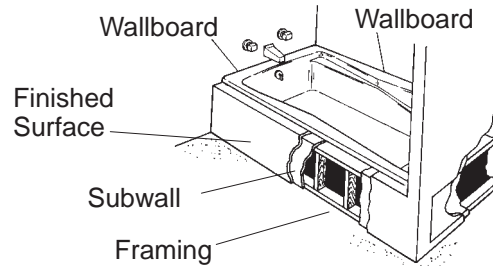

## 6. INSTALL THE FAUCET TRIM AND GRIP RAILS

Install faucet trim according to the instructions packed with the trim.

Install grip rails according to the grip rails manufacturer's instructions if they are called for with your model.

## 7. CARE AND CLEANING

When cleaning up after installation, do not use abrasive cleansers, as they may scratch and dull the bath surface. Use warm water and a liquid detergent to clean the surface.

Remove stubborn stains, paint, or tar with turpentine or paint thinner. Do not allow cleaners containing petroleum distillates to remain in contact with any bath surface for long periods of time.

Remove plaster by carefully scraping with a wood edge. Do not use metal scrapers, wire brushes, or other metal tools. Use a powder type detergent on a damp cloth to provide mild abrasive action to any residual plaster.

Clean the outside surface of your vitreous china product with mild soap and warm water. Wipe the entire surface completely dry with a clean, soft cloth.

If the surface of your vitreous china product becomes excessively dirty, you can use a general purpose cleaner such as: Fantastik®, Lysol® Foaming Disinfectant, Dow Bathroom Cleaner Liquid, Scrub Free® Soap Scum Remover, Soft Scrub®, Spic and Span, or Mr. Clean®.

## 8. LIFETIME LIMITED WARRANTY—KOHLER CAST IRON

Kohler warrants the cast iron components of this product manufactured after February 10, 2000 to be free of defects in material and workmanship during normal residential use for as long as the original consumer purchaser owns his/her home. Gloss reduction, scratching, staining or alkaline etching, of the finish over time due to use, cleaning practices or water or atmospheric conditions are not manufacturing defects but are indicative of normal wear and tear. This warranty applies only for Kohler cast iron product installed in the United States of America and Canada.

If a defect is found in normal residential use, Kohler Co. or Kohler Ltd. will, at its election, repair, replace or make appropriate adjustment. Damage caused by accident, misuse, or abuse is not covered by this warranty. Improper care and cleaning will void the warranty. Proof of purchase (original sales receipt) must be provided to Kohler with all warranty claims. Kohler Co. and Kohler Ltd. are not responsible for labor charges, installation, or other consequential costs. In no event shall the responsibility of Kohler exceed the purchase price of the product.

If the cast iron product is used commercially or is installed outside of North America, Kohler warrants the cast iron product to be free from defects in material and workmanship for one (1) year from the date the product is installed, with all other terms of this warranty applying except duration. All other components other than the enameled cast iron carry Kohler's one year limited warranty unless otherwise specified.

If you believe that you have a warranty claim, contact Kohler Co. or Kohler Ltd. either through your Dealer, Plumbing

Contractor, Home Center or E-tailer, or by writing to the address below. Please be sure to provide all pertinent information regarding your claim, including a complete description of the problem, the product, model number, color, finish, the date the product was purchased and from whom the product was purchased. Also include your original invoice. For other information, or to obtain the name and address of the service and repair facility nearest you, call **1-800-4-KOHLER** from within the U.S.A., or **1-800-964-5590** from within Canada.

United States Residents:

Kohler Co., Customer Service Dept., 444 Highland Drive, Kohler, Wisconsin, 53044, U.S.A.

Canada Residents:

Kohler Ltd., Customer Service Dept., 107 Woodbine Downs Blvd., Unit 12, Etobicoke, Ontario, Canada, M9W 6Y1.

The foregoing warranties are in lieu of all other warranties, express or implied, including but not limited to the implied warranties of merchantability and fitness for a particular purpose.

**Seller disclaims any liability for special, incidental, or consequential damages.**

Some states/provinces do not allow limitations of how long an implied warranty lasts or the exclusion or limitation of such damages, so these limitations and exclusions may not apply to you.

This warranty gives the consumer specific legal rights.

You may also have other rights that vary from state/province to state/province. This warranty is to the original consumer purchaser only, and excludes product damage due to installation error, product abuse, or product misuse, whether performed by a contractor, service company, or the consumer.

This is our exclusive written warranty.





## **CALL US FOR HELP**

Questions? Problems? First review the installation instructions to ensure correct installation. For additional assistance, call our Customer Service Department for direct help. You may also contact us at our web site listed below.

**In the U.S.A., call 1-800-4-KOHLER**

**In Mexico, call 001-877-680-1310**

**In Canada, call 1-800-964-5590**

THE BOLD LOOK  
OF **KOHLER**<sup>®</sup>  
[www.kohler.com](http://www.kohler.com)