

SVP SERIES

PERISTALTIC METERING PUMP

INSTALLATION AND MAINTENANCE MANUAL

 **WARNING**

TO BE INSTALLED AND MAINTAINED BY PROPERLY TRAINED PROFESSIONAL INSTALLER ONLY. READ MANUAL & LABELS FOR ALL SAFETY INFORMATION & INSTRUCTIONS.

TABLE OF CONTENTS

WARRANTY AND SERVICE POLICY.....	3
SAFETY INFORMATION..... cover, 4-5, 9, 10, 12-16, 18, 19, 21-23,	30
FLOW RATE OUTPUTS	6
MATERIALS OF CONSTRUCTION	7
ACCESSORIES	8
INSTALLATION.....	9-18
TROUBLESHOOTING.....	19-21
SUBASSEMBLY CONNECTIONS	22
TUBE REPLACEMENT	23-29
CLEANING THE POINT OF INJECTION	30-32
PUMP HEAD – EXPLODED VIEW AND PARTS	33
PUMP HEAD.....	34
PUMP HEAD SERVICE KITS	35
PUMP TUBES	36
CHECK VALVES	37

IMSV 012020

WARRANTY AND CUSTOMER SERVICE

LIMITED WARRANTY

Stenner Pump Company will for a period of one (1) year from the date of purchase (proof of purchase required) repair or replace, at our option, all defective parts. Stenner is not responsible for any removal or installation costs. Pump tube assemblies and rubber components are considered perishable and are not covered in this warranty. Pump tube will be replaced each time a pump is in for service, unless otherwise specified. The cost of the pump tube replacement will be the responsibility of the customer. Stenner will incur shipping costs for warranty products shipped from our factory in Jacksonville, Florida. Any tampering with major components, chemical damage, faulty wiring, weather conditions, water damage, power surges, or products not used with reasonable care and maintained in accordance with the instructions will void the warranty. Stenner limits its liability solely to the cost of the original product. We make no other warranty expressed or implied.

RETURNS

Stenner offers a 30-day return policy on factory direct purchases. Except as otherwise provided, no merchandise will be accepted for return after 30 days from purchase. To return merchandise at any time, call Stenner at 800.683.2378 for a Return Merchandise Authorization (RMA) number. A 15% re-stocking fee will be applied. Include a copy of your invoice or packing slip with your return.

DAMAGED OR LOST SHIPMENTS

All truck shipments: Check your order immediately upon arrival. All damage must be noted on the delivery receipt. Call Stenner Customer Service at 800.683.2378 for all shortages and damages within seven (7) days of receipt.

SERVICE & REPAIRS

Before returning a pump for warranty or repair, remove chemical from pump tube by running water through the tube, and then run the pump dry. Following expiration of the warranty period, Stenner Pump Company will clean and overhaul any Stenner metering pump for a minimum labor charge plus necessary replacement parts and shipping. All metering pumps received for overhaul will be restored to their original condition. The customer will be charged for missing parts unless specific instructions are given. To return merchandise for repair, call Stenner at 800.683.2378 or 904.641.1666 for a Return Merchandise Authorization (RMA) number.

DISCLAIMER

The information contained in this manual is not intended for specific application purposes. Stenner Pump Company reserves the right to make changes to prices, products, and specifications at any time without prior notice.

TRADEMARKS

QuickPro® is a registered trademark of the Stenner Pump Company.

Santoprene® is a registered trademark of Exxon Mobil Corporation.

Versilon® is a registered trademark of Saint-Gobain Performance Plastics.

Pellethane® is a registered trademark of Lubrizol Advanced Materials, Inc.

AquaShield™ is a trademark of Houghton International.

SAFETY INFORMATION

IMPORTANT SAFETY INSTRUCTIONS

When installing and using this electrical equipment, basic safety precautions should always be followed, including the following:

READ AND FOLLOW ALL INSTRUCTIONS



WARNING Warns about hazards that CAN cause death, serious personal injury, or property damage if ignored.



ELECTRIC SHOCK HAZARD

VAC MODELS ONLY



WARNING **ELECTRIC SHOCK HAZARD:**

Pump supplied with grounding power cord and attached plug. To reduce risk of electrical shock, connect only to a properly grounded, grounding type receptacle. Install only on a circuit protected by a Ground-Fault Circuit-Interrupter (GFCI).



AVERTISSEMENT **DANGER DE CHOC ÉLECTRIQUE:**

La pompe est dotée d'un cordon d'alimentation avec mise à la terre muni d'une fiche. Pour réduire le risque de choc électrique, branchez uniquement sur une prise correctement mise à la terre. Installez uniquement sur un circuit protégé par un disjoncteur différentiel.



DO NOT alter the power cord or plug end.



DO NOT use receptacle adapters.



DO NOT use pump with a damaged or altered power cord or plug. Contact the factory or an authorized service facility for repair.



WARNING **HAZARDOUS VOLTAGE:**

DISCONNECT power cord before removing motor cover for service. **Electrical service by trained personnel only.**



WARNING **EXPLOSION HAZARD:**

This equipment **IS NOT** explosion proof. **DO NOT** install or operate in an explosive environment.



WARNING **RISK OF CHEMICAL EXPOSURE:**

Potential for chemical burns, fire, explosion, personal injury, or property damage. To reduce risk of exposure, the use of proper personal protective equipment is mandatory.



WARNING **RISK OF FIRE HAZARD:**





DO NOT install or operate on any flammable surface.



WARNING To reduce the risk of injury, do not permit children to use this product. This appliance is not to be used by persons with reduced physical, sensory or mental capabilities, or lack of experience and knowledge, unless they have been given supervision or instruction.

SAFETY INFORMATION continued

 **NOTICE:** Indicates special instructions or general mandatory action.

-  **NOTICE:** This metering pump is portable and designed to be removable from the plumbing system without damage to the connections.
-  **NOTICE:** Before installing or servicing the pump, read the pump manual for all safety information and complete instructions. The pump is designed for installation and service by properly trained personnel.
-  **NOTICE:** Installation and product must adhere to all regulatory and compliance codes applicable to the area.
-  **NOTICE:** This metering pump and its components have been tested for use with the following chemicals: Sodium Hypochlorite (10-15%), Muriatic Acid (20-22% Baume, 31.5% HCl), and Soda Ash.
-  **AVIS:** Cette pompe de dosage et ses composants ont été testés pour leur compatibilité avec les produits chimiques suivants : hypochlorite de sodium (10 à 15 %), acide chlorhydrique (20 à 22 % Baume, 31,5 % HCl), et carbonate de sodium.

 **This is the safety alert symbol. When displayed in this manual or on the equipment, look for one of the following signal words alerting you to the potential for personal injury or property damage.**

 **PUMP SUITABLE FOR INDOOR USE.**

 Pompe adaptée à une utilisation à l'intérieur.

 Electrical installation should adhere to all national and local codes. Consult a licensed professional for assistance with proper electrical installation.

VAC MODELS ONLY

 Pump uses a class 2 auto switching power supply for AC input voltage rated 100-240VAC.

SAVE THESE INSTRUCTIONS

FLOW RATE OUTPUTS

25 psi (1.7 bar) maximum

Item Number Prefix	Pump Tube	Gallons per Day	Gallons per Hour	Ounces per Minute	Liters per Day	Liters per Hour	Milliliters per Minute	
Manual	SVP1L1	1	0.3-5.0	0.01-0.21	0.03-0.44	1.1-18.9	0.05-0.79	0.76-13.13
	SVP1L2	2	0.8-17.0	0.03-0.71	0.07-1.51	3.0-64.4	0.13-2.68	2.08-44.65
	SVP1L3	3	2.0-40.0	0.08-1.67	0.18-3.55	7.6-151.4	0.32-6.31	5.27-105.14
	SVP1L4	4	3.0-60.0	0.13-2.50	0.27-5.33	11.4-227.1	0.48-9.46	7.92-157.71
	SVP1L5	5	4.3-85.0	0.18-3.54	0.38-7.55	16.3-321.8	0.68-13.40	11.32-223.40
4-20mA Input*	SVP4L1	1	0.3-5.0	0.01-0.21	0.03-0.44	1.1-18.9	0.05-0.79	0.76-13.13
	SVP4L2	2	0.8-17.0	0.03-0.71	0.07-1.51	3.0-64.4	0.13-2.68	2.08-44.65
	SVP4L3	3	2.0-40.0	0.08-1.67	0.18-3.55	7.6-151.4	0.32-6.31	5.27-105.14
	SVP4L4	4	3.0-60.0	0.13-2.50	0.27-5.33	11.4-227.1	0.48-9.46	7.92-157.71
	SVP4L5	5	4.3-85.0	0.18-3.54	0.38-7.55	16.3-321.8	0.68-13.40	11.32-223.40

Approximate Maximum Outputs @ 50/60Hz

100 psi (6.9 bar) maximum

Item Number Prefix	Pump Tube	Gallons per Day	Gallons per Hour	Ounces per Minute	Liters per Day	Liters per Hour	Milliliters per Minute	
Manual	SVP1H1	1	0.3-5.0	0.01-0.21	0.03-0.44	1.1-18.9	0.05-0.79	0.76-13.13
	SVP1H2	2	0.8-17.0	0.03-0.71	0.07-1.51	3.0-64.4	0.13-2.68	2.08-44.65
	SVP1H7	7	2.0-40.0	0.08-1.67	0.18-3.55	7.6-151.4	0.32-6.31	5.27-105.14
4-20mA Input*	SVP4H1	1	0.3-5.0	0.01-0.21	0.03-0.44	1.1-18.9	0.05-0.79	0.76-13.13
	SVP4H2	2	0.8-17.0	0.03-0.71	0.07-1.51	3.0-64.4	0.13-2.68	2.08-44.65
	SVP4H7	7	2.0-40.0	0.08-1.67	0.18-3.55	7.6-151.4	0.32-6.31	5.27-105.14

Approximate Maximum Outputs @ 50/60Hz

* Input Signal Voltage/Resistance maximum 48VDC/128 ohm.

NOTE: Duckbill check valve included with pumps rated 100 psi (6.9 bar) maximum.



NOTICE: The information within this chart is solely intended for use as a guide. The output data is an approximation based on pumping water under a controlled testing environment. Many variables can affect the output of the pump. Stenner Pump Company recommends that all metering pumps undergo field calibration by means of analytical testing to confirm their outputs.

MATERIALS OF CONSTRUCTION

All Housings

Polycarbonate

Pump Tube

Santoprene® (FDA approved) or Versilon®

Check Valve Duckbill

Santoprene® (FDA approved) or Pellethane®

Suction/Discharge Tubing & Ferrules

Polyethylene (FDA approved)

Suction Line Strainer and Cap

PVC or Polypropylene (both NSF listed); ceramic weight

All Fasteners

Stainless Steel

Tube and Injection Fittings

PVC or Polypropylene (both NSF listed)

Connecting Nuts and 3/8" Adapter

PVC or Polypropylene (both NSF listed)

Pump Head Latches

Polypropylene

ACCESSORIES

3 Connecting Nuts 1/4" or 3/8"

3 Ferrules 1/4" or 6 mm *Europe*

1 Injection Fitting 25 psi (1.7 bar) max. or 1 Duckbill Check Valve 100 psi (6.9 bar) max.

1 Weighted Suction Line Strainer 1/4", 3/8" or 6 mm *Europe*

1 20' Roll of Suction/Discharge Tubing

1/4" or 3/8" White or UV Black or 6 mm White *Europe*

1 Additional Pump Tube

2 Additional Latches

1 Mounting Bracket

1 Manual

1 4-20mA input signal cord (included with SVP 4-20mA pump)

INSTALLATION

ADDITIONAL SAFETY INSTRUCTIONS

! **NOTICE:** Indicates special instructions or general mandatory action.

- !** Read all safety hazards before installing or servicing the pump. The pump is designed for installation and service by properly trained personnel.
- !** Use all required personal protective equipment when working on or near a chemical metering pump.
- !** Install the pump so that it is in compliance with all national and local plumbing and electrical codes.
- !** Use the proper product to treat potable water systems, use only chemicals listed or approved for use.
- !** Install the pump to work in conjunction with well pump or system controls.
- !** Inspect tube frequently for leakage, deterioration, or wear. Schedule a regular pump tube maintenance change to prevent chemical damage to pump and/or spillage.
- !** Pump is not recommended for installation in areas where leakage can cause personal injury or property damage.

INSTALLATION continued

DEFINITIONS

Manual Mode of Operation

The pump is operated by manually adjusting the motor speed with the keypad. SVP Manual pumps and SVP 4-20mA pumps.

Automatic Mode of Operation

The pump is paced by an external 4-20mA signal, LED light illuminate. SVP 4-20mA pumps.

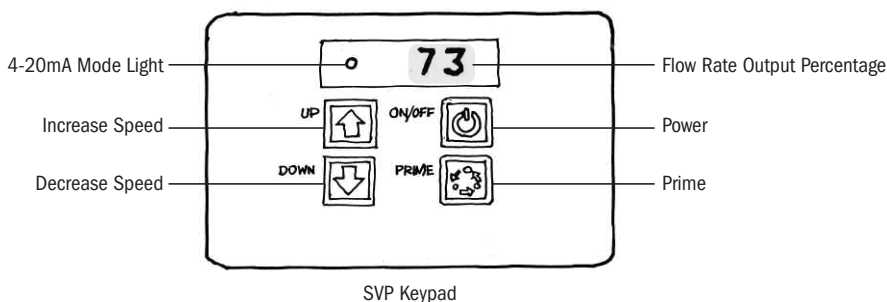

MOUNT PUMP

- ❗ **Select a dry location (to avoid water intrusion and pump damage) above the solution tank.**
- ❗ **To prevent pump damage in the event of a pump tube leak, never mount the pump vertically with the pump head up.**
- ❗ **To avoid chemical damage from fumes, DO NOT mount pump directly over an open solution tank. Keep tank covered.**
- ❗ **Avoid flooded suction or pump mounted lower than the solution container. Draw solution from the top of the tank. Pump can run dry without damage. If pump is installed with a flooded suction, a shut-off valve or other device must be provided to stop flow to pump during service.**
- ❗ **DO NOT allow water intrusion into the motor or corrosion and damage will occur.**

INSTALLATION DIAGRAM

VAC MODELS ONLY

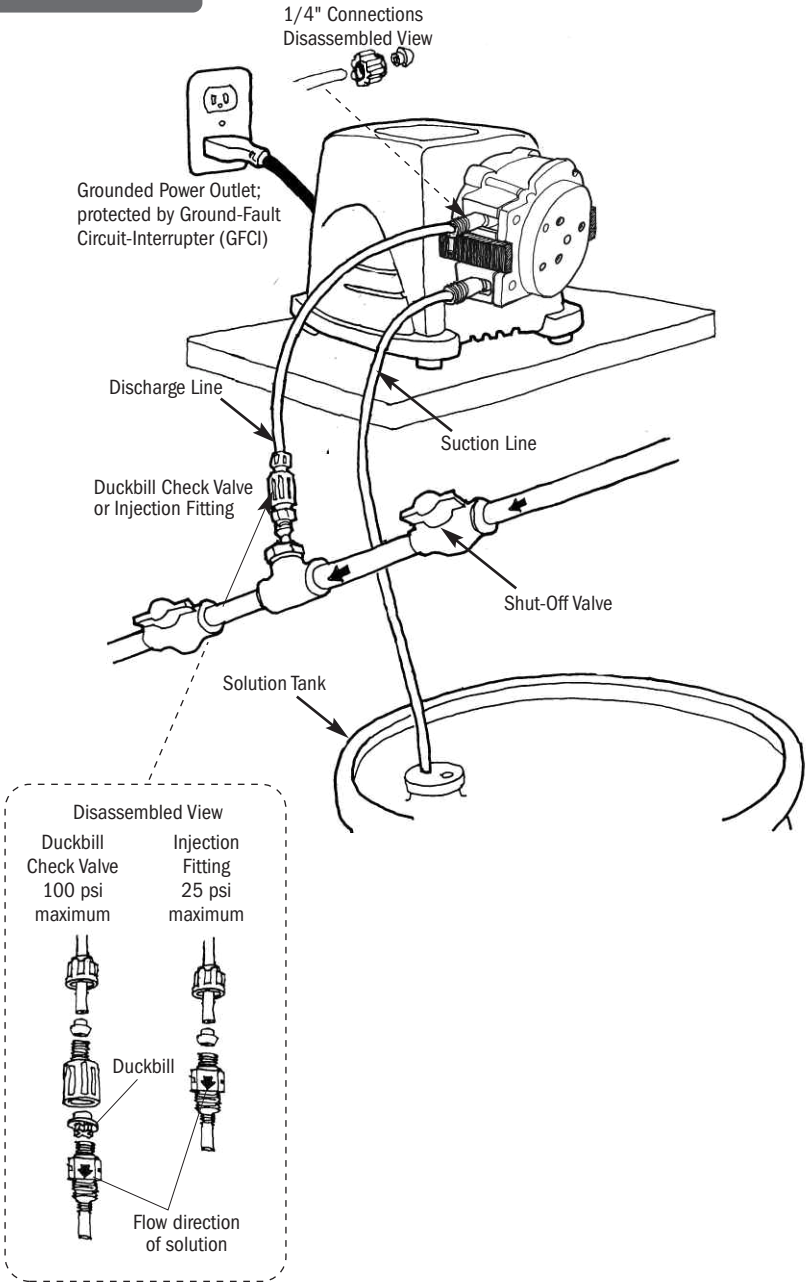

SAFETY INFORMATION



WARNING

RISK OF EQUIPMENT MALFUNCTION OR DAMAGE



DO NOT connect input signal cord to any AC electrical supply.



DO NOT exceed 48VDC input signal.



AVERTISSEMENT

RISQUE DE DEFAUT DE FONCTIONNEMENT OU DE DOMMAGES A L'EQUIPEMENT



NE JAMAIS connecter le cordon du signal d'entrée à n'importe quelle source de courant alternatif.



NE PAS excéder le signal d'entrée 48VDC.



NOTICE: Indicates special instructions or general mandatory action.



Pump is not a source or power supply for the 4-20mA signal loop. Refer to input signal specifications.



Pump and input signal must be "OFF" prior to connecting input signal. Failure to follow this warning may result in microcontroller corruption and erratic operation.



Failure to connect input signal with proper polarity will result in the pump not responding to the input signal.



The LED display can vary if the pump is exposed to a 9-30MHz signal when operating in the "automatic" mode.



Notification: Indique des instructions spéciales ou l'action obligatoire générale.



La pompe n'est pas une source ni une alimentation en courant pour la boucle de signal 4 à 20mA. Consulter les spécifications du signal d'entrée.



Mettre sur Arrêt ("OFF") la pompe et le signal d'entrée, avant d'effectuer la connexion du cordon du signal d'entrée. Si cette précaution n'est pas prise, la micro-contrôleur risque d'être corrompu et le fonctionnement irrégulier.



Si le signal d'entrée n'est pas connecté à la polarité appropriée, la pompe ne réagira pas à ce signal.



L'afficheur LED peut varier si la pompe est exposée à un signal 9-30MHz en fonctionnant en mode "automatique."

INSTALLATION continued

VERIFY VOLTAGE AND POWER

 **To prevent motor damage, verify with a volt meter that the receptacle voltage corresponds with the pump voltage.**

1. Plug cord into receptacle.
2. Press the ON/OFF button located on the keypad to verify the unit is turned on. Red LED display will light up when supply voltage is present and unit is turned ON.

SVP Manual Pump

The SVP Manual pump (identified by the SVP1 prefix) does not have 4-20mA capabilities and only operates in **manual mode** of operation. The output can be incremented through its available speed range by utilizing the UP/DOWN keys on the keypad. Press ON/OFF button again to turn the metering pump off.

SVP 4-20mA Pump

- The manual mode of operation is also available with the SVP 4-20mA pump (identified by the SVP4 prefix). To change to **automatic mode** of operation, simultaneously press both the UP and DOWN keys and hold for two seconds. Then mode of operation will change and be indicated by a small LED light located at the left side of the display. Any settings entered in the variable speed mode will remain in memory.
- If using the automatic mode of operation (4-20mA DC analog signal), plug the input signal connector (10' cable) to the receptacle located on the front of the pump beneath the pump head. Connect the jacketed cable to the supply conductor (4-20mA source) ensuring proper polarity. Red is positive, black is negative. Press ON/OFF button again to turn the metering pump off.

More on next page

INSTALLATION continued

INSTALL SUCTION LINE TO PUMP HEAD

1. Uncoil the suction/discharge line. Use outside of solution tank as a guide to cut proper length of suction line ensuring it will be 2-3" above the bottom of solution tank.

! Allow sufficient slack to avoid kinks and stress cracks. Always make a clean square cut to assure that the suction line is burr free. Normal maintenance requires trimming.

! Suction lines that extend to the bottom of the tank can result in debris pickup leading to clogged injectors and possible tube failure.

2. Make connections by sliding the line(s) through connecting nut* and ferrule and finger tighten to the corresponding tube fittings.

3. Finger tighten nut to the threaded tube fitting while holding the tube fitting.

! Over tightening the ferrule and nut may result in damaged fittings, crushed ferrules, and air pick up.

! DO NOT use thread seal tape on pump tube connections.

More on next page

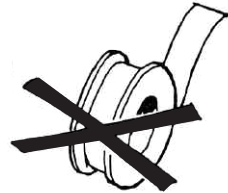
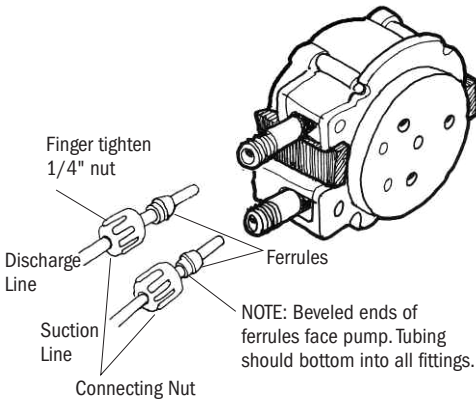

DO NOT use thread seal tape on pump tube threads.

* For 3/8" connections only. Slide line through 3/8" connecting nut and finger tighten to male end of adapter or pump tube fitting. While firmly holding the adapter or tube fitting, wrench tighten the 3/8" connecting nut one additional half turn. If leak occurs, gradually tighten the 3/8" connecting nut as required.

INSTALLATION continued

INSTALL SUCTION WEIGHT TO SUCTION LINE

1. Drill a hole into the bung cap or solution tank lid. Slide the tubing through and secure the weighted strainer to the line.
2. To attach the strainer, slide approximately 3.5" of tubing through the collet and lock into place on strainer body. Pull tubing to make sure it is secure.
3. Suspend slightly above tank bottom to reduce the chance of sediment pickup.



DO NOT mix chemicals in the solution container. Follow recommended mixing procedures according to the manufacturer.



DO NOT operate pump unless chemical is completely in solution. Turn pump off when replenishing solution.



DO NOT slide tubing all the way to the bottom of the weighted strainer. Tubing could become flush with the nose of the strainer and the pump may not prime due to blockage.

More on next page

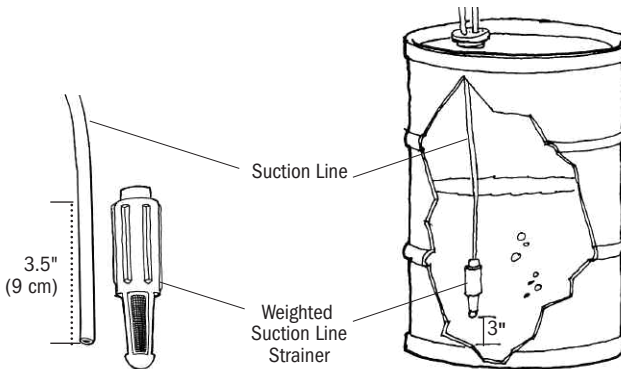

INSTALLATION continued

INSTALL DISCHARGE LINE TO PUMP HEAD AND INJECTION POINT

1. Make a secure finger tight connection on the discharge fitting of the pump head as instructed in Install Suction Line instructions.

! DO NOT use thread seal tape on pump tube connections.

! **WARNING** HAZARDOUS PRESSURE: Shut off water or circulation system and bleed off any system pressure.

! Locate a point of injection beyond all pumps and filters or as determined by the application.

2. A 1/4" or 1/2" Female NPT (FNPT) connection is required for installing the injection fitting. If there is no FNPT fitting available, provide one by either tapping the pipe or installing FNPT pipe tee fitting.
3. Wrap the Male NPT (MNPT) end of injection fitting with 2 or 3 turns of thread seal tape. If necessary, trim the injection fitting quill as required to inject product directly into flow of water.

More on next page



DO NOT use thread seal tape on pump tube threads.

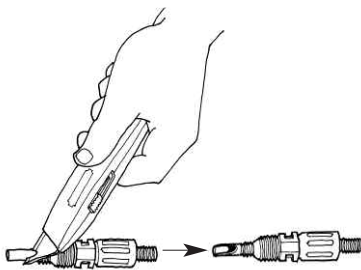

Trim Injection Fitting

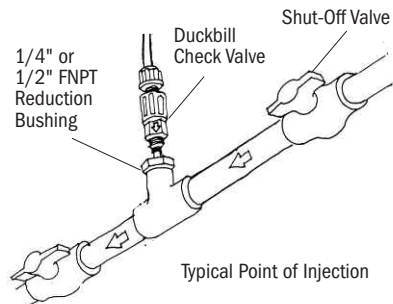

INSTALLATION continued

4. Hand tighten the injection fitting into the FNPT fitting.

Injection Fitting

- a. Install connecting nut and ferrule to the pump discharge line. Insert discharge line into injection fitting until it reaches base of fitting.
- b. Finger tighten connecting nut to fitting. For 3/8" connections wrench tighten one additional 1/2 turn. If leak occurs, gradually tighten the 3/8" connecting nut as required.

Duckbill Check Valve

- a. Prior to connection, test injection check valve and NPT threads for leaks by pressurizing system. If necessary, tighten an additional 1/4 turn.
- b. Install connecting nut and ferrule to the pump discharge line. Insert discharge line into check valve body until it reaches base of body.
- c. Finger tighten connecting nut to fitting. For 3/8" connections wrench tighten one additional 1/2 turn. If leak occurs, gradually tighten the 3/8" connecting nut as required.

5. Turn pump on and re-pressurize system. Press and hold the PRIME button on the keypad and allow the pump to fully prime. The Prime key will operate the pump at 100% but will not display 100% on the keypad. Observe chemical flow as actuated by system and check all connections for leaks.

SVP Manual Pump

Use the manual mode of operation to set the metering pump to the desired speed required for the application. This is the initial setting. Check the entire system for leaks. Proceed to Step 6.

More on next page

INSTALLATION continued

SVP 4-20mA Pump

For automatic mode of operation, verify that the 4-20mA LED light is displayed on the keypad. Provide the required signal for the automatic mode of operation. The pump will respond to the 4-20mA input signal and pace accordingly. Proceed to Step 6.

- 4.0-4.7mA = OFF or 0% motor speed.
- 4.8-19.9mA: the pump will operate in 1% increments every 0.16mA.
- Above 19.9mA the pump will operate at 100% motor speed.
- The pump's minimum speed is 5% @ 4.8mA.

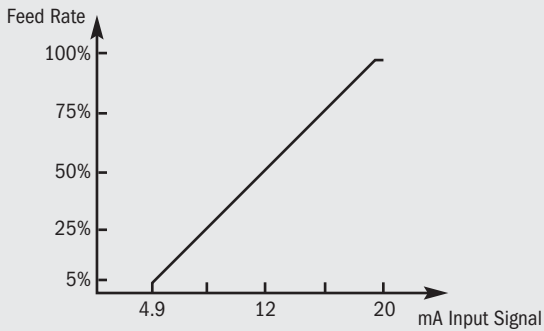

6. After suitable amount of dosing time, perform tests for desired chemical readings (e.g., pH or ppm). If necessary, fine tune dosing or adjust solution strength.



The injection point and fitting require periodic maintenance to clean any deposits or buildup. To allow quick access to the point of injection, Stenner recommends the installation of shut-off valves.

TROUBLESHOOTING – MOTOR



WARNING

HAZARDOUS VOLTAGE:

DISCONNECT power cord before removing motor cover for service. **Electrical service should be performed by trained personnel only.**

KEYPAD/DISPLAY

PROBLEM	POSSIBLE CAUSE	SOLUTION
Display is blank	No power cord connection point Pump is off Failed power supply	Check voltage of receptacle/controller output voltage Press ON/OFF key Check power supply; Green LED "ON" with power applied Check 12VDC output to board
No response to 4-20mA signal	Not in "AUTOMATIC"	Ensure display has a small LED light located in upper left-hand corner indicating pump is in "AUTOMATIC"
Display reads "00" and does not respond when pressing up/down keys	Pump is in "AUTOMATIC" mode of operation	Place pump in "MANUAL" mode

DC MOTOR

PROBLEM	POSSIBLE CAUSE	SOLUTION
Display working; pump is not	Worn motor brushes Failed DC motor	Inspect brushes for wear, replace if needed Replace DC gear motor if brushes are good
Pump cycles ON/OFF	Failed DC fan	Check fan operation; Replace as required

TROUBLESHOOTING – PUMP HEAD

PROBLEM	POSSIBLE CAUSE	SOLUTION
Components cracking	Chemical attack	Check chemical compatibility
Pump head leaking	Pump tube rupture	Replace tube according to instructions
No pump output, pump head rotates	Depleted solution tank Pump suction line weight is above solution Leak in the suction line Ferrules installed incorrectly, missing or damaged Sleeve and/or plastic gripper inside 3/8" connecting nut is missing, damaged, or incorrectly assembled Injection point is clogged Clogged suction/discharge line and/or check valve Life of pump tube exhausted Suction line is flush with the nose of the weighted strainer	Replenish solution Maintain suction line 2-3" above bottom of tank Inspect or replace suction line Replace ferrules If damaged or missing, replace entire 3/8" connecting nut; beveled end of gripper faces nut; wider end of sleeve faces gripper Inspect and clean injection point Clean and/or replace as needed Replace tube according to instructions Pull suction line approximately 1" from bottom of strainer, cut bottom of suction tubing at an angle
Low pump output, pump head rotates	Life of pump tube exhausted Rollers worn or broken Injection point is restricted Incorrect tube size High system back pressure	Replace tube according to instructions Replace roller assembly Inspect and clean injection point Replace tube with correct size Verify system pressure against tube psi, replace tube if needed
No pump output, pump head doesn't rotate	Stripped roller assembly Motor problem	Replace roller assembly Refer to motor section
Pump output high	Incorrect tube size or setting Roller assembly broken	Replace tube with correct size Replace roller assembly

TROUBLESHOOTING – PUMP TUBE

! **NOTICE:** A leaking pump tube damages the metering pump. Inspect pump frequently for leakage and wear. Refer to Tube Replacement section for additional safety precautions and instructions.

PROBLEM	POSSIBLE CAUSE	SOLUTION
Tube leaking	Pump tube ruptured Calcium or mineral deposit Excessive back pressure Tube is twisted Tube not centered	Replace tube according to instructions Clean injection fitting; replace tube according to instructions Verify system pressure against tube psi, replace tube if needed Replace pump tube according to instructions Replace tube according to instructions
Tube life is shortened	Chemical attack Mineral deposits at injection point Sediment blockage at check valve Degraded check valve duckbill Duckbill in wrong orientation Tube manually stretched or pinched during replacement Seized rollers caused abrasion on tube Exposure to heat or sun	Check chemical compatibility Remove deposits, replace pump tube, ferrules; center tube Clean injection fitting; Ensure suction line is 3" above bottom of the tank Use a suction line strainer Replace duckbill at every tube change Reverse duckbill orientation Follow tube replacement instructions and allow roller assembly to stretch tube into place Clean roller assembly or replace DO NOT store tubes in high temperatures or in direct sunlight
Tube connection is leaking	Missing ferrule on 1/4" or 6 mm line Crushed ferrule Ferrule in wrong orientation 3/8" nut loose Missing ferrule in 3/8" adapter Sleeve and/or plastic gripper inside 3/8" connecting nut is missing, damaged, or incorrectly assembled	Replace ferrule Replace ferrule The ferrule's beveled end should face the tube fitting Secure adapter and tighten 3/8" nut as needed Replace with new adapter fitting or insert new ferrule into adapter If damaged or missing, replace entire 3/8" connecting nut; beveled end of gripper faces nut; wider end of sleeve faces gripper

SUBASSEMBLY CONNECTIONS

SEPARATING SUBASSEMBLIES

1. Turn off the pump and disconnect the power supply.
2. Hold the motor section and turn the pump head clockwise, until it stops.
3. Pull the pump head straight out and off.

NOTE: Older pumps or pumps that have had a tube rupture may require the use of a flat blade screwdriver to assist in pump head removal. Turn pump head clockwise until it stops. Insert the screwdriver behind the pump head and carefully pry the pump head off the motor shaft while pulling.





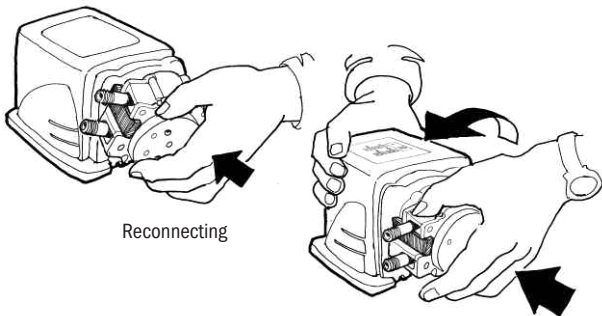
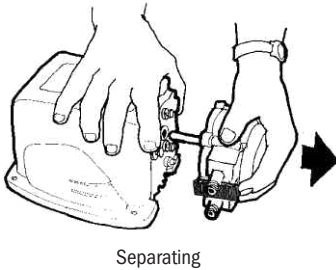

RECONNECTING PUMP HEAD TO MOTOR

1. Hold the pump motor section and insert the motor shaft into the pump head making sure the flat of the motor shaft aligns with the corresponding flat of roller assembly.
2. Rotate the pump head until the locking rivets on the front of the pump motor align with the corresponding mounting locations of the pump head.
3. Push the head onto the motor shaft until it bottoms.
4. Turn counterclockwise to engage mounting rivets.



TUBE REPLACEMENT – SAFETY INFORMATION



WARNING RISK OF CHEMICAL EXPOSURE

-  To reduce risk of exposure, check the pump tube regularly for leakage. At the first sign of leakage, replace the pump tube.
-  To reduce risk of exposure, the use of proper personal protective equipment is mandatory when working on or near chemical metering pumps.
-  To reduce risk of exposure, and also prior to service, shipping, or storage, pump generous amounts of water or a compatible buffer solution to remove chemical from pump.
-  Consult chemical manufacturer and SDS sheet for additional information and precautions for the chemical in use.
-  Personnel should be skilled and trained in the proper safety and handling of the chemicals in use.
-  Inspect tube frequently for leakage, deterioration, or wear. Schedule a regular pump tube maintenance change to prevent chemical damage to pump and/or spillage.





CAUTION PINCH POINT HAZARD

-  Use extreme caution when replacing pump tube. Be careful of your fingers and do not place fingers near rollers.

WARNING HAZARDOUS PRESSURE/CHEMICAL EXPOSURE

-  Use caution and bleed off all resident system pressure prior to attempting service or installation.
-  Use caution when disconnecting discharge line from pump. Discharge may be under pressure. Discharge line may contain chemical.

NOTICE: Indicates special instructions or general mandatory action.

-  **NOTICE: DO NOT** apply grease, oil, or lubricants to the pump tube or housing.
-  **NOTICE:** Prior to pump tube replacement, inspect the entire pump head for cracks or damaged components. Ensure rollers turn freely.
-  **NOTICE:** Rinse off chemical residue and clean all chemical and debris from pump head components prior to tube replacement. Apply AquaShield™ to main shaft and tube housing cover bushing during tube replacement.
-  **NOTICE: DO NOT** pull excessively on pump tube. Avoid kinks or damage during tube installation.
-  **NOTICE:** Inspect the suction and discharge lines, injection point (into pipe), and duckbill check valve duckbill for blockages after any tube rupture. Clear or replace as required.

TUBE REPLACEMENT continued

PREPARATION

1. Follow all safety precautions prior to tube replacement.
2. Prior to service, pump water or a compatible buffer solution through the pump and suction and discharge lines to remove chemical and avoid contact.

More on next page

TUBE REPLACEMENT continued

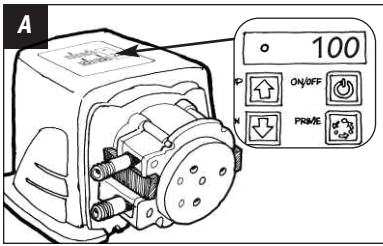

Place the pump in manual mode and verify the setting is on 100

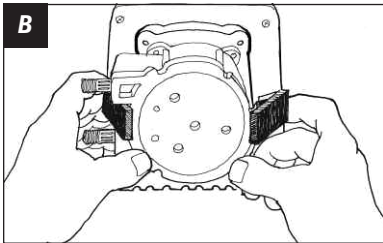

Open latches

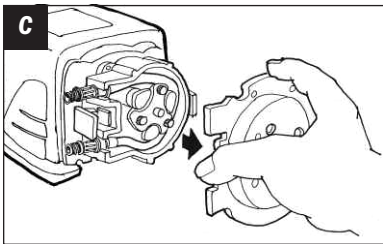

Remove cover

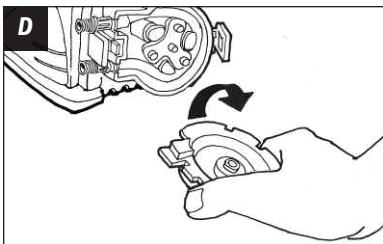

Invert cover

REMOVE THE PUMP TUBE

1. Place the pump in manual mode of operation and set display to 100%.
Illustration A Turn the pump off and disconnect the power cord.
2. Depressurize and disconnect the suction and discharge lines.
3. Open the latches on both sides of the head. *Illustration B* Carefully fold latches back to prevent contact with the cover.
For CE pump only: Remove the safety screw on cover.
4. Remove the tube housing cover and flip to use as a tool in the next step.
Illustration C & D

More on next page

TUBE REPLACEMENT continued

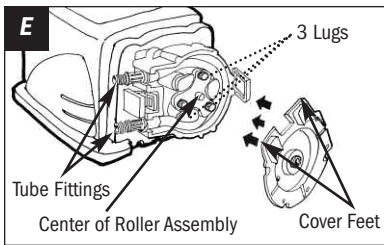

E Align cover feet near tube fittings

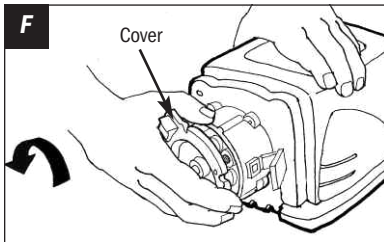

F Collapse roller assembly

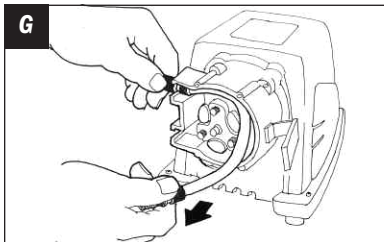

G Remove tube

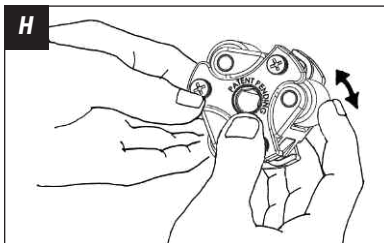

H Check rollers

REMOVE THE PUMP TUBE continued

- 5.** Align the center of the inverted cover with the center of the roller assembly so that the three holes on the face of the cover align with the three knurled lugs on the roller assembly. Position the cover feet near the tube fittings. *Illustration E*
NOTE: The roller assembly needs to be collapsed to remove the tube.
- 6.** Hold the pump securely, use the tube housing cover as a wrench and quickly (snap) rotate the cover counterclockwise to collapse the roller assembly. The tube will no longer be pressed against the tube housing wall. *Illustration F*
- 7.** Remove and discard the pump tube. *Illustration G*
- 8.** Remove the roller assembly and housing. Set them aside to re-install later.
- 9.** Use a non-citrus all-purpose cleaner to clean chemical residue from the tube housing, roller assembly and cover.
- 10.** Check the housing for cracks. Replace if cracked.
- 11.** Ensure the rollers turn freely. *Illustration H*
Replace the roller assembly if the rollers are seized or worn or if there is a reduction or lack of output from the pump.
- 12.** Reinstall clean tube housing.
- 13.** Apply AquaShield™ to the shaft tip.
- 14.** Install the roller assembly.

More on next page

TUBE REPLACEMENT continued

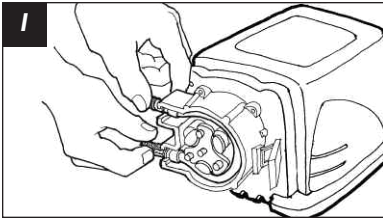

Place new tube

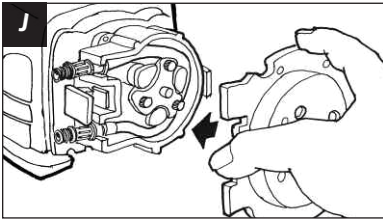

Attach cover

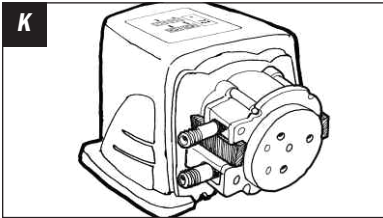

Run pump for two minutes

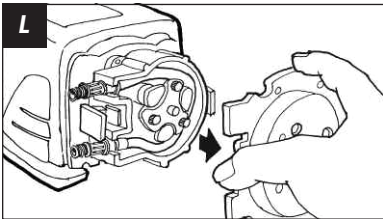

Remove cover

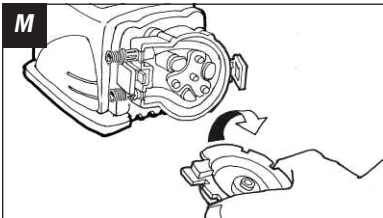

Apply Aquashield™ to cover bushing

INSTALL THE PUMP TUBE AND EXPAND THE ROLLER ASSEMBLY

IMPORTANT! DO NOT LUBRICATE PUMP TUBE OR ROLLER ASSEMBLY.

1. Place the new tube in the pump head, use your fingers to ensure that it is centered over the rollers. *Illustration I*
 2. Place the tube housing cover (feet first) on the tube housing, affix the front of the latches to the cover lip and then press the latches to secure. Be sure the cover is seated with the sleeve bearing on the shaft and is flush with housing, before latching. *Illustration J*
 3. With the cover latched, plug the pump in and turn the power on. Allow the pump to run the roller assembly in its collapsed position for two minutes to relax the tube. *Illustration K*
 4. Turn the pump off and disconnect the power cord.
 5. Remove the tube housing cover and flip to use as a tool in the next step. *Illustration L*
 6. Align the center of the inverted cover with the center of the roller assembly so that the three holes on the face of the cover align with the three knurled lugs on the roller assembly. Position the cover feet near the bottom. *Illustration M*
- NOTE: The roller assembly needs to be expanded so the tube is pressed against the tube housing wall.

More on next page

TUBE REPLACEMENT continued

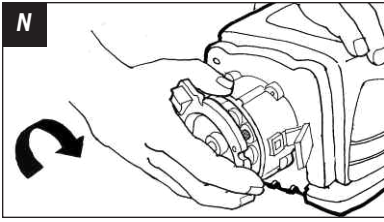

Install cover feet first

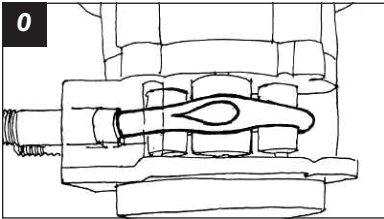

Confirm roller assembly is expanded

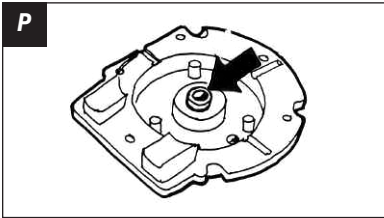

Apply AquaShield™ to cover bushing

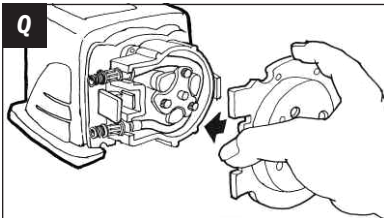

Install cover, feet first

INSTALL THE PUMP TUBE AND EXPAND THE ROLLER ASSEMBLY continued

7. Hold the pump securely. Use the cover as a wrench and quickly (snap) rotate the roller assembly clockwise to expand the roller assembly. The tube will be pressed against the tube housing wall. *Illustration N & O*
8. Apply a small amount of AquaShield™ to the cover bushing ONLY. DO NOT lubricate the pump tube. *Illustration P*
9. Place the tube housing cover (feet first) on the tube housing, affix the front of the latches to the cover lip and then press the latches back to secure. Be sure the cover is seated with the sleeve bearing on the shaft and is flush with housing, before latching. *Illustration Q*

More on next page

TUBE REPLACEMENT continued

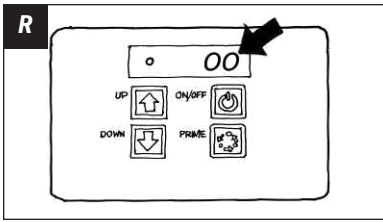

Place pump in manual mode, set to 00

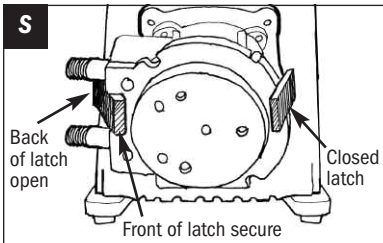

Prepare to center the tube

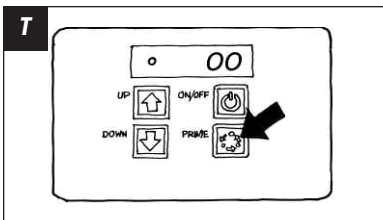

Press prime

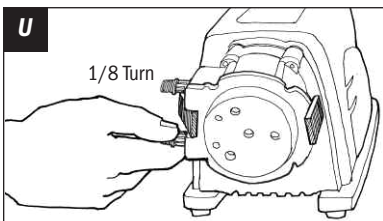

Center the tube

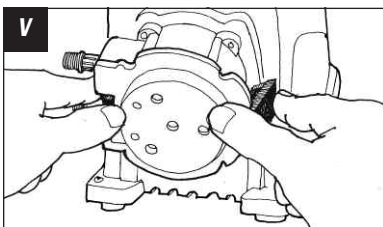

Secure latches

CENTER NEW TUBE

1. Connect the power supply and with the power on and in manual mode, set the display to 00. Lift the latch located between the tube fittings, leaving the end of the latch engaged with the lip on the tube housing cover. Leave the latch on the opposite side engaged. *Illustration R & S*
2. Depress the prime button and turn the tube fitting on the suction side not more than 1/8 of a turn in the direction the tube must move. *Illustration T & U*
3. DO NOT let go of the fitting until the tube rides approximately in center of the rollers.
4. Release the prime button, let go of the fitting, and secure the latch between the fittings. *Illustration V*
For CE pump only: Reinstall the safety screw on the cover.
5. Inspect the suction and discharge lines, point of injection, and check valve duckbill for blockages. Clean and/or replace as required. Failure to do so may lead to poor pump performance, including shortened tube life.
6. Reconnect the suction and discharge lines. DO NOT allow tube fittings to turn inside the pump housing.
7. Turn the pump on and run for one minute to verify operation.

CLEANING THE POINT OF INJECTION – SAFETY INFORMATION

NOTICE: Indicates special instructions or general mandatory action.

NOTICE: Pumps rated 25 psi maximum are installed with an injection fitting and pumps rated 100 psi maximum are installed with a duckbill check valve. Both allow the extension tip to be installed in the center of the pipe directly in the flow of water to help reduce deposit accumulation.

WARNING Warns about hazards that CAN cause death, serious personal injury, or property damage if ignored.

This is the safety alert symbol. When displayed in this manual or on the equipment, look for one of the following signal words alerting you to the potential for personal injury or property damage.

- WARNING HAZARDOUS PRESSURE/CHEMICAL EXPOSURE:**
- Use caution and bleed off all resident system pressure prior to attempting service or installation.
 - Use caution when disconnecting discharge line from pump. Discharge line may be under pressure. Discharge line may contain chemical.
 - To reduce risk of exposure, the use of proper personal protective equipment is mandatory when working on or near chemical metering pumps.

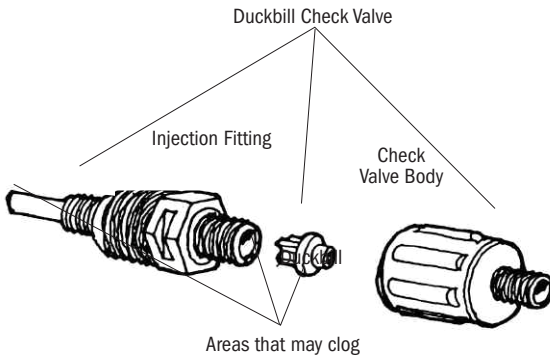

CLEANING THE POINT OF INJECTION continued

1. Turn metering pump off and unplug cord. Disable water pump or auxiliary equipment electrical supply.
2. Depressurize system and bleed pressure from pump discharge line.
3. Loosen and remove connecting nut and ferrule from the check valve or injection fitting to disconnect discharge tubing.

Duckbill Check Valve, go to 4.

Injection Fitting, skip 4 and go to 5.

4.
 - Unscrew the top fitting (check valve body) to disassemble. The bottom fitting (injection fitting with arrow) should remain attached to the pipe.
 - Remove duckbill from check valve body and replace it.
 - Examine o-ring in the injection fitting and replace if deteriorated or damaged.
5. Insert a #2 Phillips head screwdriver through injection fitting into the pipe to locate or break up accumulated deposits. If screwdriver cannot be inserted, drill the deposit out of the injection fitting (DO NOT drill through the opposite pipe wall.)

More on next page

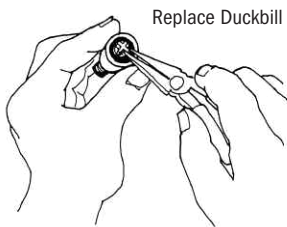

Clean out accumulated deposits with a #2 Phillips head screwdriver.

Periodic inspection and cleaning of the point of injection will maintain proper pump operation and provide maximum tube life.

CLEANING THE POINT OF INJECTION continued

- 6. Replace discharge line if cracked or deteriorated. If the end is clogged, cut off the calcified or blocked section of discharge line.

7. Duckbill Check Valve

- a. Reassemble the duckbill check valve.
- b. Replace ferrule and reinstall the discharge line to the duckbill check valve approximately 3/4" until it stops.

Injection Fitting

Replace ferrule and reinstall the discharge line to the injection fitting approximately 3/4" until it stops.

- 8. Tighten the connection nut finger tight.
- 9. Enable the water pump electrical supply and pressurize the water system.
NOTE: The roller assembly needs to be expanded so the tube is pressed against the tube housing wall.
- 10. Put the metering pump back in service and inspect all connections for leaks.

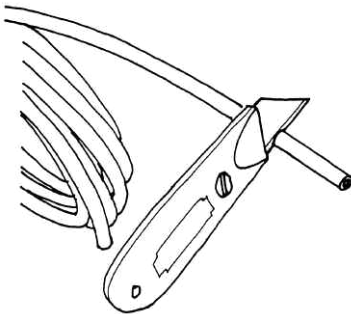

Cut off the calcified or blocked section.

PUMP HEAD EXPLODED VIEW

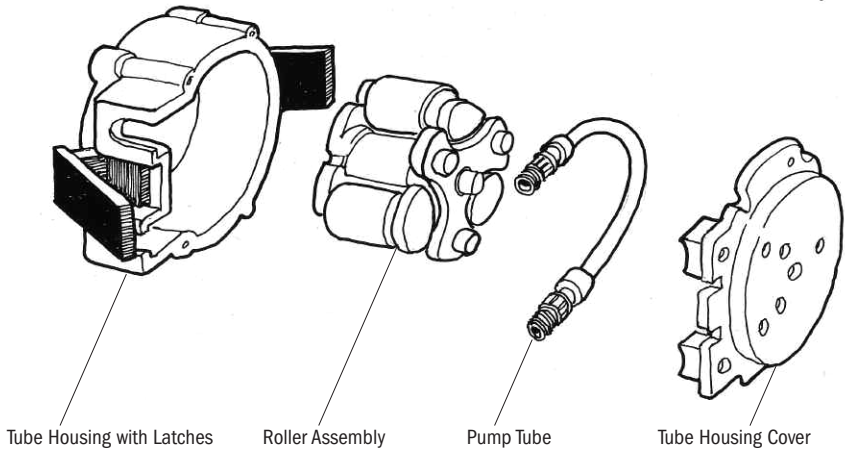

PUMP HEAD PARTS

DESCRIPTION	EA	2-PK	4-PK
Tube Housing & Latches	QP400-1	QP400-2	————
Latches	————	QP401-2	————
Roller Assembly	QP500-1	————	QP500-4
Tube Housing Cover & Bushing	QP100-1	————	QP100-4

PUMP HEAD

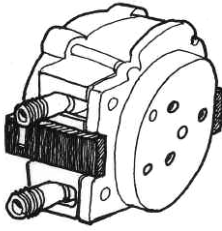

Refer to the **FLOW RATE OUTPUT** chart to match the pump with the correct tube

PUMP HEAD 25 psi max.

Includes tube, ferrules 1/4"

DESCRIPTION	EA	2-PK
#1 Santoprene® QP Pump Head	QP251-1	QP251-2
#2 Santoprene® QP Pump Head	QP252-1	QP252-2
#3 Santoprene® QP Pump Head	QP253-1	QP253-2
#4 Santoprene® QP Pump Head	QP254-1	QP254-2
#5 Santoprene® QP Pump Head	QP255-1	QP255-2
#1 Versilon® QP Pump Head	QP25T1-1	-----
#2 Versilon® QP Pump Head	QP25T2-1	-----
#3 Versilon® QP Pump Head	QP25T3-1	-----
#4 Versilon® QP Pump Head	QP25T4-1	-----
#5 Versilon® QP Pump Head	QP25T5-1	-----

PUMP HEAD 100 psi max.

Includes tube, duckbill, ferrules 1/4"

DESCRIPTION	EA
#1 Santoprene® QP Pump Head	QP101-1
#2 Santoprene® QP Pump Head	QP102-1
#7 Santoprene® QP Pump Head	QP107-1
#1 Versilon® QP Pump Head	QP10T1-1
#2 Versilon® QP Pump Head	QP10T2-1

PUMP HEAD 1.7 bar max. EUROPE

Includes tube, ferrules 6 mm

DESCRIPTION	EA	2-PK
#1 Santoprene® QP Pump Head	QP171-1	QP171-2
#2 Santoprene® QP Pump Head	QP172-1	QP172-2
#3 Santoprene® QP Pump Head	QP173-1	QP173-2
#4 Santoprene® QP Pump Head	QP174-1	QP174-2
#5 Santoprene® QP Pump Head	QP175-1	QP175-2
#1 Versilon® QP Pump Head	QP17T1-1	-----
#2 Versilon® QP Pump Head	QP17T2-1	-----
#3 Versilon® QP Pump Head	QP17T3-1	-----
#4 Versilon® QP Pump Head	QP17T4-1	-----
#5 Versilon® QP Pump Head	QP17T5-1	-----

PUMP HEAD 6.9 bar max. EUROPE

Includes tube, duckbill, ferrules 6 mm

DESCRIPTION	EA
#1 Santoprene® QP Pump Head	QP691-1
#2 Santoprene® QP Pump Head	QP692-1
#7 Santoprene® QP Pump Head	QP697-1
#1 Versilon® QP Pump Head	QP69T1-1
#2 Versilon® QP Pump Head	QP69T2-1

NOTE: Confirm chemical compatibility with the chemical resistance guide in the catalog.

PUMP HEAD SERVICE KITS

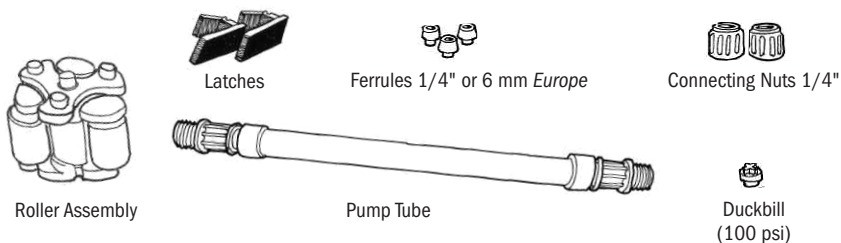

PUMP HEAD SERVICE KIT 25 psi max.

Includes roller assembly, tube, nuts, ferrules 1/4", latches

DESCRIPTION	KIT
#1 Santoprene® QP Kit	QP251K
#2 Santoprene® QP Kit	QP252K
#3 Santoprene® QP Kit	QP253K
#4 Santoprene® QP Kit	QP254K
#5 Santoprene® QP Kit	QP255K
#1 Versilon® QP Kit	QP25T1K
#2 Versilon® QP Kit	QP25T2K
#3 Versilon® QP Kit	QP25T3K
#4 Versilon® QP Kit	QP25T4K
#5 Versilon® QP Kit	QP25T5K

PUMP HEAD SERVICE KIT 100 psi max.

Includes roller assembly, tube, duckbill, nuts, ferrules 1/4", latches

DESCRIPTION	KIT
#1 Santoprene® QP Kit	QP101K
#2 Santoprene® QP Kit	QP102K
#7 Santoprene® QP Kit	QP107K
#1 Versilon® QP Kit	QP10T1K
#2 Versilon® QP Kit	QP10T2K

PUMP HEAD SERVICE KIT 1.7 bar max. EUROPE

Includes roller assembly, tube, nuts, ferrules 6 mm, latches

DESCRIPTION	KIT
#1 Santoprene® QP Kit	QP171K
#2 Santoprene® QP Kit	QP172K
#3 Santoprene® QP Kit	QP173K
#4 Santoprene® QP Kit	QP174K
#5 Santoprene® QP Kit	QP175K
#1 Versilon® QP Kit	QP17T1K
#2 Versilon® QP Kit	QP17T2K
#3 Versilon® QP Kit	QP17T3K
#4 Versilon® QP Kit	QP17T4K
#5 Versilon® QP Kit	QP17T5K

PUMP HEAD SERVICE KIT 6.9 bar max. EUROPE

Includes roller assembly, tube, duckbill, nuts, ferrules 6 mm, latches

DESCRIPTION	KIT
#1 Santoprene® QP Kit	QP691K
#2 Santoprene® QP Kit	QP692K
#7 Santoprene® QP Kit	QP697K
#1 Versilon® QP Kit	QP69T1K
#2 Versilon® QP Kit	QP69T2K

NOTE: Confirm chemical compatibility with the chemical resistance guide in the catalog.

PUMP TUBES

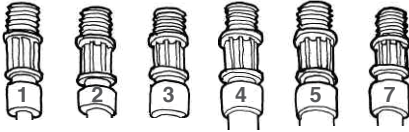

Tube number located on fitting

Refer to the **FLOW RATE OUTPUT** chart to match the pump with the correct tube

PUMP TUBE Includes ferrules 1/4"

DESCRIPTION	2-PK	5-PK
#1 Santoprene® Tube	UCCP201	MCCP201
#2 Santoprene® Tube	UCCP202	MCCP202
#3 Santoprene® Tube	UCCP203	MCCP203
#4 Santoprene® Tube	UCCP204	MCCP204
#5 Santoprene® Tube	UCCP205	MCCP205
#7 Santoprene® Tube	UCCP207	MCCP207
#1 Versilon® Tube	UCTYG01	MCTYG01
#2 Versilon® Tube	UCTYG02	MCTYG02
#3 Versilon® Tube	UCTYG03	MCTYG03
#4 Versilon® Tube	UCTYG04	MCTYG04
#5 Versilon® Tube	UCTYG05	MCTYG05

PUMP TUBE & DUCKBILL

Includes ferrules 1/4"

DESCRIPTION	2-PK
#1 Santoprene® Tube & Duckbill	UCC1FD
#2 Santoprene® Tube & Duckbill	UCC2FD
#7 Santoprene® Tube & Duckbill	UCC7FD
#1 Versilon® Tube & Duckbill	UCTY1FD
#2 Versilon® Tube & Duckbill	UCTY2FD

PUMP TUBE EUROPE Includes ferrules 6 mm

DESCRIPTION	2-PK	5-PK
#1 Santoprene® Tube	UCCP21CE	MCCP21CE
#2 Santoprene® Tube	UCCP21CE	MCCP21CE
#3 Santoprene® Tube	UCCP23CE	MCCP23CE
#4 Santoprene® Tube	UCCP24CE	MCCP24CE
#5 Santoprene® Tube	UCCP25CE	MCCP25CE
#7 Santoprene® Tube	UCCP27CE	MCCP27CE
#1 Versilon® Tube	UCTY1CE	MCTY1CE
#2 Versilon® Tube	UCTY2CE	MCTY2CE
#3 Versilon® Tube	UCTY3CE	MCTY3CE
#4 Versilon® Tube	UCTY4CE	MCTY4CE
#5 Versilon® Tube	UCTY5CE	MCTY5CE

PUMP TUBE & DUCKBILL EUROPE

Includes ferrules 6 mm

DESCRIPTION	2-PK
#1 Santoprene® Tube & Duckbill	UC1FDCE
#2 Santoprene® Tube & Duckbill	UC2FDCE
#7 Santoprene® Tube & Duckbill	UC7FDCE
#1 Versilon® Tube & Duckbill	UCTY1DCE
#2 Versilon® Tube & Duckbill	UCTY2DCE

NOTE: Confirm chemical compatibility with the chemical resistance guide in the catalog.

INJECTION FITTINGS & CHECK VALVES

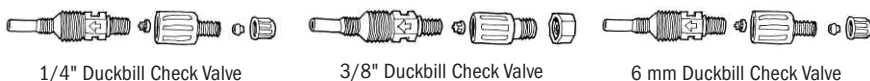

1/4" Duckbill Check Valve

3/8" Duckbill Check Valve

6 mm Duckbill Check Valve

INJECTION FITTINGS 25 psi max.

DESCRIPTION	EA	5-PK
1/4" Injection Fitting with Nut & Ferrule	UCAK300	MCAK300
3/8" Injection Fitting with Nut	UCAK400	———

INJECTION FITTINGS 1.7 bar max. EUROPE

DESCRIPTION	EA
6 mm Injection Fitting with Nut & Ferrule	UCAK3CE

DUCKBILL CHECK VALVES 100 psi max.

DESCRIPTION	EA	5-PK
1/4" Includes Santoprene® Duckbill, Nut, Ferrule	UCDBINJ	MCDBINJ
1/4" Includes Pellethane® Duckbill, Nut, Ferrule	UCTYINJ	MCTYINJ
1/4" Includes FKM Duckbill, Nut, Ferrule	UCKMINJ	MCKMINJ
3/8" Includes Santoprene® Duckbill, Nut	UCINJ38	MCINJ38
3/8" Includes Pellethane® Duckbill, Nut	UCTYJ38	MCTYJ38
3/8" Includes FKM Duckbill, Nut	UCKMI38	MCKMI38

DUCKBILL CHECK VALVES 6.9 bar max. EUROPE

DESCRIPTION	EA	5-PK
6 mm Includes Santoprene® Duckbill, Nut, Ferrule	UCINJCE	MCINJCE
6 mm Includes Pellethane® Duckbill, Nut, Ferrule	UCTINJCE	MCTINJCE
6 mm Includes FKM Duckbill, Nut, Ferrule	UCKMJCE	MCKMJCE

NOTE: Confirm chemical compatibility with the chemical resistance guide in the catalog.

STENNER PUMPS[®]

STENNER PUMP COMPANY

3174 DeSalvo Road
Jacksonville, Florida 32246 USA

Phone: 904.641.1666

US Toll Free: 800.683.2378

Fax: 904.642.1012

sales@stenner.com

www.stenner.com

Hours of Operation (EST):

Mon.-Thu. 7:30 am-5:30 pm

Fri. 7:00 am-5:30 pm

 Assembled in the USA

© Stenner Pump Company
All Rights Reserved