

XOMOX[®]

brands you trust.



Xomox[®] FK Soft Seated Ball Valve

CRANE[®]

www.cranecpe.com

Heritage of Innovation & Quality

Crane Co. is a diversified manufacturer of highly engineered industrial products, founded in 1855. Crane has approximately 11,000 employees in the Americas, Europe, Asia and Australia, and is traded on the New York Stock Exchange (NYSE:CR).

One of its businesses (within Fluid Handling segment), XOMOX® was established in 1956 as the Continental Manufacturing Company. The principal product was the Tufline fluorocarbon-sleeved plug valve. The concept of the nonlubricated sleeved plug valve was developed owing to the advent of Teflon® by the E.I. du Pont de Nemours and Company.

Today, XOMOX ranks among the most successful and well known global manufactures of industrial valves for demanding service applications. XOMOX manufactures and supplies a broad line of fluid flow process control products for the **process industry** including chemical, fertilizer, petrochemical, water treatment, pulp & paper, fossil fuel and nuclear power generation, oil and gas-transmission and production, among others.

When you buy products from us, you get much more than just valves:

Traceability

A stainless steel, tag is attached to all manufactured and modified valves. It includes standard ANSI information.

Fully Tested

All valves manufactured by Xomox are tested in accordance with Xomox strict manufacturing procedures and industry regulations.

Field Repair Services

Xomox technicians are available for field repair and emergency service at your site.

Consistent Quality

The high Xomox quality is supported by our extensive practical experience, state-of-the-art manufacturing, and quality assurance certified by international inspections authorities. Please visit our website for details.

Crane Fluid Handling: Global Presence, Local Support.



Manufacturing facilities include:

- Cincinnati, USA
- Lindau, Germany
- Chihuahua, Mexico
- Székesfehérvár, Hungary
- Chennai, India
- Ningjin, China

Xomox FK Ball Valve Features and Benefits

Features & Benefits

- 1 Three independent stem seals offer superior **fugitive emissions control**, certified to the following standards: EPA Method-21, ISO-15848, and TA-Luft according to VDI 2440.
- 2 **Self-relieving** seats permit relief of excess pressure to protect the integrity of the valve while maintaining bi-directional operation.
- 3 Patented SX ball-stem design provides high maximum stem torque capability and built-in side load resistance for **extended valve life** under severe conditions including thermal-cycling.
- 4 Dual material spiral wound body gasket, including a PTFE chemically inert inner seal and a secondary graphite outer seal, is supplied as standard.



Fire tested as standard per API 607-6th edition & ISO 10497:2010

High Maximum Stem Torque Capability

Triple stem seal

Tertiary Seal
Graphite Packing

Secondary Seal
Lip Seal Ring

Primary Seal
SX Stem Seal

ISO 5211 Mounting

Blow-Out Proof Stem with Anti-Static Continuity

Dual Material Spiral Wound Body Gasket

Full-Port Design

Investment Casting through 12"

Floating ball design 1/2" - 8"
Trunnion ball design 10" - 12"

Full-Face Metal to Metal Contact

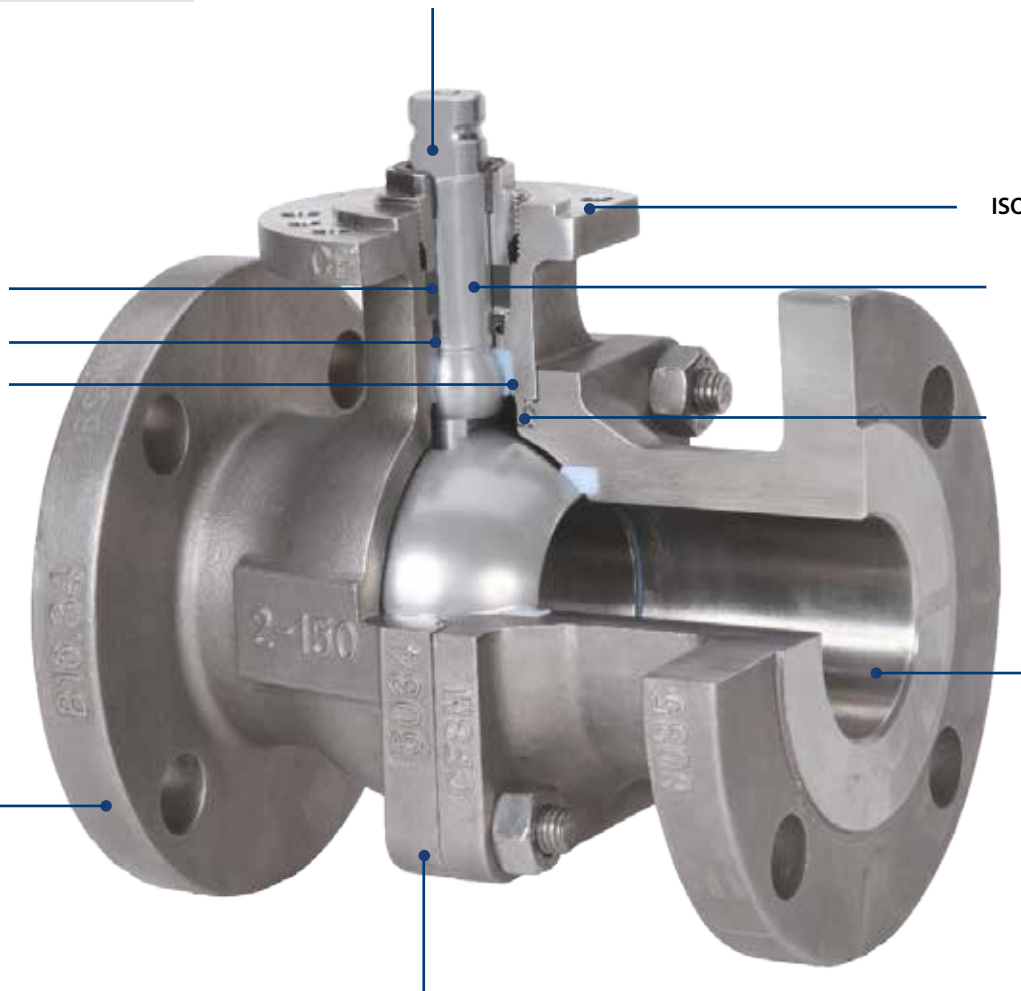

Xomox® FK Ball Valve

Body Configuration	Port	Figure Number	ANSI Pressure Class	IN.	1/2"	3/4"	1"	1 1/2"	2"	3"	4"	6"	8"	10"	12"
				DN	15	20	25	40	50	80	100	150	200	250	300
2pc Floating	Full Port	K21F	150		•	•	•	•	•	•	•	•	•		
		K23F	300		•	•	•	•	•	•	•	•	•		
2pc Trunnion	Full Port	K21F-T	150											•	•
		K23F-T	300											•	•

Xomox®FK Ball Valves are available in the following configurations:

- Two-piece, raised face flanged ends
- Sizes 1/2" through 12"
- Pressure ratings ANSI Class 150 and 300
- Xomox FK ball valves provide tight shutoff from vacuum through rated pressure at temperatures up to 450°F (230°C)

Traceability

A stainless steel tag is attached to all manufactured and modified valves. It includes standard ANSI information and an individual serial number.

Testing

Each valve is tested according to API 598.

Features Include

- Full bore design
- Face-to-face dimension long pattern ASME B16.10
- Raised face flange dimension per ASME B16.5
- Self-relieving seats
- Fire tested API 607 6th edition & ISO 10497:2010
- Anti-static design (electrical continuity between ball-stem-body)
- Blow-out proof stem
- Actuator mounting flange according to ISO 5211
- Patented SX stem seal for side load protection
- Fugitive emissions per EPA Method-21, ISO-15848, & TA-Luft (VDI 2440)

Soft-Seated Ball Valves Designed to ASME Standards

Xomox FK valves are designed in accordance with ASME B16.34, API-608, API-6D. These ball valves feature a full-port split body design, and the option of a locking hand lever or an enclosed operating gear and hand wheel.

Superior Sealing

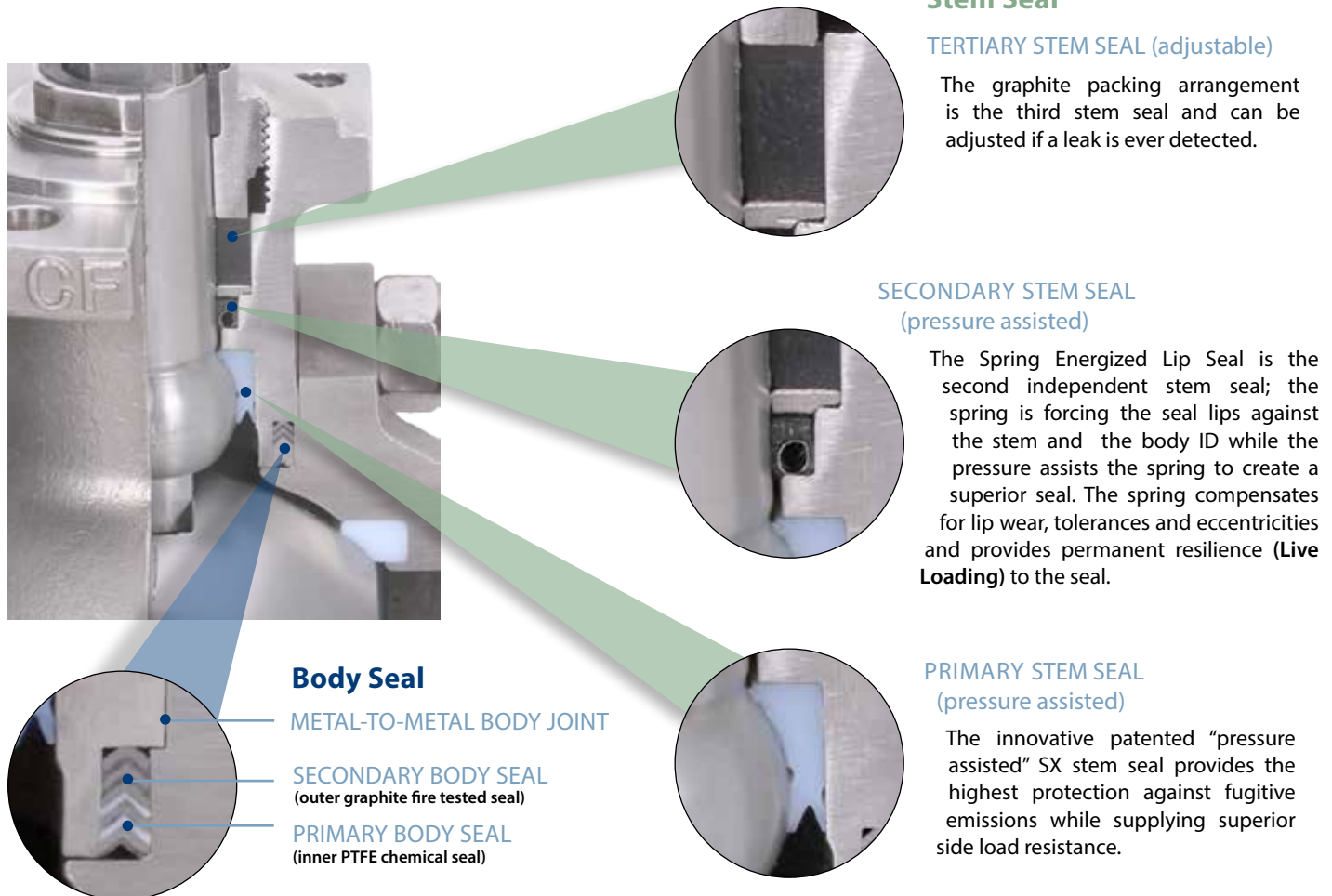

Stem Seal

TERTIARY STEM SEAL (adjustable)

The graphite packing arrangement is the third stem seal and can be adjusted if a leak is ever detected.

SECONDARY STEM SEAL

(pressure assisted)

The Spring Energized Lip Seal is the second independent stem seal; the spring is forcing the seal lips against the stem and the body ID while the pressure assists the spring to create a superior seal. The spring compensates for lip wear, tolerances and eccentricities and provides permanent resilience (**Live Loading**) to the seal.

PRIMARY STEM SEAL

(pressure assisted)

The innovative patented “pressure assisted” SX stem seal provides the highest protection against fugitive emissions while supplying superior side load resistance.

Body Seal

METAL-TO-METAL BODY JOINT

SECONDARY BODY SEAL
(outer graphite fire tested seal)

PRIMARY BODY SEAL
(inner PTFE chemical seal)

Thermal Cycling Protection

To combat the effects of pressure and temperature fluctuations, our dual-material body gasket is supplied as standard and offers chemical seal and fire-safe operation.

The Thermal Cycling Challenge

Most PTFE body gaskets work well at static temperatures; the real challenge comes when you introduce a wide temperature swing. In a standard gasket seal design, thermal cycle can cause a leak due to difference in the thermal expansion between the PTFE body seal and the metal body joint.

The need for a gasket to have the ability to recover cannot be over emphasized. The effects of pressure and temperature fluctuations, the temperature differential across the body joint, together with bolt stress relaxation and creep, demand a gasket with adequate flexibility and recovery to maintain a seal even under these varying service conditions.

The Xomox FK body gasket design uses a dual material spiral wound body gasket with a PTFE chemically inert inner seal and a secondary graphite fire-tested outer seal.

The spiral wound gasket is an industry proven design providing structural support and “Live Loading” via the metal spiral “v” shape rings. These “v” rings located in the fully-contained body groove protect the PTFE and graphite seals from extrusion and cold flow during thermal cycles.

Side Load Protection

THE PROBLEM:

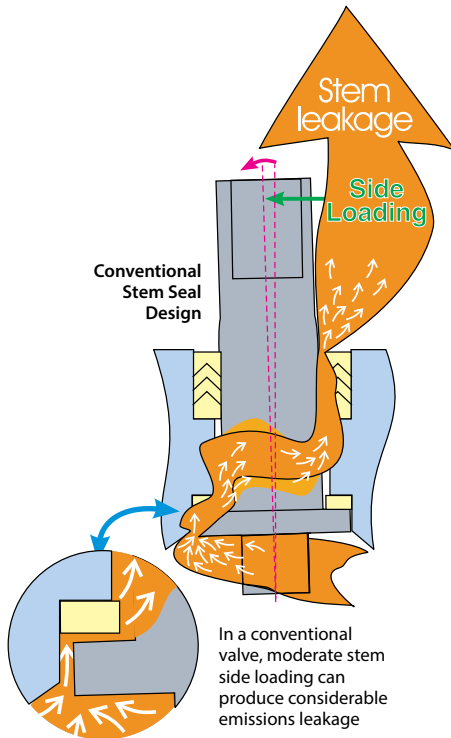

The most common problem with traditional ball valve designs is stem seal leakage.

A primary cause of stem seal failure is due to side loads on the stem. This failure becomes a serious safety issue when the valves are used on hazardous applications common to the chemical process industry.

In a conventional valve, moderate stem side loading can lead to significant emissions issues. Side loading can be caused by manual operation, abusive contact, and actuation loads due to misalignment.

THE SOLUTION:

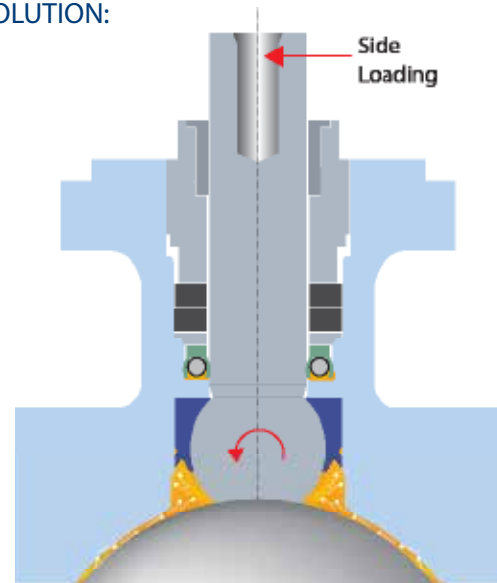

The Xomox FK ball valve sealing system provides a triple stem seal. The primary seal is the patented SX spherical stem seal that compensates for stem movement and seat wear caused by side loads and high-cycle applications.

When the stem is in a side load situation, either internal or external to the valve, the pressure between the spherical surface of the stem and SX seal remains constant, leading to a superior external seal.

The spherical ball shape of the stem and the mating SX seal combine to provide a compression seal which is enhanced by the addition of a "V" lip design feature that is also in compression and is pressure assisted.

This patented SX seal system makes it possible to provide a valve design that offers significant advantages including longer lifespan, greater leak prevention and improved safety, which is especially important when handling hazardous media.

Our customers can now order a standard off-the-shelf ball valve with triple top seals for maximum emissions protection.

Typical Side Load Issues

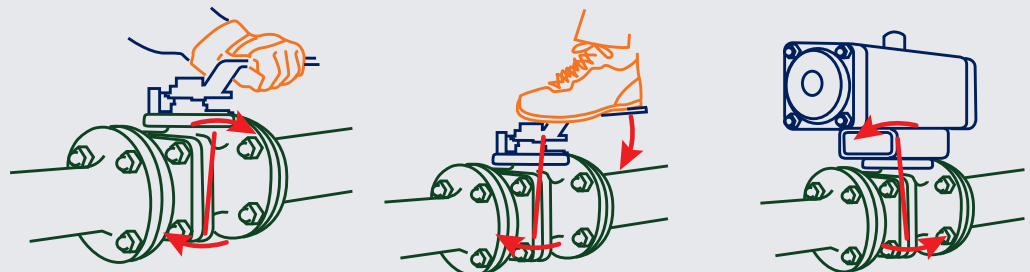

Applications

Xomox FK ball valves deliver economical solutions for the vast majority of chemical applications while maintaining the highest possible degree of performance in terms of in-line leakage and fugitive emissions.

FK Ball Valve - Performance Chart

FUNCTION		MEDIA TYPES										APPLICATION REQUIREMENTS										
On / Off	Throttling	Clean Liquids & Gases	Dirty Liquids & Gases	Corrosive Liquids & Gases	Hazardous Liquids & Gases	Viscous Liquids	Scaling Liquids & Slurries	Abrasive Slurries	Fibrous Slurries	Dry Materials	Vacuum Service	High Flow Capacity	Low Torque	Fugitive Emissions Control	Reduced Maintenance	Extended Service Life	Sizes	Pressure Ratings	High Temperature (ASME/EN)	Low Temperature	Key Benefit	
●	●	●	●	●	●	●	●	●	●	●	●	●	●	●	●	●	1/2" - 12"	DN15/DN300	Class 150/300	450°F / 230°C	-20°F / -29°C	Safety / Economy

● Superior Performance ● Limited Application

Source: Crane Engineering

They are commonly used within the following industries:

- Chlor-Alkali
- Industrial Chemicals
- Metal and Mining
- Nitrogen and Phosphate Fertilizers
- Refining
- Petrochemical

Special Application Services:

- NACE
- Chlorine
- Oxygen

Special Materials:

- WCB and CF8M standard body materials
- Higher alloys available (Example: Alloy-20, Monel, Inconel & Hastelloy C)

Technical Specifications

Floating Ball Type

CL150 - K21F
 CL300 - K23F
 Full Port 1/2" - 8"
 ASME/ANSI B16.10
 Long Pattern

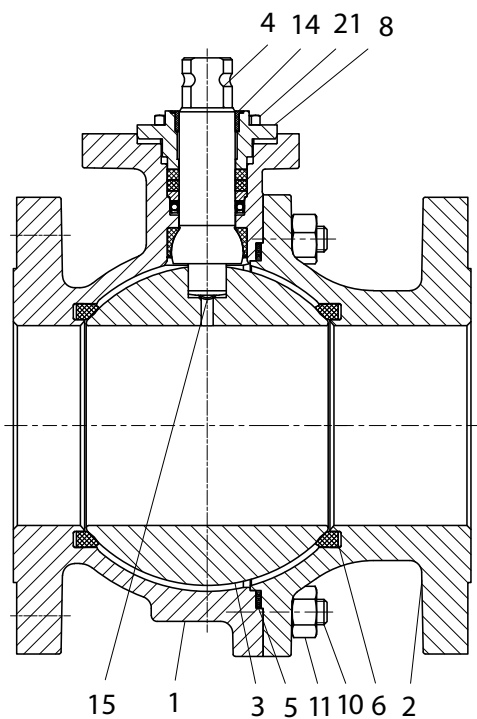

Materials of Construction

	Description	Carbon Steel	Stainless Steel
1	Body	ASTM A216 Gr WCB	ASTM A351 Gr CF8M
2	Tail	ASTM A216 Gr WCB	ASTM A351 Gr CF8M
3	Ball	316ss	316ss
4	Stem	UNS S31803	UNS S31803
5	Body Gasket	PTFE/Graphite/316ss	PTFE/Graphite/316ss
6	Seat	TFM	TFM
7	SX Stem Seal	TFM	TFM
8	Packing Gland	316ss	316ss
9	Support Ring	316ss	316ss
10	Stud	ASTM A193 Gr B7	ASTM A193 Gr B8M Cl.2
11	Heavy Hex Nut	ASTM A194 Gr.2H	ASTM A194 Gr.8M
12	Spring-energized Lip Seal	PTFE Filled/SST	PTFE Filled/SST
13	Packing	Graphite	Graphite
14	Guide Bushing	PTFE-Carbon filled	PTFE-Carbon filled
15	Anti-static Spring	SST	SST
*16	Stop Pin	316ss	316ss
*17	Hand Lever	316ss	316ss
*18	Socket Head Cap Screw	316ss	316ss
*19	Hex Nut	316ss	316ss
*20	Locking Pin with Ring	316ss	316ss
**21	Packing Adjustment Bolt	ASTM A193 Gr.B8M Cl.2	ASTM A193 Gr.B8M Cl.2

*Not shown

** Only on 4"-8"

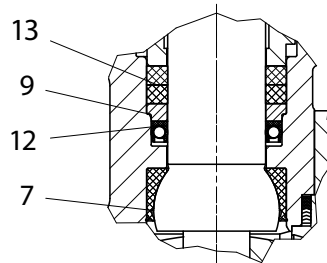

Technical Specifications

Trunnion Ball Type

CL150 - K21F-T
 CL300 - K23F-T
 Full Port 10" - 12"
 ASME/ANSI B16.10
 Long Pattern

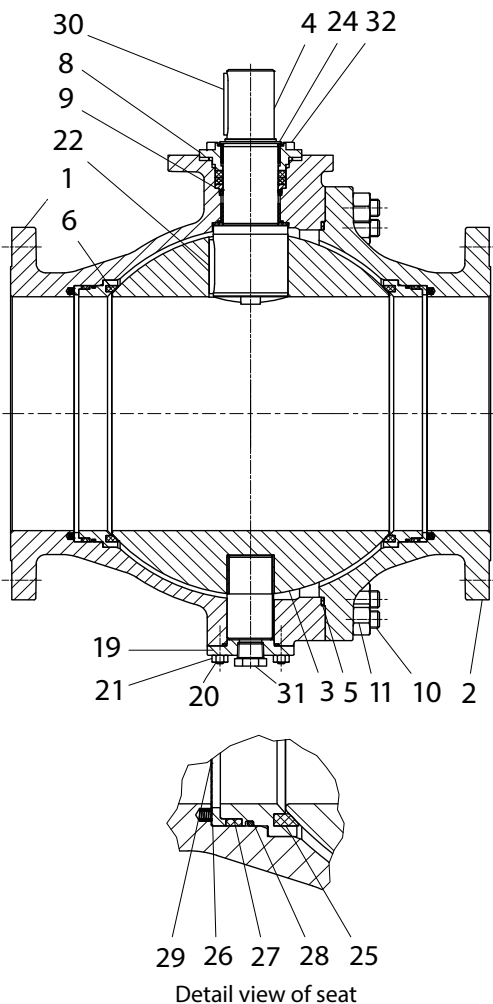

Materials of Construction

Item	Description	Carbon Steel	Stainless Steel
1	Body	ASTM A216 Gr WCB	ASTM A351 Gr CF8M
2	Tail	ASTM A216 Gr WCB	ASTM A351 Gr CF8M
3	Ball	316ss	316ss
4	Stem	UNS S31803	UNS S31803
5	Body Gasket	PTFE/Graphite/316ss	PTFE/Graphite/316ss
6	Seat	TFM	TFM
7	Stem Seal	TFM	TFM
8	Packing Gland	316ss	316ss
9	Support Ring	316ss	316ss
10	Stud	ASTM A193 Gr B7	ASTM A193 Gr B8M Cl.2
11	Heavy Hex Nut	ASTM A194 Gr.2H	ASTM A194 Gr.8M
12	Spring-energized Lip Seal	PTFE Filled/SST	PTFE Filled/SST
13	Packing	Graphite	Graphite
14	Flange Bearing	Reinforced Thermoplastic	Reinforced Thermoplastic
16	Sleeve Bearing	Reinforced Thermoplastic	Reinforced Thermoplastic
17	Bottom Stem	316ss	316ss
18	Gasket	PTFE/Graphite/316ss	PTFE/Graphite/316ss
19	Cover	316ss	316ss
20	Stud	ASTM A193 Gr. B7	ASTM A193 Gr. B8 Cl.2
21	Heavy Hex Nut	ASTM A194 Gr.2H	A194 Gr.8M
22	Parallel Key	316ss	316ss
24	Retaining Ring	SST	SST
25	Seat Retaining Ring	316ss	316ss
26	L-Ring	316ss	316ss
27	Seal Ring	Graphite	Graphite
28	O-Ring	Viton	Viton
29	Spring	SST	SST
30	Parallel Key	316ss	316ss
31	Pipe Plug	316ss	316ss
32	Packing Adjustment Bolt	ASTM A193 Gr.B8M Cl.2	ASTM A193 Gr.B8M Cl.2

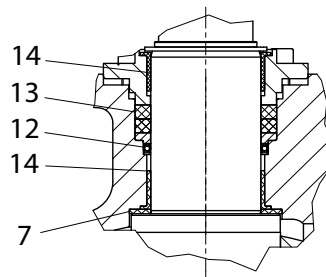

Detail view of top stem

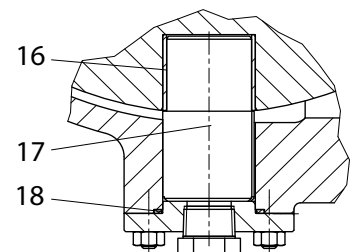





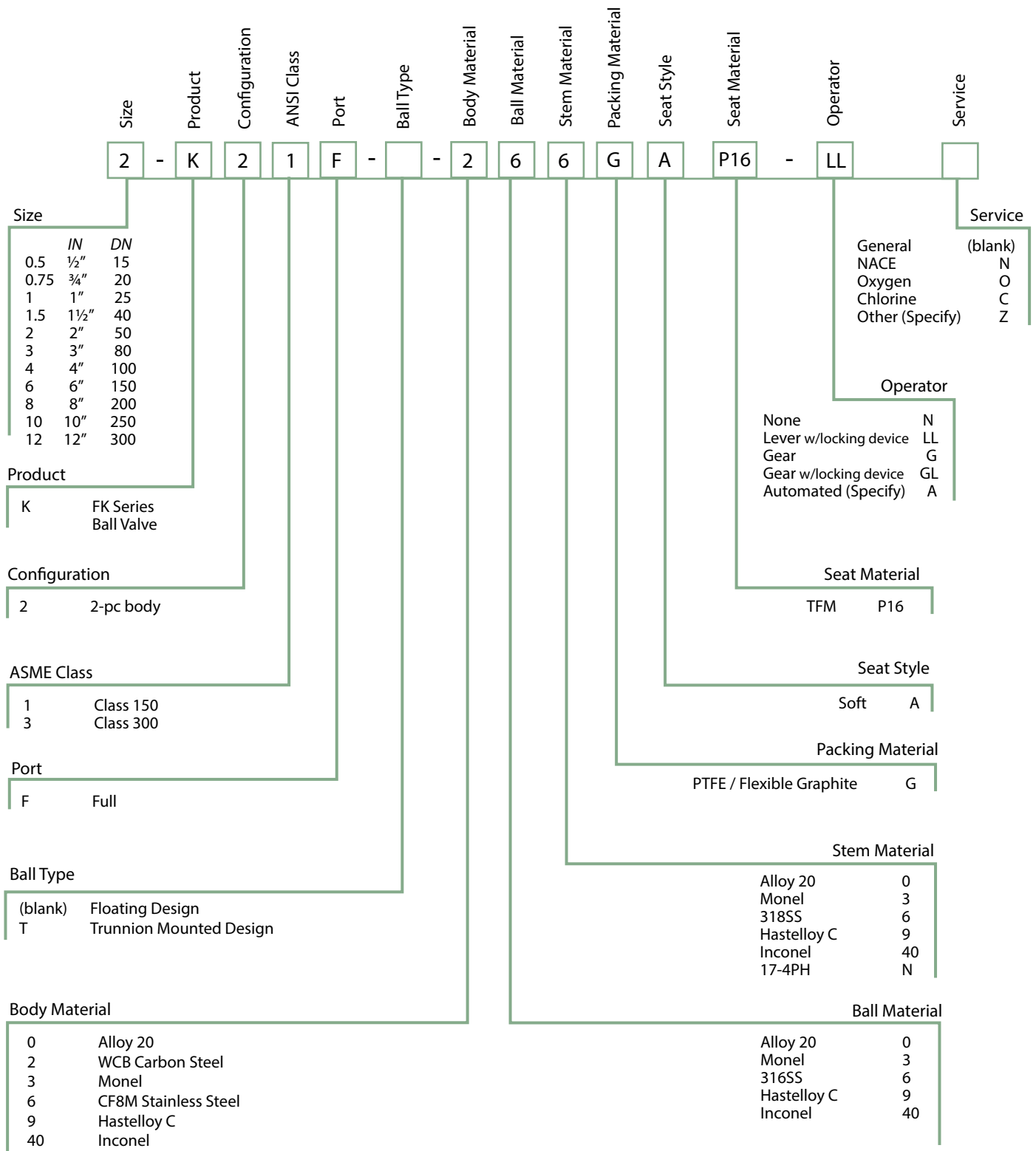



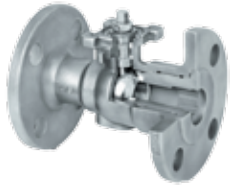

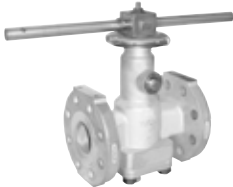

Detail view of bottom stem

How To Order



Comprehensive Product Portfolio

<p>BALL VALVES</p>				
<p>Xomox FK 2 Piece</p>	<p>Xomox Reduced Bore 1 Piece</p>	<p>Xomox 2 Piece</p>	<p>Xomox 3 Piece</p>	
<p>PLUG VALVES</p>				
<p>Xomox 2 Way Flanged Sleeve Plug Valve</p>	<p>Xomox XP Sleeved Plug Valve</p>	<p>Xomox Severe Service Valve</p>	<p>Xomox HF Sleeve Plug Valve</p>	
<p>LINED PRODUCTS</p>				
<p>Xomox Lined Plug Valve</p>	<p>Xomox Lined Butterfly Valve</p>	<p>Xomox Lined Ball Check Valve</p>	<p>Xomox Lined Ball Valve</p>	
<p>BUTTERFLY VALVES</p>			<p>ACTUATION</p>  <p>Xomox Actuators</p>	
<p>Xomox High-Performance Wafer Butterfly Valve</p>	<p>Xomox High-Performance Lug Butterfly Valve</p>			

XOMOX®

Crane ChemPharma & Energy
4444 Cooper Road
Cincinnati, Ohio 45242 U.S.A
Tel: +1 513 745 6000
Fax +1 513 745 6086
www.cranecpe.com

CRANE®



brands you trust.



CPE-XOMOX FK-SSBV-BU-EN-L15-6-4-2014

Crane Co., and its subsidiaries cannot accept responsibility for possible errors in catalogues, brochures, other printed materials, and website information. Crane Co. reserves the right to alter its products without notice, including products already on order provided that such alteration can be made without changes being necessary in specifications already agreed. All trademarks in this material are property of the Crane Co. or its subsidiaries. The Crane and Crane brands logotype, in alphabetical order, (ALOYCO®, CENTER LINE®, COMPAC-NOZ®, CRANE®, DEPA® & ELRO®, DUO-CHEK®, FLOWSEAL®, JENKINS®, KROMBACH®, NOZ-CHEK®, PACIFIC®, RESISTOFLEX®, REVO®, SAUNDERS®, STOCKHAM®, TRIANGLE®, UNI-CHEK®, WTA®, and XOMOX®) are registered trademarks of Crane Co. All rights reserved.