



AIR CONDITIONER

Wall Mounted type

DESIGN & TECHNICAL MANUAL

for Extra Cold Climate Area

INDOOR



ASU9RLS3
ASU12RLS3
ASU15RLS3

OUTDOOR



AOU9RLS3H
AOU12RLS3H
AOU15RLS3H

FUJITSU GENERAL LIMITED

1. INDOOR UNIT

WALL MOUNTED TYPE :

ASU9RLS3

ASU12RLS3

ASU15RLS3

CONTENTS

1. INDOOR UNIT

1. FEATURES	01 - 01
2. WIRELESS REMOTE CONTROLLER	01 - 04
3. SPECIFICATIONS	01 - 06
4. DIMENSIONS	01 - 07
5. WIRING DIAGRAMS	01 - 09
6. CAPACITY TABLE	01 - 10
6-1. COOLING CAPACITY.....	01 - 10
6-2. HEATING CAPACITY.....	01 - 13
7. FAN PERFORMANCE	01 - 15
7-1. AIR VELOCITY DISTRIBUTION.....	01 - 15
7-2. AIRFLOW.....	01 - 17
8. OPERATION NOISE	01 - 19
8-1. NOISE LEVEL CURVE.....	01 - 19
8-2. SOUND LEVEL CHECK POINT.....	01 - 21
9. SAFETY DEVICES	01 - 22
10. EXTERNAL INPUT & OUTPUT	01 - 23
10-1. EXTERNAL INPUT.....	01 - 23
10-2. EXTERNAL OUTPUT.....	01 - 25
11. FUNCTION SETTINGS	01 - 27
11-1. INDOOR UNIT (Setting by remote controller).....	01 - 27
12. OPTIONAL PARTS	01 - 33
12-1. CONTROLLER.....	01 - 33
12-2. OTHERS.....	01 - 33

1. FEATURES

MODEL

ASU9RLS3 / AOU9RLS3H
ASU12RLS3 / AOU12RLS3H
ASU15RLS3 / AOU15RLS3H



FEATURES

Energy efficiency

	Extra Cold Climate Area Model		
	ASU9RLS3	ASU12RLS3	ASU15RLS3
Seasonal Energy Efficiency Ratio (SEER)	33.0	29.3	25.3
Heating Seasonal Performance Factor (HSPF)	14.0	13.8	13.3

MEASUREMENT CONDITIONS
ANSI/ASHRAE STANDARD 37-1988

High efficient design

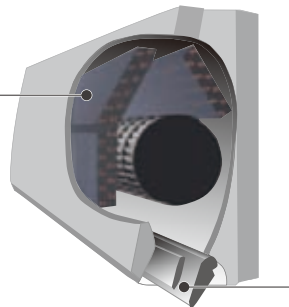
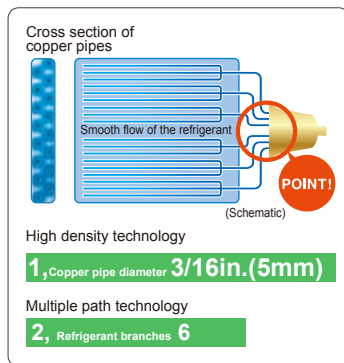

More comfortable airflow

Power diffuser

Vertical airflow provides powerful floor level heating.

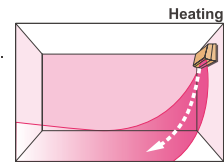

Horizontal airflow does not blow cool air directly at occupants in the room.

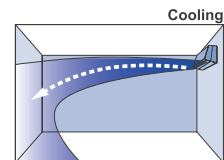

Low outdoor air temperature correspondence

Corresponds to heating operation at -15°F (-26°C) outdoor air temperature

Heating
-15 to 75°F (-26 to 24°C)

Specification improvement to allow operation under extremely low outdoor temperature -15°F (-26°C) without trouble

Extra cold climate area model

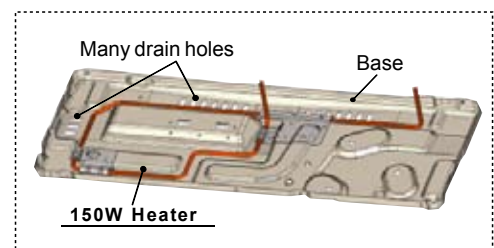
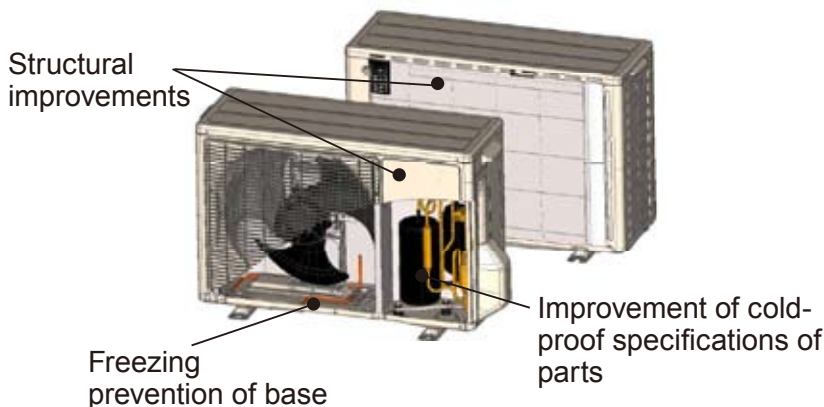

● **Powerful operation** *Only available with Wireless RC.

20 minutes continuous operation by maximum airflow and maximum compressor speed is possible. Rapid cooling and heating makes the room comfortable quickly.

Example : Cooling operation

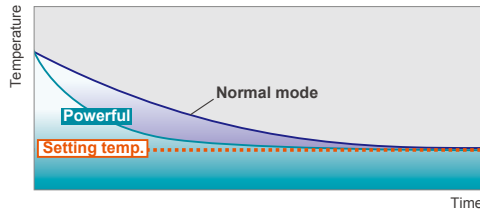

● **Energy saving Program** *Only available with Wireless RC.

Human sensor catches movements of people in a room, and operates with lower capacity when the room is empty. When people come back to the room, it automatically returns to previous operating mode.

Energy saving operation by detecting someone's movement



● **MIN. HEAT Operation** *Only available with Wireless RC.

The room temperature can be set to go no lower than 50°F (10°C), thus ensuring that the room does not get too cold when not occupied

Caution)

- When the room temperature is higher than 50°F (10°C), "MIN. HEAT" operation will not start. Operation starts and maintains the room temperature at 50°F (10°C) when the temperature drops below 50°F (10°C).
- When "MIN. HEAT" operation stops, the room set temperature quickly returns to the preset temperature.

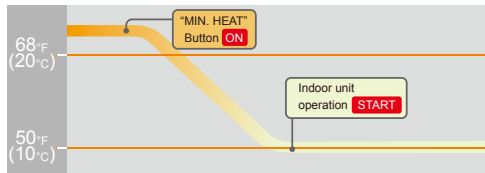

● **Outdoor unit low noise** *Only available with Wireless RC.

When air-conditioner operates in large capacity, operation noise of outdoor unit will be suppressed. In case of room temperature being close to setting temperature, operation noise might not decrease.

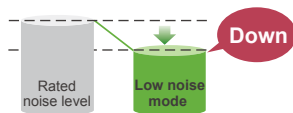

● **Economy operation**

Example : Cooling operation

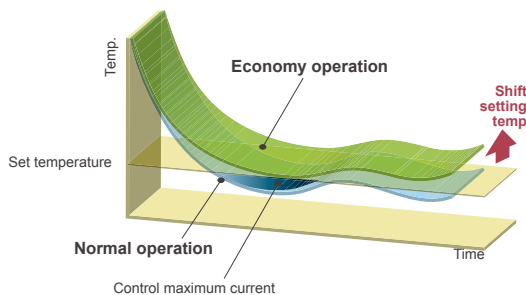

- Economy operation is energy saving, as the set temperature of indoor unit is shifted by 2°F (1°C) and the maximum electric value of the outdoor unit is suppressed.

● **5 Mode timer (ON/OFF/Weekly/Program/Sleep)** *Only available with Wireless RC.

Weekly timer can be easily set by wireless remote controller.
ON, OFF can be set up to 4 times in 1 day and up to 28 times in 1 week.
For other modes, program timer and sleep timer can be also selected by one push.

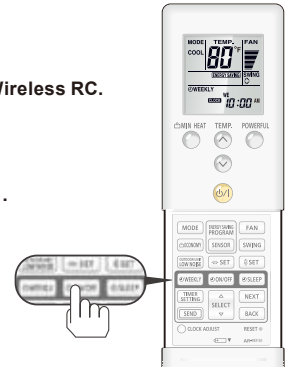

● **Low outdoor air temperature correspondence**

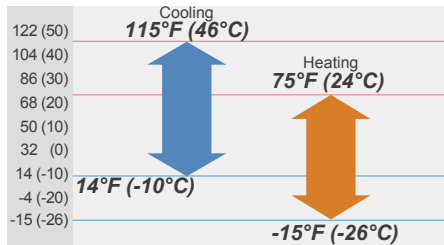

2. WIRELESS REMOTE CONTROLLER

FEATURES



- * 5 Mode timer setup available (ON / OFF / Weekly / Program / Sleep).
- * Easy operation.
- * Easy to change custom code (max. 4 custom codes) by button operation.

● Built-in timers

Select from 5 Mode timer programs (ON / OFF / Weekly / Program / Sleep).

● Weekly timer

Weekly timer can be easily set by wireless remote controller.
ON, OFF can be set up to 4 times in 1 day and up to 28 times in 1 week.

● Program timer

The program timer operates the on and off timer once within a 24 hour period.

● Sleep timer

The sleep timer function automatically corrects the temperature thermostat setting according to the timer setting to prevent excessive cooling and heating while sleeping.

Cooling operation/dry operation

When the sleep timer is set, the set temperature automatically rises 2°F (1°C) every hour. The set temperature can rise up to a maximum of 4°F (2°C).

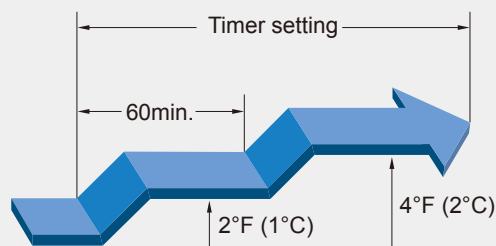

Heating operation

When the sleep timer is set, the set temperature automatically drops 2°F (1°C) every 30 minutes. The set temperature can drop to a maximum of 8°F (4°C).

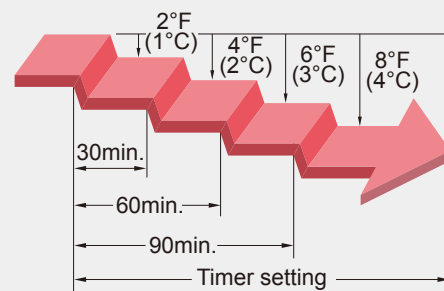

● Simple function setting

Setting of the air conditioner selection function is performed by remote controller.

● Switching remote controller custom code

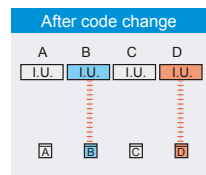
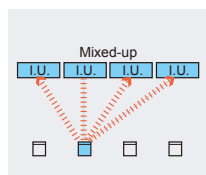

- Code selector switch eliminates unit being wrongly switched. (Up to 4 codes can be set.)
- *I.U.=Indoor unit

● To change the temperature unit

Easy to change the temperature unit (°F ↔ °C) by button operation.

FUNCTIONS

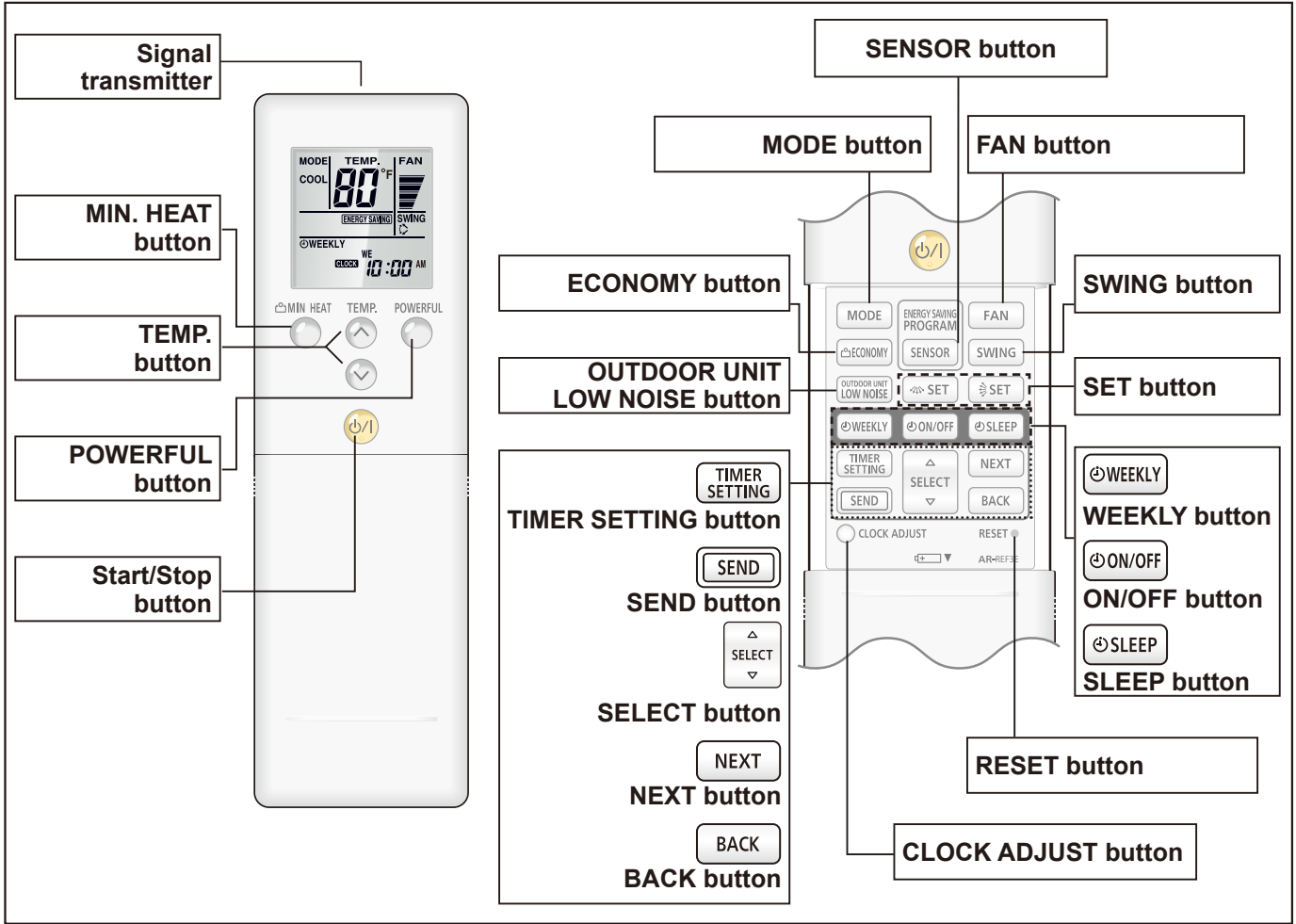

Display panel

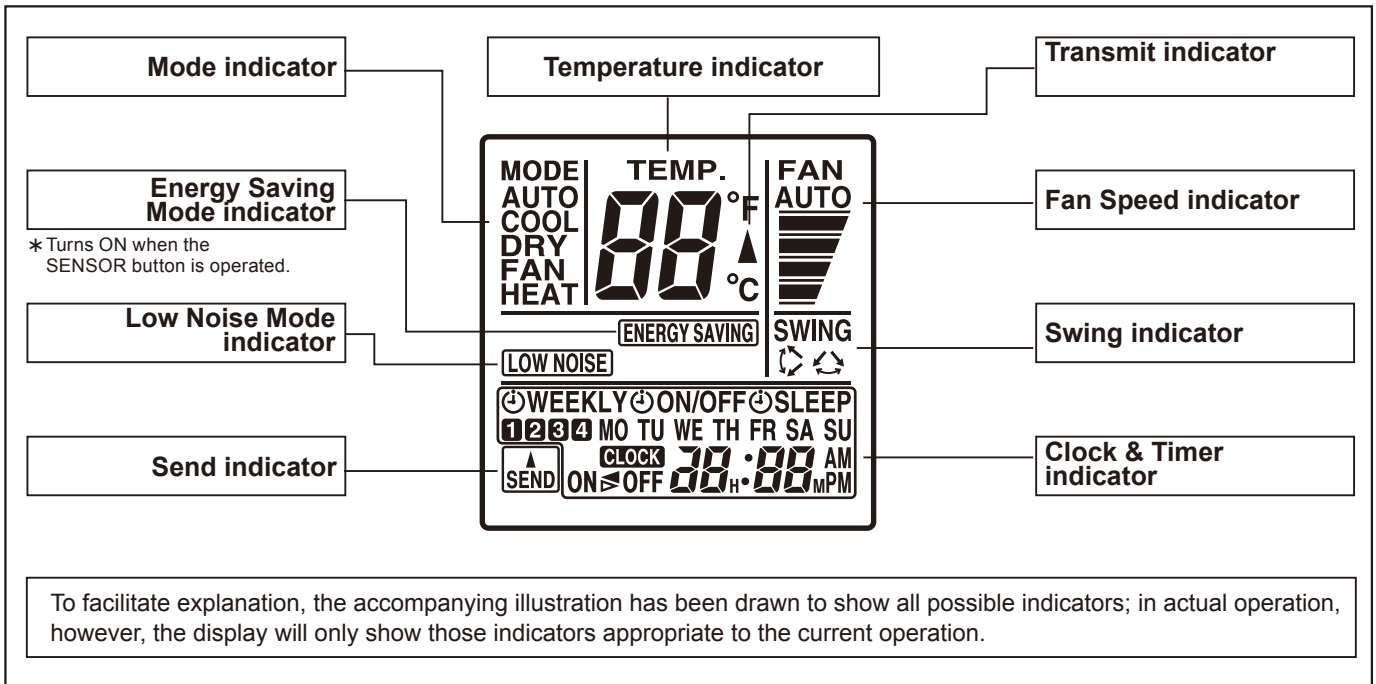

SPECIFICATION

DIMENSIONS [H × W × D]: in. (mm)	8-1/16 (205) × 2-3/8 (61) × 11/16 (17)
WEIGHT oz. (g)	4.3 (122)
ACCESSORY	Holder

3. SPECIFICATIONS

Type				WALL MOUNTED		
				INVERTER HEAT PUMP		
Model name				ASU9RLS3	ASU12RLS3	ASU15RLS3
Power source				208 / 230V ~ 60Hz		
Available voltage range				188 - 253V		
Capacity	Cooling	Rated	kW	2.64	3.52	4.25
			Btu/h	9,000	12,000	14,500
		Min - Max	kW	0.90 - 3.60	0.90 - 4.00	0.90 - 5.40
	Btu/h		3,100 - 12,000	3,100 - 13,600	3,100 - 18,400	
	Heating	Rated	kW	3.52	4.69	5.28
			Btu/h	12,000	16,000	18,000
Min - Max		kW	0.90 - 6.45	0.90 - 6.48	0.90 - 7.00	
	Btu/h	3,100 - 22,000	3,100 - 22,100	3,100 - 23,900		
Input power	Cooling	Rated	kW	0.50	0.79	1.04
				Max	0.85	0.99
	Heating	Rated	0.66	1.01	1.15	
			Max	1.93	1.94	2.19
Current	Cooling	Rated	A	2.5	3.8	4.8
	Heating			3.3	4.7	5.2
EER	Cooling		kW/kW	5.28	4.46	4.09
				Btu/hW	18.0	15.2
COP	Heating		kW/kW	5.33	4.64	4.59
				Btu/hW	18.2	15.8
SEER	Cooling		Btu/hW	33.0	29.3	25.3
HSPF	Heating		Btu/hW	14.0	13.8	13.3
Power factor	Cooling		%	87	90	94
	Heating			87	93	96
Moisture removal			pints/h (l/h)	2.6 (1.2)	2.7 (1.3)	4.0 (1.9)
Maximum operating current *1		Cooling	A	9.4	9.4	9.9
		Heating		11.9	11.9	14.9
Fan	Airflow rate	Cooling	CFM (m ³ /h)	High	489(830)	547(930)
				Med	400(680)	459(780)
				Low	341(580)	371(630)
				Quiet	224(380)	259(440)
		Heating	High	489(830)	547(930)	
			Med	400(680)	459(780)	
			Low	341(580)	371(630)	
			Quiet	224(380)	294(500)	
	Type × Q'ty		Cross flow fan × 1			
	Motor output		W			
		61				
Sound pressure level *2	Cooling	dB (A)	High	42	45	
			Med	37	40	
			Low	32	34	
			Quiet	23	26	
	Heating	High	41	45		
		Med	35	39		
		Low	31	33		
		Quiet	23	27		
Heat exchanger type	Dimensions (H × W × D)		in. (mm)	Main : 15-1/8 × 28-3/8 × 1-3/16 (384 × 720 × 30) Sub : 3-5/16 × 28-3/8 × 1/2 (84 × 720 × 13.3) 4-15/16 × 28-3/8 × 1/2 (126 × 720 × 13.3)		
	Fin pitch		FPI	Main : 21 Sub : 18		
	Rows × Stages			Main : 3 × 24 Sub : 1 × 10		
	Pipe type			Copper		
	Fin type			Aluminum		
Enclosure	Material			Polystyrene		
	Color			White Approximate color of MUNSELL 5PB 9.25/0.5		
Dimensions (H × W × D)	Net		inch	11 - 5/8 × 37 × 10 - 5/8		
			mm	295 × 940 × 270		
	Gross		inch	14 - 3/8 × 40 - 15/16 × 14		
			mm	365 × 1,040 × 355		
Weight	Net		lbs. (kg)	31 (14.0)		
				Gross	37 (17.0)	
Connection pipe	Size	Liquid	in. (mm)	Ø1/4 (Ø6.35)		
		Gas		Ø3/8 (Ø9.52)	Ø1/2 (Ø12.7)	
	Method			Flare		
Operation range	Cooling		°F (°C)	64 to 90 (18 to 32)		
			%RH	80 or less		
	Heating		°F (°C)	60 to 88 (16 to 30)		
Remote controller type				Wireless		
Drain hose	Material			PP+LLDPF		
	Size		in. (mm)	Ø9/16 (Ø13.8) (I.D.) Ø5/8 to Ø11/16 (Ø15.8 to Ø16.7) (O.D.)		

NOTE :

* Specifications are based on the following conditions.

Cooling : Indoor temperature of 80°F (26.67°C) DB / 67°F (19.44°C) WB, and outdoor temperature of 95°F (35°C) DB / 75°F (23.9°C) WB.

Heating : Indoor temperature of 70°F (21.11°C) DB / 59°F (15°C) WB, and outdoor temperature of 47°F (8.33°C) DB / 43°F (6.11°C) WB.

Pipe length : 24ft.7in (7.5m), Height difference:0 m. (Outdoor unit-Indoor unit)

* The protective function might work when using it outside the operation range.

*1: The maximum current is the maximum value when operated within the operation range.

*2: These are the measured values in the manufacturer's anechoic chamber.

Because of the surrounding sound environment, the sound levels measured in actual installation conditions might be higher than the specified values here.

4. DIMENSIONS

MODEL: ASU9RLS3, ASU12RLS3, ASU15RLS3

Unit : in. (mm)

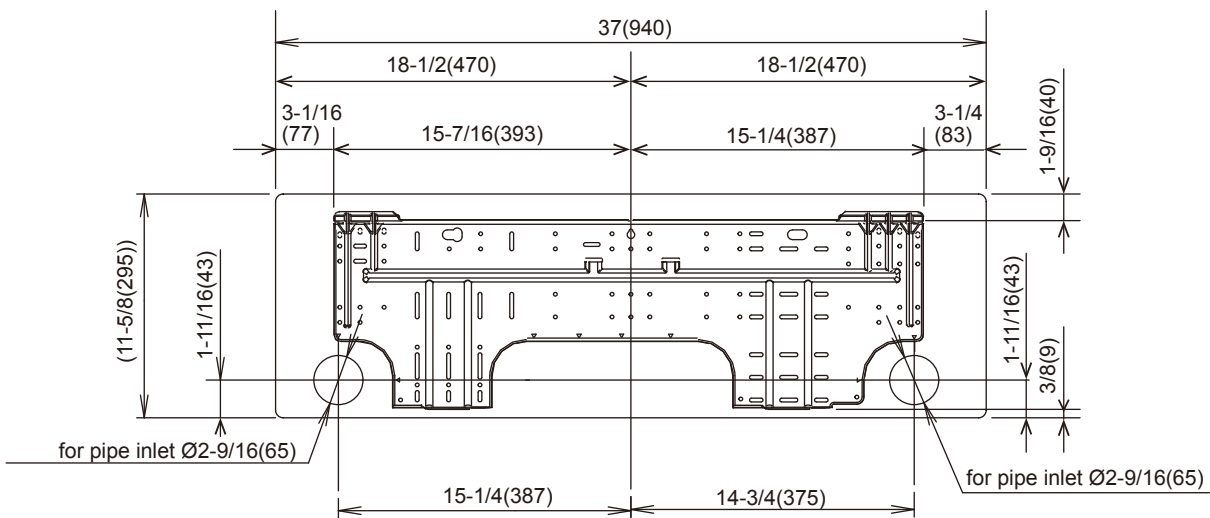
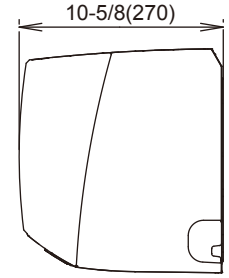
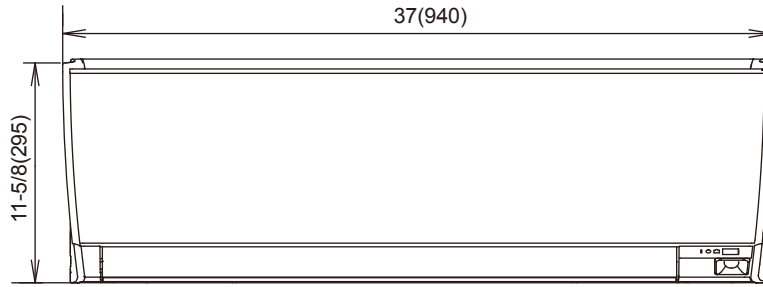

		ASU9RLS3	ASU12RLS3	ASU15RLS3
Refrigerant pipe flare connection	Liquid	Ø 1/4 in. (Ø 6.35 mm)		
	Gas	Ø 3/8 in. (Ø 9.52 mm)	Ø 1/2 in. (Ø 12.7 mm)	
Drain hose connection	Drain hose	(Ø 9/16 in. (I.D.), Ø 5/8 to Ø 11/16 in. (O.D.) [Ø 13.8 mm (I.D.), Ø 15.8 to 16.7 mm (O.D.)]		

■ INSTALLATION PLACE

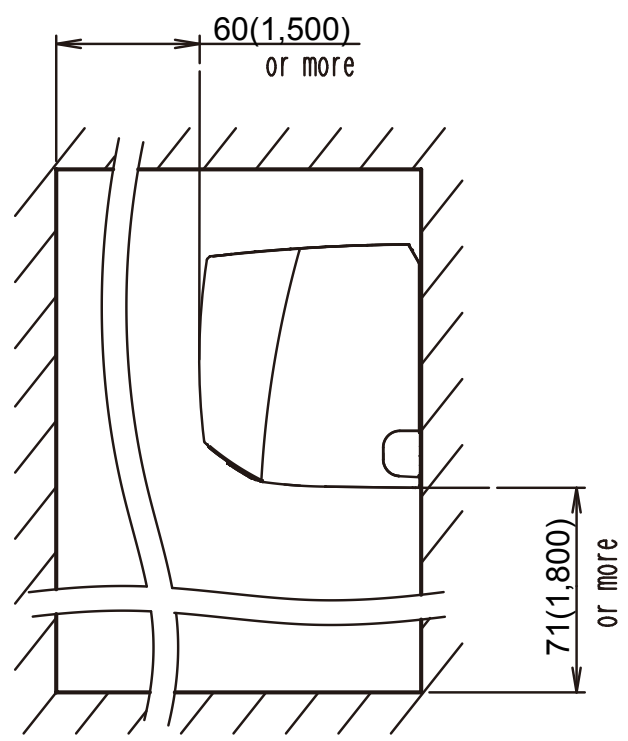
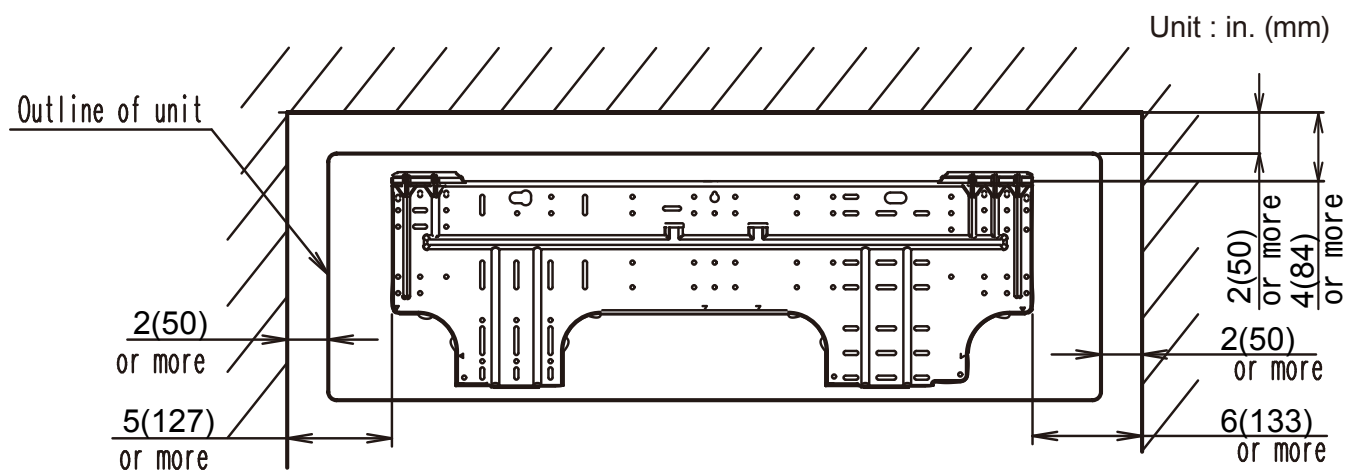

5. WIRING DIAGRAMS

MODEL: ASU9RLS3, ASU12RLS3, ASU15RLS3

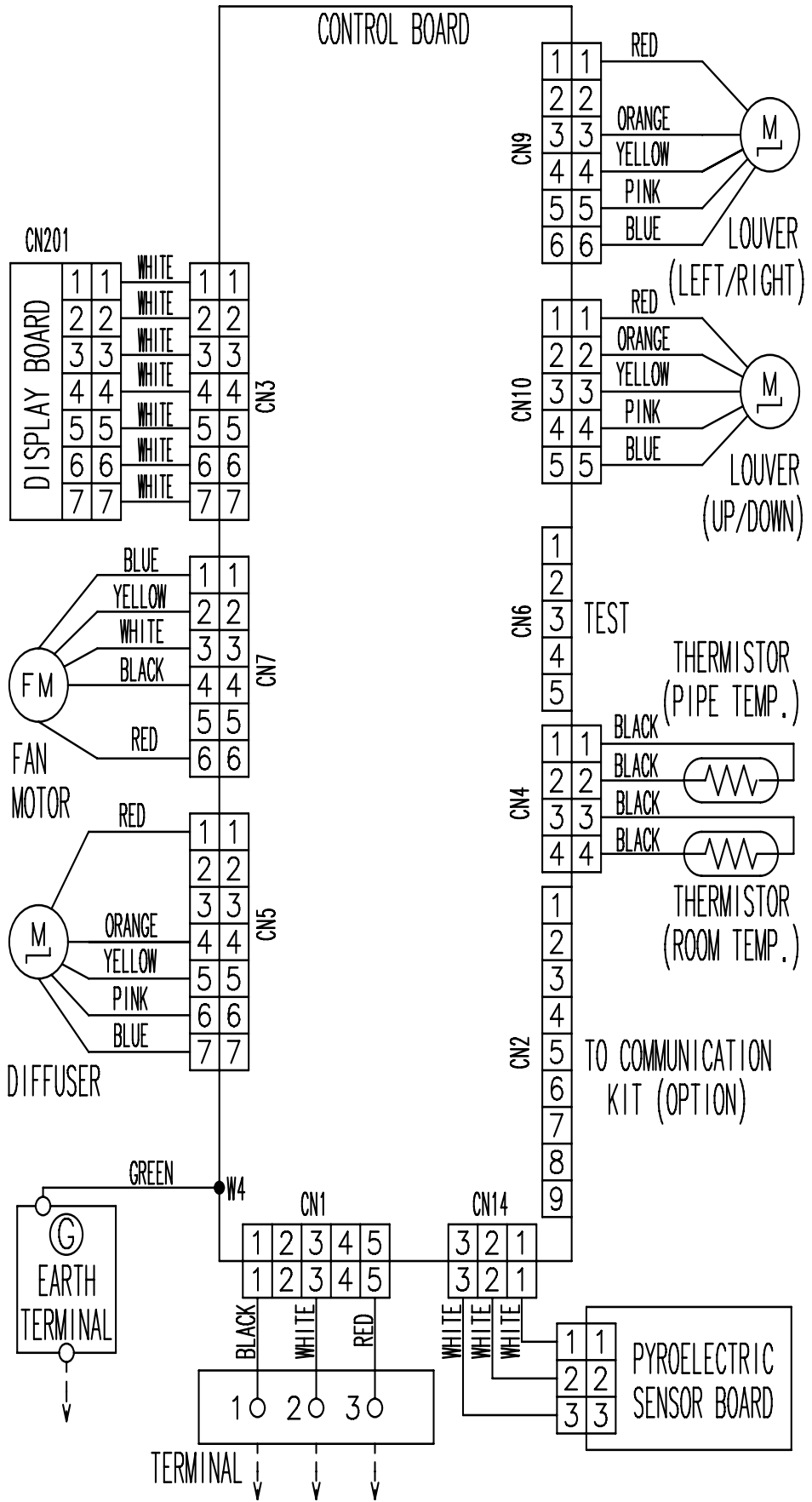

6. CAPACITY TABLE

6-1. COOLING CAPACITY

■ MODEL: ASU9RLS3

AFR	489
-----	-----

		Indoor temperature																	
		64			70			75			80			85			90		
		54			60			63			67			71			73		
Outdoor temperature	°FDB	TC	SHC	IP	TC	SHC	IP	TC	SHC	IP	TC	SHC	IP	TC	SHC	IP	TC	SHC	IP
	15	8.33	8.06	0.19	9.29	8.11	0.19	10.25	8.87	0.20	10.57	9.53	0.20	11.17	9.50	0.20	11.81	10.07	0.21
	23	8.16	7.88	0.22	9.09	7.91	0.22	10.03	8.65	0.23	10.35	9.31	0.22	10.94	9.28	0.22	11.56	9.91	0.23
	32	7.99	7.69	0.22	8.90	7.75	0.23	9.81	8.45	0.24	10.13	9.16	0.23	10.70	9.09	0.23	11.32	9.68	0.24
	41	7.81	7.58	0.24	8.71	7.61	0.24	9.60	8.28	0.25	9.90	8.97	0.24	10.47	8.90	0.24	11.07	9.50	0.25
	50	7.64	7.36	0.22	8.51	7.41	0.22	9.38	8.07	0.24	9.68	8.76	0.23	10.24	8.70	0.23	10.83	9.26	0.24
	59	7.47	7.24	0.27	8.32	7.27	0.27	9.16	7.91	0.28	9.46	8.57	0.28	10.01	8.51	0.28	10.58	9.08	0.28
	67	8.42	8.15	0.34	9.38	8.18	0.35	10.33	8.94	0.36	10.67	9.63	0.36	11.28	9.59	0.36	11.93	10.18	0.37
	77	8.01	7.74	0.39	8.93	7.77	0.39	9.85	8.49	0.40	10.16	9.15	0.40	10.74	9.11	0.41	11.35	9.73	0.41
	87	7.57	7.29	0.44	8.45	7.36	0.44	9.31	8.01	0.45	9.58	8.67	0.45	10.16	8.63	0.46	10.74	9.18	0.46
	95	7.09	6.88	0.48	7.91	6.91	0.49	8.73	7.53	0.50	9.00	8.15	0.50	9.55	8.12	0.51	10.06	8.63	0.51
	104	6.00	5.67	0.45	6.68	6.16	0.46	7.36	6.71	0.46	7.60	7.26	0.46	8.05	7.22	0.47	8.52	7.70	0.47
115	5.52	5.33	0.45	6.17	5.71	0.46	6.78	6.22	0.46	6.99	6.74	0.46	7.43	6.71	0.47	7.84	7.15	0.47	

AFR : Air Flow Rate (CFM)
 TC : Total Capacity (kBtu/h)
 SHC : Sensible Heat Capacity (kBtu/h)
 IP : Input Power (kW)

AFR	13.8
-----	------

		Indoor temperature																	
		17.8			21.1			23.9			26.7			29.4			32.2		
		12.2			15.6			17.2			19.4			21.7			22.8		
Outdoor temperature	°CDB	TC	SHC	IP	TC	SHC	IP	TC	SHC	IP	TC	SHC	IP	TC	SHC	IP	TC	SHC	IP
	-10.0	2.44	2.36	0.19	2.72	2.38	0.19	3.00	2.60	0.20	3.10	2.79	0.20	3.27	2.78	0.20	3.46	2.95	0.21
	-5.0	2.39	2.31	0.22	2.67	2.32	0.22	2.94	2.53	0.23	3.03	2.73	0.22	3.21	2.72	0.22	3.39	2.90	0.23
	0.0	2.34	2.25	0.22	2.61	2.27	0.23	2.88	2.48	0.24	2.97	2.68	0.23	3.14	2.67	0.23	3.32	2.84	0.24
	5.0	2.29	2.22	0.24	2.55	2.23	0.24	2.81	2.43	0.25	2.90	2.63	0.24	3.07	2.61	0.24	3.25	2.79	0.25
	10.0	2.24	2.16	0.22	2.49	2.17	0.22	2.75	2.37	0.24	2.84	2.57	0.23	3.00	2.55	0.23	3.17	2.71	0.24
	15.0	2.19	2.12	0.27	2.44	2.13	0.27	2.69	2.32	0.28	2.77	2.51	0.28	2.93	2.49	0.28	3.10	2.66	0.28
	19.4	2.47	2.39	0.34	2.75	2.40	0.35	3.03	2.62	0.36	3.13	2.82	0.36	3.31	2.81	0.36	3.50	2.98	0.37
	25.0	2.35	2.27	0.39	2.62	2.28	0.39	2.89	2.49	0.40	2.98	2.68	0.40	3.15	2.67	0.41	3.33	2.85	0.41
	30.6	2.22	2.14	0.44	2.48	2.16	0.44	2.73	2.35	0.45	2.81	2.54	0.45	2.98	2.53	0.46	3.15	2.69	0.46
	35.0	2.08	2.02	0.48	2.32	2.03	0.49	2.56	2.21	0.50	2.64	2.39	0.50	2.80	2.38	0.51	2.95	2.53	0.51
	40.0	1.76	1.66	0.45	1.96	1.80	0.46	2.16	1.97	0.46	2.23	2.13	0.46	2.36	2.12	0.47	2.50	2.26	0.47
46.0	1.62	1.56	0.45	1.81	1.67	0.46	1.99	1.82	0.46	2.05	1.98	0.46	2.18	1.97	0.47	2.30	2.10	0.47	

AFR : Air Flow Rate (m³/min)
 TC : Total Capacity (kW)
 SHC : Sensible Heat Capacity (kW)
 IP : Input Power (kW)

MODEL: ASU12RLS3

AFR	489
-----	-----

		Indoor temperature																				
		°FDB			64			70			75			80			85			90		
		°FWB			54			60			63			67			71			73		
Outdoor temperature	°FDB	TC	SHC	IP	TC	SHC	IP	TC	SHC	IP	TC	SHC	IP	TC	SHC	IP	TC	SHC	IP			
	15	10.34	9.52	0.28	11.53	9.58	0.28	12.72	10.47	0.29	13.11	11.30	0.29	13.87	11.21	0.29	14.67	11.96	0.30			
	23	10.26	9.44	0.33	11.44	9.47	0.33	12.62	10.34	0.35	13.01	11.19	0.34	13.77	11.12	0.34	14.56	11.85	0.35			
	32	10.18	9.35	0.36	11.36	9.39	0.36	12.52	10.27	0.38	12.91	11.09	0.37	13.67	11.03	0.38	14.45	11.78	0.39			
	41	10.10	9.30	0.39	11.27	9.37	0.39	12.42	10.21	0.41	12.81	11.02	0.40	13.57	10.98	0.40	14.34	11.68	0.41			
	50	10.03	9.21	0.40	11.18	9.25	0.40	12.32	10.10	0.42	12.71	10.92	0.41	13.47	10.86	0.41	14.23	11.60	0.42			
	59	9.95	9.16	0.41	11.10	9.23	0.41	12.22	10.05	0.44	12.61	10.85	0.42	13.37	10.81	0.43	14.12	11.50	0.44			
	67	11.22	10.32	0.54	12.51	10.40	0.55	13.77	11.34	0.55	14.22	12.25	0.56	15.07	12.18	0.56	15.92	12.98	0.57			
	77	10.67	9.82	0.62	11.90	9.85	0.63	13.13	10.76	0.64	13.53	11.63	0.64	14.32	11.56	0.64	15.14	12.32	0.65			
	87	10.09	9.27	0.69	11.25	9.31	0.70	12.41	10.18	0.71	12.78	10.98	0.71	13.57	10.94	0.72	14.32	11.67	0.73			
	95	9.48	8.72	0.76	10.53	8.76	0.77	11.63	9.56	0.79	12.00	10.32	0.79	12.72	10.29	0.80	13.43	10.94	0.81			
	104	8.01	7.78	0.71	8.93	7.82	0.72	9.82	8.51	0.73	10.13	9.20	0.74	10.74	9.16	0.74	11.35	9.78	0.75			
115	7.36	7.20	0.71	8.22	7.23	0.72	9.07	7.89	0.74	9.34	8.54	0.74	9.89	8.51	0.74	10.47	9.05	0.75				

AFR : Air Flow Rate (CFM)
 TC : Total Capacity (kBtu/h)
 SHC : Sensible Heat Capacity (kBtu/h)
 IP : Input Power (kW)

AFR	13.8
-----	------

		Indoor temperature																				
		°CDB			17.8			21.1			23.9			26.7			29.4			32.2		
		°CWB			12.2			15.6			17.2			19.4			21.7			22.8		
Outdoor temperature	°CDB	TC	SHC	IP	TC	SHC	IP	TC	SHC	IP	TC	SHC	IP	TC	SHC	IP	TC	SHC	IP			
	-10.0	3.03	2.79	0.28	3.38	2.81	0.28	3.73	3.07	0.29	3.84	3.31	0.29	4.07	3.29	0.29	4.30	3.50	0.30			
	-5.0	3.01	2.77	0.33	3.35	2.78	0.33	3.70	3.03	0.35	3.81	3.28	0.34	4.04	3.26	0.34	4.27	3.47	0.35			
	0.0	2.98	2.74	0.36	3.33	2.75	0.36	3.67	3.01	0.38	3.78	3.25	0.37	4.01	3.23	0.38	4.23	3.45	0.39			
	5.0	2.96	2.73	0.39	3.30	2.75	0.39	3.64	2.99	0.41	3.75	3.23	0.40	3.98	3.22	0.40	4.20	3.42	0.41			
	10.0	2.94	2.70	0.40	3.28	2.71	0.40	3.61	2.96	0.42	3.73	3.20	0.41	3.95	3.18	0.41	4.17	3.40	0.42			
	15.0	2.92	2.68	0.41	3.25	2.71	0.41	3.58	2.94	0.44	3.70	3.18	0.42	3.92	3.17	0.43	4.14	3.37	0.44			
	19.4	3.29	3.03	0.54	3.67	3.05	0.55	4.04	3.32	0.55	4.17	3.59	0.56	4.42	3.57	0.56	4.67	3.80	0.57			
	25.0	3.13	2.88	0.62	3.49	2.89	0.63	3.85	3.15	0.64	3.97	3.41	0.64	4.20	3.39	0.64	4.44	3.61	0.65			
	30.6	2.96	2.72	0.69	3.30	2.73	0.70	3.64	2.98	0.71	3.75	3.22	0.71	3.98	3.21	0.72	4.20	3.42	0.73			
	35.0	2.78	2.56	0.76	3.09	2.57	0.77	3.41	2.80	0.79	3.52	3.03	0.79	3.73	3.02	0.80	3.94	3.21	0.81			
	40.0	2.35	2.28	0.71	2.62	2.29	0.72	2.88	2.49	0.73	2.97	2.70	0.74	3.15	2.68	0.74	3.33	2.87	0.75			
46.0	2.16	2.11	0.71	2.41	2.12	0.72	2.66	2.31	0.74	2.74	2.50	0.74	2.90	2.49	0.74	3.07	2.65	0.75				

AFR : Air Flow Rate (m³/min)
 TC : Total Capacity (kW)
 SHC : Sensible Heat Capacity (kW)
 IP : Input Power (kW)

MODEL: ASU15RLS3

AFR	547
-----	-----

		Indoor temperature																	
		64			70			75			80			85			90		
		54			60			63			67			71			73		
Outdoor temperature	°FDB	TC	SHC	IP	TC	SHC	IP	TC	SHC	IP	TC	SHC	IP	TC	SHC	IP	TC	SHC	IP
	15	12.72	9.80	0.36	14.18	10.92	0.36	15.63	12.04	0.38	16.10	12.40	0.37	17.04	13.13	0.37	18.02	13.88	0.38
	23	12.53	9.62	0.39	13.95	10.72	0.39	15.38	11.82	0.41	15.85	12.18	0.40	16.78	12.90	0.40	17.75	13.63	0.42
	32	12.33	9.49	0.40	13.73	10.57	0.41	15.14	11.65	0.43	15.60	12.01	0.42	16.52	12.72	0.42	17.47	13.45	0.43
	41	12.13	9.34	0.41	13.51	10.41	0.41	14.89	11.47	0.43	15.35	11.82	0.42	16.26	12.52	0.42	17.19	13.24	0.44
	50	11.93	9.18	0.42	13.29	10.23	0.42	14.65	11.27	0.45	15.10	11.62	0.43	16.00	12.31	0.44	16.91	13.01	0.45
	59	11.73	9.01	0.45	13.07	10.04	0.45	14.41	11.07	0.48	14.85	11.41	0.46	15.74	12.10	0.46	16.64	12.78	0.48
	67	13.48	11.10	0.72	15.01	11.17	0.74	16.55	12.15	0.75	17.06	13.14	0.75	18.08	13.07	0.76	19.11	13.95	0.76
	77	12.86	10.57	0.82	14.33	10.64	0.83	15.80	11.59	0.84	16.27	12.50	0.84	17.23	12.47	0.85	18.22	13.28	0.86
	87	12.18	10.00	0.91	13.58	10.07	0.92	14.98	10.99	0.94	15.42	11.87	0.95	16.34	11.84	0.95	17.30	12.61	0.96
	95	11.46	9.40	1.01	12.76	9.48	1.02	14.06	10.32	1.03	14.50	11.17	1.04	15.35	11.10	1.05	16.24	11.84	1.06
	104	10.06	8.28	0.99	11.22	8.31	1.01	12.35	9.09	1.02	12.73	9.79	1.02	13.51	9.76	1.03	14.26	10.39	1.05
115	9.18	7.54	0.97	10.20	7.57	0.99	11.26	8.28	1.01	11.60	8.91	1.01	12.32	8.88	1.02	13.00	9.48	1.03	

AFR : Air Flow Rate (CFM)
 TC : Total Capacity (kBtu/h)
 SHC : Sensible Heat Capacity (kBtu/h)
 IP : Input Power (kW)

AFR	15.5
-----	------

		Indoor temperature																	
		17.8			21.1			23.9			26.7			29.4			32.2		
		12.2			15.6			17.2			19.4			21.7			22.8		
Outdoor temperature	°CDB	TC	SHC	IP	TC	SHC	IP	TC	SHC	IP	TC	SHC	IP	TC	SHC	IP	TC	SHC	IP
	-10.0	3.73	2.87	0.36	4.15	3.20	0.36	4.58	3.53	0.38	4.72	3.63	0.37	5.00	3.85	0.37	5.28	4.07	0.38
	-5.0	3.67	2.82	0.39	4.09	3.14	0.39	4.51	3.46	0.41	4.65	3.57	0.40	4.92	3.78	0.40	5.20	4.00	0.42
	0.0	3.61	2.78	0.40	4.02	3.10	0.41	4.44	3.42	0.43	4.57	3.52	0.42	4.84	3.73	0.42	5.12	3.94	0.43
	5.0	3.56	2.74	0.41	3.96	3.05	0.41	4.37	3.36	0.43	4.50	3.46	0.42	4.77	3.67	0.42	5.04	3.88	0.44
	10.0	3.50	2.69	0.42	3.90	3.00	0.42	4.29	3.30	0.45	4.43	3.41	0.43	4.69	3.61	0.44	4.96	3.81	0.45
	15.0	3.44	2.64	0.45	3.83	2.94	0.45	4.22	3.24	0.48	4.35	3.34	0.46	4.61	3.54	0.46	4.88	3.75	0.48
	19.4	3.95	3.25	0.72	4.40	3.27	0.74	4.85	3.56	0.75	5.00	3.85	0.75	5.30	3.83	0.76	5.60	4.09	0.76
	25.0	3.77	3.10	0.82	4.20	3.12	0.83	4.63	3.40	0.84	4.77	3.66	0.84	5.05	3.65	0.85	5.34	3.89	0.86
	30.6	3.57	2.93	0.91	3.98	2.95	0.92	4.39	3.22	0.94	4.52	3.48	0.95	4.79	3.47	0.95	5.07	3.70	0.96
	35.0	3.36	2.76	1.01	3.74	2.78	1.02	4.12	3.02	1.03	4.25	3.27	1.04	4.50	3.25	1.05	4.76	3.47	1.06
	40.0	2.95	2.43	0.99	3.29	2.44	1.01	3.62	2.66	1.02	3.73	2.87	1.02	3.96	2.86	1.03	4.18	3.05	1.05
46.0	2.69	2.21	0.97	2.99	2.22	0.99	3.30	2.43	1.01	3.40	2.61	1.01	3.61	2.60	1.02	3.81	2.78	1.03	

AFR : Air Flow Rate (m³/min)
 TC : Total Capacity (kW)
 SHC : Sensible Heat Capacity (kW)
 IP : Input Power (kW)

6-2. HEATING CAPACITY

MODEL: ASU9RLS3

AFR	487
-----	-----

		Indoor temperature								
		°FDB		60		65		70		75
Outdoor temperature	°FDB	°FWB	TC	IP	TC	IP	TC	IP	TC	IP
	-15	-17	11.6	2.15	11.4	2.19	11.1	2.23	10.5	2.31
	-5	-7	14.7	2.16	14.3	2.20	14.0	2.24	13.3	2.32
	5	3	16.1	2.17	15.7	2.21	15.4	2.25	14.6	2.34
	14	12	16.8	2.13	16.4	2.17	16.0	2.22	15.2	2.30
	23	19	18.3	2.10	17.9	2.14	17.5	2.18	16.6	2.26
	32	28	18.8	2.06	18.4	2.10	17.9	2.14	17.0	2.22
	41	37	21.3	1.88	20.8	1.92	20.3	1.95	19.3	2.03
	47	43	23.1	1.85	22.6	1.89	22.0	1.93	20.9	2.01
	50	47	25.5	1.84	24.9	1.88	24.3	1.91	23.1	1.99
59	50	26.5	1.63	25.8	1.67	25.2	1.70	23.9	1.77	

AFR : Air Flow Rate (CFM)
TC : Total Capacity (kBtu/h)
IP : Input Power (kW)

AFR	13.8
-----	------

		Indoor temperature								
		°CDB		15.6		18.3		21.1		23.9
Outdoor temperature	°CDB	°CWB	TC	IP	TC	IP	TC	IP	TC	IP
	-26.1	-27.0	3.41	2.15	3.33	2.19	3.25	2.23	3.09	2.31
	-20.6	-21.7	4.31	2.16	4.20	2.20	4.10	2.24	3.90	2.32
	-15.0	-16.1	4.73	2.17	4.61	2.21	4.50	2.25	4.28	2.34
	-10.0	-11.1	4.91	2.13	4.80	2.17	4.68	2.22	4.45	2.30
	-5.0	-7.2	5.38	2.10	5.25	2.14	5.12	2.18	4.86	2.26
	0.0	-2.2	5.52	2.06	5.39	2.10	5.26	2.14	5.00	2.22
	5.0	2.8	6.25	1.88	6.10	1.92	5.95	1.95	5.65	2.03
	8.3	6.1	6.77	1.85	6.61	1.89	6.45	1.93	6.13	2.01
	10.0	8.3	7.48	1.84	7.30	1.88	7.13	1.91	6.77	1.99
15.0	10.0	7.75	1.63	7.57	1.67	7.38	1.70	7.02	1.77	

AFR : Air Flow Rate (m³/min)
TC : Total Capacity (kW)
IP : Input Power (kW)

MODEL: ASU12RLS3

AFR	487
-----	-----

		Indoor temperature								
		°FDB		60		65		70		75
Outdoor temperature	°FDB	°FWB	TC	IP	TC	IP	TC	IP	TC	IP
	-15	-17	12.4	2.15	12.1	2.19	11.8	2.23	11.2	2.31
	-5	-7	15.8	2.16	15.4	2.20	15.0	2.24	14.3	2.32
	5	3	17.4	2.17	17.0	2.21	16.6	2.25	15.8	2.34
	14	12	18.3	2.13	17.8	2.18	17.4	2.22	16.5	2.30
	23	19	20.0	2.10	19.5	2.14	19.0	2.18	18.1	2.26
	32	28	20.6	2.07	20.1	2.11	19.6	2.15	18.6	2.23
	41	37	22.5	1.88	21.9	1.92	21.4	1.96	20.3	2.04
	47	43	23.2	1.86	22.7	1.90	22.1	1.94	21.0	2.02
	50	47	25.6	1.85	25.0	1.89	24.4	1.93	23.2	2.00
59	50	26.6	1.64	25.9	1.68	25.3	1.71	24.0	1.78	

AFR : Air Flow Rate (CFM)
TC : Total Capacity (kBtu/h)
IP : Input Power (kW)

AFR	13.8
-----	------

		Indoor temperature								
		°CDB		15.6		18.3		21.1		23.9
Outdoor temperature	°CDB	°CWB	TC	IP	TC	IP	TC	IP	TC	IP
	-26.1	-27.0	3.62	2.15	3.54	2.19	3.45	2.23	3.28	2.31
	-20.6	-21.7	4.63	2.16	4.52	2.20	4.41	2.24	4.19	2.32
	-15.0	-16.1	5.11	2.17	4.99	2.21	4.86	2.25	4.62	2.34
	-10.0	-11.1	5.36	2.13	5.23	2.18	5.10	2.22	4.85	2.30
	-5.0	-7.2	5.86	2.10	5.72	2.14	5.58	2.18	5.30	2.26
	0.0	-2.2	6.03	2.07	5.88	2.11	5.74	2.15	5.45	2.23
	5.0	2.8	6.58	1.88	6.43	1.92	6.27	1.96	5.96	2.04
	8.3	6.1	6.80	1.86	6.64	1.90	6.48	1.94	6.15	2.02
	10.0	8.3	7.52	1.85	7.34	1.89	7.16	1.93	6.80	2.00
15.0	10.0	7.79	1.64	7.60	1.68	7.42	1.71	7.05	1.78	

AFR : Air Flow Rate (m³/min)
TC : Total Capacity (kW)
IP : Input Power (kW)

MODEL: ASU15RLS3

AFR	547
-----	-----

Outdoor temperature		Indoor temperature									
		°FDB		60		65		70		75	
		°FDB	°FWB	TC	IP	TC	IP	TC	IP	TC	IP
-15	-17	17.1	2.77	16.7	2.82	16.3	2.88	15.5	2.98		
-5	-7	19.6	2.78	19.1	2.84	18.6	2.89	17.7	3.00		
5	3	22.0	2.79	21.5	2.85	21.0	2.90	19.9	3.01		
14	12	22.7	2.68	22.2	2.73	21.6	2.78	20.5	2.89		
23	19	23.3	2.56	22.8	2.61	22.2	2.66	21.1	2.76		
32	28	24.0	2.45	23.4	2.49	22.9	2.54	21.7	2.64		
41	37	24.7	2.18	24.1	2.22	23.5	2.27	22.3	2.36		
47	43	25.1	2.10	24.5	2.15	23.9	2.19	22.7	2.28		
50	47	26.1	1.97	25.5	2.01	24.9	2.05	23.6	2.13		
59	50	27.2	1.75	26.5	1.79	25.9	1.82	24.6	1.89		

AFR : Air Flow Rate (CFM)
TC : Total Capacity (kBtu/h)
IP : Input Power (kW)

AFR	15.5
-----	------

Outdoor temperature		Indoor temperature									
		°CDB		15.6		18.3		21.1		23.9	
		°CDB	°CWB	TC	IP	TC	IP	TC	IP	TC	IP
-26.1	-27.0	5.01	2.77	4.89	2.82	4.77	2.88	4.53	2.98		
-20.6	-21.7	5.73	2.78	5.60	2.84	5.46	2.89	5.19	3.00		
-15.0	-16.1	6.46	2.79	6.31	2.85	6.15	2.90	5.84	3.01		
-10.0	-11.1	6.65	2.68	6.49	2.73	6.33	2.78	6.02	2.89		
-5.0	-7.2	6.84	2.56	6.68	2.61	6.52	2.66	6.19	2.76		
0.0	-2.2	7.04	2.45	6.87	2.49	6.70	2.54	6.37	2.64		
5.0	2.8	7.23	2.18	7.06	2.22	6.88	2.27	6.54	2.36		
8.3	6.1	7.35	2.10	7.18	2.15	7.00	2.19	6.65	2.28		
10.0	8.3	7.66	1.97	7.47	2.01	7.29	2.05	6.93	2.13		
15.0	10.0	7.97	1.75	7.78	1.79	7.59	1.82	7.21	1.89		

AFR : Air Flow Rate (m³/min)
TC : Total Capacity (kW)
IP : Input Power (kW)

7. FAN PERFORMANCE

7-1. AIR VELOCITY DISTRIBUTION

■ MODEL : ASU9RLS3, ASU12RLS3

Conditions:
Fan speed : High
Operation mode : FAN

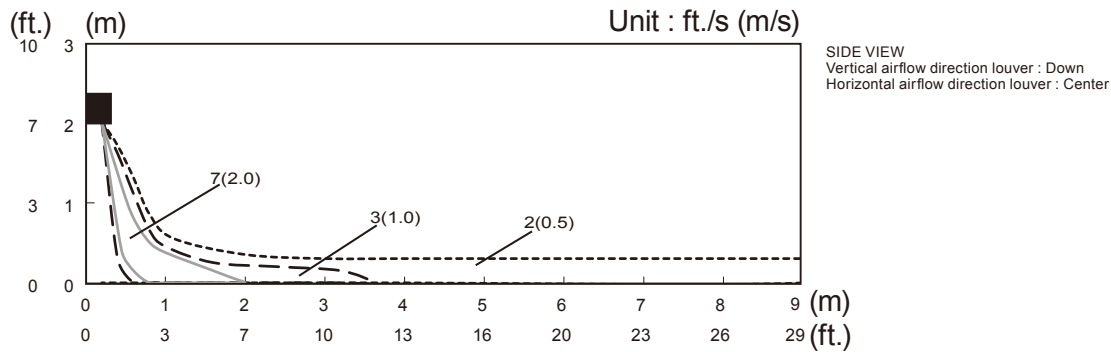
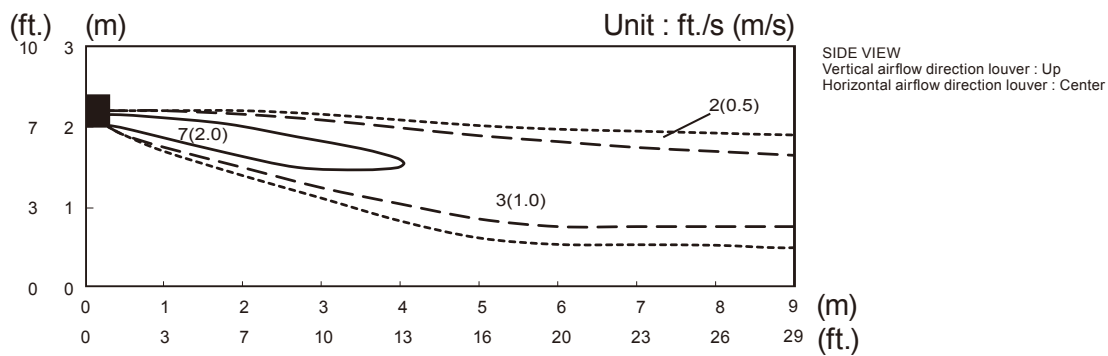
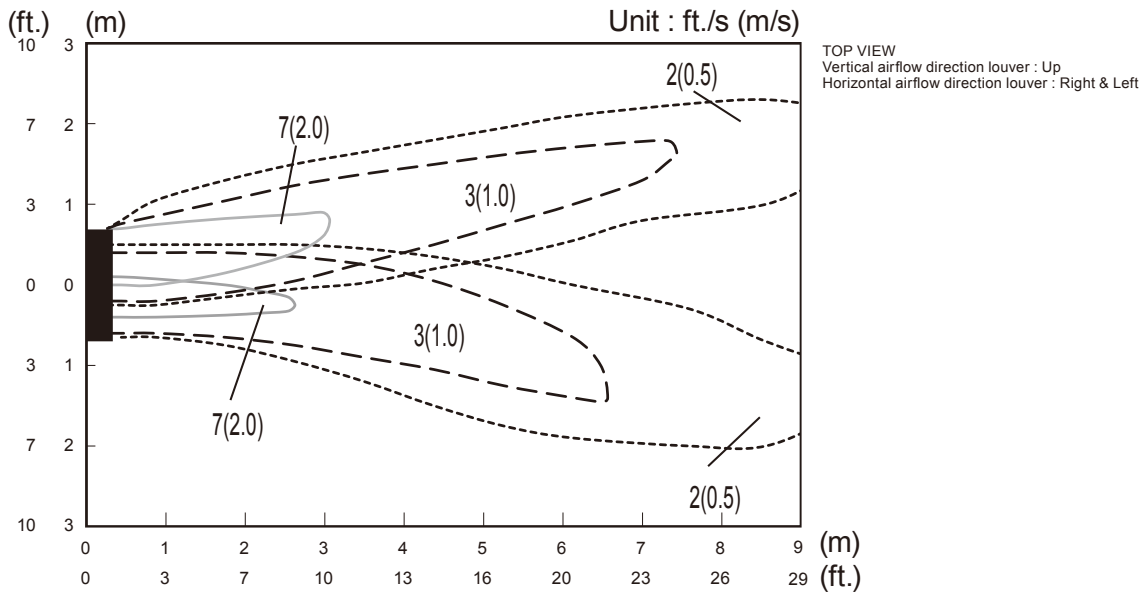
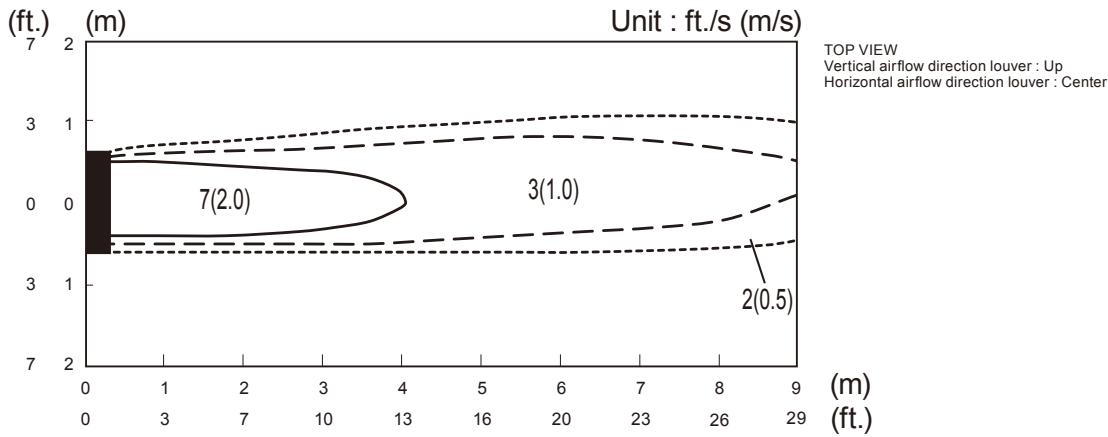

Conditions:
Fan speed : High
Operation mode : FAN

MODEL: ASU15RLS3

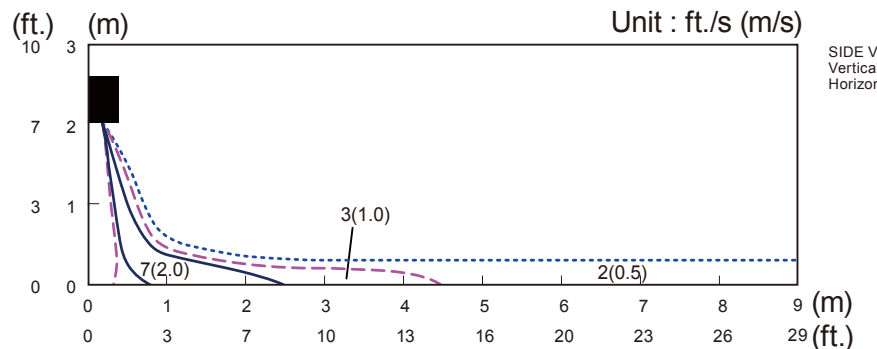
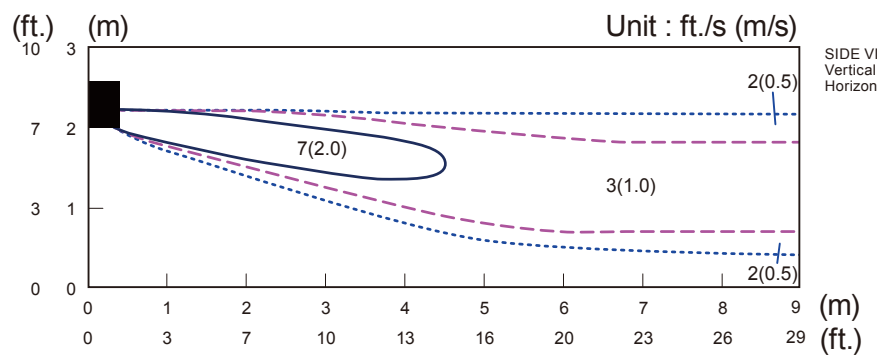
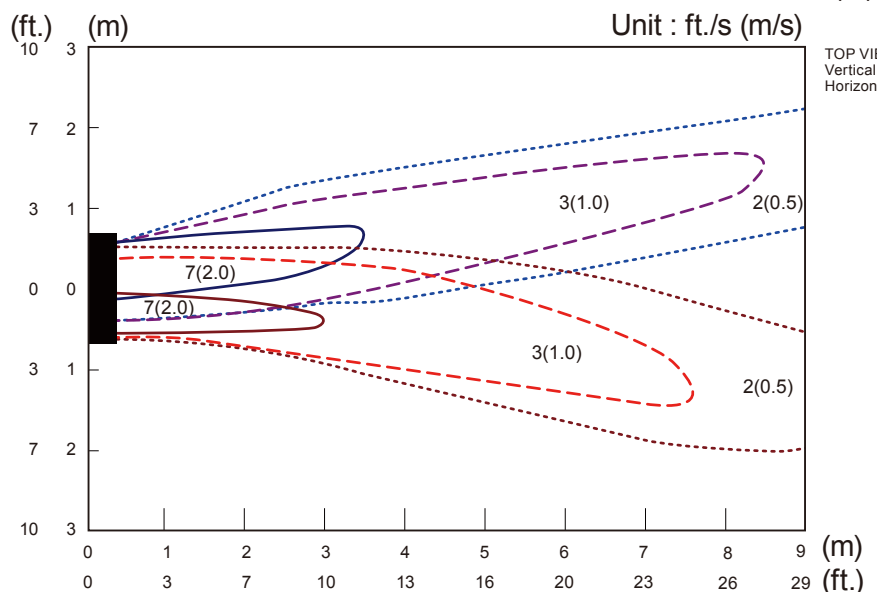
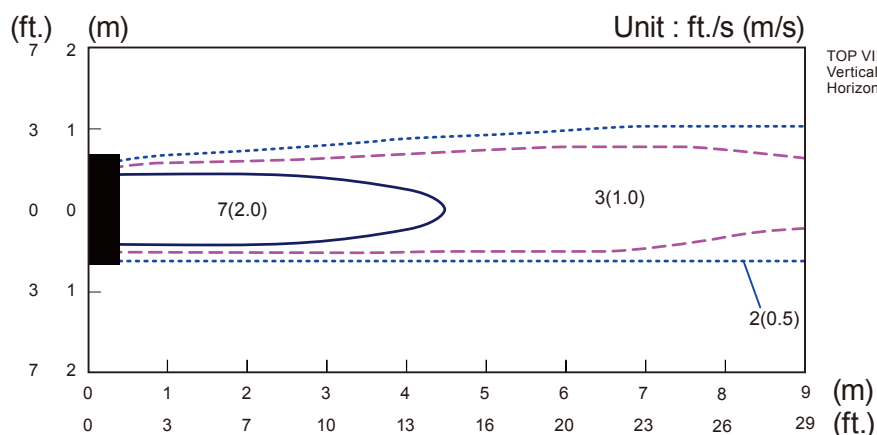

7-2. AIRFLOW

■ MODEL: ASU9RLS3, ASU12RLS3

● Cooling

Fan speed	Airflow	
HIGH	830	m ³ /h
	231	l/s
	489	CFM
MED	680	m ³ /h
	189	l/s
	400	CFM
LOW	580	m ³ /h
	161	l/s
	341	CFM
QUIET	380	m ³ /h
	106	l/s
	224	CFM

● Heating

Fan speed	Airflow	
HIGH	830	m ³ /h
	231	l/s
	489	CFM
MED	680	m ³ /h
	189	l/s
	400	CFM
LOW	580	m ³ /h
	161	l/s
	341	CFM
QUIET	380	m ³ /h
	106	l/s
	224	CFM

■ MODEL: ASU15RLS3

● Cooling

Fan speed	Airflow	
HIGH	930	m ³ /h
	258	l/s
	547	CFM
MED	780	m ³ /h
	217	l/s
	459	CFM
LOW	630	m ³ /h
	175	l/s
	371	CFM
QUIET	440	m ³ /h
	122	l/s
	259	CFM

● Heating

Fan speed	Airflow	
HIGH	930	m ³ /h
	258	l/s
	547	CFM
MED	780	m ³ /h
	217	l/s
	459	CFM
LOW	630	m ³ /h
	175	l/s
	371	CFM
QUIET	500	m ³ /h
	139	l/s
	294	CFM

8. OPERATION NOISE

8-1. NOISE LEVEL CURVE

MODEL: ASU9RLS3

● Cooling

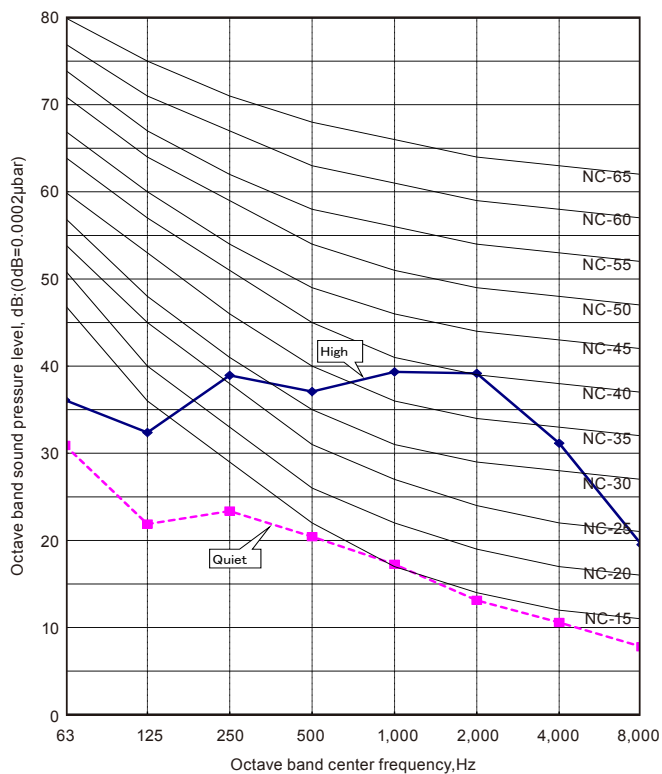

● Heating

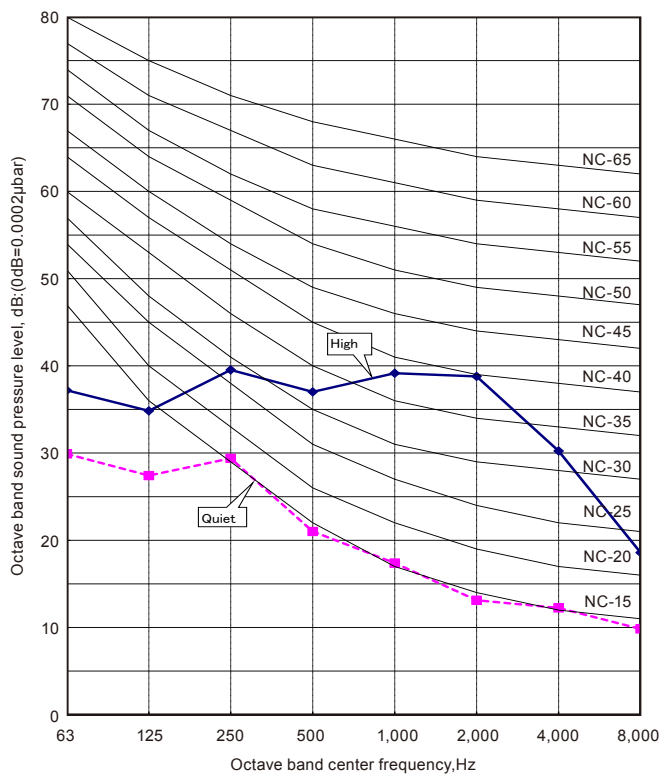

MODEL: ASU12RLS3

● Cooling

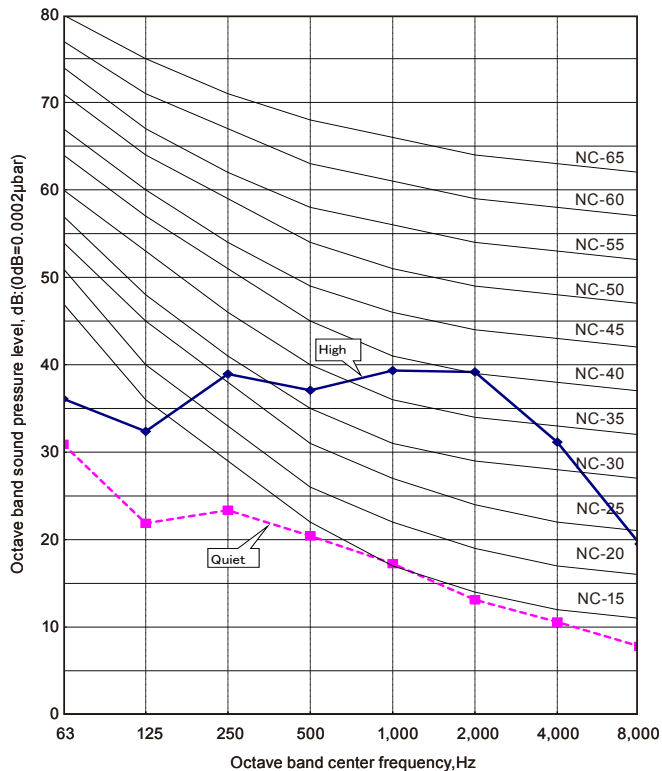

● Heating

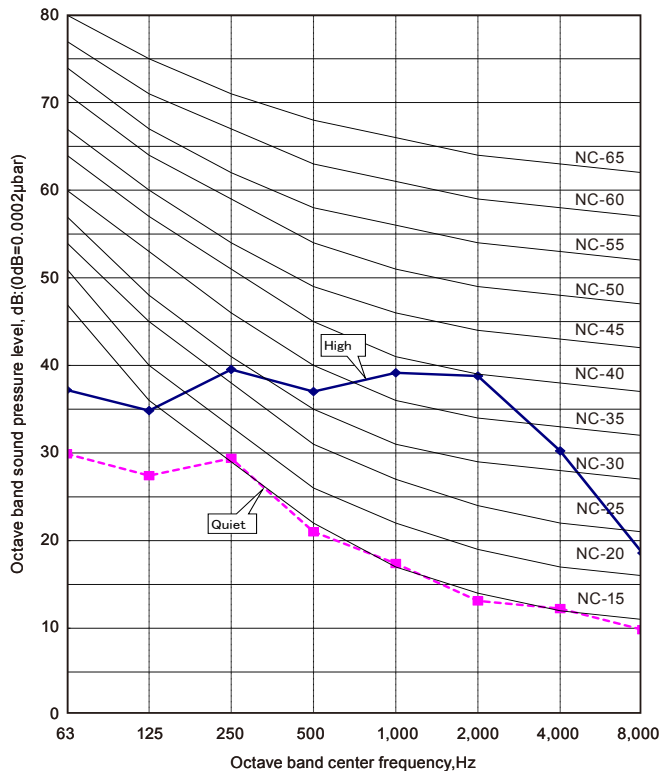

MODEL: ASU15RLS3

● Cooling

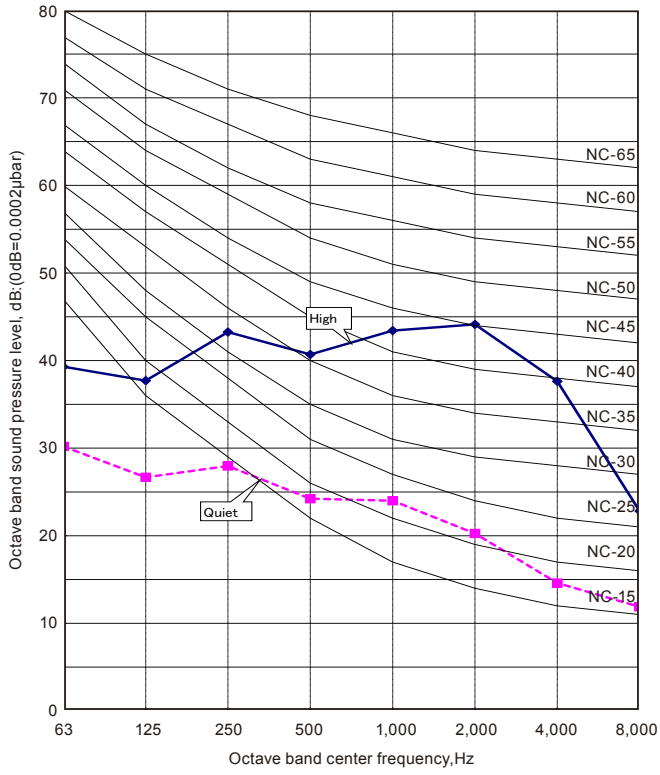

● Heating

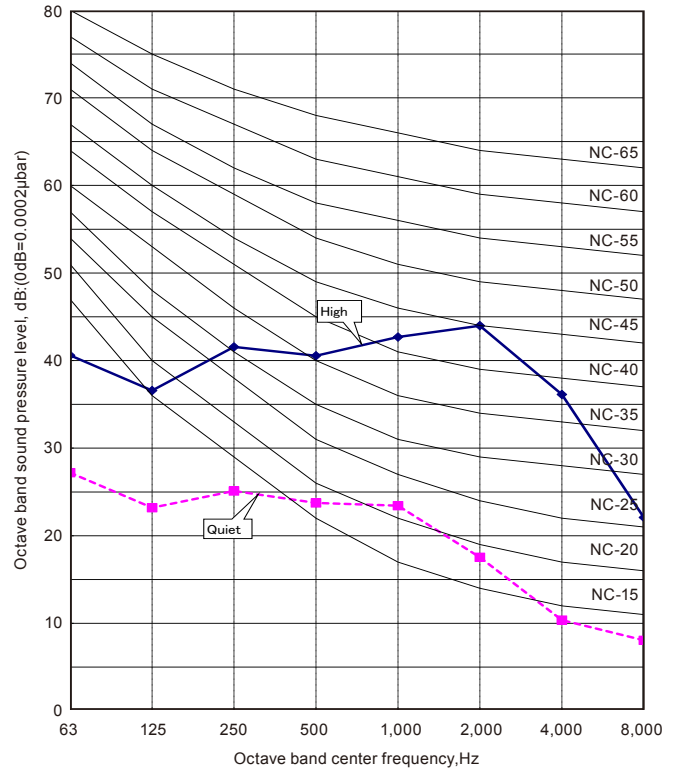

8-2. SOUND LEVEL CHECK POINT

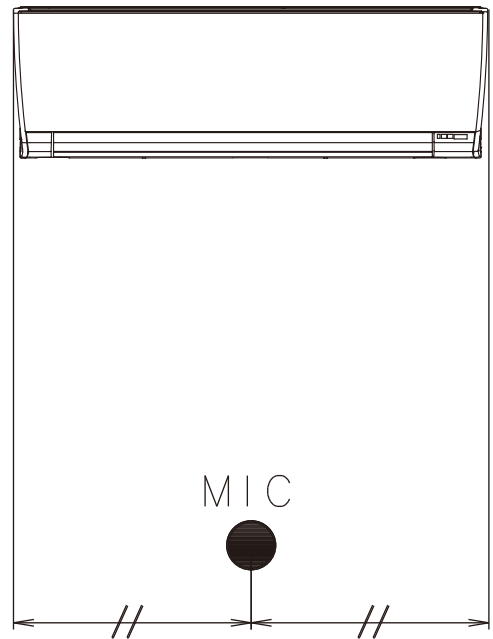
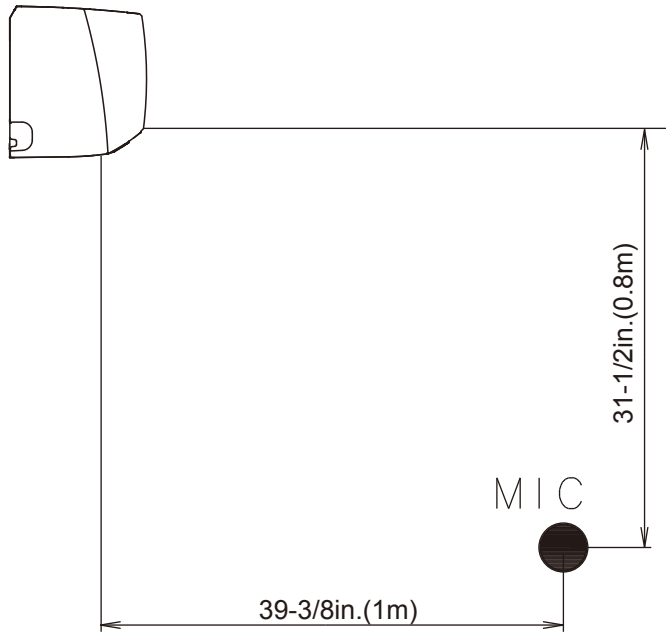

9. SAFETY DEVICES

	Protection form	Model
		ASU9RLS3 ASU12RLS3 ASU15RLS3
Circuit protection	Current fuse (PCB)	250V 3.15A
Fan motor protection	Thermal protector program	OFF: 302±27 °F (150±15 °C) ON: 248±27 °F (120±15 °C)

10. EXTERNAL INPUT & OUTPUT

Connector	INPUT	OUTPUT	REMARKS
CNA01	Control input	-	See external input/output settings for details.
CNB01	-	Operation status output	
CNB02	-	Error status output	

10-1. EXTERNAL INPUT

■ CONTROL INPUT (Operation/Stop or Forced stop)

The air conditioner can be remotely operated by means of the following on-site work.

"Operation/Stop" mode or "Forced stop" mode can be selected with function setting of indoor unit.

Unit operation is started at the following contents by adding the contact input of a commercial ON/OFF switch to a connector on the external control PC board and turning it ON.

Unit operation	Initial setting after power is ON	Starting mode other than initial setting
Operation mode	Auto changeover	Mode at previous operation
Set temperature	75°F (24°C)	Temperature at previous operation
Air flow mode	AUTO	Mode at previous operation
Air direction (swing)	Standard air direction (swing OFF)	Air direction at previous operation

● Circuit diagram example

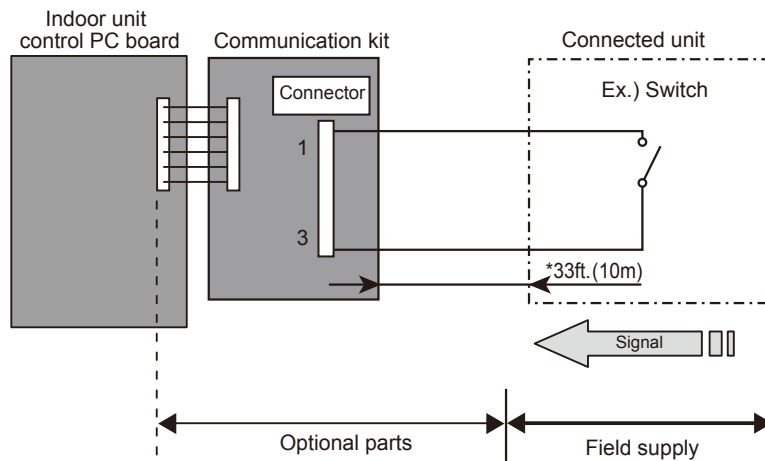

* Make the distance from the PC board to the connected unit within 33ft.(10m).
Contact capacity : 24VDC or more, 10mA or more.
Please use non-polar relays and switches.

● When function setting is in "Operation/Stop" mode

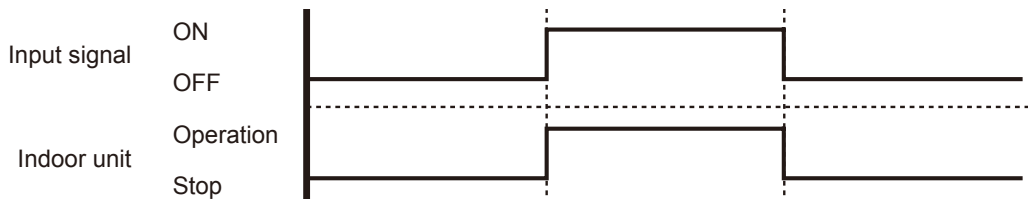

● When function setting is in "Forced stop" mode

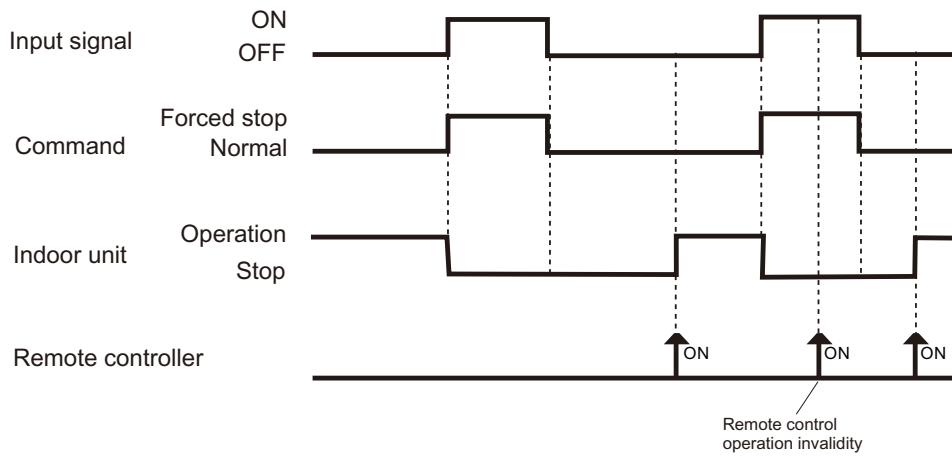

● Parts (Optional)

Parts name	Model name
External connect kit	UTY-XWZXZ5
Communication kit	UTY-TWBXF1

*For operating the EXTERNAL function, the Compact wall mounted type requires the communication kit in addition to the wire (UTY-XWZXZ5).



10-2. EXTERNAL OUTPUT

■ OPERATION STATUS OUTPUT

An air conditioner operation status signal can be output.

● Circuit diagram example

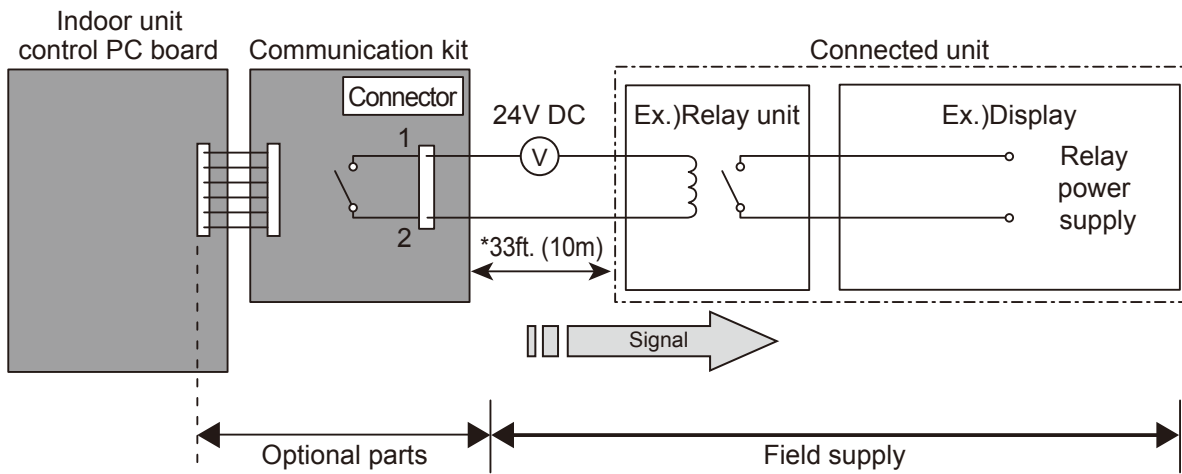

* Make the distance from the PC board to the connected unit within 33ft.(10m).
Relay spec. : Max.24VDC, 10mA to less than 500mA.

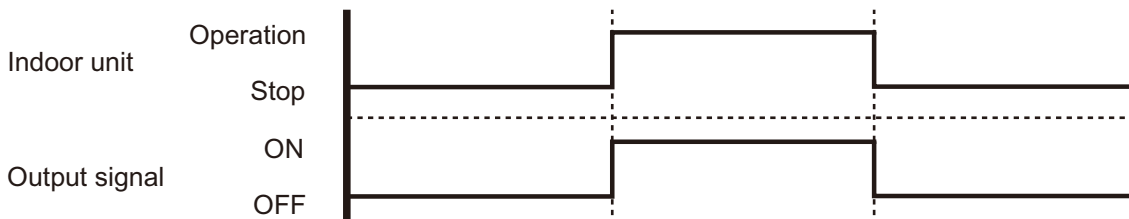

● Parts (Optional)

Parts name	Model name
External connect kit	UTY-XWZXZ5
Communication kit	UTY-TWBXF1

*For operating the EXTERNAL function, the wall mounted type requires the communication kit in addition to the wire (UTY-XWZXZ5).



■ ERROR STATUS OUTPUT

An air conditioner error status signal can be output.

● Circuit diagram example

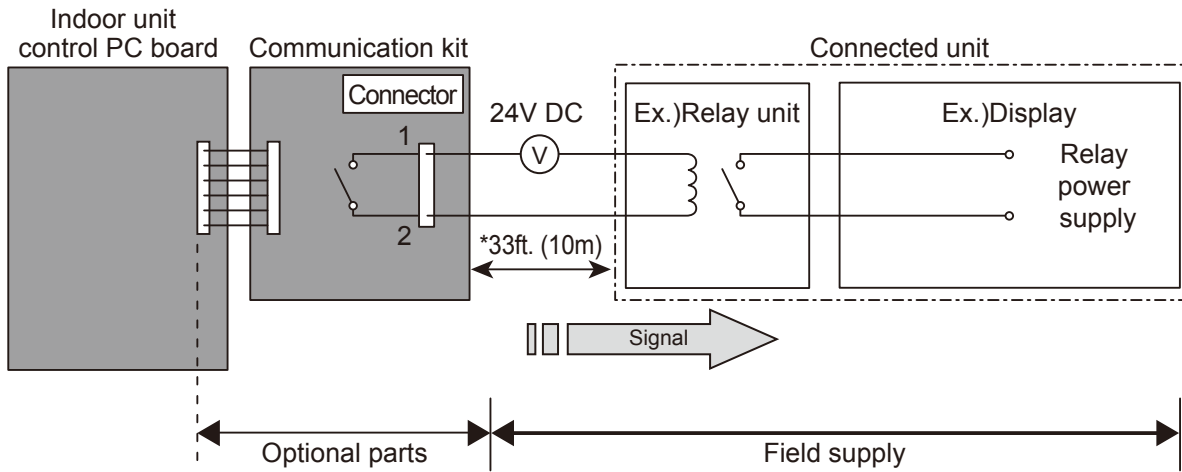

* Make the distance from the PC board to the connected unit within 33ft.(10m).
Relay spec. : Max.24VDC, 10mA to less than 500mA.

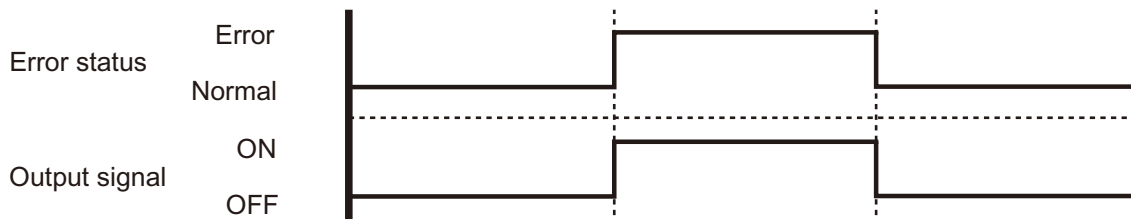

● Parts (Optional)

Parts name	Model name
External connect kit	UTY-XWZXZ5
Communication kit	UTY-TWBXF1

*For operating the EXTERNAL function, the wall mounted type requires the communication kit in addition to the wire (UTY-XWZXZ5).



11. FUNCTION SETTINGS

11-1. INDOOR UNIT (Setting by remote controller)

- The function settings of the control of the indoor unit can be changed by this procedure according to the installation conditions. Incorrect settings can cause the indoor unit to malfunction.
- After the power is turned on, perform the "FUNCTION SETTING" according to the installation conditions using the remote controller.
- The settings may be selected between the following two: Function Number or Setting Value.
- Settings will not be changed if invalid numbers or setting values are selected.

■ PREPARATION

- Turn on the power
 - * Before turning on the power of the indoor units, make sure the piping air-tight test and vacuuming have been conducted.
 - * Also check again to make sure no wiring mistakes were made before turning on the power.

■ FUNCTION SETTING METHOD (for Wireless remote controller)

Perform the "FUNCTION SETTING" according to the installation conditions using the remote controller.

⚠ CAUTION
Confirm whether the wiring work for outdoor unit has been finished.
Confirm that the cover for the electrical enclosure on the outdoor unit is in place.

- This procedure changes to the function settings used to control the indoor unit according to the installation conditions. Incorrect settings can cause the indoor unit to malfunction.
- After the power is turned on, perform the "FUNCTION SETTING" according to the installation conditions using the remote controller.
- The settings may be selected between the following two: Function Number or Setting Value.
- Settings will not be changed if invalid numbers or setting values are selected.
- Refer to the installation manual enclosed with the remote control unit when the wired remote control unit (option) is used.
- Adjust the custom code of the indoor unit and the custom code of the remote controller.

Entering the Function Setting Mode

While pressing the POWERFUL button and SET TEMP. (Λ / ∨) simultaneously, press the RESET button to enter the function setting mode.

Selecting the Function Number and Setting Value

- (1) Press the SET TEMP. (Λ / ∨) buttons to select the function number.
(Press the MIN. HEAT button to switch between the left and right digits.)
- (2) Press the POWERFUL button to proceed to setting the value.
(Press the POWERFUL button again to return to the function number selection.)
- (3) Press the SET TEMP. (Λ / ∨) buttons to select the setting value.
(Press the MIN. HEAT button to switch between the left and right digits.)
- (4) Press the MODE button, in the order listed to confirm the settings.
Please confirm that the beep sounds.
- (5) Next, please press START/STOP (⏻ / ⏩) button. Please confirm that the beep sounds.
- (6) Press the RESET button to cancel the function setting mode.
- (7) After completing the FUNCTION SETTING, be sure to turn off the power and turn it on again.

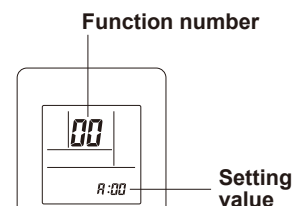

⚠ CAUTION
After turning off the power, wait 30 seconds or more before turning it on again. The Function Setting will not become active unless the power is turned off then on again.

FUNCTION DETAILS

Functions	
1)	Filter sign
2)	Room temperature control for indoor unit sensor
3)	Auto restart
4)	Room temperature sensor switching
5)	Remote controller custom code
6)	External input control
7)	Room temperature sensor switching (Aux.)
8)	Indoor unit fan control for energy saving for cooling
9)	Room temperature control for wired remote controller sensor
10)	Heat Insulation condition (building insulation)

1) Filter sign

Select appropriate intervals for displaying the filter sign on the indoor unit according to the estimated amount of dust in the air of the room.

If the indication is not required, select "No indication" (03).

(◆... Factory setting)

Function number	Setting value	Setting description
11	00	Standard (400 hours)
	01	Long interval (1000 hours)
	02	Short interval (200 hours)
	03	No indication

2) Room temperature control for indoor unit sensor

Refer to Function 95, before performing this setting.

Depending on the installed environment, correction of the room temperature sensor may be required. Select the appropriate control setting according to the installed environment.

The temperature correction values show the difference from the Standard setting "00" (manufacturer's recommended value).

*When Function 95-01(High insulation) is set, the Standard setting "00" will be the same as No correction "01" [0.0°F (0.0°C)].

(◆... Factory setting)

Function number	Setting value	Setting description	
30 (For cooling)	31 (For heating)	00	Standard setting*
		01	No correction 0.0°F (0.0°C)
		02	-1°F (-0.5°C)
		03	-2°F (-1.0°C)
		04	-3°F (-1.5°C)
		05	-4°F (-2.0°C)
		06	-5°F (-2.5°C)
		07	-6°F (-3.0°C)
		08	-7°F (-3.5°C)
		09	-8°F (-4.0°C)
		10	+1°F (+0.5°C)
		11	+2°F (+1.0°C)
		12	+3°F (+1.5°C)
		13	+4°F (+2.0°C)
		14	+5°F (+2.5°C)
		15	+6°F (+3.0°C)
		16	+7°F (+3.5°C)
17	+8°F (+4.0°C)		

More Cooling
Less Heating

Less Cooling
More Heating

3) Auto restart

Enable or disable automatic restart after a power interruption.

(◆... Factory setting)

Function number	Setting value	Setting description
40	00	Enable
	01	Disable

*Auto restart is an emergency function such as for power outage etc.
Do not attempt to use this function in normal operation.
Be sure to operate the unit by remote controller or external device.

4) Room temperature sensor switching

(Only for Wired remote controller)

When using the Wired remote controller temperature sensor, change the setting to "Both" (01).

(◆... Factory setting)

Function number	Setting value	Setting description
42	00	Indoor unit
	01	Both

00: Sensor on the indoor unit is active.

01: Sensors on both indoor unit and wired remote controller are active.

*Remote controller sensor must be turned on by using the remote controller.

5) Remote controller custom code

(Only for wireless remote controller)

The indoor unit custom code can be changed.

Select the appropriate custom code.

(◆... Factory setting)

Function number	Setting value	Setting description
44	00	A
	01	B
	02	C
	03	D

6) External input control

"Operation/Stop" mode or "Forced stop" mode can be selected.

(◆... Factory setting)

Function number	Setting value	Setting description
46	00	Operation/Stop mode
	01	(Setting prohibited)
	02	Forced stop mode

7) Room temperature sensor switching (Aux.)

To use the temperature sensor on the wired remote controller only, change the setting to "Wired remote controller" (01). This function will only work if the function setting 42 is set at "Both" (01)

(◆... Factory setting)

Function number	Setting value	Setting description
48	00	Both
	01	Wired remote controller

8) Indoor unit fan control for energy saving for cooling

Enable or disable the power-saving function by controlling the indoor unit fan rotation when the outdoor unit is stopped during cooling operation.

(◆... Factory setting)

Function number	Setting value	Setting description
49	00	Disable
	01	Enable

00: When the outdoor unit is stopped, the indoor unit fan operates continuously following the setting on the remote controller.

01: When the outdoor unit is stopped, the indoor unit fan operates intermittently at a very low speed.

9) Room temperature control for wired remote controller sensor

Refer to Function 95, before performing this setting.

Depending on the installed environment, correction of the wired remote controller temperature sensor may be required. Select the appropriate control setting according to the installed environment.

To change this setting, set Function 42 to Both "01".

Ensure that the Thermo Sensor icon is displayed on the remote controller screen.

(◆... Factory setting)

Function number	Setting value	Setting description	
92 (For cooling)	93 (For heating)	00	No correction 0.0°F(0.0°C)
		01	No correction 0.0°F (0.0°C)
		02	-1°F (-0.5°C)
		03	-2°F (-1.0°C)
		04	-3°F (-1.5°C)
		05	-4°F (-2.0°C)
		06	-5°F (-2.5°C)
		07	-6°F (-3.0°C)
		08	-7°F (-3.5°C)
		09	-8°F (-4.0°C)
		10	+1°F (+0.5°C)
		11	+2°F (+1.0°C)
		12	+3°F (+1.5°C)
		13	+4°F (+2.0°C)
		14	+5°F (+2.5°C)
		15	+6°F (+3.0°C)
		16	+7°F (+3.5°C)
17	+8°F (+4.0°C)		

More Cooling
Less Heating

Less Cooling
More Heating

10) Heat Insulation condition (building insulation)

Heat insulation conditions differ according to the installed environment.

Standard insulation "00" allows system to rapidly respond to the cooling or heating load changes. High insulation "01" is when the heat insulation structure of the building is high and does not require system to rapidly respond to cooling or heating load changes.

When High insulation "01" is selected;

- Overheating (overcooling) is prevented at the start-up.
- All room temp. control settings (Function 30, 31, 92, 93) will reset to No correction [0.0°F (0.0°C)].

(◆... Factory setting)

Function number	Setting value	Setting description
95	00	Standard insulation ◆
	01	High insulation

NOTE:

When changing Function 95, perform this setting before other Room temp. control settings (Function 30, 31, 92, 93). If Function 95 is not set first, Room temperature control settings (Function 30, 31, 92, 93) will be reset and you must re-do them again.

■ REMOTE CONTROLLER CUSTOM CODE SETTING

Use the following steps to select the custom code of the remote controller. (Note that the air conditioner cannot receive a signal if the air conditioner has not been set for the matching custom code.)

- (1) Press the START/STOP (⏻ / ⏪) button until only the clock is displayed on the remote controller display.
- (2) Press the MODE button for at least 5 seconds to display the current custom code (initially set to **A**).
- (3) Press the SET TEMP. (▲ / ▼) buttons to change the custom code between **A** → **b** → **c** → **d**.
Match the code on the display to the air conditioner custom code.
- (4) Press the MODE button again to return to the clock display. The custom code will be changed.

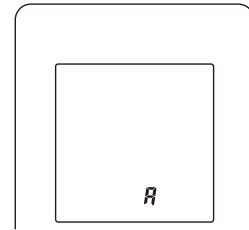

- If no buttons are pressed within 30 seconds after the custom code is displayed, the system returns to the original clock display. In this case, start again from step 1.
- The air conditioner custom code is set to A prior to shipment.

■ REMOTE CONTROLLER TEMPERATURE UNIT

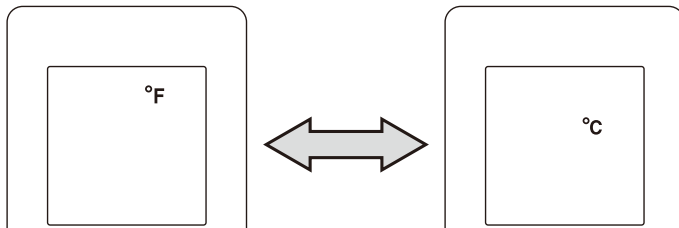

To change the temperature unit:

- (1) Press the TEMP. (Up) button (▲) for at least 5 seconds to display the current temperature unit. (Factory setting: °F)
- (2) Press the TEMP. buttons (▲ / ▼) to switch the temperature unit. (°F ↔ °C)
- (3) With either of pressing the START/STOP button or no additional button operation for 30 seconds in step 2., the temperature unit currently selected will be set.

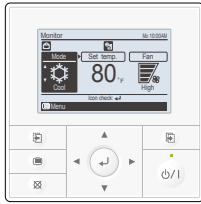
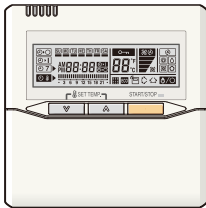

12. OPTIONAL PARTS

12-1. CONTROLLER

Exterior	Parts name	Model No.	Summary
	Wired remote controller	UTY-RVNUM	Large and full-dot liquid crystal screen, wide and large keys easy to press, user-intuitive arrow key. *Optional communication kit is necessary for installation
	Wired remote controller	UTY-RNNUM	The room temperature can be controlled by detecting the temperature accurately with built-in thermo sensor. *Optional communication kit is necessary for installation.
	Simple remote controller	UTY-RSNUM	Compact remote controller concentrates on the basic functions such as Start/Stop, Fan Control, Temperature Setting and Operation mode. *Optional communication kit is necessary for installation.

12-2. OTHERS

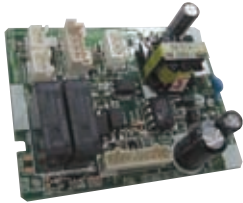
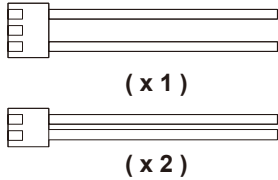
Exterior	Parts name	Model No.	Summary
	Communication kit	UTY-TWBXF1	Use to connect with optional devices and air conditioner PC board.
	External connect kit	UTY-XWZXZ5	Required when external device is connected. *Optional communication kit is necessary for installation.

2. OUTDOOR UNIT

SINGLE TYPE :

AOU9RLS3H

AOU12RLS3H

AOU15RLS3H

CONTENTS

2. OUTDOOR UNIT

1. SPECIFICATIONS.....	02 - 01
2. DIMENSIONS	02 - 02
3. REFRIGERANT CIRCUIT	02 - 03
4. WIRING DIAGRAMS.....	02 - 05
5. CAPACITY COMPENSATION RATE FOR PIPE LENGTH AND HEIGHT DIFFERENCE	02 - 07
6. ADDITIONAL CHARGE CALCULATION.....	02 - 09
7. AIRFLOW	02 - 10
8. OPERATION NOISE.....	02 - 11
8-1. NOISE LEVEL CURVE	02 - 11
8-2. SOUND LEVEL CHECK POINT	02 - 13
9. ELECTRIC CHARACTERISTICS.....	02 - 14
10. SAFETY DEVICES	02 - 15

1. SPECIFICATIONS

OUTDOOR UNIT
AOU9-15RLS3H

OUTDOOR UNIT
AOU9-15RLS3H

Type			INVERTER HEAT PUMP		
Model name			AOU9RLS3H	AOU12RLS3H	AOU15RLS3H
Power source			208 / 230V ~ 60Hz		
Available voltage range			188 - 253V		
Starting current			3.3	4.7	5.2
Fan	Airflow rate	Cooling	989 (1,680)		1,206 (2,050)
		Heating	1,082 (1,840)		
	Type × Q'ty		Propeller fan × 1		
	Motor output		W	49	
Sound pressure level	Cooling	dB (A)	42	43	49
	Heating		47		50
Heat exchanger type	Dimensions (H × W × D)		in.	23-1/8 × 34-11/16 × 1-7/16	
			mm	588 × 881 × 36.4	
	Fin pitch		FPI	20	
	Rows × Stages			2 × 28	
	Pipe type			Copper	
Fin Type			Aluminum		
Compressor	Type × Q'ty		Rotary × 1		
	Motor output		W	850	1,000
Refrigerant	Type		R410A		
	Charge	lbs.oz.	2lbs.14oz.		3lbs.1oz.
		kg	1.30		1.40
Refrigerant oil		Type	FREOL α68SZ		
Enclosure	Material		Steel		
	Color		Beige Approximate color of MUNSELL 10YR7.5/1.0		
Dimensions (H × W × D)	Net	in.	24 - 1/2 × 31 - 1/8 × 11 - 7/16		
		mm	620 × 790 × 290		
	Gross	in.	28 - 1/16 × 37-3/16 × 15 - 9/16		
		mm	713 × 945 × 395		
Weight	Net	lbs.(kg)	86 (39)		88 (40)
	Gross		95 (43)		
Connention pipe	Size	Liquid	Ø 1/4 (Ø 6.35)		
		Gas	Ø 3/8 (Ø 9.52)		Ø 1/2 (Ø 12.7)
	Method		Flare		
	Pre - charge length		ft. (m)	49 (15)	
	Max. length			66 (20)	
	Max. height difference			49 (15)	
Operation range	Cooling	°F (°C)	14 to 115 (-10 to 46)		
	Heating		-15 to 75 (-26 to 24)		

Note :

Specifications are based on the following conditions.

Cooling : Indoor temperature of 80°F (26.67°C) DB / 67°F (19.44°C) WB, and outdoor temperature of 95°F (35°C) DB / 75°F (23.9°C) WB.

Heating : Indoor temperature of 70°F (21.11°C) DB / 59°F (15°C) WB, and outdoor temperature of 47°F (8.33°C) DB / 43°F (6.11°C) WB.

Pipe length : 24ft.7in (7.5m), Height difference:0 m. (Outdoor unit - Indoor unit)

The protective function may work when using it outside the operation range.

2. DIMENSIONS

MODEL: AOU9RLS3H, AOU12RLS3H, AOU15RLS3H

Unit : in. (mm)

OUTDOOR UNIT
AOU9-15RLS3H

OUTDOOR UNIT
AOU9-15RLS3H

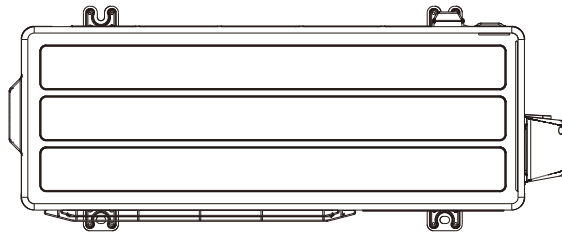

Top view

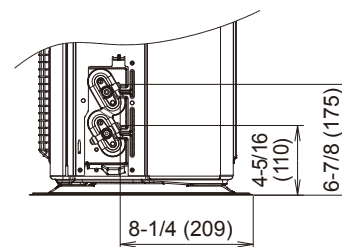
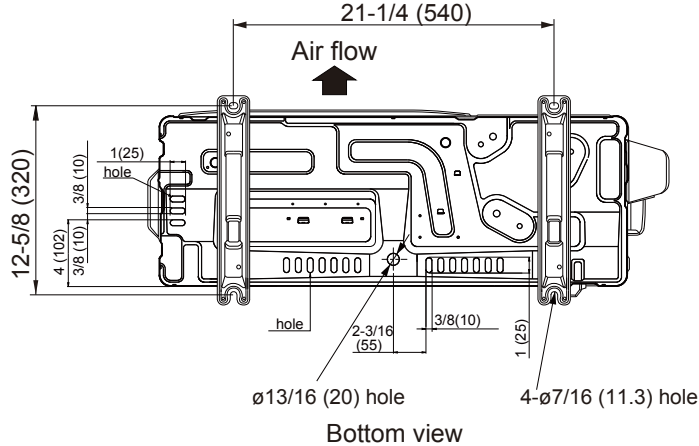
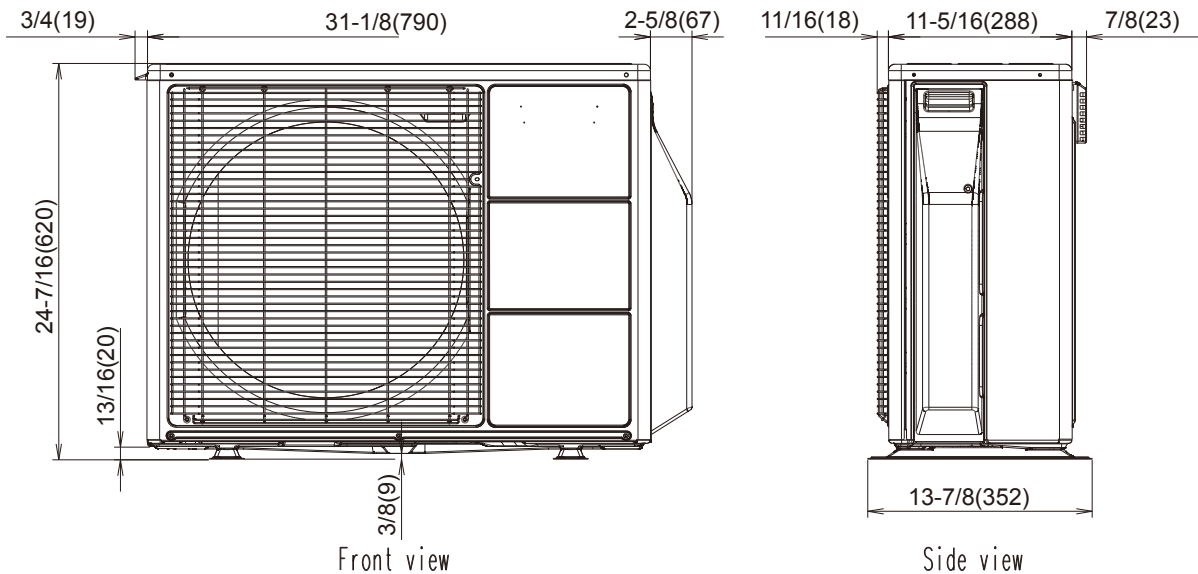

INSTALLATION PLACE

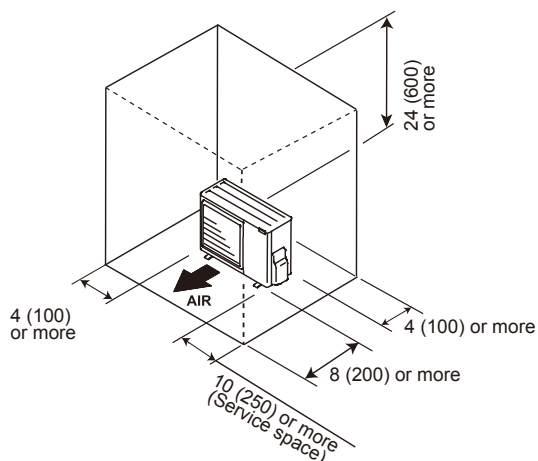

CAUTION

- When the outdoor temperature is 0 °C or less, do not use the accessory drain pipe and drain cap. If the drain pipe and drain cap are used, the drain water in the pipe may freeze in extremely cold weather. (Reverse cycle model only)
- In areas with heavy snowfall, if the intake and outlet of outdoor unit is blocked with snow, it might become difficult to get warm and it is likely to cause breakdown. Please construct a canopy and a pedestal or place the unit on a high stand (local configured).

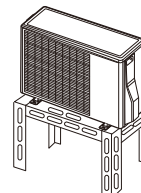

•Height above the floor level should be 50 mm or more.

•To obtain better operation efficiency, when the outdoor unit is installed, be sure to open the front and left side.

3. REFRIGERANT CIRCUIT

■ MODEL: AOU9RLS3H, AOU12RLS3H

OUTDOOR UNIT
AOU9-15RLS3H

OUTDOOR UNIT
AOU9-15RLS3H

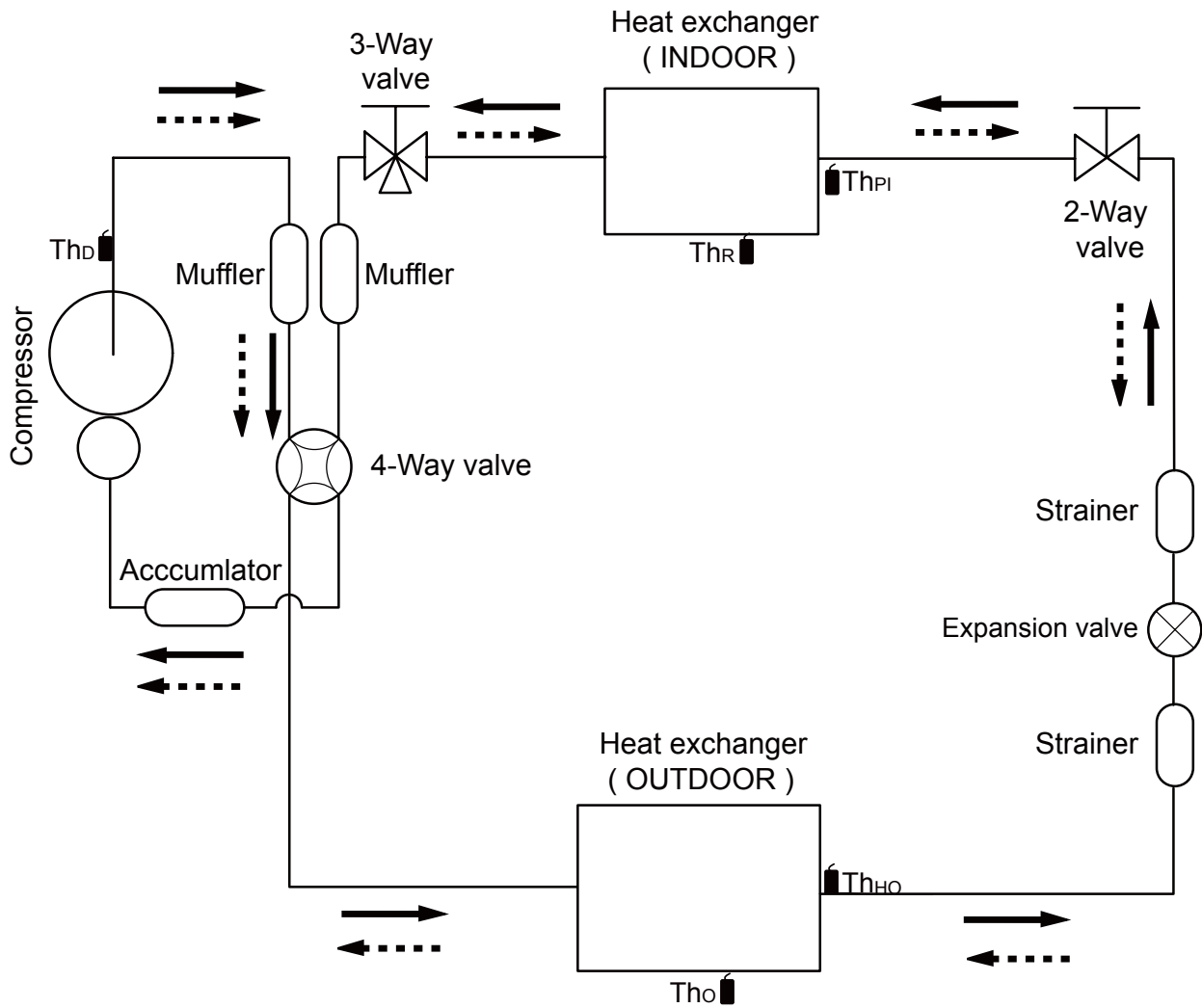

Cooling
 Heating

- Th_D Thermistor (Discharge Temp.)
- Th_O Thermistor (Outdoor Temp.)
- Th_{HO} Thermistor (Heat Exchanger Out Temp.)
- Th_R Thermistor (Room Temp.)
- Th_{PI} Thermistor (Pipe Temp.)

Refrigerant pipe diameter
 Liquid: 1/4" (6.35 mm)
 Gas: 3/8" (9.52 mm)

MODEL: AOU15RLS3H

OUTDOOR UNIT
AOU9-15RLS3H

OUTDOOR UNIT
AOU9-15RLS3H

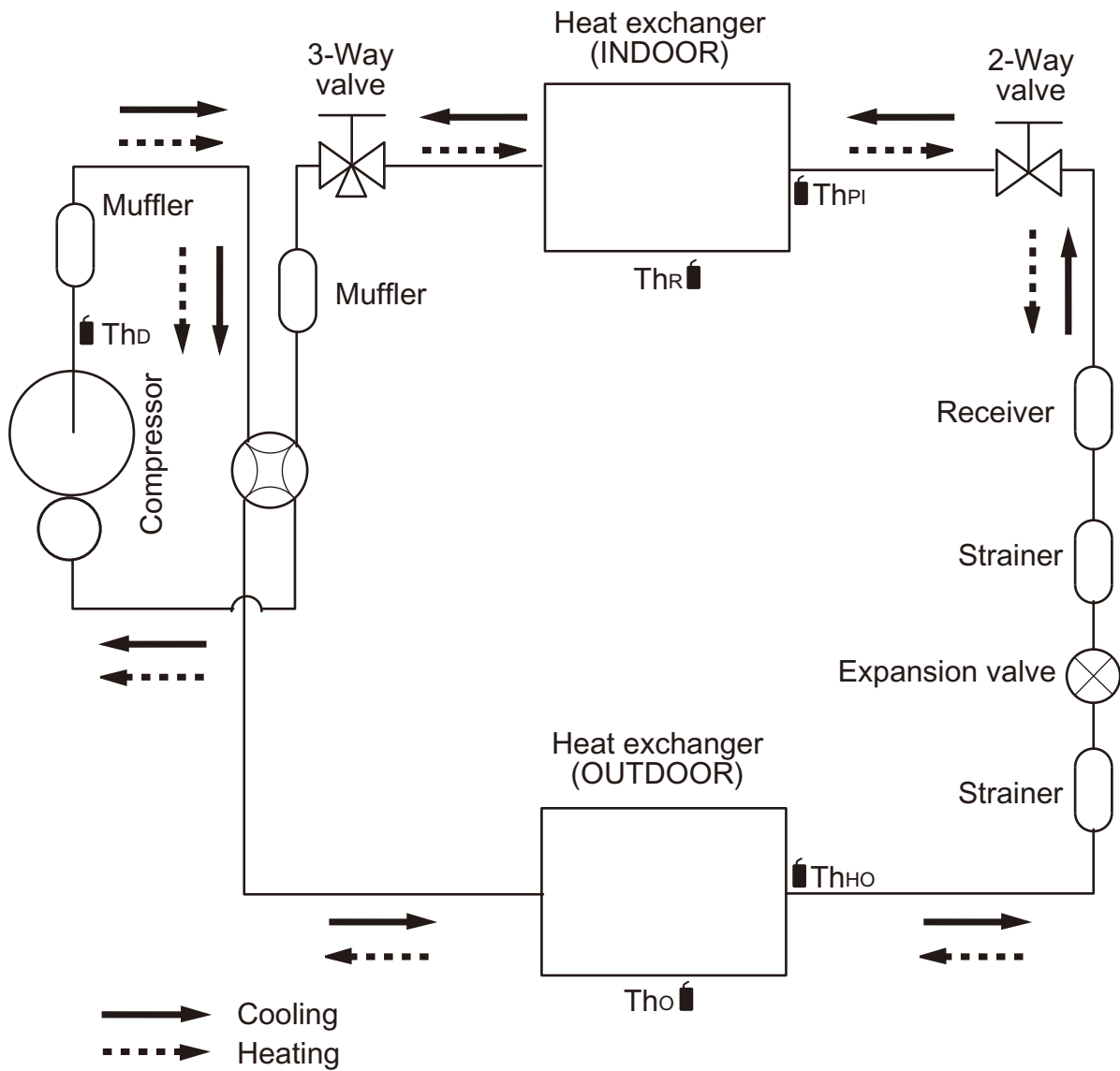

- Th_D Thermistor (Discharge Temp.)
- Th_O Thermistor (Outdoor Temp.)
- Th_{HO} Thermistor (Heat Exchanger Out Temp.)
- Th_R Thermistor (Room Temp.)
- Th_{PI} Thermistor (Pipe Temp.)

Refrigerant pipe diameter
 Liquid: 1/4" (6.35 mm)
 Gas: 1/2" (12.70 mm)

4. WIRING DIAGRAMS

MODEL: AOU9RLS3H, AOU12RLS3H

OUTDOOR UNIT
AOU9-15RLS3H

OUTDOOR UNIT
AOU9-15RLS3H

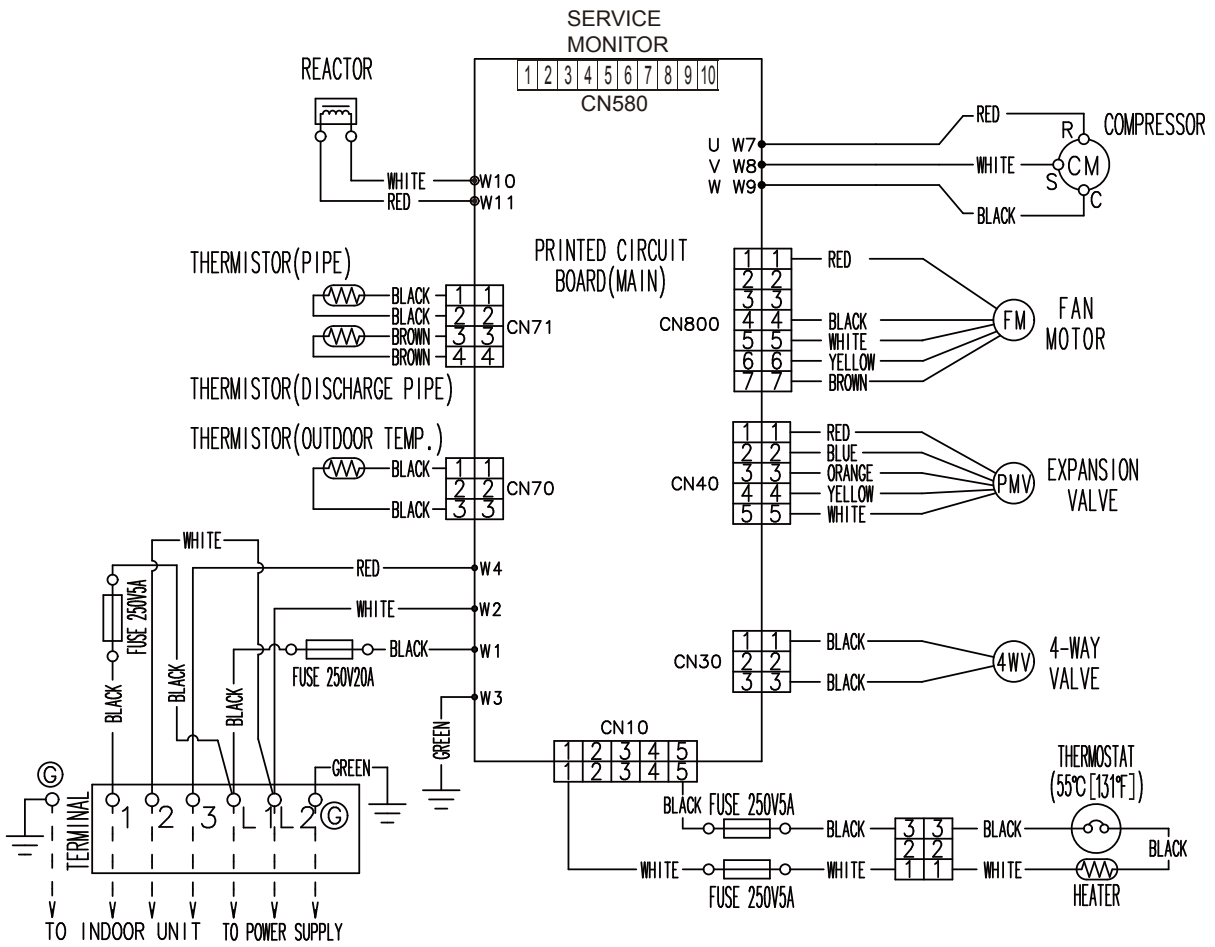

MODEL: AOU15RLS3H

OUTDOOR UNIT
AOU9-15RLS3H

OUTDOOR UNIT
AOU9-15RLS3H

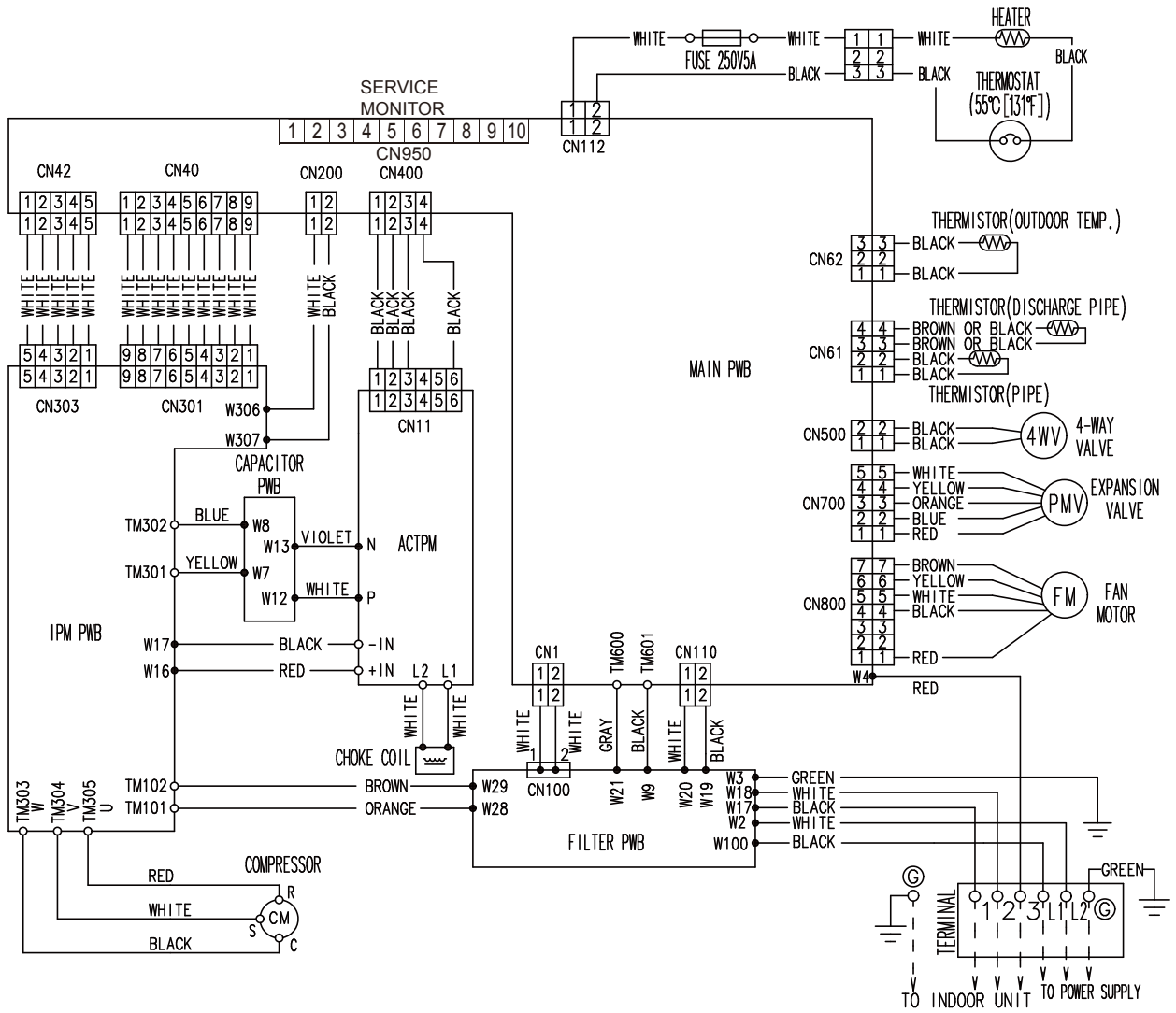

5. CAPACITY COMPENSATION RATE FOR PIPE LENGTH AND HEIGHT DIFFERENCE

MODEL: AOU9RLS3H, AOU12RLS3H

OUTDOOR UNIT
AOU9-15RLS3H

OUTDOOR UNIT
AOU9-15RLS3H

COOLING				Pipe length (m)				
				5m	7.5m	10m	15m	20m
				17ft.	25ft.	33ft.	50ft.	67ft.
Height difference H	*1 Indoor unit is higher than outdoor unit.	15m	50ft.	-	-	-	0.877	0.874
		10m	33ft.	-	-	0.956	0.891	0.888
		7.5m	25ft.	-	0.988	0.960	0.895	0.892
		5m	17ft.	1.017	0.992	0.964	0.899	0.895
	*2 Indoor unit is lower than outdoor unit	0m	0ft.	1.025	1.000	0.971	0.906	0.902
		-5m	-17ft.	1.025	1.000	0.971	0.906	0.902
		-7.5m	-25ft.	-	1.000	0.971	0.906	0.902
		-10m	-33ft.	-	-	0.971	0.906	0.902
		-15m	-50ft.	-	-	-	0.906	0.902

HEATING				Pipe length (m)				
				5m	7.5m	10m	15m	20m
				17ft.	25ft.	33ft.	50ft.	67ft.
Height difference H	*1 Indoor unit is higher than outdoor unit.	15m	50ft.	-	-	-	0.933	0.925
		10m	33ft.	-	-	0.981	0.933	0.925
		7.5m	25ft.	-	1.000	0.981	0.933	0.925
		5m	17ft.	1.017	1.000	0.981	0.933	0.925
	*2 Indoor unit is lower than outdoor unit	0m	0ft.	1.017	1.000	0.981	0.933	0.925
		-5m	-17ft.	1.012	0.995	0.976	0.928	0.920
		-7.5m	-25ft.	-	0.993	0.974	0.926	0.918
		-10m	-33ft.	-	-	0.971	0.923	0.916
		-15m	-50ft.	-	-	-	0.914	0.906

Height difference H

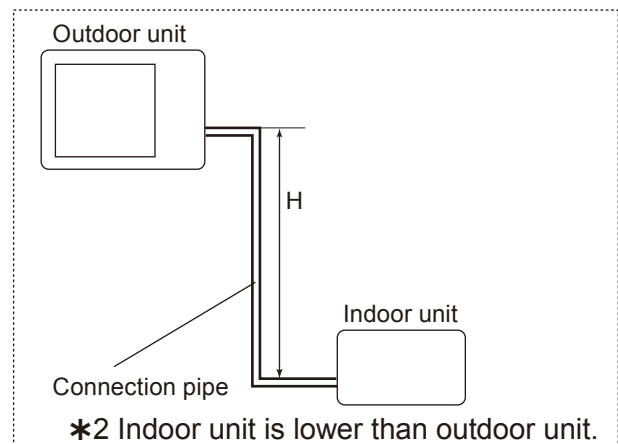
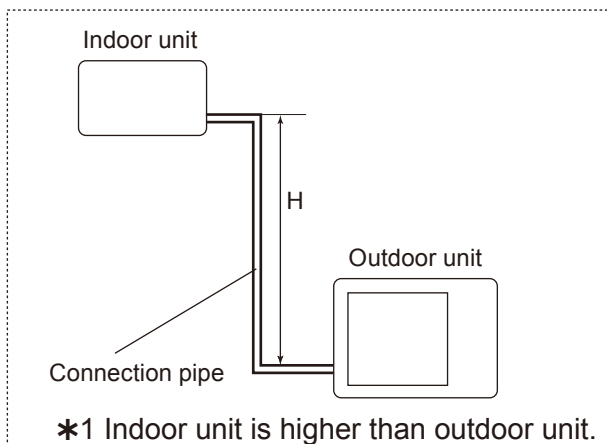

MODEL: AOU15RLS3H

OUTDOOR UNIT
AOU9-15RLS3H

OUTDOOR UNIT
AOU9-15RLS3H

COOLING				Pipe length (m)				
				5m	7.5m	10m	15m	20m
				17ft.	25ft.	33ft.	50ft.	67ft.
Height difference H	*1 Indoor unit is higher than outdoor unit.	15m	50ft.	-	-	-	0.951	0.950
		10m	33ft.	-	-	0.979	0.967	0.966
		7.5m	25ft.	-	0.988	0.983	0.971	0.970
		5m	17ft.	0.994	0.992	0.987	0.975	0.974
	*2 Indoor unit is lower than outdoor unit	0m	0ft.	1.002	1.000	0.995	0.983	0.982
		-5m	-17ft.	1.002	1.000	0.995	0.983	0.982
		-7.5m	-25ft.	-	1.000	0.995	0.983	0.982
		-10m	-33ft.	-	-	0.995	0.983	0.982
		-15m	-50ft.	-	-	-	0.983	0.982

HEATING				Pipe length (m)				
				5m	7.5m	10m	15m	20m
				17ft.	25ft.	33ft.	50ft.	67ft.
Height difference H	*1 Indoor unit is higher than outdoor unit.	15m	50ft.	-	-	-	0.994	0.979
		10m	33ft.	-	-	1.012	0.994	0.979
		7.5m	25ft.	-	1.000	1.012	0.994	0.979
		5m	17ft.	0.969	1.000	1.012	0.994	0.979
	*2 Indoor unit is lower than outdoor unit	0m	0ft.	0.969	1.000	1.012	0.994	0.979
		-5m	-17ft.	0.964	0.995	1.007	0.989	0.974
		-7.5m	-25ft.	-	0.993	1.004	0.986	0.972
		-10m	-33ft.	-	-	1.002	0.984	0.969
		-15m	-50ft.	-	-	-	0.974	0.959

Height difference H

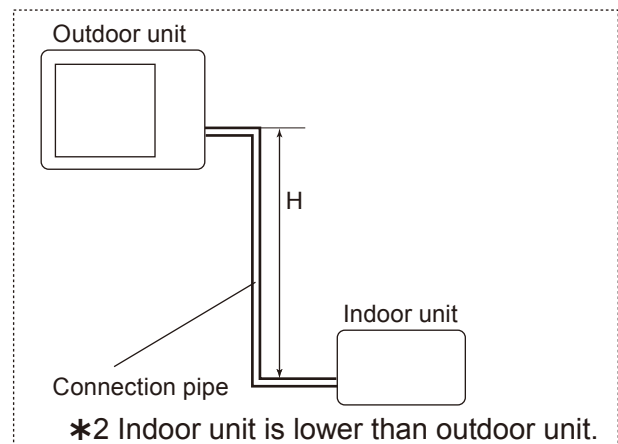
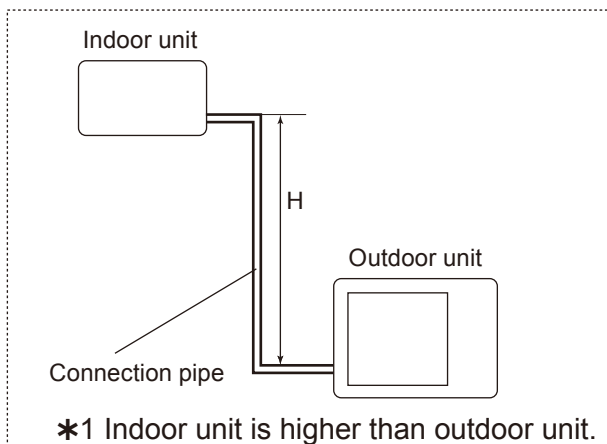

6. ADDITIONAL CHARGE CALCULATION

■ MODEL: AOU9RLS3H, AOU12RLS3H

Refrigerant type		R410A
Refrigerant amount	lbs. oz.	2lbs.14oz.
	g	1,300

● REFRIGERANT CHARGE

Pipe length	ft.	49 or less	66 (MAX)	0.22oz./ft. (20g/m)
	m	15 or less	20 (MAX)	
Additional charge	oz.	0	+3.5	
	g	0	+100	

■ MODEL: AOU15RLS3H

Refrigerant type		R410A
Refrigerant amount	lbs. oz.	3lbs.1oz.
	g	1,400

● REFRIGERANT CHARGE

Pipe length	ft.	49 or less	66 (MAX)	0.22oz./ft. (20g/m)
	m	15 or less	20 (MAX)	
Additional charge	oz.	0	+3.5	
	g	0	+100	

OUTDOOR UNIT
AOU9-15RLS3H

OUTDOOR UNIT
AOU9-15RLS3H

7. AIRFLOW

■ MODEL: AOU9RLS3H, AOU12RLS3H

● Cooling

Airflow	
1,680	m ³ /h
467	l/s
989	CFM

● Heating

Airflow	
1,840	m ³ /h
510	l/s
1,082	CFM

■ MODEL: AOU15RLS3H

● Cooling

Airflow	
2,050	m ³ /h
569	l/s
1,206	CFM

● Heating

Airflow	
1,840	m ³ /h
510	l/s
1,082	CFM

8. OPERATION NOISE

8-1. NOISE LEVEL CURVE

MODEL: AOU9RLS3H

● Cooling

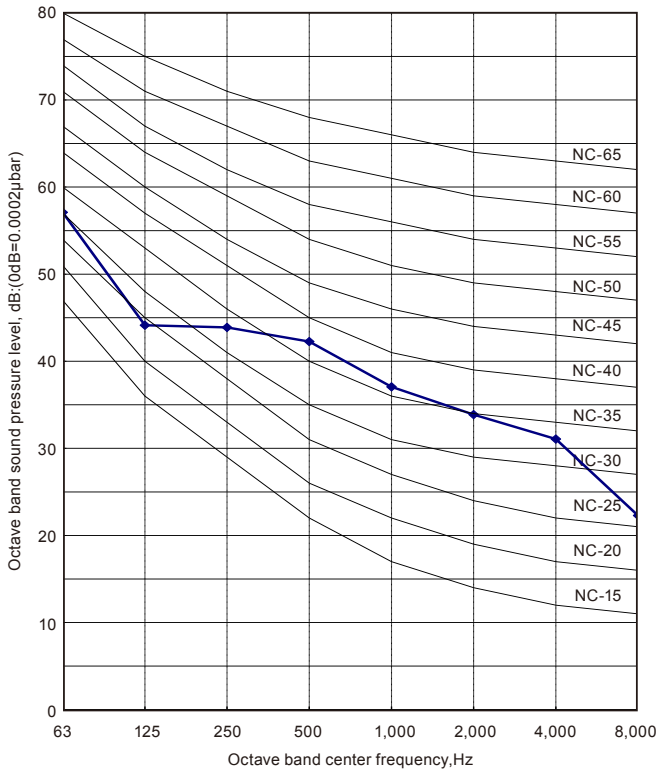

● Heating

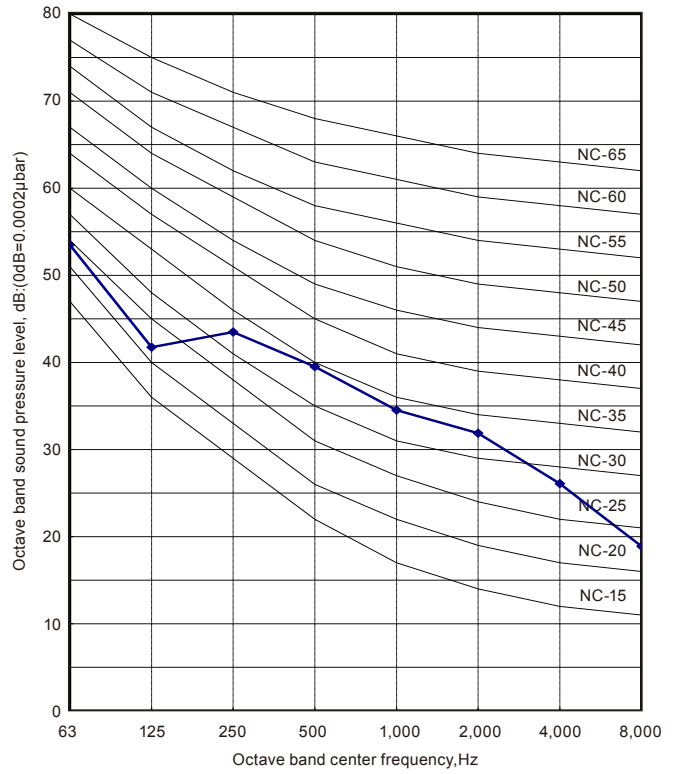

MODEL: AOU12RLS3H

● Cooling

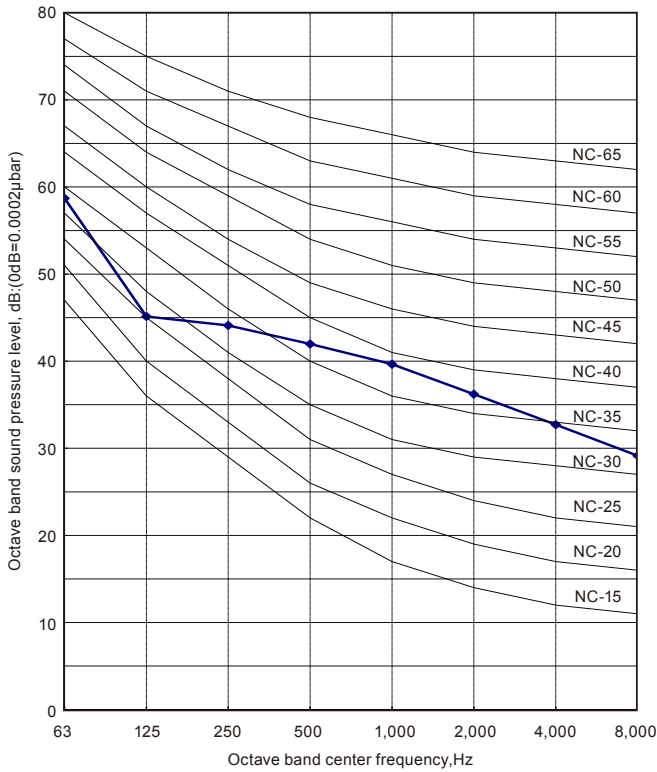

● Heating

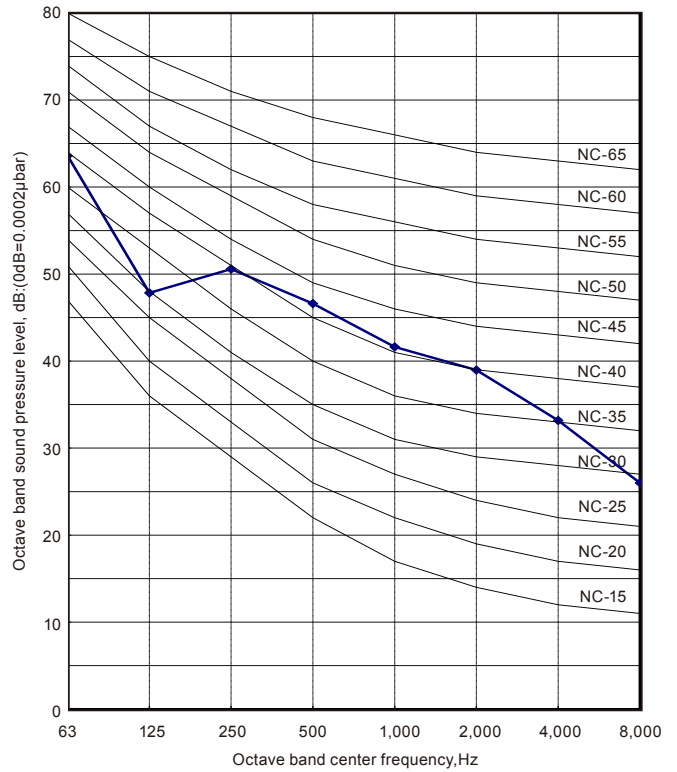

MODEL: AOU15RLS3H

● Cooling

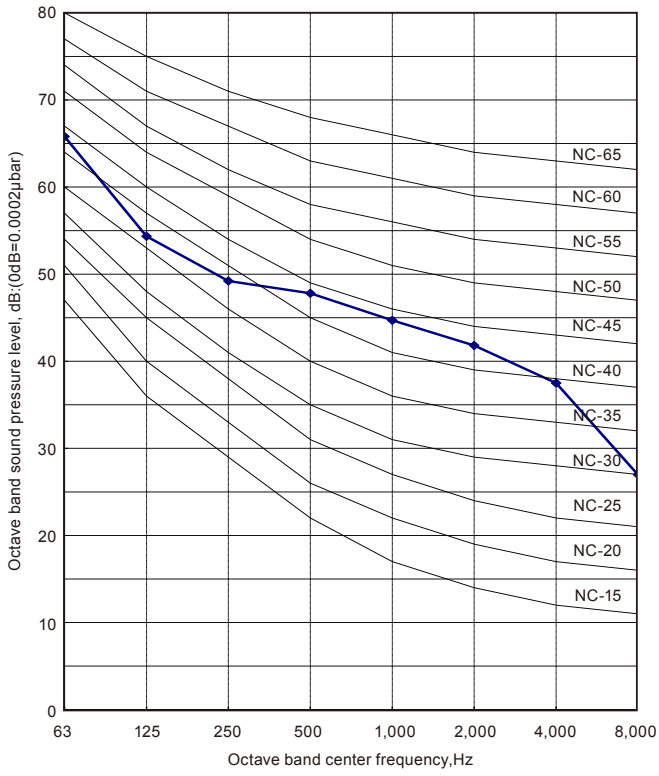

● Heating

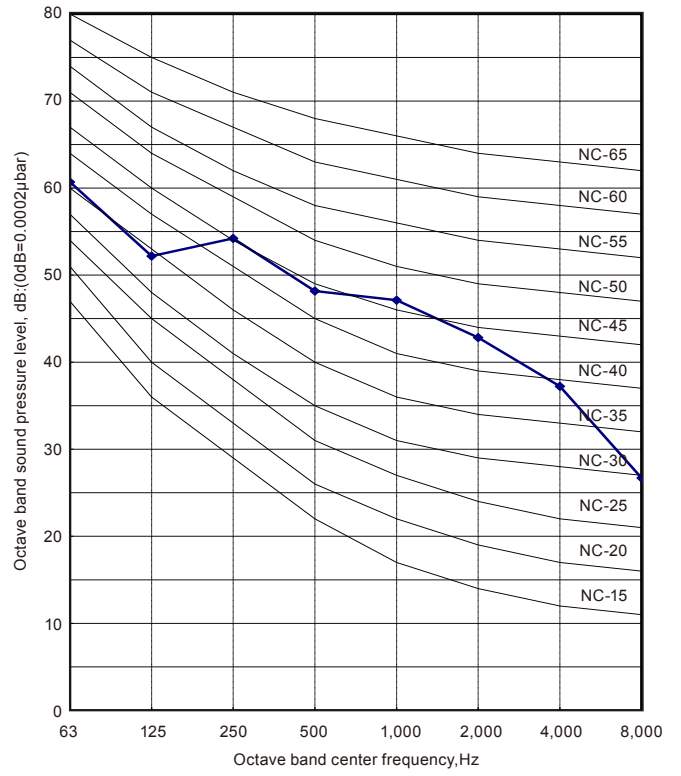

8-2. SOUND LEVEL CHECK POINT

OUTDOOR UNIT
AOU9-15RLS3H

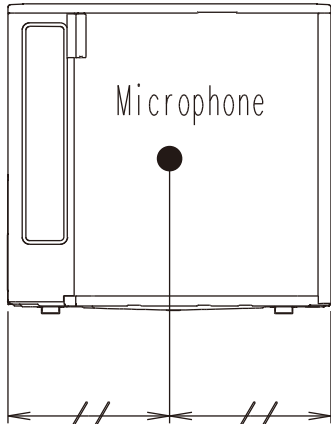
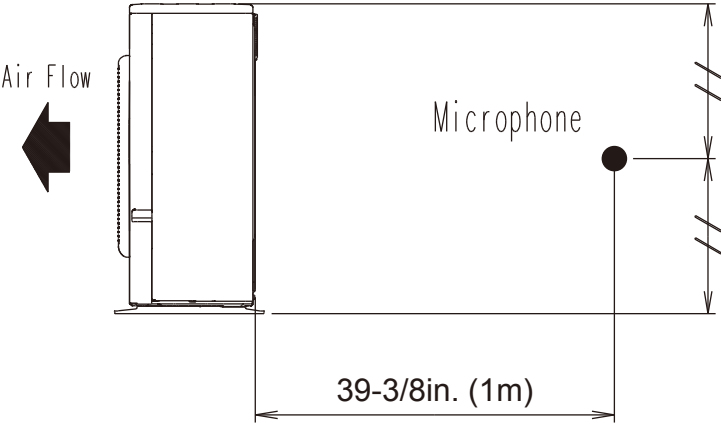

OUTDOOR UNIT
AOU9-15RLS3H

9. ELECTRIC CHARACTERISTICS

Model name			AOU9RLS3H	AOU12RLS3H	AOU15RLS3H
Power supply	Voltage	V	208 / 230 ~		
	Frequency	Hz	60		
MCA		A	14.4		18.2
Starting Current		A	3.3	4.7	5.2
Wiring Spec. *1	MAX. CKT. BKR	A	15		20
	Power Cable	AWG	14		12
	Connection cable *2	AWG	14		
	Limited wiring length :	ft. (m)	68 (21)		

*1: Selected sample based on Japan Electrotechnical Standards and Codes Committee E0005.

*2: Limit voltage drop to less than 2%. Increase conductor size if voltage drop is 2% or more.

MCA : Min Circuit Amp (Calculation based on UL1995)

MAX. CKT. BKR : Maximum Circuit Breaker

10. SAFETY DEVICES

OUTDOOR UNIT
AOU9-15RLS3H

OUTDOOR UNIT
AOU9-15RLS3H

	Protection form	Model		
		AOU9RLS3H	AOU12RLS3H	AOU15RLS3H
Circuit protection	Current fuse (NEAR THE TERMINAL)	250V 20A		250V 5A
		250V 5A		
	Current fuse (MAIN PRINTED CIRCUIT BOARD)	250V 15A		250V 3.15A
		250V 3.15A		250V 5A
	Current fuse (FILTER PRINTED CIRCUIT BOARD)	-		250V 25A
250V 5A				
Fan motor protection	Thermal protection program	OFF : 212±27 °F (100±15 °C) ON : 203±18 °F (95±10 °C)		
Compressor protection	Thermal protection program (Discharge temp.)	OFF : 230 °F (110 °C) ON : After 7 minutes		