



PIPE TOOLS & VISES
SINCE 1896

Drill-Powered Chamfer Tools

Replacement Parts

PB2, PB3, PB4

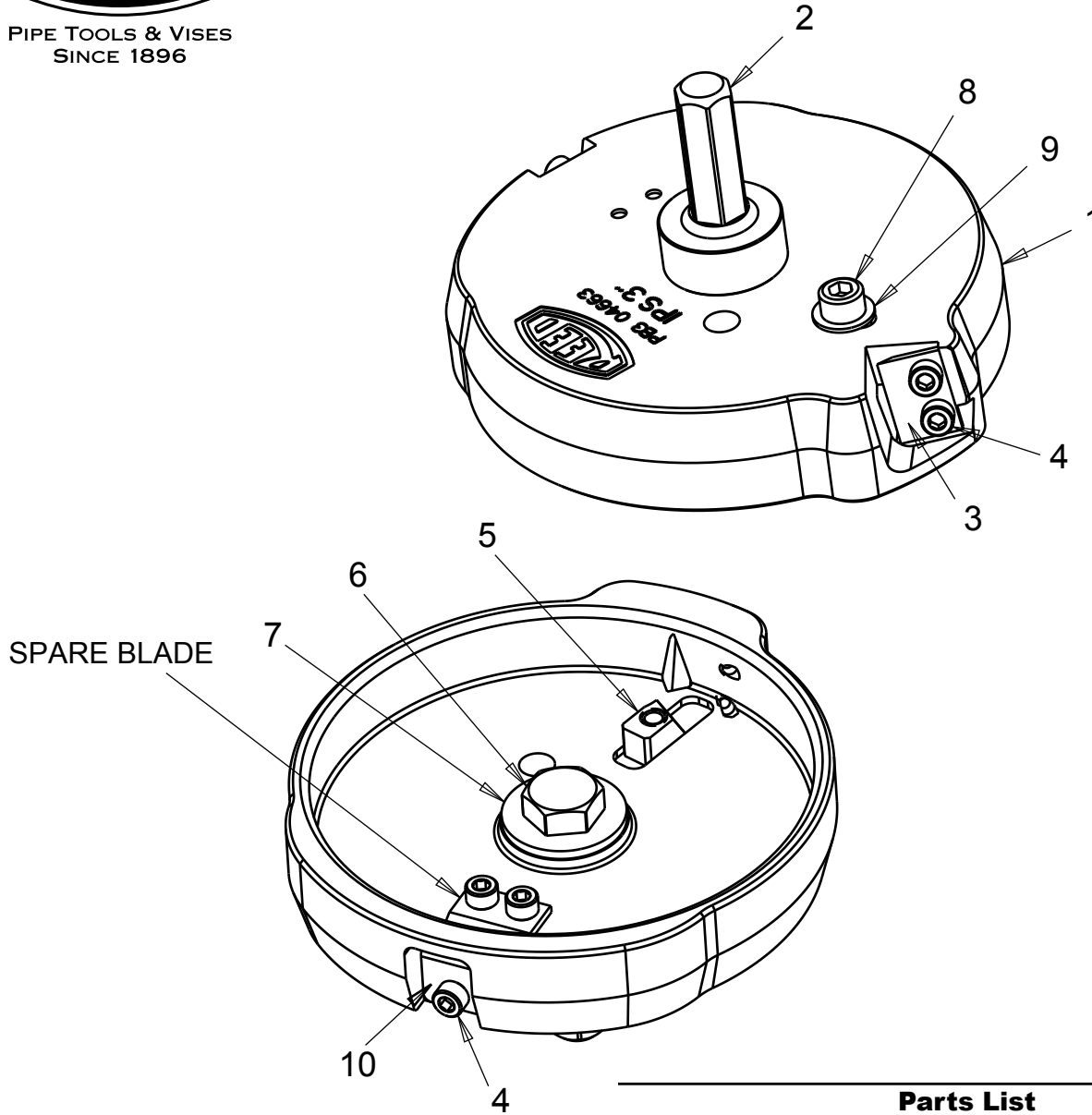

Parts List

Ref. No.	Description	Item Code	Quantity
1	A. PB2 BODY	94662	1
	B. PB3 BODY	94663	1
	C. PB4 BODY	94664	1
2	ARBOR	94665	1
3	CUTTING BLADE	94661	2
4	SOCKET HEAD SCREW 6-32 X 1/4	35303	5
5	PB INTERNAL BLADE	94667	1
6	HEX HEAD SCREW	31008	1
7	FLAT WASHER	30246	1
8	SOCKET HEAD SCREW	35295	1
9	WASHER #10	30254	1
10	FLAT SPRING	94668	1