



— EST. 1929 —



DECORATIVE HARDWARE | BATH HARDWARE | DECORATIVE HOOKS
FUNCTIONAL HARDWARE | DISPLAYS



INSPIRED DESIGN

Personalize your space with a distinctive, finishing touch that reflects your very own unique style.



CONTENTS



INTRODUCTION

INSPIRED COORDINATING COLLECTIONS – P. 4



DECORATIVE CABINET HARDWARE

INTRODUCTION – P. 6

FINISH INDEX – P. 8

TRANSITIONAL – P. 12

CONTEMPORARY – P. 28

TRADITIONAL – P. 44



DECORATIVE CABINET HARDWARE (CONTINUED)

ECLECTIC – P. 70

OVERSIZED – P. 92

ALLISON™ VALUE HARDWARE – P. 110

ALLISON™ VALUE HARDWARE FINISH INDEX – P. 112



DECORATIVE BATH HARDWARE

INTRODUCTION – P. 154

FINISH INDEX – P. 156

PRODUCT LISTING – P. 157



DECORATIVE HOOKS

INTRODUCTION – P. 162

FINISH INDEX – P. 164

PRODUCT LISTING – P. 166



FUNCTIONAL CABINET HARDWARE

INTRODUCTION – P. 170

FINISH INDEX – P. 172

PRODUCT LISTING – P. 174



DISPLAYS

INTRODUCTION – P. 210



PRODUCT INDEX

PACK TYPE INFORMATION – P. 213

COLLECTION LISTING – P. 214

FULL PRODUCT LISTING – P. 216



Featured Here: Candler Decorative Cabinet Hardware in Caramel Bronze.

Featured Right: Collection of coordinating Cabinet Hardware, Bath Hardware & Hooks in Caramel Bronze.



INSPIRED COORDINATING COLLECTIONS

Since 1929, we've been inspired to create decorative hardware collections and finishes that transcend décor fashion trends, and incorporate discerning design tastes. Designed to beautifully coordinate with a wide variety of styles and décor accents, our decorative hardware collections make it easy to create a seamless look in any room of the home. With more than 160 finishes, you can personalize your space with a distinctive, finishing touch that reflects your very own unique style.



Featured Here:
Candler Decorative Cabinet Hardware in Caramel Bronze,
and Large Coat & Hat Hook in Caramel Bronze.



DECORATIVE HARDWARE

INTRODUCTION
p.6

FINISH INDEX
p.8

TRANSITIONAL
p.12

CONTEMPORARY
p.28

TRADITIONAL
p.44

ECLECTIC
p.70

OVERSIZED
p.92

ALLISON® VALUE HARDWARE
p.110

SILVER TONES

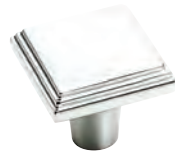

26

Polished Chrome



PN

Polished Nickel



SN

Satin Nickel (Matte)



26D

Brushed Chrome



G9

Sterling Nickel



G10

Satin Nickel



SS

Stainless Steel



AA

Anodized Aluminum



CP

Champagne



AN

Antique Nickel



AS

Antique Silver



AP

Aged Pewter



WN

Weathered Nickel



WNC

Weathered Nickel Copper

GOLD TONES



BBZ

Brushed Bronze



3

Polished Brass



GB

Gilded Bronze



074

Brushed Brass



EB

Elegant Brass



DBS

Distressed Brass



AE

Antique English



BB

Burnished Brass



077

Burnished Brass

GOLD TONES



R1

Regency Brass



R2

Weathered Brass



R3

Rustic Brass

RUSTIC TONES

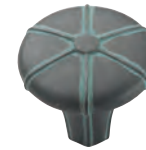

VS

Viridian Slate



WC

Weathered Copper



RBZ

Rustic Bronze



ART

Antique Rust



CBZ

Caramel Bronze

DARK TONES



WI

Wrought Iron



WID

Wrought Iron Dark



RB

Roman Bronze



ORB

Oil Rubbed Bronze



DOB

Dark Oiled Bronze

DARK TONES



GPH

Graphite



PWT

Pewter



SBK

Silvered Black



BN

Black Nickel



BNB

Black Nickel (Solid Brass)



BBR

Black Bronze



MB

Matte Black



FB

Flat Black

COLORS



30

White



W

White



A

Almond



DW

Distressed Cream



DAW

Distressed Antique White



NBZ

Black

TWO-TONED



CS

Crystal



CSG

Crystal/ Satin Nickel



CGB

Crystal/ Gilded Bronze



CORB

Crystal/ Oil Rubbed Bronze



CBBR

Crystal/ Black Bronze



CBB

Acrylic/ Burnished Brass



CG10

Clear Glass/ Satin Nickel



AORB

Amber Glass/ Oil Rubbed Bronze



ABBR

Amber Glass/ Black Bronze



GPT

Pewter/ Satin Nickel



INSPIRED COORDINATING COLLECTIONS

Decorative hardware styles and finishes designed to beautifully coordinate throughout your home.

Featured Here:

Extensity Decorative Cabinet Hardware in Caramel Bronze and 18" Beveled Honey Pine Hook Rack with Pilltop Hooks in Caramel Bronze.



TRANSITIONAL

Simple, yet sophisticated, transitional design embraces the comfort of traditional, classic looks with the stylish touch of contemporary forms.

CANDLER

Available Finishes

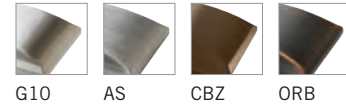

A full finish index is located on pages 8-11.

Product Number	Type of Hardware
29367G10*	Oversized Pull* – 18"
29366G10*	Oversized Pull* – 12"
29365G10*	Oversized Pull* – 8"
29364G10	Pull – 160mm
29363G10	Pull – 128mm
29355G10	Pull – 96mm
29349G10	Pull – 3"
29368G10*	Oversized Knob* – 1 1/2"
29340G10	Knob – 1 1/4"
29367AS*	Oversized Pull* – 18"
29366AS*	Oversized Pull* – 12"
29365AS*	Oversized Pull* – 8"
29364AS	Pull – 160mm
29363AS	Pull – 128mm
29355AS	Pull – 96mm
29349AS	Pull – 3"
29368AS*	Oversized Knob* – 1 1/2"
29340AS	Knob – 1 1/4"
29366CBZ*	Oversized Pull* – 12"
29365CBZ*	Oversized Pull* – 8"
29364CBZ <i>(shown)</i>	Pull – 160mm
29363CBZ <i>(shown)</i>	Pull – 128mm
29355CBZ <i>(shown)</i>	Pull – 96mm
29349CBZ <i>(shown)</i>	Pull – 3"
29368CBZ* <i>(shown)</i>	Oversized Knob* – 1 1/2"
29340CBZ <i>(shown)</i>	Knob – 1 1/4"
29366ORB*	Oversized Pull* – 12"
29365ORB*	Oversized Pull* – 8"
29364ORB	Pull – 160mm
29363ORB	Pull – 128mm
29355ORB	Pull – 96mm
29349ORB	Pull – 3"
29368ORB*	Oversized Knob* – 1 1/2"
29340ORB	Knob – 1 1/4"

*Image can be located in Oversized section that begins on page 92.
Pack type information can be located in the Product Index that begins on page 213.



EXTENSITY

Available Finishes

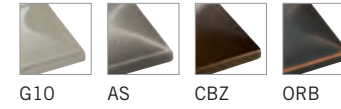

A full finish index is located on pages 8-11.

Product Number	Type of Hardware
29397G10*	Oversized Pull* – 18"
29396G10*	Oversized Pull* – 12"
29395G10*	Oversized Pull* – 8"
29394G10	Pull – 160mm
29393G10	Pull – 128mm
29385G10	Pull – 96mm
29379G10	Pull – 3"
29398G10*	Oversized Knob* – 1 1/2"
29370G10	Knob – 1 3/16"
29397AS*	Oversized Pull* – 18"
29396AS*	Oversized Pull* – 12"
29395AS*	Oversized Pull* – 8"
29394AS <i>(shown)</i>	Pull – 160mm
29393AS <i>(shown)</i>	Pull – 128mm
29385AS <i>(shown)</i>	Pull – 96mm
29379AS <i>(shown)</i>	Pull – 3"
29398AS* <i>(shown)</i>	Oversized Knob* – 1 1/2"
29370AS <i>(shown)</i>	Knob – 1 3/16"
29397CBZ*	Oversized Pull* – 18"
29396CBZ*	Oversized Pull* – 12"
29395CBZ*	Oversized Pull* – 8"
29394CBZ	Pull – 160mm
29393CBZ	Pull – 128mm
29385CBZ	Pull – 96mm
29379CBZ	Pull – 3"
29398CBZ*	Oversized Knob* – 1 1/2"
29370CBZ	Knob – 1 3/16"
29396ORB*	Oversized Pull* – 12"
29395ORB*	Oversized Pull* – 8"
29394ORB	Pull – 160mm
29393ORB	Pull – 128mm
29385ORB	Pull – 96mm
29379ORB	Pull – 3"
29398ORB*	Oversized Knob* – 1 1/2"
29370ORB	Knob – 1 3/16"

*Image can be located in Oversized section that begins on page 92.
Pack type information can be located in the Product Index that begins on page 213.



HIGHLAND RIDGE

Available Finishes



A full finish index is located on pages 8-11.

Product Number	Type of Hardware
55324PN*	Oversized Pull* – 18"
55323PN*	Oversized Pull* – 12"
55322PN*	Oversized Pull* – 8"
55314PN (shown)	Backplate – 5"
55321PN (shown)	Pull – 160mm
55319PN (shown)	Pull – 128mm
55317PN (shown)	Pull – 96mm
55316PN (shown)	Pull – 3"
55318PN (shown)	Cup Pull – 3.5"
55315PN (shown)	Latch – 1 3/5"
55312PN (shown)	Knob – 28mm
55311PN (shown)	Rectangular Knob – 35mm
55324AP*	Oversized Pull* – 18"
55323AP*	Oversized Pull* – 12"
55322AP*	Oversized Pull* – 8"
55314AP	Backplate – 5"
55321AP	Pull – 160mm
55319AP	Pull – 128mm
55317AP	Pull – 96mm
55316AP	Pull – 3"
55318AP	Cup Pull – 3.5"
55315AP	Latch – 1 3/5"
55312AP	Knob – 28mm
55311AP	Rectangular Knob – 35mm
55324DOB*	Oversized Pull* – 18"
55323DOB*	Oversized Pull* – 12"
55322DOB*	Oversized Pull* – 8"
55314DOB	Backplate – 5"
55321DOB	Pull – 160mm
55319DOB	Pull – 128mm
55317DOB	Pull – 96mm
55316DOB	Pull – 3"
55318DOB	Cup Pull – 3.5"
55315DOB	Latch – 1 3/5"
55312DOB	Knob – 28mm
55311DOB	Rectangular Knob – 35mm

*Image can be located in Oversized section that begins on page 92.
Pack type information can be located in the Product Index that begins on page 213.



55314PN
5" length

55321PN
160mm ctr.

55319PN
128mm ctr.

55317PN
96mm ctr.

55316PN
3" ctr.

55318PN
3.5" ctr.



55315PN
1 3/5" length



55312PN
28mm dia.



55311PN
35mm length

WESTERLY™

Available Finishes

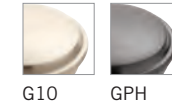

A full finish index is located on pages 8-11.

Product Number	Type of Hardware
54024G10*	Oversized Pull* – 18"
54023G10*	Oversized Pull* – 12"
53722G10 (shown)	Pull – 160mm
53721G10 (shown)	Pull – 128mm
53720G10 (shown)	Pull – 96mm
53719G10 (shown)	Pull – 3"
53718G10 (shown)	Knob – 1 3/16"
53717G10 (shown)	T-Knob – 34mm
54024GPH*	Oversized Pull* – 18"
54023GPH*	Oversized Pull* – 12"
53722GPH	Pull – 160mm
53721GPH	Pull – 128mm
53720GPH	Pull – 96mm
53719GPH	Pull – 3"
53718GPH	Knob – 1 3/16"
53717GPH	T-Knob – 34mm

*Image can be located in Oversized section that begins on page 92.
Pack type information can be located in the Product Index that begins on page 213.

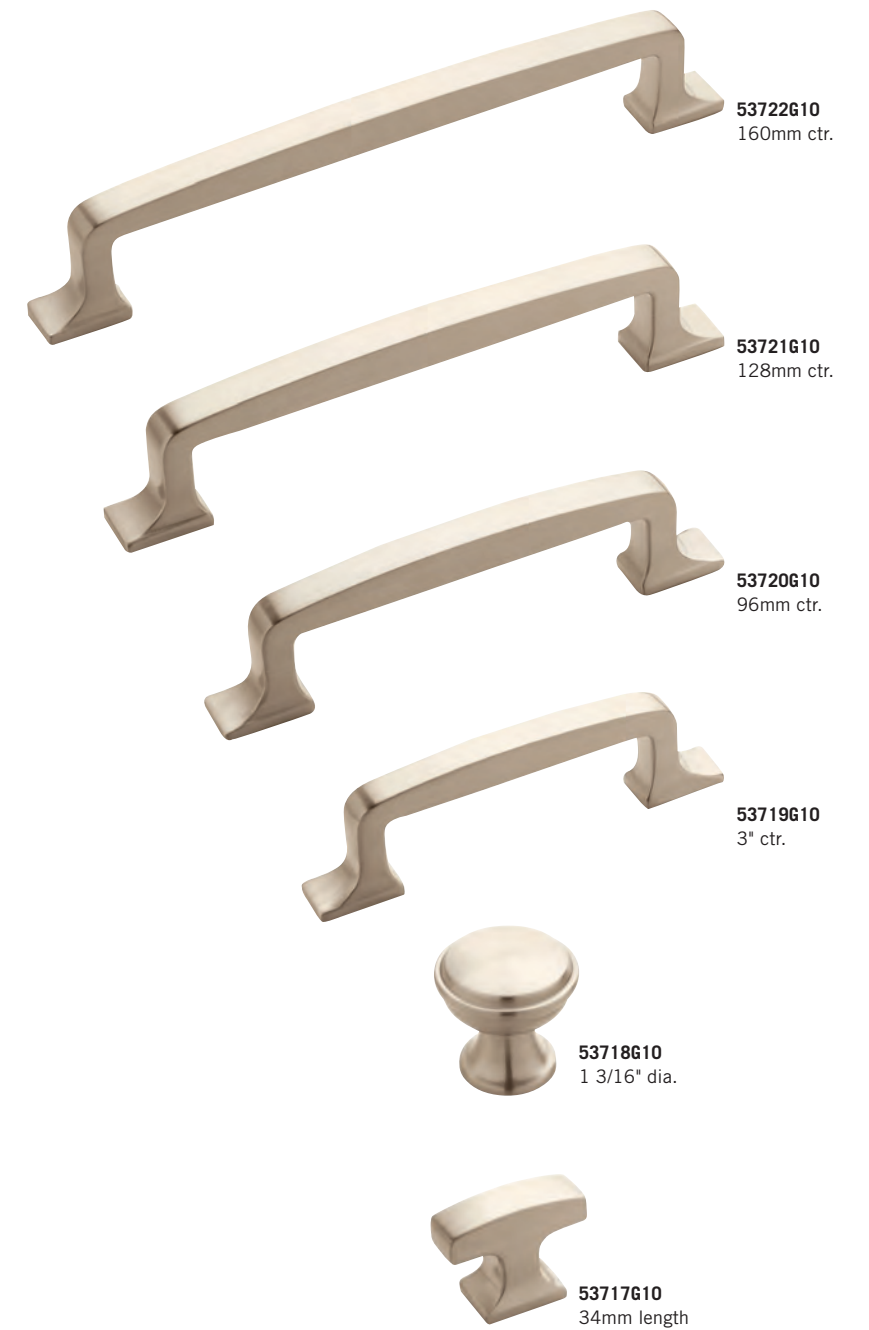

53722G10
160mm ctr.

53721G10
128mm ctr.

53720G10
96mm ctr.

53719G10
3" ctr.

53718G10
1 3/16" dia.

53717G10
34mm length

ROCHDALE™

Available Finishes



G10 GPH

A full finish index is located on pages 8-11.

Product Number	Type of Hardware
54022G10*	Oversized Pull* – 18"
54021G10*	Oversized Pull* – 12"
53714G10	Pull – 160mm
53713G10	Pull – 128mm
53712G10	Pull – 96mm
53711G10	Pull – 3"
53716G10	Cup Pull – 96mm
53715G10	Cup Pull – 3"
53710G10	Knob – 1 1/4"
54022GPH*	Oversized Pull* – 18"
54021GPH*	Oversized Pull* – 12"
53714GPH (shown)	Pull – 160mm
53713GPH (shown)	Pull – 128mm
53712GPH (shown)	Pull – 96mm
53711GPH (shown)	Pull – 3"
53716GPH (shown)	Cup Pull – 96mm
53715GPH (shown)	Cup Pull – 3"
53710GPH (shown)	Knob – 1 1/4"

*Image can be located in Oversized section that begins on page 92.
Pack type information can be located in the Product Index that begins on page 213.

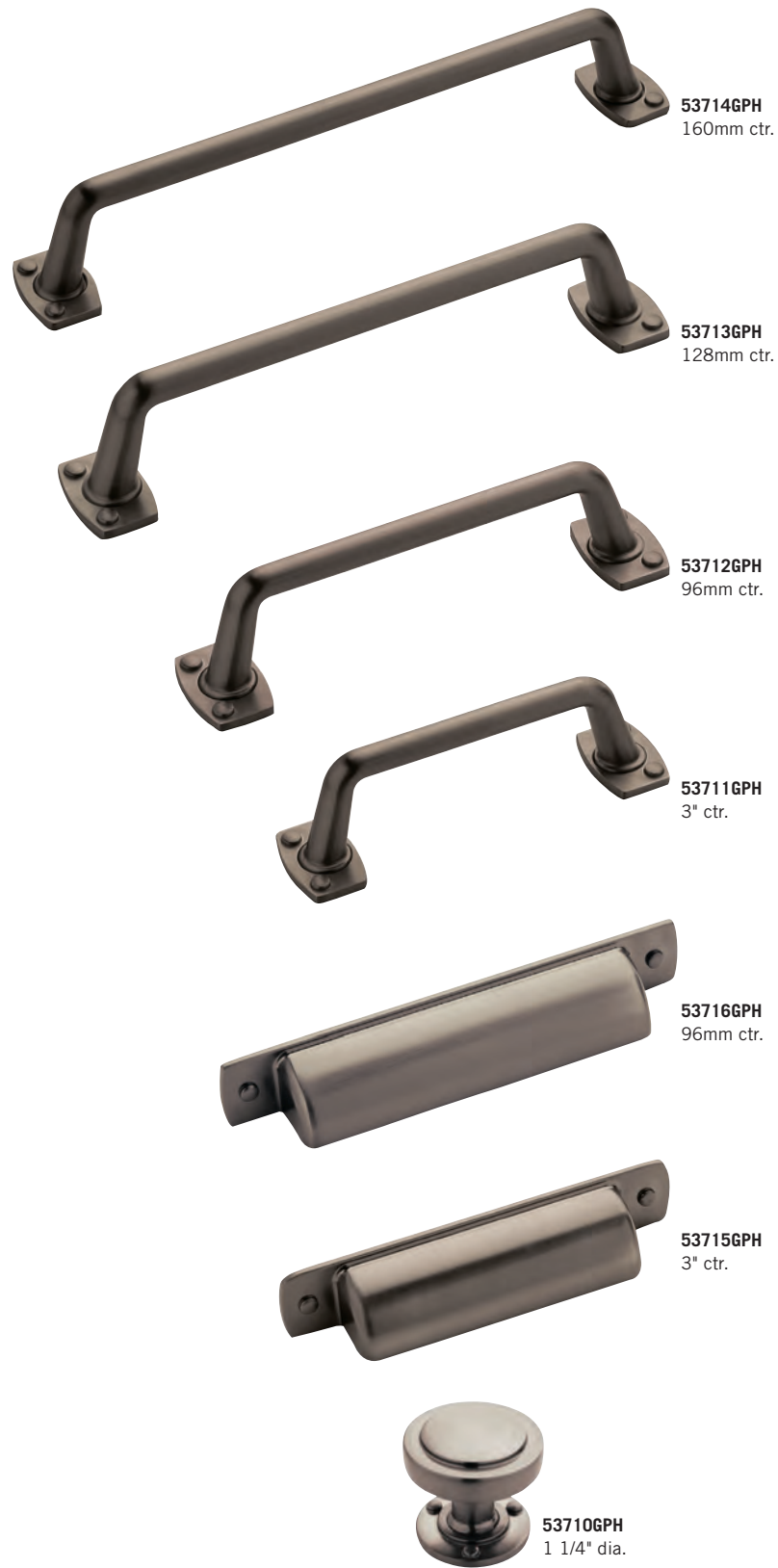

KANE™

Available Finishes

Finishes may not be available in all styles.



G10 AS WN GB RB



ORB

A full finish index is located on pages 8-11.

Product Number	Type of Hardware
53806G10*	Oversized Pull* – 18"
53805G10*	Oversized Pull* – 12"
53804G10*	Oversized Pull* – 8"
53803G10	Pull – 160mm
53802G10	Pull – 128mm
53702G10	Pull – 96mm
53701G10	Pull – 3"
53801G10	Cup Pull – 96mm
538072G10*	Oversized Knob* – 1 5/8"
53700G10	Knob – 1 1/4"
53702AS	Pull – 96mm
53806WN*	Oversized Pull* – 18"
53805WN*	Oversized Pull* – 12"
53804WN*	Oversized Pull* – 8"
53803WN (shown)	Pull – 160mm
53802WN (shown)	Pull – 128mm
53702WN (shown)	Pull – 96mm
53701WN (shown)	Pull – 3"
53801WN (shown)	Cup Pull – 96mm
538072WN* (shown)	Oversized Knob* – 1 5/8"
53700WN (shown)	Knob – 1 1/4"
53702GB	Pull – 96mm
53702RB	Pull – 96mm
53806ORB*	Oversized Pull* – 18"
53805ORB*	Oversized Pull* – 12"
53804ORB*	Oversized Pull* – 8"
53803ORB	Pull – 160mm
53802ORB	Pull – 128mm
53702ORB	Pull – 96mm
53701ORB	Pull – 3"
53801ORB	Cup Pull – 96mm
538072ORB*	Oversized Knob* – 1 5/8"
53700ORB	Knob – 1 1/4"

*Image can be located in Oversized section that begins on page 92.
Pack type information can be located in the Product Index that begins on page 213.



INSPIRATIONS™

Available Finishes

Finishes may not be available in all styles.



G10 WN R2 WC ART

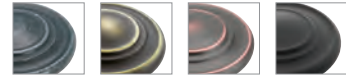

WID RB ORB FB

A full finish index is located on pages 8-11.

Product Number	Type of Hardware
54001G10*	Oversized Pull* – 8"
1589G10 (shown)	Pull – 160mm
1588G10 (shown)	Pull – 128mm
1587G10 (shown)	Pull – 96mm
1590G10 (shown)	Pull – 3"
15862G10* (shown)	Oversized Knob* – 1 3/4"
1586G10 (shown)	Knob – 1 3/8"
4258G10 (shown)	Knob – 1 3/16"
54001WN*	Oversized Pull* – 8"
1589WN	Pull – 160mm
1588WN	Pull – 128mm
1587WN	Pull – 96mm
1590WN	Pull – 3"
15862WN*	Oversized Knob* – 1 3/4"
1586WN	Knob – 1 3/8"
4258WN	Knob – 1 3/16"
1590R2	Pull – 3"
1586R2	Knob – 1 3/8"
1590WC	Pull – 3"
1586WC	Knob – 1 3/8"
1590ART	Pull – 3"
1586ART	Knob – 1 3/8"
1590WID	Pull – 3"
1586WID	Knob – 1 3/8"
4258WID	Knob – 1 3/16"
1586RB	Knob – 1 3/8"
54001ORB*	Oversized Pull* – 8"
1589ORB	Pull – 160mm
1588ORB	Pull – 128mm
1587ORB	Pull – 96mm
1590ORB	Pull – 3"
15862ORB*	Oversized Knob* – 1 3/4"
1586ORB	Knob – 1 3/8"
54001FB*	Oversized Pull* – 8"
1589FB	Pull – 160mm
1588FB	Pull – 128mm
1587FB	Pull – 96mm
1590FB	Pull – 3"
15862FB*	Oversized Knob* – 1 3/4"
1586FB	Knob – 1 3/8"

*Image can be located in Oversized section that begins on page 92.
Pack type information can be located in the Product Index that begins on page 213.



INSPIRATIONS™

Available Finishes

Finishes may not be available in all styles.



G10 WN ART WID RB

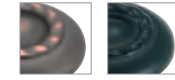

ORB FB

A full finish index is located on pages 8-11.

Product Number	Type of Hardware
1788G10*	Oversized Pull* – 18"
1787G10*	Oversized Pull* – 12"
54000G10*	Oversized Pull* – 8"
1786G10 (shown)	Pull – 160mm
1785G10 (shown)	Pull – 128mm
1784G10 (shown)	Pull – 96mm
1584G10 (shown)	Pull – 3"
15852G10* (shown)	Oversized Knob* – 1 3/4"
1585G10 (shown)	Knob – 1 1/4"
1584WN	Pull – 3"
1585WN	Knob – 1 1/4"
1584ART	Pull – 3"
1585ART	Knob – 1 1/4"
1788WID*	Oversized Pull* – 18"
1787WID*	Oversized Pull* – 12"
54000WID*	Oversized Pull* – 8"
1786WID	Pull – 160mm
1785WID	Pull – 128mm
1784WID	Pull – 96mm
1584WID	Pull – 3"
15852WID*	Oversized Knob* – 1 3/4"
1585WID	Knob – 1 1/4"
1584RB	Pull – 3"
1585RB	Knob – 1 1/4"
1788ORB*	Oversized Pull* – 18"
1787ORB*	Oversized Pull* – 12"
54000ORB*	Oversized Pull* – 8"
1786ORB	Pull – 160mm
1785ORB	Pull – 128mm
1784ORB	Pull – 96mm
1584ORB	Pull – 3"
15852ORB*	Oversized Knob* – 1 3/4"
1585ORB	Knob – 1 1/4"
1584FB	Pull – 3"
1585FB	Knob – 1 1/4"

*Image can be located in Oversized section that begins on page 92.
Pack type information can be located in the Product Index that begins on page 213.

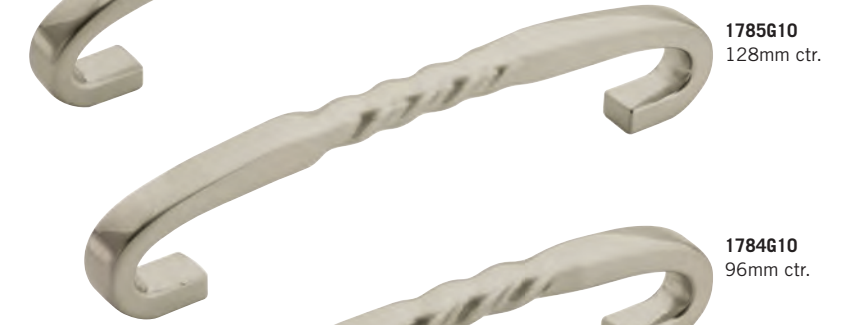

INSPIRATIONS™

Available Finishes

Finishes may not be available in all styles.

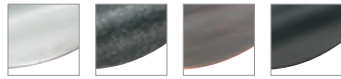

G10 WID ORB FB

A full finish index is located on pages 8-11.

Product Number	Type of Hardware
1592G10	Cup Pull – 3"
1593G10	Finger Pull – 1 7/8"
1592WID	Cup Pull – 3"
1592ORB (shown)	Cup Pull – 3"
1593ORB (shown)	Finger Pull – 1 7/8"
1592FB	Cup Pull – 3"
1593FB	Finger Pull – 1 7/8"

Pack type information can be located in the Product Index that begins on page 213.



1592ORB
3" ctr.



1593ORB
1 7/8" length

COLORS

Available Finish



NBZ

A full finish index is located on pages 8-11.

Product Number	Type of Hardware
3621NBZ (shown)	Pull – 4"

Pack type information can be located in the Product Index that begins on page 213.



3621NBZ
4" ctr.

ESSENTIAL'Z™

Available Finishes



SN AN WNC

A full finish index is located on pages 8-11.

Product Number	Type of Hardware
24002SN	Pull – 128mm
24001SN	Knob – 40mm
24002AN	Pull – 128mm
24001AN	Knob – 40mm
24002WNC (shown)	Pull – 128mm
24001WNC (shown)	Knob – 40mm

Pack type information can be located in the Product Index that begins on page 213.



24002WNC
128mm ctr.

24001WNC
40mm dia.

Available Finishes

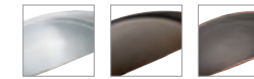

G10 ART ORB

A full finish index is located on pages 8-11.

Product Number	Type of Hardware
9365G10	Cup Pull – 64mm
9365ART	Cup Pull – 64mm
9365ORB (shown)	Cup Pull – 64mm

Pack type information can be located in the Product Index that begins on page 213.



9365ORB
64mm ctr.

PORTER™

Available Finishes

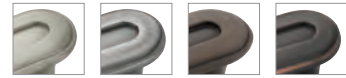

G10 WN ART ORB

A full finish index is located on pages 8-11.

Product Number	Type of Hardware
27024G10	Pull – 3"
27026G10	Knob – 1 1/4"
27024WN <i>(shown)</i>	Pull – 3"
27026WN <i>(shown)</i>	Knob – 1 1/4"
27024ART	Pull – 3"
27026ART	Knob – 1 1/4"
27024ORB	Pull – 3"
27026ORB	Knob – 1 1/4"

Pack type information can be located in the Product Index that begins on page 213.

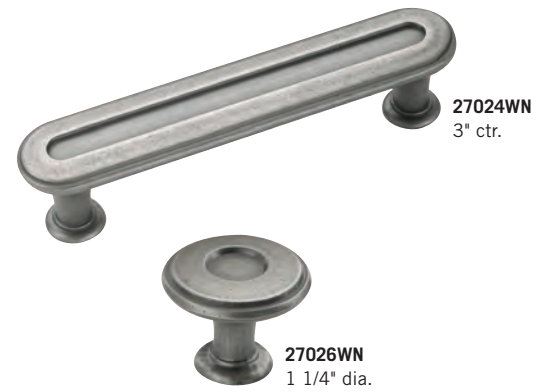

27024WN
3" ctr.

27026WN
1 1/4" dia.

Available Finishes

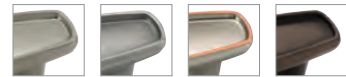

G10 WN WNC ART

A full finish index is located on pages 8-11.

Product Number	Type of Hardware
27005G10	Pull – 3"
27006G10	Square Knob – 1 1/8"
27005WN	Pull – 3"
27006WN	Square Knob – 1 1/8"
27005WNC <i>(shown)</i>	Pull – 3"
27006WNC <i>(shown)</i>	Square Knob – 1 1/8"
27005ART	Pull – 3"
27006ART	Square Knob – 1 1/8"

Pack type information can be located in the Product Index that begins on page 213.

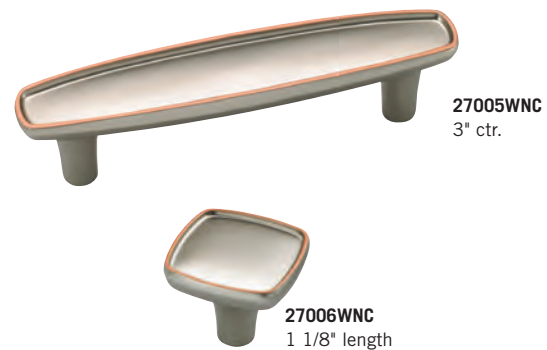

27005WNC
3" ctr.

27006WNC
1 1/8" length

CROSLEY™

Available Finishes

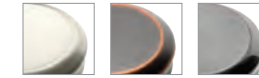

G10 ORB PWT

A full finish index is located on pages 8-11.

Product Number	Type of Hardware
53705G10	Pull – 96mm
53704G10	Pull – 3"
53703G10	Knob – 1"
53705ORB <i>(shown)</i>	Pull – 96mm
53704ORB <i>(shown)</i>	Pull – 3"
53703ORB <i>(shown)</i>	Knob – 1"
53705PWT	Pull – 96mm
53704PWT	Pull – 3"
53703PWT	Knob – 1"

Pack type information can be located in the Product Index that begins on page 213.



53705ORB
96mm ctr.

53704ORB
3" ctr.

53703ORB
1" dia.

POLARA™

Available Finishes



AP SBK

A full finish index is located on pages 8-11.

Product Number	Type of Hardware
54003AP*	Oversized Pull* – 12"
53026AP <i>(shown)</i>	Pull – 96mm
53025AP <i>(shown)</i>	Square Knob – 24mm
54003SBK*	Oversized Pull* – 12"
53026SBK	Pull – 96mm
53025SBK	Square Knob – 24mm

*Image can be located in Oversized section that begins on page 92.

Pack type information can be located in the Product Index that begins on page 213.



53026AP
96mm ctr.

53025AP
24mm dia.

COLOUR WASHED CERAMICS

Available Finishes



W A DW

A full finish index is located on pages 8-11.

Product Number	Type of Hardware
----------------	------------------

1321W	Knob – 1 3/8"
-------	---------------

1321A	Knob – 1 3/8"
-------	---------------

1321DW (shown)	Knob – 1 3/8"
-----------------------	----------------------

Pack type information can be located in the Product Index that begins on page 213.



1321DW
1 3/8" dia.

CERAMICS

Available Finishes

Finishes may not be available in all styles.



30 W CR

A full finish index is located on pages 8-11.

Product Number	Type of Hardware
----------------	------------------

72530 (shown)	Knob – 1 5/16"
----------------------	-----------------------

1320W (shown)	Knob – 1 3/8"
---------------	---------------

725ACR (shown)	Knob – 1 3/8"
----------------	---------------

Pack type information can be located in the Product Index that begins on page 213.



72530
1 5/16" dia.



1320W
1 3/8" dia.



725ACR
1 3/8" dia.





INSPIRED COORDINATING COLLECTIONS
 Create a seamless look throughout the home with a variety of collections and exquisite finishes that coordinate beautifully with existing décor.

Featured Here:
 Essential'Z Decorative Cabinet Hardware in Brushed Bronze, Arrondi Bath Hardware in Brushed Bronze and Contemporary Hook in Brushed Bronze



CONTEMPORARY

A blend of sophistication and simplicity, contemporary style emphasizes clean lines and smooth textures to reflect an architectural balance that creates the sleek and modern home.

ESSENTIAL'Z™ BRIDGE PULLS

Available Finishes



G10 BBZ

A full finish index is located on pages 8-11.

Product Number	Type of Hardware
29426G10*	Oversized Pull* – 18"
29425G10*	Oversized Pull* – 12"
29424G10*	Oversized Pull* – 8"
29423G10 (shown)	Pull – 160mm
29416G10 (shown)	Pull – 128mm
29415G10 (shown)	Pull – 96mm
29409G10 (shown)	Pull – 3"
29426BBZ*	Oversized Pull* – 18"
29425BBZ*	Oversized Pull* – 12"
29424BBZ*	Oversized Pull* – 8"
29423BBZ	Pull – 160mm
29416BBZ	Pull – 128mm
29415BBZ	Pull – 96mm
29409BBZ	Pull – 3"

*Image can be located in Oversized section that begins on page 92.

Pack type information can be located in the Product Index that begins on page 213.



ESSENTIAL'Z™ BAR PULLS

Available Finishes



G10 BBZ

A full finish index is located on pages 8-11.

Product Number	Type of Hardware
26207G10*	Oversized Pull* – 18"
26206G10*	Oversized Pull* – 12"
26205G10*	Oversized Pull* – 8"
26204G10	Pull – 160mm
9362G10	Pull – 128mm
26203G10	Pull – 96mm
26201G10	Pull – 3"
26207BBZ*	Oversized Pull* – 18"
26206BBZ*	Oversized Pull* – 12"
26205BBZ*	Oversized Pull* – 8"
26204BBZ (shown)	Pull – 160mm
9362BBZ (shown)	Pull – 128mm
26203BBZ (shown)	Pull – 96mm
26201BBZ (shown)	Pull – 3"

*Image can be located in Oversized section that begins on page 92.

Pack type information can be located in the Product Index that begins on page 213.

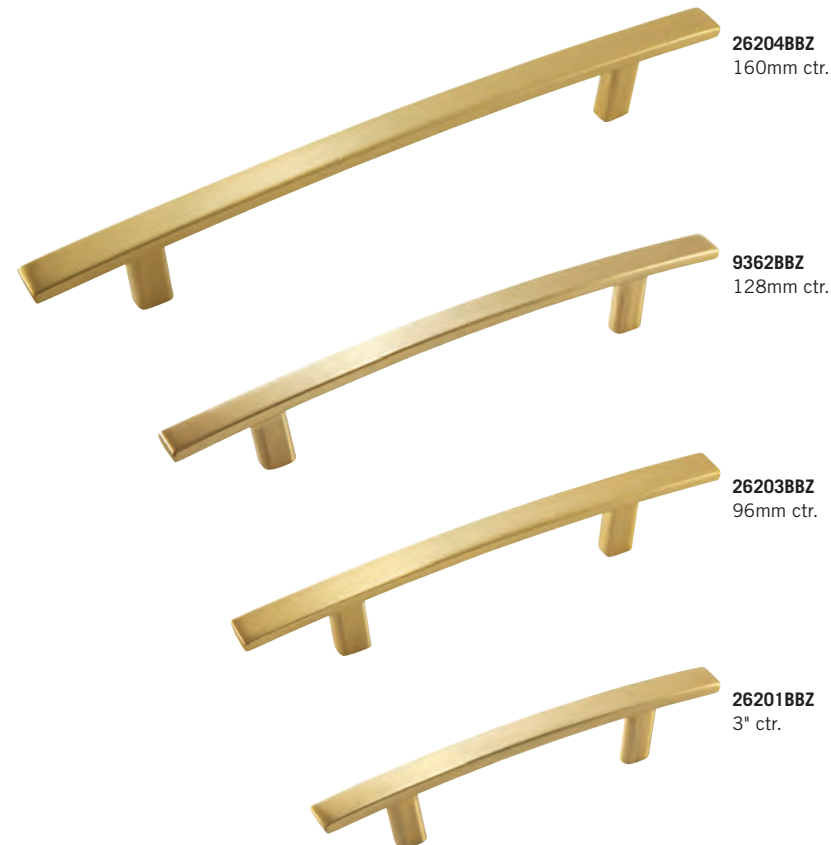

RIVA

Available Finishes

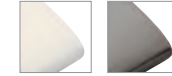

G10 GPH

A full finish index is located on pages 8-11.

Product Number	Type of Hardware
55371G10*	Oversized Pull* – 18"
55370G10*	Oversized Pull* – 12"
55369G10*	Oversized Pull* – 8"
55368G10 (shown)	Pull – 160mm
55367G10 (shown)	Pull – 128mm
55365G10 (shown)	Pull – 96mm
55364G10 (shown)	Pull – 3"
55360G10 (shown)	Knob – 1 1/7"
55371GPH*	Oversized Pull* – 18"
55370GPH*	Oversized Pull* – 12"
55369GPH*	Oversized Pull* – 8"
55368GPH	Pull – 160mm
55367GPH	Pull – 128mm
55365GPH	Pull – 96mm
55364GPH	Pull – 3"
55360GPH	Knob – 1 1/7"

*Image can be located in Oversized section that begins on page 92.

Pack type information can be located in the Product Index that begins on page 213.

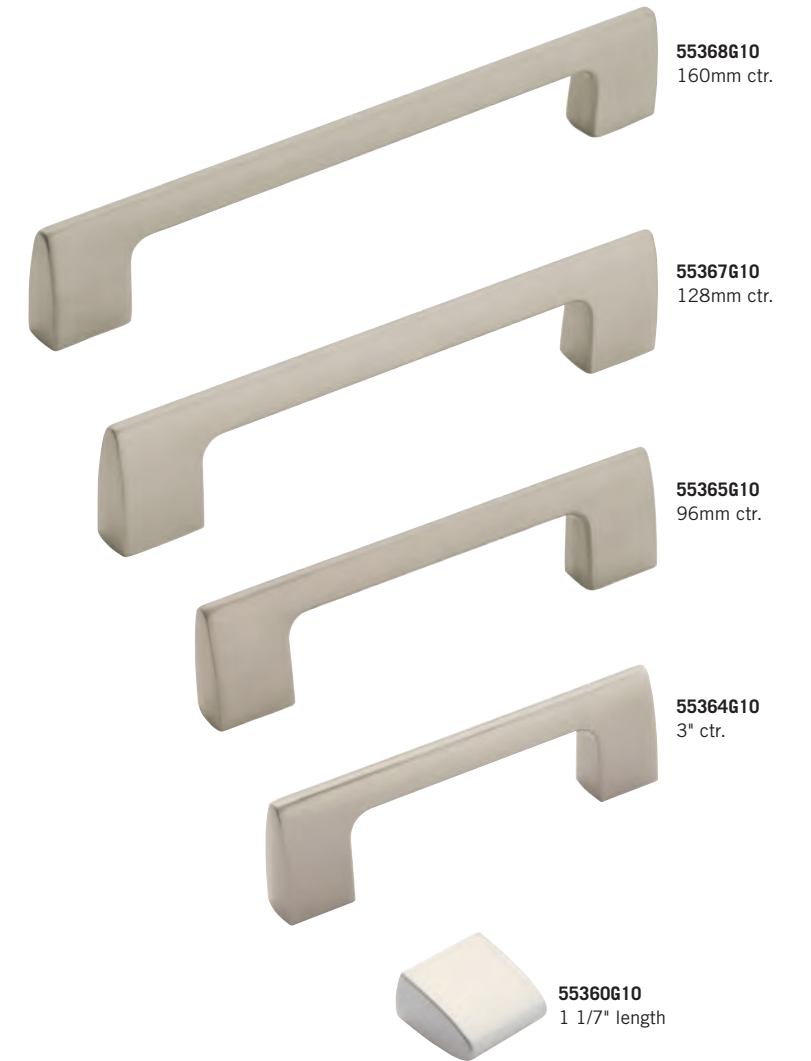

BAR PULLS

Available Finishes

Finishes may not be available in all styles.



G9 SS ORB

A full finish index is located on pages 8-11.

Product Number	Type of Hardware
19019CSG9*	Oversized Pull* – 768mm
19018CSG9*	Oversized Pull* – 640mm
19017CSG9*	Oversized Pull* – 544mm
19016CSG9*	Oversized Pull* – 480mm
19015CSG9*	Oversized Pull* – 416mm
19014CSG9*	Oversized Pull* – 320mm
19013CSG9*	Oversized Pull* – 256mm
19012CSG9	Pull – 192mm
19541CSG9	Pull – 128mm
19011CSG9	Pull – 96mm
19010CSG9	Pull – 3"
19019SS*	Oversized Pull* – 768mm
19018SS*	Oversized Pull* – 640mm
19017SS*	Oversized Pull* – 544mm
19016SS*	Oversized Pull* – 480mm
54025SS	Oversized Pull – 18"
19015SS*	Oversized Pull* – 416mm
19014SS*	Oversized Pull* – 320mm
54008SS	Oversized Pull – 12"
19013SS*	Oversized Pull* – 256mm
19012SS (shown)	Pull – 192mm
19541SS (shown)	Pull – 128mm
19011SS (shown)	Pull – 96mm
19010SS (shown)	Pull – 3"
19019ORB*	Oversized Pull* – 768mm
19018ORB*	Oversized Pull* – 640mm
19017ORB*	Oversized Pull* – 544mm
19016ORB*	Oversized Pull* – 480mm
54025ORB	Oversized Pull – 18"
19015ORB*	Oversized Pull* – 416mm
19014ORB*	Oversized Pull* – 320mm
54008ORB	Oversized Pull – 12"
40519ORB*	Oversized Pull* – 256mm
40518ORB	Pull – 192mm
40517ORB	Pull – 128mm
40516ORB	Pull – 96mm
40515ORB	Pull – 3"

*Image can be located in Oversized section that begins on page 92.

Pack type information can be located in the Product Index that begins on page 213.

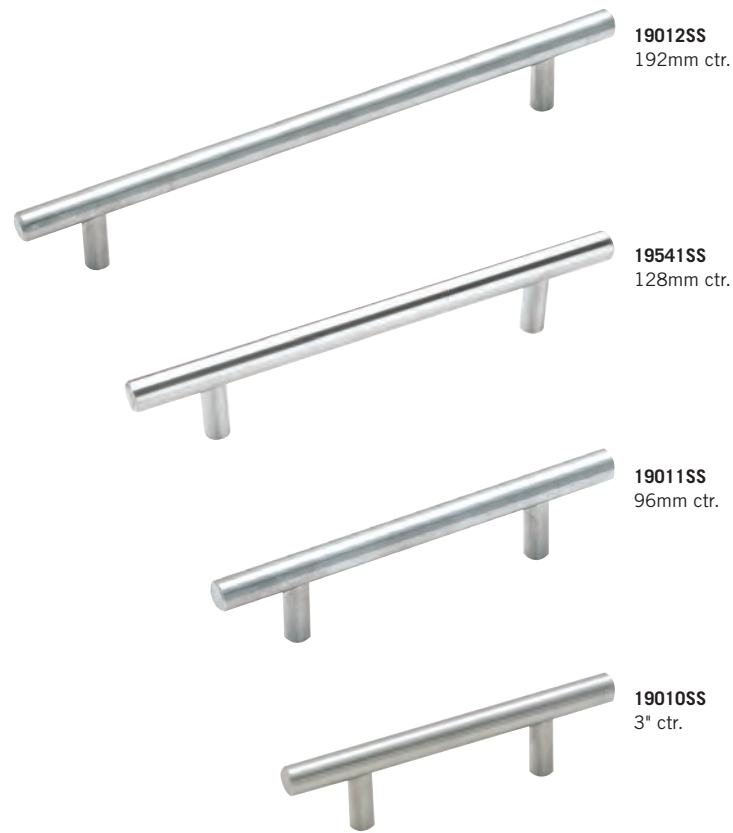

19012SS
192mm ctr.

19541SS
128mm ctr.

19011SS
96mm ctr.

19010SS
3" ctr.

STAINLESS STEEL

Available Finish



SS

A full finish index is located on pages 8-11.

Product Number	Type of Hardware
19005SS (shown)	Pull – 192mm
19004SS (shown)	Pull – 160mm
19003SS (shown)	Pull – 128mm
19002SS (shown)	Pull – 96mm
19001SS (shown)	Pull – 3"
26200SS (shown)	Knob – 32mm
19009SS (shown)	T-Knob – 2"
19008SS (shown)	Knob – 1 1/4"
19007SS (shown)	Knob – 1 3/16"
19006SS (shown)	T-Knob – 2"

Pack type information can be located in the Product Index that begins on page 213.

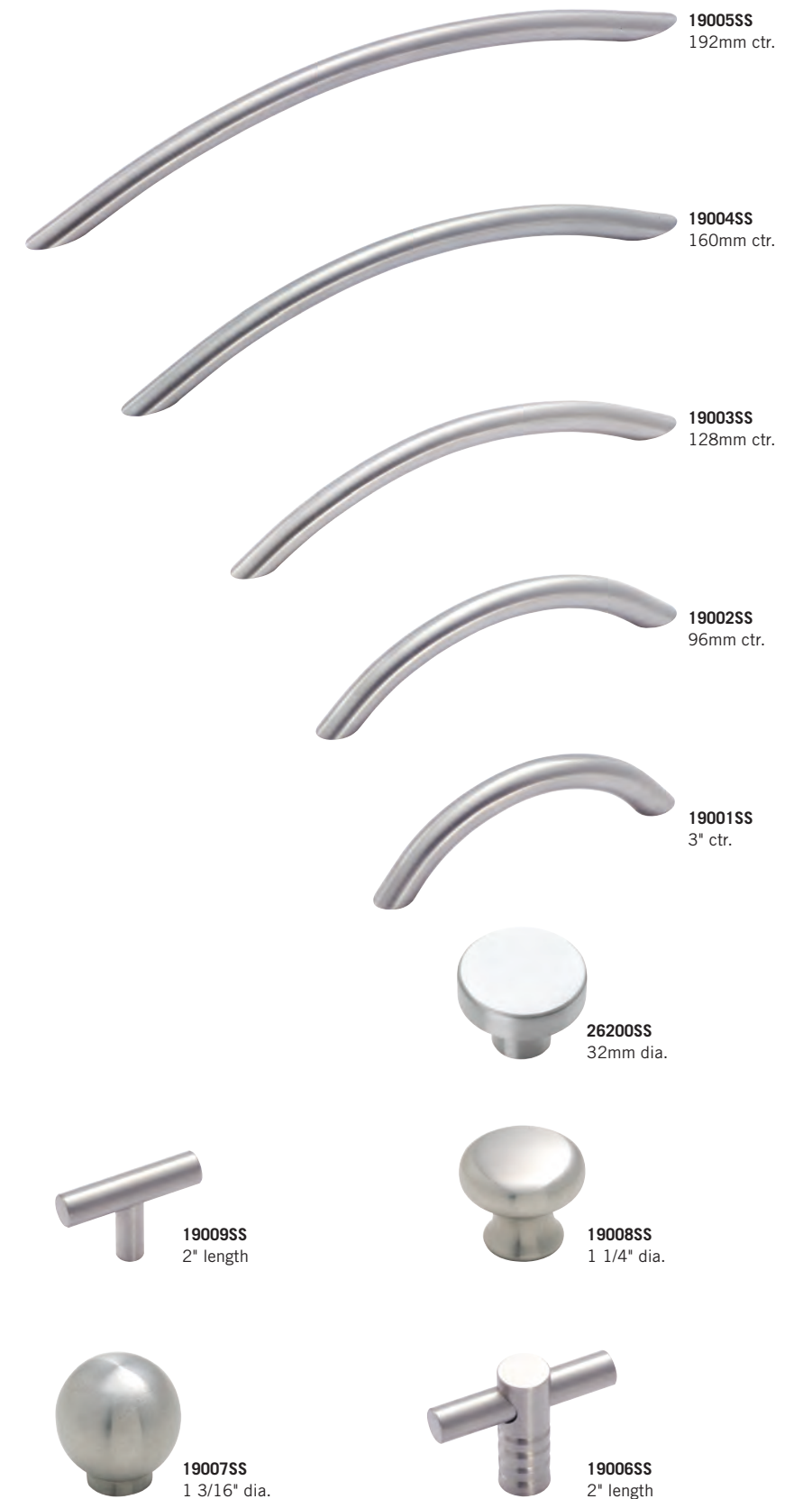

19005SS
192mm ctr.

19004SS
160mm ctr.

19003SS
128mm ctr.

19002SS
96mm ctr.

19001SS
3" ctr.

26200SS
32mm dia.

19009SS
2" length

19008SS
1 1/4" dia.

19007SS
1 3/16" dia.

19006SS
2" length

STAINLESS STEEL

Available Finish



SS

A full finish index is located on pages 8-11.

Product Number	Type of Hardware
----------------	------------------

24016SS <i>(shown)</i>	Pull – 192mm
24015SS <i>(shown)</i>	Pull – 128mm
26202SS <i>(shown)</i>	Pull – 96mm
24014SS <i>(shown)</i>	Pull – 64mm

Pack type information can be located in the Product Index that begins on page 213.



CREASED BOW™

Available Finishes



26 G10 AA

A full finish index is located on pages 8-11.

Product Number	Type of Hardware
----------------	------------------

2701726 <i>(shown)</i>	Pull – 128mm
2701626 <i>(shown)</i>	Pull – 96mm
2701826 <i>(shown)</i>	Knob – 7/8"

27017G10	Pull – 128mm
27016G10	Pull – 96mm
27018G10	Knob – 7/8"

27017AA	Pull – 128mm
27016AA	Pull – 96mm
27018AA	Knob – 7/8"

Pack type information can be located in the Product Index that begins on page 213.



SONARA

Available Finishes



SN AN

A full finish index is located on pages 8-11.

Product Number	Type of Hardware
----------------	------------------

53042SN <i>(shown)</i>	Pull – 128mm
53043SN <i>(shown)</i>	Knob – 31mm

53042AN	Pull – 128mm
53043AN	Knob – 31mm

Pack type information can be located in the Product Index that begins on page 213.

Available Finishes



SN SBK

A full finish index is located on pages 8-11.

Product Number	Type of Hardware
----------------	------------------

53044SN <i>(shown)</i>	Pull – 3"
53045SN <i>(shown)</i>	Knob – 27mm

53044SBK	Pull – 3"
53045SBK	Knob – 27mm

Pack type information can be located in the Product Index that begins on page 213.



CONRAD™

Available Finishes

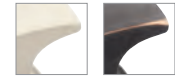

G10 ORB

A full finish index is located on pages 8-11.

Product Number	Type of Hardware
29200G10 <i>(shown)</i>	Pull – 96mm
29201G10 <i>(shown)</i>	Pull – 96mm
29202G10 <i>(shown)</i>	Pull – 96mm
29203G10 <i>(shown)</i>	T-Knob – 38.9mm
29200ORB	Pull – 96mm
29201ORB	Pull – 96mm
29202ORB	Pull – 96mm
29203ORB	T-Knob – 38.9mm

Pack type information can be located in the Product Index that begins on page 213.

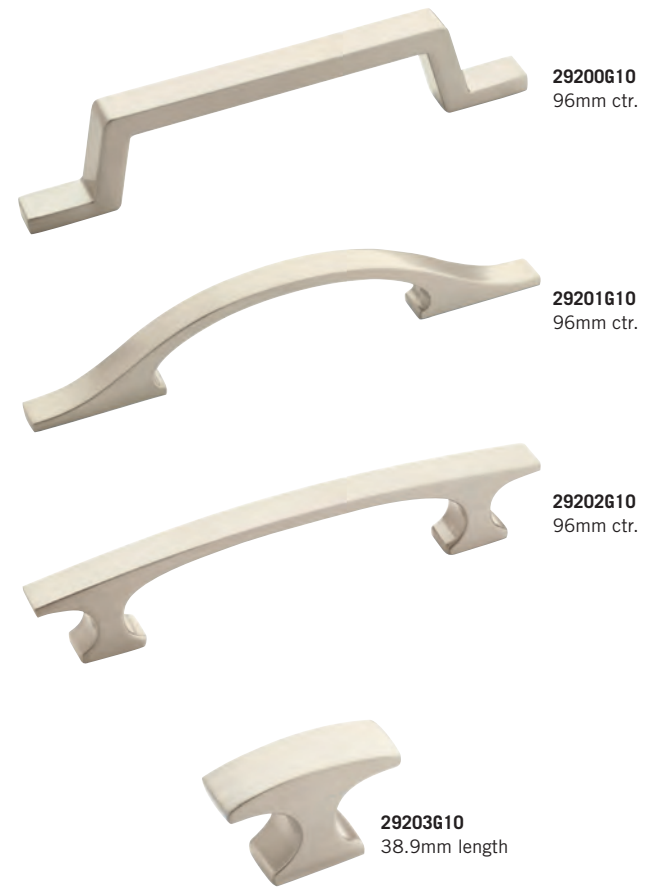

HARMONY

Available Finish



G10

A full finish index is located on pages 8-11.

Product Number	Type of Hardware
29446G10 <i>(shown)</i>	Pull – 128mm
29445G10 <i>(shown)</i>	Pull – 96mm
29439G10 <i>(shown)</i>	Pull – 3"

Pack type information can be located in the Product Index that begins on page 213.



ESSENTIAL'Z™

Available Finish



SN

A full finish index is located on pages 8-11.

Product Number	Type of Hardware
24017SN <i>(shown)</i>	Pull – 160mm
24018SN <i>(shown)</i>	Pull – 96mm

Pack type information can be located in the Product Index that begins on page 213.



Available Finishes

Finishes may not be available in all styles.



G10 WN WID

A full finish index is located on pages 8-11.

Product Number	Type of Hardware
----------------	------------------

9363G10 <i>(shown)</i>	Pull – 128mm
19202G10 <i>(shown)</i>	Pull – 96mm
19259G10 <i>(shown)</i>	Pull – 3"

19202WN	Pull – 96mm
19259WN	Pull – 3"

19202WID	Pull – 96mm
19259WID	Pull – 3"

Pack type information can be located in the Product Index that begins on page 213.

Available Finish



G10

A full finish index is located on pages 8-11.

Product Number	Type of Hardware
----------------	------------------

19203G10 <i>(shown)</i>	Pull – 128mm
--------------------------------	---------------------

Pack type information can be located in the Product Index that begins on page 213.

Available Finishes



SN SS

A full finish index is located on pages 8-11.

Product Number	Type of Hardware
----------------	------------------

24013SN	Pull – 128mm
---------	--------------

24013SS <i>(shown)</i>	Pull – 128mm
-------------------------------	---------------------

Pack type information can be located in the Product Index that begins on page 213.



9363G10
128mm ctr.



19202G10
96mm ctr.



19259G10
3" ctr.



19203G10
128mm ctr.



24013SS
128mm ctr.

Available Finishes

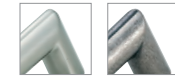

G10 WN

A full finish index is located on pages 8-11.

Product Number	Type of Hardware
----------------	------------------

19200G10 <i>(shown)</i>	Pull – 128mm
--------------------------------	---------------------

19200WN	Pull – 128mm
---------	--------------

Pack type information can be located in the Product Index that begins on page 213.

Available Finishes

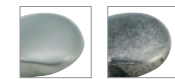

G10 WN

A full finish index is located on pages 8-11.

Product Number	Type of Hardware
----------------	------------------

19201G10 <i>(shown)</i>	Pull – 128mm
--------------------------------	---------------------

19201WN	Pull – 128mm
---------	--------------

Pack type information can be located in the Product Index that begins on page 213.

Available Finishes



G10 WN

A full finish index is located on pages 8-11.

Product Number	Type of Hardware
----------------	------------------

19205G10 <i>(shown)</i>	Pull – 128mm
--------------------------------	---------------------

19205WN	Pull – 128mm
---------	--------------

Pack type information can be located in the Product Index that begins on page 213.



19200G10
128mm ctr.



19201G10
128mm ctr.



19205G10
128mm ctr.

ESSENTIAL'Z™

Available Finishes



G10 WN

A full finish index is located on pages 8-11.

Product Number	Type of Hardware
----------------	------------------

19204G10 (shown)	Pull – 128mm
------------------	--------------

19204WN	Pull – 128mm
---------	--------------

Pack type information can be located in the Product Index that begins on page 213.

Available Finish



G10

A full finish index is located on pages 8-11.

Product Number	Type of Hardware
----------------	------------------

9364G10 (shown)	Pull – 128mm
-----------------	--------------

Pack type information can be located in the Product Index that begins on page 213.

DULCET™

Available Finishes



26 G10

A full finish index is located on pages 8-11.

Product Number	Type of Hardware
----------------	------------------

2702126 (shown)	Pull – 128mm
-----------------	--------------

2702026 (shown)	Pull – 96mm
-----------------	-------------

2701926 (shown)	Pull – 3"
-----------------	-----------

27021G10	Pull – 128mm
----------	--------------

27020G10	Pull – 96mm
----------	-------------

27019G10	Pull – 3"
----------	-----------

Pack type information can be located in the Product Index that begins on page 213.



19204G10
128mm ctr.



9364G10
128mm ctr.



2702126
128mm ctr.



2702026
96mm ctr.



2701926
3" ctr.

SLEEK

Available Finishes

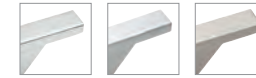

26 26D G10

A full finish index is located on pages 8-11.

Product Number	Type of Hardware
----------------	------------------

2613526	Pull – 96mm
---------	-------------

2613426	Pull – 3"
---------	-----------

2613526D (shown)	Pull – 96mm
------------------	-------------

2613426D (shown)	Pull – 3"
------------------	-----------

26135G10	Pull – 96mm
----------	-------------

26134G10	Pull – 3"
----------	-----------

Pack type information can be located in the Product Index that begins on page 213.

Available Finishes

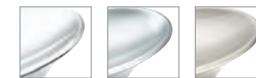

26 26D G10

A full finish index is located on pages 8-11.

Product Number	Type of Hardware
----------------	------------------

2612826	Pull – 64mm
---------	-------------

2612926	Knob – 2"
---------	-----------

2612826D (shown)	Pull – 64mm
------------------	-------------

2612926D (shown)	Knob – 2"
------------------	-----------

26128G10	Pull – 64mm
----------	-------------

26129G10	Knob – 2"
----------	-----------

Pack type information can be located in the Product Index that begins on page 213.



2613526D
96mm ctr.



2613426D
3" ctr.



2612826D
64mm ctr.



2612926D
2" length

BASIC | METALS

Available Finishes

Finishes may not be available in all styles.



G10 WN FB

A full finish index is located on pages 8-11.

Product Number	Type of Hardware
4479G10 <i>(shown)</i>	Pull – 96mm
4477G10 <i>(shown)</i>	Pull – 96mm
4478G10 <i>(shown)</i>	Pull – 96mm
4476G10 <i>(shown)</i>	T-Knob – 40mm
4478WN	Pull – 96mm
4479FB	Pull – 96mm
4477FB	Pull – 96mm
4476FB	T-Knob – 40mm

Pack type information can be located in the Product Index that begins on page 213.

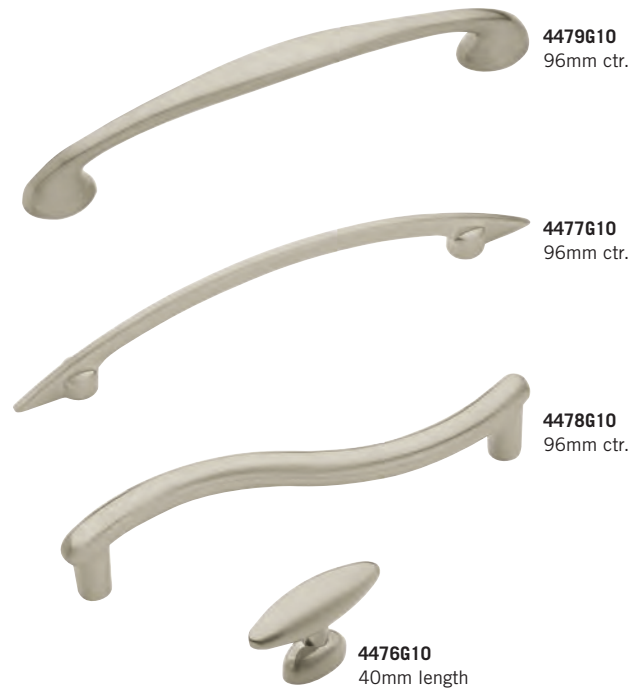

4479G10
96mm ctr.

4477G10
96mm ctr.

4478G10
96mm ctr.

4476G10
40mm length

EVOLUTIONS™

Available Finish



PWT

A full finish index is located on pages 8-11.

Product Number	Type of Hardware
4422PWT <i>(shown)</i>	Pull – 3"
4423PWT <i>(shown)</i>	T-Knob – 1 1/4"
4420PWT <i>(shown)</i>	Pull – 3"
4421PWT <i>(shown)</i>	Knob – 1 1/4"

Pack type information can be located in the Product Index that begins on page 213.



4422PWT
3" ctr.

4423PWT
1 1/4" length

4420PWT
3" ctr.

4421PWT
1 1/4" dia.

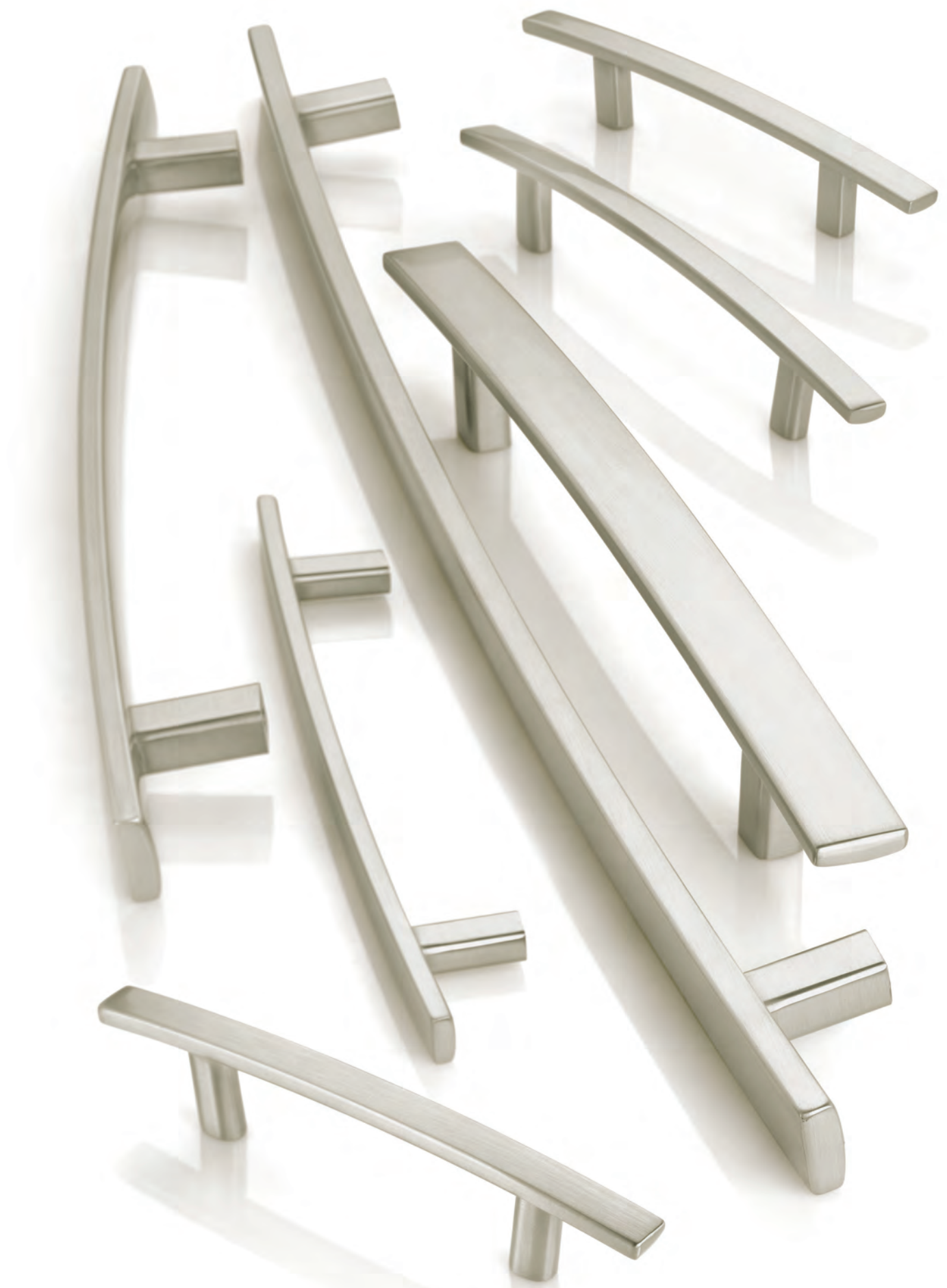



INSPIRED COORDINATING COLLECTIONS

Classic yet fashion-forward designs in today's most desired finishes provide an updated touch and coordinate easily throughout the traditional home.

Featured Here:
 Mulholland Decorative Hardware in Gilded Bronze and Pilltop Hook in Gilded Bronze.



TRADITIONAL

Elegantly designed with an inviting blend of sophisticated lines, soft curves and warm tones, traditional style is a timeless classic.

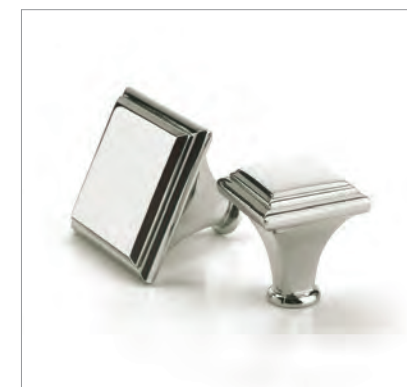

ATHERLY

Available Finishes

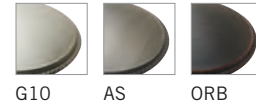

A full finish index is located on pages 8-11.

Product Number	Type of Hardware
29303G10	Pull – 128mm
29295G10	Pull – 96mm
29289G10	Pull – 3"
29304G10*	Oversized Oval Knob* – 1 7/8"
29280G10	Oval Knob – 1 1/2"
29305G10*	Oversized Round Knob* – 1 1/2"
29310G10	Knob – 1 3/16"
29303AS (shown)	Pull – 128mm
29295AS (shown)	Pull – 96mm
29289AS (shown)	Pull – 3"
29304AS* (shown)	Oversized Oval Knob* – 1 7/8"
29280AS (shown)	Oval Knob – 1 1/2"
29305AS* (shown)	Oversized Round Knob* – 1 1/2"
29310AS (shown)	Knob – 1 3/16"
29303ORB	Pull – 128mm
29295ORB	Pull – 96mm
29289ORB	Pull – 3"
29304ORB*	Oversized Oval Knob* – 1 7/8"
29280ORB	Oval Knob – 1 1/2"
29305ORB*	Oversized Round Knob* – 1 1/2"
29310ORB	Knob – 1 3/16"

*Image can be located in Oversized section that begins on page 92.
Pack type information can be located in the Product Index that begins on page 213.



MULHOLLAND™

Available Finishes

Finishes may not be available in all styles.



A full finish index is located on pages 8-11.

Product Number	Type of Hardware
53533G10*	Oversized Pull* – 18"
53532G10*	Oversized Pull* – 12"
53531G10*	Oversized Pull* – 8"
53530G10	Pull – 160mm
53529G10	Pull – 128mm
53031G10	Pull – 96mm
53030G10	Pull – 3"
535342G10*	Oversized T-Knob* – 1 1/2"
53029G10	T-Knob – 1 1/4"
53533GB*	Oversized Pull* – 18"
53532GB*	Oversized Pull* – 12"
53531GB*	Oversized Pull* – 8"
53530GB (shown)	Pull – 160mm
53529GB (shown)	Pull – 128mm
53031GB (shown)	Pull – 96mm
53030GB (shown)	Pull – 3"
535342GB* (shown)	Oversized T-Knob* – 1 1/2"
53029GB (shown)	T-Knob – 1 1/4"
53031R3	Pull – 96mm
53030R3	Pull – 3"
53029R3	T-Knob – 1 1/4"
53031ART	Pull – 96mm
53030ART	Pull – 3"
53029ART	T-Knob – 1 1/4"
53533ORB*	Oversized Pull* – 18"
53532ORB*	Oversized Pull* – 12"
53531ORB*	Oversized Pull* – 8"
53530ORB	Pull – 160mm
53529ORB	Pull – 128mm
53031ORB	Pull – 96mm
53030ORB	Pull – 3"
535342ORB*	Oversized T-Knob* – 1 1/2"
53029ORB	T-Knob – 1 1/4"

*Image can be located in Oversized section that begins on page 92.
Pack type information can be located in the Product Index that begins on page 213.

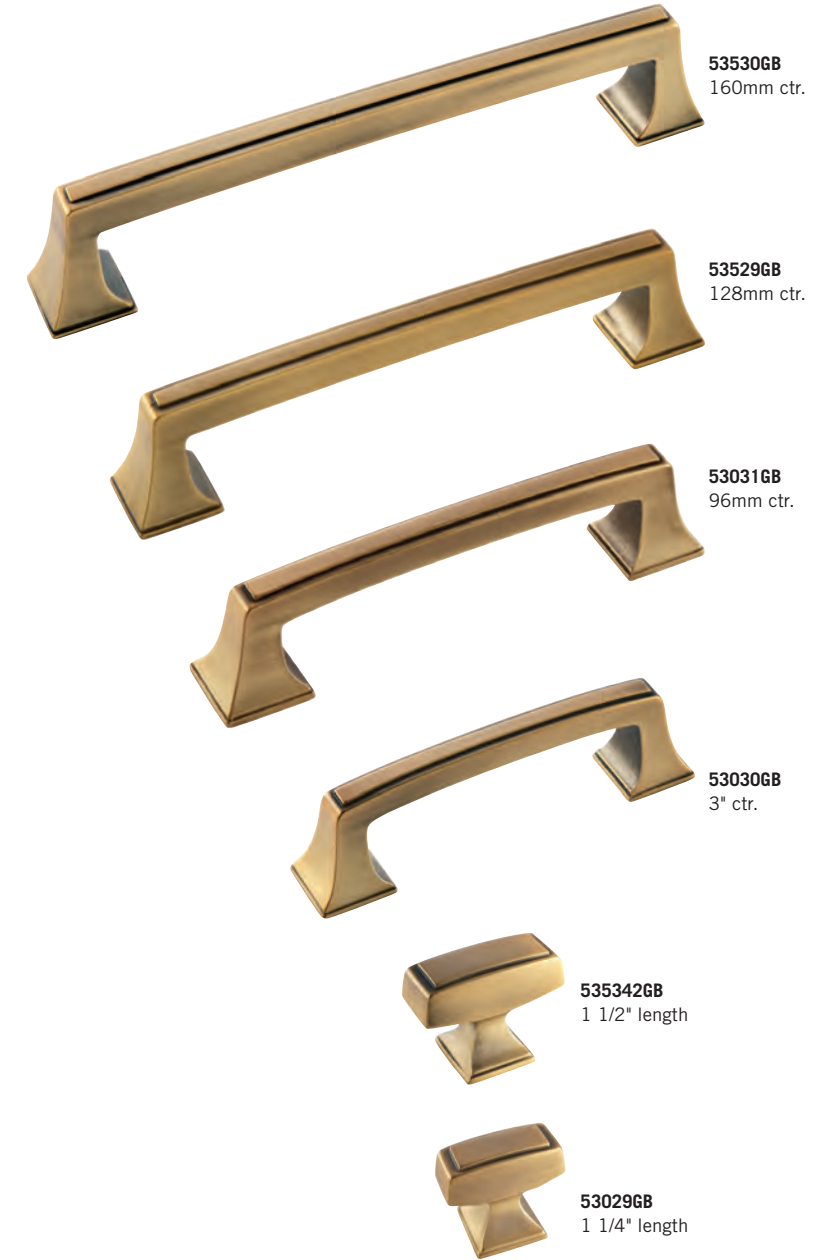

REVITALIZE

Available Finishes



G10 GB ORB

A full finish index is located on pages 8-11.

Product Number	Type of Hardware
55350G10*	Oversized Pull* – 18"
55349G10*	Oversized Pull* – 12"
55348G10*	Oversized Pull* – 8"
55347G10	Pull – 160mm
55346G10	Pull – 128mm
55344G10	Pull – 96mm
55343G10	Pull – 3"
55342G10	Knob – 1 1/4"
55341G10	Knob – 1 1/4"
55340G10	Rectangular Knob – 1 1/4"
55350GB*	Oversized Pull* – 18"
55349GB*	Oversized Pull* – 12"
55348GB*	Oversized Pull* – 8"
55347GB (shown)	Pull – 160mm
55346GB (shown)	Pull – 128mm
55344GB (shown)	Pull – 96mm
55343GB (shown)	Pull – 3"
55342GB (shown)	Knob – 1 1/4"
55341GB (shown)	Knob – 1 1/4"
55340GB (shown)	Rectangular Knob – 1 1/4"
55350ORB*	Oversized Pull* – 18"
55349ORB*	Oversized Pull* – 12"
55348ORB*	Oversized Pull* – 8"
55347ORB	Pull – 160mm
55346ORB	Pull – 128mm
55344ORB	Pull – 96mm
55343ORB	Pull – 3"
55342ORB	Knob – 1 1/4"
55341ORB	Knob – 1 1/4"
55340ORB	Rectangular Knob – 1 1/4"

*Image can be located in Oversized section that begins on page 92.
Pack type information can be located in the Product Index that begins on page 213.



LATTICE™

Available Finishes

Finishes may not be available in all styles.



SN WNC DBS RB DOB

A full finish index is located on pages 8-11.

Product Number	Type of Hardware
55426SN*	Oversized Pull* – 18"
55425SN*	Oversized Pull* – 12"
55424SN*	Oversized Pull* – 8"
55423SN	Pull – 160mm
55422SN	Pull – 128mm
24235SN	Pull – 96mm
55421SN	Pull – 3"
554202SN*	Oversized Knob* – 1 11/16"
24234SN	Knob – 1 5/16"
24235WNC	Pull – 96mm
24234WNC	Knob – 1 5/16"
55426DBS*	Oversized Pull* – 18"
55425DBS*	Oversized Pull* – 12"
55424DBS*	Oversized Pull* – 8"
55423DBS	Pull – 160mm
55422DBS	Pull – 128mm
24235DBS	Pull – 96mm
55421DBS	Pull – 3"
554202DBS*	Oversized Knob* – 1 11/16"
24234DBS	Knob – 1 5/16"
55426RB*	Oversized Pull* – 18"
55425RB*	Oversized Pull* – 12"
55424RB*	Oversized Pull* – 8"
55423RB	Pull – 160mm
55422RB	Pull – 128mm
24235RB	Pull – 96mm
55421RB	Pull – 3"
554202RB*	Oversized Knob* – 1 11/16"
24234RB	Knob – 1 5/16"
55426DOB*	Oversized Pull* – 18"
55425DOB*	Oversized Pull* – 12"
55424DOB*	Oversized Pull* – 8"
55423DOB (shown)	Pull – 160mm
55422DOB (shown)	Pull – 128mm
24235DOB (shown)	Pull – 96mm
55421DOB (shown)	Pull – 3"
554202DOB* (shown)	Oversized Knob* – 1 11/16"
24234DOB (shown)	Knob – 1 5/16"

*Image can be located in Oversized section that begins on page 92.
Pack type information can be located in the Product Index that begins on page 213.



MULHOLLAND™

Available Finishes

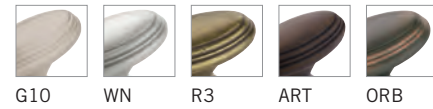

A full finish index is located on pages 8-11.

Product Number	Type of Hardware
53034G10	Pull – 96mm
53033G10	Pull – 3"
53032G10	T-Knob – 1 7/16"
53034WN	Pull – 96mm
53033WN	Pull – 3"
53032WN	T-Knob – 1 7/16"
53034R3	Pull – 96mm
53033R3	Pull – 3"
53032R3	T-Knob – 1 7/16"
53034ART	Pull – 96mm
53033ART	Pull – 3"
53032ART	T-Knob – 1 7/16"
53034ORB (shown)	Pull – 96mm
53033ORB (shown)	Pull – 3"
53032ORB (shown)	T-Knob – 1 7/16"

Pack type information can be located in the Product Index that begins on page 213.



OPULENCE

Available Finishes



A full finish index is located on pages 8-11.

Product Number	Type of Hardware
2613226	Pull – 3"
2613326	Knob – 1 3/8"
26132G10	Pull – 3"
26133G10	Knob – 1 3/8"
26132WN (shown)	Pull – 3"
26133WN (shown)	Knob – 1 3/8"
26132EB	Pull – 3"
26133EB	Knob – 1 3/8"
26132ORB	Pull – 3"
26133ORB	Knob – 1 3/8"

Pack type information can be located in the Product Index that begins on page 213.



ADVANTAGE | SOLID BRASS

Available Finishes

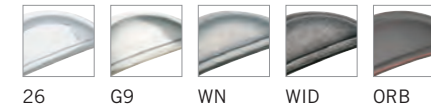

A full finish index is located on pages 8-11.

Product Number	Type of Hardware
423526	Cup Pull – 3"
4235G9	Cup Pull – 3"
4235WN	Cup Pull – 3"
4235WID	Cup Pull – 3"
4235ORB (shown)	Cup Pull – 3"

Pack type information can be located in the Product Index that begins on page 213.

Available Finish



NBZ

A full finish index is located on pages 8-11.

Product Number	Type of Hardware
1957NBZ (shown)	Pull – 3"

Pack type information can be located in the Product Index that begins on page 213.



Available Finishes

Finishes may not be available in all styles.

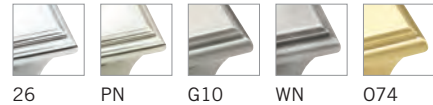

ORB

A full finish index is located on pages 8-11.

Product Number	Type of Hardware
2613026	Cup Pull – 3"
2613126	Square Knob – 1"
26138PN (shown)	Cup Pull – 128mm
26137PN (shown)	Cup Pull – 96mm
26130PN (shown)	Cup Pull – 3"
261392PN* (shown)	Oversized Knob* – 1 3/7"
26131PN (shown)	Square Knob – 1"
26138G10	Cup Pull – 128mm
26137G10	Cup Pull – 96mm
26130G10	Cup Pull – 3"
261392G10*	Oversized Knob* – 1 3/7"
26131G10	Square Knob – 1"
26130WN	Cup Pull – 3"
26131WN	Square Knob – 1"
26130074	Cup Pull – 3"
26131074	Square Knob – 1"
26138ORB	Cup Pull – 128mm
26137ORB	Cup Pull – 96mm
26130ORB	Cup Pull – 3"
261392ORB*	Oversized Knob* – 1 3/7"
26131ORB	Square Knob – 1"

*Image can be located in Oversized section that begins on page 92.

Pack type information can be located in the Product Index that begins on page 213.



261392PN
1 3/7" length



26131PN
1" length

Available Finishes

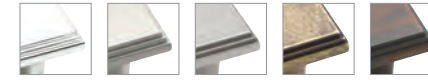

26 G10 WN R2 ORB

A full finish index is located on pages 8-11.

Product Number	Type of Hardware
2611626 (shown)	Pull – 3"
2611726 (shown)	Knob – 1"
26116G10	Pull – 3"
26117G10	Knob – 1"
26116WN	Pull – 3"
26117WN	Knob – 1"
26116R2	Pull – 3"
26117R2	Knob – 1"
26116ORB	Pull – 3"
26117ORB	Knob – 1"

Pack type information can be located in the Product Index that begins on page 213.

Available Finishes

Finishes may not be available in all styles.

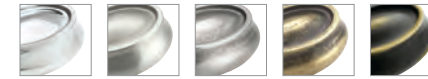

26 G10 WN R2 RB



ORB

A full finish index is located on pages 8-11.

Product Number	Type of Hardware
2612626	Pull – 3"
2612726	Knob – 1 1/2"
26126G10 (shown)	Pull – 3"
261272G10* (shown)	Oversized Knob* – 2"
26127G10 (shown)	Knob – 1 1/2"
26126WN	Pull – 3"
26127WN	Knob – 1 1/2"
26126R2	Pull – 3"
26127R2	Knob – 1 1/2"
261272RB*	Oversized Knob* – 2"
26127RB	Knob – 1 1/2"
26126ORB	Pull – 3"
261272ORB*	Oversized Knob* – 2"
26127ORB	Knob – 1 1/2"

*Image can be located in Oversized section that begins on page 92.

Pack type information can be located in the Product Index that begins on page 213.



2611626
3" ctr.



2611726
1" length



26126G10
3" ctr.



261272G10
2" length



26127G10
1 1/2" length

BRASS AND STERLING TRADITIONS

Available Finishes

Finishes may not be available in all styles.

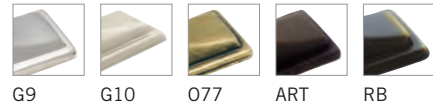

G9 G10 O77 ART RB



ORB

A full finish index is located on pages 8-11.

Product Number	Type of Hardware
54004G9*	Oversized Pull* – 8"
1302G9	Pull – 3"
1316G10*	Oversized Pull* – 18"
1315G10*	Oversized Pull* – 12"
54004G10*	Oversized Pull* – 8"
1314G10	Pull – 160mm
1313G10	Pull – 128mm
1312G10	Pull – 96mm
1302G10	Pull – 3"
54004077*	Oversized Pull* – 8"
1302077	Pull – 3"
1302ART	Pull – 3"
1316RB*	Oversized Pull* – 18"
1315RB*	Oversized Pull* – 12"
54004RB*	Oversized Pull* – 8"
1314RB (shown)	Pull – 160mm
1313RB (shown)	Pull – 128mm
1312RB (shown)	Pull – 96mm
1302RB (shown)	Pull – 3"
1316ORB*	Oversized Pull* – 18"
1315ORB*	Oversized Pull* – 12"
54004ORB*	Oversized Pull* – 8"
1314ORB	Pull – 160mm
1313ORB	Pull – 128mm
1312ORB	Pull – 96mm
1302ORB	Pull – 3"

*Image can be located in Oversized section that begins on page 92.

Pack type information can be located in the Product Index that begins on page 213.



1314RB
160mm ctr.

1313RB
128mm ctr.

1312RB
96mm ctr.

1302RB
3" ctr.

BRASS AND STERLING TRADITIONS

Available Finishes



G9 O77 ART RB ORB

A full finish index is located on pages 8-11.

Product Number	Type of Hardware
1300G9	Pull – 3"
1300077	Pull – 3"
1300ART	Pull – 3"
1300RB (shown)	Pull – 3"
1300ORB	Pull – 3"

Pack type information can be located in the Product Index that begins on page 213.

Available Finishes



G9 O77 ART ORB

A full finish index is located on pages 8-11.

Product Number	Type of Hardware
1307G9	Knob – 1 1/4"
1307077	Knob – 1 1/4"
1307ART (shown)	Knob – 1 1/4"
1307ORB	Knob – 1 1/4"

Pack type information can be located in the Product Index that begins on page 213.

Available Finishes

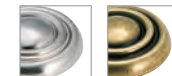

G9 O77

A full finish index is located on pages 8-11.

Product Number	Type of Hardware
1306G9	Knob – 1 3/16"
1306077 (shown)	Knob – 1 3/16"

Pack type information can be located in the Product Index that begins on page 213.



1300RB
3" ctr.



1307ART
1 1/4" dia.



1306077
1 3/16" dia.

BRASS & STERLING TRADITIONS

Available Finishes

Finishes may not be available in all styles.



G9 GB O77 ORB

A full finish index is located on pages 8-11.

Product Number	Type of Hardware
1303G9 <i>(shown)</i>	Pull – 3"
1301G9 <i>(shown)</i>	Pull – 3"
1308G9 <i>(shown)</i>	Knob – 1 1/8"
1308GB	Knob – 1 1/8"
1303O77	Pull – 3"
1301O77	Pull – 3"
1308O77	Knob – 1 1/8"
1303ORB	Pull – 3"
1301ORB	Pull – 3"
1308ORB	Knob – 1 1/8"

Pack type information can be located in the Product Index that begins on page 213.



1303G9
3" ctr.



1301G9
3" ctr.



1308G9
1 1/8" dia.

VASARI™

Available Finishes



SN AN WNC

A full finish index is located on pages 8-11.

Product Number	Type of Hardware
24005SN	Pull – 128mm
24004SN	Pull – 96mm
24003SN	Knob – 30mm
24005AN	Pull – 128mm
24004AN	Pull – 96mm
24003AN	Knob – 30mm
24005WNC <i>(shown)</i>	Pull – 128mm
24004WNC <i>(shown)</i>	Pull – 96mm
24003WNC <i>(shown)</i>	Knob – 30mm

Pack type information can be located in the Product Index that begins on page 213.

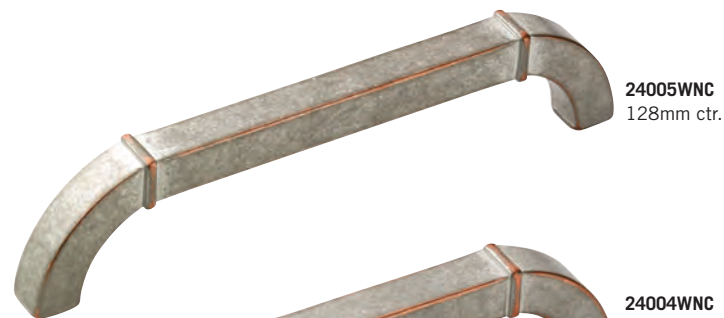

24005WNC
128mm ctr.



24004WNC
96mm ctr.



24003WNC
30mm dia.

VILLAGE CLASSICS™

Available Finishes

Finishes may not be available in all styles.



WN R2 ART RB ORB



FB

A full finish index is located on pages 8-11.

Product Number	Type of Hardware
19324WN <i>(shown)</i>	Pull – 160mm
19323WN <i>(shown)</i>	Pull – 96mm
19322WN <i>(shown)</i>	Pull – 3"
19321WN <i>(shown)</i>	T-Knob – 66mm
19320WN <i>(shown)</i>	Knob – 34mm
19324R2	Pull – 160mm
19323R2	Pull – 96mm
19322R2	Pull – 3"
19321R2	T-Knob – 66mm
19320R2	Knob – 34mm
19322ART	Pull – 3"
19321ART	T-Knob – 66mm
19322RB	Pull – 3"
19321RB	T-Knob – 66mm
19324ORB	Pull – 160mm
19323ORB	Pull – 96mm
19322ORB	Pull – 3"
19321ORB	T-Knob – 66mm
19320ORB	Knob – 34mm
19324FB	Pull – 160mm
19323FB	Pull – 96mm
19322FB	Pull – 3"
19321FB	T-Knob – 66mm
19320FB	Knob – 34mm

Pack type information can be located in the Product Index that begins on page 213.



19324WN
160mm ctr.



19323WN
96mm ctr.



19322WN
3" ctr.



19321WN
66mm length



19320WN
34mm dia.

TRADITIONAL CLASSICS

Available Finishes

Finishes may not be available in all styles.



G10 ORB CS CSG CGB



CORB CBBR CBB CG10 AORB



ABBR

A full finish index is located on pages 8-11.

Product Number	Type of Hardware
14303G10 <i>(shown)</i>	Knob – 1 1/4"
14303ORB <i>(shown)</i>	Knob – 1 1/4"
734CS <i>(shown)</i>	Knob – 1 9/16"
733CS <i>(shown)</i>	Knob – 1 3/16"
732CS <i>(shown)</i>	Knob – 1 3/8"
731CS <i>(shown)</i>	Knob – 1 3/16"
14303CSG	Knob – 1 1/4"
55268CGB	Knob – 1"
55268CORB	Knob – 1"
55268CBBR	Knob – 1"
907CBB <i>(shown)</i>	Knob – 1 3/8"
14303CBB <i>(shown)</i>	Knob – 1 1/4"
55268CG10	Knob – 1 1/4"
55266CG10 <i>(shown)</i>	Knob – 1"
55268AORB <i>(shown)</i>	Knob – 1 1/4"
55266AORB	Knob – 1"
55268ABBR	Knob – 1"

Pack type information can be located in the Product Index that begins on page 213.



14303G10
1 1/4" dia.



14303ORB
1 1/4" dia.



734CS
1 9/16" dia.



733CS
1 3/16" dia.



732CS
1 3/8" dia.



731CS
1 3/16" dia.



907CBB
1 3/8" dia.



14303CBB
1 1/4" dia.



55268AORB
1 1/4" dia.



55266CG10
1" dia.

TRADITIONAL CLASSICS

Available Finishes

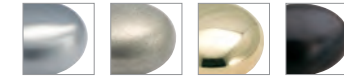

G10 WN 3 ORB

A full finish index is located on pages 8-11.

Product Number	Type of Hardware
772G10	Knob – 1 1/2"
772WN <i>(shown)</i>	Knob – 1 1/2"
7723	Knob – 1 1/2"
772ORB	Knob – 1 1/2"

Pack type information can be located in the Product Index that begins on page 213.



772WN
1 1/2" dia.

Available Finishes



G10 WN 3 AE RBZ

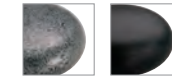

WI ORB

A full finish index is located on pages 8-11.

Product Number	Type of Hardware
771G10 <i>(shown)</i>	Knob – 1 1/4"
771WN	Knob – 1 1/4"
7713	Knob – 1 1/4"
771AE	Knob – 1 1/4"
771RBZ	Knob – 1 1/4"
771WI	Knob – 1 1/4"
771ORB	Knob – 1 1/4"

Pack type information can be located in the Product Index that begins on page 213.



771G10
1 1/4" dia.

THE ANNIVERSARY COLLECTION™

Available Finishes

Finishes may not be available in all styles.



A full finish index is located on pages 8-11.

Product Number	Type of Hardware
854G9 <i>(shown)</i>	Pull – 3"
884G9 <i>(shown)</i>	Pull – 3"
874G9 <i>(shown)</i>	Pull – 3"
874074	Pull – 3"
854ORB	Pull – 3"
874PWT	Pull – 3"
854BN	Pull – 3"
874BN	Pull – 3"

Pack type information can be located in the Product Index that begins on page 213.

Available Finishes

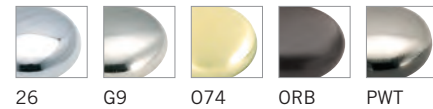

BN

A full finish index is located on pages 8-11.

Product Number	Type of Hardware
85326	Knob – 1 3/16"
853G9 <i>(shown)</i>	Knob – 1 3/16"
853074	Knob – 1 3/16"
853ORB	Knob – 1 3/16"
853PWT	Knob – 1 3/16"
853BN	Knob – 1 3/16"

Pack type information can be located in the Product Index that begins on page 213.



854G9
3" ctr.



884G9
3" ctr.



874G9
3" ctr.



853G9
1 3/16" dia.

HINT OF HERITAGE®

Available Finishes

Finishes may not be available in all styles.

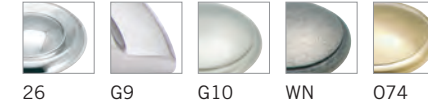

26 G9 G10 WN O74

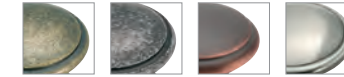

R2 WID ORB PWT

A full finish index is located on pages 8-11.

Product Number	Type of Hardware
138626 <i>(shown)</i>	Knob – 1 1/4"
2378G9	Pull – 3"
14662G10* <i>(shown)</i>	Oversized Knob* – 1 3/4"
1466G10	Knob – 1 1/4"
1466WN	Knob – 1 1/4"
2378074	Pull – 3"
1466R2	Knob – 1 1/4"
1466WID	Knob – 1 1/4"
1466ORB	Knob – 1 1/4"
2378PWT <i>(shown)</i>	Pull – 3"
2377PWT <i>(shown)</i>	Pull – 3"
2370PWT <i>(shown)</i>	Knob – 1 1/4"
1466PWT <i>(shown)</i>	Knob – 1 1/4"

*Image can be located in Oversized section that begins on page 92.

Pack type information can be located in the Product Index that begins on page 213.



2378PWT
3" ctr.



2377PWT
3" ctr.



2370PWT
1 1/4" dia.



1466PWT
1 1/4" dia.



14662G10
1 3/4" dia.



138626
1 1/4" dia.

EXPRESSIONS™

Available Finishes

Finishes may not be available in all styles.

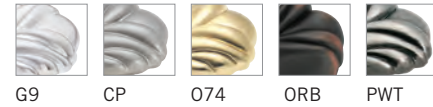

A full finish index is located on pages 8-11.

Product Number	Type of Hardware
1471G9	Pull – 3"
1475G9	Knob – 1 3/8"
1471CP	Pull – 3"
1475CP	Knob – 1 3/8"
1471O74	Pull – 3"
1470O74	Pull – 3"
1475O74	Knob – 1 3/8"
1471ORB	Pull – 3"
1471PWT (shown)	Pull – 3"
1470PWT (shown)	Pull – 3"
1475PWT (shown)	Knob – 1 3/8"
1474PWT (shown)	T-Knob – 1 1/2"

Pack type information can be located in the Product Index that begins on page 213.



1471PWT
3" ctr.



1470PWT
3" ctr.



1475PWT
1 3/8" dia.



1474PWT
1 1/2" length

PATTERNS

Available Finish



G10

A full finish index is located on pages 8-11.

Product Number	Type of Hardware
26121G10 (shown)	Knob – 1 3/8"

Pack type information can be located in the Product Index that begins on page 213.



26121G10
1 3/8" dia.

DESIGN DETAILS™

Available Finish



PWT

A full finish index is located on pages 8-11.

Product Number	Type of Hardware
1820PWT (shown)	Pull – 3"
1821PWT (shown)	Knob – 1 3/8"

Pack type information can be located in the Product Index that begins on page 213.



1820PWT
3" ctr.



1821PWT
1 3/8" dia.

Available Finish



PWT

A full finish index is located on pages 8-11.

Product Number	Type of Hardware
1824PWT (shown)	Pull – 3"
1825PWT (shown)	Square Knob – 1 1/4"

Pack type information can be located in the Product Index that begins on page 213.



1824PWT
3" ctr.

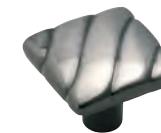

1825PWT
1 1/4" length

REFLECTIONS™

Available Finishes

Finishes may not be available in all styles.



26 G9 G10 AS 3



GB R1 RB RBZ ART



ORB

A full finish index is located on pages 8-11.

Product Number	Type of Hardware
138426	Pull – 3"
138726	Knob – 1 1/4"
1384G9	Pull – 3"
1387G9	Knob – 1 1/4"
1387G10	Knob – 1 1/4"
1387AS	Knob – 1 1/4"
13833 <i>(shown)</i>	Pull – 3"
13843 <i>(shown)</i>	Pull – 3"
13873 <i>(shown)</i>	Knob – 1 1/4"
1387GB	Knob – 1 1/4"
1384R1	Pull – 3"
1387R1	Knob – 1 1/4"
1387RB	Knob – 1 1/4"
1387RBZ	Knob – 1 1/4"
1387ART	Knob – 1 1/4"
1387ORB	Knob – 1 1/4"

Pack type information can be located in the Product Index that begins on page 213.



13833
3" ctr.



13843
3" ctr.



13873
1 1/4" dia.

TRUE ELEGANCE™

Available Finishes



074 077

A full finish index is located on pages 8-11.

Product Number	Type of Hardware
1350074	Pull – 3"
1354074	Knob – 1 1/4"
1350077 <i>(shown)</i>	Pull – 3"
1354077 <i>(shown)</i>	Knob – 1 1/4"

Pack type information can be located in the Product Index that begins on page 213.

Available Finishes



074 077

A full finish index is located on pages 8-11.

Product Number	Type of Hardware
1352074	Pull – 3"
1356074	Knob – 1 1/4"
1352077 <i>(shown)</i>	Pull – 3"
1356077 <i>(shown)</i>	Knob – 1 1/4"

Pack type information can be located in the Product Index that begins on page 213.



1350077
3" ctr.



1354077
1 1/4" dia.



1352077
3" ctr.



1356077
1 1/4" dia.

RADIANCE™

Available Finishes

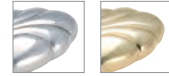

26 3

A full finish index is located on pages 8-11.

Product Number	Type of Hardware
----------------	------------------

139426 <i>(shown)</i>	Pull – 3"
139626 <i>(shown)</i>	T-Knob – 1 1/2"

13943	Pull – 3"
13963	T-Knob – 1 1/2"

Pack type information can be located in the Product Index that begins on page 213.

Available Finish



R1

A full finish index is located on pages 8-11.

Product Number	Type of Hardware
----------------	------------------

1395R1 <i>(shown)</i>	Pull – 3"
1397R1 <i>(shown)</i>	Knob – 1 1/4"

Pack type information can be located in the Product Index that begins on page 213.

RUSTIC FINISHES

Available Finish



R1

A full finish index is located on pages 8-11.

Product Number	Type of Hardware
----------------	------------------

76295R1 <i>(shown)</i>	Pull – 3"
-------------------------------	------------------

Pack type information can be located in the Product Index that begins on page 213.



139426
3" ctr.



139626
1 1/2" length



1395R1
3" ctr.



1397R1
1 1/4" dia.



76295R1
3" ctr.

BACKPLATES

Available Finishes

Finishes may not be available in all styles.

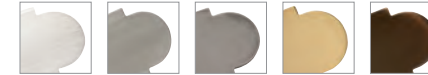

G10 AS WN GB CBZ



ORB WID

A full finish index is located on pages 8-11.

Product Number	Type of Hardware
----------------	------------------

19207G10	Knob Backplate
19208G10	3" Pull Backplate

19207AS <i>(shown)</i>	Knob Backplate
19208AS <i>(shown)</i>	3" Pull Backplate

19208WN	3" Pull Backplate
---------	-------------------

19207GB	Knob Backplate
19208GB	3" Pull Backplate

19207CBZ	Knob Backplate
19208CBZ	3" Pull Backplate

19207ORB	Knob Backplate
19208ORB	3" Pull Backplate

19207WID	Knob Backplate
19208WID	3" Pull Backplate

Pack type information can be located in the Product Index that begins on page 213.

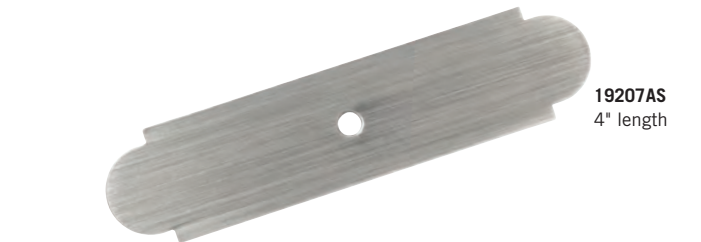

19207AS
4" length



19208AS
3" ctr.

Available Finishes



G10 WN R2 ORB WID

A full finish index is located on pages 8-11.

Product Number	Type of Hardware
----------------	------------------

19206G10	Backplate – 4 3/8"
----------	--------------------

19206WN	Backplate – 4 3/8"
---------	--------------------

19206R2	Backplate – 4 3/8"
---------	--------------------

19206ORB	Backplate – 4 3/8"
----------	--------------------

19206WID <i>(shown)</i>	Backplate – 4 3/8"
--------------------------------	---------------------------

Pack type information can be located in the Product Index that begins on page 213.



19206WID
4 3/8" length

BACKPLATES

Available Finishes



G9 G10 ORB

A full finish index is located on pages 8-11.

Product Number	Type of Hardware
----------------	------------------

875G9	Backplate – 3"
-------	----------------

875G10 <i>(shown)</i>	Backplate – 3"
------------------------------	-----------------------

875ORB	Backplate – 3"
--------	----------------

Pack type information can be located in the Product Index that begins on page 213.

Available Finish



G9

A full finish index is located on pages 8-11.

Product Number	Type of Hardware
----------------	------------------

885G9 <i>(shown)</i>	Backplate – 3 5/8"
-----------------------------	---------------------------

Pack type information can be located in the Product Index that begins on page 213.

Available Finish



G10

A full finish index is located on pages 8-11.

Product Number	Type of Hardware
----------------	------------------

1971G10 <i>(shown)</i>	Backplate – 96mm
-------------------------------	-------------------------

Pack type information can be located in the Product Index that begins on page 213.



875G10
3" ctr.



885G9
3 5/8" length



1971G10
96mm ctr.

BACKPLATES

Available Finishes



26 3 BB

A full finish index is located on pages 8-11.

Product Number	Type of Hardware
----------------	------------------

7624726 <i>(shown)</i>	Backplate – 3"
-------------------------------	-----------------------

762473	Backplate – 3"
--------	----------------

76247BB	Backplate – 3"
---------	----------------

Pack type information can be located in the Product Index that begins on page 213.

Available Finishes



G9 O77

A full finish index is located on pages 8-11.

Product Number	Type of Hardware
----------------	------------------

1304G9 <i>(shown)</i>	Backplate – 4 5/16"
------------------------------	----------------------------

1304O77	Backplate – 4 5/16"
---------	---------------------

Pack type information can be located in the Product Index that begins on page 213.



7624726
3" ctr.



1304G9
4 5/16" length



INSPIRED COORDINATING COLLECTIONS

With over 160 finishes, you can personalize your space with a distinctive, finishing touch that reflects your own unique style.

Featured Here:
Abernathy Decorative Cabinet Hardware in Antique Silver and Clarendon Bath Hardware in Antique Silver.



ECLECTIC

Celebrating a harmonious blend of different eras and styles, eclectic design reflects the sentiment that anything goes as long as it goes together.

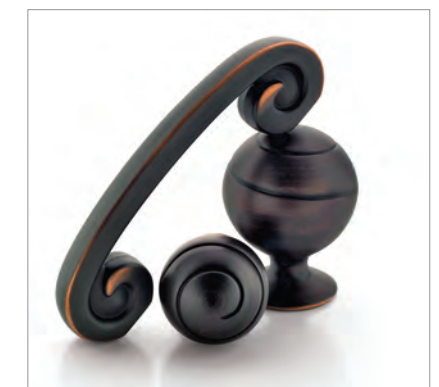

Available Finishes



CG10 CAS CORB

A full finish index is located on pages 8-11.

Product Number	Type of Hardware
29460CG10 <i>(shown)</i>	Square Knob – 1"
29460CAS <i>(shown)</i>	Square Knob – 1"
29460CORB <i>(shown)</i>	Square Knob – 1"

Pack type information can be located in the Product Index that begins on page 213.



29460CG10
1" length



29460CAS
1" length

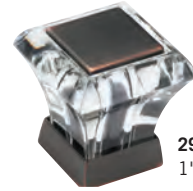

29460CORB
1" length

Available Finishes



G10 ORB BBR

A full finish index is located on pages 8-11.

Product Number	Type of Hardware
55281G10*	Oversized Pull* – 18"
55280G10*	Oversized Pull* – 12"
55279G10*	Oversized Pull* – 8"
55278G10	Pull – 160mm
55277G10	Pull – 128mm
55276G10	Pull – 96mm
55275G10	Pull – 3"
55274G10	Pendant – 1 13/16"
55273G10*	Oversized Square Knob* – 1 1/2"
55271G10	Square Knob – 1 3/16"
55272G10*	Oversized Knob* – 1 3/4"
55270G10	Knob – 1 5/16"
55281ORB*	Oversized Pull* – 18"
55280ORB*	Oversized Pull* – 12"
55279ORB*	Oversized Pull* – 8"
55278ORB	Pull – 160mm
55277ORB	Pull – 128mm
55276ORB	Pull – 96mm
55275ORB	Pull – 3"
55274ORB	Pendant – 1 13/16"
55273ORB*	Oversized Square Knob* – 1 1/2"
55271ORB	Square Knob – 1 3/16"
55272ORB*	Oversized Knob* – 1 3/4"
55270ORB	Knob – 1 5/16"
55281BBR*	Oversized Pull* – 18"
55280BBR*	Oversized Pull* – 12"
55279BBR*	Oversized Pull* – 8"
55278BBR <i>(shown)</i>	Pull – 160mm
55277BBR <i>(shown)</i>	Pull – 128mm
55276BBR <i>(shown)</i>	Pull – 96mm
55275BBR <i>(shown)</i>	Pull – 3"
55274BBR <i>(shown)</i>	Pendant – 1 13/16"
55273BBR* <i>(shown)</i>	Oversized Square Knob* – 1 1/2"
55271BBR <i>(shown)</i>	Square Knob – 1 3/16"
55272BBR* <i>(shown)</i>	Oversized Knob* – 1 3/4"
55270BBR <i>(shown)</i>	Knob – 1 5/16"

*Image can be located in Oversized section that begins on page 92.
Pack type information can be located in the Product Index that begins on page 213.



55278BBR
160mm ctr.

55277BBR
128mm ctr.

55276BBR
96mm ctr.

55275BBR
3" ctr.

55274BBR
1 13/16" length

55273BBR
1 1/2" length

55271BBR
1 3/16" length

55272BBR
1 3/4" dia.

55270BBR
1 5/16" dia.

SWIRL'Z®

Available Finishes

Finishes may not be available in all styles.



G10 WN WID ORB FB

A full finish index is located on pages 8-11.

Product Number	Type of Hardware
19260G10	Pull – 128mm
9337G10	Pull – 3"
9339G10	Knob – 1 1/8"
93382G10*	Oversized Knob* – 1 3/4"
9338G10	Knob – 1 1/8"
19260WN	Pull – 128mm
9337WN	Pull – 3"
9339WN	Knob – 1 1/8"
9338WN	Knob – 1 1/8"
19260WID	Pull – 128mm
9337WID	Pull – 3"
9339WID	Knob – 1 1/8"
9338WID	Knob – 1 1/8"
19260ORB (shown)	Pull – 128mm
9337ORB (shown)	Pull – 3"
9339ORB (shown)	Knob – 1 1/8"
93382ORB* (shown)	Oversized Knob* – 1 3/4"
9338ORB (shown)	Knob – 1 1/8"
9337FB	Pull – 3"
9339FB	Knob – 1 1/8"
9338FB	Knob – 1 1/8"

*Image can be located in Oversized section that begins on page 92.
Pack type information can be located in the Product Index that begins on page 213.

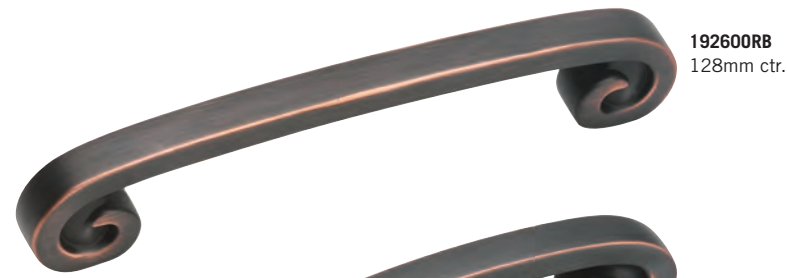

19260ORB
128mm ctr.



9337ORB
3" ctr.



9339ORB
1 1/8" length



93382ORB
1 3/4" dia.



9338ORB
1 1/8" dia.

INSPIRATIONS™

Available Finishes

Finishes may not be available in all styles.



G10 WN EB R2 ORB



WID

A full finish index is located on pages 8-11.

Product Number	Type of Hardware
1580G10	Pull – 3"
15812G10*	Oversized Knob* – 1 3/4"
1581G10	Knob – 1 1/4"
1580WN (shown)	Pull – 3"
4443WN (shown)	Pull – 3"
1582WN (shown)	Cup Pull – 3"
1583WN (shown)	Finger Pull – 1 7/8"
4444WN (shown)	Knob – 1"
15812WN* (shown)	Oversized Knob* – 1 3/4"
1581WN (shown)	Knob – 1 1/4"
1580EB	Pull – 3"
4443EB	Pull – 3"
1582EB	Cup Pull – 3"
1583EB	Finger Pull – 1 7/8"
4444EB	Knob – 1"
15812EB*	Oversized Knob* – 1 3/4"
1581EB	Knob – 1 1/4"
1580R2	Pull – 3"
1582R2	Cup Pull – 3"
1583R2	Finger Pull – 1 7/8"
1581R2	Knob – 1 1/4"
1580ORB	Pull – 3"
1582ORB	Cup Pull – 3"
1583ORB	Finger Pull – 1 7/8"
15812ORB*	Oversized Knob* – 1 3/4"
1581ORB	Knob – 1 1/4"
1580WID	Pull – 3"
1582WID	Cup Pull – 3"
1583WID	Finger Pull – 1 7/8"
1581WID	Knob – 1 1/4"

*Image can be located in Oversized section that begins on page 92.
Pack type information can be located in the Product Index that begins on page 213.



1580WN
3" ctr.



4443WN
3" ctr.



1582WN
3" ctr.



1583WN
1 7/8" length



4444WN
1" length



15812WN
1 3/4" dia.



1581WN
1 1/4" dia.

PADMA™

Available Finishes

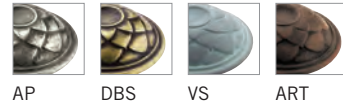

A full finish index is located on pages 8-11.

Product Number	Type of Hardware
54002AP*	Oversized Pull* – 12"
53028AP <i>(shown)</i>	Pull – 96mm
53027AP <i>(shown)</i>	Knob – 33mm
54002DBS*	Oversized Pull* – 12"
53028DBS	Pull – 96mm
53027DBS	Knob – 33mm
54002VS*	Oversized Pull* – 12"
53028VS	Pull – 96mm
53027VS	Knob – 33mm
54002ART*	Oversized Pull* – 12"
53028ART	Pull – 96mm
53027ART	Knob – 33mm

*Image can be located in Oversized section that begins on page 92.

Pack type information can be located in the Product Index that begins on page 213.



53028AP
96mm ctr.

53027AP
33mm dia.

VASARI™

Available Finishes

Finishes may not be available in all styles.



A full finish index is located on pages 8-11.

Product Number	Type of Hardware
24011SN	Pull – 96mm
24009SN	Knob – 30mm
24012SN	Pull – 96mm
24010SN	Knob – 30mm
24011AN <i>(shown)</i>	Pull – 96mm
24009AN <i>(shown)</i>	Knob – 30mm
24012AN <i>(shown)</i>	Pull – 96mm
24010AN <i>(shown)</i>	Knob – 30mm
24020AN <i>(shown)</i>	Pull – 96mm
24021AN <i>(shown)</i>	Knob – 33mm
24011WNC	Pull – 96mm
24009WNC	Knob – 30mm
24012WNC	Pull – 96mm
24010WNC	Knob – 30mm
24020WNC	Pull – 96mm
24021WNC	Knob – 33mm

Pack type information can be located in the Product Index that begins on page 213.



24011AN
96mm ctr.

24009AN
30mm dia.

24012AN
96mm ctr.

24010AN
30mm dia.

24020AN
96mm ctr.

24021AN
33mm dia.

VASARI™

Available Finishes



A full finish index is located on pages 8-11.

Product Number	Type of Hardware
24008AN	Pull – 128mm
24007AN	Pull – 96mm
24006AN	Knob – 30mm
24008WNC <i>(shown)</i>	Pull – 128mm
24007WNC <i>(shown)</i>	Pull – 96mm
24006WNC <i>(shown)</i>	Knob – 30mm

Pack type information can be located in the Product Index that begins on page 213.

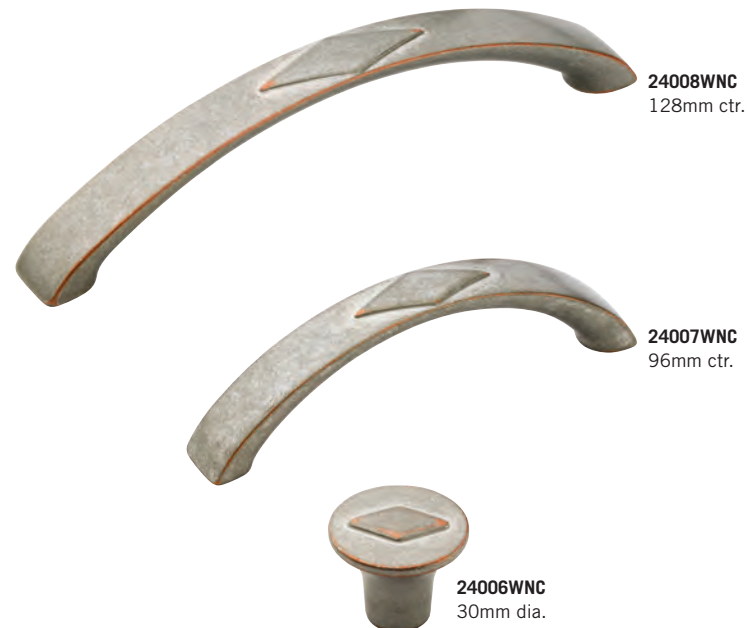

24008WNC
128mm ctr.

24007WNC
96mm ctr.

24006WNC
30mm dia.

EYDON™

Available Finishes



WN WNC ART ORB

A full finish index is located on pages 8-11.

Product Number	Type of Hardware
53037WN	Pull – 96mm
53036WN	Pull – 3"
53035WN	Knob – 1"
53037WNC <i>(shown)</i>	Pull – 96mm
53036WNC <i>(shown)</i>	Pull – 3"
53035WNC <i>(shown)</i>	Knob – 1"
53037ART	Pull – 96mm
53036ART	Pull – 3"
53035ART	Knob – 1"
53037ORB	Pull – 96mm
53036ORB	Pull – 3"
53035ORB	Knob – 1"

Pack type information can be located in the Product Index that begins on page 213.

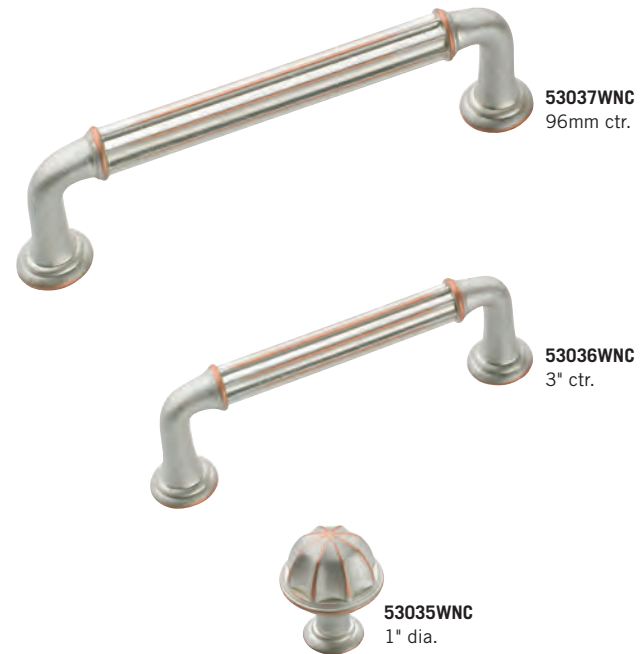

ODEON™

Available Finishes



AN WNC DBS

A full finish index is located on pages 8-11.

Product Number	Type of Hardware
53040AN	Pull – 128mm
53041AN	Knob – 34mm
53040WNC <i>(shown)</i>	Pull – 128mm
53041WNC <i>(shown)</i>	Knob – 34mm
53040DBS	Pull – 128mm
53041DBS	Knob – 34mm

Pack type information can be located in the Product Index that begins on page 213.



ANGOURI™

Available Finishes

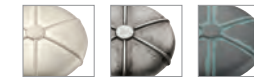

SN AP VS

A full finish index is located on pages 8-11.

Product Number	Type of Hardware
24233SN	Pull – 128mm
24232SN	Knob – 33mm
24233AP <i>(shown)</i>	Pull – 128mm
24232AP <i>(shown)</i>	Knob – 33mm
24233VS	Pull – 128mm
24232VS	Knob – 33mm

Pack type information can be located in the Product Index that begins on page 213.



SUNDARA™

Available Finishes

Finishes may not be available in all styles.



WN R2 WID ORB

A full finish index is located on pages 8-11.

Product Number	Type of Hardware
27031WN	Pull – 3"
27030WN	Knob – 1 1/4"
27031R2	Pull – 3"
27030R2	Knob – 1 1/4"
27009R2	Square Knob – 1 1/8"
27009WID	Square Knob – 1 1/8"
27031ORB <i>(shown)</i>	Pull – 3"
27030ORB <i>(shown)</i>	Knob – 1 1/4"
27009ORB <i>(shown)</i>	Square Knob – 1 1/8"

Pack type information can be located in the Product Index that begins on page 213.



CYPRUS™

Available Finish



G9

A full finish index is located on pages 8-11.

Product Number	Type of Hardware
----------------	------------------

5267G9 <i>(shown)</i>	Pull – 3"
5266G9 <i>(shown)</i>	Knob – 1 1/4"

Pack type information can be located in the Product Index that begins on page 213.

Available Finishes



G10



WN



WID

A full finish index is located on pages 8-11.

Product Number	Type of Hardware
----------------	------------------

19251G10	Pull – 3"
19250G10	Knob – 1 5/8"
19251WN	Pull – 3"
19250WN	Knob – 1 5/8"

19251WID <i>(shown)</i>	Pull – 3"
19250WID <i>(shown)</i>	Knob – 1 5/8"

Pack type information can be located in the Product Index that begins on page 213.

MARSDEN™

Available Finishes



WN



EB



ORB

A full finish index is located on pages 8-11.

Product Number	Type of Hardware
----------------	------------------

27033WN	Pull – 3"
27008WN	Square Knob – 1 1/8"
27033EB	Pull – 3"
27008EB	Square Knob – 1 1/8"

27033ORB <i>(shown)</i>	Pull – 3"
27008ORB <i>(shown)</i>	Square Knob – 1 1/8"

Pack type information can be located in the Product Index that begins on page 213.



5267G9
3" ctr.



5266G9
1 1/4" dia.



19251WID
3" ctr.



19250WID
1 5/8" length

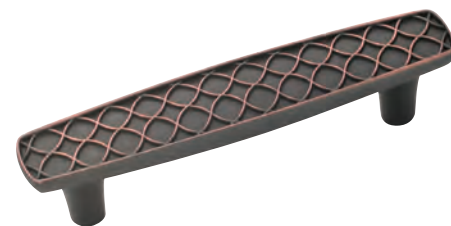

27033ORB
3" ctr.



27008ORB
1 1/8" length

VINEYARD™

Available Finishes



G10



WN



WID



PWT

A full finish index is located on pages 8-11.

Product Number	Type of Hardware
----------------	------------------

4473G10	Pull – 3"
4475G10	Square Knob – 1 1/8"

4473WN	Pull – 3"
4475WN	Square Knob – 1 1/8"

4473WID <i>(shown)</i>	Pull – 3"
4475WID <i>(shown)</i>	Square Knob – 1 1/8"

4473PWT	Pull – 3"
4475PWT	Square Knob – 1 1/8"

Pack type information can be located in the Product Index that begins on page 213.

Available Finishes



WN



EB



WID

A full finish index is located on pages 8-11.

Product Number	Type of Hardware
----------------	------------------

4465WN <i>(shown)</i>	Pull – 3"
4466WN <i>(shown)</i>	Square Knob – 1 1/8"

4465EB	Pull – 3"
4466EB	Square Knob – 1 1/8"

4465WID	Pull – 3"
4466WID	Square Knob – 1 1/8"

Pack type information can be located in the Product Index that begins on page 213.



4473WID
3" ctr.



4475WID
1 1/8" length



4465WN
3" ctr.



4466WN
1 1/8" length

Available Finishes



WN R2 RBZ WID

A full finish index is located on pages 8-11.

Product Number	Type of Hardware
4482WN	Pull – 96mm
4484WN	Knob – 1 1/4"
4482R2	Pull – 96mm
4484R2	Knob – 1 1/4"
4482RBZ	Pull – 96mm
4484RBZ	Knob – 1 1/4"
4482WID (shown)	Pull – 96mm
4484WID (shown)	Knob – 1 1/4"

Pack type information can be located in the Product Index that begins on page 213.

Available Finishes

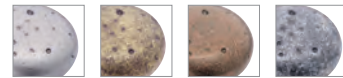

WN R2 RBZ WID

A full finish index is located on pages 8-11.

Product Number	Type of Hardware
4483WN (shown)	Pull – 96mm
4485WN (shown)	Knob – 1 1/4"
4483R2	Pull – 96mm
4485R2	Knob – 1 1/4"
4483RBZ	Pull – 96mm
4485RBZ	Knob – 1 1/4"
4483WID	Pull – 96mm
4485WID	Knob – 1 1/4"

Pack type information can be located in the Product Index that begins on page 213.



Available Finish



PWT

A full finish index is located on pages 8-11.

Product Number	Type of Hardware
4480PWT (shown)	Pull – 3"
4481PWT (shown)	Knob – 1 1/8"

Pack type information can be located in the Product Index that begins on page 213.

Available Finishes



WN PWT GPT

A full finish index is located on pages 8-11.

Product Number	Type of Hardware
4467WN	Pull – 3"
4468WN	Square Knob – 1 1/4"
4467PWT	Pull – 3"
4468PWT	Square Knob – 1 1/4"
4467GPT (shown)	Pull – 3"
4468GPT (shown)	Square Knob – 1 1/4"

Pack type information can be located in the Product Index that begins on page 213.



NATURAL ELEGANCE®

Available Finishes

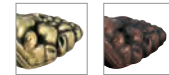

O77 RBZ

A full finish index is located on pages 8-11.

Product Number	Type of Hardware
1332077	Pull – 3"
1332RBZ (shown)	Pull – 3"

Pack type information can be located in the Product Index that begins on page 213.



1332RBZ
3" ctr.

Available Finishes



G9 O77 RBZ WI

A full finish index is located on pages 8-11.

Product Number	Type of Hardware
1330G9	Pull – 3"
1336G9	Knob – 1 11/32"
1330077	Pull – 3"
1336077	Knob – 1 11/32"
1330RBZ (shown)	Pull – 3"
1336RBZ (shown)	Knob – 1 11/32"
1330WI	Pull – 3"
1336WI	Knob – 1 11/32"

Pack type information can be located in the Product Index that begins on page 213.



1330RBZ
3" ctr.



1336RBZ
1 11/32" dia.

NATURAL ELEGANCE®

Available Finishes

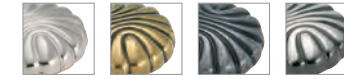

G9 O77 WI PWT

A full finish index is located on pages 8-11.

Product Number	Type of Hardware
1333G9	Pull – 3"
1337G9	Knob – 1 7/32"
1338G9	Knob – 1 9/16"
1333077	Pull – 3"
1337077	Knob – 1 7/32"
1338077	Knob – 1 9/16"
1333WI	Pull – 3"
1337WI	Knob – 1 7/32"
1338WI	Knob – 1 9/16"
1333PWT (shown)	Pull – 3"
1337PWT (shown)	Knob – 1 7/32"
1338PWT (shown)	Knob – 1 9/16"

Pack type information can be located in the Product Index that begins on page 213.

Available Finishes



G9 O77

A full finish index is located on pages 8-11.

Product Number	Type of Hardware
1334G9 (shown)	Pull – 3"
1334077	Pull – 3"

Pack type information can be located in the Product Index that begins on page 213.



1333PWT
3" ctr.



1337PWT
1 7/32" dia.



1338PWT
1 9/16" length



1334G9
3" ctr.

Available Finishes



R3 RBZ WI

A full finish index is located on pages 8-11.

Product Number	Type of Hardware
4428R3	Pull – 3"
4429R3	Square Knob – 1 1/8"
4428RBZ (shown)	Pull – 3"
4429RBZ (shown)	Square Knob – 1 1/8"
4428WI	Pull – 3"
4429WI	Square Knob – 1 1/8"

Pack type information can be located in the Product Index that begins on page 213.



4428RBZ
3" ctr.



4429RBZ
1 1/8" length

Available Finishes



G10 R3 RBZ WI ORB

A full finish index is located on pages 8-11.

Product Number	Type of Hardware
4424G10	Pull – 3"
4425G10	Knob – 1 1/4"
4424R3	Pull – 3"
4425R3	Knob – 1 1/4"
4424RBZ	Pull – 3"
4425RBZ	Knob – 1 1/4"
4424WI	Pull – 3"
4425WI	Knob – 1 1/4"
4424ORB (shown)	Pull – 3"
4425ORB (shown)	Knob – 1 1/4"

Pack type information can be located in the Product Index that begins on page 213.



4424ORB
3" ctr.



4425ORB
1 1/4" dia.

Available Finishes



WN R2 WID

A full finish index is located on pages 8-11.

Product Number	Type of Hardware
4453WN	Cup Pull – 3"
4454WN	Square Knob – 1 1/8"
4453R2 (shown)	Cup Pull – 3"
4454R2 (shown)	Square Knob – 1 1/8"
4453WID	Cup Pull – 3"
4454WID	Square Knob – 1 1/8"

Pack type information can be located in the Product Index that begins on page 213.



4453R2
3" ctr.



4454R2
1 1/8" length

Available Finishes



RBZ WI

A full finish index is located on pages 8-11.

Product Number	Type of Hardware
4426RBZ (shown)	Pull – 3"
4427RBZ (shown)	Knob – 1 1/4"
4426WI	Pull – 3"
4427WI	Knob – 1 1/4"

Pack type information can be located in the Product Index that begins on page 213.



4426RBZ
3" ctr.



4427RBZ
1 1/4" dia.

TRUE ELEGANCE®

Available Finish



WI

A full finish index is located on pages 8-11.

Product Number	Type of Hardware
----------------	------------------

1351WI <i>(shown)</i>	Pull – 3"
1355WI <i>(shown)</i>	Knob – 1 1/4"

Pack type information can be located in the Product Index that begins on page 213.



1351WI
3" ctr.



1355WI
1 1/4" dia.

NATURE'S SPLENDOR™

Available Finishes



WN R2 RBZ WID PWT

A full finish index is located on pages 8-11.

Product Number	Type of Hardware
----------------	------------------

4451WN	Pull – 3"
4452WN	Finger Pull – 1 1/2"
4451R2 <i>(shown)</i>	Pull – 3"
4452R2 <i>(shown)</i>	Finger Pull – 1 1/2"
4451RBZ	Pull – 3"
4452RBZ	Finger Pull – 1 1/2"
4451WID	Pull – 3"
4452WID	Finger Pull – 1 1/2"
4451PWT	Pull – 3"
4452PWT	Finger Pull – 1 1/2"

Pack type information can be located in the Product Index that begins on page 213.



4451R2
3" ctr.



4452R2
1 1/2" length

DIVINITY™

Available Finishes



G9 PWT

A full finish index is located on pages 8-11.

Product Number	Type of Hardware
----------------	------------------

5260G9 <i>(shown)</i>	Pull – 3"
5261G9 <i>(shown)</i>	Knob – 1 1/4"

5260 PWT	Pull – 3"
5261PWT	Knob – 1 1/4"

Pack type information can be located in the Product Index that begins on page 213.



5260G9
3" ctr.



5261G9
1 1/4" dia.

Available Finishes



G10 WN WID

A full finish index is located on pages 8-11.

Product Number	Type of Hardware
----------------	------------------

19254G10	Pull – 3"
19253G10	Pull – 3"
19252G10	Knob – 1 1/4"

19254WN <i>(shown)</i>	Pull – 3"
19253WN <i>(shown)</i>	Pull – 3"
19252WN <i>(shown)</i>	Knob – 1 1/4"

19254WID	Pull – 3"
19253WID	Pull – 3"
19252WID	Knob – 1 1/4"

Pack type information can be located in the Product Index that begins on page 213.



19254WN
3" ctr.



19253WN
3" ctr.



19252WN
1 1/4" dia.

ABSTRACTIONS™

Available Finishes



26 26D G10

A full finish index is located on pages 8-11.

Product Number	Type of Hardware
----------------	------------------

1925826	Pull – 3"
1925726	Knob – 1 1/4"

1925826D <i>(shown)</i>	Pull – 3"
1925726D <i>(shown)</i>	Knob – 1 1/4"

19258G10	Pull – 3"
19257G10	Knob – 1 1/4"

Pack type information can be located in the Product Index that begins on page 213.



1925826D
3" ctr.

1925726D
1 1/4" dia.

UTENSIL'Z®

Available Finish



G10

A full finish index is located on pages 8-11.

Product Number	Type of Hardware
----------------	------------------

9332G10 <i>(shown)</i>	Pull – 3"
9331G10 <i>(shown)</i>	Pull – 3"
9330G10 <i>(shown)</i>	Pull – 3"

Pack type information can be located in the Product Index that begins on page 213.



9332G10
3" ctr.

9331G10
3" ctr.

9330G10
3" ctr.





INSPIRED COORDINATING COLLECTIONS

Our most fashionable Decorative Cabinet Hardware and finishes offered in a complete range of sizes for seamless coordination throughout the home.

Featured Here:
Essential 'Z' Decorative Cabinet Hardware in Satin Nickel.



OVERSIZED

Our oversized collections offer sizes to fit every home with pulls up to 18" and a variety of oversized knobs.

CANDLER

Available Finishes

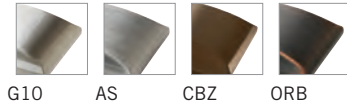

A full finish index is located on pages 8-11.

Product Number	Type of Hardware
29367G10	Oversized Pull – 18"
29366G10	Oversized Pull – 12"
29365G10	Oversized Pull – 8"
29368G10	Oversized Knob – 1 1/2"
29367AS <i>(shown)</i>	Oversized Pull – 18"
29366AS <i>(shown)</i>	Oversized Pull – 12"
29365AS <i>(shown)</i>	Oversized Pull – 8"
29368AS <i>(shown)</i>	Oversized Knob – 1 1/2"
29367CBZ	Oversized Pull – 18"
29366CBZ	Oversized Pull – 12"
29365CBZ	Oversized Pull – 8"
29368CBZ	Oversized Knob – 1 1/2"
29367ORB	Oversized Pull – 18"
29366ORB	Oversized Pull – 12"
29365ORB	Oversized Pull – 8"
29368ORB	Oversized* Knob – 1 1/2"

Additional collection images are located on page 14.
Pack type information can be located in the Product Index that begins on page 213.



EXTENSITY

Available Finishes

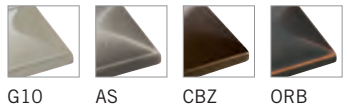

A full finish index is located on pages 8-11.

Product Number	Type of Hardware
29397G10	Oversized Pull – 18"
29396G10	Oversized Pull – 12"
29395G10	Oversized Pull – 8"
29398G10	Oversized Knob – 1 1/2"
29397AS	Oversized Pull – 18"
29396AS	Oversized Pull – 12"
29395AS	Oversized Pull – 8"
29398AS	Oversized Knob – 1 1/2"
29397CBZ <i>(shown)</i>	Oversized Pull – 18"
29396CBZ <i>(shown)</i>	Oversized Pull – 12"
29395CBZ <i>(shown)</i>	Oversized Pull – 8"
29398CBZ <i>(shown)</i>	Oversized Knob – 1 1/2"
29397ORB	Oversized Pull – 18"
29396ORB	Oversized Pull – 12"
29395ORB	Oversized Pull – 8"
29398ORB	Oversized Knob – 1 1/2"

Additional collection images are located on page 15.
Pack type information can be located in the Product Index that begins on page 213.



HIGHLAND RIDGE

Available Finishes

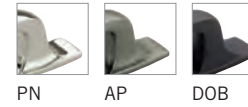

A full finish index is located on pages 8-11.

Product Number	Type of Hardware
55324PN <i>(shown)</i>	Oversized Pull – 18"
55323PN <i>(shown)</i>	Oversized Pull – 12"
55322PN <i>(shown)</i>	Oversized Pull – 8"
55324AP	Oversized Pull – 18"
55323AP	Oversized Pull – 12"
55322AP	Oversized Pull – 8"
55324DOB	Oversized Pull – 18"
55323DOB	Oversized Pull – 12"
55322DOB	Oversized Pull – 8"

Additional collection images are located on page 16.
Pack type information can be located in the Product Index that begins on page 213.



WESTERLY™

Available Finishes

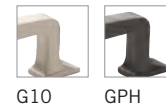

A full finish index is located on pages 8-11.

Product Number	Type of Hardware
54024G10 <i>(shown)</i>	Oversized Pull – 18"
54023G10 <i>(shown)</i>	Oversized Pull – 12"
54024GPH	Oversized Pull – 18"
54023GPH	Oversized Pull – 12"

Additional collection images are located on page 17.
Pack type information can be located in the Product Index that begins on page 213.

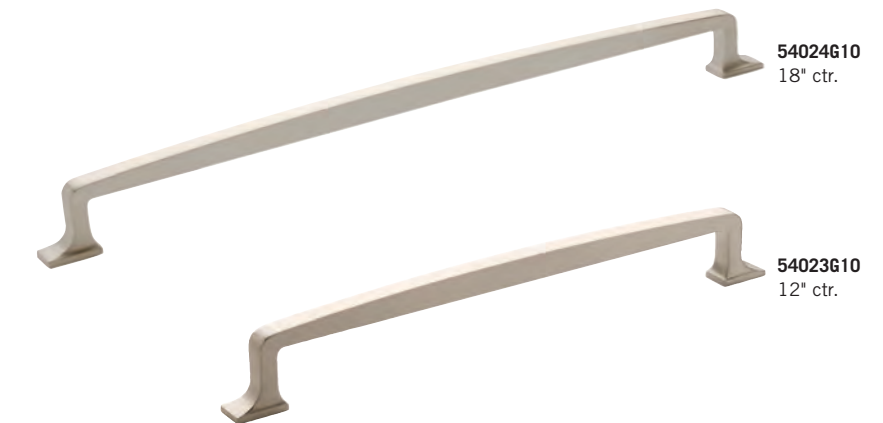

ROCHDALE™

Available Finishes



G10 GPH

A full finish index is located on pages 8-11.

Product Number	Type of Hardware
54022G10	Oversized Pull – 18"
54021G10	Oversized Pull – 12"
54022GPH (shown)	Oversized Pull – 18"
54021GPH (shown)	Oversized Pull – 12"

Additional collection images are located on page 18.
Pack type information can be located in the Product Index that begins on page 213.



KANE™

Available Finishes



G10 WN ORB

A full finish index is located on pages 8-11.

Product Number	Type of Hardware
53806G10	Oversized Pull – 18"
53805G10	Oversized Pull – 12"
53804G10	Oversized Pull – 8"
538072G10	Oversized Knob – 1 5/8"
53806WN (shown)	Oversized Pull – 18"
53805WN (shown)	Oversized Pull – 12"
53804WN (shown)	Oversized Pull – 8"
538072WN (shown)	Oversized Knob – 1 5/8"
53806ORB	Oversized Pull – 18"
53805ORB	Oversized Pull – 12"
53804ORB	Oversized Pull – 8"
538072ORB	Oversized Knob – 1 5/8"

Additional collection images are located on page 19.
Pack type information can be located in the Product Index that begins on page 213.



INSPIRATIONS™

Available Finishes

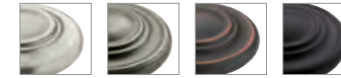

G10 WN ORB FB

A full finish index is located on pages 8-11.

Product Number	Type of Hardware
54001G10	Oversized Pull – 8"
15862G10	Oversized Knob – 1 3/4"
54001WN (shown)	Oversized Pull – 8"
15862WN (shown)	Oversized Knob – 1 3/4"
54001ORB	Oversized Pull – 8"
15862ORB	Oversized Knob – 1 3/4"
54001FB	Oversized Pull – 8"
15862FB	Oversized Knob – 1 3/4"

Additional collection images are located on page 20.
Pack type information can be located in the Product Index that begins on page 213.



Available Finishes

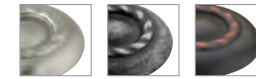

G10 WID ORB

A full finish index is located on pages 8-11.

Product Number	Type of Hardware
1788G10 (shown)	Oversized Pull – 18"
1787G10 (shown)	Oversized Pull – 12"
54000G10 (shown)	Oversized Pull – 8"
15852G10 (shown)	Oversized Knob – 1 3/4"
1788WID	Oversized Pull – 18"
1787WID	Oversized Pull – 12"
54000WID	Oversized Pull – 8"
15852WID	Oversized Knob – 1 3/4"
1788ORB	Oversized Pull – 18"
1787ORB	Oversized Pull – 12"
54000ORB	Oversized Pull – 8"
15852ORB	Oversized Knob – 1 3/4"

Additional collection images are located on page 21.
Pack type information can be located in the Product Index that begins on page 213.



POLARA™

Available Finishes



AP SBK

A full finish index is located on pages 8-11.

Product Number	Type of Hardware
54003AP	Oversized Pull – 12"
54003SBK <i>(shown)</i>	Oversized Pull – 12"

Additional collection images are located on page 25.
Pack type information can be located in the Product Index that begins on page 213.



54003SBK
12" ctr.

ESSENTIAL'Z™ BRIDGE PULLS

Available Finishes



G10 BBZ

A full finish index is located on pages 8-11.

Product Number	Type of Hardware
29426G10	Oversized Pull – 18"
29425G10	Oversized Pull – 12"
29424G10	Oversized Pull – 8"
29426BBZ <i>(shown)</i>	Oversized Pull – 18"
29425BBZ <i>(shown)</i>	Oversized Pull – 12"
29424BBZ <i>(shown)</i>	Oversized Pull – 8"

Additional collection images are located on page 30.
Pack type information can be located in the Product Index that begins on page 213.



29426BBZ
18" ctr.



29425BBZ
12" ctr.



29424BBZ
8" ctr.

ESSENTIAL'Z™ BAR PULLS

Available Finishes

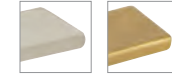

G10 BBZ

A full finish index is located on pages 8-11.

Product Number	Type of Hardware
26207G10 <i>(shown)</i>	Oversized Pull – 18"
26206G10 <i>(shown)</i>	Oversized Pull – 12"
26205G10 <i>(shown)</i>	Oversized Pull – 8"
26207BBZ	Oversized Pull – 18"
26206BBZ	Oversized Pull – 12"
26205BBZ	Oversized Pull – 8"

Additional collection images are located on page 30.
Pack type information can be located in the Product Index that begins on page 213.

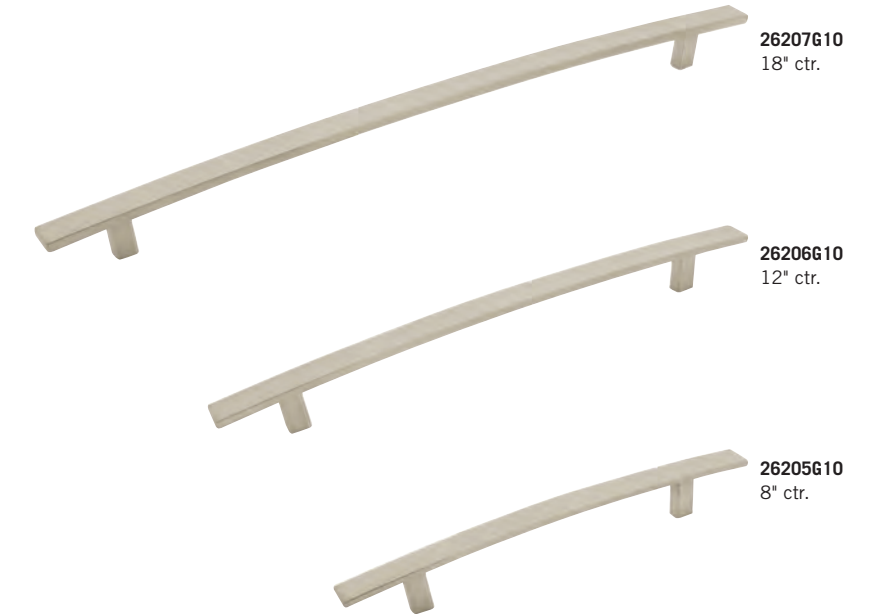

26207G10
18" ctr.

26206G10
12" ctr.

26205G10
8" ctr.

RIVA

Available Finishes



G10 GPH

A full finish index is located on pages 8-11.

Product Number	Type of Hardware
55371G10 <i>(shown)</i>	Oversized Pull – 18"
55370G10 <i>(shown)</i>	Oversized Pull – 12"
55369G10 <i>(shown)</i>	Oversized Pull – 8"
55371GPH	Oversized Pull – 18"
55370GPH	Oversized Pull – 12"
55369GPH	Oversized Pull – 8"

Additional collection images are located on page 31.
Pack type information can be located in the Product Index that begins on page 213.

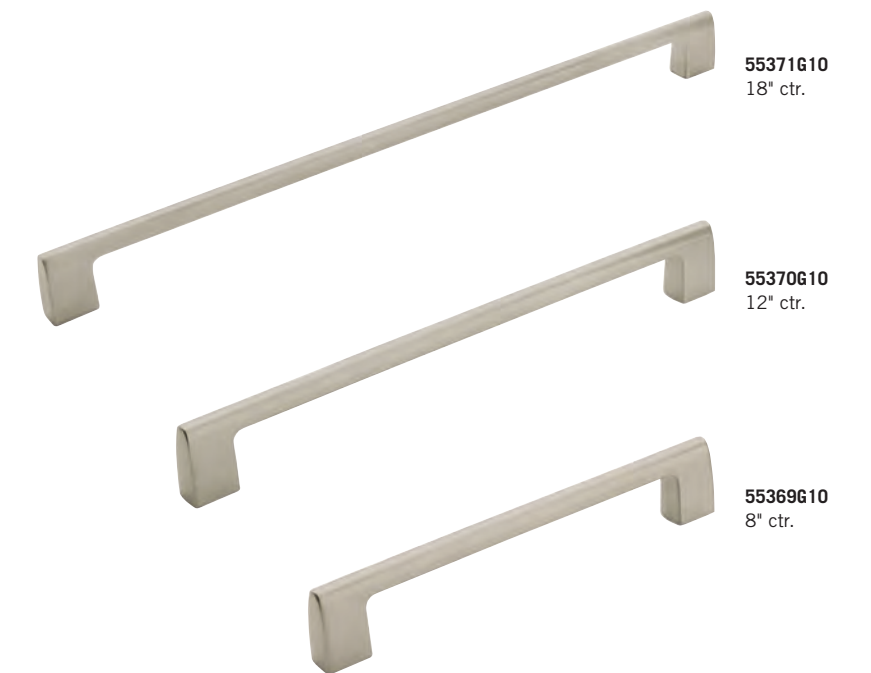

55371G10
18" ctr.

55370G10
12" ctr.

55369G10
8" ctr.

BAR PULLS

Available Finishes

Finishes may not be available in all styles.



G9 SS ORB

A full finish index is located on pages 8-11.

Product Number	Type of Hardware
19019CSG9	Oversized Pull – 768mm
19018CSG9	Oversized Pull – 640mm
19017CSG9	Oversized Pull – 544mm
19016CSG9	Oversized Pull – 480mm
19015CSG9	Oversized Pull – 416mm
19014CSG9	Oversized Pull – 320mm
19013CSG9	Oversized Pull – 256mm
19019SS (shown)	Oversized Pull – 768mm
19018SS (shown)	Oversized Pull – 640mm
19017SS (shown)	Oversized Pull – 544mm
19016SS (shown)	Oversized Pull – 480mm
54025SS	Oversized Pull – 18"
19015SS (shown)	Oversized Pull – 416mm
19014SS (shown)	Oversized Pull – 320mm
54008SS	Oversized Pull – 12"
19013SS (shown)	Oversized Pull – 256mm
19019ORB	Oversized Pull – 768mm
19018ORB	Oversized Pull – 640mm
19017ORB	Oversized Pull – 544mm
19016ORB	Oversized Pull – 480mm
54025ORB	Oversized Pull – 18"
19015ORB	Oversized Pull – 416mm
19014ORB	Oversized Pull – 320mm
54008ORB	Oversized Pull – 12"
40519ORB	Oversized Pull – 256mm

Additional collection images are located on page 32.
Pack type information can be located in the Product Index that begins on page 213.



19013SS
256mm ctr.

19014SS
320mm ctr.

19015SS
416mm ctr.

19016SS
480mm ctr.

19017SS
544mm ctr.

19018SS
640mm ctr.

19019SS
768mm ctr.

ATHERLY

Available Finishes

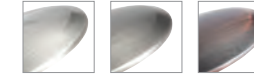

G10 AS ORB

A full finish index is located on pages 8-11.

Product Number	Type of Hardware
29304G10	Oversized Oval Knob – 1 7/8"
29305G10	Oversized Round Knob – 1 1/2"
29304AS	Oversized Oval Knob – 1 7/8"
29305AS	Oversized Round Knob – 1 1/2"
29304ORB (shown)	Oversized Oval Knob – 1 7/8"
29305ORB (shown)	Oversized Round Knob – 1 1/2"

Additional collection images are located on page 46.

Pack type information can be located in the Product Index that begins on page 213.



29304ORB
1 7/8" dia.



29305ORB
1 1/2" dia.

MULHOLLAND™

Available Finishes

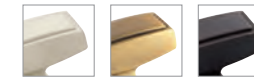

G10 GB ORB

A full finish index is located on pages 8-11.

Product Number	Type of Hardware
53533G10	Oversized Pull – 18"
53532G10	Oversized Pull – 12"
53531G10	Oversized Pull – 8"
535342G10	Oversized T-Knob – 1 1/2"
53533GB	Oversized Pull – 18"
53532GB	Oversized Pull – 12"
53531GB	Oversized Pull – 8"
535342GB	Oversized T-Knob – 1 1/2"
53533ORB (shown)	Oversized Pull – 18"
53532ORB (shown)	Oversized Pull – 12"
53531ORB (shown)	Oversized Pull – 8"
535342ORB (shown)	Oversized T-Knob – 1 1/2"

Additional collection images are located on page 47.

Pack type information can be located in the Product Index that begins on page 213.



53533ORB
18" ctr.

53532ORB
12" ctr.

53531ORB
8" ctr.

535342ORB
1 1/2" length

REVITALIZE

Available Finishes



G10 GB ORB

A full finish index is located on pages 8-11.

Product Number	Type of Hardware
55350G10	Oversized Pull – 18"
55349G10	Oversized Pull – 12"
55348G10	Oversized Pull – 8"
55350GB <i>(shown)</i>	Oversized Pull – 18"
55349GB <i>(shown)</i>	Oversized Pull – 12"
55348GB <i>(shown)</i>	Oversized Pull – 8"
55350ORB	Oversized Pull – 18"
55349ORB	Oversized Pull – 12"
55348ORB	Oversized Pull – 8"

Additional collection images are located on page 48.
Pack type information can be located in the Product Index that begins on page 213.



LATTICE™

Available Finishes

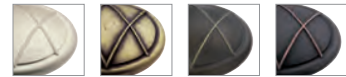

SN DBS RB DOB

A full finish index is located on pages 8-11.

Product Number	Type of Hardware
55426SN	Oversized Pull – 18"
55425SN	Oversized Pull – 12"
55424SN	Oversized Pull – 8"
554202SN	Oversized Knob – 1 11/16"
55426DBS	Oversized Pull – 18"
55425DBS	Oversized Pull – 12"
55424DBS	Oversized Pull – 8"
554202DBS	Oversized Knob – 1 11/16"
55426RB	Oversized Pull – 18"
55425RB	Oversized Pull – 12"
55424RB	Oversized Pull – 8"
554202RB	Oversized Knob – 1 11/16"
55426DOB <i>(shown)</i>	Oversized Pull – 18"
55425DOB <i>(shown)</i>	Oversized Pull – 12"
55424DOB <i>(shown)</i>	Oversized Pull – 8"
554202DOB <i>(shown)</i>	Oversized Knob – 1 11/16"

Additional collection images are located on page 49.
Pack type information can be located in the Product Index that begins on page 213.



MANOR

Available Finishes

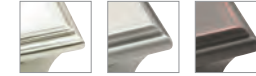

PN G10 ORB

A full finish index is located on pages 8-11.

Product Number	Type of Hardware
261392PN	Oversized Knob – 1 3/7"
261392G10	Oversized Knob – 1 3/7"
261392ORB <i>(shown)</i>	Oversized Knob – 1 3/7"

Additional collection images are located on page 52.
Pack type information can be located in the Product Index that begins on page 213.



261392ORB
1 3/7" length

Available Finishes

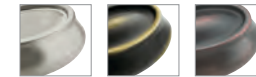

G10 RB ORB

A full finish index is located on pages 8-11.

Product Number	Type of Hardware
261272G10	Oversized Knob – 2"
261272RB	Oversized Knob – 2"
261272ORB <i>(shown)</i>	Oversized Knob – 2"

Additional collection images are located on page 53.
Pack type information can be located in the Product Index that begins on page 213.



261272ORB
2" length

BRASS & STERLING TRADITIONS

Available Finishes

Finishes may not be available in all styles.

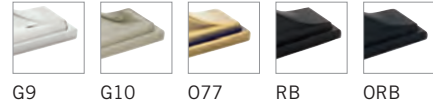

A full finish index is located on pages 8-11.

Product Number	Type of Hardware
54004G9	Oversized Pull – 8"
1316G10	Oversized Pull – 18"
1315G10	Oversized Pull – 12"
54004G10	Oversized Pull – 8"
54004077	Oversized Pull – 8"
1316RB <i>(shown)</i>	Oversized Pull – 18"
1315RB <i>(shown)</i>	Oversized Pull – 12"
54004RB <i>(shown)</i>	Oversized Pull – 8"
1316ORB	Oversized Pull – 18"
1315ORB	Oversized Pull – 12"
54004ORB	Oversized Pull – 8"

Additional collection images are located on page 54.

Pack type information can be located in the Product Index that begins on page 213.



1316RB
18" ctr.

1315RB
12" ctr.

54004RB
8" ctr.

HINT OF HERITAGE®

Available Finish



G10

A full finish index is located on pages 8-11.

Product Number	Type of Hardware
14662G10 <i>(shown)</i>	Oversized Knob – 1 3/4"

Additional collection images are located on page 61.

Pack type information can be located in the Product Index that begins on page 213.



14662G10
1 3/4" dia.

BLACKROCK

Available Finishes



G10 ORB BBR

A full finish index is located on pages 8-11.

Product Number	Type of Hardware
55281G10	Oversized Pull – 18"
55280G10	Oversized Pull – 12"
55279G10	Oversized Pull – 8"
55273G10	Oversized Square Knob – 1 1/2"
55272G10	Oversized Knob – 1 5/8"
55281ORB	Oversized Pull – 18"
55280ORB	Oversized Pull – 12"
55279ORB	Oversized Pull – 8"
55273ORB	Oversized Square Knob – 1 1/2"
55272ORB	Oversized Knob – 1 5/8"
55281BBR <i>(shown)</i>	Oversized Pull – 18"
55280BBR <i>(shown)</i>	Oversized Pull – 12"
55279BBR <i>(shown)</i>	Oversized Pull – 8"
55273BBR <i>(shown)</i>	Oversized Square Knob – 1 1/2"
55272BBR <i>(shown)</i>	Oversized Knob – 1 5/8"

Additional collection images are located on page 73.

Pack type information can be located in the Product Index that begins on page 213.



55281BBR
18" ctr.

55280BBR
12" ctr.

55279BBR
8" ctr.

55273BBR
1 1/2" length

55272BBR
1 5/8" dia.

SWIRL'Z®

Available Finishes



G10 ORB

A full finish index is located on pages 8-11.

Product Number	Type of Hardware
93382G10	Oversized Knob – 1 3/4"
93382ORB <i>(shown)</i>	Oversized Knob – 1 3/4"

Additional collection images are located on page 74.
Pack type information can be located in the Product Index that begins on page 213.



93382ORB
1 3/4" dia.

INSPIRATIONS™

Available Finishes

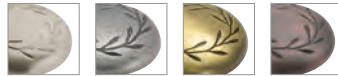

G10 WN EB ORB

A full finish index is located on pages 8-11.

Product Number	Type of Hardware
15812G10	Oversized Knob – 1 3/4"
15812WN <i>(shown)</i>	Oversized Knob – 1 3/4"
15812EB	Oversized Knob – 1 3/4"
15812ORB	Oversized Knob – 1 3/4"

Additional collection images are located on page 75.
Pack type information can be located in the Product Index that begins on page 213.



15812WN
1 3/4" dia.

PADMA™

Available Finishes



AP DBS VS ART

A full finish index is located on pages 8-11.

Product Number	Type of Hardware
54002AP <i>(shown)</i>	Oversized Pull – 12"
54002DBS	Oversized Pull – 12"
54002VS	Oversized Pull – 12"
54002ART	Oversized Pull – 12"

Additional collection images are located on page 76.
Pack type information can be located in the Product Index that begins on page 213.



54002AP
12" ctr.

TRADITIONAL CLASSICS

Available Finishes



G10 WN R2

A full finish index is located on pages 8-11.

Product Number	Type of Hardware
54006G10	Oversized Pull – 12"
54006WN	Oversized Pull – 12"
54006R2 <i>(shown)</i>	Oversized Pull – 12"

Pack type information can be located in the Product Index that begins on page 213.



54006R2
12" ctr.

ESSENTIAL'Z™

Available Finishes



G10 WN ORB

A full finish index is located on pages 8-11.

Product Number	Type of Hardware
54007G10	Oversized Pull – 12"
54007WN	Oversized Pull – 12"
54007ORB <i>(shown)</i>	Oversized Pull – 12"

Pack type information can be located in the Product Index that begins on page 213.



54007ORB
12" ctr.

ALLISON™ VALUE HARDWARE

Available Finishes

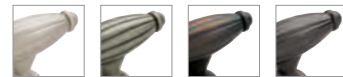

G10 WN ORB GPH

A full finish index is located on pages 112-115.

Product Number	Type of Hardware
55228G10 <i>(shown)</i>	Oversized Pull – 18"
55227G10 <i>(shown)</i>	Oversized Pull – 12"
55226G10 <i>(shown)</i>	Oversized Pull – 8"
552212G10 <i>(shown)</i>	Oversized Knob – 3"
55228WN	Oversized Pull – 18"
55227WN	Oversized Pull – 12"
55226WN	Oversized Pull – 8"
552212WN	Oversized Knob – 3"
55228ORB	Oversized Pull – 18"
55227ORB	Oversized Pull – 12"
55226ORB	Oversized Pull – 8"
552212ORB	Oversized Knob – 3"
55228GPH	Oversized Pull – 18"
55227GPH	Oversized Pull – 12"
55226GPH	Oversized Pull – 8"
552212GPH	Oversized Knob – 3"

Additional collection images are located on page 116.
Pack type information can be located in the Product Index that begins on page 213.

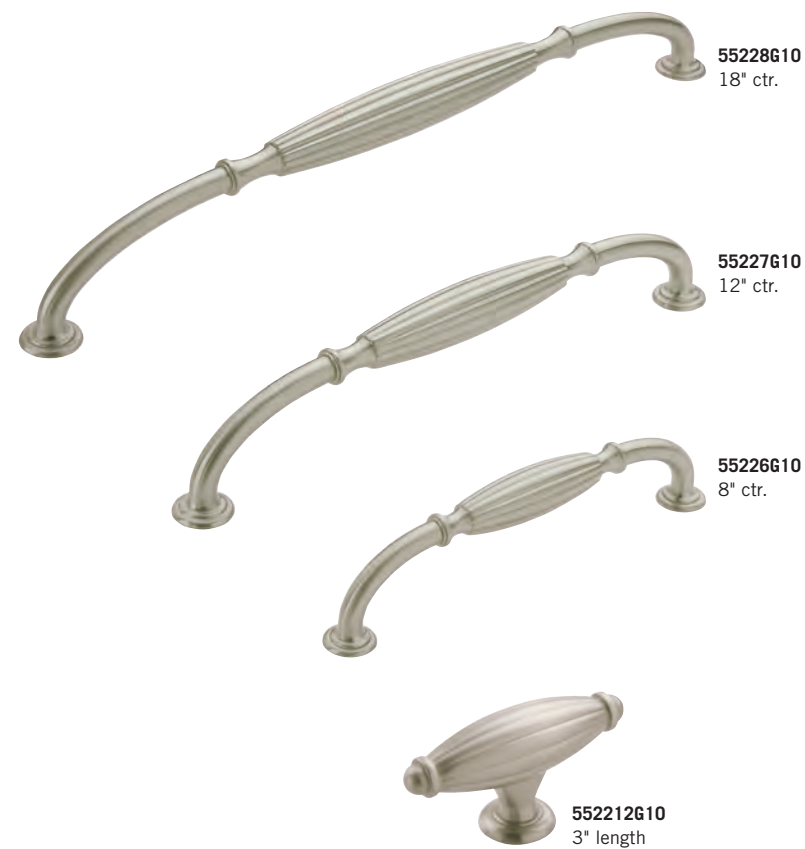

55228G10
18" ctr.

55227G10
12" ctr.

55226G10
8" ctr.

552212G10
3" length

Available Finishes



G10 ORB

A full finish index is located on pages 112-115.

Product Number	Type of Hardware
55248G10 <i>(shown)</i>	Oversized Pull – 18"
55247G10 <i>(shown)</i>	Oversized Pull – 12"
55246G10 <i>(shown)</i>	Oversized Pull – 8"
55248ORB	Oversized Pull – 18"
55247ORB	Oversized Pull – 12"
55246ORB	Oversized Pull – 8"

Additional collection images are located on page 117.
Pack type information can be located in the Product Index that begins on page 213.



55248G10
18" ctr.

55247G10
12" ctr.

55246G10
8" ctr.





INSPIRED COORDINATING COLLECTIONS

Our most affordable Decorative Cabinet Hardware in a complete range of finishes for easy coordination throughout the home.

Featured Here:
Allison™ Value Decorative Cabinet Hardware in Satin Nickel, featuring the 3" Pull.

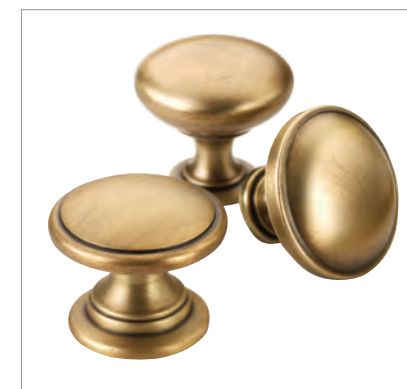

ALLISON™ VALUE HARDWARE

Our Allison Value Hardware offers favorite, time-tested styles in a variety of designs and finishes.

SILVER TONES



26

Polished Chrome



26D

Brushed Chrome



SCH

Brushed Chrome



CH

Polished Chrome



G9

Sterling Nickel



G10

Satin Nickel



AS

Antique Silver



WN

Weathered Nickel

GOLD TONES



3

Polished Brass



B

Polished Solid Brass



PB

Polished Brass



EB

Elegant Brass



GB

Gilded Bronze



BRB

Brushed Brass



LB

Light Antique Brass



AE

Antique English



AB

Antique Brass



ABS

Antique Brass



BB

Burnished Brass



R1

Regency Brass



R3

Rustic Brass

RUSTIC TONES



AC

Antique Copper

DARK TONES



WI

Wrought Iron



WID

Wrought Iron Dark



RB

Roman Bronze



ORB

Oil-Rubbed Bronze



GPH

Graphite



BN

Black Nickel



BNB

Black Nickel (Solid Brass)



FB

Flat Black

COLORS

				
CS Crystal	30 White	W White	54 White	PW White (Plastic)
				
GW White Ceramic	DEL White with Pattern	WHT White or White with Pattern	GC White Ceramic with Gray Circle	BON Bone (Almond)
				
PA Almond (Plastic)	AL Almond	HGR Hunter Green	BJ Black	BL Black
				
BLK Black	PBK Black (Plastic)	NBZ Natural Bronze	MB Matte Black Paint	CB Colonial Black

TWO-TONED

				
WCH White / Polished Chrome	30G White / Satin Nickel	26W Polished Chrome with White Plastic or Ceramic	WPB White / Polished Brass	30B White / Polished Brass
				
W3 Polished Brass with White Ceramic Insert	WB White Ceramic Insert in Burnished Brass	FWP Almond / Polished Brass with Flower	OB Oak / Antique Brass	O3 Oak Insert with Polished Brass
				
OLB Oak with Burnished Brass	OPB Oak / Polished Brass	263 Polished Chrome / Brass	BC Polished Chrome / Brass	

WOOD TONES

				
WOOD Unfinished Wood	MA1 Natural Stained Wood	WD Unfinished Wood, Birch	MA2 Spiced Stained Wood	MA4 Cherry Stained Wood

ALLISON™ VALUE HARDWARE

Available Finishes



A full finish index is located on pages 112-115.

Product Number	Type of Hardware
55228G10*	Oversized Pull* – 18"
55227G10*	Oversized Pull* – 12"
55226G10*	Oversized Pull* – 8"
55225G10	Pull – 160mm
55224G10	Pull – 128mm
55223G10	Pull – 96mm
55222G10	Pull – 3"
552212G10*	Oversized Knob* – 3"
55220G10	Knob – 2 5/8"
55228WN*	Oversized Pull* – 18"
55227WN*	Oversized Pull* – 12"
55226WN*	Oversized Pull* – 8"
55225WN	Pull – 160mm
55224WN	Pull – 128mm
55223WN	Pull – 96mm
55222WN	Pull – 3"
552212WN*	Oversized Knob* – 3"
55220WN	Knob – 2 5/8"
55228ORB*	Oversized Pull* – 18"
55227ORB*	Oversized Pull* – 12"
55226ORB*	Oversized Pull* – 8"
55225ORB (shown)	Pull – 160mm
55224ORB (shown)	Pull – 128mm
55223ORB (shown)	Pull – 96mm
55222ORB (shown)	Pull – 3"
552212ORB* (shown)	Oversized Knob* – 3"
55220ORB (shown)	Knob – 2 5/8"
55228GPH*	Oversized Pull* – 18"
55227GPH*	Oversized Pull* – 12"
55226GPH*	Oversized Pull* – 8"
55225GPH	Pull – 160mm
55224GPH	Pull – 128mm
55223GPH	Pull – 96mm
55222GPH	Pull – 3"
552212GPH*	Oversized Knob* – 3"
55220GPH	Knob – 2 5/8"

*Image can be located in Oversized section that begins on page 92.
Pack type information can be located in the Product Index that begins on page 213.



ALLISON™ VALUE HARDWARE

Available Finishes

Finishes may not be available in all styles.



A full finish index is located on pages 112-115.

Product Number	Type of Hardware
5301326	Pull – 3"
55248G10*	Oversized Pull* – 18"
55247G10*	Oversized Pull* – 12"
55246G10*	Oversized Pull* – 8"
55245G10	Pull – 160mm
55244G10	Pull – 128mm
55243G10	Pull – 96mm
53013G10	Pull – 3"
53013EB	Pull – 3"
53013BB	Pull – 3"
53013RB	Pull – 3"
55248ORB*	Oversized Pull* – 18"
55247ORB*	Oversized Pull* – 12"
55246ORB*	Oversized Pull* – 8"
55245ORB (shown)	Pull – 160mm
55244ORB (shown)	Pull – 128mm
55243ORB (shown)	Pull – 96mm
53013ORB (shown)	Pull – 3"
53013BN	Pull – 3"
53013FB	Pull – 3"

*Image can be located in Oversized section that begins on page 92.
Pack type information can be located in the Product Index that begins on page 213.



ALLISON™ VALUE HARDWARE

Available Finishes

Finishes may not be available in all styles.

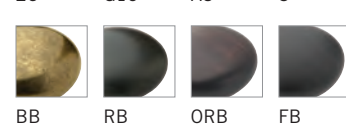
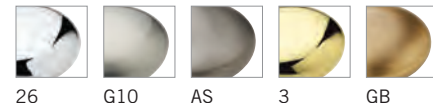

A full finish index is located on pages 112-115.

Product Number	Type of Hardware
----------------	------------------

5300026	Knob – 1 1/4"
5300226	Knob – 1 3/16"
5300526	Knob – 1 1/4"

53000G10 <i>(shown)</i>	Knob – 1 1/4"
53002G10 <i>(shown)</i>	Knob – 1 3/16"
53005G10 <i>(shown)</i>	Knob – 1 1/4"

53005AS	Knob – 1 1/4"
530003	Knob – 1 1/4"
530023	Knob – 1 3/16"
530053	Knob – 1 1/4"

53005GB	Knob – 1 1/4"
---------	---------------

53000BB	Knob – 1 1/4"
53002BB	Knob – 1 3/16"
53005BB	Knob – 1 1/4"

53005RB	Knob – 1 1/4"
---------	---------------

530020RB	Knob – 1 3/16"
530050RB	Knob – 1 1/4"

53000FB	Knob – 1 1/4"
53002FB	Knob – 1 3/16"
53005FB	Knob – 1 1/4"

Pack type information can be located in the Product Index that begins on page 213.



53000G10
1 1/4" dia.



53002G10
1 3/16" dia.



53005G10
1 1/4" dia.

ALLISON™ VALUE HARDWARE

Available Finishes

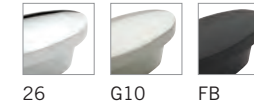

A full finish index is located on pages 112-115.

Product Number	Type of Hardware
----------------	------------------

5301626	Pull – 1"
---------	-----------

53016G10 <i>(shown)</i>	Pull – 1"
--------------------------------	------------------

53016FB	Pull – 1"
---------	-----------

Pack type information can be located in the Product Index that begins on page 213.

Available Finish



CS

A full finish index is located on pages 112-115.

Product Number	Type of Hardware
----------------	------------------

29112CS <i>(shown)</i>	Knob – 1 3/16"
-------------------------------	-----------------------

Pack type information can be located in the Product Index that begins on page 213.

Available Finishes



G10 ORB

A full finish index is located on pages 112-115.

Product Number	Type of Hardware
----------------	------------------

29113G10 <i>(shown)</i>	Knob – 1 1/4"
--------------------------------	----------------------

29113ORB	Knob – 1 1/4"
----------	---------------

Pack type information can be located in the Product Index that begins on page 213.



53016G10
1" ctr.

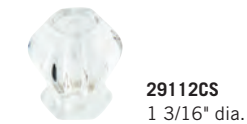

29112CS
1 3/16" dia.



29113G10
1 1/4" dia.

ALLISON™ VALUE HARDWARE

Available Finishes

Finishes may not be available in all styles.



26 G10 AS 3 EB



BB RB ORB BN FB

A full finish index is located on pages 112-115.

Product Number	Type of Hardware
5300326	Pull – 96mm
5300626	Pull – 3"
5300726	Pull – 3"
5300826	Pull – 3"
5300926	Pull – 3"
5301026	Cup Pull – 3"
53003G10 <i>(shown)</i>	Pull – 96mm
53006G10 <i>(shown)</i>	Pull – 3"
53007G10 <i>(shown)</i>	Pull – 3"
53008G10 <i>(shown)</i>	Pull – 3"
53009G10 <i>(shown)</i>	Pull – 3"
53010G10 <i>(shown)</i>	Cup Pull – 3"
53010AS	Cup Pull – 3"
530033	Pull – 96mm
530063	Pull – 3"
530073	Pull – 3"
530083	Pull – 3"
53009EB	Pull – 3"
53010EB	Cup Pull – 3"
53003BB	Pull – 96mm
53006BB	Pull – 3"
53007BB	Pull – 3"
53008BB	Pull – 3"
53010BB	Cup Pull – 3"
53006RB	Pull – 3"
53010RB	Cup Pull – 3"
53003ORB	Pull – 96mm
53006ORB	Pull – 3"
53010ORB	Cup Pull – 3"
53009BN	Pull – 3"
53010BN	Cup Pull – 3"
53003FB	Pull – 96mm
53006FB	Pull – 3"
53007FB	Pull – 3"
53008FB	Pull – 3"
53009FB	Pull – 3"
53010FB	Cup Pull – 3"

Pack type information can be located in the Product Index that begins on page 213.



53003G10
96mm ctr.



53006G10
3" ctr.



53007G10
3" ctr.



53008G10
3" ctr.



53009G10
3" ctr.



53010G10
3" ctr.

ALLISON™ VALUE HARDWARE

Available Finishes

Finishes may not be available in all styles.

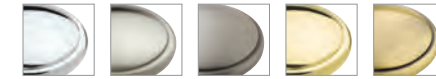

26 G10 AS 3 EB

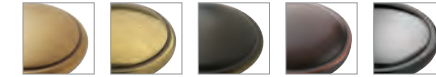

GB BB RB ORB BN



FB

A full finish index is located on pages 112-115.

Product Number	Type of Hardware
5301126	Knob – 1 1/4"
5301226	Knob – 1 1/4"
5301526	Knob – 1 1/4"
53011G10 <i>(shown)</i>	Knob – 1 1/4"
53012G10 <i>(shown)</i>	Knob – 1 1/4"
53015G10 <i>(shown)</i>	Knob – 1 1/4"
53012AS	Knob – 1 1/4"
53015AS	Knob – 1 1/4"
530113	Knob – 1 1/4"
530123	Knob – 1 1/4"
530153	Knob – 1 1/4"
53011EB	Knob – 1 1/4"
53012EB	Knob – 1 1/4"
53015EB	Knob – 1 1/4"
53012GB	Knob – 1 1/4"
53015GB	Knob – 1 1/4"
53012BB	Knob – 1 1/4"
53012RB	Knob – 1 1/4"
53011ORB	Knob – 1 1/4"
53012ORB	Knob – 1 1/4"
53015ORB	Knob – 1 1/4"
53011BN	Knob – 1 1/4"
53012BN	Knob – 1 1/4"
53015BN	Knob – 1 1/4"
53011FB	Knob – 1 1/4"
53012FB	Knob – 1 1/4"
53015FB	Knob – 1 1/4"

Pack type information can be located in the Product Index that begins on page 213.



53011G10
1 1/4" dia.



53012G10
1 1/4" dia.



53015G10
1 1/4" dia.

ALLISON™ VALUE HARDWARE

Available Finishes

Finishes may not be available in all styles.



26 G10 3 EB ORB

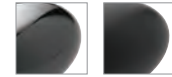

BN FB

A full finish index is located on pages 112-115.

Product Number	Type of Hardware
5301826	Knob – 1 3/8"
5301426	Knob – 1 3/8"
53018G10 (shown)	Knob – 1 3/8"
53014G10 (shown)	Knob – 1 3/8"
530183	Knob – 1 3/8"
530143	Knob – 1 3/8"
53018EB	Knob – 1 3/8"
53014EB	Knob – 1 3/8"
53018ORB	Knob – 1 3/8"
53014ORB	Knob – 1 3/8"
53014BN	Knob – 1 3/8"
53018FB	Knob – 1 3/8"
53014FB	Knob – 1 3/8"

Pack type information can be located in the Product Index that begins on page 213.

Available Finishes



G10 WN WID ORB

A full finish index is located on pages 112-115.

Product Number	Type of Hardware
29116G10 (shown)	Knob – 1 3/16"
29116WN	Knob – 1 3/16"
29116WID	Knob – 1 3/16"
29116ORB	Knob – 1 3/16"

Pack type information can be located in the Product Index that begins on page 213.



53018G10
1 3/8" length



53014G10
1 3/8" length



29116G10
1 3/16" dia.

ALLISON™ VALUE HARDWARE

Available Finishes

Finishes may not be available in all styles.

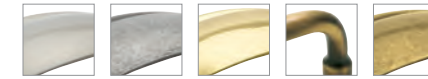

G10 WN 3 AE BB

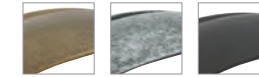

R3 WI FB

A full finish index is located on pages 112-115.

Product Number	Type of Hardware
1452G10	Pull – 4"
53019G10	Cup Pull – 2 1/2"
53019WN	Cup Pull – 2 1/2"
14513 (shown)	Pull – 3 1/2"
530193 (shown)	Cup Pull – 2 1/2"
1452AE (shown)	Pull – 4"
53019BB	Cup Pull – 2 1/2"
53019R3	Cup Pull – 2 1/2"
53019WI	Cup Pull – 2 1/2"
53019FB	Cup Pull – 2 1/2"

Pack type information can be located in the Product Index that begins on page 213.

Available Finish



3

A full finish index is located on pages 112-115.

Product Number	Type of Hardware
14113 (shown)	Pull – 3"
14233 (shown)	Knob – 1"

Pack type information can be located in the Product Index that begins on page 213.



1452AE
4" ctr.



14513
3 1/2" ctr.



530193
2 1/2" ctr.



14113
3" ctr.



14233
1" dia.

ALLISON™ VALUE HARDWARE

Available Finish



WN

A full finish index is located on pages 112-115.

Product Number	Type of Hardware
----------------	------------------

53017WN (shown)	Knob – 1 1/4"
-----------------	---------------

Pack type information can be located in the Product Index that begins on page 213.

Available Finishes



26 G10 WN 3 EB



BB ORB FB

A full finish index is located on pages 112-115.

Product Number	Type of Hardware
----------------	------------------

5347026	Pull – 3"
5347126	Knob – 1 1/4"

53470G10 (shown)	Pull – 3"
53471G10 (shown)	Knob – 1 1/4"

53470WN	Pull – 3"
53471WN	Knob – 1 1/4"

534703	Pull – 3"
534713	Knob – 1 1/4"

53470EB	Pull – 3"
53471EB	Knob – 1 1/4"

53470BB	Pull – 3"
53471BB	Knob – 1 1/4"

53470ORB	Pull – 3"
53471ORB	Knob – 1 1/4"

53470FB	Pull – 3"
53471FB	Knob – 1 1/4"

Pack type information can be located in the Product Index that begins on page 213.



53017WN
1 1/4" ctr.



53470G10
3" ctr.



53471G10
1 1/4" dia.

ALLISON™ VALUE HARDWARE

Available Finishes



26 G10 3 BB ORB



FB

A full finish index is located on pages 112-115.

Product Number	Type of Hardware
----------------	------------------

5300126	Knob – 1 1/4"
5300426	Pull – 96mm

53001G10 (shown)	Knob – 1 1/4"
53004G10 (shown)	Pull – 96mm

530013	Knob – 1 1/4"
530043	Pull – 96mm

53001BB	Knob – 1 1/4"
53004BB	Pull – 96mm

53001ORB	Knob – 1 1/4"
53004ORB	Pull – 96mm

53001FB	Knob – 1 1/4"
53004FB	Pull – 96mm

Pack type information can be located in the Product Index that begins on page 213.

Available Finishes



26 G10 3 BB FB

A full finish index is located on pages 112-115.

Product Number	Type of Hardware
----------------	------------------

5302126	Pull – 96mm
5302226	Knob – 1 1/4"

53021G10 (shown)	Pull – 96mm
53022G10 (shown)	Knob – 1 1/4"

530213	Pull – 96mm
530223	Knob – 1 1/4"

53021BB	Pull – 96mm
53022BB	Knob – 1 1/4"

53021FB	Pull – 96mm
53022FB	Knob – 1 1/4"

Pack type information can be located in the Product Index that begins on page 213.



53004G10
96mm ctr.



53001G10
1 1/4" dia.



53021G10
96mm ctr.



53022G10
1 1/4" dia.

ALLISON™ VALUE HARDWARE

Available Finishes

Finishes may not be available in all styles.



26 26D G10 3 PB



B AE BB BRB ORB

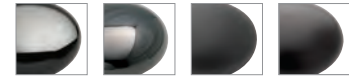

BN BNB FB NBZ

A full finish index is located on pages 112-115.

Product Number	Type of Hardware
----------------	------------------

5302326 (shown)	Knob – 1 1/4"
71026 (shown)	Knob – 1 1/4"
191026	Knob – 1 1/4"
195026	Knob – 1 1/4"

191026D (shown)	Knob – 1 1/4"
195026D (shown)	Knob – 1 1/4"
2911026D	Knob – 1 3/16"

53023G10	Knob – 1 1/4"
1910G10	Knob – 1 1/4"
1950G10	Knob – 1 1/4"
1443G10 (shown)	Knob – 1 1/4"
29110G10 (shown)	Knob – 1 3/16"
29115G10 (shown)	Knob – 1 1/2"
29117G10 (shown)	Knob – 1 3/16"

530233	Knob – 1 1/4"
7103	Knob – 1 1/4"
14433	Knob – 1 1/4"

1910PB	Knob – 1 1/4"
--------	---------------

1950B	Knob – 1 1/4"
-------	---------------

1950AE	Knob – 1 1/4"
--------	---------------

53023BB	Knob – 1 1/4"
---------	---------------

1950BRB	Knob – 1 1/4"
---------	---------------

1950ORB	Knob – 1 1/4"
1443ORB	Knob – 1 1/4"

1910BN	Knob – 1 1/4"
--------	---------------

1950BNB	Knob – 1 1/4"
---------	---------------

53023FB	Knob – 1 1/4"
---------	---------------

1950NBZ	Knob – 1 1/4"
---------	---------------

Pack type information can be located in the Product Index that begins on page 213.



5302326
1 1/4" dia.



1443G10
1 1/4" length



71026
1 1/4" dia.



29110G10
1 3/16" dia.



191026D
1 1/4" dia.



29115G10
1 1/2" dia.



195026D
1 1/4" dia.



29117G10
1 3/16" dia.

ALLISON™ VALUE HARDWARE

Available Finishes

Finishes may not be available in all styles.



G9 G10 3 PB BB



R1 WID BNB GW MB

A full finish index is located on pages 112-115.

Product Number	Type of Hardware
----------------	------------------

76272G9 (shown)	Pull – 3"
------------------------	-----------

1952G10	Pull – 3 1/2"
---------	---------------

1951G10	Pull – 3"
---------	-----------

4261G10 (shown)	Pull – 3"
------------------------	-----------

34413 (shown)	Pull – 3"
----------------------	-----------

762733 (shown)	Pull – 3"
-----------------------	-----------

762803 (shown)	Pull – 3"
-----------------------	-----------

252PB (shown)	Pull – 3"
----------------------	-----------

3441BB	Pull – 3"
--------	-----------

76273R1	Pull – 3"
---------	-----------

76280R1	Pull – 3"
---------	-----------

4261WID	Pull – 3"
---------	-----------

1952BNB (shown)	Pull – 3 1/2"
------------------------	---------------

1951BNB (shown)	Pull – 3"
------------------------	-----------

3441GW	Pull – 3"
--------	-----------

76280GW	Pull – 3"
---------	-----------

76280MB	Pull – 3"
---------	-----------

Pack type information can be located in the Product Index that begins on page 213.



1952BNB
3 1/2" ctr.



1951BNB
3" ctr.



76272G9
3" ctr.



4261G10
3" ctr.



34413
3" ctr.



762733
3" ctr.



762803
3" ctr.



252PB
3" ctr.

ALLISON™ VALUE HARDWARE

Available Finishes

Finishes may not be available in all styles.

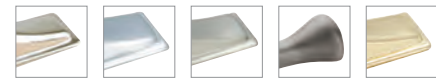

CH SCH G10 AS PB

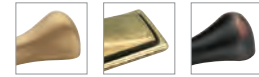

GB LB ORB

A full finish index is located on pages 112-115.

Product Number	Type of Hardware
173CH <i>(shown)</i> 174CH	Pull – 3" Pull – 3"
172SCH <i>(shown)</i> 174SCH <i>(shown)</i> 253SCH <i>(shown)</i> 254SCH <i>(shown)</i>	Pull – 3" Pull – 3" Pull – 3" Pull – 3"
172G10 173G10 174G10 253G10 1908G10 <i>(shown)</i>	Pull – 3" Pull – 3" Pull – 3" Pull – 3" Pull – 3"
174AS	Pull – 3"
173PB 253PB 254PB 1908PB	Pull – 3" Pull – 3" Pull – 3" Pull – 3"
174GB	Pull – 3"
172LB 253LB	Pull – 3" Pull – 3"
173ORB 174ORB 253ORB	Pull – 3" Pull – 3" Pull – 3"

Pack type information can be located in the Product Index that begins on page 213.

Available Finish



3

A full finish index is located on pages 112-115.

Product Number	Type of Hardware
306473 <i>(shown)</i>	Knob – 1 1/4"

Pack type information can be located in the Product Index that begins on page 213.



ALLISON™ VALUE HARDWARE

Available Finishes

Finishes may not be available in all styles.

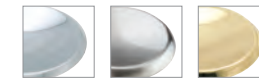

26 G10 3

A full finish index is located on pages 112-115.

Product Number	Type of Hardware
341426 <i>(shown)</i>	Knob – 1 3/4"
341326 <i>(shown)</i>	Knob – 1 1/2"
55126 <i>(shown)</i>	Knob – 1 1/16"
69151G10 <i>(shown)</i>	Knob – 1 1/2"
34143 34133	Knob – 1 3/4" Knob – 1 1/2"
69152 <i>(shown)</i>	Knob – 1 1/2"

Pack type information can be located in the Product Index that begins on page 213.

Available Finishes



26 26D G10 B AE



BNB

A full finish index is located on pages 112-115.

Product Number	Type of Hardware
1950H26	Knob – 1 1/4"
1950H26D	Knob – 1 1/4"
1950HG10	Knob – 1 1/4"
1950HB	Knob – 1 1/4"
1950HAE	Knob – 1 1/4"
1950HBNB <i>(shown)</i>	Knob – 1 1/4"

Pack type information can be located in the Product Index that begins on page 213.



ALLISON™ VALUE HARDWARE

Available Finish



G10

A full finish index is located on pages 112-115.

Product Number	Type of Hardware
52998G10 <i>(shown)</i>	Pull – 128mm
52997G10 <i>(shown)</i>	Pull – 96mm

Pack type information can be located in the Product Index that begins on page 213.

Available Finishes

Finishes may not be available in all styles.



ABS AC BL CB

A full finish index is located on pages 112-115.

Product Number	Type of Hardware
410ABS	Pull – 3 1/4"
3401AC	Pull – 3 1/4"
410BL <i>(shown)</i>	Pull – 3 1/4"
3401CB <i>(shown)</i>	Pull – 3 1/4"

Pack type information can be located in the Product Index that begins on page 213.

Available Finishes

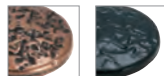

AC CB

A full finish index is located on pages 112-115.

Product Number	Type of Hardware
3403AC	Knob – 1 1/4"
3403CB <i>(shown)</i>	Knob – 1 1/4"

Pack type information can be located in the Product Index that begins on page 213.



52998G10
128mm ctr.



52997G10
96mm ctr.



3401CB
3 1/4" ctr.



410BL
3 1/4" ctr.



3403CB
1 1/4" dia.

ALLISON™ VALUE HARDWARE

Available Finishes

Finishes may not be available in all styles.



26 G10 3

A full finish index is located on pages 112-115.

Product Number	Type of Hardware
341626 <i>(shown)</i>	Pull – 3"
341526 <i>(shown)</i>	Pull – 2 3/4"

29111G10 <i>(shown)</i>	Pull – 128mm
69153G10 <i>(shown)</i>	Pull – 3"

69154 <i>(shown)</i>	Pull – 3"
34163	Pull – 3"
34153	Pull – 2 3/4"

Pack type information can be located in the Product Index that begins on page 213.

Available Finish



G9

A full finish index is located on pages 112-115.

Product Number	Type of Hardware
76270G9 <i>(shown)</i>	Knob – 1 1/2"

Pack type information can be located in the Product Index that begins on page 213.



29111G10
128mm ctr.



341626
3" ctr.



341526
2 3/4" ctr.



69153G10
3" ctr.



69154
3" ctr.



76270G9
1 1/2" length

ALLISON™ VALUE HARDWARE

Available Finishes

Finishes may not be available in all styles.



BN

A full finish index is located on pages 112-115.

Product Number	Type of Hardware
7631226	Pull – 4"
76312CS26	Pull – 4"
76313CS26	Pull – 96mm
86726	Pull – 3 1/2"
867CS26	Pull – 3 1/2"
86526	Pull – 3"
865CS26	Pull – 3"
197026D (shown)	Pull – 96mm
7631226D (shown)	Pull – 4"
76312CS26D	Pull – 4"
76313CS26D	Pull – 96mm
7631326D (shown)	Pull – 96mm
86726D (shown)	Pull – 3 1/2"
867CS26D	Pull – 3 1/2"
86526D (shown)	Pull – 3"
865CS26D	Pull – 3"
1970G10	Pull – 96mm
76312G10	Pull – 4"
76312CSG10	Pull – 4"
76313G10	Pull – 96mm
76313CSG10	Pull – 96mm
867G10	Pull – 3 1/2"
867CSG10	Pull – 3 1/2"
865G10	Pull – 3"
865CSG10	Pull – 3"
763123	Pull – 4"
76312CS3	Pull – 4"
76313CS3	Pull – 96mm
8673	Pull – 3 1/2"
8653	Pull – 3"
865CS3	Pull – 3"
865BB	Pull – 3"
865BN	Pull – 3"
76313BN	Pull – 96mm

Pack type information can be located in the Product Index that begins on page 213.



7631226D
4" ctr.

7631326D
96mm ctr.

197026D
96mm ctr.

86726D
3 1/2" ctr.

86526D
3" ctr.

ALLISON™ VALUE HARDWARE

Available Finishes

Finishes may not be available in all styles.



G10 AS AE AB ORB

A full finish index is located on pages 112-115.

Product Number	Type of Hardware
149G10	Pull – 3"
149AS	Pull – 3"
149AE (shown)	Pull – 3"
156AE (shown)	Pull – 3"
176AE (shown)	Pull – 3"
638AE (shown)	Pull – 3"
644AE (shown)	Pull – 3"
859AE (shown)	Pull – 3"
76393AE (shown)	Pull – 3"
29114AB (shown)	Pull – 3"
149ORB	Pull – 3"

Pack type information can be located in the Product Index that begins on page 213.

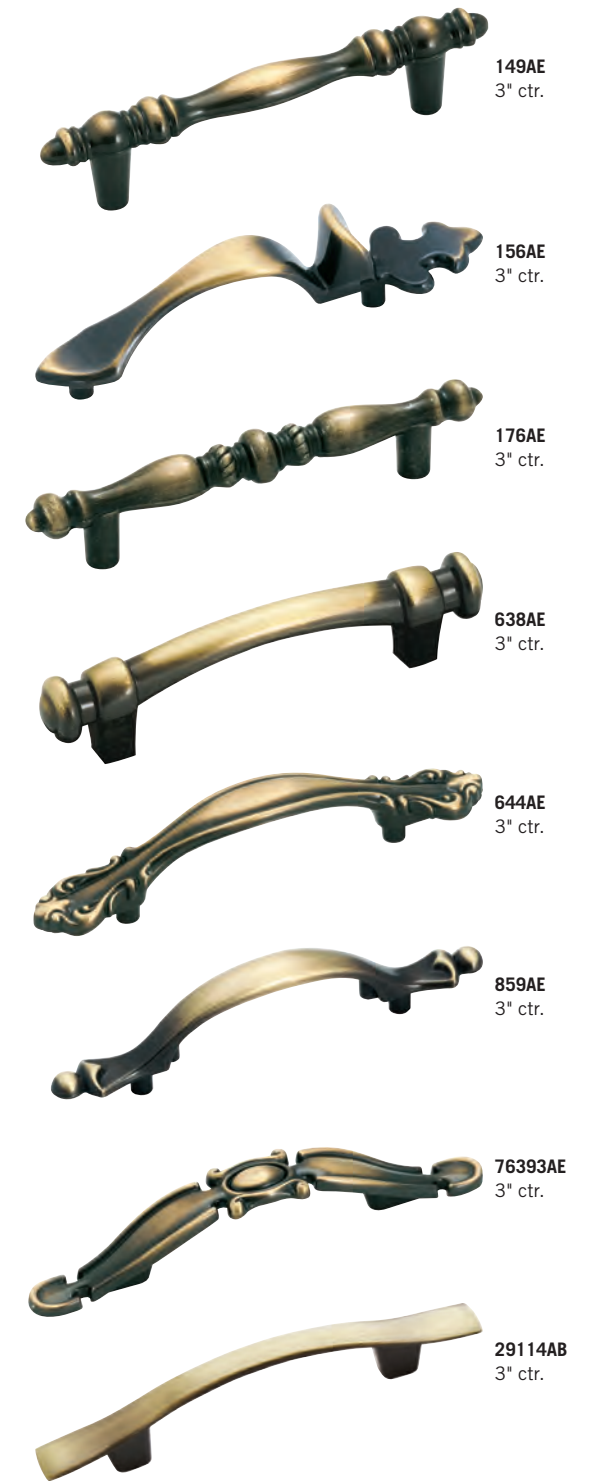

149AE
3" ctr.

156AE
3" ctr.

176AE
3" ctr.

638AE
3" ctr.

644AE
3" ctr.

859AE
3" ctr.

76393AE
3" ctr.

29114AB
3" ctr.

ALLISON™ VALUE HARDWARE

Available Finishes

Finishes may not be available in all styles.



AE ABS BB AC

A full finish index is located on pages 112-115.

Product Number	Type of Hardware
----------------	------------------

3468AE (shown)	Pull – 3"
3470AE (shown)	Pull – 3"
76223AE (shown)	Pull – 3"

714ABS (shown)	Pull – 3"
894ABS (shown)	Pull – 3"

743BB (shown)	Pull – 3"
3421BB (shown)	Pull – 3"

3434AC (shown)	Pull – 3"
----------------	-----------

Pack type information can be located in the Product Index that begins on page 213.



3468AE
3" ctr.



3470AE
3" ctr.



76223AE
3" ctr.



714ABS
3" ctr.



894ABS
3" ctr.



743BB
3" ctr.



3421BB
3" ctr.



3434AC
3" ctr.

ALLISON™ VALUE HARDWARE

Available Finishes

Finishes may not be available in all styles.



3 AE AB ABS AC



ORB BL

A full finish index is located on pages 112-115.

Product Number	Type of Hardware
----------------	------------------

762093 (shown)	Knob – 1 1/8"
----------------	---------------

643AE (shown)	Knob – 1 1/16"
728AE (shown)	Knob – 1 1/4"
755AE (shown)	Knob – 1 1/4"
778AE (shown)	Backplate – 2"
776AE (shown)	Knob – 1 1/4"
3448AE (shown)	Knob – 1 3/8"
594AE (shown)	Knob – 1 1/2"
3467AE (shown)	Knob – 1 1/16"
76209AE	Knob – 1 1/8"
69169 (shown)	Knob – 1 1/2"

29118AB (shown)	Knob – 1 3/8"
-----------------	---------------

125ABS (shown)	Knob – 1 1/4"
159ABS (shown)	Knob – 1 1/2"
497ABS (shown)	Knob – 1 1/16"
890ABS (shown)	Knob – 1 1/2"

3433AC (shown)	Knob – 1 1/2"
----------------	---------------

159ORB	Knob – 1 1/2"
--------	---------------

497BL	Knob – 1 1/16"
-------	----------------

Pack type information can be located in the Product Index that begins on page 213.



69169
1 1/2" dia.



762093
1 1/8" dia.



728AE
1 1/4" dia.



643AE
1 1/16" dia.



778AE
2" dia.



755AE
1 1/4" dia.



3448AE
1 3/8" dia.



776AE
1 1/4" dia.

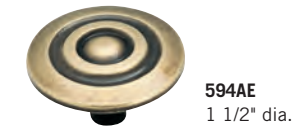

594AE
1 1/2" dia.

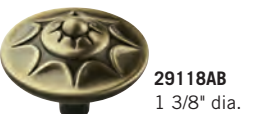

29118AB
1 3/8" dia.



159ABS
1 1/2" dia.



3467AE
1 1/16" dia.



3433AC
1 1/2" dia.



125ABS
1 1/4" dia.



890ABS
1 1/2" dia.

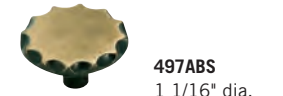

497ABS
1 1/16" dia.

ALLISON™ VALUE HARDWARE

Available Finishes

Finishes may not be available in all styles.



3 PB R1 GW

A full finish index is located on pages 112-115.

Product Number	Type of Hardware
7503 <i>(shown)</i>	Pull – 3"
7613 <i>(shown)</i>	Pull – 3"
14465PB <i>(shown)</i>	Pull – 3"
76290R1 <i>(shown)</i>	Pull – 3"
750GW	Pull – 3"

Pack type information can be located in the Product Index that begins on page 213.



ALLISON™ VALUE HARDWARE

Available Finish



G10

A full finish index is located on pages 112-115.

Product Number	Type of Hardware
29119G10 <i>(shown)</i>	Pull – 96mm
29120G10 <i>(shown)</i>	Pull – 96mm
52989G10 <i>(shown)</i>	Pull – 96mm
52990G10 <i>(shown)</i>	Pull – 96mm
52991G10 <i>(shown)</i>	Pull – 96mm
52992G10 <i>(shown)</i>	Pull – 96mm
52993G10 <i>(shown)</i>	Pull – 96mm

Pack type information can be located in the Product Index that begins on page 213.



ALLISON™ VALUE HARDWARE

Available Finish



G10

A full finish index is located on pages 112-115.

Product Number	Type of Hardware
52994G10 <i>(shown)</i>	Pull – 96mm
52995G10 <i>(shown)</i>	Pull – 96mm
52996G10 <i>(shown)</i>	Pull – 96mm

Pack type information can be located in the Product Index that begins on page 213.



Available Finishes

Finishes may not be available in all styles.



26D



W

A full finish index is located on pages 112-115.

Product Number	Type of Hardware
97926D <i>(shown)</i>	Pull – 4"
97826D <i>(shown)</i>	Pull – 3 1/2"
97726D <i>(shown)</i>	Pull – 3"

Pack type information can be located in the Product Index that begins on page 213.



ALLISON™ VALUE HARDWARE

Available Finishes

Finishes may not be available in all styles.



SCH



CH

A full finish index is located on pages 112-115.

Product Number	Type of Hardware
943SCH <i>(shown)</i>	Pull – 4"
942SCH <i>(shown)</i>	Pull – 3"
942CH	Pull – 3"

Pack type information can be located in the Product Index that begins on page 213.



Available Finishes

Finishes may not be available in all styles.



26D



CH



G10

A full finish index is located on pages 112-115.

Product Number	Type of Hardware
3053526D <i>(shown)</i>	Pull – 3"
170CH <i>(shown)</i>	Pull – 3"
171G10 <i>(shown)</i>	Pull – 3"
1930G10 <i>(shown)</i>	Pull – 3"

Pack type information can be located in the Product Index that begins on page 213.

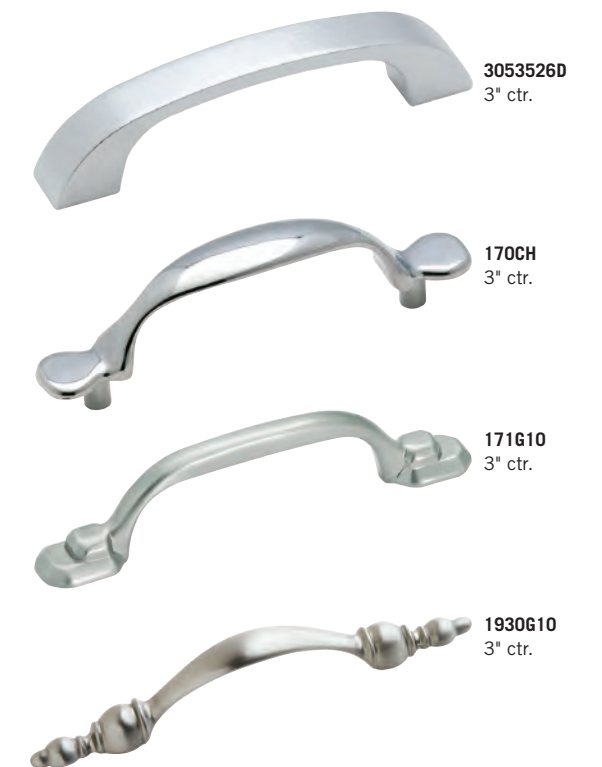

ALLISON™ VALUE HARDWARE

Available Finishes

Finishes may not be available in all styles.



G10 AS 3 PB LB



AE AB BB R1 GW



MB

A full finish index is located on pages 112-115.

Product Number	Type of Hardware
875G10 76294G10	Knob – 1 3/8" Knob – 1 3/16"
875AS 76294AS	Knob – 1 3/8" Knob – 1 3/16"
34433 14243 (shown) 69267 (shown) 69268 (shown)	Knob – 1 3/16" Knob – 1 1/4" Knob – 1 1/16" Knob – 1 5/16"
255PB (shown) 256PB (shown)	Knob – 1 1/4" Knob – 1 1/4"
256LB 848LB (shown)	Knob – 1 1/4" Knob – 1 3/8"
875AB (shown)	Knob – 1 3/8"
3443BB (shown) 3423BB (shown)	Knob – 1 3/16" Knob – 1 1/2"
76291R1 (shown) 989R1 (shown) 76294R1 (shown)	Knob – 1 1/4" Knob – 1 3/8" Knob – 1 3/16"
3443GW	Knob – 1 3/16"
3443MB	Knob – 1 3/16"

Pack type information can be located in the Product Index that begins on page 213.



69268
1 5/16" dia.



14243
1 1/4" dia.



848LB
1 3/8" dia.

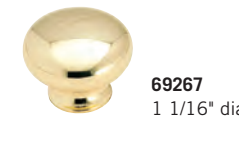

69267
1 1/16" dia.



875AB
1 3/8" dia.



255PB
1 1/4" dia.



989R1
1 3/8" dia.



256PB
1 1/4" dia.



76294R1
1 3/16" dia.



3443BB
1 3/16" dia.



3423BB
1 1/2" dia.



76291R1
1 1/4" dia.

ALLISON™ VALUE HARDWARE

Available Finishes

Finishes may not be available in all styles.

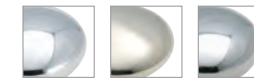

26 SCH CH

A full finish index is located on pages 112-115.

Product Number	Type of Hardware
427126 (shown)	Knob – 1 1/4"
14404SCH (shown) 14408SCH (shown) 14403SCH (shown)	Knob – 1 3/16" Knob – 1 11/16" Knob – 1 5/16"
14401CH (shown) 831CH (shown) 973CH (shown)	Knob – 1 1/4" Knob – 1 1/4" Knob – 1 3/16"

Pack type information can be located in the Product Index that begins on page 213.

Available Finish



3

A full finish index is located on pages 112-115.

Product Number	Type of Hardware
544 (shown) 543 (shown)	Knob – 1 1/2" Knob – 1 1/4"

Pack type information can be located in the Product Index that begins on page 213.



427126
1 1/4" dia.



14404SCH
1 3/16" dia.



14408SCH
1 11/16" length



14403SCH
1 5/16" dia.



14401CH
1 1/4" dia.



831CH
1 1/4" dia.



973CH
1 3/16" dia.



544
1 1/2" dia.



543
1 1/4" dia.

ALLISON™ VALUE HARDWARE

Available Finishes

Finishes may not be available in all styles.



3 BB

A full finish index is located on pages 112-115.

Product Number	Type of Hardware
7593 <i>(shown)</i>	Backplate Pull – 3"
7603 <i>(shown)</i>	Backplate Knob – 1 3/4"
3426BB <i>(shown)</i>	Backplate Pull – 3"
3444BB <i>(shown)</i>	Backplate Knob – 3 11/16"

Pack type information can be located in the Product Index that begins on page 213.



7593
3" ctr.



3426BB
3" ctr.

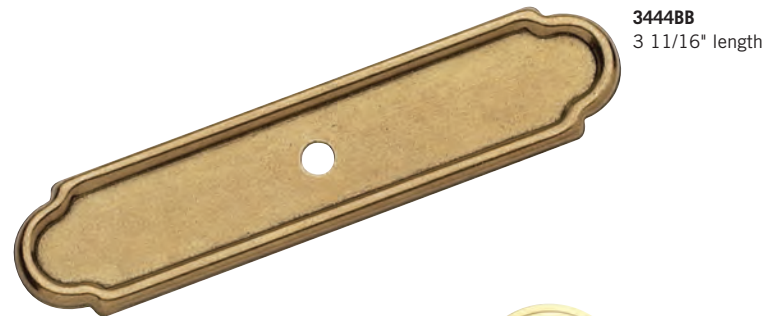

3444BB
3 11/16" length



7603
1 3/4" dia.

Available Finish



AB

A full finish index is located on pages 112-115.

Product Number	Type of Hardware
1355AB <i>(shown)</i>	Knob – 1 3/8"
1356AB <i>(shown)</i>	Backplate – 2"

Pack type information can be located in the Product Index that begins on page 213.



1355AB
1 3/8" dia.



1356AB
2" dia.

ALLISON™ VALUE HARDWARE

Available Finishes

Finishes may not be available in all styles.



AE BB

A full finish index is located on pages 112-115.

Product Number	Type of Hardware
176CAE <i>(shown)</i>	Pull – 3"
735AE	Pull – 3"
3424BB <i>(shown)</i>	Pull – 3"

Pack type information can be located in the Product Index that begins on page 213.



176CAE
3" ctr.



3424BB
3" ctr.

Available Finish



AE

A full finish index is located on pages 112-115.

Product Number	Type of Hardware
876AE <i>(shown)</i>	Pull – 3"
886AE <i>(shown)</i>	Knob – 1"

Pack type information can be located in the Product Index that begins on page 213.



876AE
3" ctr.



886AE
1" dia.

ALLISON™ VALUE HARDWARE

Available Finishes

Finishes may not be available in all styles.



AE ABS BB

A full finish index is located on pages 112-115.

Product Number	Type of Hardware
152AE (shown)	Pull – 3"
70612AE (shown)	Pull – 2 1/2"
766AE (shown)	Pull – 2 1/2"
768AE (shown)	Pull – 2 3/4"
573ABS (shown)	Pull – 3"
802ABS (shown)	Pull – 3"
3425BB (shown)	Pull – 3"

Pack type information can be located in the Product Index that begins on page 213.



152AE
3" ctr.



573ABS
3" ctr.



802ABS
3" ctr.



3425BB
3" ctr.



70612AE
2 1/2" ctr.



768AE
2 3/4" ctr.



766AE
2 1/2" ctr.

ALLISON™ VALUE HARDWARE

Available Finishes



AE ABS

A full finish index is located on pages 112-115.

Product Number	Type of Hardware
888AE (shown)	Knob – 1 3/8"
888ABS (shown)	Knob – 1 1/2"

Pack type information can be located in the Product Index that begins on page 213.

Available Finish



263

A full finish index is located on pages 112-115.

Product Number	Type of Hardware
1964263 (shown)	Pull – 3"

Pack type information can be located in the Product Index that begins on page 213.



888AE
1 3/8" dia.



888ABS
1 1/2" dia.



1964263
3" ctr.

ALLISON™ VALUE HARDWARE

Available Finish



BB

A full finish index is located on pages 112-115.

Product Number	Type of Hardware
----------------	------------------

861BB <i>(shown)</i>	Pull – 3"
862BB <i>(shown)</i>	Knob – 1 1/4"

Pack type information can be located in the Product Index that begins on page 213.

Available Finishes

Finishes may not be available in all styles.



LB ABS 30 26W BC



W3

A full finish index is located on pages 112-115.

Product Number	Type of Hardware
----------------	------------------

885LB <i>(shown)</i>	Knob – 1 1/4"
879ABS <i>(shown)</i>	Knob – 1 1/4"
69228 <i>(shown)</i>	Knob – 1 1/4"
72730 <i>(shown)</i>	Knob – 1 1/4"
7624626W	Knob – 1 1/4"
1956BC <i>(shown)</i>	Knob – 1 1/4"
76246W3 <i>(shown)</i>	Knob – 1 1/4"

Pack type information can be located in the Product Index that begins on page 213.



861BB
3" ctr.



862BB
1 1/4" dia.



885LB
1 1/4" dia.



879ABS
1 1/4" dia.



69228
1 1/4" dia.



72730
1 1/4" dia.



1956BC
1 1/4" dia.



76246W3
1 1/4" dia.

ALLISON™ VALUE HARDWARE

Available Finishes

Finishes may not be available in all styles.



AB WPB FWB WB FWP



OB O3 OLB PBOK OPB



W3

A full finish index is located on pages 112-115.

Product Number	Type of Hardware
----------------	------------------

76245AB	Pull – 3"
245WPB	Pull – 3"
14222WPB <i>(shown)</i>	Pull – 3"
69141 <i>(shown)</i>	Pull – 3"
76245WB	Pull – 3"
245FWP <i>(shown)</i>	Pull – 3"
762430B	Pull – 3"
762450B	Pull – 3"
7624503	Pull – 3"
2450LB	Pull – 3"
1925PBOK <i>(shown)</i>	Pull – 3"
69143 <i>(shown)</i>	Pull – 3"
2660PB <i>(shown)</i>	Pull – 3"
76245W3	Pull – 3"

Pack type information can be located in the Product Index that begins on page 213.



245FWP
3" ctr.



14222WPB
3" ctr.



69141
3" ctr.



1925PBOK
3" ctr.



69143
3" ctr.



2660PB
3" ctr.

ALLISON™ VALUE HARDWARE

Available Finishes

Finishes may not be available in all styles.



A full finish index is located on pages 112-115.

Product Number	Type of Hardware
76244AB	Knob – 1 1/4"
14351WCH <i>(shown)</i>	Knob – 1 3/16"
262WCH	Knob – 1 1/4"
244WPB <i>(shown)</i>	Knob – 1 1/4"
262WPB <i>(shown)</i>	Knob – 1 1/4"
76244WB	Knob – 1 1/4"
244FWP	Knob – 1 1/4"
76244OB	Knob – 1 1/4"
76244O3	Knob – 1 1/4"
2650PB <i>(shown)</i>	Knob – 1 1/4"
7624426W <i>(shown)</i>	Knob – 1 1/4"
76244W3	Knob – 1 1/4"

Pack type information can be located in the Product Index that begins on page 213.

Available Finishes



30G 30B

A full finish index is located on pages 112-115.

Product Number	Type of Hardware
95130G <i>(shown)</i>	Knob – 1 3/16"
95130B	Knob – 1 3/16"

Pack type information can be located in the Product Index that begins on page 213.



244WPB
1 1/4" dia.



262WPB
1 1/4" dia.



2650PB
1 1/4" dia.



7624426W
1 1/4" dia.



14351WCH
1 3/16" dia.



95130G
1 3/16" dia.

ALLISON™ VALUE HARDWARE

Available Finish



26W

A full finish index is located on pages 112-115.

Product Number	Type of Hardware
7624226W <i>(shown)</i>	Pull – 3"
7624526W <i>(shown)</i>	Pull – 3"

Pack type information can be located in the Product Index that begins on page 213.

Available Finishes

Finishes may not be available in all styles.



WCH 30G

A full finish index is located on pages 112-115.

Product Number	Type of Hardware
263WCH	Pull – 3"
26330G <i>(shown)</i>	Pull – 3"

Pack type information can be located in the Product Index that begins on page 213.

Available Finish



MB

A full finish index is located on pages 112-115.

Product Number	Type of Hardware
853MB <i>(shown)</i>	Knob – 1 3/16"

Pack type information can be located in the Product Index that begins on page 213.



7624226W
3" ctr.



7624526W
3" ctr.



26330G
3" ctr.

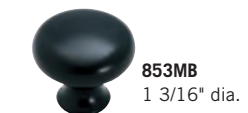

853MB
1 3/16" dia.

ALLISON™ VALUE HARDWARE

Available Finishes

Finishes may not be available in all styles.

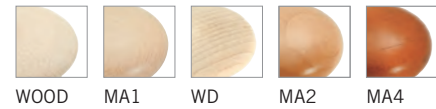

A full finish index is located on pages 112-115.

Product Number	Type of Hardware
937 <i>(shown)</i>	Pull – 3"
928 <i>(shown)</i>	Knob – 2 1/2"
926 <i>(shown)</i>	Knob – 1 3/4"
932 <i>(shown)</i>	Knob – 1"
934 <i>(shown)</i>	Knob – 1 1/2"
933 <i>(shown)</i>	Knob – 1 1/4"
880MA1 <i>(shown)</i>	Knob – 1 1/2"
845WD <i>(shown)</i>	Pull – 3 1/2"
847WD <i>(shown)</i>	Pull – 96mm
814WD <i>(shown)</i>	Knob – 2"
813WD <i>(shown)</i>	Knob – 1 1/2"
811WD <i>(shown)</i>	Knob – 1 1/4"
812WD <i>(shown)</i>	Knob – 1"
880MA2	Knob – 1 1/2"
880MA4	Knob – 1 1/2"

Pack type information can be located in the Product Index that begins on page 213.



ALLISON™ VALUE HARDWARE

Available Finishes

Finishes may not be available in all styles.



A full finish index is located on pages 112-115.

Product Number	Type of Hardware
1920W <i>(shown)</i>	Knob – 1 1/2"
14221WHT <i>(shown)</i>	Knob – 1 3/8"
14204WHT <i>(shown)</i>	Knob – 1 1/4"
14224WHT <i>(shown)</i>	Knob – 1 3/8"
902WHT <i>(shown)</i>	Knob – 1 1/4"
217WHT <i>(shown)</i>	Knob – 1 1/2"
5322GC	Knob – 1 1/2"
217BON	Knob – 1 1/2"
14202AL <i>(shown)</i>	Knob – 1 1/4"
217HGR	Knob – 1 1/2"
902BLK	Knob – 1 1/4"
217BLK	Knob – 1 1/2"

Pack type information can be located in the Product Index that begins on page 213.



ALLISON™ VALUE HARDWARE

Available Finishes

Finishes may not be available in all styles.



DEL WHT AL

A full finish index is located on pages 112-115.

Product Number	Type of Hardware
----------------	------------------

221DEL (shown)	Knob – 1 1/2"
----------------	---------------

221WHT (shown)	Knob – 1 1/2"
----------------	---------------

69125 (shown)	Knob – 1 1/2"
---------------	---------------

69120 (shown)	Knob – 1 1/4"
---------------	---------------

226WHT (shown)	Knob – 1 1/4"
----------------	---------------

69128 (shown)	Knob – 1 1/2"
---------------	---------------

Pack type information can be located in the Product Index that begins on page 213.



ALLISON™ VALUE HARDWARE

Available Finishes

Finishes may not be available in all styles.



W 54 PW WHT PA

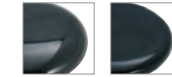

BJ PBK

A full finish index is located on pages 112-115.

Product Number	Type of Hardware
----------------	------------------

977W (shown)	Pull – 3"
--------------	-----------

543254 (shown)	Pull – 96mm
----------------	-------------

543354 (shown)	Pull – 96mm
----------------	-------------

537354 (shown)	Pull – 3"
----------------	-----------

531454 (shown)	Knob – 1 13/16"
----------------	-----------------

532154 (shown)	Knob – 1 3/16"
----------------	----------------

532254 (shown)	Knob – 1 1/2"
----------------	---------------

803PW (shown)	Pull – 3"
---------------	-----------

802PW (shown)	Knob – 1 1/4"
---------------	---------------

232WHT (shown)	Knob – 1 1/4"
----------------	---------------

231WHT (shown)	Knob – 1"
----------------	-----------

802PA	Knob – 1 1/4"
-------	---------------

5432BJ	Pull – 96mm
--------	-------------

5322BJ	Knob – 1 1/2"
--------	---------------

803PBK	Pull – 3"
--------	-----------

802PBK	Knob – 1 1/4"
--------	---------------

Pack type information can be located in the Product Index that begins on page 213.





Featured Here:
 Atherly Decorative Cabinet Hardware in Oil-Rubbed
 Bronze, shown with Clarendon Bath Hardware in
 Oil-Rubbed Bronze.



BATH HARDWARE

INTRODUCTION
 P. 154

FINISH INDEX
 P. 156

PRODUCT LISTING
 P. 157

SILVER TONES



26

Polished Chrome



PN

Polished Nickel



G10

Satin Nickel



SS

Stainless Steel



AS

Antique Silver

GOLD TONES



BBZ

Brushed Bronze



GB

Gilded Bronze

RUSTIC TONES



CBZ

Carmel Bronze

DARK TONES



ORB

Oil-Rubbed Bronze

CLARENDON™

Available Finishes



26

G10

AS

GB

CBZ



ORB

A full finish index is located on page 156.

Product Number	Type of Hardware
2650526	24" Double Towel Bar
2650426	24" Towel Bar
2650326	18" Towel Bar
2650126	Towel Ring
2650026	Tissue Roll Holder
2650726	Pivoting Double Post Tissue Roll Holder
2650226	Robe Hook
26505G10	24" Double Towel Bar
26504G10	24" Towel Bar
26503G10	18" Towel Bar
26501G10	Towel Ring
26500G10	Tissue Roll Holder
26507G10	Pivoting Double Post Tissue Roll Holder
26502G10	Robe Hook
26505AS (shown)	24" Double Towel Bar
26504AS (shown)	24" Towel Bar
26503AS (shown)	18" Towel Bar
26501AS (shown)	Towel Ring
26500AS (shown)	Tissue Roll Holder
26507AS (shown)	Pivoting Double Post Tissue Roll Holder
26502AS (shown)	Robe Hook
26505GB	24" Double Towel Bar
26504GB	24" Towel Bar
26503GB	18" Towel Bar
26501GB	Towel Ring
26500GB	Tissue Roll Holder
26507GB	Pivoting Double Post Tissue Roll Holder
26502GB	Robe Hook
26505CBZ	24" Double Towel Bar
26504CBZ	24" Towel Bar
26503CBZ	18" Towel Bar
26501CBZ	Towel Ring
26500CBZ	Tissue Roll Holder
26507CBZ	Pivoting Double Post Tissue Roll Holder
26502CBZ	Robe Hook
26505ORB	24" Double Towel Bar
26504ORB	24" Towel Bar
26503ORB	18" Towel Bar
26501ORB	Towel Ring
26500ORB	Tissue Roll Holder
26507ORB	Pivoting Double Post Tissue Roll Holder
26502ORB	Robe Hook

Coordinates well with Transitional Cabinet Hardware that begins on page 12.

Pack type information can be located in the Product Index that begins on page 213.



26505AS
24" Double Towel Bar



26504AS
24" Towel Bar



26503AS
18" Towel Bar



26501AS
Towel Ring



26500AS
Tissue Roll Holder



26507AS
Pivoting Double Post
Tissue Roll Holder



26502AS
Robe Hook

SAYBROOK™

Available Finish



G10

A full finish index is located on page 156.

Product Number	Type of Hardware
26534G10 <i>(shown)</i>	24" Towel Bar
26533G10 <i>(shown)</i>	18" Towel Bar
26531G10 <i>(shown)</i>	Towel Ring
26530G10 <i>(shown)</i>	Tissue Roll Holder
26537G10 <i>(shown)</i>	Double Post Tissue Roll Holder
26532G10 <i>(shown)</i>	Robe Hook

Coordinates well with Transitional Cabinet Hardware that begins on page 12.

Pack type information can be located in the Product Index that begins on page 213.



26534G10
24" Towel Bar



26533G10
18" Towel Bar



26531G10
Towel Ring



26530G10
Tissue Roll Holder



26537G10
Double Post
Tissue Roll Holder



26532G10
Robe Hook

ARRONDI™

Available Finishes



SS



BBZ

A full finish index is located on page 156.

Product Number	Type of Hardware
26545SS	24" Double Towel Bar
26544SS	24" Towel Bar
26543SS	18" Towel Bar
26546SS	9" Towel Bar
26541SS	Towel Ring
26540SS	Tissue Roll Holder
26542SS	Robe Hook
26545BBZ <i>(shown)</i>	24" Double Towel Bar
26544BBZ <i>(shown)</i>	24" Towel Bar
26543BBZ <i>(shown)</i>	18" Towel Bar
26546BBZ <i>(shown)</i>	9" Towel Bar
26541BBZ <i>(shown)</i>	Towel Ring
26540BBZ <i>(shown)</i>	Tissue Roll Holder
26542BBZ <i>(shown)</i>	Robe Hook

Coordinates well with Contemporary Cabinet Hardware that begins on page 28.

Pack type information can be located in the Product Index that begins on page 213.



26545BBZ
24" Double Towel Bar



26544BBZ
24" Towel Bar



26543BBZ
18" Towel Bar



26546BBZ
9" Towel Bar



26541BBZ
Towel Ring



26540BBZ
Tissue Roll Holder



26542BBZ
Robe Hook

Available Finishes



PN



ORB

A full finish index is located on page 156.

Product Number	Type of Hardware
26514PN <i>(shown)</i>	24" Towel Bar
26513PN <i>(shown)</i>	18" Towel Bar
26511PN <i>(shown)</i>	Towel Ring
26510PN <i>(shown)</i>	Tissue Roll Holder
26517PN <i>(shown)</i>	Pivoting Double Post Tissue Roll Holder
26512PN <i>(shown)</i>	Robe Hook
26514ORB	24" Towel Bar
26513ORB	18" Towel Bar
26511ORB	Towel Ring
26510ORB	Tissue Roll Holder
26517ORB	Pivoting Double Post Tissue Roll Holder
26512ORB	Robe Hook

Coordinates well with Traditional Cabinet Hardware that begins on page 44.

Pack type information can be located in the Product Index that begins on page 213.



26514PN
24" Towel Bar



26513PN
18" Towel Bar



26511PN
Towel Ring



26510PN
Tissue Roll Holder



26517PN
Pivoting Double Post
Tissue Roll Holder



26512PN
Robe Hook

Available Finish



ORB

A full finish index is located on page 156.

Product Number	Type of Hardware
26524ORB <i>(shown)</i>	24" Towel Bar
26523ORB <i>(shown)</i>	18" Towel Bar
26521ORB <i>(shown)</i>	Towel Ring
26520ORB <i>(shown)</i>	Tissue Roll Holder
26522ORB <i>(shown)</i>	Robe Hook

Coordinates well with Traditional Cabinet Hardware that begins on page 44.

Pack type information can be located in the Product Index that begins on page 213.



26524ORB
24" Towel Bar



26523ORB
18" Towel Bar



26521ORB
Towel Ring



26520ORB
Tissue Roll Holder



26522ORB
Robe Hook



Featured Here:
27" Beveled Hook Rack in Honey Pine
with Oil-Rubbed Bronze Pilltop Hooks.

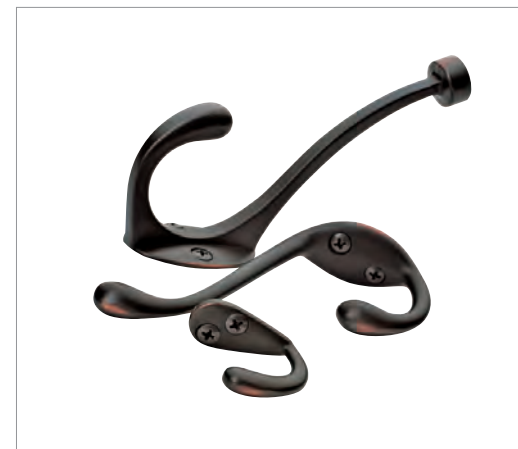

DECORATIVE HOOKS

INTRODUCTION
P. 162

FINISH INDEX
P. 164

PRODUCT LISTING
P. 166

SILVER TONES



26

Polished Chrome



W26

Polished Chrome / White



S

Silver



G10

Satin Nickel



AS

Antique Silver



WW26

White Beadboard with Polished Chrome / White Hooks



WS

White Rack with Silver Hooks



MS

Mahogany Rack with Silver Hooks



WG10

White Rack with Satin Nickel Hooks



MG10

Mahogany Rack with Satin Nickel Hooks



MAS

Mahogany Rack with Antique Silver Hooks

GOLD TONES



BBZ

Brushed Bronze



GB

Gilded Bronze



MBBZ

Mahogany Rack with Brushed Bronze Hooks



HGB

Honey Pine Rack with Gilded Bronze Hooks

RUSTIC TONES



CBZ

Carmel Bronze



HCBZ

Honey Pine Rack with Carmel Bronze Hooks

DARK TONES



ORB

Oil-Rubbed Bronze



HORB

Honey Pine Rack with Oil-Rubbed Bronze Hooks



MORB

Mahogany Rack with Oil-Rubbed Bronze Hooks

COLORS



GW

White



WGW

White Rack with White Hooks

SINGLE HOOKS

Available Finishes

Finishes may not be available in all styles.



A full finish index is located on page 164-165.

Product Number	Type of Hardware
5545726	Double Prong Robe Hook
55469W26 <i>(shown)</i>	Globe Coat and Hat Hook
55440S <i>(shown)</i>	Small Single Prong Hook
55445S <i>(shown)</i>	Medium Coat and Hat Hook
55451S <i>(shown)</i>	Large Coat and Hat Hook
55457S <i>(shown)</i>	Double Prong Robe Hook
55465S <i>(shown)</i>	Pilltop Coat and Hat Hook
55472S <i>(shown)</i>	Contemporary Coat and Hat Hook
55445G10	Medium Coat and Hat Hook
55451G10	Large Coat and Hat Hook
55457G10	Double Prong Robe Hook
55465G10	Pilltop Coat and Hat Hook
55445AS	Medium Coat and Hat Hook
55451AS	Large Coat and Hat Hook
55457AS	Double Prong Robe Hook
55465AS	Pilltop Coat and Hat Hook
55472BBZ	Contemporary Coat and Hat Hook
55445GB	Medium Coat and Hat Hook
55451GB	Large Coat and Hat Hook
55457GB	Double Prong Robe Hook
55465GB	Pilltop Coat and Hat Hook
55445CBZ	Medium Coat and Hat Hook
55451CBZ	Large Coat and Hat Hook
55457CBZ	Double Prong Robe Hook
55440ORB	Small Single Prong Hook
55445ORB	Medium Coat and Hat Hook
55451ORB	Large Coat and Hat Hook
55457ORB	Double Prong Robe Hook
55465ORB	Pilltop Coat and Hat Hook
555445GW	Medium Coat and Hat Hook
55451GW	Large Coat and Hat Hook
55457GW	Double Prong Robe Hook

Pack type information can be located in the Product Index that begins on page 213.



55469W26
Globe Coat and Hat Hook



55465-S
Pilltop Coat and Hat Hook



55472S
Contemporary Coat and Hat Hook



55451S
Large Coat and Hat Hook



55445S
Medium Coat and Hat Hook

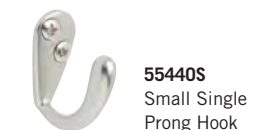

55440S
Small Single Prong Hook



55457S
Double Prong Robe Hook

OVER-THE-DOOR HOOKS

Available Finishes



A full finish index is located on page 164-165.

Product Number	Type of Hardware
55540S	Single Over-the-Door Hook
55548S	Multi Over-the-Door Hook
55540ORB	Single Over-the-Door Hook
55548ORB	Multi Over-the-Door Hook
55540GW <i>(shown)</i>	Single Over-the-Door Hook
55548GW <i>(shown)</i>	Multi Over-the-Door Hook

Pack type information can be located in the Product Index that begins on page 213.



55548GW
Multi Over-the-Door Hook



55540GW
Single Over-the-Door Hook

KEY & GADGET RACKS

Available Finishes



A full finish index is located on page 164-165.

Product Number	Type of Hardware
55590WS	9" Key & Gadget Rack
55590MS <i>(shown)</i>	9" Key & Gadget Rack
55590WG10 <i>(shown)</i>	9" Key & Gadget Rack
55590MAS <i>(shown)</i>	9" Key & Gadget Rack
55590MBBZ <i>(shown)</i>	9" Key & Gadget Rack
55590HGB <i>(shown)</i>	9" Key & Gadget Rack
55590HCBZ <i>(shown)</i>	9" Key & Gadget Rack
55590HORB <i>(shown)</i>	9" Key & Gadget Rack
55590GW <i>(shown)</i>	9" Key & Gadget Rack

Key & Gadget Racks are California Air Research Board certified.
Pack type information can be located in the Product Index that begins on page 213.



55590WG10
9" Key & Gadget Rack



55590MS
9" Key & Gadget Rack



55590MAS
9" Key & Gadget Rack



55590MBBZ
9" Key & Gadget Rack



55590HGB
9" Key & Gadget Rack



55590HCBZ
9" Key & Gadget Rack



55590HORB
9" Key & Gadget Rack



55590GW
9" Key & Gadget Rack

HOOK RACKS

Available Finishes

Finishes may not be available in all styles.



A full finish index is located on page 164-165.

Product Number	Type of Hardware
55646WS	18" Classic Hook Rack
55651WS <i>(shown)</i>	27" Classic Hook Rack
55656WS	18" Beveled Hook Rack
55662WS	27" Beveled Hook Rack
55643MS	18" Contemporary Hook Rack
55640WW26 <i>(shown)</i>	18" Beadboard Hook Rack
55646WG10 <i>(shown)</i>	18" Classic Hook Rack
55656WG10	18" Beveled Hook Rack
55662WG10	27" Beveled Hook Rack
55643MG10	18" Contemporary Hook Rack
55656MAS	18" Beveled Hook Rack
55662MAS	27" Beveled Hook Rack
55643MBBZ <i>(shown)</i>	18" Contemporary Hook Rack
55656HGB <i>(shown)</i>	18" Beveled Hook Rack
55662HGB	27" Beveled Hook Rack
55656HCBZ	18" Beveled Hook Rack
55662HCBZ <i>(shown)</i>	27" Beveled Hook Rack
55656HORB	18" Beveled Hook Rack
55662HORB	27" Beveled Hook Rack
55656MORB	18" Beveled Hook Rack
55662MORB	27" Beveled Hook Rack
55646GW	18" Classic Hook Rack
55651GW	27" Classic Hook Rack

Hook Racks are California Air Research Board certified.
Pack type information can be located in the Product Index that begins on page 213.



55640WW26
18" Beadboard Hook Rack



55646WG10
18" Classic Hook Rack



55651WS
27" Classic Hook Rack



55656HGB
18" Beveled Hook Rack



55662HCBZ
27" Beveled Hook Rack



55643MBBZ
18" Contemporary Rack



Featured Here:
Self Closing Face Mount Hinge in Satin Nickel.



FUNCTIONAL CABINET HARDWARE

INTRODUCTION
P. 170

FINISH INDEX
P. 172

PRODUCT LISTING
P. 174

SILVER TONES



14

Nickel



26

Polished Chrome



2G

"Perma-Brite" Zinc



G9

Sterling Nickel



G10

Satin Nickel



AS

Antique Silver



M26

Machine Chrome



AL

Aluminum



WN

Weathered Nickel

GOLD TONES



3

Polished Brass



PB

Polished Brass



GB

Gilded Bronze



AE

Antique Brass



BB

Burnished Brass



M3

Machine Brass

RUSTIC TONES



AC

Antique Copper

DARK TONES



WI

Wrought Iron



ORB

Oil-Rubbed Bronze



DAE

Dark Antique English



CB

Colonial Black



FB

Flat Black

COLORS



W

White



3W

White



A

Almond



PT

Plastic Tan



3PT

Plastic Tan



BR

Brown



BK

Black

TWO-TONE



AW

Aluminum / Wood Grain

DECORATIVE HARDWARE INSTALLATION TEMPLATES

These new templates take the guesswork out of installation! This easy-to-use solution makes cabinet hardware installation simple and saves time.

Product Number	Description
TMPDOOR <i>(shown)</i>	Cabinet Door Template
TMPDRWR <i>(shown)</i>	Cabinet Drawer Template
TMPMULTI <i>(shown)</i>	Cabinet Door and Drawer Template

Pack type information can be located in the Product Index that begins on page 213.



FULL WRAP

Features

- Choice of overlays from 1/4" to 5/8", plus 3/8" insert application
- Heavy-duty steel construction
- Wide range of mounting options
- Dual-spring mechanism for quiet, consistent self-closing power
- Choice of door wing styles and hole patterns

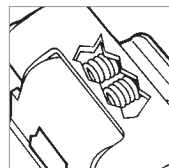

Dual-spring mechanism



Overlays from 1/4" to 5/8"

Choice of door wing styles and hole patterns

Heavy duty steel construction

SELF-CLOSING, FULL WRAP

Available Finish



BB

A full finish index is located on pages 172-173.

Product Number	Overlay
7540BB <i>(shown)</i>	1/2"

Screws: (2) #6 F.H. x 5/8"; (3) #5 F.H. x 1/2"

Pack type information can be located in the Product Index that begins on page 213.



7540BB

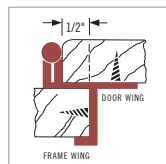
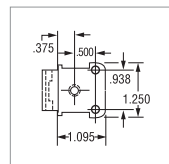
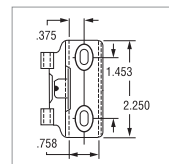

PARTIAL WRAP

Features

- Choice of overlays from 13/64" to 1/2", plus 3/8" inset and reverse bevel applications
- Heavy-duty steel construction
- Wide range of mounting options
- Slotted holes for easy adjustment
- Dual-spring mechanism for quiet, consistent self-closing power
- Choice of door wing styles and hole patterns

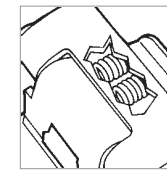

Dual-spring mechanism



Overlays from 13/64" to 1/2"

Slotted holes

Choice of door wing styles and hole patterns

Heavy duty steel construction

SELF-CLOSING, PARTIAL WRAP

Available Finishes



G10 BB ORB

A full finish index is located on pages 172-173.

Product Number	Overlay
7566G10 <i>(shown)</i>	1/4"
7566BB	1/4"
7566ORB	1/4"

Screws: (2) #6 F.H. x 5/8"; (3) #5 F.H. x 1/2"

Pack type information can be located in the Product Index that begins on page 213.



7566G10

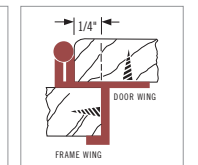
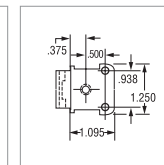
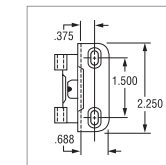

SELF-CLOSING, PARTIAL WRAP

Available Finishes



A full finish index is located on pages 172-173.

Product Number	Overlay
755014	1/2"
7550G10 (shown)	1/2"
7550WN	1/2"
75503	1/2"
7550BB	1/2"
7550WI	1/2"
7550ORB	1/2"
7550FB	1/2"
7550W	1/2"

Screws: (2) #6 F.H. x 5/8"; (3) #5 F.H. x 1/2"
Pack type information can be located in the Product Index that begins on page 213.

Available Finishes

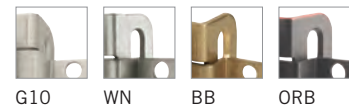

A full finish index is located on pages 172-173.

Product Number	Inset
7565G10	3/8"
7565WN	3/8"
7565BB	3/8"
7565ORB (shown)	3/8"

Screws: (2) #6 T.H. x 5/8"; (3) #6 O.H. x 1/2"
Pack type information can be located in the Product Index that begins on page 213.



7550G10

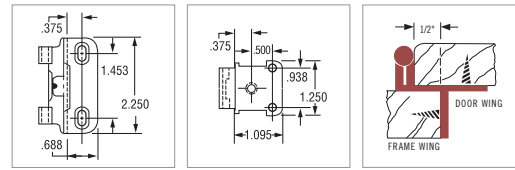

7565ORB

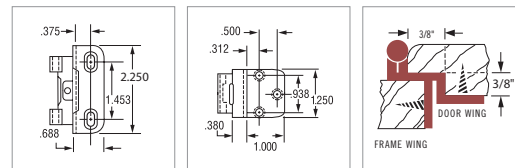

FACE MOUNT

Features

- Traditional, semi-concealed styling
- Choice of frame wing styles to coordinate with decorative hardware
- Reliable, self-closing power of dual compression springs
- Coordinating finishes

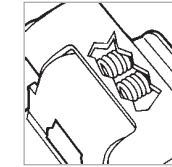

Dual-spring mechanism

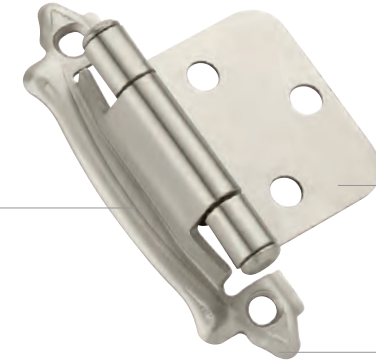

Choice of decorative door wing styles and hole patterns

Variety of decorative frame wing styles

SELF-CLOSING, FACE MOUNT

Available Finish



26'

A full finish index is located on pages 172-173.

Product Number	Overlay
69201' (shown)	Variable

Screws: (2) #6 F.H. x 5/8"; (3) #6 F.H. x 1/2"
Pack type information can be located in the Product Index that begins on page 213.



69201'

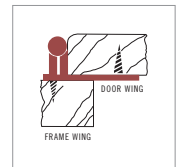

Available Finishes



26

3

AE

BB

A full finish index is located on pages 172-173.

Product Number	Overlay
762926 (shown)	Variable
76293	Variable
7629AE	Variable
7629BB	Variable

Screws: (2) #5 O.H. x 5/8"; (3) #5 F.H. x 1/2"
Pack type information can be located in the Product Index that begins on page 213.



762926

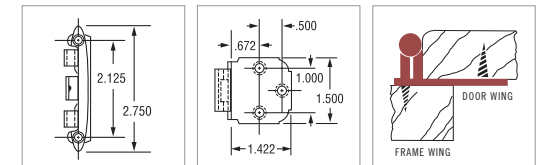

SELF-CLOSING, FACE MOUNT

Available Finishes

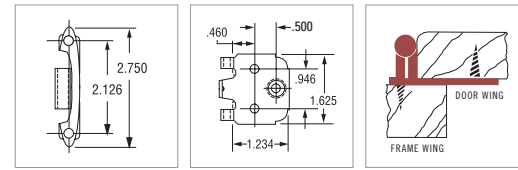

A full finish index is located on pages 172-173.

Product Number	Overlay
713914	Variable
7139G10	Variable
71393	Variable
7139BB	Variable
7139WI	Variable
71390RB (shown)	Variable
7139BK	Variable
7139W	Variable

Screws: (2) #6 O.H. x 5/8"; (3) #6 F.H. x 1/2"

Pack type information can be located in the Product Index that begins on page 213.

Available Finishes

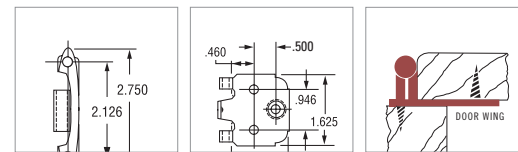
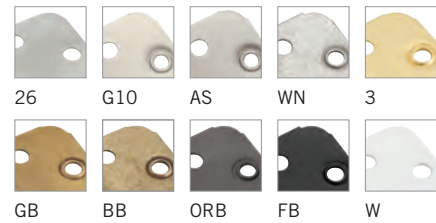

A full finish index is located on pages 172-173.

Product Number	Overlay
342926	Variable
3429G10	Variable
3429AS	Variable
3429WN	Variable
34293	Variable
3429GB	Variable
3429BB	Variable
3429ORB	Variable
3429FB (shown)	Variable
3429W	Variable

Screws: (2) #6 O.H. x 5/8"; (3) #6 F.H. x 1/2"

Pack type information can be located in the Product Index that begins on page 213.

SELF-CLOSING, FACE MOUNT

Available Finishes

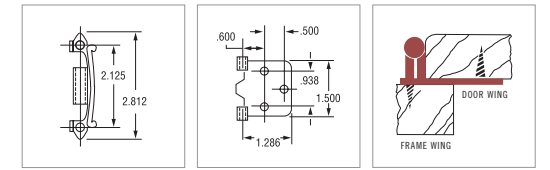
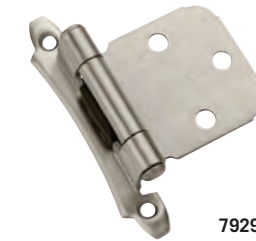

A full finish index is located on pages 172-173.

Product Number	Overlay
792926	Variable
7929G10 (shown)	Variable
79293	Variable
7929AE	Variable
7929BB	Variable
7929ORB	Variable

Screws: (2) #5 O.H. x 5/8"; (3) #5 F.H. x 1/2"

Pack type information can be located in the Product Index that begins on page 213.

Available Finishes

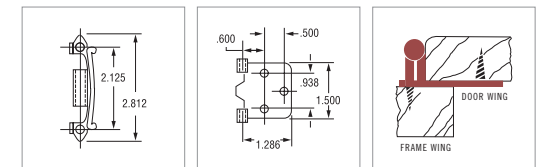

A full finish index is located on pages 172-173.

Product Number	Overlay
7329G9	Variable
7329G10	Variable
73290RB (shown)	Variable

Screws: (2) #5 O.H. x 5/8"; (3) #5 F.H. x 1/2"

Pack type information can be located in the Product Index that begins on page 213.

SELF-CLOSING, FACE MOUNT

Available Finishes



A full finish index is located on pages 172-173.

Product Number	Overlay
763026	Variable
76303 (shown)	Variable
7630AE	Variable
7630BB	Variable
7630AC	Variable

Screws: (5) #5 O.H. x 5/8"

Pack type information can be located in the Product Index that begins on page 213.

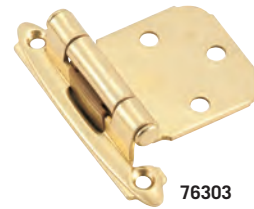

76303

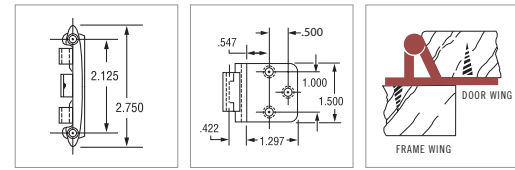

Available Finishes

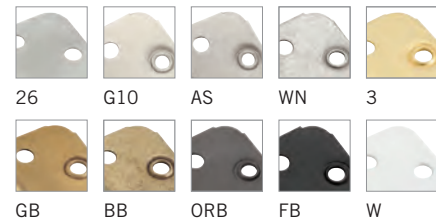

A full finish index is located on pages 172-173.

Product Number	Inset
342826	3/8"
3428G10	3/8"
3428AS	3/8"
3428WN	3/8"
34283	3/8"
3428GB	3/8"
3428BB	3/8"
3428ORB	3/8"
3428FB (shown)	3/8"
3428W	3/8"

Screws: (5) #6 O.H. x 5/8"

Pack type information can be located in the Product Index that begins on page 213.



3428FB

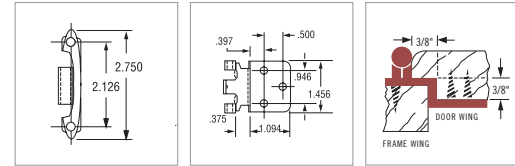

SELF-CLOSING, FACE MOUNT

Available Finishes



A full finish index is located on pages 172-173.

Product Number	Inset
7128G10	3/8"
71283	3/8"
7128BB	3/8"
7128WI	3/8"
71280RB (shown)	3/8"
7128BK	3/8"
7128W	3/8"

Screws: (5) #6 O.H. x 5/8"

Pack type information can be located in the Product Index that begins on page 213.



71280RB

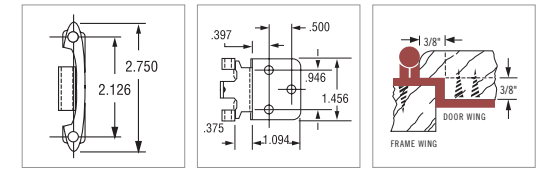

Available Finishes



A full finish index is located on pages 172-173.

Product Number	Inset
7328G9	3/8"
7328AE (shown)	3/8"
7328AC	3/8"

Screws: (5) #5 O.H. x 5/8"

Pack type information can be located in the Product Index that begins on page 213.



7328AE

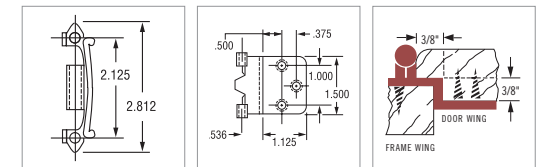

SELF-CLOSING, FACE MOUNT

Available Finishes

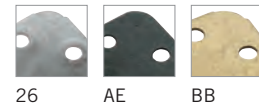

26 AE BB

A full finish index is located on pages 172-173.

Product Number	Inset
----------------	-------

762826	3/8"
--------	------

7628AE	3/8"
--------	------

7628BB (shown)	3/8"
-----------------------	-------------

Screws: (5) #5 O.H. x 5/8"

Pack type information can be located in the Product Index that begins on page 213.



7628BB

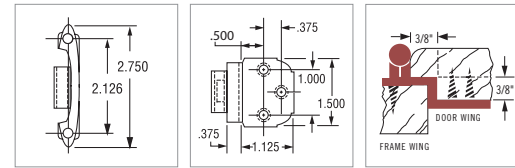

Available Finishes



26 G10 3 AE BB

ORB

A full finish index is located on pages 172-173.

Product Number	Inset
----------------	-------

792826	3/8"
--------	------

7928G10 (shown)	3/8"
------------------------	-------------

79283	3/8"
-------	------

7928AE	3/8"
--------	------

7928BB	3/8"
--------	------

7928ORB	3/8"
---------	------

Screws: (5) #5 O.H. x 5/8"

Pack type information can be located in the Product Index that begins on page 213.

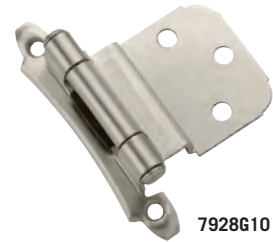

7928G10

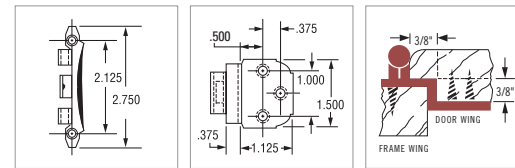

DOUBLE DEMOUNTABLE

Features

- Reduce labor by simple one-step routing
- Easy mounting – hinge slips into pre-routed slots
- Choice of overlays from 1/4" – 1/2", including 3/8" inset
- Double demountable hinges feature clamping plates, which clamp the hinge to both the door and the frame stile
- Heavy-duty steel construction
- Full 3-way adjustability
- Easily adjust and correct a warped door or a twisted cabinet problem
- Coordinating finishes

One-screw adjustment

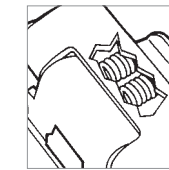

Overlays from 1/4" to 1/2"

Specially-angled clamps for reliable holding power

Easy-clamping mechanism

Dual-spring mechanism

Heavy-duty steel construction

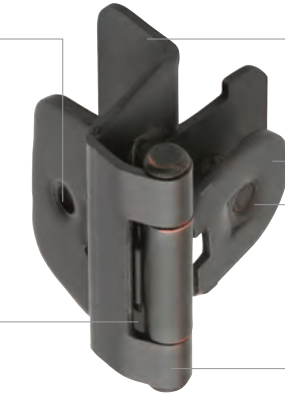

3-Way Adjustment

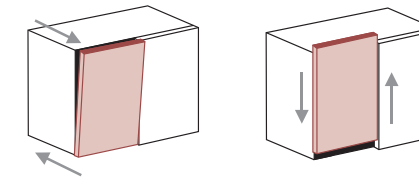

In-Out Adjustment

Vertical Adjustment

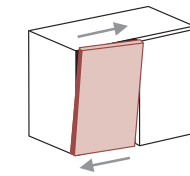

Horizontal Adjustment

DOUBLE DEMOUNTABLE

Available Finishes



G9 G10 3 BB ORB

A full finish index is located on pages 172-173.

Product Number	Overlay
8701G9	1/4"
8701G10 (shown)	1/4"
87013	1/4"
8701BB	1/4"
8701ORB	1/4"

Pack type information can be located in the Product Index that begins on page 213.



8701G10

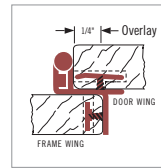

Available Finishes



14 G9 G10 AE BB

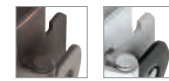

ORB W

A full finish index is located on pages 172-173.

Product Number	Overlay
870414	1/2"
8704G9	1/2"
8704G10	1/2"
8704AE	1/2"
8704BB	1/2"
8704ORB	1/2"
8704W (shown)	1/2"

Pack type information can be located in the Product Index that begins on page 213.



8704W

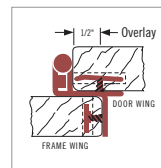

DOUBLE DEMOUNTABLE

Available Finishes



G9 G10 AE BB ORB

A full finish index is located on pages 172-173.

Product Number	Inset
8700G9 (shown)	3/8"
8700G10	3/8"
8700AE	3/8"
8700BB	3/8"
8700ORB	3/8"

Pack type information can be located in the Product Index that begins on page 213.



8700G9

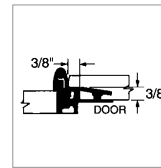

SINGLE DEMOUNTABLE

Features

- Choice of overlays from 13/32" – 1/2", plus 3/8" inset
- Heavy-duty steel construction
- Wide range of mounting options
- Dual-spring mechanism for quiet, consistent self-closing power

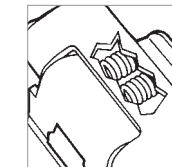

Dual-spring mechanism



Overlays from 13/32" to 1/2"

Frame wing slots for easy adjustment

Specially-angled clamps for reliable holding power

Heavy duty steel construction

SINGLE DEMOUNTABLE, PARTIAL WRAP

Available Finish



14

A full finish index is located on pages 172-173.

Product Number	Overlay
----------------	---------

871514 (shown)	1/4"
----------------	------

Screws: (2) #6 F.H. X 5/8"

Pack type information can be located in the Product Index that begins on page 213.



871514

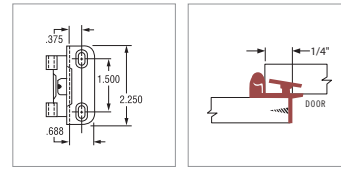

Available Finishes



14 G10 3 BB ORB

A full finish index is located on pages 172-173.

Product Number	Overlay
----------------	---------

871914	1/2"
--------	------

8719G10	1/2"
---------	------

87193	1/2"
-------	------

8719BB	1/2"
--------	------

8719ORB (shown)	1/2"
-----------------	------

Screws: (2) #6 F.H. X 5/8"

Pack type information can be located in the Product Index that begins on page 213.



8719ORB

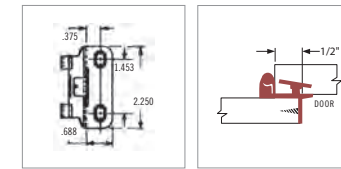

FACE MOUNT

Features

- Choice of frame wing styles and finishes to coordinate with decorative hardware
- Numerous style and application options, such as flush, offset or inset mounting, or overlay
- High strength steel



Choice of frame wing styles

Choice of door wing styles and hole patterns

NON SELF-CLOSING, FACE MOUNT

Available Finishes



G9 3 BB

A full finish index is located on pages 172-173.

Product Number	Overlay
----------------	---------

7678WNG9	Variable
----------	----------

76783 (shown)	Variable
---------------	----------

7678BB	Variable
--------	----------

Screws: (2) #5 O.H. x 5/8"; (3) #5 F.H. x 1/2"

Pack type information can be located in the Product Index that begins on page 213.



76783

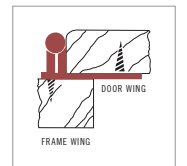

Available Finishes



26¹ BB³

A full finish index is located on pages 172-173.

Product Number	Overlay
----------------	---------

69191 ¹	Variable
--------------------	----------

69192 ² (shown)	Variable
----------------------------	----------

Screws: (2) #5 O.H. x 5/8"; (3) #5 F.H. x 1/2"

Pack type information can be located in the Product Index that begins on page 213.



69192³

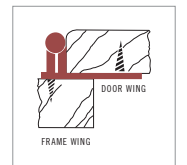

NON SELF-CLOSING, FACE MOUNT

Available Finishes



26 G10 3 ORB

A full finish index is located on pages 172-173.

Product Number	Inset
----------------	-------

341726	3/8"
--------	------

3417G10	3/8"
---------	------

34173	3/8"
-------	------

34170RB (shown)	3/8"
------------------------	-------------

Screws: (2) #5 O.H. x 5/8"; (3) #5 F.H. x 1/2"

Pack type information can be located in the Product Index that begins on page 213.



34170RB

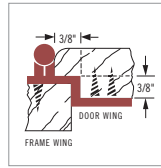

Available Finishes



26¹ 3² BB³

A full finish index is located on pages 172-173.

Product Number	Inset
----------------	-------

69194 ¹	3/8"
--------------------	------

69193² (shown)	3/8"
----------------------------------	-------------

69195 ³	3/8"
--------------------	------

Screws: (2) #5 O.H. x 5/8"; (3) #5 F.H. x 1/2"

Pack type information can be located in the Product Index that begins on page 213.



69193²

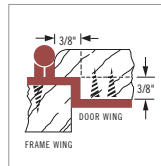

NON SELF-CLOSING, ADJUSTABLE

Available Finishes



AE DAE

A full finish index is located on pages 172-173.

Product Number	Inset
----------------	-------

7687MAE (shown)	3/8"
------------------------	-------------

7687MDAE	3/8"
----------	------

Screws: (5) #6 O.H. x 5/8"

Pack type information can be located in the Product Index that begins on page 213.



7687AE

NON SELF-CLOSING

Available Finish



AE

A full finish index is located on pages 172-173.

Product Number	Inset
----------------	-------

7538AE (shown)	3/8"
-----------------------	-------------

Screws: (2) #5 O.H. x 5/8"; (3) #5 F.H. x 1/2"

Pack type information can be located in the Product Index that begins on page 213.

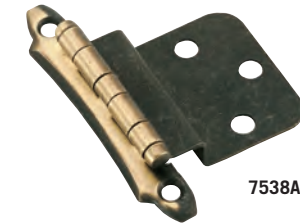

7538AE

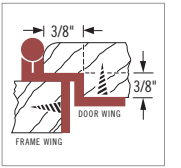

NON SELF-CLOSING, BUTT HINGE

Available Finish



AE

A full finish index is located on pages 172-173.

Product Number	Wrap
----------------	------

2335AE (shown)	—
-----------------------	---

Screws: (4) #5 F.H. x 1/2"

1 1/2" Joint x 1 1/2" Width

Pack type information can be located in the Product Index that begins on page 213.



2335AE

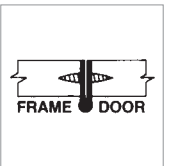

Available Finish



AE

A full finish index is located on pages 172-173.

Product Number	Wrap
----------------	------

2355AE (shown)	—
-----------------------	---

Screws: (6) #5 F.H. x 5/8"

2" Joint x 1 3/8" Width

Pack type information can be located in the Product Index that begins on page 213.



2355AE

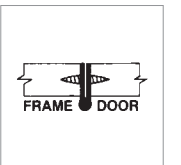

NON SELF-CLOSING, "H" HINGE

Available Finishes



AC CB

A full finish index is located on pages 172-173.

Product Number	
3404AC	Flush
3404CB (shown)	Flush

Screws: (6) #6 P.Y.H. x 5/8"
Pack type information can be located in the Product Index that begins on page 213.



3404CB

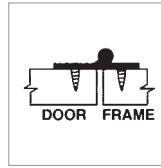

Available Finish



AC

A full finish index is located on pages 172-173.

Product Number	Offset
3406AC (shown)	3/8"

Screws: (4) #6 P.Y.H. x 5/8"
Pack type information can be located in the Product Index that begins on page 213.



3406AC

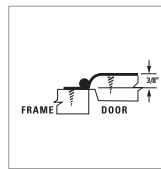

Available Finish



AE

A full finish index is located on pages 172-173.

Product Number	
1670AE (shown)	Flush

Screws: (6) #6 P.Y.H. x 5/8"
Pack type information can be located in the Product Index that begins on page 213.



1670AE

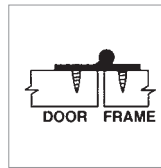

Available Finish



AE

A full finish index is located on pages 172-173.

Product Number	Offset
1672AE (shown)	3/8"

Screws: (6) #6 P.Y.H. x 5/8"
Pack type information can be located in the Product Index that begins on page 213.



1672AE

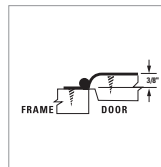

FULL WRAP & PARTIAL WRAP

Features

- Minaret and ball finial tips provide elegant accents
- Exclusive pin treatment assures silent reliable performance
- Patented angled set hold simplifies installation; easy horizontal/vertical adjustment
- Door gap as small as 1/16"
- Designed with interlevered wings to minimize door gap and eliminate the need to mortise the door frame

Vertical adjustment
± 1/16"

Patented angled
set-screw hole

Vertical adjustment
± 1/16"



Horizontal adjustment
+ 1/16"

Horizontal adjustment
± 1/16"

Decorative Pin

FULL INSET, FULL WRAP, BALL TIP

Available Finishes



G9 G10 AE WI ORB



DAE FB

A full finish index is located on pages 172-173.

Product Number	Door Thickness
3175TBG9	3/4"
3175TBG10	3/4"
3175TBPB	3/4"
3175TBAE	3/4"
3175TBWI	3/4"
3175TBORB (shown)	3/4"
3175TBD AE	3/4"
3175TBFB	3/4"

Screws: (3) #6 F.H. x 5/8"; (4) #6 F.H. x 1/2"
Pack type information can be located in the Product Index that begins on page 213.



3175TBORB

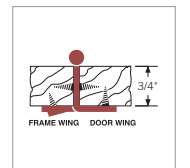

FULL INSET, FULL WRAP, MINARET TIP

Available Finishes

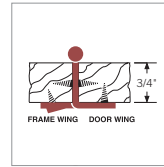

A full finish index is located on pages 172-173.

Product Number	Door Thickness
3175TM14	3/4"
3175TMG9	3/4"
3175TMG10 (shown)	3/4"
3175TMPB	3/4"
3175TMAE	3/4"
3175TMBB	3/4"
3175TMWI	3/4"
3175TMORB	3/4"
3175TMDAE	3/4"
3175TMFB	3/4"

Screws: (3) #6 F.H. x 5/8"; (4) #6 F.H. x 1/2"
Pack type information can be located in the Product Index that begins on page 213.

FULL INSET, PARTIAL WRAP, BALL TIP

Available Finishes

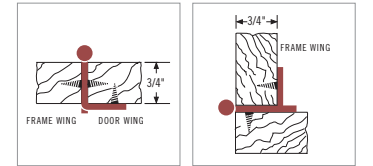

A full finish index is located on pages 172-173.

Product Number	Door Thickness
3180TB14	3/4"
3180TBG9	3/4"
3180TBG10	3/4"
3180TBAE	3/4"
3180TBBB	3/4"
3180TBWI (shown)	3/4"
3180TBORB	3/4"
3180TBDAE	3/4"
3180TBFB	3/4"

Screws: (2) #6 O.H. x 5/8"; (4) #6 F.H. x 1/2"
Pack type information can be located in the Product Index that begins on page 213.

FULL INSET, PARTIAL WRAP, MINARET TIP

Available Finish



DAE

A full finish index is located on pages 172-173.

Product Number	Door Thickness
3180UBDAE (shown)	13/16"

Screws: (2) #6 O.H. x 5/8"; (4) #6 F.H. x 1/2"
Pack type information can be located in the Product Index that begins on page 213.

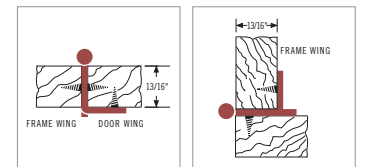

FULL INSET, PARTIAL WRAP, MINARET TIP

Available Finishes



A full finish index is located on pages 172-173.

Product Number	Door Thickness
3180TM14	3/4"
3180TMG9 (shown)	3/4"
3180TMG10	3/4"
3180TMPB	3/4"
3180TMAE	3/4"
3180TMBB	3/4"
3180TMWI	3/4"
3180TMORB	3/4"
3180TMDAE	3/4"
3180TMFB	3/4"

Screws: (2) #6 O.H. x 5/8"; (4) #6 F.H. x 1/2"

Pack type information can be located in the Product Index that begins on page 213.



3180TMG9

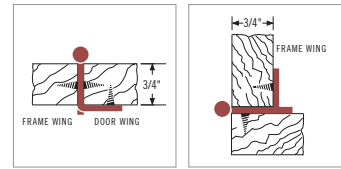

FULL INSET, PARTIAL WRAP

Available Finish



G9

A full finish index is located on pages 172-173.

Product Number	Door Thickness
3180TG9 (shown)	3/4"

Screws: (2) #6 O.H. x 5/8"; (4) #6 F.H. x 1/2"

Pack type information can be located in the Product Index that begins on page 213.



3180TG9

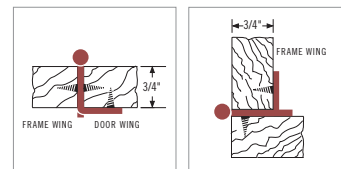

MATRIX™ FACE FRAME CONCEALED

Features

- 2-way or 3-way independent adjustability
- Compact design with low protrusion into Cabinet opening
- Stay open feature
- Choose from a full range of overlay options and hole patterns
- Designed and tested to exceed KCMA and BHMA standards

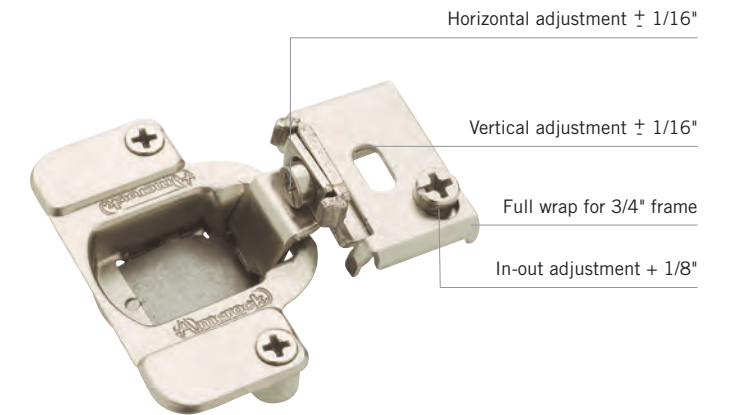

Hole Pattern – 45mm

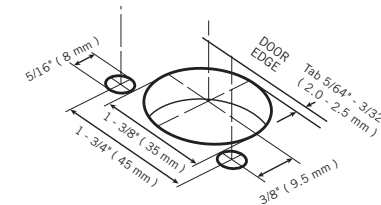

Hole Pattern – 48mm

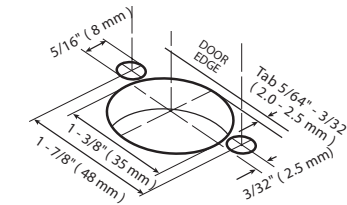

MATRIX™ CONCEALED

Available Finish



14

A full finish index is located on pages 172-173.



2911C1214

Product Number	Overlay	Hole Pattern	Cup Depth	Opening Angle	Adjustment
2911C1214 (shown)	1 1/4"	48mm	13mm	105°	3-way
2911C1314	1 1/4"	45mm	13mm	105°	3-way
2911J2214	1/2"	48mm	11mm	105°	3-way
2911J2314	1/2"	45mm	11mm	105°	3-way

Screws: D packs do not include screws

Pack type information can be located in the Product Index that begins on page 213.

MATRIX™ CONCEALED

Available Finish



14

A full finish index is located on pages 172-173.



2811C1314

Product Number	Overlay	Hole Pattern	Cup Depth	Opening Angle	Adjustment
2811C1314 (shown)	1 1/4"	45mm	13mm	105°	2-way
2811I1214	3/8"	48mm	13mm	105°	2-way
2811J2314	1/2"	45mm	11mm	105°	2-way
2811H1314	1/4"	45mm	13mm	105°	2-way
2811N1214	15/16"	48mm	13mm	105°	2-way

Screws: D packs include 8mm dowels (no screws); BP packs include all mounting screws (no dowels)
Pack type information can be located in the Product Index that begins on page 213.

FRAMELESS CONCEALED

Available Finish



D14

A full finish index is located on pages 172-173.



4613-D14

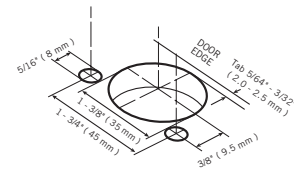

Product Number	Overlay	Hole Pattern	Cup Depth	Opening Angle	Adjustment
4613D14 (shown)	Full	45mm	-	110°	3-way

Screws: BP packs include all mounting screws (no dowels)
Pack type information can be located in the Product Index that begins on page 213.

FRAMELESS CONCEALED

Available Finish



A14

A full finish index is located on pages 172-173.



4611A14

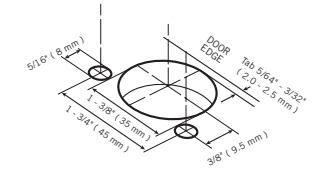

Product Number	Overlay	Hole Pattern	Cup Depth	Opening Angle	Adjustment
4611A14 (shown)	Full	45mm	-	110°	3-way

Screws: BP packs include all mounting screws (no dowels)
Pack type information can be located in the Product Index that begins on page 213.

Available Finish



C14

A full finish index is located on pages 172-173.



7165AC14

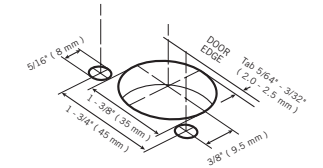

Product Number	Overlay	Hole Pattern	Cup Depth	Opening Angle	Adjustment
7165AC14 (shown)	Full, clip on	45mm	-	165°	3-way

Screws: BP packs include all mounting screws (no dowels)
Pack type information can be located in the Product Index that begins on page 213.

EASY ON

Available Finish



CH

A full finish index is located on pages 172-173.



14951CH

Product Number	Overlay
14951CH (shown)	Variable

Screws: BP and CM packs include all mounting
Screws: D packs do not include screws
Pack type information can be located in the Product Index that begins on page 213.

MARATHON®

Features

- Guaranteed performance – smooth, quiet and trouble free
- Exceeds 250,000 cycles – outperforms conventional knife hinges and KCMA standards
- Reliable self-closing force – outlasts conventional knife hinges
- Cuts should be made with a #6 dado 9/32" W

Locating tabs allow quick positioning on frame

Vertical adjustment $\pm 1/16"$

Horizontal adjustment $\pm 1/16"$

High-strength steel frame wings for overlays 1/4" to 1/2"

Revolutionary DuraFlex™ action for long life

Full 180° opening

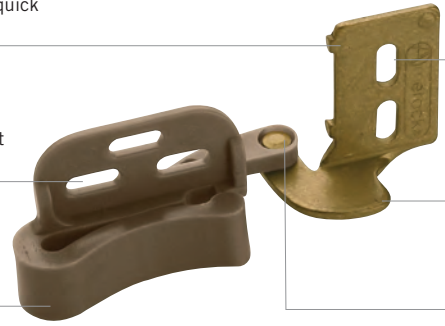

MARATHON®, PARTIAL WRAP

Available Finish



W

A full finish index is located on pages 172-173.

Product Number	Overlay
2606W (shown)	1/2"

Screws: BP and CM packs include all mounting

Screws: D packs do not include screws

Pack type information can be located in the Product Index that begins on page 213.



2606W

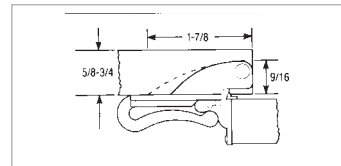

ROLLER CATCHES

Available Finishes



2G A2G

A full finish index is located on pages 172-173.



97142G

Product Number	Pull Force	Length	Width	Height	Strike
97142G (shown)	3-6 lbs.	1 3/16"	1 3/8"	9/16"	Steel; (2G); 1 5/16" L x 1/4" W x 1/2" H
9714A2G	3-6 lbs.	1 3/16"	1 3/8"	9/16"	Steel; (2G); 1 5/16" L x 1/4" W x 1/2" H

Screws: (4) #6 T.H. x 1/2"

Pack type information can be located in the Product Index that begins on page 213.

Available Finish



2G

A full finish index is located on pages 172-173.



34722G

Product Number	Pull Force	Length	Width	Height	Strike
34722G (shown)	3-6 lbs.	1 3/16"	1 3/8"	9/16"	Steel; (2G); 1 5/16" L x 1/4" W x 1/2" H

Screws: (4) #6 T.H. x 1/2"

Pack type information can be located in the Product Index that begins on page 213.

Available Finishes



2G B2G

A full finish index is located on pages 172-173.



98232G

Product Number	Pull Force	Length	Width	Height	Strike
98232G (shown)	–	1 1/4"	1 3/8"	5/8"	Steel; (2G); 1" L x 1 3/8" W x 3/8" H
9823B2G	–	1 1/4"	1 3/8"	5/8"	Steel; (2G); 3/4" L x 1 3/8" W x 3/8" H

Screws: (4) #6 T.H. x 1/2" ; Nail (2) #18 F.H. x 1/2"

Pack type information can be located in the Product Index that begins on page 213.

ROLLER CATCHES

Available Finish



14

A full finish index is located on pages 172-173.



347414

Product Number	Pull Force	Length	Width	Height	Strike
347414 (shown)	5-6 lbs.	1"	15/16"	1/2"	Steel; 1" L x 11/16" W x 3/8" H

Screws: (3) #6 T.H. x 1/2"

Pack type information can be located in the Product Index that begins on page 213.

Available Finish



2G

A full finish index is located on pages 172-173.



97452G

Product Number	Pull Force	Length	Width	Height	Strike
97452G (shown)	5-6 lbs.	1 3/4"	1/8"	7/8"	Steel

Screws: (2) #5 O.H. x 5/8"; (3) #5 F.H. x 1/2"

Pack type information can be located in the Product Index that begins on page 213.

Available Finish



AW

A full finish index is located on pages 172-173.



9753AW

Product Number	Pull Force	Length	Width	Height	Strike
9753AW (shown)	5-10 lbs.	1 1/8"	2"	5/8"	Steel; (AE); 1 1/8" L x 3/4" W

Screws: (2) #6 T.H. x 1/2"; (1) #5 F.H. x 1/2"

Pack type information can be located in the Product Index that begins on page 213.

MAGNETIC CATCHES

Available Finishes

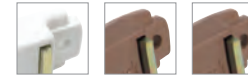

3W

PT

3PT

A full finish index is located on pages 172-173.



9765PT

Product Number	Pull Force	Length	Width	Height	Strike
97653W	5-11 lbs.	1 15/16"	3/4"	11/16"	Steel; 3 strikes; (AE); 1 1/8" L x 7/8" W x 3/4" H
9765PT (shown)	5-11 lbs.	1 15/16"	3/4"	11/16"	Steel; 1 strike; (AE); 1 1/8" L x 7/8" W x 3/4" H
97653PT	5-11 lbs.	1 15/16"	3/4"	11/16"	Steel; 3 strikes; (AE); 1 1/8" L x 7/8" W x 3/4" H

Screws: (2) #6 T.H. x 1/2"; (1) #5 F.H. x 1/2"

Pack type information can be located in the Product Index that begins on page 213.

Available Finishes



W

PT

A full finish index is located on pages 172-173.



9765FW

Product Number	Pull Force	Length	Width	Height	Strike
9765FW (shown)	5-11 lbs.	1 15/16"	3/4"	11/16"	Steel; (AE); 1 1/8" L x 7/8" W x 3/4" H
9765FPT	5-11 lbs.	1 15/16"	3/4"	11/16"	Steel; (AE); 1 1/8" L x 7/8" W x 3/4" H

Screws: (4) #6 T.H. x 1/2"; Nail (1) #15 x 1/2"

Pack type information can be located in the Product Index that begins on page 213.

Available Finish



W

PT

A full finish index is located on pages 172-173.



3473PT

Product Number	Pull Force	Length	Width	Height	Strike
3473W	5-11 lbs.	2"	1 1/8"	1/2"	Steel; (AE); 1 1/8" L x 3/4" W
3473PT (shown)	5-11 lbs.	2"	1 1/8"	1/2"	Steel; (AE); 1 1/8" L x 3/4" W

Screws: (2) #6 T.H. x 1/2"; (1) #5 F.H. x 1/2"

Pack type information can be located in the Product Index that begins on page 213.

MAGNETIC CATCHES

Available Finish



PT

A full finish index is located on pages 172-173.



9773PT

Product Number	Pull Force	Length	Width	Height	Strike
9773PT <i>(shown)</i>	5-11 lbs.	2"	1 1/8"	1/2"	Steel; (AE); 1 1/8" L x 3/4" W

Screws: (2) #6 T.H. x 1/2"; (1) #5 F.H. x 1/2"

Pack type information can be located in the Product Index that begins on page 213.

Available Finish



AL

A full finish index is located on pages 172-173.



9783AL

Product Number	Pull Force	Length	Width	Height	Strike
9783AL <i>(shown)</i>	5-11 lbs.	2"	1"	5/8"	Steel; (AE); 1 1/8" L x 3/4" W

Screws: (2) #6 T.H. x 1/2"; (1) #5 F.H. x 1/2"

Pack type information can be located in the Product Index that begins on page 213.

Available Finishes



W



PT

A full finish index is located on pages 172-173.



9793PT

Product Number	Pull Force	Length	Width	Height	Strike
9793W	6-12 lbs.	2"	3/4"	1/2"	Steel; (AE); 1 1/8" L x 3/4" W
9793PT <i>(shown)</i>	6-12 lbs.	2"	3/4"	1/2"	Steel; (AE); 1 1/8" L x 3/4" W

Screws: (2) #6 T.H. x 1/2"; (1) #5 F.H. x 1/2"

Pack type information can be located in the Product Index that begins on page 213.

MAGNETIC CATCHES

Available Finish



AW

A full finish index is located on pages 172-173.



9798AW

Product Number	Pull Force	Length	Width	Height	Strike
9798AW <i>(shown)</i>	12-19 lbs.	1 1/8"	2"	13/16"	Steel; (AE); 1" L x 3/4" W

Screws: (2) #6 T.H. x 1/2"; (1) #5 F.H. x 1/2"

Pack type information can be located in the Product Index that begins on page 213.

Available Finish



AL

A full finish index is located on pages 172-173.



33772AL

Product Number	Pull Force	Length	Width	Height	Strike
33772AL <i>(shown)</i>	-	1 1/2"	13/16"	1/2"	Steel; 1 1/4" L x 7/8" W

Screws: (2) #6 T.H. x 1/2"; (1) #5 F.H. x 1/2"

Pack type information can be located in the Product Index that begins on page 213.

TOUCH CATCHES

Available Finishes



W



BR

A full finish index is located on pages 172-173.



32301BR

Product Number	Pull Force	Length	Width	Height	Strike
32301W	-	-	-	-	-
32301BR <i>(shown)</i>	-	-	-	-	-

Screws: (2) #6 T.H. x 5/8"; (1) #5 F.H. x 1/2"

Pack type information can be located in the Product Index that begins on page 213.

MISCELLANEOUS CATCHES

Available Finish



2G

A full finish index is located on pages 172-173.



36752G

Product Number	Pull Force	Length	Width	Height	Strike
36752G (shown)	–	1 5/16"	1"	1"	Steel; 1" L x 7/16" W x 1/4" H

Screws: (3) #5 T.H. x 1/2"; (1) #15 x 1/2"

Pack type information can be located in the Product Index that begins on page 213.

Product Number	Pull Force	Length	Width	Height	Strike
8924DB	–	–	–	–	Steel

Screws: (2) #5 O.H. x 5/8"; (3) #5 F.H. x 1/2"

Pack type information can be located in the Product Index that begins on page 213.

Available Finish



2G

A full finish index is located on pages 172-173.



34712G

Product Number	Pull Force	Length	Width	Height	Strike
34712G (shown)	3-6 lbs.	1 5/16"	1"	1/2"	Steel; 1 1/4" L x 3/8" W x 5/8" H

Screws: (4) #6 T.H. x 1/2"

Pack type information can be located in the Product Index that begins on page 213.

Available Finish



A2G

A full finish index is located on pages 172-173.



9700A2G

Product Number	Pull Force	Length	Width	Height	Strike
9700A2G (shown)	3-6 lbs.	1 5/16"	1"	1/2"	Steel; 1 1/4" L x 3/8" W x 5/8" H

Screws: (4) #6 T.H. x 1/2"

Pack type information can be located in the Product Index that begins on page 213.

MISCELLANEOUS CATCHES

Available Finishes

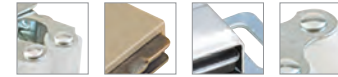

A full finish index is located on pages 172-173.



143



145



144



147

SHEET METAL SCREWS

Product Number	Description	Qty. Per Case
91557M3	#5 O.H. x 5/8" Sheet Metal Screws	2000 (10 bags of 200pcs)
91557BB	#5 O.H. x 5/8" Sheet Metal Screws	2000 (10 bags of 200pcs)
91657G10	#6 O.H. x 5/8" Sheet Metal Screws	2000 (10 bags of 200pcs)
91657M3	#6 O.H. x 5/8" Sheet Metal Screws	2000 (10 bags of 200pcs)
91657BB	#6 O.H. x 5/8" Sheet Metal Screws	2000 (10 bags of 200pcs)
91657ORB	#6 O.H. x 5/8" Sheet Metal Screws	2000 (10 bags of 200pcs)
92555G10	#5 F.H. x 1/2" Sheet Metal Screws	2000 (10 bags of 200pcs)
92555M26	#5 F.H. x 1/2" Sheet Metal Screws	2000 (10 bags of 200pcs)
92555M3	#5 F.H. x 1/2" Sheet Metal Screws	2000 (10 bags of 200pcs)
92555BB	#5 F.H. x 1/2" Sheet Metal Screws	2000 (10 bags of 200pcs)
92555ORB	#5 F.H. x 1/2" Sheet Metal Screws	2000 (10 bags of 200pcs)
92655G10	#6 F.H. x 1/2" Sheet Metal Screws	2000 (10 bags of 200pcs)
92655M3	#6 F.H. x 1/2" Sheet Metal Screws	2000 (10 bags of 200pcs)
92655BB	#6 F.H. x 1/2" Sheet Metal Screws	2000 (10 bags of 200pcs)
92655ORB	#6 F.H. x 1/2" Sheet Metal Screws	2000 (10 bags of 200pcs)
92657G10	#6 F.H. x 5/8" Sheet Metal Screws	2000 (10 bags of 200pcs)
92657M3	#6 F.H. x 5/8" Sheet Metal Screws	2000 (10 bags of 200pcs)
92657BB	#6 F.H. x 5/8" Sheet Metal Screws	2000 (10 bags of 200pcs)
92657ORB	#6 F.H. x 5/8" Sheet Metal Screws	2000 (10 bags of 200pcs)
94657BB	#6 T.H. x 5/8" Sheet Metal Screws	2000 (10 bags of 200pcs)

Pack type information can be located in the Product Index that begins on page 213.

MACHINE SCREWS FOR KNOBS AND PULLS

Product Number	Description	Qty. Per Case
780312G	#8-32 T.H. x 1 3/4" Machine Screws	1000 (10 bags of 100pcs)
773002G	#8-32 T.H. x 2" Machine Screws	1000 (10 bags of 100pcs)
780272G	#8-32 T.H. x 1" Machine Screws	1000 (10 bags of 100pcs)
780292G	#8-32 Robertson x 1 1/4" Machine Screws	1000 (10 bags of 100pcs)
780302G	#8-32 T.H. x 1 1/2" Machine Screws	1000 (10 bags of 100pcs)
790632G	#8-32 T.H. x 1 5/8" Machine Screws	1000 (10 bags of 100pcs)

Pack type information can be located in the Product Index that begins on page 213.

SHelf SUPPORTS

Available Finishes



14 3

A full finish index is located on pages 172-173.

Product Number	Size	Box Qty
300114 <i>(shown)</i>	20mm L	4,000 per box
30013	–	4,000 per box

Note: For use with 5mm holes
Pack type information can be located in the Product Index that begins on page 213.

Available Finish



CL

A full finish index is located on pages 172-173.

Product Number	Size
3002CL <i>(shown)</i>	–

Note: For use with 5mm holes
Pack type information can be located in the Product Index that begins on page 213.



300114

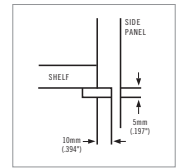

3002CL

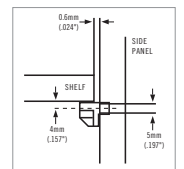

SERIES 17002

Features

- Self-closing euro style drawer slides
- 3/4 extension slides provide more stability for optimum performance
- Bottom or side mount capability
- Self-closing feature guides the drawer to the fully closed position from slightly outside the cabinet
- White epoxy coated



Product Number	Description	Material	Length	Width	Height	Extension	Slide Type
17002NB14W	14" S/C	Cold Rolled Steel	14"	1/2"	7/8"	3/4"	Euro
17002NB16WS	16" S/C	Cold Rolled Steel	16"	1/2"	7/8"	3/4"	Euro
17002NB18WS	18" S/C	Cold Rolled Steel	18"	1/2"	7/8"	3/4"	Euro
17002NB20WS	20" S/C	Cold Rolled Steel	20"	1/2"	7/8"	3/4"	Euro
17002NB22WS	22" S/C	Cold Rolled Steel	22"	1/2"	7/8"	3/4"	Euro
17002BPW	Fixed Rear Mtg Bkt	Plastic	-	-	-	-	Bracket

Pack type information can be located in the Product Index that begins on page 213.

SERIES 5850

Features

- Self-closing euro style drawer slides
- 3/4 extension slides provide more stability for optimum performance
- Bottom or side mount capability
- Self-closing feature guides the drawer to the fully closed position from slightly outside the cabinet



Product Number	Description	Material	Length	Width	Height	Extension	Slide Type
5850C14W	14" Cabinet Track	Cold Rolled Steel	14"	1/2"	7/8"	3/4"	Euro
5850C20W	20" Cabinet Track	Cold Rolled Steel	20"	1/2"	7/8"	3/4"	Euro
5850C22W	22" Cabinet Track	Cold Rolled Steel	22"	1/2"	7/8"	3/4"	Euro
5850D14WS	14" Drawer Rail	Cold Rolled Steel	14"	1/2"	7/8"	3/4"	Euro
5850D20WS	20" S/C Drawer Rail	Cold Rolled Steel	20"	1/2"	7/8"	3/4"	Euro
5850D22WS	22" S/C Drawer Rail	Cold Rolled Steel	22"	1/2"	7/8"	3/4"	Euro
5850ABRPW	Right Adjustable Rear Mtg Bkt	Plastic	-	-	-	-	Bracket
5850BRPW	Right Fixed Rear Mtg Bkt	Plastic	-	-	-	-	Bracket

Pack type information can be located in the Product Index that begins on page 213.

SERIES 700

Features

- Standard type ball bearing side mount drawer slides
- Ball bearings within the slides provide smooth, long-lasting operation
- Full extension slides provide easy access to all items in the drawer
- When closed, the hold-in detent keeps the drawer firmly in place
- The lever disconnect feature simplifies drawer removal



Product Number	Description	Material	Length	Width	Height	Extension	Slide Type
70016NB2G	Standard Type Side Mount	Cold Rolled Steel	16"	1/2"	1 3/4"	Full	Ball Bearing
70018NB2G	Standard Type Side Mount	Cold Rolled Steel	18"	1/2"	1 3/4"	Full	Ball Bearing
70020NB2G	Standard Type Side Mount	Cold Rolled Steel	20"	1/2"	1 3/4"	Full	Ball Bearing
70022NB2G	Standard Type Side Mount	Cold Rolled Steel	22"	1/2"	1 3/4"	Full	Ball Bearing

Pack type information can be located in the Product Index that begins on page 213.



DISPLAY TOWER

Display Type	Dimensions
Quad (shown)	19 1/2" W x 84" H



Quad Tower

DISPLAY BOARDS

Board Type	Dimensions
BPD (shown)	16" W x 24" H
Appliance	15" W x 16 1/2" H
Appliance Easel	12" W x 13" H
Bath Slat Wall (shown)	30" W x 22" H
Stainless Steel 1	20" W x 40" H
Stainless Steel 2	10" W x 20" H
CSM Full (shown)	15" W x 5 1/2" H
CSM Half (shown)	7 1/2" W x 5 1/2" H
Allison™ Value Hardware (shown)	15" W x 5 1/2" H



BPD



Bath Slat Wall



CSM Full



CSM Half



Allison™ Value Hardware



Featured Here:
 Candler Cabinet Hardware in Antique Silver,
 18" Beveled Mahogany Hook Rack with
 Hooks in Antique Silver, and Large Coat &
 Hat Hook in Antique Silver.



PRODUCT INDEX

INTRODUCTION
 P. 211

PACK TYPE INFORMATION
 P. 213

COLLECTION LISTING
 P. 214

FULL PRODUCT LISTING
 P. 216

PACK TYPE INFORMATION

Decorative Pack Types	Packaging	Description
BP	Polybag Pack	10 – 25 pieces in a carton, individually bagged with screws.
CDK	Cabinet Design Kit	10 items in a tray and PVS carton. 4 per case. Includes drillbit, screwbit, template, screws.
CM	Bulk Pack	100 – 200 pieces in a box. Items individually wrapped in tissue. Includes screws.
D	Bulk Pack	100 – 200 pieces in a box. Items individually wrapped in tissue.
E	Ensembles	Coordinated pair of decorative hardware.
PK	Special Pack	Quantity per box varies by product.
TEN	Ten Pack	10 pieces in plastic clamshell pack. 4 packs per case. Includes screws.
TMP	Template Pack	Product and instructions.
TPK	Ten Pack	10 pieces in plastic clamshell pack. 4 packs per case. Includes screws.

Hooks Pack Types	Packaging	Description
H	Retail Pack	Product, mounting hardware, instructions.

Bath Pack Types	Packaging	Description
BH	Retail Pack	Product, mounting hardware, instructions.

Hinge Pack Types	Packaging	Description
BP	Polybag Pack	25 pairs of hinges in a carton, individually bagged with pads and screws.
CM/LCM/M	Bulk Pack	100 pairs of hinges per carton with separate bags of pads and screws.
D/LD	Bulk Pack	100 pairs of hinges per carton without pads and screws.
P	Large Bulk Pack	2500 plus "eaches" of hinges in a carton (quantities vary by product) without pads and screws.
PK	Special Pack	50 "eaches" of hinges in a carton, individually bagged with pads and screws.
TEN	Ten Pack	10 pieces in plastic reusable bucket pack. Includes screws.

Catch Pack Types	Packaging	Description
BP	Polybag Pack	25 pieces in a carton, individually bagged with screws and a strike.
CM	Bulk Pack	200 catches in a carton with separate bags of screws and strikes.

Drawer Slide Pack Types	Packaging	Description
C	Polybag Pack or Shrink Wrapped	One set of drawer slides retail packed.
P	Bulk Pack	50 pieces of one item.
CM	Bulk Pack	100 slides.

COLLECTION INDEX

AMEROCK DECORATIVE CABINET HARDWARE

ABERNATHY	72	ESSENTIAL'Z - BAR PULLS	30,99	PORTER	24
ABSTRACTIONS	90	ESSENTIAL'Z - BRIDGE PULLS	30,98	RADIANCE	66
ADVANTAGE SOLID BRASS	51	EVOLUTIONS	42	REFLECTIONS	64
AMBROSIA	82	EXPRESSIONS	62	REVITALIZE	48,102
ANGOURI	79	EXTENSITY	15,94	RIVA	31,99
ATHERLY	46,101	EYDON	78	ROCHDALE	18,96
BACKPLATES	67	FORGINGS	86	RUSTIC FINISHES	66
BAR PULLS	32,100	HARMONY	37	SLEEK	41
BASIC METALS	42	HIGHLAND RIDGE	16,95	SONARA	35
BLACKROCK	73,105	HINT OF HERITAGE	61,104	STAINLESS STEEL	33
BRASS AND STERLING TRADITIONS	54,104	INSPIRATIONS	20,75,97,106	SUNDARA	79
CANDLER	14,94	KANE	19,96	SWIRL'Z	74,106
CERAMICS	26	LATTICE	49,102	THE ANNIVERSARY COLLECTION	60
COLORS	22	MANOR	52,103	TRADITIONAL CLASSICS	58,107
COLOUR WASHED CERAMICS	26	MARSDEN	80	TRUE ELEGANCE	65,88
CONRAD	36	MULHOLLAND	47,50,100	UTENSIL'Z	90
CREASED BOW	34	NATURAL ELEGANCE	84	VASARI	56,76
CROSLEY	25	NATURE'S SPLENDOR	88	VILLAGE CLASSICS	57
CYPRUS	80	ODEON	78	VINEYARD	81
DESIGN DETAILS	63	OPULENCE	50	WESTERLY	17,95
DIVINITY	89	PADMA	76,106		
DULCET	40	PATTERNS	62		
ESSENTIAL'Z	23,37,107	POLARA	25,98		

Amerock warrants all products protected with the Guardian Lifetime Guarantee™ against defects in material and workmanship for as long as the original consumer purchaser owns the product. If the finish of any of the items protected by the Guardian Lifetime Guarantee™ tarnishes or corrodes, Amerock® will send to the original purchaser, without charge, a new replacement product of the same or comparable style and quality. If a replacement is no longer available, Amerock® will refund to the original purchaser the current retail value of the knob or pull. This warranty does not include removal of the defective product or installation of the replacement product, which are the responsibilities of the original purchaser. This warranty does not cover product failure caused by improper installation, improper cleaning, product abuse, casualty, or other abnormal conditions.

COLLECTION INDEX

ALLISON VALUE HARDWARE

ALLISON VALUE HARDWARE 116

DECORATIVE BATH HARDWARE

ARRONDI 159

CLARENDON 157

MARKHAM 160

SAYBROOK 158

SAYBROOK CLASSIC 161

DECORATIVE HOOKS

HOOK RACKS 169

KEY & GADGET RACKS 168

OVER-THE-DOOR HOOKS 167

SINGLE HOOKS 166

FUNCTIONAL CABINET HARDWARE

INSTALLATION TEMPLATES	174	MARATHON, PARTIAL WRAP	198	SERIES 17002	208
DOUBLE DEMOUNTABLE	184	MATRIX CONCEALED	196	SERIES 5850	208
EASY ON	197	MATRIX FACE FRAME CONCEALED	195	SERIES 700	209
FRAMELESS CONCEALED	196	MISCELLANEOUS CATCHES	204	SHEET METAL SCREWS	206
FULL INSET, FULL WRAP, BALL TIP	191	NON SELF-CLOSING	189	SHELF SUPPORTS	207
FULL INSET, FULL WRAP, MINARET TIP	192	NON SELF-CLOSING, "H" HINGE	190	SINGLE DEMOUNTABLE, PARTIAL WRAP	186
FULL INSET, PARTIAL WRAP	194	NON SELF-CLOSING, BUTT HINGE	189	TOUCH CATCHES	203
FULL INSET, PARTIAL WRAP, BALL TIP	193	NON SELF-CLOSING, FACE MOUNT	187		
FULL INSET, PARTIAL WRAP, MINARET TIP	193	ROLLER CATCHES	199		
MACHINE SCREWS FOR KNOBS AND PULLS	206	SELF-CLOSING, FACE MOUNT	177		
		SELF-CLOSING, FULL WRAP	174		
MAGNETIC CATCHES	201	SELF-CLOSING, PARTIAL WRAP	175		

PRODUCT INDEX

Item	Pack Type	Primary Dimension	Length	Width	Projection	Base Material	Page	Item	Pack Type	Primary Dimension	Length	Width	Projection	Base Material	Page
125ABS	-	1 1/4"	-	-	3/4"	Zinc	135	1321DW	BP	1 3/8"	1 3/8"	1 3/8"	1 1/8"	Ceramic	26
1300ART	BP	3"	5 1/4"	3/4"	1 1/16"	Zinc	55	1321W	BP	1 3/8"	1 3/8"	1 3/8"	1 1/8"	Ceramic	26
1300G9	BP	3"	5 1/4"	3/4"	1 1/16"	Zinc	55	1330G9	BP	3"	5 1/2"	3/8"	1"	Zinc	84
1300077	BP, D	3"	5 1/4"	3/4"	1 1/16"	Zinc	55	1330077	BP	3"	5 1/2"	3/8"	1"	Zinc	84
1300ORB	BP	3"	5 1/4"	3/4"	1 1/16"	Zinc	55	1330RBZ	BP	3"	5 1/2"	3/8"	1"	Zinc	84
1300RB	BP	3"	5 1/4"	3/4"	1 1/16"	Zinc	55	1330WI	BP	3"	5 1/2"	3/8"	1"	Zinc	84
1301G9	BP	3"	5 1/2"	13/16"	1"	Zinc	56	1332077	BP	3"	5 1/8"	3/8"	1"	Zinc	84
1301O77	BP	3"	5 1/2"	13/16"	1"	Zinc	56	1332RBZ	BP	3"	5 1/8"	3/8"	1"	Zinc	84
1301ORB	BP	3"	5 1/2"	13/16"	1"	Zinc	56	1333G9	BP, CM	3"	5"	3/8"	1"	Zinc	85
1302ART	BP	3"	4 15/16"	9/16"	1"	Zinc	54	1333077	BP	3"	5"	3/8"	1"	Zinc	85
1302G10	BP	3"	4 15/16"	9/16"	1"	Zinc	54	1333PWT	BP	3"	5"	3/8"	1"	Zinc	85
1302G9	BP	3"	4 15/16"	9/16"	1"	Zinc	54	1333WI	BP	3"	5"	3/8"	1"	Zinc	85
1302O77	BP	3"	4 15/16"	9/16"	1"	Zinc	54	1334G9	BP	3"	5 1/4"	3/8"	1"	Zinc	85
1302ORB	BP	3"	4 15/16"	9/16"	1"	Zinc	54	1334O77	BP	3"	5 1/4"	3/8"	1"	Zinc	85
1302RB	BP	3"	4 15/16"	9/16"	1"	Zinc	54	1336G9	BP	1 3/8"	1 3/8"	1 3/8"	1"	Zinc	84
1303G9	BP	3"	4 11/16"	11/16"	1"	Zinc	56	1336O77	BP	1 3/8"	1 3/8"	1 3/8"	1"	Zinc	84
1303O77	BP	3"	4 11/16"	11/16"	1"	Zinc	56	1336RBZ	BP	1 3/8"	1 3/8"	1 3/8"	1"	Zinc	84
1303ORB	BP	3"	4 11/16"	11/16"	1"	Zinc	56	1336WI	BP	1 3/8"	1 3/8"	1 3/8"	1"	Zinc	84
1304G9	BP	4 5/16"	4 5/16"	25/32"	3/32"	Zinc	69	1337G9	BP	1 1/4"	1 1/4"	1 1/4"	1"	Zinc	85
1304O77	BP	4 5/16"	4 5/16"	25/32"	3/32"	Zinc	69	1337O77	BP	1 1/4"	1 1/4"	1 1/4"	1"	Zinc	85
1306G9	BP	1 3/16"	1 3/16"	1 3/16"	7/8"	Zinc	55	1337PWT	BP	1 1/4"	1 1/4"	1 1/4"	1"	Zinc	85
1306O77	BP	1 3/16"	1 3/16"	1 3/16"	7/8"	Zinc	55	1337WI	BP	1 1/4"	1 1/4"	1 1/4"	1"	Zinc	85
1307ART	BP	1 1/4"	1 1/4"	1 1/4"	7/8"	Zinc	55	1338G9	BP	1 1/2"	1 1/2"	7/8"	1"	Zinc	85
1307G9	BP	1 1/4"	1 1/4"	1 1/4"	7/8"	Zinc	55	1338O77	BP	1 1/2"	1 1/2"	7/8"	1"	Zinc	85
1307O77	BP	1 1/4"	1 1/4"	1 1/4"	7/8"	Zinc	55	1338PWT	BP	1 1/2"	1 1/2"	7/8"	1"	Zinc	85
1307ORB	BP	1 1/4"	1 1/4"	1 1/4"	7/8"	Zinc	55	1338WI	BP	1 1/2"	1 1/2"	7/8"	1"	Zinc	85
1308G9	BP	1 1/8"	1 1/8"	1 1/8"	1"	Zinc	56	1350074	BP	3"	5 3/16"	5/16"	15/16"	Zinc	65
1308GB	BP	1 1/8"	1 1/8"	1 1/8"	1"	Zinc	56	1350077	BP	3"	5 3/16"	5/16"	15/16"	Zinc	65
1308O77	BP	1 1/8"	1 1/8"	1 1/8"	1"	Zinc	56	1351WI	BP	3"	5 1/4"	5/16"	15/16"	Zinc	88
1308ORB	BP	1 1/8"	1 1/8"	1 1/8"	1"	Zinc	56	1352O74	BP	3"	5 1/4"	5/16"	15/16"	Zinc	65
1312G10	BP	3 3/4", 96mm	5 2/3"	2/5"	1"	Zinc	54	1352O77	BP	3"	5 1/4"	5/16"	15/16"	Zinc	65
1312ORB	BP	3 3/4", 96mm	5 2/3"	2/5"	1"	Zinc	54	1354O74	BP	1 1/4"	1 1/4"	1 1/4"	1"	Zinc	65
1312RB	BP	3 3/4", 96mm	5 2/3"	2/5"	1"	Zinc	54	1354O77	BP	1 1/4"	1 1/4"	1 1/4"	1"	Zinc	65
1313G10	BP	5", 128mm	7"	7/16"	1 1/8"	Zinc	54	1355AB	-	1 1/4"	1 1/4"	1 1/4"	1 1/8"	Zinc	142
1313ORB	BP	5", 128mm	7"	7/16"	1 1/8"	Zinc	54	1355WI	BP	1 1/4"	1 1/4"	1 1/4"	1 1/8"	Zinc	88
1313RB	BP	5", 128mm	7"	7/16"	1 1/8"	Zinc	54	1356AB	-	1 1/4"	1 1/4"	1 1/4"	1"	Zinc	142
1314G10	BP	6 1/4", 160mm	8 1/4"	1/2"	1 1/4"	Zinc	54	1356O74	BP	1 1/4"	1 1/4"	1 1/4"	1"	Zinc	65
1314ORB	BP	6 1/4", 160mm	8 1/4"	1/2"	1 1/4"	Zinc	54	1356O77	BP	1 1/4"	1 1/4"	1 1/4"	1"	Zinc	65
1314RB	BP	6 1/4", 160mm	8 1/4"	1/2"	1 1/4"	Zinc	54	13833	BP	3"	4 13/16"	9/16"	1"	Zinc	64
1315G10	BP	12"	15 2/5"	1"	2"	Zinc	54	13843	BP	3"	4 9/16"	9/16"	1"	Zinc	64
1315ORB	BP	12"	15 2/5"	1"	2"	Zinc	54	138426	BP	3"	4 9/16"	9/16"	1"	Zinc	64
1315RB	BP	12"	15 2/5"	1"	2"	Zinc	54	1384G9	BP	3"	4 9/16"	9/16"	1"	Zinc	64
1316G10	BP	18"	22 1/4"	1 1/8"	2 1/4"	Zinc	54	1384R1	BP	3"	4 9/16"	9/16"	1"	Zinc	64
1316ORB	BP	18"	22 1/4"	1 1/8"	2 1/4"	Zinc	54	138626	BP	1 1/4"	1 1/4"	1 1/4"	1"	Zinc	61
1316RB	BP	18"	22 1/4"	1 1/8"	2 1/4"	Zinc	54	13873	BP	1 1/4"	1 1/4"	1 1/4"	1"	Zinc	64
1320W	BP	1 3/8"	1 3/8"	1 3/8"	1 1/8"	Ceramic	26	138726	BP	1 1/4"	1 1/4"	1 1/4"	1"	Zinc	64
1321A	BP	1 3/8"	1 3/8"	1 3/8"	1 1/8"	Ceramic	26	1387ART	BP	1 1/4"	1 1/4"	1 1/4"	1"	Zinc	64

The dimensional information provided here should be verified with the actual product prior to drilling or attempting to install the hardware. All dimensions listed are within the nearest 1/16th of an inch. Please direct any questions you may have on the installation process to Amerock Customer Service.

PRODUCT INDEX

Item	Pack Type	Primary Dimension	Length	Width	Projection	Base Material	Page
1387AS	BP	1 1/4"	1 1/4"	1 1/4"	1"	Zinc	64
1387G10	BP, TPK	1 1/4"	1 1/4"	1 1/4"	1"	Zinc	64
1387G9	BP	1 1/4"	1 1/4"	1 1/4"	1"	Zinc	64
1387GB	BP	1 1/4"	1 1/4"	1 1/4"	1"	Zinc	64
1387ORB	BP	1 1/4"	1 1/4"	1 1/4"	1"	Zinc	64
1387R1	BP	1 1/4"	1 1/4"	1 1/4"	1"	Zinc	64
1387RB	BP	1 1/4"	1 1/4"	1 1/4"	1"	Zinc	64
1387RBZ	BP	1 1/4"	1 1/4"	1 1/4"	1"	Zinc	64
13943	BP	3"	4 1/4"	11/16"	1"	Zinc	66
139426	BP	3"	4 1/4"	11/16"	1"	Zinc	66
1395R1	BP	3"	4 15/16"	3/4"	1"	Zinc	66
13963	BP	1 1/2"	1 1/2"	7/8"	1"	Zinc	66
139626	BP	1 1/2"	1 1/2"	7/8"	1"	Zinc	66
1397R1	BP	1 1/4"	1 1/4"	1 1/4"	1"	Zinc	66
143	-	-	1 1/4"	1/2"	1 1/16"	-	205
144	-	-	-	-	-	-	205
145	BP	-	-	-	-	-	205
147	-	-	-	-	-	-	205
149AE	BP	3"	4 1/4"	3/8"	15/16"	Zinc	133
149AS	BP	3"	4 1/4"	3/8"	15/16"	Zinc	133
149G10	BP	3"	4 1/4"	3/8"	15/16"	Zinc	133
149ORB	BP	3"	4 1/4"	3/8"	15/16"	Zinc	133
14113	BP	3"	3 5/8"	5/8"	1 1/32"	Cartridge Brass	123
14233	BP	1"	1"	1"	15/16"	Cartridge Brass	123
14243	BP	1 1/4"	1 1/4"	1 1/4"	1"	Cartridge Brass	140
14433	BP	1 1/4"	1 1/4"	3/4"	1 1/4"	Cartridge Brass	126
1443G10	BP	1 1/4"	1 1/4"	3/4"	1 1/4"	Cartridge Brass	126
1443ORB	BP	1 1/4"	1 1/4"	3/4"	1 1/4"	Cartridge Brass	126
14513	BP	3 1/2"	3 7/8"	3/8"	1 1/8"	Cartridge Brass	123
1452AE	BP	4"	4 1/2"	3/8"	1 1/4"	Cartridge Brass	123
1452G10	BP	4"	4 1/2"	3/8"	1 1/4"	Cartridge Brass	123
14662G10	BP	1 3/4"	1 3/4"	1 3/4"	1 3/8"	Zinc	61, 104
1466G10	BP	1 1/4"	1 1/4"	1 1/4"	1 1/8"	Zinc	61
1466ORB	BP	1 1/4"	1 1/4"	1 1/4"	1 1/8"	Zinc	61
1466PWT	BP	1 1/4"	1 1/4"	1 1/4"	1 1/8"	Zinc	61
1466R2	BP	1 1/4"	1 1/4"	1 1/4"	1 1/8"	Zinc	61
1466WID	BP	1 1/4"	1 1/4"	1 1/4"	1 1/8"	Zinc	61
1466WN	BP	1 1/4"	1 1/4"	1 1/4"	1 1/8"	Zinc	61
1470074	BP	3"	4 3/4"	7/16"	1"	Zinc	62
1470PWT	BP	3"	4 3/4"	7/16"	1"	Zinc	62
1471CP	BP	3"	5 1/8"	7/16"	1"	Zinc	62
1471G9	BP	3"	5 1/8"	7/16"	1"	Zinc	62
1471074	BP	3"	5 1/8"	7/16"	1"	Zinc	62
1471ORB	BP	3"	5 1/8"	7/16"	1"	Zinc	62
1471PWT	BP	3"	5 1/8"	7/16"	1"	Zinc	62
1474PWT	BP	1 1/2"	1 1/2"	7/8"	1 1/8"	Zinc	62
1475CP	BP	1 3/8"	1 3/8"	1 1/4"	1 1/4"	Zinc	62

The dimensional information provided here should be verified with the actual product prior to drilling or attempting to install the hardware. All dimensions listed are within the nearest 1/16th of an inch. Please direct any questions you may have on the installation process to Amerock Customer Service.

PRODUCT INDEX

Item	Pack Type	Primary Dimension	Length	Width	Projection	Base Material	Page
1475G9	BP	1 3/8"	1 3/8"	1 1/4"	1 1/4"	Zinc	62
1475074	BP	1 3/8"	1 3/8"	1 1/4"	1 1/4"	Zinc	62
1475PWT	BP	1 3/8"	1 3/8"	1 1/4"	1 1/4"	Zinc	62
14202AL	-	1 1/4"	-	-	1 1/16"	Ceramic	151
14204WHT	-	1 1/4"	-	-	15/16"	Ceramic	151
14221WHT	-	1 3/8"	-	-	1 3/16"	Ceramic	151
14222WPB	-	3"	-	-	-	Ceramic	147
14224WHT	-	1 3/8"	-	-	7/8"	Ceramic	151
14303CBB	BP	1 1/4"	-	-	-	Glass / Zinc	58
14303CSG	BP	1 1/4"	-	-	-	Glass / Zinc	58
14303G10	BP	1 1/4"	-	-	-	Glass / Zinc	58
14303ORB	BP	1 1/4"	-	-	-	Glass / Zinc	58
14351WCH	-	1 3/16"	-	-	1 1/8"	Zinc	148
14401CH	-	1 1/4"	-	-	1 1/16"	Zinc	141
14403SCH	-	1 5/16"	-	-	7/8"	Zinc	141
14404SCH	-	1 3/16"	-	-	1 1/8"	Zinc	141
14408SCH	-	1 11/16"	1 11/16"	1"	11/16"	Zinc	141
14465PB	-	3"	5 1/4"	-	7/8"	Zinc	136
14951CH	-	1 1/4"	-	-	-	Steel	197
152AE	BP, CM	3"	4 7/8"	1 3/4"	2 5/32"	Zinc	144
156AE	BP	3"	4 5/32"	3/4"	7/8"	Zinc	133
159ABS	-	1 1/2"	1"	-	-	Zinc	135
159ORB	BP	1 1/2"	1"	-	-	Zinc	135
1580EB	BP	3"	5 9/16"	11/16"	1"	Zinc	75
1580G10	BP	3"	5 9/16"	11/16"	1"	Zinc	75
1580ORB	BP	3"	5 9/16"	11/16"	1"	Zinc	75
1580R2	BP	3"	5 9/16"	11/16"	1"	Zinc	75
1580WID	BP	3"	5 9/16"	11/16"	1"	Zinc	75
1580WN	BP	3"	5 9/16"	11/16"	1"	Zinc	75
15812EB	BP	1 3/4"	1 3/4"	1 3/4"	1 7/16"	-	75, 106
15812G10	BP	1 3/4"	1 3/4"	1 3/4"	1 7/16"	-	75, 106
15812ORB	BP	1 3/4"	1 3/4"	1 3/4"	1 7/16"	-	75, 106
15812WN	BP	1 3/4"	1 3/4"	1 3/4"	1 7/16"	-	75, 106
1581EB	BP	1 1/4"	1 1/4"	1 1/4"	1 1/8"	Zinc	75
1581G10	BP	1 1/4"	1 1/4"	1 1/4"	1 1/8"	Zinc	75
1581ORB	BP	1 1/4"	1 1/4"	1 1/4"	1 1/8"	Zinc	75
1581R2	BP	1 1/4"	1 1/4"	1 1/4"	1 1/8"	Zinc	75
1581WID	BP	1 1/4"	1 1/4"	1 1/4"	1 1/8"	Zinc	75
1581WN	BP	1 1/4"	1 1/4"	1 1/4"	1 1/8"	Zinc	75
1582EB	BP	3"	4 1/4"	1 3/8"	1"	Zinc	75
1582ORB	BP	3"	4 1/4"	1 3/8"	1"	Zinc	75
1582R2	BP	3"	4 1/4"	1 3/8"	1"	Zinc	75
1582WID	BP	3"	4 1/4"	1 3/8"	1"	Zinc	75
1582WN	BP	3"	4 1/4"	1 3/8"	1"	Zinc	75
1583EB	BP	1 3/4"	1 3/4"	1 1/16"	1 1/16"	Zinc	75
1583ORB	BP	1 3/4"	1 3/4"	1 1/16"	1 1/16"	Zinc	75
1583R2	BP	1 3/4"	1 3/4"	1 1/16"	1 1/16"	Zinc	75
1583WID	BP	1 3/4"	1 3/4"	1 1/16"	1 1/16"	Zinc	75
1583WN	BP	1 3/4"	1 3/4"	1 1/16"	1 1/16"	Zinc	75
1583WID	BP	1 3/4"	1 3/4"	1 1/16"	1 1/16"	Zinc	75
1583WN	BP	1 3/4"	1 3/4"	1 1/16"	1 1/16"	Zinc	75
1585G10	BP, TPK	1 1/4"	1 1/4"	1 1/4"	1"	Zinc	21
1585ORB	BP, TPK	1 1/4"	1 1/4"	1 1/4"	1"	Zinc	21
1585RB	BP	1 1/4"	1 1/4"	1 1/4"	1"	Zinc	21
1585WID	BP	1 1/4"	1 1/4"	1 1/4"	1"	Zinc	21
1585WN	BP	1 1/4"	1 1/4"	1 1/4"	1"	Zinc	21
15862FB	BP	1 3/4"	1 3/4"	1 3/4"	1 5/16"	Zinc	20, 97
15862G10	BP	1 3/4"	1 3/4"	1 3/4"	1 5/16"	Zinc	20, 97
15862ORB	BP	1 3/4"	1 3/4"	1 3/4"	1 5/16"	Zinc	20, 97
15862R2	E	1 3/4"	1 3/4"	1 3/4"	1 5/16"	Zinc	20, 97
15862RORB	E	1 3/4"	1 3/4"	1 3/4"	1 5/16"	Zinc	20, 97
15862WN	BP	1 3/4"	1 3/4"	1 3/4"	1 5/16"	Zinc	20, 97
1586ART	BP	1 5/16"	1 5/16"	1 5/16"	1"	Zinc	20
1586FB	BP	1 5/16"	1 5/16"	1 5/16"	1"	Zinc	20
1586G10	BP	1 5/16"	1 5/16"	1 5/16"	1"	Zinc	20
1586ORB	BP, TPK	1 5/16"	1 5/16"	1 5/16"	1"	Zinc	20
1586R2	BP	1 5/16"	1 5/16"	1 5/16"	1"	Zinc	20
1586RB	BP	1 5/16"	1 5/16"	1 5/16"	1"	Zinc	20
1586WC	BP	1 5/16"	1 5/16"	1 5/16"	1"	Zinc	20
1586WID	BP	1 5/16"	1 5/16"	1 5/16"	1"	Zinc	20
1586WN	BP	1 5/16"	1 5/16"	1 5/16"	1"	Zinc	20
1587FB	BP	96mm	6 5/16"	11/16"	1 1/16"	Zinc	20
1587G10	BP	96mm	6 5/16"	11/16"	1 1/16"	Zinc	20
1587ORB	BP	96mm	6 5/16"	11/16"	1 1/16"	Zinc	20
1587WN	BP	96mm	6 5/16"	11/16"	1 1/16"	Zinc	20
1588FB	BP	128mm	7 1/2"	3/4"	1 1/8"	Zinc	20
1588G10	BP	128mm	7 1/2"	3/4"	1 1/8"	Zinc	20
1588ORB	BP	128mm	7 1/2"	3/4"	1 1/8"	Zinc	20
1588WN	BP	128mm	7 1/2"	3/4"	1 1/8"	Zinc	20
1589FB	BP	160mm	8 11/16"	3/4"	1 3/16"	Zinc	20
1589G10	BP	160mm	8 11/16"	3/4"	1 3/16"	Zinc	20
1589ORB	BP	160mm	8 11/16"	3/4"	1 3/16"	Zinc	20
1589WN	BP	160mm	8 11/16"	3/4"	1 3/16"	Zinc	20

The dimensional information provided here should be verified with the actual product prior to drilling or attempting to install the hardware. All dimensions listed are within the nearest 1/16th of an inch. Please direct any questions you may have on the installation process to Amerock Customer Service.

PRODUCT INDEX

Item	Pack Type	Primary Dimension	Length	Width	Projection	Base Material	Page
1788WID	BP	18"	20 5/8"	5/7"	2 2/7"	Zinc	21, 97
17002BPW	C	–	–	–	–	Steel	208
17002NB14W	C	14"	13 7/8"	1/2"	7/8"	Steel	208
17002NB16WS	C	16"	15 3/4"	1/2"	7/8"	Steel	208
17002NB18WS	C	18"	17 3/4"	1/2"	7/8"	Steel	208
17002NB20WS	C	2"	19 11/16"	1/2"	7/8"	Steel	208
17002NB22WS	C	22"	21 5/8"	1/2"	7/8"	Steel	208
176CAE	BP	3"	4 3/8"	9/16"	1"	Zinc	143
1820PWT	BP	3"	4 7/16"	1 1/2"	1 1/16"	Zinc	63
1821PWT	BP	1 3/8"	2 3/8"	3 3/8"	1 1/8"	Zinc	63
1824PWT	BP	3"	5 3/16"	5/8"	1"	Zinc	63
1825PWT	BP	1 1/4"	1 1/4"	1 1/4"	1"	Zinc	63
1908G10	BP	3"	5 1/2"	5/8"	7/8"	Zinc	128
1908PB	BP	3"	5 1/2"	5/8"	7/8"	Zinc	128
191026	BP	1 1/4"	1 1/4"	1 1/4"	1 1/8"	Zinc	126
191026D	BP	1 1/4"	1 1/4"	1 1/4"	1 1/8"	Zinc	126
1910BN	BP	1 1/4"	1 1/4"	1 1/4"	1 1/8"	Zinc	126
1910G10	BP	1 1/4"	1 1/4"	1 1/4"	1 1/8"	Zinc	126
1910PB	BP	1 1/4"	1 1/4"	1 1/4"	1 1/8"	Zinc	126
1920W	BP	1 1/2"	–	–	3/4"	Zinc	151
1925PBOK	BP	3"	4 7/8"	3/4"	1 1/8"	Zinc	147
1930G10	BP	3"	5"	1/2"	1"	Zinc	139
195026	BP	1 1/4"	1 1/4"	1 1/4"	1 1/8"	Solid Brass	126
195026D	BP	1 1/4"	1 1/4"	1 1/4"	1 1/8"	Solid Brass	126
1950AE	BP	1 1/4"	1 1/4"	1 1/4"	1 1/8"	Solid Brass	126
1950B	BP	1 1/4"	1 1/4"	1 1/4"	1 1/8"	Solid Brass	126
1950BNB	BP	1 1/4"	1 1/4"	1 1/4"	1 1/8"	Solid Brass	126
1950BRB	BP	1 1/4"	1 1/4"	1 1/4"	1 1/8"	Solid Brass	126
1950G10	BP	1 1/4"	1 1/4"	1 1/4"	1 1/8"	Solid Brass	126
1950NBZ	BP	1 1/4"	1 1/4"	1 1/4"	1 1/8"	Solid Brass	126
1950ORB	BP	1 1/4"	1 1/4"	1 1/4"	1 1/8"	Solid Brass	126
1951BNB	BP	3"	3 3/8"	3/8"	1 3/16"	Solid Brass	127
1951G10	BP	3"	3 3/8"	3/8"	1 3/16"	Solid Brass	127
1952BNB	BP	3 1/2"	3 7/8"	3/8"	1 1/4"	Cartridge Brass	127
1952G10	BP	3 1/2"	3 7/8"	3/8"	1 1/4"	Cartridge Brass	127
1956BC	BP	1 1/4"	–	–	15/16"	Brass	146
1957NBZ	BP	3"	3 1/4"	7/16"	15/16"	Solid Brass	51
1964263	BP	3 15/16"	3 15/16"	9/16"	1 1/4"	Brass	145
197026D	BP	96mm	4 1/2"	9/16"	15/16"	Brass	132
1970G10	BP	96mm	4 1/2"	9/16"	15/16"	Brass	132
1971G10	BP	96mm, 3 3/4"	4 5/8"	13/16"	1/16"	Zinc	68
19001SS	BP	3"	3 5/8"	3/8"	1 3/16"	Stainless Steel	33
19002SS	BP	96mm	4 9/16"	3/8"	1 3/16"	Stainless Steel	33
19003SS	BP	128mm	5 15/16"	3/8"	1 3/16"	Stainless Steel	33
19004SS	BP	160mm	7 3/8"	3/8"	1 1/4"	Stainless Steel	33
19005SS	BP	192mm	8 7/8"	3/8"	1 1/4"	Stainless Steel	33
19006SS	BP	2" Length	2"	9/16"	1 1/2"	Stainless Steel	33
19007SS	BP	1 3/16"	1 3/16"	1 3/16"	1 1/4"	Stainless Steel	33
19008SS	BP	1 1/4"	1 1/4"	1 1/4"	1 1/8"	Stainless Steel	33
19009SS	BP	2" Length	2"	7/16"	1 3/8"	Stainless Steel	33
19010SS	BP	3"	5 3/8"	1/2"	1 3/8"	Stainless Steel	32
19011SS	BP	96mm	6 1/8"	1/2"	1 3/8"	Stainless Steel	32
19012SS	BP	192mm	9 15/16"	1/2"	1 3/8"	Stainless Steel	32
19013SS	BP	256mm	13 1/4"	1/2"	1 3/8"	Stainless Steel	32, 100
19014ORB	BP	320mm	15 3/4"	1/2"	1 3/8"	Stainless Steel	32, 100
19014SS	BP	320mm	15 3/4"	1/2"	1 3/8"	Stainless Steel	32, 100
19015ORB	BP	416mm	19 1/2"	1/2"	1 3/8"	Stainless Steel	32, 100
19015SS	BP	416mm	19 1/2"	1/2"	1 3/8"	Stainless Steel	32, 100
19016ORB	BP	480mm	22 1/16"	1/2"	1 3/8"	Stainless Steel	32, 100
19016SS	BP	480mm	22 1/16"	1/2"	1 3/8"	Stainless Steel	32, 100
19017ORB	BP	544mm	24 9/16"	1/2"	1 3/8"	Stainless Steel	32, 100
19017SS	BP	544mm	24 9/16"	1/2"	1 3/8"	Stainless Steel	32, 100
19018ORB	BP	640mm	28 3/8"	1/2"	1 3/8"	Stainless Steel	32, 100
19018SS	BP	640mm	28 3/8"	1/2"	1 3/8"	Stainless Steel	32, 100
19019ORB	BP	768mm	33 3/8"	1/2"	1 3/8"	Stainless Steel	32, 100
19019SS	BP	768mm	33 3/8"	1/2"	1 3/8"	Stainless Steel	32, 100
19200G10	BP	128mm	5 9/16"	9/16"	1 1/4"	Zinc	39
19200WN	BP	128mm	5 9/16"	9/16"	1 1/4"	Zinc	39
19201G10	BP	128mm	6 5/16"	13/16"	1 3/16"	Zinc	39
19201WN	BP	128mm	6 5/16"	13/16"	1 3/16"	Zinc	39
19202G10	BP	96mm	5 3/8"	1/2"	1"	Zinc	38
19202WID	BP	96mm	5 3/8"	1/2"	1"	Zinc	38
19202WN	BP	96mm	5 3/8"	1/2"	1"	Zinc	38
19203G10	BP	128mm	6"	3/4"	1 3/8"	Zinc	38
19204G10	BP	128mm	8 1/16"	1/2"	1 7/16"	Zinc	40
19204WN	BP	128mm	8 1/16"	1/2"	1 7/16"	Zinc	40
19205G10	BP	128mm	6 3/16"	11/16"	1 1/4"	Zinc	39
19205WN	BP	128mm	6 3/16"	11/16"	1 1/4"	Zinc	39
19206G10	BP	4 3/8"	4 3/8"	1"	1/16"	Steel	67
19206ORB	BP	4 3/8"	4 3/8"	1"	1/16"	Steel	67
19206R2	BP	4 3/8"	4 3/8"	1"	1/16"	Steel	67
19206WID	BP	4 3/8"	4 3/8"	1"	1/16"	Steel	67
19206WN	BP	4 3/8"	4 3/8"	1"	1/16"	Steel	67
19207AS	BP	4 3/8"	4 3/8"	1"	1/16"	Steel	67
19207CBZ	BP	4 3/8"	4 3/8"	1"	1/16"	Steel	67
19207G10	BP	4 3/8"	4 3/8"	1"	1/16"	Steel	67
19207GB	BP	4 3/8"	4 3/8"	1"	1/16"	Steel	67
19207ORB	BP	4 3/8"	4 3/8"	1"	1/16"	Steel	67
19207WID	BP	4 3/8"	4 3/8"	1"	1/16"	Steel	67
19208AS	BP	3"	5 11/16"	15/16"	1/16"	Steel	67
19208CBZ	BP	3"	5 11/16"	15/16"	1/16"	Steel	67
19208G10	BP	3"	5 11/16"	15/16"	1/16"	Steel	67
19208GB	BP	3"	5 11/16"	15/16"	1/16"	Steel	67
19208ORB	BP	3"	5 11/16"	15/16"	1/16"	Steel	67

The dimensional information provided here should be verified with the actual product prior to drilling or attempting to install the hardware. All dimensions listed are within the nearest 1/16th of an inch. Please direct any questions you may have on the installation process to Amerock Customer Service.

PRODUCT INDEX

Item	Pack Type	Primary Dimension	Length	Width	Projection	Base Material	Page
19208WID	BP	3"	5 11/16"	15/16"	1/16"	Steel	67
19208WN	BP	3"	5 11/16"	15/16"	1/16"	Steel	67
19250G10	BP	1 3/4"	1 3/4"	1 1/4"	1"	Zinc	80
19250WID	BP	1 3/4"	1 3/4"	1 1/4"	1"	Zinc	80
19250WN	BP	1 3/4"	1 3/4"	1 1/4"	1"	Zinc	80
19251G10	BP	3"	4 7/8"	1/2"	1 1/8"	Zinc	80
19251WID	BP	3"	4 7/8"	1/2"	1 1/8"	Zinc	80
19251WN	BP	3"	4 7/8"	1/2"	1 1/8"	Zinc	80
19252G10	BP	1 1/4"	1 1/4"	1 1/4"	1"	Zinc	89
19252WID	BP	1 1/4"	1 1/4"	1 1/4"	1"	Zinc	89
19252WN	BP	1 1/4"	1 1/4"	1 1/4"	1"	Zinc	89
19253G10	BP	3"	4 3/8"	5/16"	1"	Zinc	89
19253WID	BP	3"	4 3/8"	5/16"	1"	Zinc	89
19253WN	BP	3"	4 3/8"	5/16"	1"	Zinc	89
19254G10	BP	3"	4 3/4"	13/16"	1"	Zinc	89
19254WID	BP	3"	4 3/4"	13/16"	1"	Zinc	89
19254WN	BP	3"	4 3/4"	13/16"	1"	Zinc	89
1925726	BP	1 1/4"	1 1/4"	1 1/4"	1 3/8"	Zinc	90
1925726D	BP	1 1/4"	1 1/4"	1 1/4"	1 3/8"	Zinc	90
19257G10	BP	1 1/4"	1 1/4"	1 1/4"	1 3/8"	Zinc	90
1925826	BP	3"	4 5/8"	5/16"	1 1/4"	Zinc	90
1925826D	BP	3"	4 5/8"	5/16"	1 1/4"	Zinc	90
19258G10	BP	3"	4 5/8"	5/16"	1 1/4"	Zinc	90
19259G10	BP	3"	4 1/2"	9/16"	1 1/16"	Zinc	38
19259WID	BP	3"	4 1/2"	9/16"	1 1/16"	Zinc	38
19259WN	BP	3"	4 1/2"	9/16"	1 1/16"	Zinc	38
19260G10	BP	128mm	6"	7/16"	1 1/4"	Zinc	74
19260ORB	BP	128mm	6"	7/16"	1 1/4"	Zinc	74
19260WID	BP	128mm	6"	7/16"	1 1/4"	Zinc	74
19260WN	BP	128mm	6"	7/16"	1 1/4"	Zinc	74
19320FB	BP	34mm	1 5/16"	1 5/16"	2 1/16"	Steel	57
19320ORB	BP	34mm	1 5/16"	1 5/16"	2 1/16"	Steel	57
19320R2	BP	34mm	1 5/16"	1 5/16"	2 1/16"	Steel	57
19320WN	BP	34mm	1 5/16"	1 5/16"	2 1/16"	Steel	57
19321ART	BP	66mm	2 3/4"	15/16"	1 1/2"	Steel	57
19321FB	BP	66mm	2 3/4"	15/16"	1 1/2"	Steel	57
19321ORB	BP	66mm	2 3/4"	15/16"	1 1/2"	Steel	57
19321R2	BP	66mm	2 3/4"	15/16"	1 1/2"	Steel	57
19321RB	BP	66mm	2 3/4"	15/16"	1 1/2"	Steel	57
19321WN	BP	66mm	2 3/4"	15/16"	1 1/2"	Steel	57
19322ART	BP	3"	3 5/16"	3/4"	1 9/16"	Steel	57
19322FB	BP	3"	3 5/16"	3/4"	1 9/16"	Steel	57
19322ORB	BP	3"	3 5/16"	3/4"	1 9/16"	Steel	57
19322R2	BP	3"	3 5/16"	3/4"	1 9/16"	Steel	57
19322RB	BP	3"	3 5/16"	3/4"	1 9/16"	Steel	57
19322WN	BP	3"	3 5/16"	3/4"	1 9/16"	Steel	57
19323FB	BP	96mm	4 5/8"	13/16"	13/16"	Steel	57
19323ORB	BP	96mm	4 5/8"	13/16"	13/16"	Steel	57
19323R2	BP	96mm	4 5/8"	13/16"	13/16"	Steel	57
19323WN	BP	96mm	4 5/8"	13/16"	13/16"	Steel	57
19324FB	BP	160mm	7 3/16"	7/8"	7/8"	Steel	57
19324ORB	BP	160mm	7 3/16"	7/8"	7/8"	Steel	57
19324R2	BP	160mm	7 3/16"	7/8"	7/8"	Steel	57
19324WN	BP	160mm	7 3/16"	7/8"	7/8"	Steel	57
19541SS	BP	128mm	7 3/8"	1/2"	1 3/8"	Stainless Steel	32
19010CSG9	BP	3"	5 3/8"	1/2"	1 3/8"	Carbon Steel	32
19011CSG9	BP	96mm	6 1/8"	1/2"	1 3/8"	Carbon Steel	32
19012CSG9	BP	192mm	9 15/16"	1/2"	1 3/8"	Stainless Steel	32
19013CSG9	BP	256mm	13 1/4"	1/2"	1 3/8"	Carbon Steel	32, 100
19014CSG9	BP	320mm	15 3/4"	1/2"	1 3/8"	Carbon Steel	32, 100
19015CSG9	BP	416mm	19 1/2"	1/2"	1 3/8"	Carbon Steel	32, 100
19016CSG9	BP	480mm	22 1/16"	1/2"	1 3/8"	Carbon Steel	32, 100
19017CSG9	BP	544mm	24 9/16"	1/2"	1 3/8"	Carbon Steel	32, 100
19018CSG9	BP	640mm	28 3/8"	1/2"	1 3/8"	Carbon Steel	32, 100
19019CSG9	BP	768mm	33 3/8"	1/2"	1 3/8"	Carbon Steel	32, 100
1950H26	BP	1 1/4"	1 1/4"	1 1/4"	1 3/8"	Solid Brass	129
1950H26D	BP	1 1/4"	1 1/4"	1 1/4"	1 3/8"	Solid Brass	129
1950HAE	BP	1 1/4"	1 1/4"	1 1/4"	1 3/8"	Solid Brass	129

PRODUCT INDEX

Item	Pack Type	Primary Dimension	Length	Width	Projection	Base Material	Page
29379G10	BP	3"	4 3/16"	11/16"	1 5/16"	Zinc	15
29379ORB	BP	3"	4 3/16"	11/16"	1 5/16"	Zinc	15
29385AS	BP	96mm	4 15/16"	11/16"	1 5/16"	Zinc	15
29385CBZ	BP	96mm	4 15/16"	11/16"	1 5/16"	Zinc	15
29385G10	BP	96mm	4 15/16"	11/16"	1 5/16"	Zinc	15
29385ORB	BP	96mm	4 15/16"	11/16"	1 5/16"	Zinc	15
29393AS	BP	128mm	6 1/4"	11/16"	1 3/8"	Zinc	15
29393CBZ	BP	128mm	6 1/4"	11/16"	1 3/8"	Zinc	15
29393G10	BP	128mm	6 1/4"	11/16"	1 3/8"	Zinc	15
29393ORB	BP	128mm	6 1/4"	11/16"	1 3/8"	Zinc	15
29394AS	BP	160mm	7 1/2"	3/4"	1 7/16"	Zinc	15
29394CBZ	BP	160mm	7 1/2"	3/4"	1 7/16"	Zinc	15
29394G10	BP	160mm	7 1/2"	3/4"	1 7/16"	Zinc	15
29394ORB	BP	160mm	7 1/2"	3/4"	1 7/16"	Zinc	15
29395AS	BP	8"	9 3/16"	3/4"	1 1/2"	Zinc	15, 94
29395CBZ	BP	8"	9 3/16"	3/4"	1 1/2"	Zinc	15, 94
29395G10	BP	8"	9 3/16"	3/4"	1 1/2"	Zinc	15, 94
29395ORB	BP	8"	9 3/16"	3/4"	1 1/2"	Zinc	15, 94
29396AS	BP	12"	13 3/16"	13/16"	1 5/8"	Zinc	15, 94
29396CBZ	BP	12"	13 3/16"	13/16"	1 5/8"	Zinc	15, 94
29396G10	BP	12"	13 3/16"	13/16"	1 5/8"	Zinc	15, 94
29396ORB	BP	12"	13 3/16"	13/16"	1 5/8"	Zinc	15, 94
29397AS	BP	18"	19 3/16"	7/8"	1 3/4"	Zinc	15, 94
29397CBZ	BP	18"	19 3/16"	7/8"	1 3/4"	Zinc	15, 94
29397G10	BP	18"	19 3/16"	7/8"	1 3/4"	Zinc	15, 94
29397ORB	BP	18"	19 3/16"	7/8"	1 3/4"	Zinc	15, 94
29398AS	BP	1 1/2"	1 1/2"	1 1/2"	1 1/8"	Zinc	15, 94
29398CBZ	BP	1 1/2"	1 1/2"	1 1/2"	1 1/8"	Zinc	15, 94
29398G10	BP	1 1/2"	1 1/2"	1 1/2"	1 1/8"	Zinc	15, 94
29398ORB	BP	1 1/2"	1 1/2"	1 1/2"	1 1/8"	Zinc	15, 94
29409BBZ	BP	3"	4 3/8"	3/8"	1 3/16"	Zinc	30
29409G10	BP	3"	4 3/8"	3/8"	1 3/16"	Zinc	30
29415BBZ	BP	96mm	5 1/8"	7/16"	1 1/4"	Zinc	30
29415G10	BP	96mm	5 1/8"	7/16"	1 1/4"	Zinc	30
29416BBZ	BP	128mm	6 3/8"	1/2"	1 3/8"	Zinc	30
29416G10	BP	128mm	6 3/8"	1/2"	1 3/8"	Zinc	30
29423BBZ	BP	160mm	7 5/8"	1/2"	1 7/16"	Zinc	30
29423G10	BP	160mm	7 5/8"	1/2"	1 7/16"	Zinc	30
29424BBZ	BP	8"	9 3/8"	9/16"	1 5/8"	Zinc	30, 98
29424G10	BP	8"	9 3/8"	9/16"	1 5/8"	Zinc	30, 98
29425BBZ	BP	12"	13 3/8"	5/8"	1 3/4"	Zinc	30, 98
29425G10	BP	12"	13 3/8"	5/8"	1 3/4"	Zinc	30, 98
29426BBZ	BP	18"	19 3/8"	11/16"	1 15/16"	Zinc	30, 98
29426G10	BP	18"	19 3/8"	11/16"	1 15/16"	Zinc	30, 98
29439G10	BP	3"	3 11/16"	1/2"	1 1/8"	Zinc	37
29445G10	BP	96mm	4 1/2"	1/2"	1 1/4"	Zinc	37
29446G10	BP	128mm	5 7/8"	1/2"	1 3/8"	Zinc	37

The dimensional information provided here should be verified with the actual product prior to drilling or attempting to install the hardware. All dimensions listed are within the nearest 1/16th of an inch. Please direct any questions you may have on the installation process to Amerock Customer Service.

PRODUCT INDEX

Item	Pack Type	Primary Dimension	Length	Width	Projection	Base Material	Page
3180TMG10	PK	3/4"	2 1/2"	1 5/8"	1/4"	Steel	194
3180TMG9	CM, PK	3/4"	2 1/2"	1 5/8"	1/4"	Steel	194
3180TMORB	PK	3/4"	2 1/2"	1 5/8"	1/4"	Steel	194
3180TMPB	PK	3/4"	2 1/2"	1 5/8"	1/4"	Steel	194
3180TMWI	CM, PK	3/4"	2 1/2"	1 5/8"	1/4"	Steel	194
3180UBDAE	CM	3/4"	2 7/16"	1 5/8"	1/4"	Steel	193
32301BR	BP, LL	-	1 9/16"	1 5/8"	3/4"	Acetal / Steel	203
32301W	BP	-	1 9/16"	1 5/8"	3/4"	Acetal / Steel	203
33772AL	BP, LL	-	1 1/2"	13/16"	1/2"	-	203
3401AC	BP	3 1/4"	5 1/16"	1"	3/4"	Zinc	130
3401CB	BP	3 1/4"	5 1/16"	1"	3/4"	Zinc	130
3403AC	BP	1 1/4"	-	-	3/4"	Zinc	130
3403CB	BP	1 1/4"	-	-	3/4"	Zinc	130
3404AC	BP	Flush	3 1/2"	1 1/2"	1/8"	Steel	190
3404CB	BP, LL	Flush	3 1/2"	1 1/2"	1/8"	Steel	190
3406AC	BP	3/8"	0"	-	-	-	190
34133	BP	1 1/2"	1 1/2"	1 1/2"	5/8"	Zinc	129
341326	BP	1 1/2"	1 1/2"	1 1/2"	5/8"	Zinc	129
34143	BP	1 3/4"	-	-	3/4"	Zinc	129
341426	BP	1 3/4"	-	-	3/4"	Zinc	129
34153	BP	2 3/4"	3 7/16"	3/4"	15/16"	Zinc	131
341526	BP	2 3/4"	3 7/16"	3/4"	15/16"	Zinc	131
34163	BP	3"	3 15/16"	7/16"	7/8"	Zinc	131
341626	BP	3"	3 15/16"	7/16"	7/8"	Zinc	131
34173	BP, LL	3/8"	-	-	-	Steel	188
341726	BP, LL	3/8"	-	-	-	Steel	188
3417G10	BP, LL	3/8"	-	-	-	Steel	188
3417ORB	BP	3/8"	-	-	-	Steel	188
3421BB	BP	3"	4 3/4"	1"	1"	Zinc	134
3423BB	BP	1 1/4"	-	-	1"	Zinc	140
3424BB	BP	3"	5"	1/2"	1"	Zinc	143
3425BB	BP	3"	3 1/4"	2 1/2"	1/2"	Zinc	144
3426BB	BP	3"	5 3/4"	1 1/8"	1/8"	Zinc	142
34283	BP, LL, M	3/8"	2 3/4"	2 3/16"	3/4"	Steel	180
342826	BP	3/8"	2 3/4"	2 3/16"	3/4"	Steel	180
3428AS	BP	3/8"	2 3/4"	2 3/16"	3/4"	Steel	180
3428BB	BP, LL, M	3/8"	2 3/4"	2 3/16"	3/4"	Steel	180
3428FB	BP	3/8"	2 3/4"	2 3/16"	3/4"	Steel	180
3428G10	BP, LL	3/8"	2 3/4"	2 3/16"	3/4"	Steel	180
3428GB	BP	3/8"	2 3/4"	2 3/16"	3/4"	Steel	180
3428ORB	BP, LL	3/8"	2 3/4"	2 3/16"	3/4"	Steel	180
3428W	BP	3/8"	2 3/4"	2 3/16"	3/4"	Steel	180
3428WN	BP	3/8"	2 3/4"	2 3/16"	3/4"	Steel	180
34293	BP, LL, M	Variable	2 3/4"	1 13/16"	3/4"	-	178
342926	BP	Variable	2 3/4"	1 13/16"	3/4"	-	178
3429AS	BP	Variable	2 3/4"	1 13/16"	3/4"	-	178
3429BB	BP, LL, M	Variable	2 3/4"	1 13/16"	3/4"	-	178

The dimensional information provided here should be verified with the actual product prior to drilling or attempting to install the hardware. All dimensions listed are within the nearest 1/16th of an inch. Please direct any questions you may have on the installation process to Amerock Customer Service.

PRODUCT INDEX

Item	Pack Type	Primary Dimension	Length	Width	Projection	Base Material	Page
53704PWT	BP	3"	3 13/16"	5/16"	1 1/16"	Zinc	25
53705G10	BP	96mm	4 9/16"	5/16"	1 1/8"	Zinc	25
53705ORB	BP	96mm	4 9/16"	5/16"	1 1/8"	Zinc	25
53705PWT	BP	96mm	4 9/16"	5/16"	1 1/8"	Zinc	25
53710G10	BP	1 1/4"	1 1/4"	1 1/4"	1 1/8"	Zinc	18
53710GPH	BP	1 1/4"	1 1/4"	1 1/4"	1 1/8"	Zinc	18
53711G10	BP	3"	4"	5/16"	1 3/16"	Zinc	18
53711GPH	BP	3"	4"	5/16"	1 3/16"	Zinc	18
53712G10	BP	96mm	4 13/16"	5/16"	1 3/16"	Zinc	18
53712GPH	BP	96mm	4 13/16"	5/16"	1 3/16"	Zinc	18
53713G10	BP	128mm	6 1/16"	5/16"	1 1/4"	Zinc	18
53713GPH	BP	128mm	6 1/16"	5/16"	1 1/4"	Zinc	18
53714G10	BP	160mm	7 5/16"	5/16"	1 5/16"	Zinc	18
53714GPH	BP	160mm	7 5/16"	5/16"	1 5/16"	Zinc	18
53715G10	BP	3"	4 9/16"	7/8"	13/16"	Zinc	18
53715GPH	BP	3"	4 9/16"	7/8"	13/16"	Zinc	18
53716G10	BP	96mm	5 5/16"	7/8"	13/16"	Zinc	18
53716GPH	BP	96mm	5 5/16"	7/8"	13/16"	Zinc	18
53717G10	BP	34mm	1 5/16"	7/16"	1 1/16"	Zinc	17
53717GPH	BP	34mm	1 5/16"	7/16"	1 1/16"	Zinc	17
53718G10	BP	1 1/4"	1 1/4"	1 1/4"	1 1/8"	Zinc	17
53718GPH	BP	1 1/4"	1 1/4"	1 1/4"	1 1/8"	Zinc	17
53719G10	BP	3"	4 1/4"	5/16"	1 1/4"	Zinc	17
53719GPH	BP	3"	4 1/4"	5/16"	1 1/4"	Zinc	17
53720G10	BP	96mm	5 1/16"	3/8"	1 5/16"	Zinc	17
53720GPH	BP	96mm	5 1/16"	3/8"	1 5/16"	Zinc	17
53721G10	BP	128mm	6 5/16"	3/8"	1 5/16"	Zinc	17
53721GPH	BP	128mm	6 5/16"	3/8"	1 5/16"	Zinc	17
53722G10	BP	160mm	7 5/8"	7/16"	1 3/8"	Zinc	17
53722GPH	BP	160mm	7 5/8"	7/16"	1 3/8"	Zinc	17
53801G10	BP	96mm	4 3/8"	1 5/16"	1"	Zinc	19
53801ORB	BP	96mm	4 3/8"	1 5/16"	1"	Zinc	19
53801WN	BP	96mm	4 3/8"	1 5/16"	1"	Zinc	19
53802G10	BP	128mm	5 11/16"	9/16"	1 3/16"	Zinc	19
53802ORB	BP	128mm	5 11/16"	9/16"	1 3/16"	Zinc	19
53802WN	BP	128mm	5 11/16"	9/16"	1 3/16"	Zinc	19
53803G10	BP	160mm	7"	11/16"	1 1/4"	Zinc	19
53803ORB	BP	160mm	7"	11/16"	1 1/4"	Zinc	19
53803WN	BP	160mm	7"	11/16"	1 1/4"	Zinc	19
53804G10	BP	8"	8 7/8"	13/16"	1 11/16"	Zinc	19, 96
53804ORB	BP	8"	8 7/8"	13/16"	1 11/16"	Zinc	19, 96
53804WN	BP	8"	8 7/8"	13/16"	1 11/16"	Zinc	19, 96
53805G10	BP	12"	13"	7/8"	1 3/4"	Zinc	19, 96
53805ORB	BP	12"	13"	7/8"	1 3/4"	Zinc	19, 96
53805WN	BP	12"	13"	7/8"	1 3/4"	Zinc	19, 96
53806G10	BP	18"	19 1/4"	1 3/16"	1 13/16"	Zinc	19, 96
53806ORB	BP	18"	19 1/4"	1 3/16"	1 13/16"	Zinc	19, 96
53806WN	BP	18"	19 1/4"	1 3/16"	1 13/16"	Zinc	19, 96

The dimensional information provided here should be verified with the actual product prior to drilling or attempting to install the hardware. All dimensions listed are within the nearest 1/16th of an inch. Please direct any questions you may have on the installation process to Amerock Customer Service.

PRODUCT INDEX

Item	Pack Type	Primary Dimension	Length	Width	Projection	Base Material	Page
55220GPH	BP	2 5/8"	2 5/8"	3/4"	1 3/8"	Zinc	116
55220ORB	BP	2 5/8"	2 5/8"	3/4"	1 3/8"	Zinc	116
55220WN	BP	2 5/8"	2 5/8"	3/4"	1 3/8"	Zinc	116
552212G10	BP	3"	3"	7/8"	1 9/16"	Zinc	108, 116
552212GPH	BP	3"	3"	7/8"	1 9/16"	Zinc	108, 116
552212ORB	BP	3"	3"	7/8"	1 9/16"	Zinc	108, 116
552212WN	BP	3"	3"	7/8"	1 9/16"	Zinc	108, 116
55222G10	BP	3"	3 5/8"	9/16"	1 1/4"	Zinc	116
55222GPH	BP	3"	3 5/8"	9/16"	1 1/4"	Zinc	116
55222ORB	BP	3"	3 5/8"	9/16"	1 1/4"	Zinc	116
55222WN	BP	3"	3 5/8"	9/16"	1 1/4"	Zinc	116
55223G10	BP	96mm	4 1/2"	5/8"	1 3/8"	Zinc	116
55223GPH	BP	96mm	4 1/2"	5/8"	1 3/8"	Zinc	116
55223ORB	BP	96mm	4 1/2"	5/8"	1 3/8"	Zinc	116
55223WN	BP	96mm	4 1/2"	5/8"	1 3/8"	Zinc	116
55224G10	BP	128mm	5 3/4"	11/16"	1 9/16"	Zinc	116
55224GPH	BP	128mm	5 3/4"	11/16"	1 9/16"	Zinc	116
55224ORB	BP	128mm	5 3/4"	11/16"	1 9/16"	Zinc	116
55224WN	BP	128mm	5 3/4"	11/16"	1 9/16"	Zinc	116
55225G10	BP	160mm	7 1/16"	3/4"	1 3/4"	Zinc	116
55225GPH	BP	160mm	7 1/16"	3/4"	1 3/4"	Zinc	116
55225ORB	BP	160mm	7 1/16"	3/4"	1 3/4"	Zinc	116
55225WN	BP	160mm	7 1/16"	3/4"	1 3/4"	Zinc	116
55226G10	BP	8"	8 15/16"	15/16"	2 1/16"	Zinc	108, 116
55226GPH	BP	8"	8 15/16"	15/16"	2 1/16"	Zinc	108, 116
55226ORB	BP	8"	8 15/16"	15/16"	2 1/16"	Zinc	108, 116
55226WN	BP	8"	8 15/16"	15/16"	2 1/16"	Zinc	108, 116
55227G10	BP	12"	13 1/16"	1 1/16"	2 7/16"	Zinc	108, 116
55227GPH	BP	12"	13 1/16"	1 1/16"	2 7/16"	Zinc	108, 116
55227ORB	BP	12"	13 1/16"	1 1/16"	2 7/16"	Zinc	108, 116
55227WN	BP	12"	13 1/16"	1 1/16"	2 7/16"	Zinc	108, 116
55228G10	BP	18"	19 3/16"	1 1/4"	2 3/4"	Zinc	108, 116
55228GPH	BP	18"	19 3/16"	1 1/4"	2 3/4"	Zinc	108, 116
55228ORB	BP	18"	19 3/16"	1 1/4"	2 3/4"	Zinc	108, 116
55228WN	BP	18"	19 3/16"	1 1/4"	2 3/4"	Zinc	108, 116
55243G10	BP	96mm	4 1/5"	4/9"	1 3/7"	Zinc	117
55243ORB	BP	96mm	4 1/5"	4/9"	1 3/7"	Zinc	117
55244G10	BP	128mm	5 9/16"	11/16"	1 9/16"	Zinc	117
55244ORB	BP	128mm	5 9/16"	11/16"	1 9/16"	Zinc	117
55245G10	BP	160mm	176.43/25.4	13/16"	1 11/16"	Zinc	117
55245ORB	BP	160mm	176.43/25.4	13/16"	1 11/16"	Zinc	117
55246G10	BP	8"	8 11/16"	7/8"	2"	Zinc	108, 117
55246ORB	BP	8"	8 11/16"	7/8"	2"	Zinc	108, 117
55247G10	BP	12"	12 13/16"	1"	2 1/4"	Zinc	108, 117
55247ORB	BP	12"	12 13/16"	1"	2 1/4"	Zinc	108, 117
55248G10	BP	18"	18 15/16"	1 3/16"	2 3/8"	Zinc	108, 117
55248ORB	BP	18"	18 15/16"	1 3/16"	2 3/8"	Zinc	108, 117
55266AORB	BP	1"	1"	1"	–	Zinc / Tempered Glass	58
55266CG10	BP	1"	1"	1"	–	Zinc / Tempered Glass	58
55268ABBR	BP	1 1/4"	1 1/4"	1 1/4"	1 1/2"	Zinc / Tempered Glass	58
55268AORB	BP	1 1/4"	1 1/4"	1 1/4"	1 1/2"	Zinc / Tempered Glass	58
55268CBBR	BP	1 1/4"	1 1/4"	1 1/4"	1 1/2"	Zinc / Tempered Glass	58
55268CG10	BP	1 1/4"	1 1/4"	1 1/4"	1 1/2"	Zinc / Tempered Glass	58
55268CGB	BP	1 1/4"	1 1/4"	1 1/4"	1 1/2"	Zinc / Tempered Glass	58
55268CORB	BP	1 1/4"	1 1/4"	1 1/4"	1 1/2"	Zinc / Tempered Glass	58
55270BBR	BP	1 5/16"	1 5/16"	1 5/16"	1"	Zinc	73
55270G10	BP	1 5/16"	1 5/16"	1 5/16"	1"	Zinc	73
55270ORB	BP	1 5/16"	1 5/16"	1 5/16"	1"	Zinc	73
55271BBR	BP	1 3/16"	1 3/16"	1 3/16"	1 1/16"	Zinc	73
55271G10	BP	1 3/16"	1 3/16"	1 3/16"	1 1/16"	Zinc	73
55271ORB	BP	1 3/16"	1 3/16"	1 3/16"	1 1/16"	Zinc	73
55272BBR	BP	1 5/8"	1 5/8"	1 5/8"	1 1/4"	Zinc	73, 105
55272G10	BP	1 5/8"	1 5/8"	1 5/8"	1 1/4"	Zinc	73, 105
55272ORB	BP	1 5/8"	1 5/8"	1 5/8"	1 1/4"	Zinc	73, 105
55273BBR	BP	1 1/2"	1 1/2"	1 1/2"	1 3/8"	Zinc	73, 105
55273G10	BP	1 1/2"	1 1/2"	1 1/2"	1 3/8"	Zinc	73, 105
55273ORB	BP	1 1/2"	1 1/2"	1 1/2"	1 3/8"	Zinc	73, 105
55274BBR	BP	1 13/16"	1 13/16"	1 3/8"	3/4"	Zinc	73
55274G10	BP	1 13/16"	1 13/16"	1 3/8"	3/4"	Zinc	73
55274ORB	BP	1 13/16"	1 13/16"	1 3/8"	3/4"	Zinc	73
55275BBR	BP	3"	3 3/4"	7/16"	1 1/8"	Zinc	73
55275G10	BP	3"	3 3/4"	7/16"	1 1/8"	Zinc	73
55275ORB	BP	3"	3 3/4"	7/16"	1 1/8"	Zinc	73
55276BBR	BP	96mm	4 5/8"	1/2"	1 3/16"	Zinc	73
55276G10	BP	96mm	4 5/8"	1/2"	1 3/16"	Zinc	73
55276ORB	BP	96mm	4 5/8"	1/2"	1 3/16"	Zinc	73
55277BBR	BP	128mm	5 15/16"	1/2"	1 1/4"	Zinc	73
55277G10	BP	128mm	5 15/16"	1/2"	1 1/4"	Zinc	73
55277ORB	BP	128mm	5 15/16"	1/2"	1 1/4"	Zinc	73
55278BBR	BP	160mm	7 1/4"	1/2"	1 1/4"	Zinc	73
55278G10	BP	160mm	7 1/4"	1/2"	1 1/4"	Zinc	73
55278ORB	BP	160mm	7 1/4"	1/2"	1 1/4"	Zinc	73
55279BBR	BP	8"	9 3/8"	9/16"	1 11/16"	Zinc	73, 105
55279G10	BP	8"	9 3/8"	9/16"	1 11/16"	Zinc	73, 105
55279ORB	BP	8"	9 3/8"	9/16"	1 11/16"	Zinc	73, 105
55280BBR	BP	12"	13 3/8"	9/16"	1 11/16"	Zinc	73, 105
55280G10	BP	12"	13 3/8"	9/16"	1 11/16"	Zinc	73, 105
55280ORB	BP	12"	13 3/8"	9/16"	1 11/16"	Zinc	73, 105
55281BBR	BP	18"	19 3/8"	9/16"	1 11/16"	Zinc	73, 105
55281G10	BP	18"	19 3/8"	9/16"	1 11/16"	Zinc	73, 105
55281ORB	BP	18"	19 3/8"	9/16"	1 11/16"	Zinc	73, 105
55311AP	BP	36mm	1 7/16"	13/16"	1 1/8"	Zinc	16
55311DOB	BP	36mm	1 7/16"	13/16"	1 1/8"	Zinc	16
55311PN	BP	36mm	1 7/16"	13/16"	1 1/8"	Zinc	16

The dimensional information provided here should be verified with the actual product prior to drilling or attempting to install the hardware. All dimensions listed are within the nearest 1/16th of an inch. Please direct any questions you may have on the installation process to Amerock Customer Service.

PRODUCT INDEX

Item	Pack Type	Primary Dimension	Length	Width	Projection	Base Material	Page
643AE	BP	1 1/16"	1 1/16"	1 1/16"	15/16"	Zinc	135
644AE	BP, CM	3"	5 1/16"	5/8"	7/8"	Zinc	133
69120	-	1 1/4"	-	-	7/8"	Ceramic	152
69125	-	1 1/2"	-	-	1"	Ceramic	152
69128	-	1 1/2"	-	-	15/16"	Ceramic	152
69141	-	3"	4 7/8"	11/16"	1 1/4"	Zinc	147
69143	-	3"	4 7/8"	11/16"	1 1/4"	Zinc	147
69151G10	BP	1 7/16"	-	-	16/21"	Other	129
69152	-	1 1/2"	-	-	3/4"	Zinc	129
69153G10	BP	3"	4 1/64"	42/97"	37/47"	Zinc	131
69154	-	3"	4"	7/16"	3/4"	Zinc	131
69169	-	1 1/2"	-	-	3/4"	Zinc	135
69191	-	1 1/4"	-	-	-	Steel	187
69192	-	1 1/4"	-	-	-	Steel	187
69193	-	1 1/4"	-	-	-	Steel	188
69194	-	1 1/4"	-	-	-	Steel	188
69195	-	1 1/4"	-	-	-	Steel	188
69201	-	1 1/4"	-	-	-	Steel	177
69228	-	1 1/4"	-	-	1"	Ceramic	146
69267	-	1 1/16"	-	-	13/16"	Zinc	140
69268	-	1 5/16"	-	-	1 1/16"	Zinc	140
70612AE	BP	2 1/2"	4 3/8"	2 3/16"	5/8"	Ceramic	144
70016NB2G	C	16"	16"	1/2"	1 3/4"	Steel	209
70018NB2G	C	18"	18"	1/2"	1 3/4"	Steel	209
70020NB2G	C	20"	20"	1/2"	1 3/4"	Steel	209
70022NB2G	C	22"	22"	1/2"	1 3/4"	Steel	209
7103	BP	1 1/4"	1 1/4"	1 1/4"	1"	Zinc	126
71026	BP	1 1/4"	1 1/4"	1 1/4"	1"	Zinc	126
714ABS	-	3"	4 1/2"	3/4"	7/8"	Zinc	134
71283	CM	3/8"	2 3/4"	2 3/16"	3/4"	Steel / Delrin 500	181
7128BB	CM	3/8"	2 3/4"	2 3/16"	3/4"	Steel / Delrin 500	181
7128BK	BP	3/8"	2 3/4"	2 3/16"	3/4"	Steel / Delrin 500	181
7128G10	CM	3/8"	2 3/4"	2 3/16"	3/4"	Steel / Delrin 500	181
7128ORB	CM	3/8"	2 3/4"	2 3/16"	3/4"	Steel / Delrin 500	181
7128W	BP, LL	3/8"	2 3/4"	2 3/16"	3/4"	Steel / Delrin 500	181
7128WI	BP	3/8"	2 3/4"	2 3/16"	3/4"	Steel / Delrin 500	181
71393	CM	Variable	2 3/4"	2 1/8"	11/16"	Steel / Delrin 500	178
713914	BP, CM	Variable	2 3/4"	2 1/8"	11/16"	Steel / Delrin 500	178
7139BB	CM, D	Variable	2 3/4"	2 1/8"	11/16"	Steel / Delrin 500	178
7139BK	BP	Variable	2 3/4"	2 1/8"	11/16"	Steel / Delrin 500	178
7139G10	CM	Variable	2 3/4"	2 1/8"	11/16"	Steel / Delrin 500	178
7139ORB	CM	Variable	2 3/4"	2 1/8"	11/16"	Steel / Delrin 500	178
7139W	BP, LL	Variable	2 3/4"	2 1/8"	11/16"	Steel / Delrin 500	178
7139WI	BP	Variable	2 3/4"	2 1/8"	11/16"	Steel / Delrin 500	178
7165AC14	-	Full, Clip on	2 3/4"	1 3/8"	3/8"	Steel	197
72530	BP	1 5/16"	2 5/16"	3 5/16"	1 3/16"	-	26
72730	BP	1 1/4"	1 1/4"	1 1/4"	1 1/4"	Porcelain	146

The dimensional information provided here should be verified with the actual product prior to drilling or attempting to install the hardware. All dimensions listed are within the nearest 1/16th of an inch. Please direct any questions you may have on the installation process to Amerock Customer Service.

PRODUCT INDEX

Item	Pack Type	Primary Dimension	Length	Width	Projection	Base Material	Page
76303	BP	Variable	0"	-	-	-	180
763026	BP	Variable	2 3/4"	2"	5 3/4"	Steel	180
7630AC	BP	Variable	0"	-	-	-	180
7630AE	BP	Variable	0"	-	-	-	180
7630BB	BP, CM	Variable	0"	-	-	-	180
76783	BP, LL	Variable	2 3/4"	1 3/4"	3/4"	Steel	187
7678BB	BP	Variable	2 3/4"	1 3/4"	3/4"	Steel	187
762093	BP	1 1/8"	-	-	1"	Zinc	135
76209AE	BP	1 1/8"	-	-	1"	Zinc	135
76223AE	BP, CM	3"	5 1/4"	5/8"	1"	Zinc	134
7624226W	BP	3"	5 7/8"	5/8"	1 3/8"	Zinc	149
762430B	BP	3"	5 7/8"	5/8"	1 3/8"	Zinc	147
7624426W	BP	1 1/4"	-	-	1"	Zinc	148
76244AB	BP	1 1/4"	-	-	1"	Zinc	148
7624403	BP	1 1/4"	-	-	1"	Zinc	148
762440B	BP	1 1/4"	-	-	1"	Zinc	148
76244W3	BP	1 1/4"	-	-	1"	Zinc	148
76244WB	BP	1 1/4"	-	-	1"	Zinc	148
7624526W	BP	3"	5 1/16"	5/8"	1 1/3"	Zinc	149
76245AB	BP	3"	5 1/16"	5/8"	1 1/3"	Zinc	147
7624503	BP	3"	5 1/16"	5/8"	1 1/3"	Zinc	147
762450B	BP	3"	5 1/16"	5/8"	1 1/3"	Zinc	147
76245W3	BP	3"	5 1/16"	5/8"	1 1/3"	Zinc	147
76245WB	BP	3"	5 1/16"	5/8"	1 1/3"	Zinc	147
7624626W	BP	1 1/4"	-	-	1"	Zinc	146
76246W3	BP	1 1/4"	-	-	1"	Zinc	146
762473	BP	3"	5 3/4"	15/16"	1/8"	Zinc	69
7624726	BP	3"	5 3/4"	15/16"	1/8"	Zinc	69
76247BB	BP	3"	5 3/4"	15/16"	1/8"	Zinc	69
76270G9	BP	1 1/2"	-	-	7/8"	Zinc	131
76272G9	BP	3"	5 3/4"	1/2"	1"	Zinc	127
762733	BP	3"	5 1/4"	5/8"	1"	Zinc	127
76273R1	BP, CM	3"	5 1/4"	5/8"	1"	Zinc	127
762803	BP	3"	5"	5/8"	1"	Zinc	127
76280GW	BP	3"	5"	5/8"	1"	Zinc	127
76280MB	BP	3"	5"	5/8"	1"	Zinc	127
76280R1	BP, CM	3"	5"	5/8"	1"	Zinc	127
76290R1	BP	3"	5 1/2"	3/4"	1"	Zinc	136
76291R1	BP	1 1/4"	-	-	1"	Zinc	140
76294AS	BP	1 3/16"	-	-	3/4"	Zinc	140
76294G10	BP	1 3/16"	-	-	3/4"	Zinc	140
76294R1	BP	1 3/16"	-	-	3/4"	Zinc	140
76295R1	BP	3"	5"	1"	1"	Zinc	66
763123	BP	4"	4 1/4"	1/4"	1 1/4"	Brass	132
7631226	BP	4"	4 1/4"	1/4"	1 1/4"	Brass	132
7631226D	BP	4"	4 1/4"	1/4"	1 1/4"	Brass	132
76312G10	BP	4"	4 1/4"	1/4"	1 1/4"	Brass	132

The dimensional information provided here should be verified with the actual product prior to drilling or attempting to install the hardware. All dimensions listed are within the nearest 1/16th of an inch. Please direct any questions you may have on the installation process to Amerock Customer Service.

PRODUCT INDEX

Table with 8 columns: Item, Pack Type, Primary Dimension, Length, Width, Projection, Base Material, Page. Rows include items like 802PA, 802PBK, 802PW, etc.

Table with 8 columns: Item, Pack Type, Primary Dimension, Length, Width, Projection, Base Material, Page. Rows include items like 875AB, 875AS, 875G10, etc.

PRODUCT INDEX

Table with 8 columns: Item, Pack Type, Primary Dimension, Length, Width, Projection, Base Material, Page. Rows include items like 91557M3, 91657BB, 91657G10, etc.

Table with 8 columns: Item, Pack Type, Primary Dimension, Length, Width, Projection, Base Material, Page. Rows include items like 9364G10, 9365ART, 9365G10, etc.

The dimensional information provided here should be verified with the actual product prior to drilling or attempting to install the hardware. All dimensions listed are within the nearest 1/16th of an inch. Please direct any questions you may have on the installation process to Amerock Customer Service.

The dimensional information provided here should be verified with the actual product prior to drilling or attempting to install the hardware. All dimensions listed are within the nearest 1/16th of an inch. Please direct any questions you may have on the installation process to Amerock Customer Service.



EST. 1929

Amerock® creates decorative hardware solutions that inspire, coordinate and help homeowners express their individual style and personality.

CUSTOMER SERVICE – USA

4110 Premier Drive
High Point, NC 27265
1.800.435.6959

CUSTOMER SERVICE – CANADA

586 Argus Rd.
Oakville, Ontario
L6J 3J3
1.800.435.6959
amerocksupport@newellco.com

CORPORATE

3 Glenlake Parkway
Atlanta, GA 30328
1.678.404.3300

www.amerock.com

NewellRubbermaid
Brands That Matter™

