

Hydro Multi-B

Installation and operating instructions



WATER QUALITY
Drinking Water System Component
NSF / ANSI 61
NSF / ANSI 372



be
think
innovate

Original installation and operating instructions.

CONTENTS

	Page
1. Symbols used in this document	2
2. Limited warranty	3
3. Product introduction	3
3.1 Introduction	3
3.2 Delivery and handling	4
3.3 Applications	4
3.4 Features and benefits	5
4. Delivery and handling	5
4.1 Delivery	5
4.2 Handling	5
5. Identification	6
5.1 Nameplate	6
5.2 Type key	6
6. Installation	7
6.1 Mechanical installation	7
6.2 Electrical installation	8
7. Operation	9
7.1 User interface	9
8. Startup	11
8.1 Positive inlet pressure startup procedure	11
8.2 Flooded suction and suction lift startup procedures	11
9. Operating modes	12
9.1 Local mode, external stop not activated	12
9.2 Local mode, external stop activated	12
9.3 Remote-controlled, external stop not activated	13
9.4 Remote-controlled, external stop activated	13
10. Functions	14
10.1 General functions	14
10.2 Functions for constant-pressure systems	14
11. Data communication	15
12. Maintenance and service	15
12.1 Maintenance	15
12.2 Frost protection	15
12.3 Service	16
12.4 Overview of inputs and outputs	16
13. Fault finding	18
14. Maintenance	19
14.1 Pumps	19
14.2 CU 323	19
15. Frost protection	19
16. Taking out of operation	19
17. Technical data	19
17.1 Pressure	19
17.2 Temperature	19
17.3 Relative humidity	19
17.4 Sound pressure level	20
18. Electrical data	20
18.1 Disposal	20



Warning

Prior to installation, read these installation and operating instructions. Installation and operation must comply with local regulations and accepted codes of good practice.

Warning

The use of this product requires experience with and knowledge of the product.



Persons with reduced physical, sensory or mental capabilities must not use this product, unless they are under supervision or have been instructed in the use of the product by a person responsible for their safety.

Children must not use or play with this product.

1. Symbols used in this document



Warning

If these safety instructions are not observed, it may result in personal injury.



Warning

The surface of the product may be so hot that it may cause burns or personal injury.



Caution

If these safety instructions are not observed, it may result in malfunction or damage to the equipment.

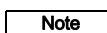

Note

Notes or instructions that make the job easier and ensure safe operation.

2. Limited warranty

Products manufactured by GRUNDFOS PUMPS CORPORATION (Grundfos) are warranted to the original user only to be free of defects in material and workmanship for a period of 24 months from date of installation, but not more than 30 months from date of manufacture. Grundfos' liability under this warranty shall be limited to repairing or replacing at Grundfos' option, without charge, F.O.B. Grundfos' factory or authorized service station, any product of Grundfos' manufacture. Grundfos will not be liable for any costs of removal, installation, transportation, or any other charges which may arise in connection with a warranty claim. Products which are sold but not manufactured by Grundfos are subject to the warranty provided by the manufacturer of said products and not by Grundfos' warranty. Grundfos will not be liable for damage or wear to products caused by abnormal operating conditions, accident, abuse, misuse, unauthorized alteration or repair, or if the product was not installed in accordance with Grundfos' printed installation and operating instructions.

To obtain service under this warranty, the defective product must be returned to the distributor or dealer of Grundfos' products from which it was purchased together with proof of purchase and installation date, failure date, and supporting installation data. Unless otherwise provided, the distributor or dealer will contact Grundfos or an authorized service station for instructions. Any defective product to be returned to Grundfos or a service station must be sent freight prepaid; documentation supporting the warranty claim and/or a Return Material Authorization must be included if so instructed.

GRUNDFOS WILL NOT BE LIABLE FOR ANY INCIDENTAL OR CONSEQUENTIAL DAMAGES, LOSSES, OR EXPENSES ARISING FROM INSTALLATION, USE, OR ANY OTHER CAUSES. THERE ARE NO EXPRESS OR IMPLIED WARRANTIES, INCLUDING MERCHANTABILITY OR FITNESS FOR A PARTICULAR PURPOSE, WHICH EXTEND BEYOND THOSE WARRANTIES DESCRIBED OR REFERRED TO ABOVE.

Some jurisdictions do not allow the exclusion or limitation of incidental or consequential damages and some jurisdictions do not allow limit actions on how long implied warranties may last. Therefore, the above limitations or exclusions may not apply to you. This warranty gives you specific legal rights and you may also have other rights which vary from jurisdiction to jurisdiction.

3. Product introduction

3.1 Introduction

As standard, Hydro Multi-B booster systems consist of two to three CM(E) pumps coupled in parallel and mounted on a common base frame with all the necessary fittings and a control cabinet.

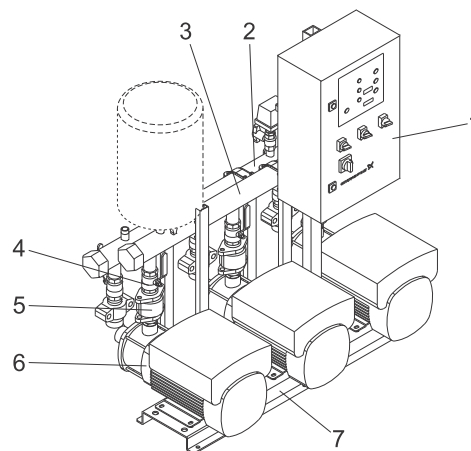

Fig. 1 Front view of Hydro Multi-B booster system

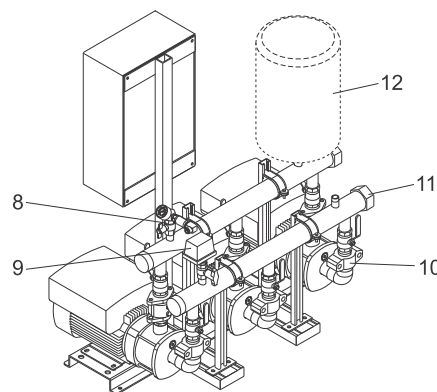

Fig. 2 Back view of Hydro Multi-B booster system

Pos.	Description	Quantity
1	Control cabinet	1
2	Suction manifold (316 SS)	1
3	Discharge manifold (316 SS)	1
4	Isolating valve (Nickel Plated Brass)	2 per pump
5	Non-return valve (Polyacetal (POM))	1 per pump
6	Pump (CME A-version CI/304 SS)	2-3
7	Base frame (304 SS)	1
8	Pressure transmitter and pressure gauge	1
9	Inlet pressure switch and pressure gauge	1
10	Oval flange connection (CME 3 - CME 10)	2 per pump
	Intermediate adapter connection (CME 15)	1 per pump
11	Screw cap or blanking flange	2
12	Optional diaphragm tank (available as an accessory)	n/a

TM05 8632 2513

TM05 8633 2513

3.2 Delivery and handling

3.2.1 Delivery

The Hydro Multi-B booster system is delivered in packaging specially designed for transport by fork-lift truck or a similar vehicle.

The forks of the fork-lift truck must be at least 6 ft (2 m) long.

3.2.2 Handling

The Hydro Multi-B booster system is delivered attached to a wood pallet. It is recommended to move the system on wood pallet to installation location. Detach from wood pallet and slide off wood pallet at final location of installation.



Warning

When lifting the booster system, never use the eyebolts of the motors.

Do not lift the booster system by the manifolds.

Do not stand on the manifolds.

When lifting the booster system, only use suitable lifting equipment that is in good condition and approved for the weight. The weight is stated on the nameplate of the booster system.

3.3 Applications

Grundfos Hydro Multi-B booster systems are for constant pressure boosting applications.

The Hydro Multi-B system is designed to maintain a constant pressure on the discharge side of the pumps. Hydro Multi-B systems for constant-pressure applications adjust the performance according to the demand and keep a constant pressure in the following ways:

- by cutting the required number of pumps in and out
- through continuous adjustment of the speed of the running CME pumps.

3.3.1 Operating principle

The user enters the required pressure of the system (setpoint) via the user interface of the CU 323 control unit. The CU 323 adjusts the system performance according to the feedback received from the pressure transmitter installed on the discharge manifold.

3.3.2 Control variants

Hydro Multi-B systems for constant-pressure applications are available as control variant E. The systems work as described below.

Control variant E

Two to three electronically speed-controlled CME pumps.

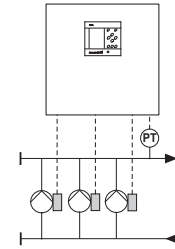

One CME pump in operation.

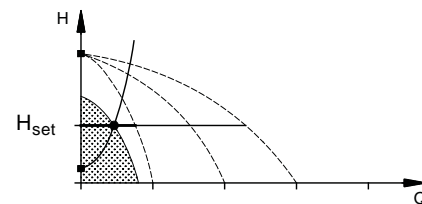

Three CME pumps in operation.

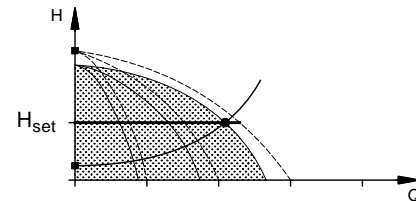

- Control variant E for constant-pressure applications maintains a constant pressure through continuous adjustment of the speed of the pumps.
- The system performance is adjusted to the demand by cutting the required number of pumps in and out and through parallel control of the pumps in operation.

TM03 0993 0905

TM00 7995 2296

TM00 7996 2296

3.4 Features and benefits

The Hydro Multi-B is developed with focus on user-friendliness and ease of operation.

The pumps are controlled via the CU 323 controller which features a simple interface that makes it easy to control and monitor the system.

When the system has been set up, the controller takes care of the daily operation.



Fig. 3 CU 323 controller

The components and design of the Hydro Multi-B have been chosen with focus on robustness and compactness. Every system is thoroughly tested before it leaves the factory.

4. Delivery and handling

4.1 Delivery

The Hydro Multi-B booster system is delivered in a recyclable packaging, specially designed for transport by fork-lift truck or a similar vehicle.

The forks of the fork-lift truck must be at least 6 feet long.

4.2 Handling

Hydro Multi-B booster systems must be lifted as shown in fig. 4. During handling, the lifting point should **always** be above the centre of gravity of the booster system.

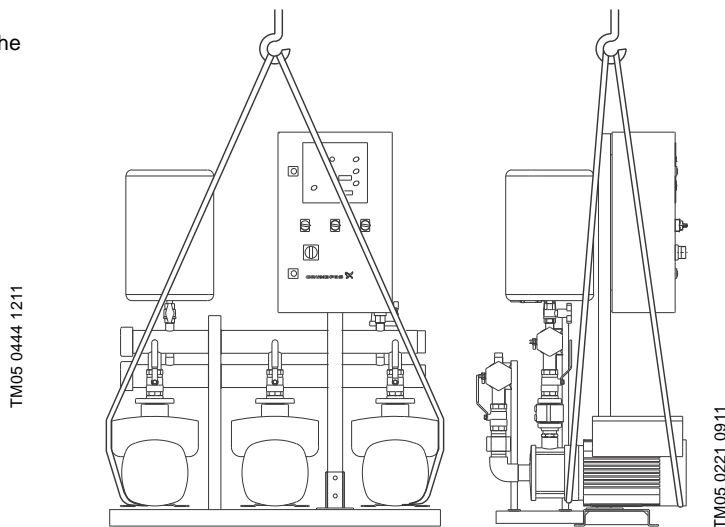

Fig. 4 Correct lifting of Hydro Multi-B



Warning

When lifting the booster system, never use the eyebolts of the motors.

Do not lift the booster system by the manifolds.

Do not stand on the manifolds.

When lifting the booster system, only use suitable lifting equipment that is in good condition and approved for the weight. The weight is stated on the nameplate of the booster system.

5. Identification

This section shows the nameplate, the type key and the codes that can appear in the variant code.

Note

As codes can be combined, a code position may contain more than one code (letter).

5.1 Nameplate

The nameplate is fitted on the base frame.

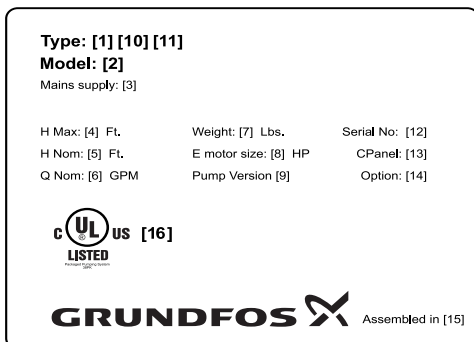

TM05 9777 4413

Fig. 5 Nameplate

Pos.	Description
1	Type designation
2	Model
3	Supply voltage
4	Maximum head [ft]
5	Nominal head [ft]
6	Nominal flow rate [gpm]
7	Weight [lb]
8	Motor power [Hp] of pumps with variable frequency drive
9	Code for pump versions
10	Number of E-pumps
11	E-pump type
12	System serial number
13	Control panel part number
14	Options
15	Country of origin
16	cULus Packaged Pumping Listing (Category QCZJ)

5.2 Type key

Code	Example	Hydro Multi-B	E	2 CME 10-3 A	3 x 460 V, 60 Hz
	Type range				
	System variants				
E	Two to three pumps with integrated variable frequency drive				
	Number of pumps with integrated variable frequency drive, (CME) pump type and pump material				
A	Cast iron (EN-GJL-200)				
	Supply voltage, frequency				

6. Installation



Warning

Installation and operation must comply with local regulations and accepted codes of good practice.

Before installation, check the following:

- Does the booster system correspond to order?
- Are all visible parts intact?

6.1 Mechanical installation

6.1.1 Location

The booster system must be installed in a well ventilated room to ensure sufficient cooling of the pumps and the control cabinet.

Caution

The booster system is not designed for outdoor installation and must not be exposed to direct sunlight.

Note

The booster system must have a 3 ft (1 m) clearance on all sides for inspection and dismantling.

6.1.2 Pipework

Note

The pipework connected to the booster system must be of adequate size.

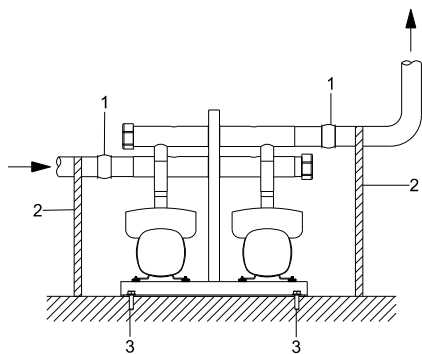

TM04 9900 0211

Fig. 6 Example showing the position of expansion joints, pipe supports and mounting bolts

Pos.	Description
1	Expansion joint
2	Pipe support (and good location for isolating valve)
3	Mounting bolts

Note

Expansion joints, pipe supports and mounting bolts shown in fig. 6 above are not supplied with a standard booster system.

Connect the pipes to the manifolds of the booster system. Either end can be used. Apply sealing compound to the unused end of the manifold, and fit the screw cap. For manifolds with flanges, fit a blanking flange with gasket.

It is advisable to install pipe supports for the suction and discharge pipes. See fig. 6.

To achieve optimum operation and minimize noise and vibration, it may be necessary to consider vibration dampening of the booster system.

Noise and vibration are generated by the rotations in the motor and pump and by the flow in pipework and fittings. The effect on the environment is subjective and depends on correct installation and the state of the other parts of the system.

If booster systems are installed in a building where the first user on the line is close to the booster system, it is advisable to fit expansion joints on the suction and discharge pipes to prevent vibration being transmitted through the pipework. All nuts should be re-tightened prior to start-up.

The pipes must be fastened to parts of the building to ensure that they cannot move or be twisted.

6.1.3 Foundation

The booster system should be positioned on an even and solid surface, for instance a concrete floor or foundation. The booster system must be bolted to the floor or foundation.

Note

As a rule of thumb, the weight of a concrete foundation should be 1.5 x the weight of the booster system.

6.1.4 Vibration dampers

To prevent the transmission of vibrations to buildings, it may be necessary to isolate the booster system foundation from building parts by means of vibration dampers.

Which is the right damper varies from installation to installation, and a wrong damper may increase the vibration level. Vibration dampers should therefore be sized by the supplier of vibration dampers. If the booster system is installed on a base frame with vibration dampers, expansion joints should always be fitted on the manifolds. This is important to prevent the booster system from "hanging" in the pipework.

6.1.5 Expansion joints

Expansion joints are installed with the following purposes:

- to absorb expansions/contractions in the pipework caused by changing liquid temperature
- to reduce mechanical strains in connection with pressure surges in the pipework
- to isolate mechanical structure-borne noise in the pipework (only rubber bellows expansion joints).

Note

Expansion joints must not be installed to compensate for inaccuracies in the pipework such as center displacement of flanges.

Fit expansion joints at a distance of minimum 1 to 1 - 1/2 times the nominal flange diameter from the manifold on the suction as well as on the discharge side. This prevents the development of turbulence in the expansion joints, resulting in better suction conditions and a minimum pressure loss on the discharge side.

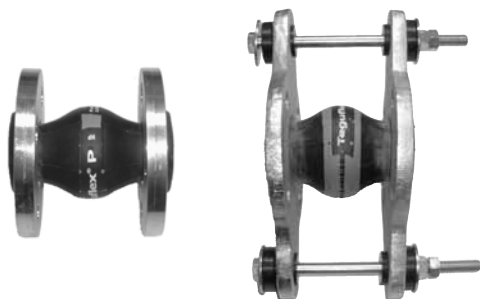

TM02 4981 1902 - TM02 4979 1902

Fig. 7 Examples of rubber bellows expansion joints without and with limit rods

Expansion joints with limit rods can be used to minimize the forces caused by the expansion joints. Expansion joints with limit rods are always recommended for flanges larger than 6 inch.

The pipework should be anchored so that it does not stress the expansion joints and the pump. Follow the supplier's instructions and pass them on to advisers or pipe installers.

6.2 Electrical installation



Warning

The electrical installation must be carried out by an authorized person in accordance with local regulations and the relevant wiring diagram.

- The electrical installation of the booster system must comply with enclosure class UL Type 3R.
- Make sure that the booster system is suitable for the power supply to which it is to be connected.
- Make sure that the wire cross-section corresponds to the specifications in the wiring diagram.

7. Operation

7.1 User interface

The Hydro Multi-B incorporates a CU 323 control unit which enables manual setting and monitoring of the booster system.

Figure 8 shows the user interface for a system with three pumps.

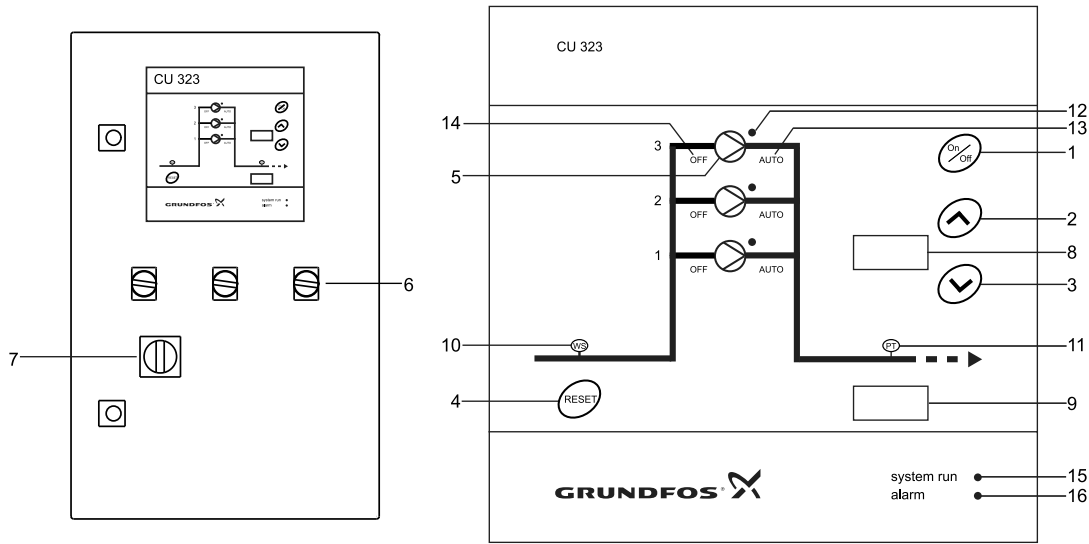





TM05 9283 4413





Fig. 8 User interface of cabinet and CU 323

Pos.	Buttons	Description
1		Changes the system operating mode between "Normal" and "Stop".
2		Increases the setpoint value.
3		Decreases the setpoint value.
4		Resets all alarms.
5		Changes the operating mode of the individual pumps between "AUTO" and "OFF". Each pump in the system has an Auto/Off button.
6		Enables "Emergency/Manual" operation. Note: If a pump is set to "Emergency" operation, it will run at 100 % speed, and the power supply to the CU 323 will be switched off.
7		Switches the power supply to the control cabinet on or off.

Table continued on next page

Table continued from previous page

Pos.	Displays	Description
	Setpoint	Shows the setpoint.
	<i>E.St</i>	External stop: Indicates that the system has been stopped externally via a digital input.
	<i>OFF</i>	Indicates that the system has been set to "OFF".
8	<i>On</i>	Indicates that the system has been set from OFF to ON. "On" is only shown for 3 seconds after which the setpoint will be shown.
	<i>On</i>	Indicates that buttons on the CU 323 have been locked automatically. Unlock the buttons by pressing  (Reset) and  or  (Reset) and  for 2 seconds.
	<i>bUS</i>	Indicates that the system is remote-controlled.
	<i>LOC</i>	Local: Appears if attempts to change local settings are made while the system is remote-controlled.
	Measured value	Shows the actual, measured value on the discharge side.
9	<i>Err</i>	Appears in case of a primary sensor fault.
	<i>H.L</i> / measured value	Alternates between the actual, measured value on the discharge side and "H.L" when a maximum discharge pressure or a level limit has been exceeded.

Pos.	Indicator lights	Status	Description
10		Off	Normal state.
		Red	Water shortage fault.
11		Off	Normal state.
		Red	Primary and/or redundant sensor fault. Maximum discharge pressure or level limit has been exceeded.
12	 (pump LED)	Off	The pump has stopped due to cascade operation. The system is in "OFF" state. The power supply has been switched off.
		Red	A pump fault has occurred.
		Green	The pump is running.
		Flashing green	The pump is in standby mode or has been stopped by pressing  or via remote control.
13	AUTO	Yellow	The pump is controlled by the CU 323.
14	OFF	Yellow	The pump has been stopped by pressing  or via remote control.

Pos.	Indicator lights	Status		Description
		Pos. 13: system run (green)	Pos. 14: alarm (red)	
15 and 16	 (system LEDs)	Off	Off	The power supply has been switched off.
		On	Off	The system is in normal operation.*
		Flashing	Off	The system has been set to stop.
		Off	On	The system has been stopped due to an alarm.
		On	On	The system is in normal operation, but there is a warning.*
		Flashing	On	The system has been set to stop, and there is a warning.

* The last pump in operation might have been stopped temporarily by the low-flow stop function.

8. Startup

Caution

A positive inlet pressure is required before start-up and during operation.

Do not start the pumps until they have been fully primed.





Warning



When pumping hot liquids, ensure that persons cannot accidentally come into contact with hot surfaces of the product.

After having carried out the mechanical, electrical and hydraulic installation described in sections [6.1 Mechanical installation](#) and [6.2 Electrical installation](#), proceed as follows:

8.1 Positive inlet pressure startup procedure

1. Check that the precharge pressure in the diaphragm tank is 0.7 times the required discharge pressure (setpoint).
Note, precharge must be set with zero pressure on the tank.
2. Close all pump discharge isolation valves on Multi B system.
3. Open discharge valve on one pump and turn tap on discharge side of system allowing water to pass through pump. Once complete, close discharge isolation valve.
4. Repeat step 3 for all remaining pumps on system. Once complete, open discharge isolation valve on all pumps after all pumps have been vented.
5. Switch on the main disconnect switch.
6. Turn system on by pressing on off button and adjust setpoint to desired setpoint value by pressing up  or down  button on the controller.

8.2 Flooded suction and suction lift startup procedures

1. Check that the precharge pressure in the diaphragm tank is 0.7 times the required discharge pressure (setpoint).
Note, precharge must be set with zero pressure on the tank.
 2. Switch off the main disconnect switch on the cabinet front.
 3. Switch off the circuit breakers (located inside the cabinet) of all pumps.
 4. Set the "Normal/Emergency" switch (located on the front of the control cabinet) for all pumps to "Emergency".
 5. Close all pump discharge valves and prime all pumps. The pumps are primed by opening cap on port of check valve positioned closest to pump and filling water into port. The pump is primed when water no longer is able to fill into pump. Reinstall cap on check valve port and repeat for all pumps.
 6. Switch on the relevant circuit breaker of pump to be started.
 7. Switch on the main disconnect switch; this will start the pump with relevant circuit breaker ON.
 8. Vent the pump by slowly opening its discharge valve. This will also allow gradual filling of discharge piping.
 9. Set the "Normal/Emergency" switch for the relevant pump to "Normal".
 10. Switch off the main disconnect switch.
 11. Repeat steps 6, 7, 8, 9 and 10 for the other pumps in the system.
 12. Switch on the main disconnect switch.
 13. Adjust the required setpoint via the CU 323 by pressing  or .
 14. Set the system to "On" by pressing .
 15. Increase setpoint to desired setpoint value.
- Hydro Multi-B is now in automatic mode and ready for operation.

Initial setpoint pressure value for system is 0 psi and maximum pressure exceeded is 22 psi above setpoint value.

Note

This may cause "Maximum pressure exceeded" alarm condition after startup is complete. Increase setpoint pressure value to desired pressure and possibly bleed off pressure on discharge to clear "Maximum pressure exceeded" fault.

9. Operating modes

User operation depends on the system mode. The system modes are described in the following sections.

9.1 Local mode, external stop not activated

In this mode, the system is locally controlled, and the external stop via digital input is not activated. The flow charts below show examples of how settings can be made.

Starting and stopping the system

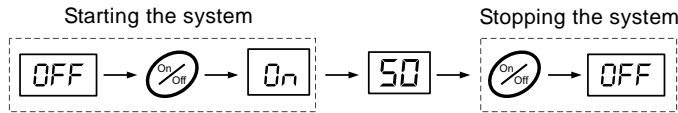

Changing the setpoint while the system is running

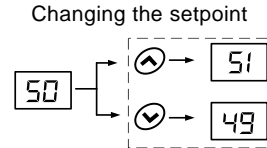

Changing the setpoint while the system is in "OFF" mode

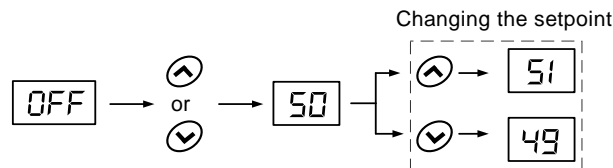

9.2 Local mode, external stop activated

In this mode, the system is locally controlled, and the external stop via digital input is activated.

External stop via digital input has higher priority than local control. This means that settings can be changed locally, but they will not be effective until external stop has been deactivated. The flow charts below show examples of how settings can be made.

Starting and stopping the system

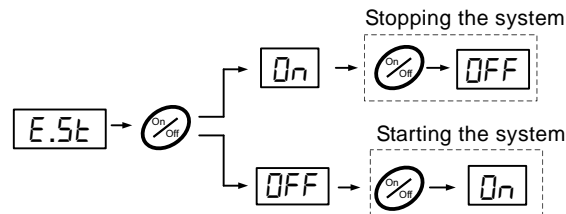

Note If the buttons are not touched for 3 seconds, the CU 323 will revert to the initial display.

Changing the setpoint

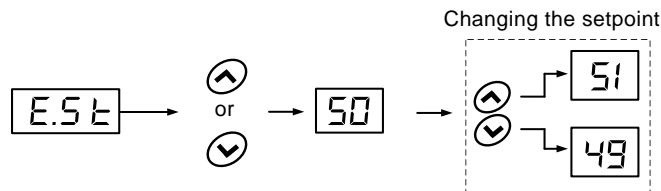

Note If the buttons are not touched for 3 seconds, the CU 323 will revert to the initial display.

TM05 9701 4313

TM05 9284 3613

TM05 9285 3613

TM04 9580 4610

TM05 9286 3613

9.3 Remote-controlled, external stop not activated

In this mode, the system is remote-controlled, and the external stop via digital input is not activated. If local settings are to be changed, follow the flow chart examples below.

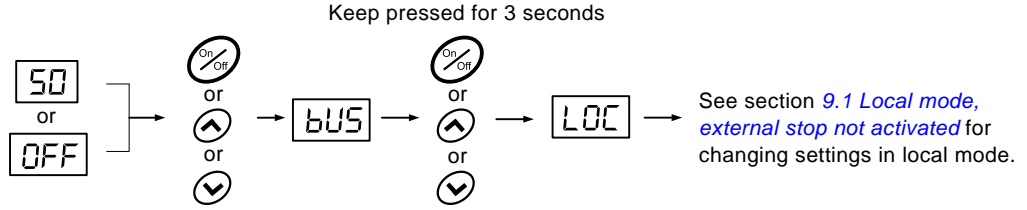

TM05 9287 3613

Note If the buttons are not touched for 3 seconds, the CU 323 will revert to the initial display.

9.4 Remote-controlled, external stop activated

In this mode, the system is remote-controlled, and the external stop via digital input is activated. If local settings are to be changed, follow the flow chart examples below.

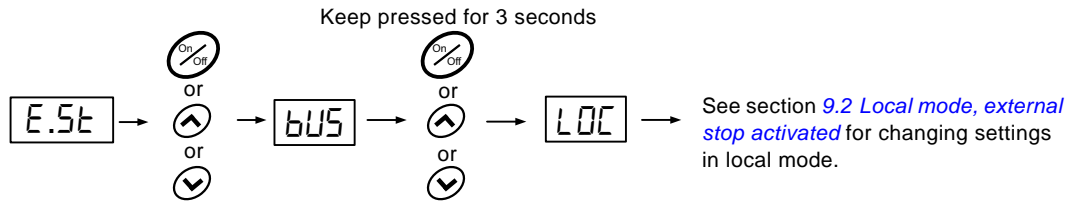

TM04 9583 4610

Note If the buttons are not touched for 3 seconds, the CU 323 will revert to the initial display.

10. Functions

Hydro Multi-B booster systems include application-optimized software.

10.1 General functions

10.1.1 Dry-running protection (pressure switch on suction standard)

Caution *When a pump is running in "Emergency" mode, it is not protected against dry running.*

To protect the pumps against damage from dry running, the Hydro Multi-B incorporates a water shortage function. This function is based on the monitoring of the inlet pressure or the level in a tank on the suction side.

The pressure or level can be monitored by one of the following:

- pressure switch (standard)
- float switch
- level switch
- external electrode relay
- analog sensor.

Dry-running protection with pressure switch, float switch, level switch or external electrode relay

Set the monitoring device to the desired limit.

If water shortage is detected for more than 5 seconds, the system will stop, and the  indicator light illuminates.

Press  when the water supply has been re-established.

Dry-running protection with analog sensor

The limit for the minimum inlet pressure in the suction manifold is a factory-set value which can only be changed by a Grundfos service engineer using PC tools.

If the sensor output is below the limit for minimum inlet pressure for more than 5 seconds, the system will stop, and the  indicator light illuminates.

Press  when the water supply has been re-established.

10.1.2 Automatic pump changeover

The automatic pump changeover function ensures an equal number of operating hours of the pumps, but it also ensures that, in case of an alarm on one pump, another pump is automatically started.

There are three types of automatic pump changeover:

- operation-dependent pump change
- alarm-dependent pump change
- time-dependent pump change.

Operation-dependent pump change

At increasing demand, the pump with the lowest number of operating hours will be started first.

At decreasing demand, the pump with the highest number of operating hours will be stopped first.

Alarm-dependent pump change

If a pump stops due to an alarm, the CU 323 will send a stop command to the pump to prevent auto-restarting and start another pump which is ready to start and which has the lowest number of operating hours.

Time-dependent pump change

In certain applications, the demand remains constant for long periods and does not require all pumps to run. In such situations, pump changeover does not take place naturally, and forced pump changeover may thus be required.

Once every 24 hours, the CU 323 checks if any of the running pumps has a higher number of operating hours than the pumps that are stopped. If this is the case, the pump will be stopped, and a pump with a lower number of operating hours will start.

10.1.3 Minimum time between start and stop

This function ensures a delay between the start/stop of one pump and the start/stop of another pump. The purpose is to prevent hunting when pumps start and stop continuously.

Note *If the system is stopped due to an alarm, the minimum time between start and stop will be ignored, and the pumps will be stopped immediately.*

10.2 Functions for constant-pressure systems

10.2.1 Pump cascade control

The cascade function ensures that only the required number of pumps is running. This means that the number of running pumps always corresponds to the required flow at the entered setpoint.

The first pump is started if the pressure at the discharge manifold is below the setpoint.

If the first pump is not able to keep the discharge pressure at the setpoint, and the minimum time between start/stop has passed, another pump is started.

During the start and stop of a pump, the speed of the speed-controlled pump is controlled in such way that the pressure disturbance is kept as low as possible.

At decreasing demand, pumps will be stopped if the pressure rises above the setpoint. Pumps will not be stopped until the minimum time between start/stop has passed.

The last pump in operation

If only one pump is operating, this pump can be operated in energy-saving on/off mode.

See section [10.2.4 Low-flow operation](#).

The number of possible starts/stops per hour for all pumps is limited by the maximum number of starts per hour.

10.2.2 Standby pumps

This function is optional and available on request. The function makes it possible to limit the maximum performance of the Hydro Multi-B by selecting one or more pumps as standby pumps.

If a three-pump system has one standby pump, maximum two pumps are allowed to operate at a time.

If one of the two pumps in operation has a fault and is stopped, the standby pump will be started. The performance of the booster system is thus not reduced.

The status as standby pump alternates between all pumps. Contact Grundfos for further information.

10.2.3 Maximum pressure exceeded

This function protects the piping on the discharge side of the booster system against damaging high pressures. The pressure is monitored, and if the pressure is higher than 22 psi (1.5 bar) above the setpoint for more than 5 seconds, the pumps are stopped, the indicator light PT illuminates, and the display indicates high limit $H.L.$

When the pressure falls below the setpoint, the system will automatically restart.

10.2.4 Low-flow operation

When only one pump is operating due to cascade, the Hydro Multi-B will regularly check for low flow by decreasing the pump speed.

When low flow is detected, the Hydro Multi-B will change its mode of operation to "low-flow operation" and run in on/off mode as described below.

In on/off mode, the system has two phases:

- Off phase
Water is drawn from the diaphragm tank until the pressure of the system reaches the lower limit of the on/off band ($P_{\text{set}} - 0.5 \times \text{on/off band}$).
- Boosting phase
The pump runs at 100 % speed until the pressure reaches the upper limit of the on/off band ($P_{\text{set}} + 0.5 \times \text{on/off band}$).

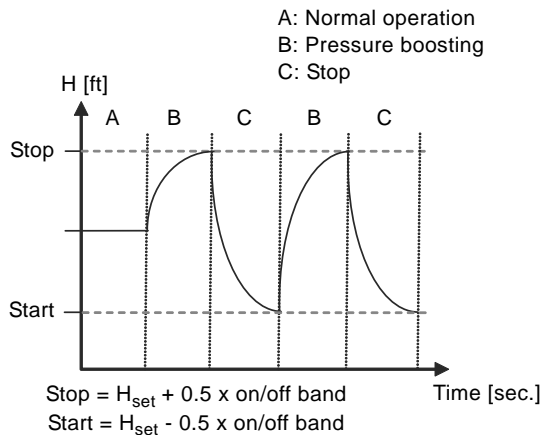

Fig. 9 On/off operation

11. Data communication

The CU 323 must have a CIM module (Communication Interface Module) fitted to be able to transfer data to the SCADA system.

12. Maintenance and service

12.1 Maintenance



Warning

Before starting work on the pumps, make sure that the power supply has been switched off. Lock the main switch with a padlock to ensure that it cannot be accidentally switched on.

12.1.1 Pumps

The internal pump parts are maintenance-free. It is important to keep the motor clean in order to ensure adequate cooling of the motor. If the pump is installed in dusty environments, it must be cleaned and checked regularly. Take the enclosure class of the motor into account when cleaning.

The motor has maintenance-free, greased-for-life bearings.

12.1.2 CU 323

The CU 323 is maintenance-free. It must be kept clean and dry. Protect it against direct sunlight. Furthermore, the CU 323 must not be outside the ambient temperature range.

12.2 Frost protection

Pumps which are not being used during periods of frost should be drained to avoid damage. Follow the instructions below:

1. Close the isolating valves before and after the pump.
2. Remove the filling and drain plugs.
3. Remember to open the isolating valves and refit the plugs before the pump is put into operation again.



Warning

Ensure that the escaping water does not cause injury to persons or damage to the motor or other components. In hot-water installations, special attention should be paid to the risk of injury caused by scalding hot water.

Do not fit the filling and drain plugs until the pump is to be used again.

12.2.1 Taking out of operation

Switch off the main disconnect switch to take the booster system out of operation.



Warning

The conductors in front of the main switch are still energized. Lock the main switch with a padlock to ensure that it cannot be accidentally switched on.

Individual pumps are taken out of operation by switching off the corresponding motor-protective circuit breaker, automatic circuit breaker or fuse.

TM03 9292 4807

12.3 Service

12.3.1 Service tools

Designation	Further information	Product number
PC Tool Link	USB	96705378
Anti-static service kit		96884939

12.4 Overview of inputs and outputs

12.4.1 Layout of the back of the CU 323

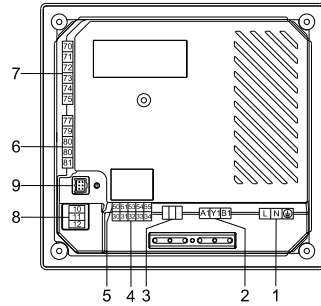

TM04 9282 3810

Fig. 10 Back of the CU 323

Group	Description
1	Connection of power supply
2	Internal GENIbus connection
3	Fieldbus connection (CIM module) (optional)
4	Input for PTC sensor or thermal switch
5	Analog inputs
6	Digital output
7	Relay outputs
8	Digital inputs
9	Service connection

12.4.2 Terminal groups

Abbreviation	Meaning
DI	Digital input
DO	Digital output
RO	Relay output
AI	Analog input
NC	Normally closed contact
NO	Normally open contact
C	Common
PTC	Positive temperature coefficient

Pos.	Terminal	Description	Data	Diagram
1	L	Connection to phase conductor	1 x 100-240 VAC ± 10 %, 50/60 Hz	
	N	Connection to neutral conductor		
	PE	Connection to protective earth		
2	A1	RS-485 A	GENIbus (internal) Fix the screen with a cable clamp.	
	Y1	RS-485 GND		
	B1	RS-485 B		
	⏚	Functional earth		
3	Connection to external fieldbus, see installation and operating instructions for the CIM module.			
4	30	PTC 1	Input for PTC sensor or thermal switch.	
	31	GND, PTC		
	32	PTC 2		
	33	GND, PTC		
	34	PTC 3		
5	50	+ 24 V	Supply to sensor. Short-circuit-protected 30 mA.	
	51	AI1	Input for analog signal. 0-20 / 4-20 mA or 0-10 V.	
	53	+ 24 V	Supply to sensor. Short-circuit-protected 30 mA.	
	54	AI2	Input for analog signal. 0-20 / 4-20 mA or 0-10 V.	
	55	GND		
All terminals (except mains terminals) must only be connected to voltages not exceeding 16 V _{rms} and 22.6 V _{peak} or 35 VDC.				
6	77	Relay 1	Relay contact for starting and stopping mains-operated pumps.	
	79	Relay 2		
	80	Common		
	80	Common		
	81	Relay 3		
7	70	Relay 1	C	
	71	Relay 1	NO	
	72	Relay 1	NC	
	73	Relay 2	C	
	74	Relay 2	NO	
	75	Relay 2	NC	
8	10	DI1	Digital input	
	11	GND		
	12	DI2		
All terminals (except mains terminals) must only be connected to voltages not exceeding 16 V _{rms} and 22.6 V _{peak} or 35 VDC.				
9	GENIbus	Service connection		

13. Fault finding



Warning

Before making any connections in pumps, terminal boxes or control cabinet, make sure that the power supply has been switched off for at least five minutes and that it cannot be accidentally switched on.

Fault	Possible cause	Remedy
The pumps are not running.	Current pressure is higher than or equal to the setpoint.	Wait until the pressure has dropped, or lower the pressure on the discharge side of the Hydro Multi-B, and check that the pumps start.
	Power supply disconnected.	Connect the power supply.
	Main disconnect switch turned off.	Turn on the main disconnect switch.
	Main switch is defective.	Replace the main switch.
	Motor protection is activated.	Contact Grundfos.
	Motor is defective.	Repair or replace the motor.
	The pressure transmitter is defective.	Replace the pressure transmitter. 0-145 psi (0-10 bar) transmitters with 0-10 V, 0-20 mA or 4-20 mA output signals are monitored by the Hydro Multi-B.
The pumps start, but stop immediately. The operating pressure is not reached.	Cable is broken or short-circuited.	Repair or replace the cable.
	Incorrect GSC file.	Check if the GSC file is correct by means of a PC Tool.
	Water shortage or no inlet pressure.	Re-establish the supply of water to the Hydro Multi-B. When the inlet pressure has been re-established, press [Reset] to restart the system.
The Hydro Multi-B has stopped and cannot restart.	The pressure transmitter is defective.	Replace the pressure transmitter. 0-145 psi (0-10 bar) transmitters with 0-10 V, 0-20 mA or 4-20 mA output signals are monitored by the Hydro Multi-B.
	Cable is broken or short-circuited.	Repair or replace the cable.
	CU 323 fault: <ul style="list-style-type: none"> Power supply disconnected. 	Connect the power supply.
	The CU 323 is defective.	Contact Grundfos.
Unstable water supply from the Hydro Multi-B.	Inlet pressure too low.	Check the suction pipe and the suction strainer, if any.
	Suction pipe or pumps partly blocked by impurities.	Clean the suction pipes, strainer or pumps.
	Pumps suck air.	Check the suction pipe for leakages.
	Pressure transmitter is defective.	Replace the transmitter.
	Incorrect GSC file.	Check if the GSC file is correct by means of a PC Tool.
Pumps are running, but deliver no water.	The valves are closed.	Open the valves.
	Suction pipe or pumps blocked by impurities.	Clean the suction pipe or pumps.
	Non-return valve blocked in closed position.	Clean the non-return valve. The non-return valve must move freely.
	Suction pipe leaky.	Check the suction pipe for leakages.
The Hydro Multi-B is unable to reach the setpoint.	Air in suction pipe or pumps.	Vent and prime the pumps. Check the suction pipe for leakages.
	Too high consumption.	<ul style="list-style-type: none"> Reduce consumption, if possible. Install a bigger Hydro Multi-B booster system.
	Too many standby pumps selected.	Reduce the number of standby pumps.
	Pipe fracture or leakage in the system.	Check the system and repair any damage.
	Incorrect GSC file.	Check if the GSC file is correct by means of a PC Tool.
Leakage from the shaft seal.	Shaft seal is defective.	Replace the shaft seal.
Noise.	The pumps are cavitating.	Clean the suction pipe/pumps and possibly the suction strainer.
Very frequent starts and stops.	Wrong diaphragm tank precharge pressure.	Set correct precharge pressure.

14. Maintenance



Warning

Before starting work on the pumps, make sure that the power supply has been switched off. Lock the main switch with a padlock to ensure that it cannot be accidentally switched on.

14.1 Pumps

The internal pump parts are maintenance-free. It is important to keep the motor clean in order to ensure adequate cooling of the motor. If the pump is installed in dusty environments, it must be cleaned and checked regularly. Take the enclosure class of the motor into account when cleaning.

The motor has maintenance-free, greased-for-life bearings.

14.2 CU 323

The CU 323 is maintenance-free. It must be kept clean and dry. Protect it against direct sunlight. Furthermore, the CU 323 must not be outside the ambient temperature range. See section [17. Technical data](#).

15. Frost protection

Pumps which are not being used during periods of frost should be drained to avoid damage. Follow the instructions below:

1. Close the isolating valves before and after the pump.
2. Remove the filling and drain plugs.
3. Remember to open the isolating valves and refit the plugs before the pump is put into operation again.



Warning

Ensure that the escaping water does not cause injury to persons or damage to the motor or other components. In hot-water installations, special attention should be paid to the risk of injury caused by scalding hot water.

Do not fit the filling and drain plugs until the pump is to be used again.

16. Taking out of operation

Switch off the main switch to take the booster system out of operation.



Warning

The conductors in front of the main switch are still energized. Lock the main switch with a padlock to ensure that it cannot be accidentally switched on.

Individual pumps are taken out of operation by switching off the corresponding motor-protective circuit breaker, automatic circuit breaker or fuse.

17. Technical data

17.1 Pressure

Inlet pressure

Caution

A positive inlet pressure is required before start-up and during operation.

Note

Flooded suction and suction lift applications are possible on some, but not all, Multi-B systems. Special attention must be applied to confirm inlet conditions ($NPSH_A$) is greater than $NPSH_R$ at the maximum capacity at which the pump will run.

Calculation of the inlet pressure is recommended in these cases:

- Water is drawn through long pipes.
- Inlet conditions are poor.

Note

In this manual, the term 'inlet pressure' is defined as the pressure/vacuum which can be measured immediately before the booster system.

To avoid cavitation, make sure that there is a minimum inlet pressure on the suction side of the booster system. The minimum inlet pressure in psi can be calculated as follows:

$$H = P_b - NPSH - H_f - H_v - H_s$$

P_b = Barometric pressure in feet (33.9 feet at sea level). In closed systems, p_b indicates system pressure in feet.

H_f = Friction loss in suction piping in feet. (At the highest flow the pump will be delivering.)

H_v = Vapor pressure in feet.

NPSH = Net Positive Suction Head in feet.

NPSH can be read from the NPSH curve at the maximum capacity at which the pump will run.

(See Grundfos CM, CME Data booklet 98435269 / L-CM-PG-001).

H_s = Safety margin = minimum 2 feet.

If "H" is calculated as positive, the pump can operate at a suction of maximum "H" feet. If "H" is calculated as negative, an inlet pressure (psia) of minimum "H" feet is required.

Maximum inlet pressure

The actual inlet pressure plus the pressure when the pump is operating against a closed valve should always be lower than the maximum system pressure.

Operating pressure

As standard, the maximum operating pressure is 145 psi (10 bar).

17.2 Temperature

Liquid temperature: +32 °F to +140 °F (0 °C to +60 °C).

Ambient temperature: +32 °F to +104 °F (0 °C to +40 °C).

17.3 Relative humidity

Maximum 95 %.

17.4 Sound pressure level

For sound pressure level, see installation and operating instructions for the CM pumps.

The sound pressure level for a number of pumps can be calculated as follows:

$$L_{\text{max.}} = L_{\text{pump}} + (n - 1) \times 3$$

$L_{\text{max.}}$ = Maximum sound pressure level

L_{pump} = Sound pressure level for one pump

n = Number of pumps.

Note

Considering the flow in pipes, vibrations, etc., the actual sound pressure level of the Hydro Multi-B system will be lower than 90 dB(A).

18. Electrical data

Supply voltage

See Hydro Multi-B nameplate.

Digital inputs

Open-circuit voltage	24 VDC
Closed-circuit current	5 mA, DC
Frequency range	0-4 Hz

Note

All digital inputs are supplied with PELV voltage (Protective Extra-Low Voltage).

Analog inputs

Input current and voltage	0-20 mA 4-20 mA 0-10 V
Tolerance	± 3.3 % of full scale
Repetitive accuracy	± 1 % of full scale
Input resistance, current	< 250 Ω
Input resistance, voltage	10 kΩ ± 10 %
Supply to sensor	24 V, maximum 50 mA per sensor, short-circuit-protected

Note

All analog inputs are supplied with PELV voltage (Protective Extra-Low Voltage).

Digital outputs (relay outputs)

Normally open contacts (DO1, DO2 and DO3)	C, NO
Normally closed contacts (DO4 and DO5)	C, NC, NO
Maximum contact load	240 VAC, 2 A
Minimum contact load	5 VDC, 10 mA

All digital outputs are potential-free relay contacts.

Note

Some outputs have a common C terminal. For further information, see the wiring diagram supplied with the Hydro Multi-B.

Inputs for PTC sensor/thermal switch

For PTC sensors to DIN 44082. Thermal switches can also be connected.

Open-circuit voltage	8 VDC ± 15 %
Closed-circuit current	1.7 mA, DC

Note

Inputs for PTC sensors are electrically separated from the other inputs and outputs of the Hydro Multi-B.

18.1 Disposal

This product or parts of it must be disposed of in an environmentally sound way:

1. Use the public or private waste collection service.
2. If this is not possible, contact the nearest Grundfos company or service workshop.

Subject to alterations.

Grundfos Kansas City

17100 West 118th Terrace
Olathe, Kansas 66061
Phone: +1-913-227-3400
Fax: +1-913-227-3500

www.grundfos.us

Grundfos Canada

2941 Brighton Road
Oakville, Ontario L6H 6C9 Canada
Phone: +1-905 829 9533
Fax: +1-905 829 9512

www.grundfos.ca

Grundfos México

Boulevard TLC No. 15
Parque Industrial Stiva Aeropuerto
C.P. 66600 Apodaca, N.L. Mexico
Phone: +011-52-81-8144 4000
Fax: +011-52-81-8144 4010

www.grundfos.mx

98504518 0117
ECM: 1201915

The name Grundfos, the Grundfos logo, and be think innovate are registered trademarks owned by Grundfos Holding A/S or Grundfos A/S, Denmark. All rights reserved worldwide. © Copyright Grundfos Holding A/S