



QUICKDRAIN PROLINE + SHOWERLINE

USA™

More than a drain.
A TOTAL SHOWER SOLUTION.

QUICKDRAIN

A more sophisticated shower solution.

Design is an integral part of the QuickDrain experience. Elegance and performance working together in tandem, a seamless blend of style and engineering. QuickDrain is a sophisticated curbed or curbless total shower solution, full of refined detail.



Cosmo Polished Stainless Steel



Deco Polished Rose Gold



Lines Matte Black

ProLine and ShowerLine

QuickDrain linear shower systems provide unlimited styling options and superior engineering, offering wall-to-wall coverage. With options for residential, hospitality, and healthcare applications, QuickDrain stands out from the rest by offering homeowners, designers, and installers the opportunity to select from ShowerLine and ProLine shower systems and find the perfect solution for every project

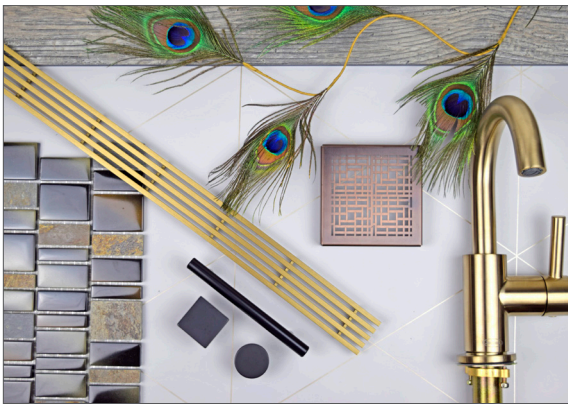

ENDLESS DESIGN POSSIBILITIES

Choose from an extensive line of elegant drain cover designs, sizes, and finishes to achieve your desired style.

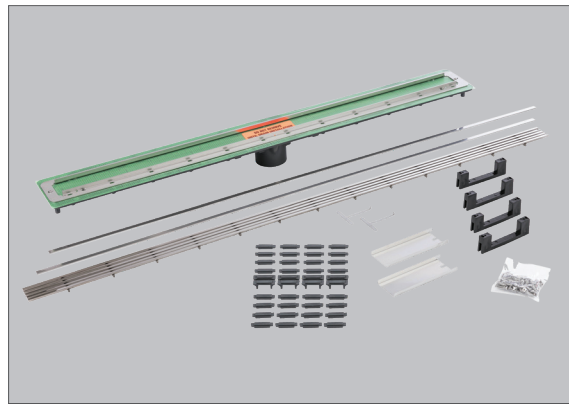

JOB SITE READY

QuickDrain linear covers can be trimmed at the jobsite and include spacers for the perfect height adjustment.



SIMPLE & FAST INSTALLATION

Pre-sloped PET QuickSlope panels can be installed in less than a day and eliminate the need to float a pitched mud bed and wait for it to cure saving time and reducing labor costs.



WALL-TO-WALL COVERAGE

Superior engineering and wall-to-wall coverage promotes the effective and efficient drainage of water.

Cover designs for every style.

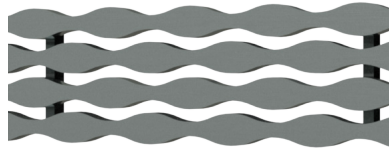

Stream



MICHAEL GRAVES
DESIGN



Deco

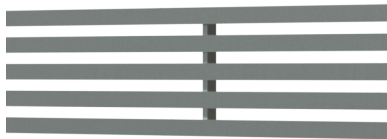

Lines

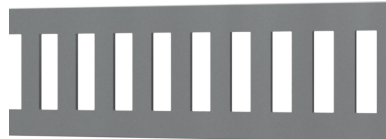

Vertical

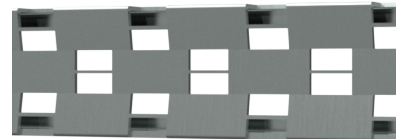

Cosmo



MICHAEL GRAVES
DESIGN

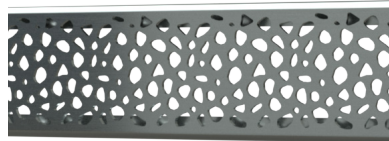

Stones



Tile-In
TILE NOT INCLUDED



MICHAEL GRAVES™
DESIGN

QuickDrain's exclusive Stream and Cosmo drain covers were designed in collaboration with world-renowned designer Michael Graves.

Complete your look with the perfect finish.

Both ProLine and ShowerLine offer eight finishes to accommodate a range of bathroom aesthetics- from a classic look in stainless steel to striking matte black- ensuring consistency throughout your project

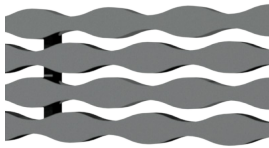

*Polished
Stainless Steel*

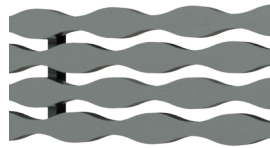

*Brushed
Stainless Steel*

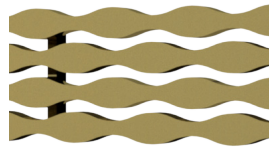

Polished Gold

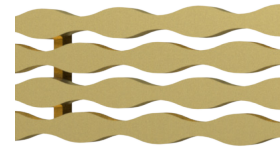

Brushed Gold

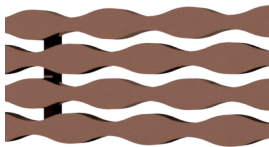

Polished Rose Gold

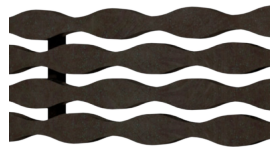

Oil Rubbed Bronze

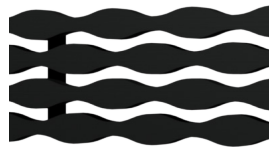

Matte Black



Polished Black

See the [QuickDrain installation guide](#) for tips on installing covers with specialty finishes as well as care and maintenance information on [QuickDrain.com](#)



Cosmo Matte Black

Performance in curbless...

When QuickDrain is installed with a curbless entrance, it creates an easy, seamless transition from dry to wet areas in the bathroom.



Universal Design & ADA Compliance

The roll-in shower is a hallmark of universal design, making the shower easily accessible to all ages and abilities in accordance with the Americans with Disabilities Act. It also provides a clean and expansive look, from traditional to modern aesthetics.



Improved Hygiene

A curbless QuickDrain shower can be designed with larger format tiles, reducing the number of grout joints and seams where mold, mildew and grime can take hold.



Flooring Options

There are nearly limitless design options, as QuickDrain makes it possible to use nearly any imaginable finish or flooring material.

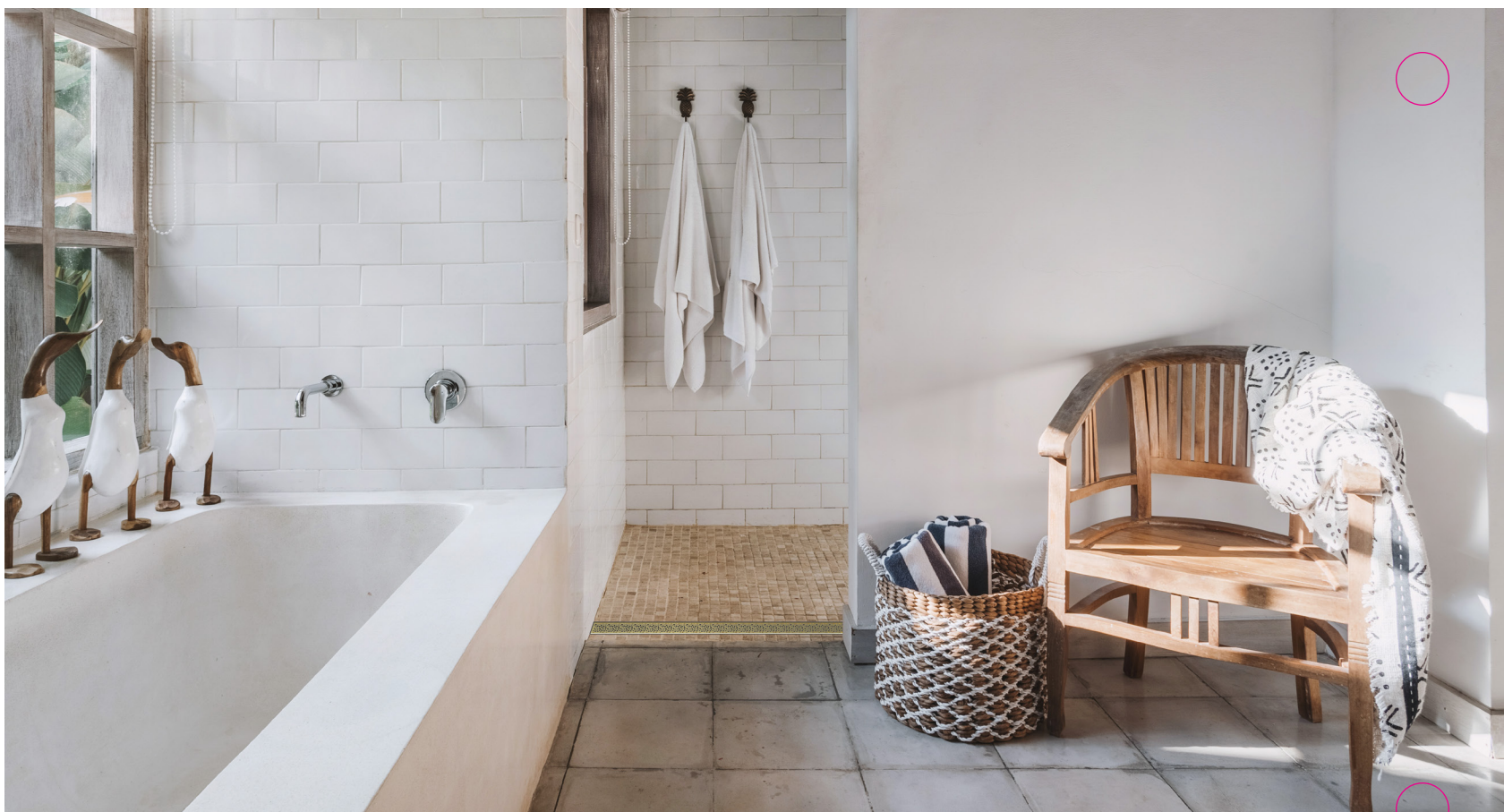

Stones Brushed Gold

○ and curbed showers.

Shower curbs can serve as the barrier between the shower pan and the rest of the bathroom floor.



Design Opportunities

Allows for use of multiple tile formats throughout the bathroom. The design possibilities are limitless when mixing and matching patterns with the curb separating and framing the shower space



Layout Preference

QuickDrain installations with a curbed shower can give a bathroom a sense of separation from the rest of the room and help visually frame the shower area.



○ **Lines** *Brushed Stainless Steel*

PROLINE + SHOWERLINE



WALL-TO-WALL COVERAGE

QuickDrain's Linear systems feature a one-directional slope with wall-to-wall coverage. This improves drainage, giving water one uniform path toward the drain.

Deco Polished Black

Simple installation.



All in a matter of hours.

Projects with a traditional mud bed and pan liner application require a minimum of two days of construction, waiting for mortar to set. The QuickSlope panel system can be completely installed in less than one day.

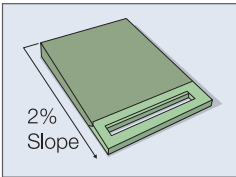

Less labor.

The QuickDrain system allows installers to move on to the next job quickly. The pre-sloped PET panels eliminate the need to float a pitched mud bed and wait for it to cure, saving big on labor cost.

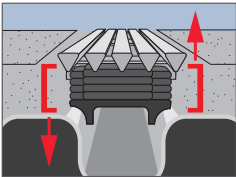

Adjustable height.

Stackable spacers mean installers can easily adjust the drain cover after installation to ensure the cover is flush with the floor.

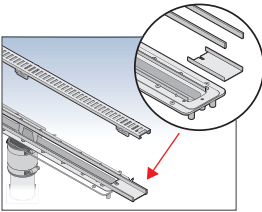

Adjustable length.

Trough extensions and covers can be trimmed at the jobsite after the body is installed, providing wall-to-wall coverage.



Install with or without clamping ring drain

Versatility.

QuickDrain can be installed by connecting to the drain waste line or used with a traditional 2-piece clamping collar drain body.

Curbless Layout Flexibility

QuickDrain can be installed to accommodate shower layout preference.



When used as a primary shower drain placed along back wall of a curbless shower, the capacity of the drain is up to 12* GPM, and all cover designs are suitable

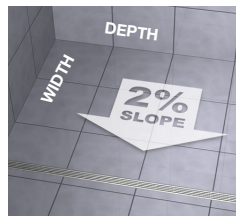

When used as a primary shower drain placed across the threshold/entry of a curbless shower, the capacity of the drain is 5* GPM, and the only recommended cover designs are STREAM, LINES, and COSMO.

* Actual volume is limited by the plumbing lines and P-trap. Multiple drains can be linked together to accommodate greater water flow or larger shower footprint.

The leader in linear drain customization.

ProLine delivers a new level of flexibility in linear drains.

With a variety of drain waste outlet location options and a customizable drain body, ProLine is the ideal choice for construction jobs that involve specification requirements, including healthcare facilities or hospitality where PVC is not allowed.

Spec-focused

Engineered to meet rigorous specification requirements.

Installation Flexibility

Multiple outlet configurations and adjustable height for different tile thicknesses. With a low profile and no need for trough extensions, ProLine makes linking drains for large projects easy.

Antimicrobial Benefits

316L Marine grade stainless steel drain body suitable for environments with strict hygienic requirements.

More than a shower drain

ProLine drains can be used in outdoor installations* like patio transition areas. The line also features sleek sink drain options.

** Does not support weight of car. Not recommended as the primary outdoor drain. Rain events may exceed GPM capacity*



Tile-In *Brushed Stainless Steel*



Stream *Brushed Stainless Steel*



Cosmo Polished Stainless Steel

ProLine custom solutions.



Non-Standard Sizes

Custom drains made in any size increment between 10"-100" long. Maximum size with one waste outlet is 68" total length not including the flanges. Drains longer than 68" must have two waste outlets per trough due to the depth, length and internal pitch of the trough.



Commercial Waste Outlet

Commercial facilities have special requirements to meet fire codes. Waste outlets can be made in custom lengths from 2" to 14" inches. Longer pipes allow waste lines to go through concrete floor, so the plumbing connection is done below fireproofing.



Side Waste Outlet

Primarily used in retrofitting situations when there are limitations on space and location of existing floors and outlets. The side waste outlet drops and turns 90 degrees and is only 2 9/16" deep, eliminating the need to drill through concrete.



Multiple Waste Outlet

Water flow output of more than 12 GPM at the rear wall and 5 GPM at the threshold can be addressed with additional outlets on the drain body. QuickDrain waste outlets can accommodate this increased flow. While the appearance is like a standard drain, these solutions can double or triple water flow capacity.



Resinous Drains

These drains are suitable for epoxy flooring and urethane making them ideal for commercial use. The trough is surrounded by a 3 1/16" square stain less steel frame.

The most complete linear drain system.

Example of ADA (Curbless) Installation Using ProLine Drain with Liquid Waterproofing

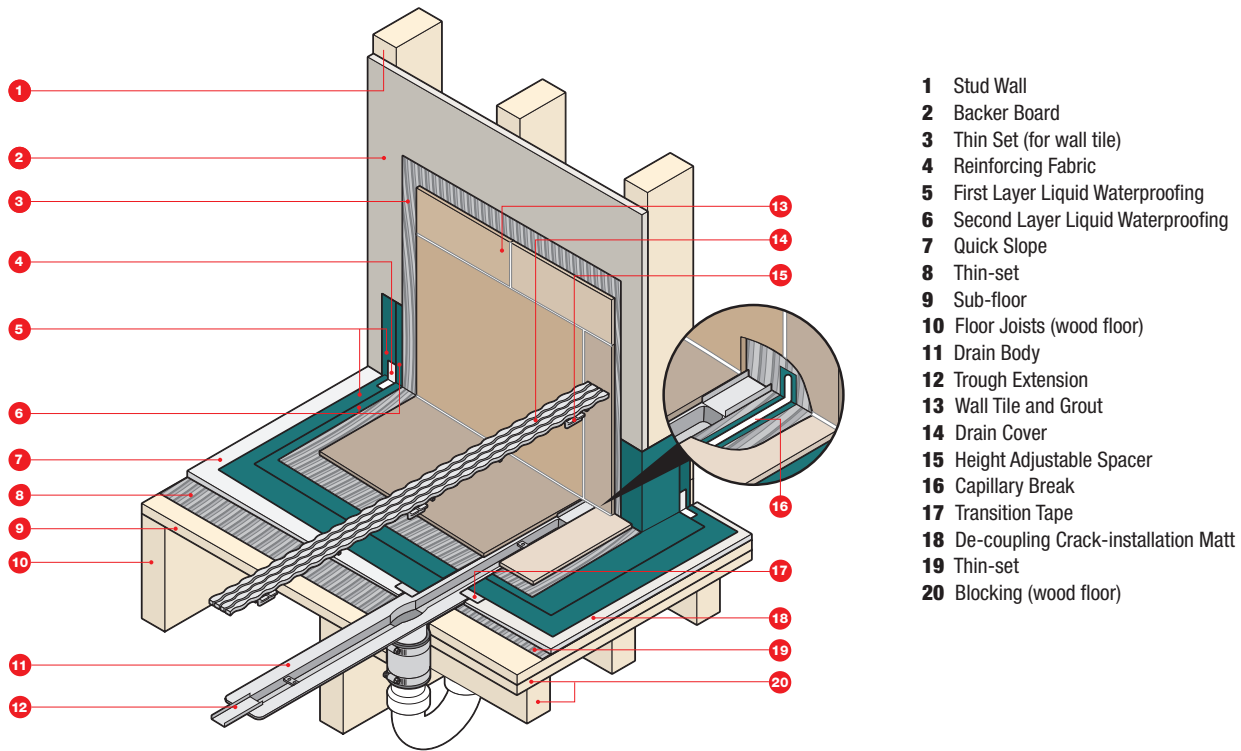

- 1 Stud Wall
- 2 Backer Board
- 3 Thin Set (for wall tile)
- 4 Reinforcing Fabric
- 5 First Layer Liquid Waterproofing
- 6 Second Layer Liquid Waterproofing
- 7 Quick Slope
- 8 Thin-set
- 9 Sub-floor
- 10 Floor Joists (wood floor)
- 11 Drain Body
- 12 Trough Extension
- 13 Wall Tile and Grout
- 14 Drain Cover
- 15 Height Adjustable Spacer
- 16 Capillary Break
- 17 Transition Tape
- 18 De-coupling Crack-installation Matt
- 19 Thin-set
- 20 Blocking (wood floor)

ProLine sample system.

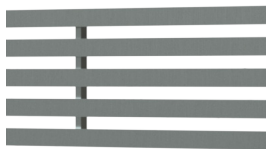

Decorative Linear Cover

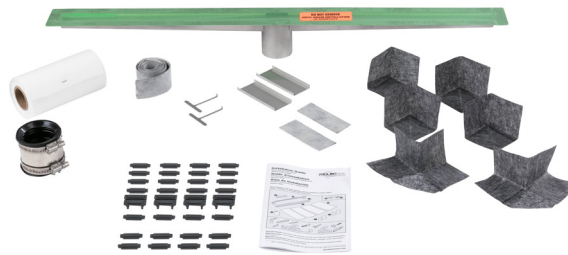

Drain Body & Liquid Waterproofing Accessories

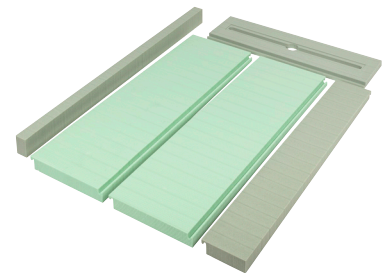

PET QuickSlope Pan Kit

A faster way to luxury.

With a PVC drain body, ShowerLine an effective solution to installing a linear drain, while still maintaining superior style and functionality.

The system features a clamping collar and is compatible with topical fabric waterproofing allowing for projects to be completed in as little as one day. If desired, the system can also be used with topical liquid applied waterproofing.

Faster Installation

The ShowerLine system can be installed in as little as 2 hours.

Tub-to shower conversions

Fast, efficient way to modernize a shower with minimal disruptions when choosing from versatile waste outlet options.

Waterproofing Flexibility

System is compatible with both topical liquid applied waterproofing or topical sheet waterproofing options allowing the installer to choose based on their preference.

Variety of Layout Options

With PVC drain bodies in 10 lengths and size-sizeable drain covers designed for wall-to-wall coverage, ShowerLine offers a variety of options to choose from for your next project.



Stream Polished Stainless Steel



Tile-In Brushed Stainless Steel

A total shower solution.

QuickDrain is a complete shower system that reimagines how a linear drain should perform and be installed. QuickDrain slashes construction time and minimizes impact on customers.

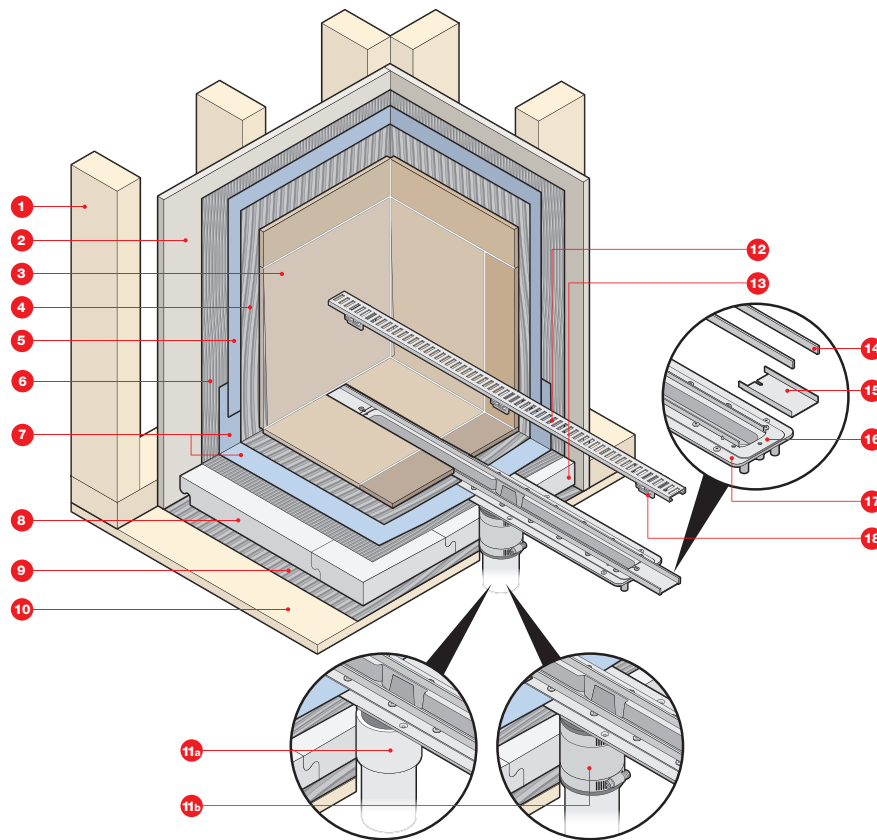

Example of Down(Vertical) Waste Outlet Drain Installation Using ShowerLine Pan with Sheet Waterproofing

- 1 Stud Wall
- 2 Backer Board
- 3 Wall Tile and Grout
- 4 Thin-set (for wall tile)
- 5 Sheet Wall Waterproofing
- 6 Thin-set
- 7 Sheet Shower Pan Waterproofing
- 8 Pre-sloped Interlocking PET Foam Panels
- 9 Thin-set
- 10 Sub-floor
- 11a PVC to PVC Connection
- 11b Shielded No-Hub Coupling
- 12 Drain Cover
- 13 Pre-sloped Interlocking Drain Support Frame
- 14 Cover Channel
- 15 Trough Extension
- 16 Clamping Collar
- 17 Drain Body
- 18 Height Adjustable Spacer

ShowerLine sample system.

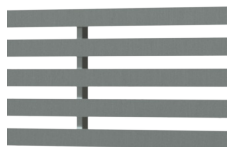

Decorative Linear Cover

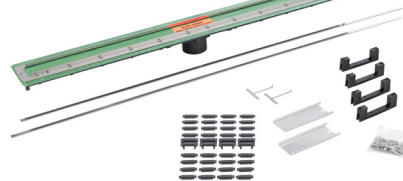

PVC Drain Body

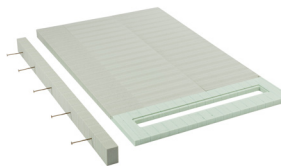

PET QuickSlope Pan Kit



QuickLiner or Liquid Waterproofing Accessories

Choosing the perfect shower system.



Residential

Both ShowerLine and ProLine linear systems are appropriate for new and remodel residential projects allowing for homeowners to choose the ideal shower to fit their lifestyle.



Hospitality

ShowLine is the go to linear drain in hospitality projects. The system can be installed quickly creating minimum impact on customers and saving on labor costs. It also provides a fast effective way to modernize a shower and complete tub to shower conversion projects.



Healthcare

ProLine is recommended for healthcare applications. With a drain body made of 316L marine grade stainless steel and ADA compliant drain covers, it is the ultimate choice for both hospitals and assisted living facilities.

Comparing ProLine and ShowerLine.

* Linear drain bodies can be linked
 ** Offset outlet is located 3" from center of ProLine drain body trough. This orientation is best utilized in wood framed construction or slab construction with floor constraints.

	ShowerLine	ProLine	
LINEAR DRAIN BODY	Linear Drain Body Material	PVC	18 gauge 316L Marine Grade Stainless Steel
	Common Connection Type	Permanet Solvent Weld or Approved two-band coupling	Approved two-band coupling
	Number of Stock Lengths	Ten	Thirteen
	Stock Lengths	Stock Lengths: 26" – 72" Max: 72" + unlimited when linking drain bodies*	Stock Lengths: 28" – 74" Max: 74" + unlimited when linking drain bodies*
	Custom Drain Body Lengths Available	No	Yes, ProLine Custom Drain Body made in any size increment between 10"-100" long.
	Drain Waste Outlets Orientation	Vertical and Side Waste Outlet orientations available	Vertical Centered, Vertical Offset**, and Custom configurations upon request
	Drain Waste Outlet ID Size	1.5" and 2.0" for Linear Drains	1.5" for Sink Drains Only , 2.0" for Linear Drains
	Drain Capacity (Gallons Per Minute)	<ul style="list-style-type: none"> • 12 GPM for 2.0" outlet with placement inside shower footprint • 5 GPM in a shower with placement across entry • 9 GPM for 1.5" outlet with placement inside shower footprint 	<ul style="list-style-type: none"> • 12 GPM for 2.0" outlet with placement inside shower footprint • 5 GPM in a shower with placement across entry
	Custom Waste Outlet Orientations	No	Yes, ProLine Custom Waste Outlets available in Commercial Length Outlet (2"-14"), Side Waste, and Multiple Waste Outlet
APPLICATION	Waterproofing Compatibility	<ul style="list-style-type: none"> • Topical Sheet Membrane • Topical Liquid Applied Membrane • Hot Mop • CPE/PVC Liner 	<ul style="list-style-type: none"> • Topical Liquid Applied Membrane (preferred) • Hot Mop • CPE/PVC Liner
	Curbed and Curbless Applications	Both	Both
	Tile format	Allows for large or small format tile	Allows for large or small format tile
	Suitable Installation Location	Indoor Only	Suitable for both Indoor and Outdoor <i>*Does not support weight of a car</i>
	Antimicrobial benefits	No	Yes, made of 316L SS and engineered to meet rigorous specification requirements
LINEAR DRAIN COVER	ADA Compliant Covers	Three	Three
	Design Options	Seven	Seven
	Finish Options	Eight	Eight

Healthcare case study.

QuickDrain ProLine Drain System Offers Ease of Installation at Major Hospital Project

CLEVELAND, OH — Brian Clifford, Plumbing Superintendent at Relmec Mechanical LLC, has been in the industry for more than 25 years, so he thought he'd seen it all — until he had the opportunity to use QuickDrain's ProLine linear drains in 2015 as part of a large-scale project for a major hospital network in Cleveland, Ohio. "This was the first time I had used QuickDrain or heard of it, and I thought, wow, here's something new," he said.

The \$110.2M, 224,300 ft² project added a 126-bed inpatient hospital bed tower to an existing family health and ambulatory surgical center. ProLine's 316L marine grade stainless steel drain body paired with an ADA compliant cover are ideal for the hospital's curbless showers. With more than 100 drains to install, Clifford said he was pleased that a QuickDrain rep provided an on-site tutorial for him, the tile setter, the construction manager and others involved on the project.

Clifford says the ProLine drains were easier to install than other drains. "They're a lot smaller and lighter to move around," he said. The tile setter also liked the ease of installation, according to Clifford. "In this application, we only had to pitch the floor to the drain and set it at the front of the shower. With a round drain, you have to pitch the floor in all different directions."

Clifford also says that QuickDrain's extension pieces were extremely helpful, and he liked being able to customize. "On this project, the showers were bigger than usual, so we used the extensions to take up a little more space and cover the opening," he explains. "The look of it is so nice."

"I would definitely recommend QuickDrain to others," Clifford said. "It was a simple process, everyone was on the same page throughout the process, and it turned out great."



QUICKDRAIN UNIVERSAL DESIGN & ADA COMPLIANCE

The roll-in, curbless shower is a hallmark of universal design, making the shower easily accessible to all ages and abilities in accordance with the Americans with Disabilities Act. It also provides a clean and expansive look, from traditional to modern aesthetics.

Hospitality case study.

International Construction Services Company Streamlines 404 Tub-to-Shower Conversions at Four Seasons Hotel

HOUSTON, TX — The 5-star Four Seasons Houston hotel is only steps away from Minute Maid Park, home of Major League Baseball's Houston Astros, making it a favorite of out-of-town fans who come to see their favorite team in action. Opened in 1982, the Four Seasons Houston is now in the latter stages of upgrading 404 guest bathrooms to transform the iconic downtown hotel, as part of a multi-year renovation project.

The bathroom renovations involve converting 40-year-old cast iron tubs to modern showers. According to project assistant-superintendent, John Upshaw of Turner Construction, converting 404 bathtubs to step-in showers in a building constructed in the '80s, is no small feat.

The construction team has encountered numerous job-site irregularities, with some bathrooms having more than one layer of drywall in the shower enclosure, altering the dimensions of the enclosure.

Meanwhile, other bathrooms were missing cement boards, resulting in damage behind the walls.

"When we demo out a tub, we're essentially running into different conditions in 404 different bathrooms," Upshaw explains. "You just don't know what you're going to run into."

So the team had to find a solution that would allow them to adapt to unexpected plumbing rough-in configurations and various shower-enclosure sizes. A product that would speed installation would be the ultimate find for a large project like this one.

Which is exactly what the hotel's architecture and design firm expected to accomplish when they specified QuickDrain USA's tub-to-shower conversion kits for the project.



RESULTS

Tile contractor Jaime Rosa, of Gulf Coast Flooring, says each crew member completes an average five showers per day at the Four Seasons Houston project. "It takes less time than a conventional mud bed, and that translates into cost-savings for us and the hotel." Turner's Upshaw adds: "The finished installation looks great, and as long as it looks good, the hotel is happy." Upshaw says he likes the QuickDrain system. "I've actually been thinking of putting it in my own home, and we will use it again for similar commercial projects."

Ordering is fast and simple.

Evaluate Your Project Space

Verify structural integrity within shower footprint (level sub-floor and square framing). Sketch the desired layout measurements – include drain location, subfloor material, and note if it is a curbed or curbless shower.

When you are ready, contact your local QuickDrain USA dealer to place your order. To make the ordering process seamless, complete the following steps using the part number pages in the back of the brochure:

1. Select drain body.

- a. Select drain body length according to what fits in the space
- b. Choose vertical or side (horizontal) waste outlet configuration.
- c. For non-standard sizes, multi-waste outlets and more, QuickDrain can help you customize a drain body. Please contact us at info@quickdrainusa.com

DRAIN BODY PART NO. _____

2. Select decorative drain cover design, finish, and size.

Lead times may vary base on order quantity and cover selection.

COVER PART NO. _____

3. Select QuickSlope PET Kit

PET KIT PART NO. _____

4. Select waterproofing kit

Special note: ProLine is compatible with liquid waterproofing, while ShowerLine is compatible with liquid or sheet waterproofing. Actual liquid waterproofing product will be supplied by the installer to complete installation.

WATERPROOFING PART NO. _____

5. Select a shower bench to complement your shower installation

SHOWER BENCH PART NO. _____

Technical Support & Job Site Assistance

Our team is able to provide expert on-site instruction and support. We also help by providing early design drawings to get your project started off right.



QUESTIONS?

Call 866-998-6685

Email insidesales@oatey.com

For a complete list of QuickDrain parts, materials and design options, visit QuickDrain.com or call 866.998.6685



Vertical Polished Stainless Steel

Shower Bench: Universal design with elegant style.

The ideal complement to SquareDrain and QuickDrain's complete shower solution, the Shower Bench balances the elegant style, universal design and accessibility that is essential for many.

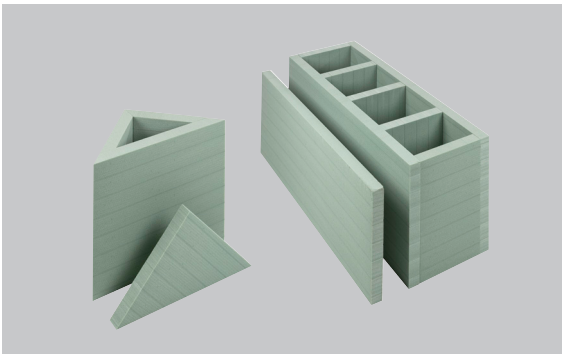

Jobsite-Ready

Ready to assemble with no framing required, reducing the amount of lumber on site. No mechanical fasteners or anchors are required.



Sustainable

2" rigid PET panels made from 100% recycled plastic come ready to assemble and can be easily trimmed on site for custom fit.

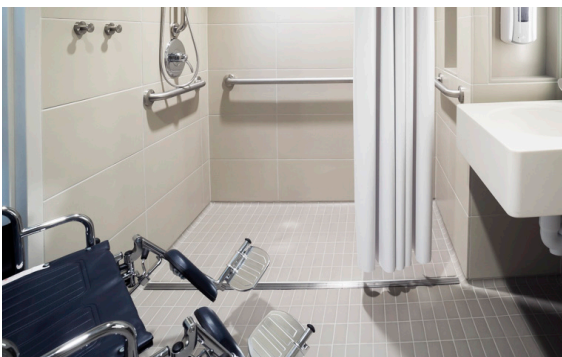

Universal Design & ADA Compliance

Accommodates the ADA standards for height and exceeds ADA weight guideline of 250lbs. ♿



Elegance

Available in three configurations including a rectangle bench and large or small corner bench options. Custom sizes available upon request.

Commitment to community.

As part of our commitment to minimize our environmental footprint, we use 100% recycled plastic bottles (Polyethylene Terephthalate or PET) to manufacture our QuickSlope shower panels. These non-reactive, economical and shatterproof parts do not degrade over time and perform even under the toughest conditions at 145 PSI.

If you're looking to obtain LEED certification for your next project, please contact a QuickDrain representative to hear about our selection of environmentally conscious products, which may qualify for LEED points.



20 million+ Plastic Bottles Recycled

For every QuickDrain shower panel installed, 450 plastic bottles are saved from landfills – 20 million bottles and counting.

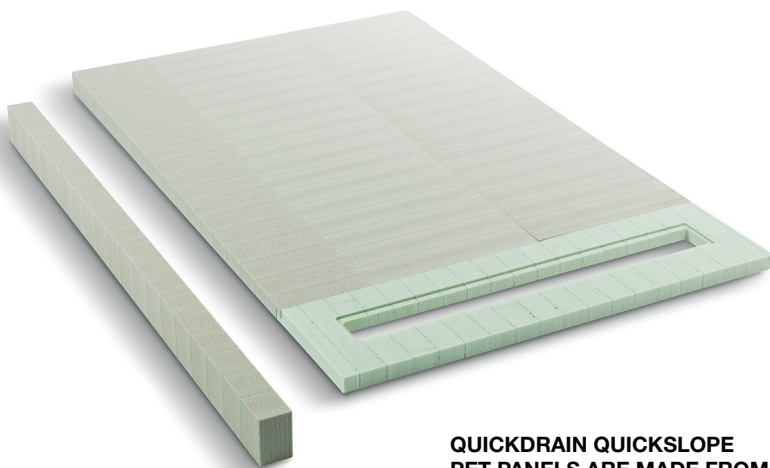

QUICKDRAIN QUICKSLOPE PET PANELS ARE MADE FROM 100% RECYCLED PLASTIC.





HAVE QUESTIONS?

CONTACT A QUICKDRAIN REPRESENTATIVE AT 866-998-6685.

NEED MORE INFORMATION?

VISIT QUICKDRAIN.COM



deliver quality. build trust. improve lives.

QuickDrain USA™ is a part of the Oatey family of brands.

LCS1120D 04/21