

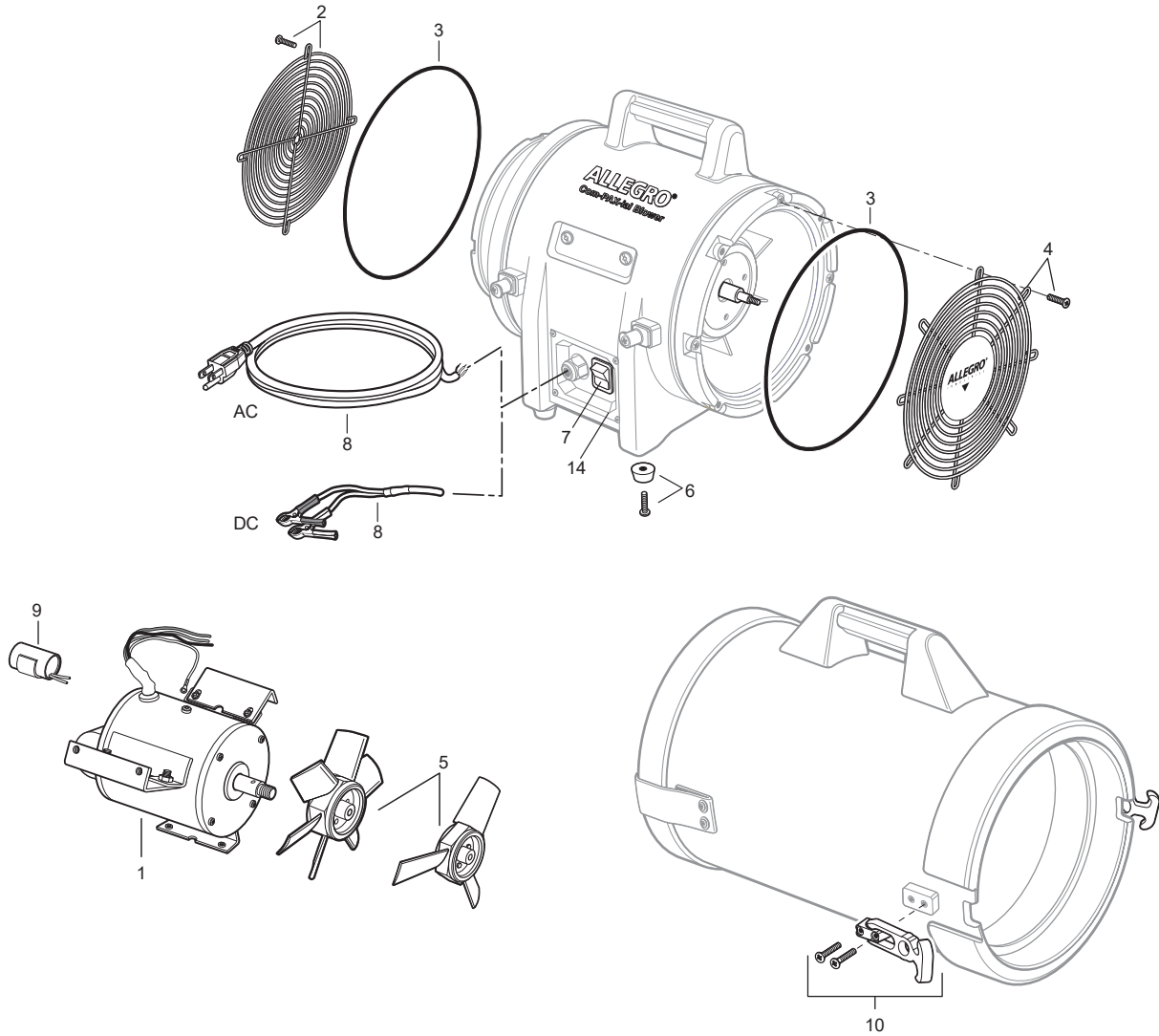

PRODUCT: 12" AXIAL PLASTIC BLOWERS

**PART NUMBER: 9543, 9543-15, 9543-25 (AC)
9546, 9546-15, 9546-25 (DC)
9548, 9548-15, 9548-25 (EX)**



KEY	PART #	DESCRIPTION	KEY	PART #	DESCRIPTION	KEY	PART #	DESCRIPTION
	9543	12" Axial AC Plastic Blower	1	9543-03	Motor	9	9543-03C	Capacitor
	9543-15	12" Axial AC Plastic Blower w/ 15' Ducting		9506-10	Motor (DC) 12 VDC	10	9543-08	Canister Latch Kit
	9543-25	12" Axial AC Plastic Blower w/ 25' Ducting		9513-03EX	Motor (EX)	11	9506-03	Clamps, Battery 50 Amp
	9546	12" Axial DC Plastic Blower	2	9543-09	Fan Guard w/ Screws	12	9506-11	Fuse, 30 Amp, DC Motor
	9546-15	12" Axial DC Plastic Blower w/ 15' Ducting	3	9543-05	Canister O-Ring	13	9534-07	Strain Relief
	9546-25	12" Axial DC Plastic Blower w/ 25' Ducting	4	9543-07	Fan Grill w/ Screws	14	9543-12	Switch Plate w/Screws
	9548	12" Axial EX Plastic Blower	5	9543-10	6 Blade Fan	15	9543-12P	Rectangular Hole Plug
	9548-15	12" Axial EX Plastic Blower w/ 15' Ducting		9509-06	3 Blade Fan	16	9543-14	12" Blower Chassis Kit
	9548-25	12" Axial EX Plastic Blower w/ 25' Ducting		9509-06EX	3 Blade Fan (EX)	17	9548-55DC	Motor Mount
			6	9543-06	Feet Kit (Includes 4 Feet & 4 Screws) (not sold separately)	18	9503-02	Plug, 20A/125V
			7	9543-13	Switch (AC only)	19	9543-12B	Strain Relief
			8	9543-04	AC Electric Cord			
				9506-40	DC Power Cord w/ Clamps			