

HVAC

PRODUCT CATALOG

ISSUE 25



Simplify
Your
Work.™

PADS 1

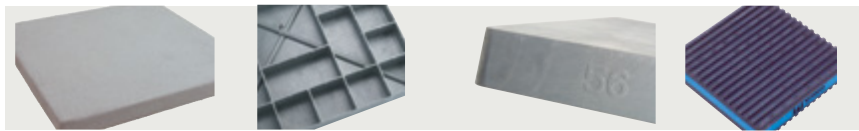

MOUNTING SYSTEMS 7



AIR MOVEMENT 21



HEATING PRODUCTS 27



CONDENSATE MANAGEMENT 35

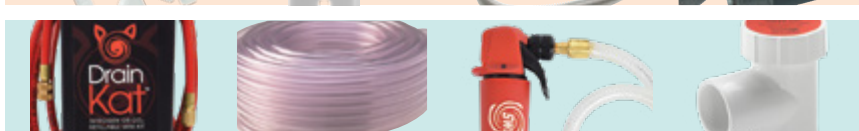

GENERAL INDUSTRIAL 41

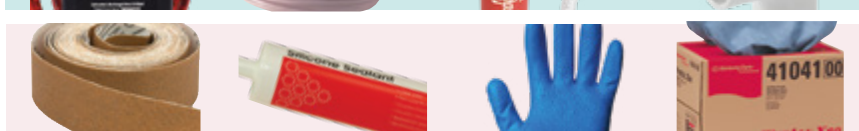

DEVCO 55



ELECTRICAL 85



TOOLS 117

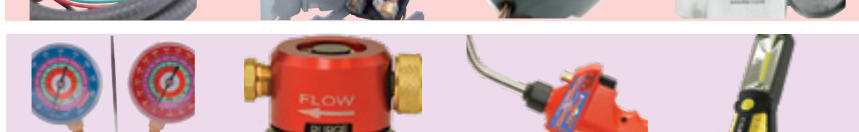

PLUMBING 131

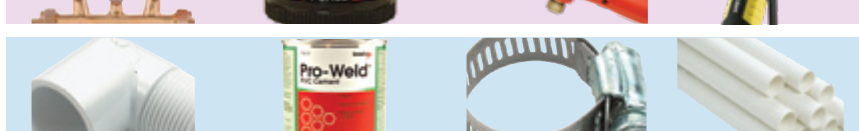

DUCTLESS 141



MAINTENANCE CHEMICALS 151



INLINE COMPONENTS 163



DISTRIBUTOR SUPPORT 181

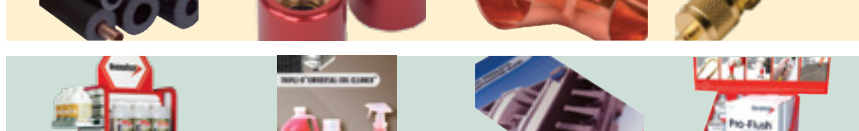

PADS

Anti-Vibration Pads.....	6
CladLite® Lightweight Equipment Pads.....	3
E Lite® Plastic Equipment Pads.....	3
EcoPad™.....	5
Heat Pump Pad.....	6
The Black Pad®.....	5
The Hurricane Pad™.....	4
UltraLite® Lightweight Concrete Equipment Pads.....	2

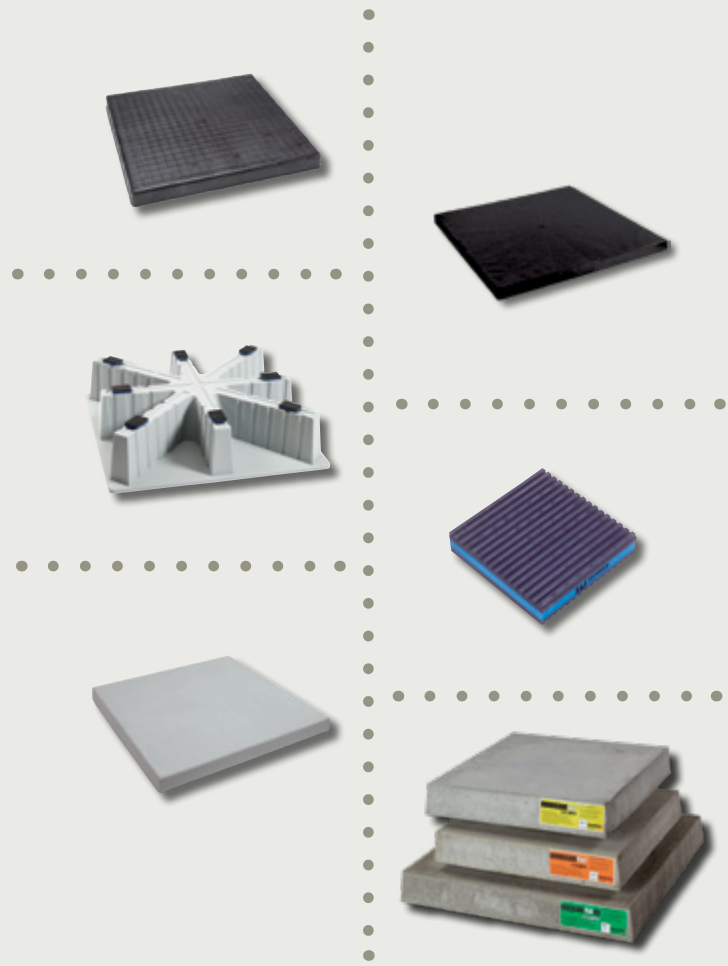

ULTRALITE® LIGHTWEIGHT CONCRETE EQUIPMENT PADS

3" UltraLite® Pads

A true concrete equipment pad at the weight of plastic (about 2.5 lbs. per square foot). UltraLite® is strengthened by miles of fiber in each square foot of fiber-cement coating. This fiber allows the pad to flex instead of cracking or breaking. The textured surface prevents the condensing unit or portable generator from sliding, and allows water drainage, while the engineered expanded polystyrene (EPS) core prevents warping and provides a solid bottom to resist settling. Unaffected by soil conditions, ultraviolet (UV) light, temperature extremes, and other weather conditions.

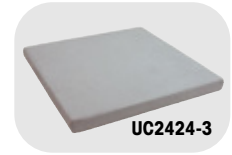

CATALOG NO.	SIZE	PAD WT.	PALLET QTY.	PALLET WT.	UOM	ORDER MULTIPLE
UC1636-3	16 X 36	18	30	565	EA	30
UC1838-3	18 X 38	20	30	625	EA	30
UC2424-3	24 X 24	18	15	295	EA	15
UC2436-3	24 X 36	26	15	415	EA	15
UC2442-3	24 X 42	28	15	445	EA	15
UC2448-3	24 X 48	30	15	475	EA	15
UC2626-3	26 X 26	17	15	280	EA	15
UC3030-3	30 X 30	23	15	370	EA	15
UC3040-3	30 X 40	33	15	520	EA	15
UC3232-3	32 X 32	26	15	415	EA	15
UC3237-3	32 X 37	29	15	460	EA	15
U3353-3	33 X 53	68	15	1,045	EA	15
UC3434-3	34 X 34	27	15	430	EA	15
UC3445-3	34 X 45	39	15	610	EA	15
UC3636-3	36 X 36	30	15	475	EA	15
UC3642-3	36 X 42	32	15	505	EA	15
UC3648-3	36 X 48	37	15	580	EA	15
U3650-3	36 X 50	62	15	955	EA	15
U3654-3	36 X 54	71	15	1,090	EA	15
U3660-3	36 X 60	49	15	760	EA	15
UC3842-3	38 X 42	35	15	550	EA	15
U3865-3	38 X 65	85	15	1,300	EA	15
U3870-3	38 X 70	113	15	1,720	EA	15
UC4040-3	40 X 40	34	15	535	EA	15
UC4042-3	40 X 42	36	15	565	EA	15
U4054-3	40 X 54	81	15	1,240	EA	15
U4550-3	45 X 50	82	15	1,255	EA	15

CATALOG NO.	SIZE	PAD WT.	PALLET QTY.	PALLET WT.	UOM	ORDER MULTIPLE
U4558-3	45 X 58	93	15	1,420	EA	15
U4848-3	48 X 48	85	15	1,300	EA	15
U4854-3	48 X 54	91	15	1,390	EA	15
U4866-3	48 X 66	108	15	1,645	EA	15
U5053-3	50 X 53	92	15	1,405	EA	15
U5056-3	50 X 56	97	15	1,480	EA	15
U5252-3	52 X 52	94	15	1,435	EA	15
U5557-3	55 X 57	109	15	1,660	EA	15

UltraLite® Earthquake Code Compliant Pads

Required nearly exclusively in Southern California, the UltraLite® pad is available for compliance with strict attachment provisions detailed in earthquake prone local building codes. UltraLite® earthquake code compliant pads are only available for sale in regions where local codes mandate installation of pads with these particular characteristics. Currently these locales include most of Southern California, portions of Washington, and portions of Oregon.



CATALOG NO.	SIZE	PAD WT.	PALLET QTY.	PALLET WT.	UOM	ORDER MULTIPLE
UC1838-3CA	18 X 38	18	15	295	EA	15
UC2424-3CA	24 X 24	14	15	235	EA	15
UC2436-3CA	24 X 36	22	15	355	EA	15
UC2448-3CA	24 X 48*	28	15	445	EA	15
UC3030-3CA	30 X 30	22	15	355	EA	15
UC3036-3CA	30 X 36	25	15	400	EA	15
UC3232-3CA	32 X 32	24	15	385	EA	15
UC3636-3CA	36 X 36	28	15	445	EA	15
UC3642-3CA	36 X 42	32	15	505	EA	15
UC3648-3CA	36 X 48	37	15	580	EA	15
UC4040-3CA	40 X 40	34	15	535	EA	15

3" UltraLite® Wedge Pads

The UltraLite® Wedge Pad is designed for Lennox condensing units.



CATALOG NO.	SIZE	PAD WT.	PALLET QTY.	PALLET WT.	UOM	ORDER MULTIPLE
UC3132-3L	31 X 32	23.33	15	350	EA	15
UC3539-3L	35 X 39	33.46	15	502	EA	15
UC4044-3L	40 X 44	37.53	15	563	EA	15

E LITE® PLASTIC EQUIPMENT PADS

E Lite's rugged design provides uniform and generous ribbing for optimum, self-leveling ground support without inserts. The result is a pad that is lightweight, but not too light. A subtle texture prevents unit slide and presents a classic appearance, which is enhanced by rounded edges and a concrete gray color. Each pad is molded with a size label and a symbol representing content of recycled material.



2" E Lite® Pads

The 2" thick E Lite® pad is the choice for plastic pads. Codes have moved toward requiring 3" pads, check local codes for your requirements.

CATALOG NO.	SIZE	PAD WT.	PALLET QTY.	PALLET WT.	UOM	ORDER MULTIPLE
EL2424-2	24 X 24	6	44	310	EA	44
EL2430-2	24 X 30	9	22	203	EA	22
EL2436-2	24 X 36	10	22	270	EA	22
EL2626-2	26 X 26	9	22	201	EA	22
EL3030-2	30 X 30	9	22	209	EA	22
EL3036-2	30 X 36	13	22	290	EA	22
EL3040-2	30 X 40	14	22	307	EA	22
EL3232-2	32 X 32	10	22	231	EA	22
EL3434-2	34 X 34	14	22	306	EA	22
EL3636-2	36 X 36	12	22	291	EA	22
EL3640-2	36 X 40	18	22	380	EA	22
EL3648-2	36 X 48	25	22	384	EA	22
EL3842-2	38 X 42	17	22	446	EA	22

3" E Lite® Pads

Codes have moved toward requiring 3" pads, check local codes for your requirements.



EL5658-3

CATALOG NO.	SIZE	PAD WT.	PALLET QTY.	PALLET WT.	UOM	ORDER MULTIPLE
EL1838-3	18 X 38	9	32	320	EA	32
EL2424-3	24 X 24	9	16	157	EA	16
EL2436-3	24 X 36	12	16	230	EA	16
EL2448-3	24 X 48	14	32	629	EA	32
EL3030-3	30 X 30	12	16	209	EA	16
EL3232-3	32 X 32	13	16	251	EA	16
EL3244-3	32 X 44	21	16	354	EA	16
EL3636-3	36 X 36	16	16	291	EA	16
EL3640-3	36 X 40	23	16	360	EA	16
EL3648-3	36 X 48	25	16	402	EA	16
EL3842-3	38 X 42	18	16	308	EA	16
EL3870-3	38 X 70	36	16	557	EA	16
EL4040-3	40 X 40	26	16	412	EA	16
EL4558-3	45 X 58	43	16	674	EA	16
EL4848-3	48 X 48	36	16	604	EA	16
EL5042-3	50 X 42	28	16	555	EA	16
EL5060-3	50 X 60	40	16	712	EA	16
EL5070-3	50 X 70	47	16	805	EA	16
EL5252-3	52 X 52	40	16	648	EA	16
EL5658-3	56 X 58	55	16	884	EA	16

CLADLITE® LIGHTWEIGHT CONCRETE EQUIPMENT PADS

Concrete surface and superior performance at 20% the weight of conventional concrete pads. The cladding provides superior resistance to sun, moisture and freeze-thaw conditions; the engineered expanded polystyrene (EPS) core is virtually impervious to water, soil conditions, fungus and bacteria. Large CladLite® pads are further strengthened by continuous steel reinforcement throughout the cladding. CladLite® is code approved for installation throughout the U.S.

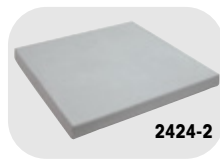

2424-2

3" CladLite® Pads

Used where codes have moved toward requiring 3" pads, check local codes for your requirements.

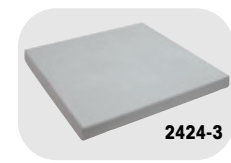

2424-3

2" CladLite® Pads

The 2" thick CladLite® pad is the choice for equipment pads. Codes have moved toward requiring 3" pads, check local codes for your requirements.

CATALOG NO.	SIZE	PAD WT.	PALLET QTY.	PALLET WT.	UOM	ORDER MULTIPLE
2424-2	24 X 24	30	25	780	EA	25
2436-2	24 X 36	50	25	1,275	EA	25
2442-2	24 X 42	57	25	1,450	EA	25
3030-2	30 X 30	36	25	925	EA	25
3036-2	30 X 36	43	25	1,093	EA	25
3040-2	30 X 40	60	25	1,525	EA	25
3143-2	31 X 43	70	25	1,775	EA	25
3232-2	32 X 32	44	25	1,125	EA	25
3434-2	34 X 34	51	25	1,300	EA	25
3636-2	36 X 36	63	25	1,598	EA	25
3640-2	36 X 40	71	25	1,798	EA	25
3648-2	36 X 48	88	25	2,220	EA	25

CATALOG NO.	SIZE	PAD WT.	PALLET QTY.	PALLET WT.	UOM	ORDER MULTIPLE
1636-3	16 X 36	48	20	985	EA	20
2424-3	24 X 24	43	20	877	EA	20
2436-3	24 X 36	60	20	1,215	EA	20
2448-3	24 X 48	84	20	1,695	EA	20
2626-3	26 X 26	50	20	1,015	EA	20
3030-3	30 X 30	62	20	1,255	EA	20
3036-3	30 X 36	73	20	1,487	EA	20
3232-3	32 X 32	68	20	1,379	EA	20
3237-3	32 X 37	73	20	1,485	EA	20
3636-3	36 X 36	80	20	1,633	EA	20
3640-3	36 X 40	97	20	1,969	EA	20
3648-3	36 X 48	109	20	2,207	EA	20
3660-3	36 X 60	163	15	2,470	EA	15
3842-3	38 X 42	120	20	2,417	EA	20
4042-3	40 X 42	170	10	1,605	EA	10
4550-3	45 X 50	184	15	2,785	EA	15
4558-3	45 X 58	203	15	3,070	EA	15
4766-3	47 X 66	219	10	2,215	EA	10
4848-3	48 X 48	184	15	2,785	EA	15
5053-3	50 X 53	197	15	2,980	EA	15

U.S. Patent number 4,505,449, and patents pending. ICBO No. PFC-5112.

THE HURRICANE PAD™ CONCRETE EQUIPMENT PADS

The Hurricane Pad™

Designed specifically for the hurricane prone regions of Florida and the Gulf Coast, The Hurricane Pad™ meets stringent local code requirements for wind resistance. Heavier than a normal concrete pad, this 4" pad provides sufficient weight to meet code. The Hurricane Pad meets the Florida Building Code Notice and can withstand winds up to 150 MPH. For certain taller equipment, The Hurricane T Class Pad™ is needed. Due to their extra weight, standard freight terms only apply for shipments to Florida. All other shipments are shipped FOB Conyers, GA.



The Hurricane T-Class Pad™

The Hurricane T Class Pad™ is even heavier than The Hurricane Pad™ and is designed to meet the higher wind loads of taller equipment. The taller the piece of equipment mounted to the pad, the greater the wind load on the pad. These heavier 4" pads provide sufficient weight to meet code for these taller condensing units. The Hurricane T-Class Pad meets the Florida Building Code Notice and can withstand winds up to 175 MPH. Due to their extra weight, standard freight terms for The Hurricane T Class Pad™ only apply for shipments to Florida. All other shipments are shipped FOB Conyers, GA.



CATALOG NO.	SIZE	PALLET QTY.	UOM	ORDER MULTIPLE
H1840-4	18 X 40	16	EA	16
H2424-4	24 X 24	16	EA	16
H2436-4	24 X 36	8	EA	8
H3030-4	30 X 30	8	EA	8
H3232-4	32 X 32	8	EA	8
H3636-4	36 X 36	8	EA	8
H3642-4	36 X 42	8	EA	8
H3648-4	36 X 48	8	EA	8
H3652-4	36 X 52	8	EA	8
H3654-4	36 X 54	8	EA	8
H3656-4	36 X 56	8	EA	8
H3672-4	36 X 72	8	EA	8
H3852-4	38 X 52	8	EA	8
H3865-4	38 X 65	8	EA	8
H3872-4	38 X 72	8	EA	8
H4040-4	40 X 40	8	EA	8
H4242-4	42 X 42	8	EA	8
H4558-4	45 X 58	8	EA	8
H5557-4	55 X 57	8	EA	8

CATALOG NO.	SIZE	PALLET QTY.	UOM	ORDER MULTIPLE
HT1840-4	18 X 24	10	EA	10
HT2436-4	24 X 36	5	EA	5
HT3030-4	30 X 30	5	EA	5
HT3232-4	32 X 32	5	EA	5
HT3636-4	36 X 36	5	EA	5
HT3648-4	36 X 48	5	EA	5
HT4040-4	40 X 40	5	EA	5
HT4242-4	42 X 42	5	EA	5
HT4558-4	45 X 58	5	EA	5

The Hurricane Pad™ MD

The new Hurricane Pad™ MD is the newest in concrete pad technology from DiversiTech. The Hurricane Pad MD is a solid concrete pad designed for the strict requirements of Miami Dade county. The Hurricane Pad MD meets the Florida Building Code Notice and can withstand winds up to 175 MPH. This pad is made from a minimum 7000PSI solid concrete. For Florida shipments only.

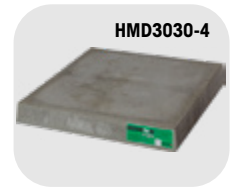

CATALOG NO.	SIZE	PALLET QTY.	UOM	ORDER MULTIPLE
HMD1840-4	18 X 40 X 4	5	EA	5
HMD3030-4	30 X 30 X 4	5	EA	5
HMD3636-4	36 X 36 X 4	5	EA	5
HMD3648-4	36 X 48 X 4	5	EA	5
HMD4040-4	40 X 40 X 4	5	EA	5

Potential Hurricane Winds Map

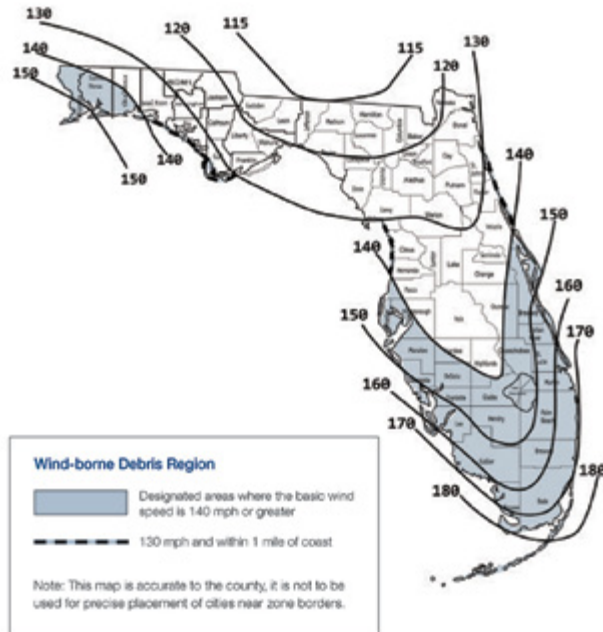

THE HURRICANE PAD™ CONCRETE EQUIPMENT PADS cont'd

The Hurricane Pad™ Tie Down Clips

Brackets used to secure condensing units to a pad or stand. These Florida approved clips use #8 self-tapping or self-drilling screws to secure to condenser.



CATALOG NO.	DESCRIPTION	UOM	ORDER MULTIPLE
TDC-4	The Hurricane Pad™ Attachment Bracket - 4", pack of 4	PK	1
TDC-6	The Hurricane Pad™ Attachment Bracket - 6", pack of 4	PK	1
TDC-8	The Hurricane Pad™ Attachment Bracket - 8", pack of 4	PK	1
TDC-10	The Hurricane Pad™ Attachment Bracket - 10", pack of 4	PK	1
TDC-12	The Hurricane Pad™ Attachment Bracket - 12", pack of 4	PK	1

THE BLACK PAD® BLACK PLASTIC EQUIPMENT PADS

The Black Pad® is an innovative equipment pad. The pad is extremely durable, resistant to ultraviolet light, and heavier than a completely plastic pad. The Black Pad® is suitable for use with pool pumps, filters, and heaters and complies with the 1997 Standard Swimming Pool Code sections 305.2 Mounting and section 405 Equipment Foundations and Enclosures.



The Black Pad® — 3"

Used where codes have moved toward requiring 3" pads. Check local codes for your requirements.

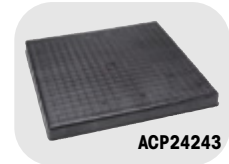

The Black Pad® — 2"

The 2" thick Black Pad® is the choice for plastic pads. Codes have moved toward requiring 3" pads, check local codes for your requirements.

CATALOG NO.	SIZE	PAD WT.	PALLET QTY.	PALLET WT.	UOM	ORDER MULTIPLE
ACP24242	24 X 24	10	24	231	EA	24
ACP30302	30 X 30	13	24	339	EA	24
ACP32322	32 X 32	16	24	387	EA	24
ACP36362	36 X 36	19	24	450	EA	24
ACP38422	38 X 42	25	24	549	EA	24

CATALOG NO.	SIZE	PAD WT.	PALLET QTY.	PALLET WT.	UOM	ORDER MULTIPLE
ACP24243	24 X 24	12	16	188	EA	16
ACP30303	30 X 30	20	16	274	EA	16
ACP32323	32 X 32	25	16	304	EA	16
ACP36363	36 X 36	23	16	367	EA	16
ACP36483	36 X 48	37	16	484	EA	16

ECOPAD™ BLACK PLASTIC EQUIPMENT PADS

An injection molded equipment pad created from 100% recycled materials to minimize environmental impact. It does not require any additional equipment for moving and handling. EcoPad™ is resistant to impact, ultra-violet degradation and weathering (virtually impervious to climatic variations), and will not crack, flake, or warp. Drillable to permit installation of refrigerant and electrical lines under and through the pad and to allow equipment to easily secure to the pad.



EcoPad™ — 3"

Used where codes have moved toward requiring 3" pads, check local codes for your requirements.



EcoPad™ — 2"

The 2" thick EcoPad™ is the choice for plastic pads. Codes have moved toward requiring 3" pads, check local codes for your requirements.

CATALOG NO.	SIZE	PAD WT.	PALLET QTY.	PALLET WT.	UOM	ORDER MULTIPLE
EP2424-2	24 X 24 X 2	6	24	166	EA	24
EP2436-2	24 X 36 X 2	10	24	227	EA	24
EP2626-2	26 X 26 X 2	9	24	226	EA	24
EP3030-2	30 X 30 X 2	9	24	224	EA	24
EP3036-2	30 X 36 X 2	13	24	294	EA	24
EP3232-2	32 X 32 X 2	10	24	260	EA	24
EP3434-2	34 X 34 X 2	14	24	339	EA	24
EP3636-2	36 X 36 X 2	12	24	299	EA	24
EP3648-2	36 X 48 X 2	19	24	476	EA	24
EP3842-2	38 X 42 X 2	17	24	430	EA	24

CATALOG NO.	SIZE	PAD WT.	PALLET QTY.	PALLET WT.	UOM	ORDER MULTIPLE
EP1838-3	18 X 38 X 3	9	32	292	EA	32
EP2424-3	24 X 24 X 3	9	16	150	EA	16
EP2436-3	24 X 36 X 3	12	16	210	EA	16
EP2448-3	24 X 48 X 3	14	32	645	EA	32
EP3030-3	30 X 30 X 3	12	16	212	EA	16
EP3232-3	32 X 32 X 3	13	16	220	EA	16
EP3434-3	34 X 34 X 3	21	16	291	EA	16
EP3636-3	36 X 36 X 3	16	16	271	EA	16
EP3640-3	36 X 40 X 3	23	16	360	EA	16
EP3648-3	36 X 48 X 3	25	16	433	EA	16
EP3842-3	38 X 42 X 3	18	16	311	EA	16
EP3870-3	38 X 70 X 3	36	16	545	EA	16
EP4040-3	40 X 40 X 3	26	16	406	EA	16
EP4558-3	45 X 58 X 3	43	16	725	EA	16
EP4848-3	48 X 48 X 3	36	16	591	EA	16
EP5042-3	50 X 42 X 3	28	16	511	EA	16
EP5060-3	50 X 60 X 3	40	16	705	EA	16
EP5070-3	50 X 70 X 3	47	16	808	EA	16
EP5252-3	52 X 52 X 3	40	16	633	EA	16
EP5658-3	56 X 58 X 3	55	16	884	EA	16

HEAT PUMP PAD™

Heat Pump Pad™

Provides an effective base for heat pump equipment installed in snowy climates. Rather than a combination of a typical 2" (or 3") equipment pad and 6" heat pump risers, the Heat Pump Pad™ provides a full 8" of elevation in a simple square footprint. The star pattern of the integral risers allows for installation of equipment with different size footprints up to 36" x 36". Also included are eight anti vibration pads uniquely designed to fit into the guide slots on the top of the integral risers. The base is sloped outward to allow for easy drainage of condensate or defrost cycle condensate when the outdoor coil is operating in heat pump mode. Nestable for efficient shipping, transportation, and warehousing. Injection molded from concrete gray, recycled polypropylene material, the Heat Pump Pad™ is environmentally friendly and designed to last longer than the equipment it supports. US Patent Number 7,891,635, and other patent(s) pending.



CATALOG NO.	DESCRIPTION	UOM	ORDER MULTIPLE
HP3232-8	32" x 32" x 8"	EA	16
HP3636-8	36" x 36" x 8"	EA	16

ANTI-VIBRATION PADS

E.V.A. Anti-Vibration Pad

The latest generation in vibration dampening technology. The most effective vibration dampening pad available on the market. The EVA Pad was tested against other pads at four different vibration settings. In the most severe vibration extremes, the EVA Pad outperforms cork and rubber by a margin of greater than 3:1! This is due to the special composite foam center which is much more structurally sound than cork. It is not affected by oils or chemicals that can break down cork and is much more effective at vibration dampening than solid rubber. All this at a very competitive price. Designed to withstand 50 psi.

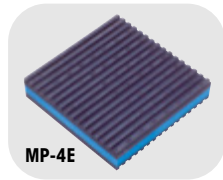

CATALOG NO.	DESCRIPTION	UOM	ORDER MULTIPLE
MP-2E	2" x 2" x 7/8" E.V.A. Pad	EA	48
MP-3E	3" x 3" x 7/8" E.V.A. Pad	EA	36
MP-4E	4" x 4" x 7/8" E.V.A. Pad	EA	24
MP-6E	6" x 6" x 7/8" E.V.A. Pad	EA	24
MP-12E	12" x 12" x 7/8" E.V.A. Pad	EA	12
MP-18E	18" x 18" x 7/8" E.V.A. Pad	EA	6

Rubber Anti-Vibration Pad

Highest quality elastomeric oil resistant padding. Designed to withstand 50 lbs. psi. The rubber pads are corrugated on both sides. Ideal for air conditioners, compressors, cooling towers, presses, machines, etc.



CATALOG NO.	DESCRIPTION	UOM	ORDER MULTIPLE
MP-2	2" x 2" x 3/8" Rubber	EA	48
MP-3	3" x 3" x 3/8" Rubber	EA	36
MP-4	4" x 4" x 3/8" Rubber	EA	24
MP-6	6" x 6" x 3/8" Rubber	EA	24
MP-8	8" x 8" x 3/8" Rubber	EA	12
MP-12	12" x 12" x 3/8" Rubber	EA	12
MP-18	18" x 18" x 3/8" Rubber	EA	6

Rubber/Cork Anti-Vibration Pad

Highest quality elastomeric oil resistant padding. Designed to withstand 50 psi. The rubber pads are corrugated on both sides. The cork is laminated between two corrugated pads. Ideal for air conditioners, compressors, cooling towers, presses, machines, etc.

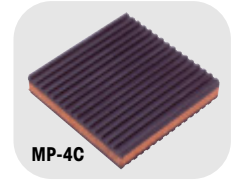

CATALOG NO.	DESCRIPTION	UOM	ORDER MULTIPLE
MP-2C	2" x 2" x 7/8" Rubber/Cork	EA	48
MP-3C	3" x 3" x 7/8" Rubber/Cork	EA	36
MP-4C	4" x 4" x 7/8" Rubber/Cork	EA	24
MP-6C	6" x 6" x 7/8" Rubber/Cork	EA	24
MP-12C	12" x 12" x 7/8" Rubber/Cork	EA	12
MP-18C	18" x 18" x 7/8" Rubber/Cork	EA	6

Iso-Cube Economy Anti-Vibration Pad

Natural rubber pads, designed to reduce vibration and noise emanating from refrigeration and air conditioning equipment. The circular design in each pad offers a suction cup effect, which eliminates the need to bolt the pads down. A standard 18" (46cm) pad is divided into eighty-one 2" (5cm) segments, each of which may be cut or torn to provide smaller pads. These 50 durometer pads will withstand a load of 180 psi with greater resiliency.



CATALOG NO.	DESCRIPTION	UOM	ORDER MULTIPLE
ISO-2	2" x 2" x 3/4" Iso-Cube	EA	24
ISO-4	4" x 4" x 3/4" Iso-Cube	EA	12
ISO-18	18" x 18" x 3/4" Iso-Cube	EA	6

MOUNTING SYSTEMS

Equipment Stands	11-12
Hanging Brackets.....	13-14
Heat Pump Risers	8
Hooks, Springs & Fixture Support.....	18
Mini-Split Stands	10-11
Mounting Accessories	13
Mounting Blocks	8-9
Mounting Brackets	9-10
Mounting Straps	19
Spring Fitting & Beam Clamps	17-18
Strut Clips & Clamps	14-16
Strut and Threaded Rod Accessories	16-17

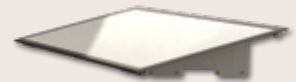
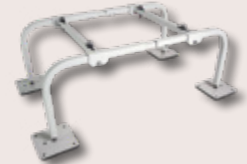

HEAT PUMP RISERS

One Piece Heat Pump Risers

Sturdy and stable, DiversiTech's Heat Pump Riser provides the desired elevation for condensers, heat pumps, and air handlers. The one piece, heavy duty plastic unit is manufactured in three heights. Butyl mastic on the top and bottom guarantees no slipping and reduced vibration and noise.



CATALOG NO.	DESCRIPTION	UOM	ORDER MULTIPLE
HPR-3	Riser – 3"	EA	48
HPR-3BL	Riser – 3", Black	EA	48
HPR-6	Riser – 6"	EA	36
HPR-6BL	Riser – 6", Black	EA	36
HPR-12	Riser – 12"	EA	16

Two Piece Heat Pump Risers

Sturdy and stable, DiversiTech's Heat Pump Riser provides the desired elevation for condensers, heat pumps, and air handlers. The one piece, heavy duty plastic unit is manufactured in two heights and an extension. Butyl mastic on the top and bottom guarantees no slipping and reduced vibration and noise.



CATALOG NO.	DESCRIPTION	UOM	ORDER MULTIPLE
HPR-3-2P	Two Piece Riser – 3"	EA	32
HPR-6-2P	Two Piece Riser – 6"	EA	16
HPR-3-2PG	Two Piece Black Riser – 3"	EA	32
HPR-6-2PG	Two Piece Black Riser – 6"	EA	16
HPR-EXT	4" Extension	EA	28

Adjustable Equipment Risers

Adjustable equipment risers easily adjust up or down as needed to secure equipment at the correct height. The large center barrel twists up from starting height of 5" to a max of 8". A separate top cap allows for raising or lowering the riser even with equipment already on it. Convenient height markings provided for reference.



CATALOG NO.	DESCRIPTION	UOM	ORDER MULTIPLE
AER-8	Adjustable Equipment Riser - 8"	EA	4
AER-8BL	Adjustable Equipment Riser - 8" Black	EA	4

MOUNTING BLOCKS

Air Handler Block

Lightweight styrofoam block (white) provides A/C air handler support in attic installations.

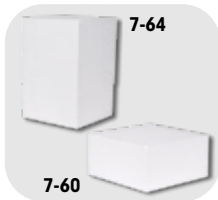

CATALOG NO.	DESCRIPTION	UOM	ORDER MULTIPLE
7-60	Air Handler Block 8" x 8" x 4"	EA	144
7-64	Air Handler Block 8" x 8" x 4", pack of 4	PK	4

Base Pad

Used as a mounting base when condensing units must be bolted down. Maximum load capacity is 220 lbs. per pad. Sliding rail design for easy and fast installation. Includes mounting bolts. Available in 17" lengths. Ivory color.



CATALOG NO.	DESCRIPTION	UOM	ORDER MULTIPLE
230-BP17W	17" Base Pad, pack of 2	PK	10

Furnace Mounting Blocks

Each furnace mounting block can support 40% more weight than competitive products – over 500 pounds! Easy peel and stick installation.



CATALOG NO.	DESCRIPTION	UOM	ORDER MULTIPLE
FB-1	Furnace Mounting Block	EA	72

Hef-T-Block™

Used as mounting bases when condensing units must be bolted down. Available in three lengths. Furnished complete with end caps and mounting bolts. Maximum load capacity is 440 pounds per mounting block. Installation temperature range from -4°F (-20°C) to 140°F (60°C). Hef T Blocks fit all mini split condensing units with a unique sliding rail feature.



CATALOG NO.	DESCRIPTION	UOM	ORDER MULTIPLE
230-MB14W	14" Hef-T-Block™ (White), pack of 2	PK	1
230-MB17W	17" Hef-T-Block™ (White), pack of 2	PK	1
230-MB36W	36" Hef-T-Block™ (White), pack of 2	PK	1
230-MBCW	Hef-T-Block™ Replacement End Cap (White), pack of 4	PK	25

MOUNTING BLOCKS cont'd

Hef-T-Foot™

The Hef-T-Foot™ is used to support small pipework, runs of cable tray, or an alternative to supporting condensing units, air source heat pumps or a variety of outdoor equipment.

The Hef-T-Foot™ with strut comes in four lengths — 9.8", 15.7", 23.6", 39.4". They are manufactured from heavy duty recycled rubber and come complete with .8" x 1.6" galvanized steel strut adhered to the rubber with industrial adhesive. The rubber is strong and durable to allow standing water to flow under the foot.



FF-250-S



FF-250-UNI

CATALOG NO.	DESCRIPTION	UOM	ORDER MULTIPLE
FF-250-S	Hef-T-Foot™ – 9.8" with 1.6" x .8" strut	EA	1
FF-400-S	Hef-T-Foot™ – 15.7" with 1.6" x .8" strut	EA	1
FF-600-S	Hef-T-Foot™ – 23.6" with 1.6" x .8" strut	EA	1
FF-1000-S	Hef-T-Foot™ – 39.4" with 1.6" x .8" strut	EA	1
FF-250-UNI	Hef-T-Foot™ – 9.8" Universal	EA	1
FF-400-S-KIT	Mini-Split Installation Kit - 15.7"	EA	1
FF-600-S-KIT	Mini-Split Installation Kit - 23.6"	EA	1
FF-1000-S-KIT	Mini-Split Installation Kit - 39.4"	EA	1

Hef-T-Foot™ Installation Variants



Mini-Split Installation Kit

Comes with 2 feet & Mounting Hardware



MOUNTING BRACKETS

Boiler Bracket

Newly redesigned mounting bracket for boilers and tankless water heaters. Available in wall mount or stand-alone configurations. Fits most boilers and tankless water heater designs. Bracket comes partially assembled for quick installations.



QSBB3000 QSBB4000

QUICK-SLING
by DiversiTech

CATALOG NO.	DESCRIPTION	UOM	ORDER MULTIPLE
QSBB3000	Boiler Bracket - Wall Mount, Fixed Horizontal Arm: 32", 350 lbs capacity	EA	1
QSBB4000	Boiler Bracket - Free Standing, Fixed Horizontal Arm: 24", Adjustable Arm Height: 6" to 33", 350 lbs capacity	EA	1

Wall Brackets - Flat Wall

The QSWB1000 Condenser Wall Bracket provides a quick and safe mount that is perfectly designed for installation to a flat wall surface and can hold up to 500lbs. It also has the flexibility to be installed in the up and out orientation or down and out.



QSWB1000

QUICK-SLING
by DiversiTech

CATALOG NO.	DESCRIPTION	UOM	ORDER MULTIPLE
QSWB1000	Mini Split Wall Bracket	EA	1

Hef-T-Bracket™

Used for supporting condensing units, Hef-T-Brackets (Type 2) feature a cross bar that is attached to a wall, and two L shaped brackets that are hooked and bolted into place on the cross bar. The condensing unit is mounted onto the L shaped brackets, and fastened using the bolts and anti vibration washers provided.

*Not approved for South Florida.



230-B2L

CATALOG NO.	DESCRIPTION	ARM LENGTH	LOAD RATING PER ARM	UOM	ORDER MULTIPLE
230-B2M	Hef-T-Bracket™ – Medium	18"	176#	EA	1
230-B2L	Hef-T-Bracket™ – Large	21"	176#	EA	1

Wall Brackets - Siding or Flat Wall

This condenser wall bracket combines the installation flexibility of the QSWB1000 and the slider track mounting rail of the QSWB2000 to create a Heavy Duty, versatile mounting solution.



QSWB1100

QUICK-SLING
by DiversiTech

CATALOG NO.	DESCRIPTION	UOM	ORDER MULTIPLE
QSWB1100	Wall Bracket w/Rails Light Dty	EA	1

Wall Bracket - Foundation Mount

This unique, 300lb condenser mounting bracket is designed to install directly to a foundation and still provides 7" clearance between the wall and the unit. The shelf depth is 19" and allows plenty of room for piping and service.



QSWB3000

QUICK-SLING
by DiversiTech

CATALOG NO.	DESCRIPTION	UOM	ORDER MULTIPLE
QSWB3000	Wall Bracket w/Rails Heavy Dty	EA	1

MOUNTING BRACKETS cont'd

Wall Bracket - Siding or Flat Wall

These hurricane rated wall brackets are strong, easy to install and are designed to be mounted into framing studs at 12" or 16" on center. These fit most mini-split models on the market today and provides the required distance between the wall and the condenser for optimal air flow. The QSWB2000 is rated for 300 lbs and the heavy duty QSWB4000 is rated for 600 lbs. Both models are also available in 316 stainless steel.



QSWB2000



CATALOG NO.	DESCRIPTION	UOM	ORDER MULTIPLE
QSWB2000	Wall Bracket w/Z Bend	EA	1
QSWB2000SS	Wall Bracket w/Z Bend, Stainless Steel	EA	1
QSWB2000-3	Wall Bracket w/Z Bend, 3 Mounting Arms	EA	1
QSWB2004	Wall Bracket - Extra Large	EA	1
QSWB2005	Wall Bracket - Extra Large, 3 Mounting Arms	EA	1
QSWB4000	Wall Bracket w/Z Bend	EA	1
QSWB4000SS	Wall Bracket w/Z Bend, Stainless Steel	EA	1

Pitched Roof Mini-Split Mounting Bracket

The Quick-Sling® Pitched Roof Mini-Split Mounting Bracket is a fast and easy solution to mounting outdoor condensing units to a sloped roof.



QSPR1000



CATALOG NO.	DESCRIPTION	UOM	ORDER MULTIPLE
QSPR1000	Pitched Roof Bracket 300 lbs capacity, 9° - 45° sloped roofs	EA	1

Air Conditioner Brackets

These heavy duty 10ga thick steel AC brackets are perfect for hanging A/C condensers and heat pumps outside the home. Mount at any height to allow for easy maintenance under units. No need to wait for finished grade or landscaping prior to installation of AC unit. Pre punched holes for easy installation. Powder coated gray finish. Load rating 600 lbs. per pair.

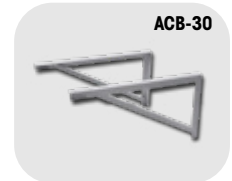

ACB-30



CATALOG NO.	DESCRIPTION	UOM	ORDER MULTIPLE
ACB-30	AC Mounting Bracket - 30", pack of 2	PK	1
ACB-36	AC Mounting Bracket - 36", pack of 2	PK	1
ACB-42	AC Mounting Bracket - 42", pack of 2	PK	1
ACB-48	AC Mounting Bracket - 48", pack of 2	PK	1
ACB-30-AL	AC Mounting Bracket, Aluminum - 30", pack of 2	PK	1
ACB-36-AL	AC Mounting Bracket, Aluminum - 36", pack of 2	PK	1
ACB-42-AL	AC Mounting Bracket, Aluminum - 42", pack of 2	PK	1
ACB-48-AL	AC Mounting Bracket, Aluminum - 48", pack of 2	PK	1

Ductless Cassette Hangers

The Ductless Cassette Hangers are an innovative bracket design that is made of light-weight aluminum to provide quick and easy installation of ductless cassettes. Only two sku's are compatible with most of the ductless cassettes on the market today. The built-in adjustability allows the alignment of the unit after it has been hung.



QSCH1000



CATALOG NO.	DESCRIPTION	UOM	ORDER MULTIPLE
QSCH1000	Ductless Cassette Hanger - Small Holds up to 200 lbs.	EA	1
QSCH2000	Ductless Cassette Hanger - Large Holds up to 200 lbs.	EA	1

MINI-SPLIT STANDS

Mini-Split Stands

Our Quick-Sling® Mini-Split Stands provide a safe, stable platform to mount your unit on. It keeps unit elevated above lawn mowers, weed whackers, pets, snow, and flooding. The elevated height allows for ease of installation, maintenance and service. **Now available in Stainless Steel.**

CATALOG NO.	DESCRIPTION	UOM	ORDER MULTIPLE
QSMS1200	Mini-Split Stand Thin - 12"	EA	1
QSMS1201	Mini-Split Stand Wide - 12"	EA	1
QSMS1201-SS	Mini-Split Stand Wide - 12" Stainless Steel	EA	1
QSMS1800	Mini-Split Stand Thin - 18"	EA	1
QSMS1801	Mini-Split Stand Wide - 18"	EA	1
QSMS1801-SS	Mini-Split Stand Wide - 18" Stainless Steel	EA	1
QSMS2400	Mini-Split Stand Thin - 24"	EA	1
QSMS2401	Mini-Split Stand Wide - 24"	EA	1
QSMS2401-SS	Mini-Split Stand Wide - 24" Stainless Steel	EA	1



QSMS1201



MINI-SPLIT STANDS cont'd

Large Mini-Split Stands

The large Quick-Sling® Mini-Split Stand is made extra wide to accommodate larger equipment with up to 38" wide mounting hole locations. This stand comes with 2 mounting rails.



QSMS1204
QUICK-SLING
by DiversiTech

CATALOG NO.	DESCRIPTION	UOM	ORDER MULTIPLE
QSMS1204	Mini-Split Stand - Extra Wide - 2 Rails, 12" Tall	EA	1
QSMS1804	Mini-Split Stand - Extra Wide - 2 Rails, 18" Tall	EA	1
QSMS2404	Mini-Split Stand - Extra Wide - 2 Rails, 24" Tall	EA	1

Mini-Split Super Stand

The Quick-Sling® Mini-Split Super Stand accommodates up to 6 outdoor mini-split condensing units on a single stand. With the addition of the extender kits condensing units can be added in increments of 2 per kit. The Mini-Split Super Stand is made from the same heavy-duty steel structural design as the VRF Super Stands.



QSMS3001-12
QUICK-SLING
by DiversiTech

CATALOG NO.	DESCRIPTION	UOM	ORDER MULTIPLE
QSMS3001-12	Mini-Split Super Stand, 6 systems, 12" High	EA	1
QSMS3001-18	Mini-Split Super Stand, 6 systems, 18" High	EA	1
QSMS3001-24	Mini-Split Super Stand, 6 systems, 24" High	EA	1
QSMS3001-12EXT	Mini-Split Super Stand Extender Kit, 2 systems, 12" High	EA	1
QSMS3001-18EXT	Mini-Split Super Stand Extender Kit, 2 systems, 18" High	EA	1
QSMS3001-24EXT	Mini-Split Super Stand Extender Kit, 2 systems, 24" High	EA	1

3 Rail Large Mini-Split Stands

The large 3 Rail Mini-Split Stand is made extra wide to accommodate larger equipment with up to 38" wide mounting hole locations. This stand comes with 3 mounting rails.



QSMS1205
QUICK-SLING
by DiversiTech

CATALOG NO.	DESCRIPTION	UOM	ORDER MULTIPLE
QSMS1205	Mini-Split Stand - Extra Wide - 3 Rails, 12" Tall	EA	1
QSMS1805	Mini-Split Stand - Extra Wide - 3 Rails, 18" Tall	EA	1
QSMS2405	Mini-Split Stand - Extra Wide - 3 Rails, 24" Tall	EA	1

Mini-Split Dual Fan Stands

Our Quick-Sling® Mini-Split Dual Fan Stands provide a safe, stable platform to mount your unit on. It keeps unit elevated above lawn mowers, weed whackers, pets, snow, and flooding. The elevated height allows for ease of installation, maintenance and service.



QSMS1202
QUICK-SLING
by DiversiTech

CATALOG NO.	DESCRIPTION	UOM	ORDER MULTIPLE
QSMS1202	Mini-Split Dual Fan Stand - 12"	EA	1
QSMS1802	Mini-Split Dual Fan Stand - 18"	EA	1
QSMS2402	Mini-Split Dual Fan Stand - 24"	EA	1

Mini-Split Double Stack Stand

Our Quick-Sling® Mini-Split Double Stack Stand provide a safe, stable platform to mount your unit on. It keeps unit elevated above lawn mowers, weed whackers, pets, snow, and flooding. The elevated height allows for ease of installation, maintenance and service.



QSMS1203
QUICK-SLING
by DiversiTech

CATALOG NO.	DESCRIPTION	UOM	ORDER MULTIPLE
QSMS1203	Mini-Split Double Stack Stand	EA	1
QSMS1203-N	Mini-Split Double Stack Stand	EA	1

EQUIPMENT STANDS

Heat Pump Stand

Our Quick-Sling® Heat Pump Stand provides a safe stable platform to mount your unit on. Keep it elevated above lawn mowers, weed whackers, pets, snow, and flooding. Elevated height allows for ease of installation, service, and maintenance.

CATALOG NO.	DESCRIPTION	UOM	ORDER MULTIPLE
QSTD3000	Quick Heat Pump Stand, 18" Tall	EA	1
QSTD3000-12	Quick Heat Pump Stand, 12" Tall	EA	1



QSTD3000
QUICK-SLING
by DiversiTech

EQUIPMENT STANDS cont'd

Vertical Air Handler Stand

Our Quick-Sling® Vertical Air Handler Stand fits all LG, Unico and Mitsubishi Air Handlers. It is adjustable left to right in 1" increments up to 6". 18" and 24" stands include 2 stability arms. 500 lbs Max Capacity.



QSTD4000
QUICK-SLING
 by DiversiTech

CATALOG NO.	DESCRIPTION	UOM	ORDER MULTIPLE
QSTD4000	12" Vert Air Hdler Std 19" Arm	EA	1
QSTD4001	12" Vert Air Hdler Std 23" Arm	EA	1
QSTD4002	12" Vert Air Hdler Std 27" Arm	EA	1
QSTD5000	18" Vert Air Hdler Std 19" Arm	EA	1
QSTD5001	18" Vert Air Hdler Std 23" Arm	EA	1
QSTD5002	18" Vert Air Hdler Std 27" Arm	EA	1
QSTD6000	24" Vert Air Hdler Std 19" Arm	EA	1
QSTD6001	24" Vert Air Hdler Std 23" Arm	EA	1
QSTD6002	24" Vert Air Hdler Std 27" Arm	EA	1

Vibration Isolation Strips for Mini-Split & VRF/VRV

These high-density elastometric-coated, molded and pre-compressed fiberglass strips are UV resistant and designed to provide vibration isolation and allow controlled movement in the fiber media.



QSAC5101
QSAC5201
QUICK-SLING
 by DiversiTech

CATALOG NO.	DESCRIPTION	UOM	ORDER MULTIPLE
QSAC5100	Mini-Split Vibration Isolation Strips - '00 for narrow mini-split stands	EA	1
QSAC5101	Mini-Split Vibration Isolation Strips - '01 for standard mini-split stands	EA	1
QSAC5102	Mini-Split Vibration Isolation Strips - '02 for two fan mini-split stands	EA	1
QSAC5104	Mini-Split Vibration Isolation Strips - '04 for 2-arm large mini-split stands	EA	1
QSAC5105	Mini-Split Vibration Isolation Strips - '01 for 3-arm large mini-split stands	EA	1
QSAC5200	Super Stand® Vibration Isolation Strips - 48 in.	EA	1
QSAC5201	Super Stand® Vibration Isolation Strips - 62 in.	EA	1
QSAC5202	Super Stand® Vibration Isolation Strips - 74 in.	EA	1

Air Handler Base – Heavy Duty Adjustable

Made of 14 gauge galvanized steel for excellent corrosion resistance and longevity. 22" high x 22" deep. Width is adjustable from 16" – 26". Supports up to 200 lbs.



6-HAB-BG

CATALOG NO.	DESCRIPTION	UOM	ORDER MULTIPLE
6-HAB-BG	Steel Air Handler Base	EA	1

Horizontal Air Handler Stand

Our Quick-Stand is made of 14-gauge square tubing. This not only cuts down on vibration but allows the stand to hold up to 500 lbs. Each leg individually extends in 1" increments using thumb screws & wing nuts for speed and versatility. Installs as low as 22" on flat or uneven surfaces.



QSTD1000
QUICK-SLING
 by DiversiTech

CATALOG NO.	DESCRIPTION	UOM	ORDER MULTIPLE
QSTD1000	Quick-Stand Heavy Duty	EA	1
QSTD2000	Quick-Stand Light Duty	EA	1

VRF/VRV Super Stand®

The New VRF/VRV Super Stand® Equipment Stands are now simpler to order, easier to size and compatible with more equipment model families.

- New sliding rail design allows infinite depth adjustments to fit most all VRF/VRV systems.
- New rail mounting slots align to all equipment mounting hole configurations.
- New Base and Extension models reduces number of model numbers making selecting and configuring the right stands quick and easy.

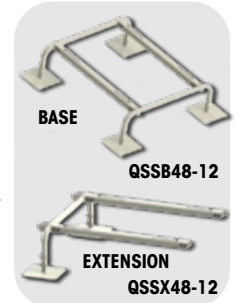

BASE
QSSB48-12
EXTENSION
QSSX48-12
QUICK-SLING
 by DiversiTech

CATALOG NO.	DESCRIPTION	UOM	ORDER MULTIPLE
QSSB48-12	Super Stand® Base Module, 12" High	EA	1
QSSB48-18	Super Stand® Base Module, 18" High	EA	1
QSSB48-24	Super Stand® Base Module, 24" High	EA	1
QSSX48-12	Super Stand® Extension Kit, 12" High	EA	1
QSSX48-18	Super Stand® Extension Kit, 18" High	EA	1
QSSX48-24	Super Stand® Extension Kit, 24" High	EA	1
QSSB62-12	Super Stand® Base Module, 12" High	EA	1
QSSB62-18	Super Stand® Base Module, 18" High	EA	1
QSSB62-24	Super Stand® Base Module, 24" High	EA	1
QSSX62-12	Super Stand® Extension Kit, 12" High	EA	1
QSSX62-18	Super Stand® Extension Kit, 18" High	EA	1
QSSX62-24	Super Stand® Extension Kit, 24" High	EA	1
QSSB74-12	Super Stand® Base Module, 12" High	EA	1
QSSB74-18	Super Stand® Base Module, 18" High	EA	1
QSSB74-24	Super Stand® Base Module, 24" High	EA	1
QSSX74-12	Super Stand® Extension Kit, 12" High	EA	1
QSSX74-18	Super Stand® Extension Kit, 18" High	EA	1
QSSX74-24	Super Stand® Extension Kit, 24" High	EA	1

MOUNTING ACCESSORIES

WeatherShield®

The Quick-Sling® WeatherShield™ protects outdoor ductless condensing units from weather damage. Quick-Sling® WeatherShield™ mounts directly to the mini-split and fits most sizes of equipment.



QSTD3000



CATALOG NO.	DESCRIPTION	UOM	ORDER MULTIPLE
QSWI1000	Quick-Sling® WeatherShield™ - 31.5 - 41.5 in. x 6 - 12 in.	EA	1

Wind Baffles

These front mounted wind baffles are specifically designed for the Mitsubishi P-Series and PUMY outdoor units allow equipment operation in low ambient temperature conditions.



QSBF-PA03

CATALOG NO.	DESCRIPTION	UOM	ORDER MULTIPLE
QSBF-PA03	Wind Baffles	EA	1
QSBF-PA04	Wind Baffles	EA	1
QSBF-PA05	Wind Baffles	EA	1

A/C Security Cages

These DiversiTech manufactured, weather-resistant, steel mesh guards offer a safe solution from theft, vandalism and accidental damage of your expensive air conditioning and air source heat pump. Ideal for all manufacturers of air conditioners and heat pumps.



CG-U-S

CATALOG NO.	DESCRIPTION	UOM	ORDER MULTIPLE
CG-U-S	A/C Security Cage - Small, 27 in. x 41 in. x 23.6 in.	EA	1
CG-U-M	A/C Security Cage - Med. 45 in. x 41 in. x 23.6 in.	EA	1
CG-U-L	A/C Security Cage - Large, 63 in. x 41 in. x 23.6 in.	EA	1

Roof Bracket

The Quick-Sling Roof Bracket mounts to QSWB3000 or the QSMS1200, 1201, 1202, 1800, 1801, 1802, 2400, 2401 and protects the equipment from snow and freezing rain.



QSRB1000

CATALOG NO.	DESCRIPTION	UOM	ORDER MULTIPLE
QSRB1000	Roof Bracket	EA	1

HANGING BRACKETS

Quick-Sling® - Air Handler Hanging Bracket

Our Quick-Sling is made of 14-gauge square tubing. This not only cuts down on vibration but allows the stand to hold up to 400 lbs. Extension arms individually adjust in one inch increments using thumb screws & wing nuts for speed & versatility. Installs as high as 24" or as low as 48" on flat or pitched roofs.



QSLG2000



CATALOG NO.	DESCRIPTION	UOM	ORDER MULTIPLE
QSLG2000	Sling Bracket Heavy Duty 2 Arm	EA	1

Quick Swivel "U" Mount - Unit Heater Bracket

Our Quick Swivel is made of 14-gauge steel able to hold 200 lbs. The swivel allows for 360° rotation for setting the perfect direction of air flow.



QSWI1000



CATALOG NO.	DESCRIPTION	UOM	ORDER MULTIPLE
QSWI1000	Swivel "U" Mount w/H-Bracket	EA	1
QSWI2000	Swivel "U" Mount w/I-Bracket	EA	1

Quick Swivel Flush Mount w/"H" Bracket - Unit Heater Bracket

Our Quick Swivel is made of 14-gauge steel able to hold 200 lbs. The swivel allows for 360° rotation for setting the perfect direction of air flow.



QSWI3000



CATALOG NO.	DESCRIPTION	UOM	ORDER MULTIPLE
QSWI3000	Swivel Flush H Bracket	EA	1
QSWI3001	Swivel Flush H Bracket 36" Spd	EA	1
QSWI3002	Swivel Flush H Bracket 17" Spd	EA	1
QSWI5003	Swivel Flush H Bracket Heavy Duty	EA	1

Quick Swivel Flush Mount w/"I" Bracket - Unit Heater Bracket

Our Quick Swivel is made of 14-gauge steel able to hold 200 lbs. The swivel allows for 360° rotation for setting the perfect direction of air flow.



QSWI4000



CATALOG NO.	DESCRIPTION	UOM	ORDER MULTIPLE
QSWI4000	Swivel Flush w/I Bracket	EA	1
QSWI5001	Swivel Flush w/34" I Bracket	EA	1
QSWI5002	Swivel Flush w/52" I Bracket	EA	1
QSWI6000	Swivel Flush w/2 I Brackets	EA	1

HANGING BRACKETS cont'd

Quick-Sling® Accessories - Steel & Wood Beam Adapters

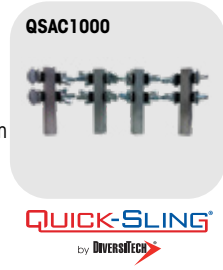

- The QSAC1000 (set of 4) & 1100 (set of 2) steel beam adapters are made out of aluminum & able to hold up to 250 lbs each.
- Each QSAC1000 is slotted to receive 3/8 threaded rod or C - clamps for easy mounting.
- The QSAC2000 (set of 4) & 2100 (set of 2) wood beam adapters are made of steel & are 12" long & 2" wide.
- Each of our adapters are able to hold up to 200 lbs.
- They have a 1.5" bend that simply clips over the wood joist. All the necessary hardware is provided.
- QSAC1000 and QSAC2000 adapts: QSLG1000 & QSLG2000
- QSAC1100 and QSAC2100 adapts: QSWI1000 & QSWI2000

CATALOG NO.	DESCRIPTION	UOM	ORDER MULTIPLE
QSAC1000	Adapters, Steel Pk of 4	EA	1
QSAC1100	Adapters, Steel Pk of 2	EA	1
QSAC2000	Adapters, Wood Pk of 4	EA	1
QSAC2100	Adapters, Wood Pk of 2	EA	1

STRUT CLIPS & CLAMPS

Rapid Positioning Clips

Rapid Positioning Clips fit directly into vertical and horizontal standard 1-5/8" strut channels. No tool required to install. Use for refrigeration, A/C tubing, PEX piping, and conduit support. They prevent cracked and fractured joints by allowing secured pipe to expand. The clips are UL2043 compliant and suitable for Plenum spaces. They are heat, light and U.V. stabilized for outdoor use. Available in 9 sizes to fit pipes with 1/4" to 1-5/8" outer diameter.



CATALOG NO.	TUBE O.D. (inch)	UOM	ORDER MULTIPLE
RPC-0014	1/4"	10 Pack	1
RPC-0038	3/8"	10 Pack	1
RPC-0012	1/2"	10 Pack	1
RPC-0058	5/8"	10 Pack	1
RPC-0034	3/4"	10 Pack	1
RPC-0078	7/8"	10 Pack	1
RPC-0118	1-1/8"	10 Pack	1
RPC-0138	1-3/8"	10 Pack	1
RPC-0158	1-5/8"	10 Pack	1

*Add "-100" to the end of part numbers for 100 pieces pack.

Studded Clips

Studded Clips fit directly onto 5/16" (M8) or 3/8" (M10) size threaded rods. No tool required to install. Use for refrigeration, A/C tubing, PEX piping, conduit, and cabling support. The clips are UL2043 compliant and suitable for Plenum spaces. They are heat, light and U.V. stabilized for outdoor use. Available in 11 sizes to fit pipes with 5/8" to 2-1/8" outer diameter.



CATALOG NO.	ROD SIZE	TUBE O.D. (inch)	UOM	ORDER MULTIPLE
SC08-15	5/16"	5/8"	10 Pack	1
SC08-20	5/16"	3/4"	10 Pack	1
SC08-22	5/16"	7/8"	10 Pack	1
SC08-25	5/16"	1"	10 Pack	1
SC08-28	5/16"	1-1/8"	10 Pack	1
SC08-32	5/16"	1-1/4"	10 Pack	1
SC08-35	5/16"	1-3/8"	10 Pack	1
SC08-40	5/16"	1-1/2"	10 Pack	1
SC08-42	5/16"	1-5/8"	10 Pack	1
SC08-50	5/16"	2"	10 Pack	1
SC08-54	5/16"	2-1/8"	10 Pack	1
SC10-15	3/8"	5/8"	10 Pack	1
SC10-20	3/8"	3/4"	10 Pack	1
SC10-22	3/8"	7/8"	10 Pack	1
SC10-25	3/8"	1"	10 Pack	1
SC10-28	3/8"	1-1/8"	10 Pack	1
SC10-32	3/8"	1-1/4"	10 Pack	1
SC10-35	3/8"	1-3/8"	10 Pack	1
SC10-40	3/8"	1-1/2"	10 Pack	1
SC10-42	3/8"	1-5/8"	10 Pack	1
SC10-50	3/8"	2"	10 Pack	1
SC10-54	3/8"	2-1/8"	10 Pack	1

*Add "-100" to the end of part numbers for 100 pieces pack.

STRUT CLIPS & CLAMPS cont'd

InsulClips

InsulClips fit directly into vertical and horizontal standard 1-5/8" strut channels. No tool required to install. Use for refrigeration, A/C tubing, PEX piping, conduit and cabling support. They are ideal for insulated pipes, to maintain vapor seal of the insulation and eliminates sweating. The clips are UL2043 compliant and suitable for Plenum spaces. They are heat, light and U.V. stabilized for outdoor use. Available in 11 sizes to fit pipes with 5/8" to 2-1/8" outer diameter.



CATALOG NO.	TUBE O.D. (inch)	UOM	ORDER MULTIPLE
IC00-15	5/8"	10 Pack	1
IC00-20	3/4"	10 Pack	1
IC00-22	7/8"	10 Pack	1
IC00-25	1"	10 Pack	1
IC00-28	1-1/8"	10 Pack	1
IC00-32	1-1/4"	10 Pack	1
IC00-35	1-3/8"	10 Pack	1
IC00-40	1-1/2"	10 Pack	1
IC00-42	1-5/8"	10 Pack	1
IC00-50	2"	10 Pack	1
IC00-54	2-1/8"	10 Pack	1

*Add "-100" to the end of part numbers for 100 pieces pack.

Flat Surface Adapter

The new Flat Surface Adapter is designed as a mounting base for RPC Clips, InsulClips, and Cable Tie Channel Clips. It easily screws onto any flat surface to provide a secure base for mounting. Made of a strong and lightweight polyamide (nylon) material.



- UL2043 compliant
- Includes slots for cable ties
- Fast and easy to install as a mounting base

CATALOG NO.	DESCRIPTION	UOM	ORDER MULTIPLE
RPC-FB	RPC Flat Surface Adapter	10 Pack	1
RPC-FB-100	RPC Flat Surface Adapter	10 Pack	1

Universal Strut Clamp

A highly versatile Universal Strut Clamp. Fits both pipe (rigid conduit)/IMC and thin walled tubing (EMT) in the corresponding sizes. Secures conduit to strut. Zinc Electro-Plate Finish.



CATALOG NO.	PINCH SIZE (inch)	O.D. (inch)	DESIGN LOAD (Lbs)	UOM	ORDER MULTIPLE
17532	1/2"	0.773"	400	EA	100
17533	3/4"	0.986"	600	EA	100
17534	1"	1.239"	600	EA	100
17535	1-1/4"	1.585"	600	EA	50
17536	1-1/2"	1.820"	800	EA	50
17537	2"	2.286"	800	EA	50

Cable Tie Channel Clips

Cable Tie Channel Clips fit directly into vertical and horizontal standard 1-5/8" strut channels. No tool required to install. Use for refrigeration, A/C tubing, PEX piping, conduit and cabling support. The clips are compliant with UL2043 and suitable for Plenum spaces. They are heat, light and U.V. stabilized for outdoor use. They accommodate PVC or metal cable ties up to a width of 11/16" (17mm). Three support base lengths available in 2" (50mm), 2-1/2" (65mm) and 3" (80mm).



CATALOG NO.	LENGTH	UOM	ORDER MULTIPLE
CTC-050	2"	10 Pack	1
CTC-065	2-1/2"	10 Pack	1
CTC-080	3"	10 Pack	1

*Add "-100" to the end of part numbers for 100 pieces pack.

Rigid Strut Clamp

Extra durable Zinc Electroplate Finished Strut Clamps to secure rigid and IMC conduits and pipes to struts. The Clamps with 2-1/2" through 8" diameter are suitable for rigid and EMT conduits.



CATALOG NO.	PINCH SIZE (inch)	O.D. (inch)	DESIGN LOAD (Lbs)	UOM	ORDER MULTIPLE
17515	3/4"	1.050"	600	EA	100
17516	1"	1.315"	600	EA	100
17518	1-1/2"	1.900"	800	EA	50
17519	2"	2.375"	800	EA	50
17520	2-1/2"	2.875"	800	EA	50
17521	3"	3.500"	800	EA	25
17522	3-1/2"	4.000"	1000	EA	25
17523	4"	4.500"	1000	EA	25

Cushion Clamps

An industry standard universal clamp that mounts to standard strut. Steel with electrochromate finish to resist corrosion. The lock nut has a nylon insert for a positive lock. The polymeric grommet withstands temperatures from -25°C to 125°C and resists the effects of most oils, chemicals, and industrial cleaning compounds.



CATALOG NO.	DESCRIPTION	UOM	ORDER MULTIPLE
538-1/4	Clamp Cushion - 1/4"	EA	25
538-3/8	Clamp Cushion - 3/8"	EA	25
538-1/2	Clamp Cushion - 1/2"	EA	25
538-5/8	Clamp Cushion - 5/8"	EA	25
538-3/4	Clamp Cushion - 3/4"	EA	25
538-7/8	Clamp Cushion - 7/8"	EA	25
538-1-1/8	Clamp Cushion - 1-1/8"	EA	10
538-1-3/8	Clamp Cushion - 1-3/8"	EA	10
538-1-5/8	Clamp Cushion - 1-5/8"	EA	10
538-2-1/8	Clamp Cushion - 2-1/8"	EA	10
538-2-5/8	Clamp Cushion - 2-5/8"	EA	10
538-3-1/8	Clamp Cushion - 3-1/8"	EA	10
538-4-1/8	Clamp Cushion - 4-1/8"	EA	10

STRUT CLIPS & CLAMPS cont'd

EMT Strut Clamp

Zinc Electroplate Finished Strut Clamps to secure EMT conduits and pipes to struts.



CATALOG NO.	PINCH SIZE (inch)	O.D. (inch)	DESIGN LOAD (Lbs)	UOM	ORDER MULTIPLE
17542	1/2"	0.706"	400	EA	100
17543	3/4"	0.922"	400	EA	100
17544	1"	1.163"	600	EA	100
17545	1-1/4"	1.510"	600	EA	50
17546	1-1/2"	1.740"	800	EA	50
17547	2"	2.197"	800	EA	50

STRUT AND THREADED ROD ACCESSORIES

H-Frame Kits

Ideal for supporting ducts, pipes and electrical equipment. Kits include a pair of feet, brackets and hardware. 12.6" or 19.7" square feet available.



CATALOG NO.	DESCRIPTION	UOM	ORDER MULTIPLE
F-HF-320	H-Frame Kit - 12.5" foot	EA	100
F-HF-500	H-Frame Kit - 19.7" foot	EA	100

Channel Nuts

Spring Channel Nuts to attach a threaded rod to a strut. They are available with short springs for 13/16" & 1" channels and with regular springs for 1-3/8" & 1-5/8" channels. Zinc Electroplate finished.



CATALOG NO.	DESCRIPTION	THREAD	THICKNESS	UOM	ORDER MULTIPLE
17412	Channel Nut-Short Spring	1/4" - 20"	.25"	EA	100
17420	Channel Nut-Short Spring	3/8" - 16"	.37"	EA	100
17430	Channel Nut-Regular Spring	1/4" - 20"	.25"	EA	100
17438	Channel Nut-Regular Spring	3/8" - 16"	.37"	EA	100
17442	Channel Nut-Regular Spring	1/2" - 13"	.50"	EA	100

Strut to Beam Clamps

These clamps connect a beam to a strut installation. They are designed for a load up to 1200 lbs. when used in pairs. Zinc Electroplate Finish.



CATALOG NO.	DESCRIPTION	UOM	ORDER MULTIPLE
17462	Beam Clamp for 13/16" & 1-5/8" Channel	EA	25
17464	Beam Clamp for 2-7/16" & 3-1/4" Channel	EA	25

Channel Post Base for 1-5/8" Strut Channels

A Post Base secures a strut assembly to the floor or other surfaces. These Post Bases are made of galvanized steel and are available as 2 and 4 hole, heavy-duty, mounting option.



CATALOG NO.	DESCRIPTION	SIZE	UOM	ORDER MULTIPLE
17450	Post Base 2 Hole	4" x 6"	EA	5
17452	Post Base 4 Hole, Corner Orientation	6" x 6"	EA	5
17454	Post Base 4 Hole, Side Orientation	6" x 6"	EA	5

Connection Plates for 1-5/8" Strut Channels

Connection Plates are used to connect strut channels to each other. Splice plates allow to make extensions by connecting several channels while corner and angle plates make 90° connections. All plates are manufactured of steel with Zinc Electroplate finish, are 1/4" thick, and designed to be used with 1-5/8" strut channels.



CATALOG NO.	DESCRIPTION	UOM	ORDER MULTIPLE
17616	Square Washer 3/8"	EA	100
17618	Square Washer 1/2"	EA	100
17626	4 Hole Splice Plate	EA	25
17628	2 Hole Corner Angle	EA	50
17630	2 Hole Cross Corner Angle	EA	50
17632	3 Hole Corner Plate	EA	25
17633	3 Hole Cross Corner Angle	EA	50
17634	4 Hole 3 Way Corner Angle	EA	25
17636	4 Hole Tee Plate	EA	20
17638	2 Hole Open 45° Corner Angle	EA	25

Plastic White End Caps

Plastic White End Caps are used to cover the ends of a strut channel. Made of soft PVC material they provide a safe, smooth capping.



CATALOG NO.	DESCRIPTION	UOM	ORDER MULTIPLE
17682	Plastic White End Caps for 1 3/16" Channel	EA	100
17684	Plastic White End Caps for 1 5/8" Channel	EA	100

SPRING FITTINGS & BEAM CLAMPS

Beam Clamps

This fast-installing Beam Clamp fits beam flanges up to 1/2". It can be used with 1/4" and 3/8" threaded rod, "S" hooks, conduit hangers, electrical boxes, and #10-24 or 1/4"-20 bridle rings.



CATALOG NO.	DESCRIPTION	UOM	ORDER MULTIPLE
18016	Beam Clamp	EA	100

Flange Mount Conduit Assembly - Bottom Mount

The Assembly suspends a conduit from the bottom of a beam with a Posi-Lock mechanism. It installs with a hammer only and can pivot 360°. The rated static load limit is 75 lbs.



CATALOG NO.	DESCRIPTION	FLANGE THICKNESS	FITS CONDUIT	UOM	ORDER MULTIPLE
18200	Flange Mount Conduit Assembly - Bottom Mount - Posi-Lock	1/8"-1/4"	3/8"	EA	100
18050	Flange Mount Conduit Assembly - Bottom Mount - Posi-Lock	1/8"-1/4"	1/2" - 3/4"	EA	100
18202	Flange Mount Conduit Assembly - Bottom Mount - Posi-Lock	1/8"-1/4"	1	EA	100

Z Purlin Hanger

Z Purlin Angled Flange Hangers are used to attach threaded rod or hooks and straps to an angled Z purlin. The Hangers are holding up to 100 lbs.



CATALOG NO.	DESCRIPTION	FOR USE WITH	UOM	ORDER MULTIPLE
18180	Z Purlin Flange Hanger	Flange from 1/16" to 1/4"	EA	100
18160	Z Purlin Rod Hanger Assembly	1/4" Threaded Rod	EA	100
18161	Z Purlin Rod Hanger Assembly	3/8" Threaded Rod	EA	100

Spring Steel Beam Clamps

Spring Steel Clamps allow to suspend boxes, fixtures and bridle rings to 1/8" through 3/4" beam flanges.



CATALOG NO.	DESCRIPTION	FLANGE THICKNESS	STATIC LOAD	UOM	ORDER MULTIPLE
18123	Spring Steel Beam Clamps 1/4"-20 x 3/8" Stud	1/8" to 1/4"	75Lbs	EA	100
18124	Spring Steel Beam Clamps 1/4"-20 x 3/8" Stud	5/16" to 1/2"	75Lbs	EA	100
18018	Spring Steel Beam Clamps Universal	1/8" to 1/4"	200Lbs	EA	100

Flange Mount Conduit Assembly - Side Mount

The Assembly suspends a conduit from the side of a beam with a Posi-Lock mechanism. It installs with a hammer only and can pivot 360°. The rated static load limit is 25 lbs.



CATALOG NO.	DESCRIPTION	FLANGE THICKNESS	FITS CONDUIT	UOM	ORDER MULTIPLE
18231	Flange Mount Conduit Assembly - Side Mount - Posi-Lock	1/8"-1/4"	1/2" - 3/4"	EA	100
18232	Flange Mount Conduit Assembly - Side Mount - Posi-Lock	1/8"-1/4"	1"	EA	100
18240	Flange Mount Conduit Assembly - Side Mount - Posi-Lock	5/16"-1/2"	1/2" - 3/4"	EA	100

Spring Steel Cable Clip

The Cable Clip for MC, AC, or BX support 14-2, 14-3 & 12-2 cables in horizontal or vertical position. NOTE: The product is designed for positioning only, with no load rating.

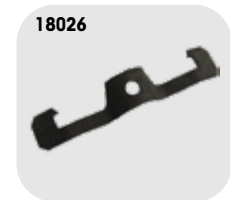

CATALOG NO.	DESCRIPTION	FOR USE WITH	UOM	ORDER MULTIPLE
18026	Spring Steel Cable Clips	OD's from .433 to .535	EA	100

SPRING FITTINGS & BEAM CLAMPS cont'd

Beam Clamp to Conduit Hanger Assembly

The Spring Steel Beam Clamp with a Pre-Installed Posi-Lock conduit hanger is available for bottom and side mount of conduits. The rated static load is 100 lbs. for the vertical, and 25 lbs. for the horizontal installation.



CATALOG NO.	DESCRIPTION	FITS CONDUITS	UOM	ORDER MULTIPLE
18130	Bottom Mount	1/2"-3/4"	EA	100
18140	Side Mount	1/2"-3/4"	EA	100

HOOKS, SPRINGS AND FIXTURE SUPPORT

Bridle Rings

Zinc-Plated Bridle Rings are a good support for communication cables & other low voltage uses. They are available as Bolt-On, commonly used with Beam Clamps, and as Screw-In, commonly used with Wooden Beams. The Cable Support Bridle Rings with saddle are a cost-effective alternative to expensive cable tray. Their wide surface saddle provides support without stress for Category 5, fiber-optic, and other sensitive voice/Datacom cables.



CATALOG NO.	DESCRIPTION	RING DIAMETER	THREAD	UOM	ORDER MULTIPLE
18421	Bridle Rings - Bolt-On	1/4" - 20"	1/4" -20	EA	100
18422	Bridle Rings - Bolt-On	2"	1/4" -20	EA	100
18425	Bridle Rings - Screw-On	1"	3/16"	EA	100
18426	Bridle Rings - Screw-On	1-1/2"	1/4"	EA	100
18427	Bridle Rings - Screw-On	2"	1/4"	EA	100
18058	Bridle Rings - Bolt-On with Saddle	2"	1/4"-20	EA	50
18060	Bridle Rings - Bolt-On with Saddle	4"	1/4"-20	EA	50

Box Stabilizer Support

This Stabilizer for electrical boxes is made of pre-galvanized steel. The box support is designed to be screwed to 2-1/2", 3-1/2" & 4" wood or metal studs.



CATALOG NO.	STUD SIZE	UOM	ORDER MULTIPLE
18370	2-1/2", 3-1/2"	EA	100
18052	2-1/2", 3-1/2", 4"	EA	100

J-Hooks

2" J Hooks for Datacom applications are a cost-effective alternative to expensive cable tray. Their wide base provides support without stress for Cat5, fiber-optic and other sensitive voice/Datacom cables. The continuous wide base radius supports the natural curve of cables and ensures eliminating kinks & bending. A cable wire retainer is supplied with every part. Its unique design eliminates the need for an attachment plate when stacked. These J-Hooks can be attached to a wide variety of structures using beam clamps, clips and many other components.



CATALOG NO.	DESCRIPTION	UOM	ORDER MULTIPLE
18056	J Hooks - 2", Screw Mount	EA	25

Box To T-Bar Fastener

A Snap-On 24" span box hanger with dual height adjustment that allows flush or 3/4" offset mounting of boxes. It is produced of pre-galvanized steel with spring steel hardware and has 1 BBC mounting clip with screw included.



CATALOG NO.	DESCRIPTION	UOM	ORDER MULTIPLE
18054	24" Span Box to T-Bar Fastener	EA	100

T-Bar Scissor Clips

This 2-piece T-Bar Scissor Clip mounts fixtures or boxes to a 1" T-bar. Includes a wing nut washer. Static Load Limit of 100 lbs.



CATALOG NO.	DESCRIPTION	UOM	ORDER MULTIPLE
18387	24" Span Box to T-Bar Fastener	EA	50

MOUNTING STRAPS

2 Hole PVC Pipe Straps

Designed to accommodate Schedule 40 PVC Conduit. The Heavy-Duty Polythene material resists deterioration from UV rays and breakage from extreme cold.



CATALOG NO.	TRADE SIZE	UOM	ORDER MULTIPLE
19490	1/2"	EA	100
19492	3/4"	EA	100
19494	1"	EA	100
19496	1-1/4"	EA	50
19498	1-1/2"	EA	50
19500	2"	EA	50
19501	2-1/2"	EA	25
19502	3"	EA	25
19503	4"	EA	25

1 Hole EMT Pipe Straps - Steel

Zinc Plated Steel Pipe Straps with a reinforced hole and rib for extra strength to secure EMT conduits. Easy Snap-On installation.



CATALOG NO.	TRADE SIZE	UOM	ORDER MULTIPLE
19400	1/2"	EA	100
19401	3/4"	EA	100
19402	1"	EA	100

2 Hole Rigid Pipe Straps - Steel

The 2 Hole Rigid Zinc Plated Steel Pipe Straps with reinforced holes and rib for extra strength are used to secure Rigid & IMC conduit. Easy Snap-On installation.



CATALOG NO.	TRADE SIZE	UOM	ORDER MULTIPLE
19436	1/2"	EA	X
19437	3/4"	EA	X
19438	1"	EA	25
19439	1-1/4"	EA	20
19440	1-1/2"	EA	10
19441	2"	EA	5
19443	3"	EA	1
19444	4"	EA	1
19445	5"	EA	1
19446	6"	EA	1

BX 1 Hole Strap

These one-hole pipe straps are ideal for hanging tubing, pipe, conduit and BX cable. They are made of pre-galvanized zinc plated steel with a reinforced rib for extra strength.



CATALOG NO.	CABLE SIZE	UOM	ORDER MULTIPLE
19463	BX: 14 - 2 Thru 10 - 3	EA	100

1 Hole Rigid Pipe Straps - Heavy Duty - Steel

The 1 Hole Rigid Pipe Strap is made of zinc plated steel with a reinforced hole and rib for heavy duty applications. It can be easily Snap-On installed and is used to secure Rigid & IMC conduit.



CATALOG NO.	TRADE SIZE	UOM	ORDER MULTIPLE
19426	1"	EA	25



RAPID POSITIONING CLIPS

The RPC line of mounting clips are cost-effective and time-saving solutions for refrigeration, A/C tubing, PEX piping, conduits and cabling support. Their unique, simple and effective one-piece design requires no tools and they are 20 times faster to install when compared to the traditional mounting clamps.



All RPC clips are made from durable polyamide material and have a wide working temperature range from -40°F to 284°F (-40°C to 140°C). They meet the UL2043 requirement for plenum rating and have the UL94 HB flame rating, suitable for use in air handling spaces.



AIR MOVEMENT

Dryer Duct, Vent Hose, Hose Clamps	23-24
Duct Strap, Ties, Clamps	24-25
Pure-Beam™ Ultraviolet Light	23
Tapes	25-26
Ventilation Products.....	22



VENTILATION PRODUCTS

Duct Fans

Features electrical junction box for UL and code compliant electrical connection. An efficient way to increase air circulation, keep room temperatures consistent, and lower heating and cooling costs. Metal construction, powerful no-maintenance motors and a one-use thermal fuse mean these fans will be up to the task for years. Straight forward installation into any 120V system with detailed instructions, templates, and diagrams. Available in many sizes. A great way to give slow vents a boost. Conforms to UL STD 507, Certified to CSA STD C22.2 #113

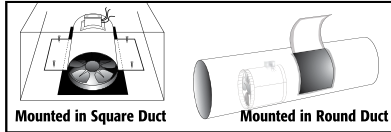

CATALOG NO.	DESCRIPTION	UOM	ORDER MULTIPLE
625-AF6	Duct Fan 6" dia., 240 CFM, 37W	EA	4
625-AF8	Duct Fan 8" dia., 420 CFM, 37W	EA	4
625-AF10	Duct Fan 10" dia., 650 CFM, 35W	EA	4
625-AF12	Duct Fan 12" dia., 975 CFM, 65W	EA	2
625-AF14	Duct Fan 14" dia., 1350 CFM, 65W	EA	1

No-Caulk Roof Flashing

These No-Caulk Roof Flashings provide a watertight seal for vent pipes. They are available for all common pipe sizes with either a galvanized steel or thermoplastic base. Easy to install. Slides over pipe for pitch to 40° - 45. Made either of rust-proof, stamped 28 gauge galvanized steel or non-fading, non-cracking rigid black thermoplastic. Non-fading sealing collar. Approved for Type B installations. Do not use paint or petroleum-based products on plastic bases or rubber collar.



Oatey

CATALOG NO.	DESCRIPTION	UOM	ORDER MULTIPLE
5-11830	Roof Flashing - 1/2" - 3/4" - 1"	EA	12
5-11840	Roof Flashing - 1-1/4" - 1-1/2"	EA	12
5-11853	Roof Flashing - 2"	EA	12
5-11866	Roof Flashing - 3"	EA	12
5-11879	Roof Flashing - 4"	EA	12
530-11908	Roof Flashing, Thermoplastic, 1-1/4" - 1-1/2"	EA	12
530-11909	Roof Flashing, Thermoplastic, 2"	EA	12
530-11910	Roof Flashing, Thermoplastic, 3"	EA	12
530-11911	Roof Flashing, Thermoplastic, 4"	EA	12
530-11919	Roof Flashing, Thermoplastic, 1-1/2" - 3"	EA	12

Roof Louver

Unique interior louver design, eliminating the need for a screen. The square hood has been designed for maximum air movement. Large nailing flange for easy installation. U.L. Listed.



LEXLE LOCKE

CATALOG NO.	DESCRIPTION	UOM	ORDER MULTIPLE
6-R50A	Roof Louver - Aluminum	EA	10

Flue Caps

PVC Flue Caps are an affordable way to protect today's high efficiency furnaces from dirt, moisture and other debris.

- Protection for high efficiency furnaces
- Universal flue cap fits 1.5", 2" and 3" PVC pipe
- Reduces draft inducer motor rust
- Helps to eliminate pressure switch service calls
- Resistant to UV radiation and oxidative degradation
- CSA approved for use in 90% AFUE heating applications



CATALOG NO.	DESCRIPTION	UOM	ORDER MULTIPLE
EC-1	E cap Flue Cap	EA	12

Smokeys

Smoke emitter cartridges provide effective, low cost leak testing of heat exchangers, air ducts, tanks and boilers. Visual air balancing of HVAC systems. Cartridges produce clean, non toxic, oil free smoke through chemical reaction. Use also for fire drills as well as the placement and testing of smoke alarms/ detectors.



CATALOG NO.	DESCRIPTION	UOM	ORDER MULTIPLE
14145	45 second burn time, 150 cu. ft., pack of 10	PK	1
14175	75 second burn time, 600 cu. ft., pack of 10	PK	1
14250	2-1/2 minute burn time, 1,100 cu. ft., pack of 5	PK	1
14340	4 minute burn time, 2,500 cu. ft., pack of 5	PK	1

Versa Cap® Flue and Hot Stack Caps

Non clogging positive draft design, recommended for flue or hot stack installation. Clamp fitting adjustable for all standard sizes. Aluminum model. U.L. Listed.



LEXLE LOCKE

CATALOG NO.	PIPE O.D.	DOUBLE WALL	SINGLE WALL	J-M TRANS. SITE	HEIGHT/OVERALL DIAMETER	UOM	ORDER MULTIPLE
6-3050	2-7/8"-5"	3 and 4	3 and 4	3 and 4	4-1/2" x 6-5/8"	EA	12
6-5070	4-7/8"-7"	5 and 6	5 and 6	5 and 6	4-3/4" x 9-1/2"	EA	12
6-7090	6-7/8"-9"	7 and 8	7 and 8	7 and 8	5-7/8" x 11-5/8"	EA	12
6-9011	8-7/8"-11"	9 and 10	9 and 10	9 and 10	6-1/2" x 12-3/4"	EA	6
6-1200	11-7/8"-14-1/2"	12	12 and 14	12	8-11/16" x 17-9/16"	EA	2

Egg Crate Louvers - Air Return Diffusers

White polystyrene 1/2 in. open cell grid louvers are beneficial for air return.

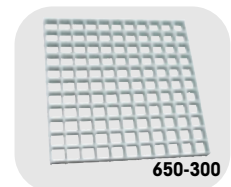

CATALOG NO.	DESCRIPTION	UOM	ORDER MULTIPLE
650-300	Egg Crate Louvers - 2' x 2' x 1/2"	EA	20
650-200	Egg Crate Louvers - 2' x 4' x 3/8"	EA	15
650-100	Egg Crate Louvers - 2' x 4' x 1/2"	EA	10

PURE-BEAM™ ULTRAVIOLET LIGHT

Pure-Beam™ Ultraviolet Light

Pure Beam™ ultraviolet light is designed for HVAC air disinfection and surface irradiation. The 17 watt UV C lamp is a powerful tool for improved indoor air quality. Installs in the HVAC system or ductwork on either the return or supply air side of the furnace or air handler. DiversiTech's Pure Beam™ ultraviolet light provides a healthier environment in your home, thanks to the germicidal qualities of the UV light spectrum present in the Pure Beam™ light. Ultraviolet light deactivates the DNA of dust mites, bacteria, viruses and other pathogens and destroys their ability to multiply and cause disease. Placement of a Pure Beam™ light in an airstream or near a drain pan can help to decrease the air contamination of any home. Exposure to Pure Beam™ significantly reduces air contamination caused by fungus, mold, and viruses and can cleanse surfaces overcome by mold and slime. Overall size is 14 in. L x 2 in. W x 2 in. H for easy placement. Includes the UV lamp, a UL listed ceramic base, and mounting bracket.



UV-1

CATALOG NO.	DESCRIPTION	UOM	ORDER MULTIPLE
UV-1	Ultraviolet Light with 24 VAC elec. ballast	EA	1
UV-BULB	Replacement Bulb – 24V	EA	1

DRYER DUCT, VENT HOSE, HOSE CLAMPS

Aluminum Dryer Vent Hoods, Kits, and Fittings

Aluminum vent hood with flange plate.



650-001

CATALOG NO.	DESCRIPTION	UOM	ORDER MULTIPLE
650-001	4" Aluminum Hood	EA	24
650-002	3" Aluminum Hood	EA	24
650-003	4" Hood / 8' Tubing	EA	24
650-038	4" Aluminum Wide Mouth	EA	10

Plastic Wide Mouth Dryer Vent Hood

Hood, aluminum pipe and collar.

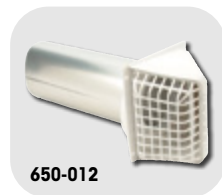

650-012

CATALOG NO.	DESCRIPTION	UOM	ORDER MULTIPLE
650-031	3" White Hood – Assembled	EA	12
650-012	4" White Hood – Assembled	EA	12
650-013	4" White Hood – Unassembled	EA	18
650-023	4" Brown Hood – Assembled	EA	12

Louvered Dryer Vent Hood

Louvered vent hoods are available with aluminum pipe and collar or hood only. Ideal for dryer and bathroom fan exhausts.



650-014

CATALOG NO.	DESCRIPTION	UOM	ORDER MULTIPLE
650-014	4" Hood Only – White	EA	12
650-016	4" Hood, Pipe and Collar – White (Assembled)	EA	12
650-017	4" Hood, Pipe and Collar – White (Unassembled)	EA	18
650-036	3" Hood, Pipe and Collar – White (Assembled)	EA	12

Dryer Vent Hose

High quality flexible white vinyl tubing. Available in 3in. or 4in. diameters. One 50ft roll per box.



650-005

CATALOG NO.	DESCRIPTION	UOM	ORDER MULTIPLE
650-005	Dryer Vent Hose – 3" x 50'	EA	1
650-006	Dryer Vent Hose – 4" x 50'	EA	1

Semi-Rigid Aluminum Duct

8ft. length compressed to 28in.



650-011

CATALOG NO.	DESCRIPTION	UOM	ORDER MULTIPLE
650-011	4" x 8' Flexible Aluminum Duct	EA	9
650-021	3" x 8' Flexible Aluminum Duct	EA	14
650-074	6" x 8' Flexible Aluminum Duct	EA	3

Metallic Duct – 5 Ply

Pure aluminum 5 ply multi layered flexible metallic duct. U.L. 181 Listed. Will contain a fire up to 265°F.



FUL0425

CATALOG NO.	DESCRIPTION	UOM	ORDER MULTIPLE
FUL0425	4" x 25' 5 Ply Metallic Duct	EA	4
FUL0625	6" x 25' 5 Ply Metallic Duct	EA	4

Dryer Hose Clamps

Available for 3 in. or 4in. dryer vent hose. Steel screw design or convenient spring action design.



650-008

650-010

CATALOG NO.	DESCRIPTION	UOM	ORDER MULTIPLE
650-008	Steel Screw Clamp for 4" Hose	EA	50
650-010	Spring Clamp for 4" Hose	EA	500

DRYER DUCT, VENT HOSE, HOSE CLAMPS cont'd

Periscope Connection Kit

For tight space duct venting. Contains one male snap lock fitting and one draw band with clamp. Adjustable 17in. to 28in..



CATALOG NO.	DESCRIPTION	UOM	ORDER MULTIPLE
650-020	4" Periscope Kit	EA	9

Metallic Duct – 2 Ply

2 ply metallic duct — aluminum outside, polyester inside. Ideal for bath fan ducting and all purpose venting.



CATALOG NO.	DESCRIPTION	UOM	ORDER MULTIPLE
FM0450	4" x 50' 2 Ply Metallic Duct	EA	1

DUCT STRAP, TIES, CLAMPS

Heavy Duty Cable Ties

6.6 nylon, the heavy duty duct straps feature smooth insertion, and a locking mechanism that gives ductwork a firm hold. Accommodates 7 to 15 inch duct. Tensioning tool for 32 in. plus allows operator to adjust strap to any desired tension.



CATALOG NO.	DESCRIPTION	UOM	ORDER MULTIPLE
7-P24	24" Long – Fits up to 6" Duct – 175 lb. Tensile	EA	50
7-P36	36" Long – Fits up to 10" Duct – 175 lb. Tensile	EA	50
7-P36B	36" Long – Black – Fits up to 10" Duct – 175 lb. Tensile	EA	50
7-P48	48" Long – Fits up to 14" Duct – 175 lb. Tensile	EA	50
7-P48B	48" Long – Black – Fits up to 14" Duct – 175 lb. Tensile	EA	25
7-L300	Tensioning Tool for 120-175 lb. Ties	EA	1

Hanging Wire

The 18 gauge galvanized can be used to hang HVAC duct work.



CATALOG NO.	DESCRIPTION	UOM	ORDER MULTIPLE
710-182G	2# Roll – 330' – 18 Gauge Galvanized	EA	8
710-185G	5# Roll – 830' – 18 Gauge Galvanized	EA	8

Plastic Hanger Strap

Flexible, non-conductive. 3/4 in. wide x .050 in. thick. Load tested to 120 lbs.



CATALOG NO.	DESCRIPTION	UOM	ORDER MULTIPLE
710-P100	3/4" x 100' Roll	EA	20

Strapping Hanger Iron

Galvanized 3/4 in. vent strapping, hanger iron, plumber's tape, pipe hanger tape and many other uses. 1/4 in. centers for bolts or nails.



CATALOG NO.	DESCRIPTION	UOM	ORDER MULTIPLE
710-A1710	Hanger Iron (Galv.) – 10' Rolls – 28 Gauge	EA	50
710-A1650	Hanger Iron (Galv.) – 50' Rolls – 28 Gauge	EA	10
710-A16100	Hanger Iron (Galv.) – 100' Rolls – 28 Gauge	EA	6

Duct Strap – Metallic – Roll

Galvanized duct strap in a convenient cardboard dispenser is not only easy to drill or nail, but also solid strapping. Plenum rated.



CATALOG NO.	DESCRIPTION	UOM	ORDER MULTIPLE
710-001	Metallic Duct Strap – 26 Gauge – 1" x 100'	EA	1
710-002	Metallic Duct Strap – 30 Gauge – 1" x 100'	EA	1
710-003	Metallic Duct Strap – 30 Gauge – 1-1/2" x 100'	EA	1
710-004	Metallic Duct Strap – 26 Gauge – 1-1/2" x 100'	EA	1
710-005	Metallic Duct Strap – 22 Gauge – 1" x 100'	EA	1

Plenum Duct Strap – UL Rated

Woven Polypropylene Hanging Straps meet the UL 2043 requirement and are suitable for use in air handling spaces. They have a high tensile strength of 400 lbs minimum and 460 lbs maximum. These straps are resistant to both abrasion and chemicals. They are easy to cut and staple to joists.



- Plenum rated, meets UL 2043 requirement
- High tensile strength
- Resistant to abrasion and chemicals
- Lightweight & easy to cut and staple

CATALOG NO.	DESCRIPTION	UOM	ORDER MULTIPLE
710-104	Plenum Duct Strap, Woven, 1-3/4" x 100 Yards – Black UL	EA	24
710-105	Plenum Duct Strap, Woven, 1-3/4" x 100 Yards – Silver UL	EA	24
710-106	Plenum Duct Strap, Woven, 3" x 100 Yards – Black UL	EA	8

DUCT STRAP, TIES, CLAMPS cont'd

Duct Strap – Woven Polypropylene

Webbed duct strap possessing high tensile and abrasion resistance. This can be used for flex duct as it is easy to cut and staple to joists. The product is chemical resistant and tested to meet UL Standard 2043. 710-104 through 710-106 are UL rated.



CATALOG NO.	DESCRIPTION	UOM	ORDER MULTIPLE
710-100	Duct Strap – 1-3/4" x 100 Yards – Black	EA	24
710-101	Duct Strap – 1-3/4" x 100 Yards – Silver	EA	24
710-102	Duct Strap – 3" x 100 Yards – Black	EA	8
710-103	Duct Strap – 3" x 100 Yards – Silver	EA	8

TAPES

Stick-E-Tape

Self adhesive aluminum tape with temperature range of 40 degree F to 200 degree F. Easily painted. Excellent vapor barrier; effective UV and water shield over urethane foam. Preferred duct and pipe wrap.



CATALOG NO.	DESCRIPTION	UOM	ORDER MULTIPLE
50302	Stick-E-Tape – AFT-701-2 – 2" x 50' Roll	EA	24

Aluminum Foil Tape

Prevents heating and cooling losses. Blocks odors and moisture. Easy to handle. Use for HVAC and refrigeration systems. 35 degree F to plus 260 degree F working temperatures. 3-5 year shelf life. Made in USA.

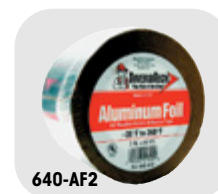

CATALOG NO.	DESCRIPTION	UOM	ORDER MULTIPLE
640-AF2	2" Aluminum Foil Tape – 50 yds.	EA	24
640-AF25	2-1/2" Aluminum Foil Tape – 50 yds.	EA	20
640-AF3	3" Aluminum Foil Tape – 50 yds.	EA	16

Flex Duct Tape

Specially designed to meet new UL181B FX code for flex duct. Higher adhesion and tack than traditional cloth duct tapes. Conformable, hand tearable foil; 3 mil thickness. 2 in. x 120 yds. Code identification printed on the tape. Acrylic adhesive for superior performance in extreme environments. (35°F to 260°F)



CATALOG NO.	DESCRIPTION	UOM	ORDER MULTIPLE
640-FD2S	Flex Duct Tape – Silver – 2"	EA	24
640-FD2B	Flex Duct Tape – Black – 2"	EA	24
640-FD3S	Flex Duct Tape – Silver – 3"	EA	16

Foil Scrim Kraft Tape

Non tearable, diamond patterned backing with an aggressive rubber based adhesive system for consistently dependable performance. Made in the USA.



CATALOG NO.	DESCRIPTION	UOM	ORDER MULTIPLE
640-FSK2	Foil Scrim Kraft Tape – 2" – 50 Yards	EA	24
640-FSK3	Foil Scrim Kraft Tape – 3" – 50 Yards	EA	16

TAPES cont'd

UL Listed Foil Tape

Unique acrylic adhesive for airtight bonds on joints and seams of fiberglass duct systems. Flexible, easy to use. Meets or exceeds performance standard AFLS 100 73 and UL 181 A.P.



CATALOG NO.	DESCRIPTION	UOM	ORDER MULTIPLE
640-UL25	UL 181 Listed Foil Tape – 2-1/2" – 60 Yards	EA	16
640-UL3	UL 181 Listed Foil Tape – 3" – 60 Yards	EA	16

Cloth Duct Tapes

High tack, excellent strength. Superior performance in sealing air handling systems. Heavy cloth content for easier tearing and additional strength. Made in the USA.



CATALOG NO.	DESCRIPTION	UOM	ORDER MULTIPLE
PC-622-S	2" x 60 Yards – Premium Grade Duct Tape – Silver	EA	24
PC-622-B	2" x 60 Yards – Premium Grade Duct Tape – Black	EA	24
PC-609-S	2" x 60 Yards – Industrial Grade Duct Tape – Silver	EA	24
PC-609-B	2" x 60 Yards – Industrial Grade Duct Tape – Black	EA	24
PC-600-S	2" x 60 Yards – Contractor Grade Duct Tape – Silver	EA	24
PC-600-B	2" x 60 Yards – Contractor Grade Duct Tape – Black	EA	24
PC-857	2" x 60 Yards – Metallized UL181B-FX Flex Duct Tape	EA	24

HEATING PRODUCTS

Black Steel Welded Nipples.....	32
Carbon Monoxide & Smoke Alarms.....	31
DiversiTech Gas Connectors.....	30
Dormont Gas Connectors and Valves.....	31
Heating Equipment Service Products.....	28
Malleable Black Iron Pipe Fittings.....	32-33
Tankless Water Heater Connection Kits.....	30
Tape.....	34
TrueStart® Hot Surface Igniters.....	28
TrueStart® Ignition Accessories.....	29
Vent Termination Kits.....	29



TRUESTART® HOT SURFACE IGNITERS

Wolverine® Universal Hot Surface Igniter

Wolverine® hot surface igniters feature protective, dynamic, and informative packaging. Wolverine® hot surface igniters are 100% tested and completely reliable. They are compatible with all OEM furnaces. Universal hot surface igniters allow a contractor to reduce truck stock and replace hundreds of OEM igniters with just one SKU.

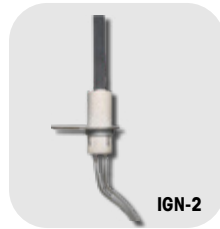

CATALOG NO.	DESCRIPTION	UOM	ORDER MULTIPLE
IGN-2	Wolverine® Hot Surface Igniter by TrueStart®, Universal, Silicon Nitride	EA	6
IGN-2-6P	Wolverine® Hot Surface Igniter by TrueStart®, Universal, Silicon Nitride – Contractor Pack, pack of 6	PK	1

Universal Silicon Carbide Igniters

TrueStart® hot surface igniters feature protective, dynamic, and informative packaging. TrueStart™ hot surface igniters are 100% tested and completely reliable. They are compatible with all OEM furnaces. TrueStart® hot surface igniters are available as a universal silicon carbide igniter.



CATALOG NO.	DESCRIPTION	UOM	ORDER MULTIPLE
IGN-001	TrueStart® Hot Surface Igniter, Universal, Silicon Carbide	EA	6

Direct Replacement Igniters

TrueStart® hot surface igniters feature protective, dynamic, and informative packaging. TrueStart® hot surface igniters are 100% tested and completely reliable. They are compatible with all OEM furnaces. TrueStart® hot surface igniters are available as direct replacement for OEM silicon carbide igniters.



CATALOG NO.	DESCRIPTION	UOM	ORDER MULTIPLE
IGN-401	TrueStart® Hot Surface Igniter, Direct Replacement, Silicon Carbide for 41-401	EA	6
IGN-402	TrueStart® Hot Surface Igniter, Direct Replacement, Silicon Carbide for 41-402	EA	6
IGN-403	TrueStart® Hot Surface Igniter, Direct Replacement, Silicon Carbide for 41-403	EA	6
IGN-405	TrueStart® Hot Surface Igniter, Direct Replacement, Silicon Carbide for 41-405	EA	6
IGN-406	TrueStart® Hot Surface Igniter, Direct Replacement, Silicon Carbide for 41-406	EA	6
IGN-407	TrueStart® Hot Surface Igniter, Direct Replacement, Silicon Carbide for 41-407	EA	6
IGN-408	TrueStart® Hot Surface Igniter, Direct Replacement, Silicon Carbide for 41-408	EA	6
IGN-409	TrueStart® Hot Surface Igniter, Direct Replacement, Silicon Carbide for 41-409	EA	6
IGN-410	TrueStart® Hot Surface Igniter, Direct Replacement, Silicon Carbide for 41-410	EA	6
IGN-412	TrueStart® Hot Surface Igniter, Direct Replacement, Silicon Carbide for 41-412	EA	6
IGN-004	TrueStart® Silicon Nitride Universal Kit	EA	6
IGN-110-102	TrueStart® Hot Surface Igniter, Direct Replacement, Silicon Carbide for 41-110-102	EA	6
IGN-110-103	TrueStart® Hot Surface Igniter, Direct Replacement, Silicon Carbide for 41-110-103	EA	6
IGN-110-101	TrueStart® Hot Surface Igniter, Direct Replacement, Silicon Carbide for 41-110-101	EA	6
IGN-108-101	TrueStart® Hot Surface Igniter, Direct Replacement, Silicon Carbide for 41-108-101	EA	6
IGN-106	TrueStart® Hot Surface Igniter, Direct Replacement, Silicon Carbide for 41-106-101	EA	6
IGN-IR	TrueStart™ Universal Round Hot Surface Igniter Kit	EA	6

HEATING EQUIPMENT SERVICE PRODUCTS

Gas Equipment Service Tools

The GDK4080 is a complete set of high quality, small diameter precision gauging drills used to clean and enlarge gas orifices, burners and carburetor jets. It contains 41 commonly used gauging drills with handles, sizes from #40 to #80. A tapered broach with handle (GB3020) is also included.



CATALOG NO.	DESCRIPTION	UOM	ORDER MULTIPLE
GDK4080	Gauging Kit Drills, #40-80 set	EA	1
GB3020	Broach 3015 with handle	EA	1

TRUESTART® IGNITION ACCESSORIES

TrueStart® Flame Sensors

TrueStart® flame sensors are a direct replacement for OEM flame sensors. They are easy to install with matching flame rod length and bending angles. Model options are available for Carrier®/BDP, Lennox, Goodman/Amana, Rheem/Ruud, JCI/York, and Trane systems.



CATALOG NO.	DESCRIPTION	UOM	ORDER MULTIPLE
900-1	TrueStart® FLAME SENSOR replaces Robertshaw 10-760, White-Rodgers 760-401, Packard PFS401, Supco FLS401, MARS 67970, SIC SP-103	EA	1
900-3	TrueStart® FLAME SENSOR replaces Carrier®/Bryant LH33WZ516, LH680013	EA	1
900-4	TrueStart® FLAME SENSOR replaces Carrier®/Bryant LH33WZ517, LH33WZ511, LH33WZ515, LH680012, LH680014	EA	1
900-5	TrueStart® FLAME SENSOR replaces Carrier® LH33WZ518	EA	1
900-6	TrueStart® FLAME SENSOR replaces Carrier® LH33WZ520	EA	1
900-8	TrueStart® FLAME SENSOR replaces Lennox® 28M9701, 20467102	EA	1
900-9	TrueStart® FLAME SENSOR replaces Lennox® 44745-001, 44745001, R44745-001, 98M8701	EA	1
900-10	TrueStart® FLAME SENSOR replaces Goodman/Amana O130F0001, B1172606, 20488501, L38-035, L38035	EA	1
900-11	TrueStart® FLAME SENSOR replaces Rheem/Ruud 62-23543-01 and 62-23543-03	EA	1
900-14	TrueStart® FLAME SENSOR replaces Trane SEN491, SEN1114, SEN441, SENO441	EA	1
900-15	TrueStart® FLAME SENSOR replaces JCI/York 024-35354-000, 025-35354-700, S1-02527773000, S1-02527773700	EA	1
900-16	TrueStart® FLAME SENSOR replaces JCI/York 025-30788-000, 025-30788-700, S1-02530788700	EA	1
900-17	TrueStart® FLAME SENSOR replaces JCI/York S1-2702-311P, 2702-311P, 2702-311	EA	1

VENT TERMINATION KITS

Concentric Vents

Concentric vents make it easier to have a two pipe installation for high efficiency furnaces. These vents simplify installation and only require one hole through the wall or roof where the pipes terminate. Without using these vents, the installation would require cutting two holes through the home, one for each pipe. These vents save time and money by reducing the amount of work required. Available in 2", 3" or 4" intake vent sizes.

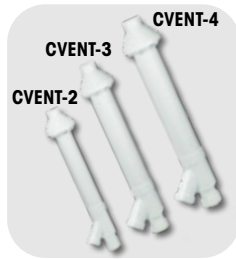

CATALOG NO.	DESCRIPTION	UOM	ORDER MULTIPLE
CVENT-2	2" Concentric Vent	EA	1
CVENT-3	3" Concentric Vent	EA	1
CVENT-4	4" Concentric Vent	EA	1
CVENTCAP2	Replacement cap for CVENT-2	EA	1
CVENTCAP3	Replacement cap for CVENT-3	EA	1
CVENTCAP4	Replacement cap for CVENT-4	EA	1
CVS-2	Vent screen for CVENT-2	EA	1
CVS-3	Vent screen for CVENT-3	EA	1
CVENT-2AB	Accelerator Bushing for 2" CVENT	EA	1

Extended Lengths for Concentric Vents

Concentric vents make it easier to have a two-pipe installation for high efficiency furnaces. These vents simplify installation and only require one hole through the wall or roof where the pipes terminate. Without using these vents, the installation would require cutting two holes through the home, one for each pipe. These vents save time and money by reducing the amount of work required. The extended length of these vents help to maintain clearance above the anticipated snow level to meet local code requirement.

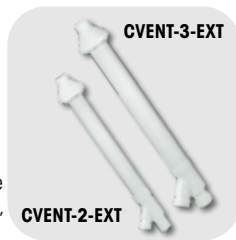

CATALOG NO.	DESCRIPTION	UOM	ORDER MULTIPLE
CVENT-2-EXT	2 in. Concentric Vent Kit, 60 in. Overall Ext. Length	EA	1
CVENT-3-EXT	3 in. Concentric Vent Kit, 60 in. Overall Ext. Length	EA	1

Horizontal Vent Termination Kits

Horizontal vent kits for use in venting high efficiency fossil fuel appliances. The low profile kit hides the vent from view.



CATALOG NO.	DESCRIPTION	UOM	ORDER MULTIPLE
HVENT-2	Horizontal Termination Kit - 2 inch	EA	6
HVENT-3	Horizontal Termination Kit - 3 inch	EA	6
HVENT-2CA	Horizontal Termination Kit - 2 inch for Canada	EA	6
HVENT-3CA	Horizontal Termination Kit - 3 inch for Canada	EA	6

Concentric Vent Flexible Installation

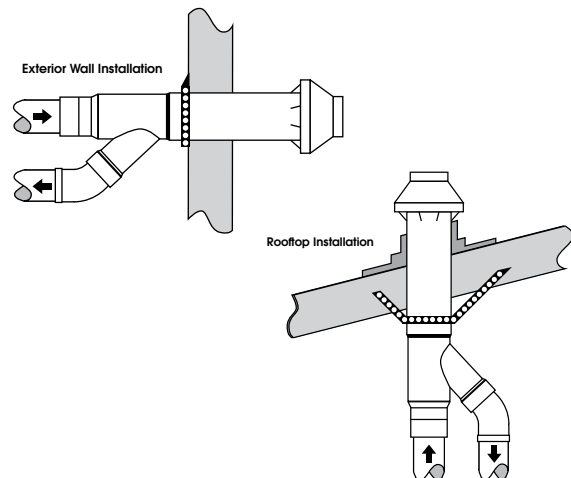

TANKLESS WATER HEATER CONNECTION KITS

EasyFlex Tankless Water Heater Connection Kits

The Tankless Water Heater Connection Kits by EASYFLEX are customized kits. Each kit includes one 1" OD, 3/4" MXF Gas Connector, two 3/4" ID, 3/4" FIP x 3/4" MIP Water Connectors, Hot & Cold Isolation Valve Set, and Pressure Relief Valve. One box has it all! Installation and maintenance are made easy for contractors and homeowners.



Global Pipe Manufacturer
EASYFLEX

CATALOG NO.	DESCRIPTION	UOM	ORDER MULTIPLE
EFLF-ISV-HCTP	Tankless Water Heater Isolation Valve Set	EA	1
EFHC-0118-3Y0118	Tankless Water Heater Isolation Valve Set + 18" Connectors	EA	1
EFHC-0124-3Y0124	Tankless Water Heater Isolation Valve Set + 24" Long Connectors	EA	1

DIVERSITECH GAS CONNECTORS

DiversiTech Gas Connectors 1/2" OD

Combining flexibility, durability, and functionality, DiversiTech stainless steel gas connectors are CSA design certified and 100% leak tested for quality and security. DiversiTech gas connectors are durable and reliable to give you everything you need. Available in a variety of sizes and lengths.



D20-3132-18

CATALOG NO.	DESCRIPTION	UOM	ORDER MULTIPLE
D20-3132-18	Gas Connector – 18" long, 1/2" OD x 3/8" ID, M x F	EA	12
D20-3132-24	Gas Connector – 24" long, 1/2" OD x 3/8" ID, M x F	EA	12
D20-3132-36	Gas Connector – 36" long, 1/2" OD x 3/8" ID, M x F	EA	12
D20-3132-48	Gas Connector – 48" long, 1/2" OD x 3/8" ID, M x F	EA	12

DiversiTech Gas Connectors 5/8" OD

Combining flexibility, durability, and functionality, DiversiTech stainless steel gas connectors are CSA design certified and 100% leak tested for quality and security. DiversiTech gas connectors are durable and reliable to give you everything you need. Available in a variety of sizes and lengths.



D30-3132-18

CATALOG NO.	DESCRIPTION	UOM	ORDER MULTIPLE
D30-3131-24	Gas Connector – 24" long, 5/8" OD x 1/2" ID, M x M	EA	12
D30-3131-36	Gas Connector – 36" long, 5/8" OD x 1/2" ID, M x M	EA	12
D30-3131-48	Gas Connector – 48" long, 5/8" OD x 1/2" ID, M x M	EA	12
D30-3132-18	Gas Connector – 18" long, 5/8" OD x 1/2" ID, M x F	EA	12
D30-3132-24	Gas Connector – 24" long, 5/8" OD x 1/2" ID, M x F	EA	12
D30-3132-36	Gas Connector – 36" long, 5/8" OD x 1/2" ID, M x F	EA	12
D30-3132-48	Gas Connector – 48" long, 5/8" OD x 1/2" ID, M x F	EA	12

Yellow Epoxy Coated Gas Connectors

Yellow coated gas connectors include an epoxy coating for added durability and extra protection from corrosion, chemical stains from common household products and plumbing repairs. They can be used in various applications: Dryers, Boilers, BBQ Grills, Ranges/Ovens, Furnaces, Fireplaces, Space Heaters, Tankless Water Heaters, Rooftop Units, Manufactured Homes.



DC30-3132-18

CATALOG NO.	DESCRIPTION	UOM	ORDER MULTIPLE
DC20-3132-18	Gas Connector coated – 18" long, 1/2" OD x 3/8" ID, M x F	EA	12
DC20-3132-24	Gas Connector coated – 24" long, 1/2" OD x 3/8" ID, M x F	EA	12
DC20-3132-36	Gas Connector coated – 36" long, 1/2" OD x 3/8" ID, M x F	EA	12
DC20-3132-48	Gas Connector coated – 48" long, 1/2" OD x 3/8" ID, M x F	EA	12
DC20-3131-18	Gas Connector coated – 18" long, 1/2" OD x 3/8" ID, M x M	EA	12
DC20-3131-24	Gas Connector coated – 24" long, 1/2" OD x 3/8" ID, M x M	EA	12
DC20-3131-36	Gas Connector coated – 36" long, 1/2" OD x 3/8" ID, M x M	EA	12
DC20-3131-48	Gas Connector coated – 48" long, 1/2" OD x 3/8" ID, M x M	EA	12
DC30-3132-18	Gas Connector coated – 18" long, 5/8" OD x 1/2" ID, M x F	EA	12
DC30-3132-24	Gas Connector coated – 24" long, 5/8" OD x 1/2" ID, M x F	EA	12
DC30-3132-36	Gas Connector coated – 36" long, 5/8" OD x 1/2" ID, M x F	EA	12
DC30-3132-48	Gas Connector coated – 48" long, 5/8" OD x 1/2" ID, M x F	EA	12
DC30-3131-18	Gas Connector coated – 18" long, 5/8" OD x 1/2" ID, M x M	EA	12
DC30-3131-24	Gas Connector coated – 24" long, 5/8" OD x 1/2" ID, M x M	EA	12
DC30-3131-36	Gas Connector coated – 36" long, 5/8" OD x 1/2" ID, M x M	EA	12
DC30-3131-48	Gas Connector coated – 48" long, 5/8" OD x 1/2" ID, M x M	EA	12

DORMONT GAS CONNECTORS AND VALVES

Dormont 20 Series

1/2" O.D. x 3/8" I.D. 1/2" MIP x 1/2" FIP Connectors



20-3132-18

CATALOG NO.	DESCRIPTION	UOM	ORDER MULTIPLE
20-3132-18	Gas Connector – 18" Long	EA	12
20-3132-24	Gas Connector – 24" Long	EA	12
20-3132-36	Gas Connector – 36" Long	EA	12
20-3132-48	Gas Connector – 48" Long	EA	12

Dormont 20 Series with Valve

Corrugated stainless steel connectors with special Supr Safe design to increase flexibility. Maximum service and safety and is approved for both indoor and outdoor use. This is perfect for range and furnace connections. This Series is AA and CGA approved. This connector comes in 20 3135 18 1/2" O.D. x 3/8" I.D. x 1/2" FIP Ball Valve.



20-3135-18

CATALOG NO.	DESCRIPTION	UOM	ORDER MULTIPLE
20-3135-18	Gas Connector – 18" Long	EA	12
20-3135-24	Gas Connector – 24" Long	EA	12
20-3135-36	Gas Connector – 36" Long	EA	12
20-3135-48	Gas Connector – 48" Long	EA	12

Dormont 30 Series

Corrugated, stainless steel connectors with special Supr Safe® design to increase flexibility. Maximum service and safety, approved for indoor or outdoor use. Perfect for range and furnace connection. AGA and CGA approved. 3131 Series: 5/8" O.D. x 1/2" I.D. 1/2" MIP x 1/2" MIP Connectors. 3132 Series: 5/8" O.D. x 1/2" I.D. 1/2" MIP x 1/2" FIP Connectors.



30-3132-18

CATALOG NO.	DESCRIPTION	UOM	ORDER MULTIPLE
30-3131-24	Gas Connector – 24" Long	EA	12
30-3131-36	Gas Connector – 36" Long	EA	12
30-3131-48	Gas Connector – 48" Long	EA	12
30-3132-12	Gas Connector – 12" Long	EA	12
30-3132-18	Gas Connector – 18" Long	EA	12
30-3132-24	Gas Connector – 24" Long	EA	12
30-3132-30	Gas Connector – 30" Long	EA	12
30-3132-36	Gas Connector – 36" Long	EA	12
30-3132-48	Gas Connector – 48" Long	EA	12
30-3132-60	Gas Connector – 60" Long	EA	12
30-3132-72	Gas Connector – 72" Long	EA	12

Gas Ball Valve

Gas Ball Valves meet the stringent ISO 9000 quality standard. AGA and CGA certified.



91-3042

CATALOG NO.	DESCRIPTION	UOM	ORDER MULTIPLE
91-3042	5/8" O.D. Flare x 3/4" FIP for "30 Series" Gas Conn.	EA	10
91-2032	1/2" O.D. Flare x 1/2" FIP for "20 Series" Gas Conn.	EA	10
92-3232	1/2" FIP x 1/2" FIP	EA	10
92-4242	3/4" FIP x 3/4" FIP	EA	10

CARBON MONOXIDE & SMOKE ALARMS

Carbon Monoxide Alarms

- 10 year sealed batteries provide continuous protection
- Microprocessor intelligence combined with electrochemical sensor virtually eliminates nuisance alarms
- Red LED indicates the status of power and CO
- Table top (free standing) or wall mounted. Mounting hardware included.
- Exceeds industry standards, ETL listed to UL Standard UL 2034 and California State Fire Marshal approved.
- 10 year limited warranty on both battery and alarm



CM-1000

CATALOG NO.	DESCRIPTION	UOM	ORDER MULTIPLE
CM-1000	Carbon Monoxide Smart Alarm	EA	1

loPhic® Smoke & Fire, Carbon Monoxide & Natural Gas Alarm

- 4-in-1 smart alarm uses a single sensor to detect both CO & Natural Gas AND protects against both fast flaming & slow smoldering fires
- 120-volt AC hardwired alarm with backup 9 volt battery is suitable for houses, apartments and mobile homes
- Mount the bracket to any standard wiring junction box and use the large mounting base to cover imperfections in drywall
- Features a quick activation pull-tab and a front-loading battery drawer for replacement without removing the alarm from the bracket
- Comes with a 7 year limited warranty



MDSCN111

CATALOG NO.	DESCRIPTION	UOM	ORDER MULTIPLE
MDSCN111	Smoke & Fire, Carbon Monoxide and Natural Gas Alarm	EA	4

BLACK STEEL WELDED NIPPLES

Black Steel Welded Nipples

Welded Steel that withstands 700 PSI test pressure is perfect for everyday use. The specs for this product are ASTM A 120 (Nom B 10) and the thickness is Sch. 40.



CATALOG NO.	DESCRIPTION	UOM	ORDER MULTIPLE
BPN-1	1/2" x CL Black Welded Nipple	EA	25
BPN-2	1/2" x 1-1/2" Black Welded Nipple	EA	25
BPN-3	1/2" x 2" Black Welded Nipple	EA	25
BPN-4	1/2" x 2-1/2" Black Welded Nipple	EA	25
BPN-5	1/2" x 3" Black Welded Nipple	EA	25
BPN-6	1/2" x 3-1/2" Black Welded Nipple	EA	25
BPN-7	1/2" x 4" Black Welded Nipple	EA	20
BPN-8	1/2" x 4-1/2" Black Welded Nipple	EA	15
BPN-9	1/2" x 5" Black Welded Nipple	EA	15
BPN-10	1/2" x 5-1/2" Black Welded Nipple	EA	25
BPN-11	1/2" x 6" Black Welded Nipple	EA	15
BPN-12	1/2" x 7" Black Welded Nipple	EA	25
BPN-13	1/2" x 8" Black Welded Nipple	EA	15
BPN-14	1/2" x 9" Black Welded Nipple	EA	25
BPN-15	1/2" x 10" Black Welded Nipple	EA	15
BPN-16	1/2" x 11" Black Welded Nipple	EA	25
BPN-17	1/2" x 12" Black Welded Nipple	EA	15
BPN-18	3/4" x CL Black Welded Nipple	EA	25
BPN-19	3/4" x 1-1/2" Black Welded Nipple	EA	25
BPN-20	3/4" x 2" Black Welded Nipple	EA	25
BPN-21	3/4" x 2-1/2" Black Welded Nipple	EA	25
BPN-22	3/4" x 3" Black Welded Nipple	EA	15
BPN-23	3/4" x 3-1/2" Black Welded Nipple	EA	15
BPN-24	3/4" x 4" Black Welded Nipple	EA	15
BPN-25	3/4" x 4-1/2" Black Welded Nipple	EA	20

Black Steel Welded Nipples (cont'd)

CATALOG NO.	DESCRIPTION	UOM	ORDER MULTIPLE
BPN-26	3/4" x 5" Black Welded Nipple	EA	20
BPN-28	3/4" x 6" Black Welded Nipple	EA	15
BPN-30	3/4" x 8" Black Welded Nipple	EA	10
BPN-32	3/4" x 10" Black Welded Nipple	EA	10
BPN-34	3/4" x 12" Black Welded Nipple	EA	15
BPN-35	1" x CL Black Welded Nipple	EA	25
BPN-37	1" x 2" Black Welded Nipple	EA	25
BPN-38	1" x 2-1/2" Black Welded Nipple	EA	25
BPN-39	1" x 3" Black Welded Nipple	EA	5
BPN-40	1" x 3-1/2" Black Welded Nipple	EA	5
BPN-41	1" x 4" Black Welded Nipple	EA	10
BPN-43	1" x 5" Black Welded Nipple	EA	5
BPN-44	1" x 5-1/2" Black Welded Nipple	EA	10
BPN-45	1" x 6" Black Welded Nipple	EA	5
BPN-47	1" x 8" Black Welded Nipple	EA	5
BPN-51	1" x 12" Black Welded Nipple	EA	5
BPN-52	1/2" x 18" Black Welded Nipple	EA	5
BPN-53	1/2" x 24" Black Welded Nipple	EA	3
BPN-54	1/2" x 36" Black Welded Nipple	EA	5
BPN-A12	1/2" Assortment Pack, 6 each of CL thru 6", pack of 66	PK	2
BPN-A34	3/4" Assortment Pack, 6 each of CL thru 6", pack of 66	PK	2

MALLEABLE BLACK IRON PIPE FITTINGS

90 Degree Ell

- Material: ASTM A 197 Cupola Malleable Iron, 150 lb.
- Dimensions:
 - ANSI B 16.3 - Malleable Iron Threaded Fittings
 - ANSI B 16.14 - Ferrous Pipe Plugs, Bushings etc.
 - ANSI B 16.39 - Malleable Iron Threaded Pipe Unions
- Threads: ANSI B 2.1 or BS 21
- Tensile Strength: 28.4 kg/mm.min



CATALOG NO.	DESCRIPTION	UOM	ORDER MULTIPLE
BPF-01	1/2" 90 Degree Elbow	EA	50
BPF-02	3/4" 90 Degree Elbow	EA	35
BPF-03	1" 90 Degree Elbow	EA	20

45 Degree Ell

The 45 Degree Ell fitting is made of ASTM A 197 Cupola Malleable Iron, 150 LB. The dimensions for this fitting are ANSI B 16.3. The threads are ANSI V 2.1 or BS 21 and the tensile strength is 28.4 kg/mm.min for this fitting.



CATALOG NO.	DESCRIPTION	UOM	ORDER MULTIPLE
BPF-04	1/2" 45 Degree Elbow	EA	50
BPF-05	3/4" 45 Degree Elbow	EA	40
BPF-06	1" 45 Degree Elbow	EA	15

Coupling

The Coupling fitting is made of ASTM A 197 Cupola Malleable Iron, 150 LB. The dimensions for this fitting are ANSI B 16.3. The threads are ANSI V 2.1 or BS 21 and the tensile strength is 28.4 kg/mm.min for this fitting.



CATALOG NO.	DESCRIPTION	UOM	ORDER MULTIPLE
BPF-07	1/2" Coupling	EA	60
BPF-08	3/4" Coupling	EA	50
BPF-09	1" Coupling	EA	25

Reducing Coupling

The Reducing Coupling fitting is made of ASTM A 197 Cupola Malleable Iron, 150 LB. The dimensions for this fitting are ANSI B 16.3. The threads are ANSI V 2.1 or BS 21 and the tensile strength is 28.4 kg/mm.min for this fitting.



CATALOG NO.	DESCRIPTION	UOM	ORDER MULTIPLE
BPF-10	3/4" x 1/2" Reducing Coupling	EA	60
BPF-11	1" x 1/2" Reducing Coupling	EA	30
BPF-12	1" x 3/4" Reducing Coupling	EA	25

90 Degree Street Ell

The 90 Degree Street Ell fitting is made of ASTM A 197 Cupola Malleable Iron, 150 LB. The dimensions for this fitting are ANSI B 16.3. The threads are ANSI V 2.1 or BS 21 and the tensile strength is 28.4 kg/mm.min for this fitting.



CATALOG NO.	DESCRIPTION	UOM	ORDER MULTIPLE
BPF-13	1/2" 90 Degree Street Elbow	EA	60
BPF-14	3/4" 90 Degree Street Elbow	EA	35

Tee

The Tee fitting is made of ASTM A 197 Cupola Malleable Iron, 150 LB. The dimensions for this fitting are ANSI B 16.3. The threads are ANSI V 2.1 or BS 21 and the tensile strength is 28.4 kg/mm.min for this fitting.



CATALOG NO.	DESCRIPTION	UOM	ORDER MULTIPLE
BPF-16	1/2" Tee	EA	40
BPF-17	3/4" Tee	EA	35
BPF-18	1" Tee	EA	20

Reducing Tee

The Reducing Tee fitting is made of ASTM A 197 Cupola Malleable Iron, 150 LB. The dimensions for this fitting are ANSI B 16.3. The threads are ANSI V 2.1 or BS 21 and the tensile strength is 28.4 kg/mm.min for this fitting.



CATALOG NO.	DESCRIPTION	UOM	ORDER MULTIPLE
BPF-20	3/4" x 1/2" x 1/2" Reducing Tee	EA	25
BPF-21	3/4" x 1/2" x 3/4" Reducing Tee	EA	20
BPF-34	1" x 1" x 1/2" Reducing Tee	EA	15

Bushing

The Bushing fitting is made of ASTM A 197 Cupola Malleable Iron, 150 LB. The dimensions for this fitting are ANSI B 16.14. The threads are ANSI V 2.1 or BS 21 and the tensile strength is 28.4 kg/mm.min for this fitting.



CATALOG NO.	DESCRIPTION	UOM	ORDER MULTIPLE
BPF-22	3/4" x 1/2" Hex Bushing	EA	75
BPF-23	1" x 1/2" Hex Bushing	EA	50

Cap

The Cap fitting is made of ASTM A 197 Cupola Malleable Iron, 150 LB. The dimensions for this fitting are ANSI B 16.3. The threads are ANSI V 2.1 or BS 21 and the tensile strength is 28.4 kg/mm.min for this fitting.



CATALOG NO.	DESCRIPTION	UOM	ORDER MULTIPLE
BPF-25	1/2" Cap	EA	75
BPF-26	3/4" Cap	EA	40
BPF-27	1" Cap	EA	35

Plug

The Plug fitting is made of ASTM A 197 Cupola Malleable Iron, 150 LB. The dimensions for this fitting are ANSI B 16.14. The threads are ANSI V 2.1 or BS 21 and the tensile strength is 28.4 kg/mm.min for this fitting.



CATALOG NO.	DESCRIPTION	UOM	ORDER MULTIPLE
BPF-28	1/2" Plug	EA	50
BPF-29	3/4" Plug	EA	30

Union

The Union fitting is made of ASTM A 197 Cupola Malleable Iron, 150 LB. The dimensions for this fitting are ANSI B 16.39. The threads are ANSI V 2.1 or BS 21 and the tensile strength is 28.4 kg/mm.min for this fitting.



CATALOG NO.	DESCRIPTION	UOM	ORDER MULTIPLE
BPF-31	1/2" Union	EA	50
BPF-32	3/4" Union	EA	35
BPF-33	1" Union	EA	20

TAPE

Yellow PTFE Thread Seal Tape

Oatey® Yellow Gas Line PTFE Thread Seal Tape is designed and manufactured for natural gas, propane, butane, water, oil and chemical lines. It is heavier than white tape with density of 1.35-1.50 grams/cubic centimeters, 4 mils thick. It complies with MIL-T-22230A (ASG), UL 31 RO, AGA 3226 and CAN/ULC-S642.



513-31403D

CATALOG NO.	DESCRIPTION	UOM	ORDER MULTIPLE
513-31403D	Yellow PTFE Thread Seal Tape, 1/2 in. x 260 in.	EA	1

CONDENSATE MANAGEMENT

Condensate Pump Parts & Accessories.....	36
ClearVue™ Tube and Traps.....	36
Condensate Drain Line Alarm	36
Condensate Drain Line Cleaning	37
Condensate Fittings and Adapters	38
Drain Line, Tubing	38-39
Tapes	39

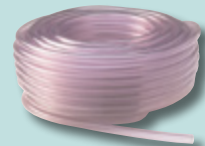

CONDENSATE PUMP PARTS & ACCESSORIES

Pump Parts & Accessories

Check valve installs easily and prevents water from travelling backwards into the pump and overflowing.



CATALOG NO.	DESCRIPTION	UOM	ORDER MULTIPLE
CP-CV	Replacement Check Valve for CP-16 and CP-22	EA	1

CONDENSATE DRAIN LINE ALARM

Universal Alarm

A universal low voltage alarm that can indicate possible system trouble. Use with the Wet Switch®, SOS, Condensate Cop, CP 22 (all types) and all float switches on 24VAC control circuits. If an alarm condition exists, the homeowner can turn the alarm off with a "silence" button until service is obtained, however a red trouble LED will remain lit. Also features: easy 2 wire connection, label to print contractor information, and low current draw. Actuates at greater than 18V to prevent any false alarms due to low voltage. Includes 2 wire nuts, a sheet metal screw, and double sided tape for convenient installation options. Also includes instructions for wiring normally open switch systems (for the CP 22 or other condensate pumps).



CATALOG NO.	DESCRIPTION	UOM	ORDER MULTIPLE
UA-1	Universal Alarm for 24VAC	EA	12

CLEARVUE™ TUBE & TRAPS

ClearVue™ Tube

Clear, 3/4" schedule 40 PVC ideal for installing as condensate drain lines in other areas where seeing the inside of the tubing is helpful. ClearVue™ Tube makes it easy to quickly spot build up or obstructions in drain lines for faster troubleshooting. Available in 5ft lengths.



CATALOG NO.	DESCRIPTION	UOM	ORDER MULTIPLE
CV-TUBE	ClearVue™ Tube – 5' section	EA	50

ClearVue™ Traps

DiversiTech introduces new ClearVue™ P and R traps. These traps are made from smooth, clear PVC with no flat spots to restrict flow. With these new ClearVue™ traps its easy to see directly into them to detect blockages and prevent problems before they become severe. Ideal for installation in condensate drain lines.

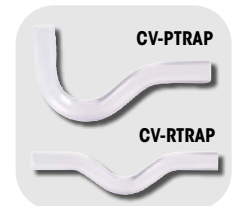

CATALOG NO.	DESCRIPTION	UOM	ORDER MULTIPLE
CV-PTRAP	ClearVue™ 3/4" P trap	EA	25
CV-RTRAP	ClearVue™ 3/4" R trap	EA	25
CV-UTRAP	ClearVue™ 3/4" U trap	EA	25

CONDENSATE DRAIN LINE CLEANING

Drain Gun™ - 16g SWOOSH® CO₂ Cartridges

Clears condensate drains with a SWOOSH! A lightweight (3 oz.) portable tool designed to blow out drain lines instantly. New larger SWOOSH® CO₂ cartridges now deliver 800 PSI of oil free air to clear the line. Each unit comes equipped with a tapered fitting to work on 3/8 in. – 3/4 in. drain openings. Flexible hose assembly maneuvers through cabinets, coils and hard to reach drains. Cartridges are environmentally safe and recyclable. No need for air or nitrogen tanks. Reduces labor costs and time on service calls.



GG-1



GG-1A

CATALOG NO.	DESCRIPTION	UOM	ORDER MULTIPLE
GG-1	Drain Gun™ for A/C Condensate Lines	EA	6
GGC-12	SWOOSH® 16g CO ₂ Cartridges, pack of 12	PK	1
GG-1A	Drain Gun™ Adapter Kit	EA	1
GG-1H	Drain Gun™ Hose Assembly	EA	1
GG-1TF	Drain Gun™ replacement tip	EA	1
GG-1BOR	Drain Gun™ bottom o-ring, pack of 5	PK	1

SWOOSH® Drain Gun™ BIG SHOT™ - 20g SWOOSH® CO₂ Cartridges

The SWOOSH® Drain Gun™ BIG SHOT™ is the newest drain clearing tool from DiversiTech. The SWOOSH® Drain Gun™ BIG SHOT™ uses new larger 20 gram SWOOSH® cartridges that provide 25% more capacity to better remove clogs, gunk and debris from drain lines. And the SWOOSH® Drain Gun™ BIG SHOT™ includes a flexible hose with tapered fitting to easily connect with drain line opening for fast and easy clearing.



SG-1



SGC-12

CATALOG NO.	DESCRIPTION	UOM	ORDER MULTIPLE
SG-1	SWOOSH® Drain Gun™ BIG SHOT™	EA	6
SGC-12	SWOOSH® 20g CO ₂ Cartridges, pack of 12	PK	1

DrainDawg™

The DrainDawg™ is a complete condensate drain cleaning kit, including the CT-475M deluxe nitrogen / CO₂ 0-475 psi regulator, the TG-10 & BS-25 ten foot hose and blowgun assembly, and the CW-15 fifteen inch whip hose. Also included is the AP-DD DrainDawg™ Accessory Fitting Kit which contains the DF-75 DrainDawg™ inflatable tip, the CK-141 3/4"-1" cone fitting, the FA-02 CO₂ to nitrogen adapter, the QN-S3 needle tip, and the TC-25 tire chuck. Made in USA.



CB-2

CATALOG NO.	DESCRIPTION	UOM	ORDER MULTIPLE
CB-2	DrainDawg™ Kit	EA	3

DrainKat™

The DrainKat™ is an over the shoulder refillable, nitrogen or CO₂ mini drain cleaning kit. Featuring a small cylinder that holds 9 cubic feet of nitrogen or 2-1/2 pounds of CO₂. The cylinder includes an integral mounted regulator for quick and easy adjustment of discharge pressure. Get exactly the amount of pressure you need with a quick adjustment on the regulator. Furnished complete with an 87" hose and drain gun kit, the CW-15 whip hose, and the AP-DK DrainKat™ Accessory Fitting Kit which contains the DF-75 DrainDawg™ inflatable tip, the CB-03 3/4"-1" cone fitting, the FA-01 male to male CO₂ to nitrogen adapter, the FA-03 CO₂ trans-fill adapter, and the the QN-S3 needle tip. Made in the USA.



MBK-6

CATALOG NO.	DESCRIPTION	UOM	ORDER MULTIPLE
MBK-6	DrainKat™ Kit	EA	2

A/C Easy Tee®

A/C Easy Tee® is a simple, inexpensive way to comply with the International Mechanical Code M32-12. It provides a Condensate Drain Service Port that is flexible and easy to use with nitrogen, water, or shop vac. A/C Easy Tee® has no valve or moving parts that could fail.



ET75

CATALOG NO.	DESCRIPTION	UOM	ORDER MULTIPLE
ET75	A/C Easy Tee®	EA	20
ET75-KIT	A/C Easy Tee® Kit - 2 Tees and ST75	EA	6
ST75	Service Tool Kit	EA	6

DrainDawg™ and DrainKat™ Fittings

The DrainDawg™ and DrainKat™ products are compatible with a series of fittings to connect to condensate drain lines and hoses. The fittings are available individually, or as kits for the DrainDawg™ and DrainKat™.

CATALOG NO.	DESCRIPTION	UOM	ORDER MULTIPLE
AP-DD	DrainDawg™ Accessory Pack	EA	1
AP-DK	DrainKat™ Accessory Pack	EA	1
BS-25	Blow gun with safety tip for DrainDawg™ or DrainKat™	EA	1
CB-03	3/4 in. cone tip with female thread for DrainDawg™ or DrainKat™ blow gun	EA	1
CK-141	3/4 in. cone with male thread for use with whip hose for DrainDawg™ or DrainKat™	EA	1
CW-15	15 in. whip hose for DrainDawg™ or DrainKat™	EA	1
DF-75	DrainDawg™ inflatable tip for drain line blowout	EA	1
FA-01	Nitrogen to CO ₂ adapter, male by male for DrainKat™	EA	1
FA-02	Nitrogen to CO ₂ adapter, female by female for DrainDawg™	EA	1
FA-03	CO ₂ transfill adapter for DrainKat™	EA	1
QN-S3	Needle tip with female thread for DrainDawg™ or DrainKat™ blow gun	EA	1
TC-25	Tire chuck for DrainDawg™	EA	1
TG-10	120 in. blow gun hose for DrainDawg™	EA	1
TG-87A	87 in. blow gun hose for DrainKat™	EA	1

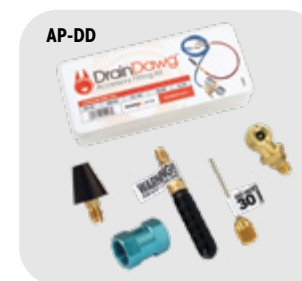

AP-DD

CONDENSATE FITTINGS & ADAPTERS

A/C Condensate Drain Pan Fittings

The Drain Pan Fittings are designed to be used with our Condensate Drain Pans.



CATALOG NO.	DESCRIPTION	UOM	ORDER MULTIPLE
6-1	3/4" Slip	EA	50
6-2	1" Slip	EA	50
6-3	3/4" Slip with Plastic Nut	EA	50
6-5	3/4" Female Pipe Thread	EA	50

Mini-Split Drain Adapters

Mini Split fan units — either ceiling cassettes or wall cassettes — typically have a unique (metric) drain line fitting. DiversiTech's adapters convert this metric fitting to standard drain line tubing sizes.



CATALOG NO.	DESCRIPTION	UOM	ORDER MULTIPLE
230-DLFY	Mini-Split Drain Line Y	EA	1
230-DLF16	16mm Mini-Split Drain Line Adapter	EA	1
230-DLF18	18mm Mini-Split Drain Line Adapter	EA	1
230-DLF20	20mm Mini-Split Drain Line Adapter	EA	1
230-DLF25	25mm Mini-Split Drain Line Adapter	EA	1
230-DLF32	32mm Mini-Split Drain Line Adapter	EA	1

Water Heater Pans

Aluminum water heater pans can be installed under gas or electric water heaters to protect from water damage. Includes a 1" PVC drain fittings to allow for connection to indirect drain. Each pan is manufactured from .032 in. prime aluminum with a pre-cut side opening to accommodate a drain fitting. Pan depth is a minimum 2.5 in.



CATALOG NO.	DESCRIPTION	UOM	ORDER MULTIPLE
6-M22	Aluminum Water Heater Pan - 22 in.	EA	6
6-M24	Aluminum Water Heater Pan - 24 in.	EA	6
6-M26	Aluminum Water Heater Pan - 26 in.	EA	6
6-M30	Aluminum Water Heater Pan - 30 in.	EA	6

Condensate Drain Pans

When a mini split system operates in heat pump mode, the outdoor coil becomes the evaporator coil. Typically, condensation generates from the evaporator coil. In certain installations, the condenser coil may be mounted overhead on brackets affixed to a wall. In these overhead applications, dripping condensation may be a nuisance. Condensate drain pans bolt onto the condenser mounting brackets, and the drain line can be plumbed to a nearby drain location. Furnished complete with all mounting hardware and drain pan outlet, condensate drain pans are available in either plastic or powder coated steel.

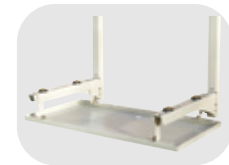

CATALOG NO.	DESCRIPTION	UOM	ORDER MULTIPLE
230-DPPL	Poly Condensate Drain Pan (Large)	EA	1
230-DPPM	Poly Condensate Drain Pan (Medium)	EA	1

DRAIN LINE, TUBING

Mini-Split Condensate Drain Line

A unique drain line for mini-split units. This large diameter drain line is typical for mini-split installations. Furnished in 160 feet lengths with cut marks every 3.28 feet. Accommodates 5/8" and 3/4" connections.



CATALOG NO.	DESCRIPTION	UOM	ORDER MULTIPLE
230-DL16	5/8" ID Mini-Split Drain Line	EA	160'
230-DL16-20	5/8" ID Mini-Split Drain Line - 20' section	EA	1

Clear Vinyl Tubing

Clear vinyl hose applications include: air conditioning and refrigeration condensate drains, condensate pump discharge lines and humidifier overflows.



CATALOG NO.	DESCRIPTION	UOM	ORDER MULTIPLE
7-316	3/16" ID Clear Vinyl Tubing - 100' section	EA	100'
7-CVMINITUBE	3/16" ID CVMINI Tubing - 100' section	EA	100'
7-14	1/4" ID Clear Vinyl Tubing - 100' section	EA	100'
7-38	3/8" ID Clear Vinyl Tubing - 100' section	EA	100'
7-12	1/2" ID Clear Vinyl Tubing - 100' section	EA	100'
7-58	5/8" ID Clear Vinyl Tubing - 100' section	EA	100'
7-34	3/4" ID Clear Vinyl Tubing - 100' section	EA	100'
7-78	7/8" ID Clear Vinyl Tubing - 50' section	EA	50'
7-10	1" ID Clear Vinyl Tubing - 50' section	EA	50'

DRAIN LINE, TUBING cont'd

Gorilla Tube® Clear Vinyl Tubing

Applications include: air conditioning and refrigeration condensate drains, condensate pump discharge lines, and humidifier overflows.

Several sizes from 1/4" to 1" diameter. Non-toxic clear vinyl chloride.

Select Gorilla Tube® over standard clear vinyl tube because:

- Extra rigid design resists crimping and kinking due to durometer value of 80 (Shore A) and thicker wall
- Maximum service temperature 140°F (60°C)
- Better performance in cold weather climates.



7-14P

CATALOG NO.	DESCRIPTION	UOM	ORDER MULTIPLE
7-14P	1/4", .250" I.D., .360" O.D., .055 wall thickness	EA	100'
7-38P	3/8", .375" I.D., .495" O.D., .060 wall thickness	EA	100'
7-12P	1/2", .500" I.D., .631" O.D., .066 wall thickness	EA	100'
7-58P	5/8", .625" I.D., .771" O.D., .073 wall thickness	EA	100'
7-34P	3/4", .750" I.D., .913" O.D., .082 wall thickness	EA	100'
7-78P	7/8", .875" I.D., 1.050" O.D., .088 wall thickness	EA	50'
7-10P	1", 1.000" I.D., 1.215" O.D., .108 wall thickness	EA	50'

Braided Clear Vinyl Tubing

Braided clear vinyl offers better strength and sealing than regular clear vinyl tubing and is very kink-resistant.



7-14B

CATALOG NO.	DESCRIPTION	UOM	ORDER MULTIPLE
7-14B	1/4" ID Braided Clear Vinyl Tubing – 100' section	EA	100'
7-14B50	1/4" ID Braided Clear Vinyl Tubing – 50' section	EA	50'
7-38B	3/8" ID Braided Clear Vinyl Tubing – 100' section	EA	100'
7-38B50	3/8" ID Braided Clear Vinyl Tubing – 50' section	EA	50'
7-12B	1/2" ID Braided Clear Vinyl Tubing – 100' section	EA	100'
7-12B50	1/2" ID Braided Clear Vinyl Tubing – 50' section	EA	50'
7-58B	5/8" ID Braided Clear Vinyl Tubing – 100' section	EA	100'
7-58B50	5/8" ID Braided Clear Vinyl Tubing – 50' section	EA	50'
7-34B	3/4" ID Braided Clear Vinyl Tubing – 100' section	EA	100'
7-34B50	3/4" ID Braided Clear Vinyl Tubing – 50' section	EA	50'

TAPES

Cork Insulation Tape

Adheres firmly to all metals. Use on hot or cold pipes to stop condensation and drips.



6-330

CATALOG NO.	DESCRIPTION	UOM	ORDER MULTIPLE
6-330	Cork Insulation Tape – 1/8" x 2" x 30' Roll – Black	EA	12

PTFE Tape

Made of pure white PTFE. Non toxic. For use with chemicals, solvents, oxygen, and on food lines. Withstands up to 2000 psi of pressure.



6-733

CATALOG NO.	DESCRIPTION	UOM	ORDER MULTIPLE
6-733	Teflon Tape – 1/2" x 520"	EA	100
6-734	Teflon Tape – 1/2" x 260"	EA	100
6-735	Teflon Tape – 3/4" x 520"	EA	100
6-736	Teflon Tape – 3/4" x 260"	EA	100

Foam Insulation Tape

Superior self-adhesive foam tape can be used on hot or cold pipes. Fits well around valves and fittings. Easily cut and molded.



6-9718

CATALOG NO.	DESCRIPTION	UOM	ORDER MULTIPLE
6-9718	Foam Insulation Tape – 1/8" x 2" x 30' Roll – Black	EA	12

Yellow PTFE Thread Seal Tape

Oatey® Yellow Gas Line PTFE Thread Seal Tape is designed and manufactured for natural gas, propane, butane, water, oil and chemical lines. It is heavier than white tape with density of 1.35 - 1.50 grams/cubic centimeters, 4 mils thick. It complies with MIL-T-22230A (ASG), UL 31 RO, AGA 3226 and CAN/ULC-S642.



513-31403D

CATALOG NO.	DESCRIPTION	UOM	ORDER MULTIPLE
513-31403D	Yellow PTFE Thread Seal Tape, 1/2 in. x 260 in.	EA	100



Providing best-in-class HVAC/R service and support is what you do, and relying on dependable product solutions is critical to getting the job done right — and to your customer's satisfaction.

Meet Asurity™ — a DiversiTech® brand of condensate management products that provide a complete system of pumps, switches, drain pans, and treatments supported by highly trained technical support when you need it. At Asurity, we do more than create complete system solutions, we create peace of mind.

Visit asurityhvacr.com to learn more



**YOUR COMPLETE SYSTEM FOR
CONDENSATE MANAGEMENT**



Condensate Pumps



Switches



Drain Pans



Treatments

GENERAL INDUSTRIAL

Abrasive Cloths.....	42
Aerosols.....	42
Batteries By Rayovac®.....	43
Carton Sealing Tape and Dispenser.....	43
Contact Cleaners.....	43-44
Coveralls.....	44
Degreasers.....	44
Drop Cloths.....	45
Hand Cleaners.....	45
Industrial Towels.....	45-46
Lubricants.....	46-47
Markers.....	48
Paints and Primers.....	48
Safety Supplies, Devices.....	48-50
Sealant, Epoxy, Glue.....	51
Sealing Compounds, Adhesive.....	51-52
Sheet Metal Screws.....	53
Surface Protection.....	54
Wasp, Hornet and Yellow Jacket Killers.....	54



ABRASIVE CLOTHS

All Purpose Cleaning Pads

For cleaning copper tubes and fittings. Made of nylon and will not rust. Can be used wet or dry. Leaves no residue and is long lasting.



ACP-10

CATALOG NO.	DESCRIPTION	UOM	ORDER MULTIPLE
ACP-10	All Purpose Cleaning Pads – pack of 10	PK	1

Abrasive Cloth

Aluminum oxide, high quality 120 grit, abrasive cloth to thoroughly clean copper and steel tubing. Works wet or dry. Exceeds industry standards for abrasive cloth.



SC-10

CATALOG NO.	DESCRIPTION	UOM	ORDER MULTIPLE
SC-10	Abrasive Cloth – 1-1/2" x 10 yds.	EA	1
SC-25	Abrasive Cloth – 1-1/2" x 25 yds.	EA	1

Grip-Cut™

Open mesh sand screen cloth. Aluminum oxide grain resin bonded to synthetic nylon cloth. 100% waterproof, but can also be used dry for sanding by hand or with portable tools. Most effective where clogging is a problem, such as soft materials. 180 grit.



SCM-5

CATALOG NO.	DESCRIPTION	UOM	ORDER MULTIPLE
SCM-5	Grip-Cut™ – 1-1/2" x 5 yds.	EA	1
SCM-10	Grip-Cut™ – 1-1/2" x 10 yds.	EA	1
SCM-25	Grip-Cut™ – 1-1/2" x 25 yds.	EA	1

AEROSOLS

Sure-Stick Heavy Duty Adhesive Spray

Wide web spray adhesive ideal for both temporary or permanent bonding. Waterproof, transparent and non-staining. Use for the toughest adhesive applications with leather, cardboard, most plastics, polyethylene sheeting and insulation in HVAC applications. Cleans with mineral spirits. Not for use on vinyl.



315-20

CATALOG NO.	DESCRIPTION	UOM	ORDER MULTIPLE
315-20	Sure-Stick Adhesive Spray – 12 oz. Aerosol	EA	12

CBC II Contact Cleaner

A plastic safe, non flammable electronic contact and circuit board cleaner. Dries fast, leaves no residue. No harsh fumes or odors.



362-16

CATALOG NO.	DESCRIPTION	UOM	ORDER MULTIPLE
362-16	CBC II Contact Cleaner – 10 oz. Aerosol	EA	12

Sweat-Free Pipe Insulation Spray

An aerosol spray on insulation specifically developed for cold water pipes, refrigeration and air conditioning lines. Stops sweating and dripping problems. Dries to a clean, white, flexible and water resistant coating. Adheres to galvanized, black iron, steel, brass, copper and PVC piping.



770-15

CATALOG NO.	DESCRIPTION	UOM	ORDER MULTIPLE
770-15	Sweat-Free Pipe Insulation – 15 oz. Aerosol	EA	12

Glass Cleaner

A foaming premium glass cleaner that powers through the toughest grease and grime on any glass or hard surface. Leaves a streak-free shine.



325-12

CATALOG NO.	DESCRIPTION	UOM	ORDER MULTIPLE
325-12	Glass Cleaner – 19 oz. Aerosol	EA	12

BATTERIES BY RAYOVAC®

Rayovac® is the Industrial Product Leader! Rayovac® is the leader in the industrial battery market and has been for years, with an estimated 50% share of the traditional industrial distribution channel. Rayovac® introduced the top-selling industrial flashlight to the market, and set the quality standard by which all other industrial flashlights are measured today. Whether your customer is searching for a toolbox-tough flashlight or high-performance batteries, Rayovac® offers a broad range of products to meet your needs.

Rayovac® Industrial Maximum Alkaline Batteries – Shrink Packed

- Same battery performance as the Contractor Packs at a lower cost
- Formulated specifically to exceed the everyday demands of industrial applications
- Outstanding dependability for “must work” applications



CATALOG NO.	DESCRIPTION	UOM	ORDER MULTIPLE
7-ALAA	Alkaline AA Battery – Shrink Packed, pack of 8	EA	8
7-ALAAA	Alkaline AAA Battery – Shrink Packed, pack of 8	EA	8
7-ALC	Alkaline C Battery – Shrink Packed, pack of 6	EA	6
7-ALD	Alkaline D Battery – Shrink Packed, pack of 6	EA	6
7-AL9V	Alkaline 9V Battery – Shrink Packed, pack of 6	EA	6

Rayovac® Lantern Batteries

- Dependable performance — for “must work” applications
- Available in General Purpose, Heavy Duty, and Alkaline Maximum



CATALOG NO.	DESCRIPTION	UOM	ORDER MULTIPLE
7-806	6 Volt Alkaline Maximum – Spring Terminals, pack of 6	EA	6

Rayovac® Industrial Maximum Alkaline Batteries — Contractor Packs

- Contractor preferred, clear, re-sealable package
- Greater battery per pack quantities command higher battery sales
- Displays much more readily than other competitive batteries
- In an HVAC test market, the Contractor Packs outsold the standard packs by a greater than 2 to 1 ratio!



CATALOG NO.	DESCRIPTION	UOM	ORDER MULTIPLE
7-ALAA-24	Alkaline AA Battery – Contractor Pack, pack of 24	EA	24
7-ALAAA-18	Alkaline AAA Battery – Contractor Pack, pack of 18	EA	18
7-ALC-12	Alkaline C Battery – Contractor Pack, pack of 12	EA	12
7-ALD-12	Alkaline D Battery – Contractor Pack, pack of 12	EA	12
7-AL9V-12	Alkaline 9V Battery – Contractor Pack, pack of 12	EA	12

CARTON SEALING TAPE AND DISPENSER

Carton Sealing Tape

This Clear 2.4 mil Sealing Tape is 2 in. nominal width and is 110 yds. in length



CATALOG NO.	DESCRIPTION	UOM	ORDER MULTIPLE
540-2110C	Carton Sealing Tape – 2” x 110 Yards – Clear	EA	36

Carton Tape Dispenser

A Heavy Duty Tape Dispenser that holds 2 in. Tape.



CATALOG NO.	DESCRIPTION	UOM	ORDER MULTIPLE
540-DISP	2” Carton Tape Dispenser	EA	1

CONTACT CLEANERS

HF™ Contact Cleaner

A petroleum distillate based precision cleaner with a flash point of 205°F. It can be an alternative to CFCs when applications require higher flashpoints.



CATALOG NO.	DESCRIPTION	UOM	ORDER MULTIPLE
CRC-4-140	HF™ Contact Cleaner – 11 oz.	EA	12

QD® Contact Cleaner

This contact cleaner is suitable for cleaning sensitive electronics and electrical equipment and does not leave any residue. It evaporates quickly and is safe to use on all plastics. This product is more useful where lower flashpoint cleaners are acceptable. The QD® Contact Cleaner is NSF K2 Registered.



CATALOG NO.	DESCRIPTION	UOM	ORDER MULTIPLE
CRC-4CF	QD® Contact Cleaner – 11 oz.	EA	12

CONTACT CLEANERS cont'd

Electronic Degreaser

This Advanced Technology Formula is non-chlorinated, non-conductive, non-corrosive and non-staining. It rapidly dissolves grease, oil and sludge for better efficiency of mechanical equipment. The Electronic Degreaser has no flash or fire point.



CATALOG NO.	DESCRIPTION	UOM	ORDER MULTIPLE
CRC-4NU	Electronic Degreaser – 15 oz.	EA	12

COVERALLS

ShuBee® Trishield Coverall

- Make a great first impression and protect your uniform
- Keep a professional appearance from the first job of the day to the last
- Exclusive Five-Pocket Design™ technology allows you to work more efficiently
- Triple layer material is breathable and durable
- Available in sizes L, XL, 2XL

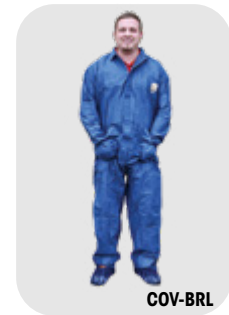

CATALOG NO.	DESCRIPTION	UOM	ORDER MULTIPLE
COV-BRL	ShuBee® Trishield Coverall, Three Layer Polypropylene, Dark Blue, 5 Pocket Design, Large	EA	25
COV-BRXL	ShuBee® Trishield Coverall, Three Layer Polypropylene, Dark Blue, 5 Pocket Design, X-Large	EA	25
COV-BR2XL	ShuBee® Trishield Coverall, Three Layer Polypropylene, Dark Blue, 5 Pocket Design, 2X-Large	EA	25

KLEENGUARD®

KleenGuard® Personal Protective Equipment (PPE) enables rather than inhibits – allowing for maximum productivity and safety for you and your employees. When you're looking for an economical way to help protect your workers during potentially hazardous tasks, the KleenGuard brand A35 Disposable Coveralls, for Liquid and Particle Protection, are an excellent choice.

- Microporous film-laminated material helps protect against hazardous liquids (splashes) and dry particles (like dust and dirt)
- This protective suit has a zipper front and open wrists and ankles
- Available in sizes Medium to 3XL, meets ANSI / ISEA 101- 1996 standards
- PPE for hazardous liquid handling, pressure washing, maintenance, industrial / general manufacturing
- Meets American National Standards Institute and International Safety Equipment Association ANSI/ISEA 101-1996 sizing standard



CATALOG NO.	DESCRIPTION	UOM	ORDER MULTIPLE
COV-WPM	KleenGuard® (PPE), A35 Liquid a7 Particle Protection, Medium, Case/25	CS	1
COV-WPL	KleenGuard® (PPE), A35 Liquid a7 Particle Protection, Large, Case/25	CS	1
COV-WPXL	KleenGuard® (PPE), A35 Liquid a7 Particle Protection, X-Large, Case/25	CS	1
COV-WP2XL	KleenGuard® (PPE), A35 Liquid a7 Particle Protection, 2X-Large, Case/25	CS	1
COV-WP3XL	KleenGuard® (PPE), A35 Liquid a7 Particle Protection, 3X-Large, Case/25	CS	1

DEGREASERS

Heavy Duty Degreaser

This degreaser rapidly and effectively removes grease, oil, tar, and other residue to increase operating efficiency of equipment. It has no flash or fire point, making it an excellent alternative to 1,1,1-based cleaners. Please use caution on plastics.



CATALOG NO.	DESCRIPTION	UOM	ORDER MULTIPLE
CRC-7X	Heavy Duty Degreaser – 19 oz.	EA	12

Heavy Duty Degreaser II

The Heavy Duty Degreaser II is a non-chlorinated, zero VOC formula for cleaning where chlorinated solvents are prohibited. It has a high flashpoint of 180°F. This degreaser effectively removes soils with no residue build-up. Please exercise caution on plastics.



CATALOG NO.	DESCRIPTION	UOM	ORDER MULTIPLE
CRC-7-140	Heavy Duty Degreaser II – 15 oz.	EA	12

Chlor-Free® Degreaser

Non-chlorinated degreasing solvent which is used to remove oil, grease and other contaminants. It is especially useful for applications requiring a quick turnaround and where a low flashpoint solvent can be used.



CATALOG NO.	DESCRIPTION	UOM	ORDER MULTIPLE
CRC-7Z	Chlor-Free® Degreaser – 14 oz.	EA	12

Citrus Degreaser

The Citrus Degreaser has a new Low VOC Formula. The product removes grease, oil and lubricants with no water wash-off. It evaporates quickly and leaves no residue. The product gives off a pleasant citrus scent and is NSF C1 Registered.



CATALOG NO.	DESCRIPTION	UOM	ORDER MULTIPLE
CRC-7PS	Citrus Degreaser – 15 oz.	EA	12

DROP CLOTHS

Canvas Drop Cloths

Premium grade canvas drop cloths are made of first quality and full piece 100% cotton duck canvas fabric. The industrial grade canvas fabric is durable since it is tightly woven using virgin cotton yarn. The drop cloths are washable and reusable. Double stitched seams with heavy-duty rot resistant thread.



DC-4128

CATALOG NO.	DESCRIPTION	UOM	ORDER MULTIPLE
DC-4128	Canvas Drop Cloth - 4' x 12'	EA	1
DC-9128	Canvas Drop Cloth - 9' x 12'	EA	1

HAND CLEANERS

Fast Orange® Hand Cleaner

Three out of five people prefer Fast Orange® over other hand cleaners. The first biodegradable, waterless hand cleaner with aloe, lanolin, and jojoba. Smooth lotion and extra-fine pumice available. USDA Approved.



HCO-7 HCO-15

CATALOG NO.	DESCRIPTION	UOM	ORDER MULTIPLE
HCO-7	Fast Orange® – 7-1/2 fl. oz. Smooth Squeeze Bottle	EA	12
HCO-15	Fast Orange® – 15 oz. Smooth Squeeze Bottle	EA	12
HCO-128	Fast Orange® – 1 Gallon Smooth with Dispenser	EA	4
HCP-7	Fast Orange® – 7-1/2 fl. oz. Pumice Squeeze Bottle	EA	12
HCP-15	Fast Orange® – 15 oz. Pumice Squeeze Bottle	EA	12

Kimberly-Clark Waterless Hand Wipes

These wipes go wherever hands go to get dirty. Full sized 12" x 12" wipes for full sized cleaning. Natural cleaning agent is tough on grease, grime, ink, and paint. Dual textured – smooth for wiping on one side and tough for scrubbing on the other. More wipes with our 75 count bucket.



5-42272

WYPALL

CATALOG NO.	DESCRIPTION	UOM	ORDER MULTIPLE
5-42272	Kimberly-Clark Waterless Hand Wipes – Bucket	EA	6
5-4227R	Hand Wipe Refills, pack of 75	PK	6

INDUSTRIAL TOWELS

WypAll® Plus Towels

Absorbs grease, oil, water and solvents from floors, hands, parts, tools and machinery. Tough enough for extra heavy jobs. Comes in a convenient pop-up box of 100 towels.



5-05790

WYPALL

CATALOG NO.	DESCRIPTION	UOM	ORDER MULTIPLE
5-05790	WypAll® Plus Towels—White, pack of 100	PK	9

Kimtex® Shop **KIMTECH** Towels

Long lasting Kimtex® stands up to oils, chemicals and solvents better than ordinary shop towels. Cloth-like feel and performance. Towel size is 9-3/4" x 16-3/4". 100 towels/box. 5 boxes/case.

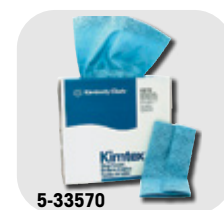

5-33570

CATALOG NO.	DESCRIPTION	UOM	ORDER MULTIPLE
5-33570	Kimtex® Shop Towels, pack of 100	PK	5

Teri® Reinforced Towels

The Teri® reinforced towels feature multi-ply tissue reinforced with nylon webbing for added strength on the job. Made from 100% recycled paper. Towel size is 9-3/4" x 16-3/4". Towel color is white. Comes in a convenient pop up box. 126 towels/box. 10 boxes/case.



5-34790

WYPALL

CATALOG NO.	DESCRIPTION	UOM	ORDER MULTIPLE
5-34790	Teri® Reinforced Towels, pack of 126	PK	10

WypAll® ShopPro X80 Towels

Like a rental shop towel, only more consistent. Engineered to feel like cloth and work even better. Absorbs more oil and water faster pound for pound than laundered shop towels. The ShopPro X80 is simply the heaviest duty towel in the Kimberly Clark line. 160 towels/box.



5-41041

WYPALL

CATALOG NO.	DESCRIPTION	UOM	ORDER MULTIPLE
5-41041	WypAll® ShopPro X80 Towels, pack of 160	PK	1

INDUSTRIAL TOWELS cont'd

WypAll® X70 Cloths

The economical alternative to scrap rags. Workhorse® Manufactured Rags is the first product to be made from Kimberly-Clark's advanced new material – Hydroknit®. Durable, rag tough construction stands up to any task. Can be re-used time and time again. Available in white or blue.



5-41455



CATALOG NO.	DESCRIPTION	UOM	ORDER MULTIPLE
5-41411	WypAll® X70 Cloths, 9-3/4" x 16-3/4" Blue, pack of 100	PK	10
5-41455	WypAll® X70 Cloths, 9-3/4" x 16-3/4" White, pack of 100	PK	10

Shop Towels

Heavy duty reusable towels. For wipe ups of grease, oil, water, etc. 100% cotton material is pre-shrunk and hemmed. Each towel measures 13" x 16".



ST-10

CATALOG NO.	DESCRIPTION	UOM	ORDER MULTIPLE
ST-4	Shop Towels, pack of 4	PK	1
ST-10	Shop Towels, pack of 10	PK	1
ST-24	Shop Towels, pack of 24	PK	1

Terry Towels

100% cotton. Minimum of 14" x 17". Pre-washed for absorbency, fully-hemmed, all-white, and reusable.



DTT-10

CATALOG NO.	DESCRIPTION	UOM	ORDER MULTIPLE
DTT-10	Terry Towels, pack of 10	PK	1
DTT-24	Terry Towels, pack of 24	PK	8

LUBRICANTS

Knock'er Loose® Penetrating Solvent

An industrial strength, low viscosity penetrant designed to rapidly loosen and free seized, bound or frozen fasteners. This product also quickly permeates rust, scale, gum, grease and corrosion. Independent tests reveal that it outperforms its competition.



CRC-1KB

CATALOG NO.	DESCRIPTION	UOM	ORDER MULTIPLE
CRC-1KB	Knock'er Loose® Penetrating Solvent – 13 oz.	EA	12

Screwloose® Industrial Penetrating Oil

A no compromise penetrant that attacks corrosion to free corroded fasteners and mechanical components. A super fast, powerful, concentrated penetrating solvent that loosens rust scale and corrosion and instantly penetrates minute and tightly fitted crevices.



CRC-8

CATALOG NO.	DESCRIPTION	UOM	ORDER MULTIPLE
CRC-8	Screwloose® Industrial Penetrating Oil – 11 oz.	EA	12

White Lithium Grease

White Lithium Grease has superior lubrication and durability in any weather or temperature. It is useful as a break in lubricant for bearings or as a general purpose lubricant and corrosion inhibitor for tools, machinery and equipment.



CRC-9

CATALOG NO.	DESCRIPTION	UOM	ORDER MULTIPLE
CRC-9	White Lithium Grease – 10 oz.	EA	12

Ultra Lite 3-36® Ultra Thin Non Staining Lubricant

Ultra thin, non staining lubricant that resists oil, dirt and dust build up. This lubricant also seals out moisture and protects against corrosion. It is excellent for drying out electrical components.



CRC-1

CATALOG NO.	DESCRIPTION	UOM	ORDER MULTIPLE
CRC-1	Ultra Lite 3-36® Ultra Thin Non Staining Lubricant – 11 oz.	EA	12

Cutting Oil

Cutting Oil is a superior thread cutting lubricant for use on all types of metals, including brass, copper and aluminum. For use on ferrous and non-ferrous metals. Clings to vertical surfaces for improved performance.



CRC-CF2

CATALOG NO.	DESCRIPTION	UOM	ORDER MULTIPLE
CRC-CF2	Cutting Oil - 16 oz. aerosol	EA	1

3-36® Multi-Purpose Lubricant & Corrosion Inhibitor

A multi-purpose petroleum based compound that forms a clear, thin film that lubricates and protects against wear and corrosion. The product also displaces moisture and cleans.



CRC-2

CATALOG NO.	DESCRIPTION	UOM	ORDER MULTIPLE
CRC-2	3-36® Multi-Purpose Lubricant & Corrosion Inhibitor – 11 oz.	EA	12

Zinc-It® Instant Cold Galvanize™ Zinc Rich Galvanize Coating

High-performance zinc coating that electrochemically bonds with ferrous metals to form a galvanic cell. The product also fights rust and corrosion and can be used as a touch-up for damaged galvanized coatings. Zinc-It® Instant Cold Galvanize™ Zinc Rich Galvanize Coating dries quickly.



CRC-5

CATALOG NO.	DESCRIPTION	UOM	ORDER MULTIPLE
CRC-5	Zinc-It® Instant Cold Galvanize™ Zinc Rich Galvanize Coating – 13 oz.	EA	12

WD-40®

Loosens rusted parts. Stops squeaks. Removes tar, grease and adhesives. Displaces moisture. Protects metal. New Smart Straw can.



741-002

741-001

CATALOG NO.	DESCRIPTION	UOM	ORDER MULTIPLE
741-001	WD-40 – 8 oz.	EA	12
741-002	WD-40 – 11 oz.	EA	12
741-003	WD-40, 14.4oz with E-Z Reach	EA	12

SP-400™ Corrosion Inhibitor

Long-term corrosion inhibitor that protects equipment subject to heat, humidity, chemicals or severely corrosive atmospheres. This product is best to use on machined surfaces and assemblies subjected to long periods of storage.



CRC-3

CATALOG NO.	DESCRIPTION	UOM	ORDER MULTIPLE
CRC-3	SP-400™ Corrosion Inhibitor – 10 oz.	EA	12

Sta-Plex™ Extreme Pressure Premium Red Grease

A superior multi-purpose certified lithium complex based grease which contains extreme pressure, anti-wear, and anti-oxidation additives. The product is very useful in high temperature and performance applications. The drop point is 500°F.



CRC-13

CATALOG NO.	DESCRIPTION	UOM	ORDER MULTIPLE
CRC-13	Sta-Plex™ Extreme Pressure Premium Red Grease – 14 oz.	EA	10

Heavy Duty Silicone Mold Release

This product provides maximum releases and is useful in difficult to remove parts. The Heavy Duty Silicone Mold Release is colorless, odorless, non-staining and non-corrosive.



CRC-6

CATALOG NO.	DESCRIPTION	UOM	ORDER MULTIPLE
CRC-6	Heavy Duty Silicone Mold Release – 12 oz.	EA	12

Pull-A-Spout Oiler

All purpose oiler with a 14in. telescoping spout. Zooms out for long shots, and in for short shots, even zooms around corners. Squeeze bottle action. Perfect lubricant for general industrial use. Contains four ounces of finest quality carbon free, rust and oxidation inhibited lubricating oil. Plastic container won't short out around electrical connections. No leakage.



CO-1

CATALOG NO.	DESCRIPTION	UOM	ORDER MULTIPLE
CO-1	Pull-A-Spout Oiler – 4 oz. – (Display)	EA	12
CR-1	Lubricant, Rust Breaker – 4 oz.	EA	12

MARKERS

Valve Action Marker

Large ink supply for increased mileage. Fast drying, smear and water resistant. Utilizes a patented valve-activated ink feed mechanism to supply ink as required, down to the last drop.



CATALOG NO.	DESCRIPTION	UOM	ORDER MULTIPLE
540-799	Valve Action Marker-Regular Tip – Red	EA	12
540-800	Valve Action Marker-Regular Tip – Black	EA	12

Felt Tip Markers

Sharpie® King-Sized Permanent Marker for metal, glass, paper and plastic. Durable metal body.



CATALOG NO.	DESCRIPTION	UOM	ORDER MULTIPLE
540-811B	Sharpie® King-Sized Marker	EA	12

Valve Action Paint Marker

Bright, crisp, opaque colors. The oil-based paint is quick drying and permanent on most surfaces. These markers also feature the patented valve-operated feed mechanism and a medium point.



CATALOG NO.	DESCRIPTION	UOM	ORDER MULTIPLE
540-805	Valve Action Paint Marker – Black	EA	12
540-806	Valve Action Paint Marker – Red	EA	12
540-807	Valve Action Paint Marker – White	EA	12
540-808	Valve Action Paint Marker – Yellow	EA	12

PAINTS AND PRIMERS

General Purpose Spray Paint

New, more complete line of professional quality fast drying spray paints. Color code compressors or refrigerant recovery cylinders to match standard refrigerant identifying colors. Touch up equipment housings. Product meets most recent VOC legislation and is currently compliant.



CATALOG NO.	DESCRIPTION	UOM	ORDER MULTIPLE
799-001	Spray Paint – Gloss Black – 12 oz.	EA	6
799-002	Spray Paint – Flat Black – 12 oz.	EA	6
799-003	Spray Paint – Gloss White – 12 oz.	EA	6
799-004	Spray Paint – Flat White – 12 oz.	EA	6
799-005	Spray Paint – Dark Machinery Gray – 12 oz.	EA	6
799-006	Spray Paint – Gray Primer – 12 oz.	EA	6
799-010	Spray Paint – Orange – 12 oz.	EA	6
799-011	Spray Paint – Aluminum (Silver) – 12 oz.	EA	6
799-012	Spray Paint – Zinc Rich Primer – 14 oz.	EA	6

Industrial Enamel

Finally an aerosol paint that sprays in any direction without clogging. We guarantee it! Dries tack free in 10 to 20 minutes; fully dry in just one hour. Excellent corrosion and solvent resistance. Resists heat up to 250°F. Now in 20 oz. cans. Product meets most recent VOC legislation and is currently compliant.



CATALOG NO.	DESCRIPTION	UOM	ORDER MULTIPLE
799-021	Industrial Enamel – Flat Black – 12 oz.	EA	6
799-022	Industrial Enamel – Gloss White – 12 oz.	EA	6
799-024	Industrial Enamel – Machinery Light Gray – 12 oz.	EA	6
799-025	Industrial Enamel – Aluminum – 12 oz.	EA	6

High Heat Spray Paint

An ultra high temperature coating formulated to resist temperatures up to 1300°F. Great for use on boilers, furnaces, steam pipes, chimney collars, compressors and engine manifolds. Product meets most recent VOC legislation and is currently compliant.



CATALOG NO.	DESCRIPTION	UOM	ORDER MULTIPLE
799-040	High Heat Spray Paint – Aluminum – 12 oz.	EA	6
799-041	High Heat Spray Paint – Black – 12 oz.	EA	6

SAFETY SUPPLIES, DEVICES

Cut Resistant Gloves

The 540-42545 coated safety gloves are made of ultra-high molecular weight polyethylene (UHMWPE) yarn with nylon and stretch fiber, which provide both cut resistance and a comfortable fit. They are rated with ANSI Level 2 / EN388 Level 3 Cut Resistance and CPPT = 686 grams. This glove is designed for protection against minor hand lacerations and abrasions. The 540-98237 coated safety gloves are made of ultra-high molecular weight polyethylene (UHMWPE) fiber, spun with glass, stainless steel and spandex. They offer ANSI Level 4 / EN388 Level 5 Cut Resistance and CPPT = 2,085 grams. It is great for industrial tasks that require protection against hand lacerations.

CATALOG NO.	DESCRIPTION	UOM	ORDER MULTIPLE
540-42545	Cut Resistant Glove, Level 3, Large, Black/White Color	PK	1
540-98237	Cut Resistant Glove, Level 5, Large, Black & Salt & Pepper Color	PK	1

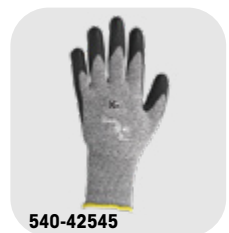

SAFETY SUPPLIES, DEVICES cont'd

Latex Gloves

Disposable natural latex rubber which provide a natural feel and grip. Powdered.



23010

CATALOG NO.	DESCRIPTION	UOM	ORDER MULTIPLE
23010	Latex Gloves, pack of 50 pairs	PK	1

Nitrile Gloves

Foam control gloves for industrial use that provide a high level of wet and dry grip. Standard in applications where tactile sensitivity is required.



540-1005L

CATALOG NO.	DESCRIPTION	UOM	ORDER MULTIPLE
540-1005L	Nitrile Gloves - Large, 1 pair per pack	EA	1

Heavy Duty Work Gloves

Your choice of durable work gloves. Washable, breathable, and durable for everyday use.



540-HU1L

CATALOG NO.	DESCRIPTION	UOM	ORDER MULTIPLE
540-HU1L	Heavy Utility Gloves - Large, 1 pair per pack	PK	1

Nitrile Disposable Gloves

Better puncture resistance than latex or vinyl. Superb tensile strength. Powder free to not compromise adhesive seals or fresh paint. Latex free alternative for latex-sensitive workers. Great barrier protection. Textured for a reliable grip, wet or dry. 9" cuff. Oil resistant.



NG-MCL-6

CATALOG NO.	DESCRIPTION	UOM	ORDER MULTIPLE
NG-MCM-35	Nitrile Gloves, Medium, Powder Free, 3.5mil Pack of 100	PK	10
NG-MCL-35	Nitrile Gloves, Large, Powder Free, 3.5mil Pack of 100	PK	10
NG-MCXL-35	Nitrile Gloves, X-Large, Powder Free, 3.5mil Pack of 100	PK	10
NG-MCM-6	Nitrile Gloves, Medium, Powder Free, 6mil Pack of 100	PK	10
NG-MCL-6	Nitrile Gloves, Large, Powder Free, 6mil Pack of 100	PK	10
NG-MCXL-6	Nitrile Gloves, XLarge, Powder Free, 6mil Pack of 100	PK	10

Leather Work Gloves

Versatile leather work gloves ideal for many industrial jobs. These leather work gloves offer: wing thumb pattern, continuous pull patch, seamless full leather index finger, leather knuckle strap, leather finger tips with elastic gather on back. Generously sized for a good working fit.

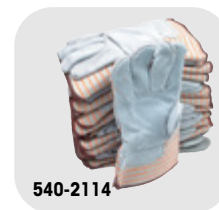

540-2114

CATALOG NO.	DESCRIPTION	UOM	ORDER MULTIPLE
540-2114	Leather Glove w/Safety Cuff, 1 pair per pack	EA	12

ShuBee® Shoe Covers

Designed specifically for the service industry professionals. Strong and made of breathable, cloth-like material. Fit up to a size 18 work boot. Come in dispenser boxes and are easy to use.



SC-BRSHU

CATALOG NO.	DESCRIPTION	UOM	ORDER MULTIPLE
SC-WPSHU	ShuBee® Dark Blue Shoe Waterproof Covers, 17 in. x 8 in., pack of 40 pairs	PK	1

Shoe Covers

Slip these shoe covers on in seconds to protect carpet, tile, or wood from dirt and scuff marks. Customers will appreciate your professional appearance.



SC-1

CATALOG NO.	DESCRIPTION	UOM	ORDER MULTIPLE
SC-1	Navy Blue Shoe Covers, pack of 50 pairs	PK	1
SC-1WP	Waterproof Shoe Covers, pack of 50 pairs	PK	1
SC-1SHU	Dark Blue Shoe Covers, pack of 50 pairs	PK	1

SAFETY SUPPLIES, DEVICES cont'd

Jackson Safety G40 Foam Nitrile Coated Gloves

- 25% better productivity than leather, with excellent grip and dexterity for rough tasks
- Maintains the highest EN388 abrasion rating, even after five washes
- Better oil and industrial grease grip (almost 3x better than previous G40 nitrile gloves)
- Seamless knit nylon back for comfort, available in a variety of sizes (ranging from Medium up to 2 Extra Large)
- Pack of 12 Pairs



CATALOG NO.	DESCRIPTION	UOM	ORDER MULTIPLE
G-NCM	Jackson Safety G40 Foam Nitrile Coated Gloves, PK Medium, 12 pairs per pack		1
G-NCL	Jackson Safety G40 Foam Nitrile Coated Gloves, PK Large, 12 pairs per pack		1
G-NCXL	Jackson Safety G40 Foam Nitrile Coated Gloves, PK X-Large, 12 pairs per pack		1
G-NC2XL	Jackson Safety G40 Foam Nitrile Coated Gloves, PK 2X-Large, 12 pairs per pack		1

Box Handler Gloves

Washable, breathable, and durable for everyday use.



CATALOG NO.	DESCRIPTION	UOM	ORDER MULTIPLE
540-BH1L	Box Handler Gloves - Large, 1 pair per pack	PK	6

Masks

Pleated Mask - 5-500M

- 3-Ply Medical Style Pleated Mask
- Non-Sterile, General Purpose Use
- Splash Proof Inner Layer
- Behind the Ear Attachment

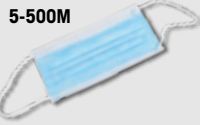

KN95 Mask-5 - 500KN

- Particle Filtering Efficiency (PFE) ≥ 95% of 0.3 Micron Particles
- 5-Layer Protection of High-Quality Non-Woven Fabric, Hot Air Cotton and Melt Blown Fabric
- Adjustable Nose Clip Seals and Prevents Fogging
- Dual Elastic Ear-loop Secures Mask to Face
- Not a NIOSH Approved Respirator



CATALOG NO.	DESCRIPTION	UOM	ORDER MULTIPLE
5-500M	Pleated Masks, pack of 50	PK	1
5-500KN	KN95 Masks, pack of 50	PK	1

First Aid Kits

10 and 25-unit first aid kits packaged in economy plastic boxes to assist when industrial accidents occur.



CATALOG NO.	DESCRIPTION	UOM	ORDER MULTIPLE
FAK-10	10-Unit First Aid Kit	EA	1
FAK-25	25-Unit First Aid Kit	EA	1

Jackson Safety G40 Latex Coated Gloves

- Breathable cotton back for comfort; Silicone-free
- Crinkled latex coating for excellent grip
- Highest EN388 tear resistance rating; Excellent durability
- Separate right and left gloves in a pair for a snug fit
- Pack of 12 pairs



CATALOG NO.	DESCRIPTION	UOM	ORDER MULTIPLE
G-LCM	Jackson Safety G40 Latex Coated Gloves, Medium, 12 pairs per pack	PK	1
G-LCL	Jackson Safety G40 Latex Coated Gloves, Large, 12 pairs per pack	PK	1
G-LCXL	Jackson Safety G40 Latex Coated Gloves, X-Large, 12 pairs per pack	PK	1
G-LC2XL	Jackson Safety G40 Latex Coated Gloves, 2X-Large, 12 pairs per pack	PK	1

Jackson Safety V30 Nemesis Safety Glasses

- Feature a sporty, flexible, lightweight design that your employees will be happy to wear; they have a stylish, sporty look and feel
- Meets ANSI Z87.1+ standards for personal eye protection
- Polycarbonate lenses provide 99.9% UVA/UVB/UVC protection
- Patented FLEX-DRY designed to be extremely flexible, to channel sweat away from the eyes, and to help prevent slippage down the nose - all for long-term comfort

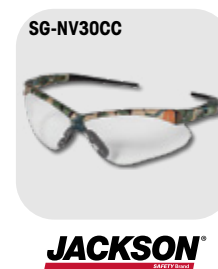

CATALOG NO.	DESCRIPTION	UOM	ORDER MULTIPLE
SG-NV30CC	Jackson Safety V30 Nemesis Safety Glasses - Clear Anti-Fog Lenses with Camo Frame, Case/12	CS	1
SG-NV30CB	Jackson Safety V30 Nemesis Safety Glasses - Smoke Anti-Fog Lenses with Camo Frame, Case/12	CS	1
SG-NV30BC	Jackson Safety V30 Nemesis Safety Glasses - Clear Lenses with Black Frame, Case/12	CS	1
SG-NV30B	Jackson Safety V30 Nemesis Safety Glasses - Clear Anti-Fog Lenses with Black Frame, Case/12	CS	1

Hand Warmer

Air-activated hand warmers deliver hours of warmth and relief from cold weather. Once the package is opened, an exothermic reaction begins providing an effective defense against the winter cold.



CATALOG NO.	DESCRIPTION	UOM	ORDER MULTIPLE
HW-10P	Hand Warmer, pack of 10	PK	1

SEALANT, EPOXY, GLUE

Thread Sealant with PTFE

General purpose sealant with the lubricity of PTFE for metal pipes. Won't shred like PTFE Tape. Allows easy disassembly. Resists common shop fluids. 60° to 400°F temp. resistance. Pressure resistance of 5000 PSI.



CATALOG NO.	DESCRIPTION	UOM	ORDER MULTIPLE
7-80632	Thread Sealant – 1/4 Pint Brush Can	EA	12
7-80633	Thread Sealant – 1 Pint Brush Can., 12 per pack	EA	12

Wagner Adhesive Sealant

For refrigerant sealing. Eliminates fastener loosening, leakage, and corrosion. Cures between thread flanks to seal against leakage and prevents thread corrosion. Offers sealing with maximum solvent resistance to the action of refrigerant (11, 12 and 22), ammonia and sulfur dioxide. Withstands corrosive liquids used in metal finishings and process industries. Ideal sealant for refrigeration, A/C, and process equipment using corrosive chemicals.



CATALOG NO.	DESCRIPTION	UOM	ORDER MULTIPLE
CAS-2712	Wagner Adhesive Sealant – 0.34 fl. oz.	EA	12

Super Glue

This adhesive can be used on dirty, greasy surfaces and the medium viscosity penetrates into preassembled and close fitting parts. It can be used on aluminum, metal, rubber, and most plastics for most tough jobs.



CATALOG NO.	DESCRIPTION	UOM	ORDER MULTIPLE
DEP052	Super Glue – 2 Gram Tube	EA	12

Fast Cure Epoxy

An easy-to-use, two part putty you simply mix and mold like clay. No complicated weighing or measuring required. Easy 1:1 cut-what-you-need mix ratio. Form it into any shape. It hardens in one hour and makes a final, steel-hard cure in 12 hours and can be sanded, drilled, machined, sawed and painted. Use on metal, wood, brick, stone, concrete, fiberglass, porcelain, tile and most plastics. Cures under water. 1.0 lb.

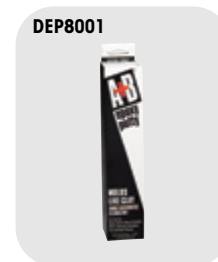

CATALOG NO.	DESCRIPTION	UOM	ORDER MULTIPLE
DEP8001	Gray Epoxy Putty – 1 lb. Kit	EA	24
DEP8002	White Epoxy Putty – 1 lb. Kit	EA	24

J-B Weld

The world's finest cold-weld compound for use when welding or soldering is out of the question due to cost, down time for repairs, or technical or environmental considerations. A remarkably easy, convenient, and inexpensive alternative to welding, soldering, and brazing. Literally pennies per use.



CATALOG NO.	DESCRIPTION	UOM	ORDER MULTIPLE
JB8265	J-B Weld 2 Part Epoxy	EA	6

SEALING COMPOUNDS, ADHESIVE

Flexi-Patch™

Flexi-Patch™ is an easy to use flexible repair patch ideal for repairing almost any surface. It cures quickly using only UV light from sunlight or a UV flashlight for a long lasting, permanent repair. Flexi-Patch is a fiberglass-reinforced polyester ideal for use on PVC, plastics, metal, wood, concrete and more. It's the easy way to permanently patch almost any surface. It dries hard for permanent repair. Can be drilled, tapped and painted once dry.



CATALOG NO.	DESCRIPTION	UOM	ORDER MULTIPLE
FP-36	Flexi-Patch fiberglass patch	EA	20

Foam Sealant – One Component

One component closed-cell expanding polyurethane foam sealant for lineal caulking applications. Air-moisture cure. Tack free in 20 minutes; fully cured in 12 hours. Paintable. Use for insulating and sealing around windows, doors, pipes, ducts and vents. Non-toxic when cured. Paint to protect from UV exposure. "R" value 4.7 (1" thickness). Foam contains fire retarding chemical and is U.L. Listed but not rated as a firestop product. Environmental concerns have led us to replace CFC's and HCFC's with hydrocarbon material in our one component foam products. See instructions on each product to ensure safe use and quality results.



CATALOG NO.	DESCRIPTION	UOM	ORDER MULTIPLE
01714	Foam Sealant – 12 oz. Can – Yields 275' (3/8" bead)	EA	12
01724	Foam Sealant – 20 oz. Can – Yields 460' (3/8" bead)	EA	12

SEALING COMPOUNDS, ADHESIVE cont'd

Firestop Products for Class A Buildings

U.L. Classified. Code Approved. Seal penetrations of plumbing, refrigeration and AC lines, ducts, vents and electrical cable through fire-rated floors, walls and ceilings. Easy-to-use, non-shrinking, non-toxic and permanently flexible. Blocks fire, gas, smoke, air and water migration. Use ceramic fiber filler together with putty or caulk for thick penetrations. Technical bulletins available.



CATALOG NO.	DESCRIPTION	UOM	ORDER MULTIPLE
16491	Firestop Caulk – Red – 10.3 fl. oz. cartridge	EA	12

Caulk Gun

Caulk guns can be used to hold the sealant to seal duct work.



CATALOG NO.	DESCRIPTION	UOM	ORDER MULTIPLE
7-100	Caulk Gun – Super Ratchet Type	EA	12
7-200	Caulk Gun – Standard Duty	EA	1

High Temp Red Silicone Sealant

A one part non-slumping paste that cures to a tough, rubbery solid at room temperature. Formulated to perform at temperatures ranging from -85°F to 500°F for continuous operation, and to 600°F for intermittent exposure. Tack free cure time – 15 minutes. Full cure time – 24 hours.



CATALOG NO.	DESCRIPTION	UOM	ORDER MULTIPLE
7-4300	High Temp Red Silicone Sealant – 10.1 oz. Cartridge	EA	12

25 Year Acrylic Latex Painter's Caulk

For both interior and exterior use. DiversiTech's 25 Year Acrylic Latex Painter's Caulk forms a tough, paintable resilient bond to all building material surfaces. Excellent resistance to water, weathering and moisture vapor.



CATALOG NO.	DESCRIPTION	UOM	ORDER MULTIPLE
7-4500	White Acrylic Latex Caulk – 10.1 oz. Cartridge	EA	12
7-4400	Clear Acrylic Latex Caulk – 10.1 oz. Cartridge	EA	12

Pro-Air Industrial Grade Spray Adhesive

A clear, pressure sensitive aerosol adhesive with exceptional tack and shear strength characteristics. An excellent choice for most permanent adhesive applications: duct liner and wrap, sheet aluminum, fiberglass insulation board, and much more. The aerosol package offers a specially designed web spray pattern for even, controlled distribution. Flammability meets aerosol flame extension test requirements. Coverage is approximately 90-100 square feet per pound.



CATALOG NO.	DESCRIPTION	UOM	ORDER MULTIPLE
GP1-40BL	Pro-Air Spray Adhesive – 38 lb. Disposable Cylinder	EA	1
GN-23H	Spray Gun	EA	1

DiversiGum Sealing Compound

Non-hardening. For plugging openings through foundations or around refrigeration tube entry.



CATALOG NO.	DESCRIPTION	UOM	ORDER MULTIPLE
6-202-1	DiversiGum Sealing Compound – 1 lb. Slug	EA	24
6-202-2	DiversiGum Sealing Compound – 2 lb. Slug	EA	20
AG-25	DiversiGum Sealing Compound – 3/8" x 25' Caulking Cord	EA	12

Silicone Sealant

Food grade 100% RTV Silicone Sealant. Can be used in applications for continuous use to 450°F. UV and water resistant. Long-term flexibility. Non-paintable. Available in 10.3 fl. oz. tube for use in standard caulk gun or in 3 fl. oz. squeeze tube.



CATALOG NO.	DESCRIPTION	UOM	ORDER MULTIPLE
7-4000	Clear Silicone Sealant – 10.3 fl. oz. Tube	EA	12
7-4001	Clear Silicone Sealant – 3 fl. oz. Squeeze Tube	EA	48
7-4100	White Silicone Sealant – 10.3 fl. oz. Tube	EA	12
7-4200	Aluminum Silicone Sealant – 10.3 fl. oz. Tube	EA	12
7-80045	Pipe Joint Compound – 6 fl. oz. Tube	EA	12

Pro-Air Duct Sealant – UL 181 AM-BM Listed

Water-based fiber-reinforced duct sealant/mastic formulated for indoor/outdoor use. Meets U.L. Class 1 rating and local codes while featuring long term flexibility and strength. Use on metal heating, ventilating, and A/C duct systems; as well as fiberglass duct board systems and flex duct systems. Recommended for use to 10" of water column pressure without the need for fiberglass mesh reinforcement.



CATALOG NO.	DESCRIPTION	UOM	ORDER MULTIPLE
800-008	Pro-Air Duct Sealant – 1/10 Gallon Tube – 10.5 oz.	EA	12
800-009	Pro-Air Duct Sealant – 1 Gallon Pail	EA	4

Black Jack® Roof Cement

Black Jack® All-Weather Roof Cement is an asphalt based patching compound designed to repair cracks, splits, seams and holes in roofing materials. It also works great in new construction and in setting flashings, drip edges and roofing material edges.

- Use in wet or dry conditions
- Seals flashings, and other roof projections
- Fiber reinforced
- Thick trowel grade



CATALOG NO.	DESCRIPTION	UOM	ORDER MULTIPLE
RM-1G	Black Jack® All Weather Roof Cement – 1 gallon	EA	6
RM-10	Black Jack® All Weather Roof Cement – 10 oz. tube	EA	12

SHEET METAL SCREWS

Masonry Bit

This bit is suitable for brick, tile, slate, cement, and cinder block. This bit is a nice addition to the toolbox.



CATALOG NO.	DESCRIPTION	UOM	ORDER MULTIPLE
540-DB6	Masonry Bit – 3/16" x 6"	EA	1

Anchor Kit

Plastic anchor kit for sheet rock applications. Kit includes 100 anchors, screws and 1 masonry bit.



CATALOG NO.	DESCRIPTION	UOM	ORDER MULTIPLE
540-AK100	Anchor size 1/4 x 1, Screw Size 10 x 1-1/4 HWH Head Size 5/16 hex	EA	1

Sheet Metal Screws – Drill Point

Self-drilling, self-tapping. Hex washer head. Produces the optimum hole size, resulting in a tighter fit. Made from special heat treated steel for extra strength. Packaged in resealable plastic cartons.



CATALOG NO.	DESCRIPTION	HEAD SIZE	UOM	ORDER MULTIPLE
5-SCR61-2DP	6 x 1/2 Drill Point, pack of 1,000	1/4"	PK	1
5-SCR61-2DPBULK	6 x 1/2 Drill Point – Bulk, pack of 15,000	1/4"	PK	1
5-SCR81-2DP	8 x 1/2 Drill Point, pack of 1,000	1/4"	PK	1
5-SCR81-2DPBULK	8 x 1/2 Drill Point – Bulk, pack of 10,000	1/4"	PK	1
5-SCR83-4DP	8 x 3/4 Drill Point, pack of 500	1/4"	PK	1
5-SCR83-4DPBULK	8 x 3/4 Drill Point – Bulk, pack of 10,000	1/4"	PK	1
5-SCR81DP	8 x 1 Drill Point, pack of 500	1/4"	PK	1
5-SCR81DPBULK	8 x 1 Drill Point – Bulk, pack of 7,500	1/4"	PK	1
5-SCR101-2DP	10 x 1/2 Drill Point, pack of 500	5/16"	PK	1
5-SCR101-2DPBULK	10 x 1/2 Drill Point – Bulk, pack of 10,000	5/16"	PK	1
5-SCR103-4DP	10 x 3/4 Drill Point, pack of 500	5/16"	PK	1
5-SCR103-4DP100	10 x 3/4 Drill Point, pack of 100	5/16"	PK	1
5-SCR103-4DPBULK	10 x 3/4 Drill Point – Bulk, pack of 5,000	3/4"	PK	1
5-SCR101DP	10 x 1 Drill Point, pack of 500	5/16"	PK	1
5-SCR101DPBULK	10 x 1 Drill Point – Bulk, pack of 5,000	5/16"	PK	1
5-SCR101-12DP	10 x 1-1/2 Drill Point, pack of 250	5/16"	PK	1
5-SCR101-12DPBULK	10 x 1-1/2 Drill Point – Bulk, pack of 3,500	5/16"	PK	1
5-SCR102DP	10 x 2 Drill Point, pack of 350	5/16"	PK	1
5-SCR102DPBULK	10 x 2 Drill Point – Bulk, pack of 2,500	5/16"	PK	1

Masonry Screw

This product comes in a pack of 250 and is suitable for brick, tile, slate, cement, and cinder block. The screws are a nice addition to the toolbox.



CATALOG NO.	DESCRIPTION	UOM	ORDER MULTIPLE
5-SCRMS	Masonry Screw – 1/4" x 1-1/4", pack of 250	PK	1

Sheet Metal Screws – Taper Point

Hex washer slotted head. Burr-free. Full 5/16" head will not strip out of hex driver opening. Heat treated tapered point will not break or "walk". Packaged in resealable plastic cartons.



CATALOG NO.	DESCRIPTION	UOM	ORDER MULTIPLE
5-SCR63-8	6 x 3/8 Taper Point, pack of 1,000	PK	1
5-SCR63-8BULK	6 x 3/8 Taper Point – Bulk, pack of 20,000	PK	1
5-SCR71-2	7 x 1/2 Taper Point, pack of 1,000	PK	1
5-SCR71-2BULK	7 x 1/2 Taper Point – Bulk, pack of 15,000	PK	1
5-SCR81-2	8 x 1/2 Taper Point, pack of 1,000	PK	1
5-SCR81-25M	8 x 1/2 Taper Point, pack of 5,000	PK	1
5-SCR81-2BULK	8 x 1/2 Taper Point – Bulk, pack of 12,000	PK	1
5-SCR83-4	8 x 3/4 Taper Point, pack of 1,000	PK	1
5-SCR83-4BULK	8 x 3/4 Taper Point – Bulk, pack of 10,000	PK	1
5-SCR81	8 x 1 Taper Point, pack of 500	PK	1
5-SCR81BULK	8 x 1 Taper Point – Bulk, pack of 7,500	PK	1
5-SCR81-12	8 x 1-1/2 Taper Point, pack of 250	PK	1
5-SCR81-12-100	8 x 1-1/2 Taper Point, pack of 100	PK	1
5-SCR81-12W	8 x 1-1/2 Taper Point w/White Head, pack of 250	PK	1
5-SCR81-12BULK	8 x 1-1/2 Taper Point – Bulk, pack of 5,000	PK	1
5-SCR82-100	8 x 2 Taper Point, pack of 100	PK	1
5-SCR82	8 x 2 Taper Point, pack of 350	PK	1
5-SCR82W	8 x 2 Taper Point w/White Head, pack of 250	PK	1
5-SCR82BULK	8 x 2 Taper Point – Bulk, pack of 3,000	PK	1
5-SCR103-4	10 x 3/4 Taper Point, pack of 1,000	PK	1
5-SCR103-4BULK	10 x 3/4 Taper Point – Bulk, pack of 10,000	PK	1
5-SCR101	10 x 1 Taper Point, pack of 500	PK	1
5-SCR101-2	10 x 1/2 Taper Point, pack of 1,000	PK	1
5-SCR101BULK	10 x 1 Taper Point – Bulk, pack of 7,000	PK	1

SURFACE PROTECTION

ShuBee® Surface Liner

- Specifically for cured hardwood floors and any other hard surfaces
- Light tack adhesive to avoid residue on client's floors
- Reverse wound for easy application and clean up
- 40" x 54' - 180 square feet
- Each box contains an EZ Trim Tool for easy cutting
- Waterproof
- Padded for extra protection



CATALOG NO.	DESCRIPTION	UOM	ORDER MULTIPLE
SPT-W	Surface Liner, White, 54 ft. Roll	EA	1

WASP, HORNET, AND YELLOW JACKET KILLERS

Sting Less Wasp & Hornet Killer

Kills wasps, hornets and yellow jackets. Very fast-acting when insects are hit directly. Allow approximately 24 hours for those that were not directly hit. This container delivers a 20-foot jet blast to knock down the insects and allow for the user to remain at a safe distance.

436-20



CATALOG NO.	DESCRIPTION	UOM	ORDER MULTIPLE
436-20	Sting Less Wasp & Hornet Spray – 14 oz. Aerosol	EA	12

Wasp & Hornet Killer by ENFORCER

Enforcer's Wasp & Hornet Killer shoots a 20-foot jet blast for instant knockdown of wasps, hornets, and yellow jackets. Enforcer's Wasp & Yellow Jacket Foam is a 20-foot blast of blanketing foam that plugs yellow jacket holes and clings to wasp and hornet nests, preventing their escape.

8-WH16



8-FWH16

CATALOG NO.	DESCRIPTION	UOM	ORDER MULTIPLE
8-WH16	Enforcer Wasp & Hornet Killer – 16 oz. Aerosol	EA	12
8-FWH16	Enforcer Wasp & Yellow Jacket Foam – 16 oz. Aerosol	EA	12

DEVCO



Anchors.....	68
Boxes, Rings, and Covers.....	70-71
Cable Connectors.....	71-72
Cable Ties and Accessories.....	72-73
Conduit Fittings.....	73-74
DEVCO Racks Master Item List (By Racks).....	60-61
General Tools.....	74
High Temperature Solderless Terminals.....	66
Nuts and Bolts.....	75-76
Plan-O-Gram for DEVCO Elec Rack.....	57
Plan-O-Gram for DEVCO Ezc Rack.....	58
Plan-O-Gram for DEVCO Combo Rack.....	59
Plastic Anchor Kits.....	69
Power Cords and Work Lights.....	76
Screws.....	76
Slip-On Solderless Terminals.....	62-63
Special Purpose Solderless Terminals.....	63-64
Specialty Fasteners.....	77
Specialty Fittings.....	78
Standard Solderless Terminals.....	64-65
Storage Containers.....	78
Tapes.....	78
Terminal Kits.....	67
Testers, Leads, Clips, Fuses.....	79
Wire.....	79-80
Wiring Devices.....	80-84

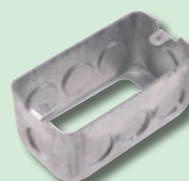

How to sell DEVCO® products

DEVCO® merchandising displays are an easy and attractive way to showcase a variety of DEVCO® products in your store. Offered in three different versions, each display rack includes everything you need to create extra sales for your business.

Easy to Display

DEVCO® provides turnkey merchandising solutions for wholesale distribution. Attractive, easy to set-up merchandising displays provide a great way to highlight DEVCO® products and make it easy for customers to find what they need. The point of sale display merchandises the products, enabling the distributor to add additional sales.

The products merchandised on the carousel are impulse buy items. The items are packed so they cost the contractor only a few dollars, and most are less than \$10 each.

Easy to Profit

DEVCO® displays provide a typical distributor branch with easy add-on sales that build profits. Each display can generate significant sales and margins for the store while providing contractors with the parts they need to finish the job. These self-service displays are a great way to increase revenue with minimal effort.

The Perfect Plan

Each DEVCO® Merchandising display comes with a complete plan-o-gram to make merchandising it simple and fast. And there are three different versions available so you can choose the display that's right for your business and customers.

And when you purchase the DEVCO® products to fill it up, the merchandising rack is **loaned free of charge.**



Display Rack	Featured Products
EZC	Solderless terminals, ground connectors, fasteners, anchor kits, cable ties, washers, hex nuts, cable clamps, sheet metal screws and hose clamps
Electrical	Ground adaptors, outlets, boxes, bushings, cable connectors, extension rings, indicator lights, plugs and connectors, receptacles, reducing washers, toggle switches and hook up wire
Combo	Solderless terminals, insulated rings, ground adaptors, covers, reducing washers, plugs and connectors, hook up wire, fasteners, hex nuts and self drilling screws

PLAN-O-GRAM FOR DEVCO ELEC RACK (MKT-POP-DEVELEC)

PANEL A

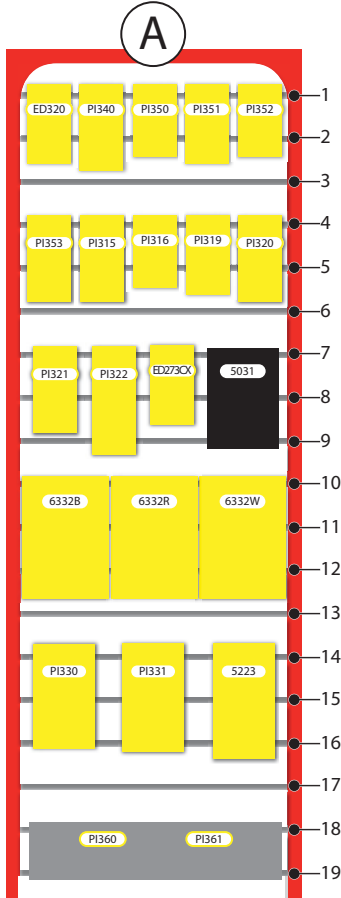

PANEL B

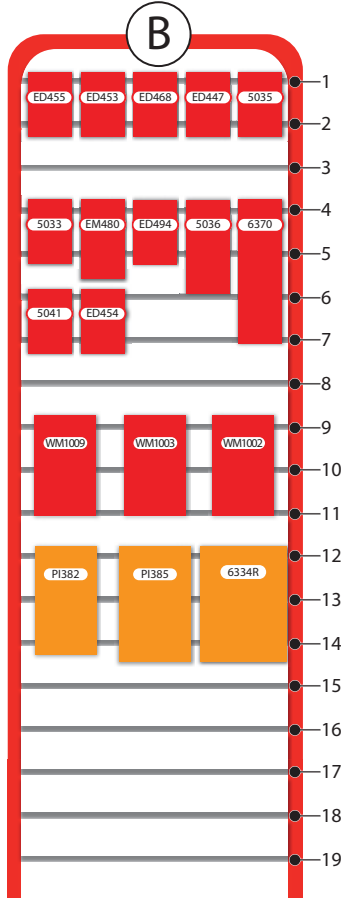

PANEL C

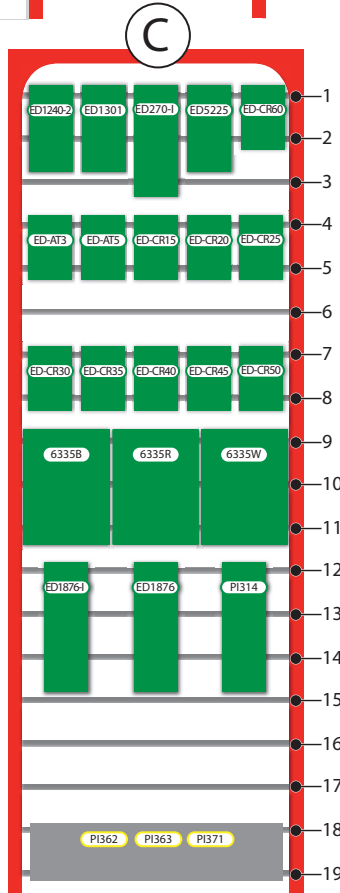

PANEL D

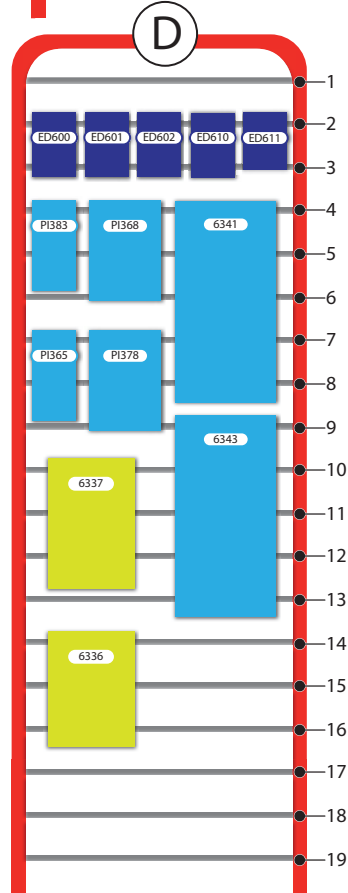

MKT-POP-DEVELEC

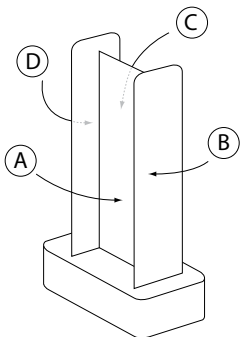

MKT-POP-DEVELEC
Merchandising Rack
72" x 22" x 20.5"

NOTE: Item numbers in **RED** indicate Made in the U.S.A.



PLAN-O-GRAM FOR DEVCO EVC RACK (MKT-POP-DEVEZC)

PANEL

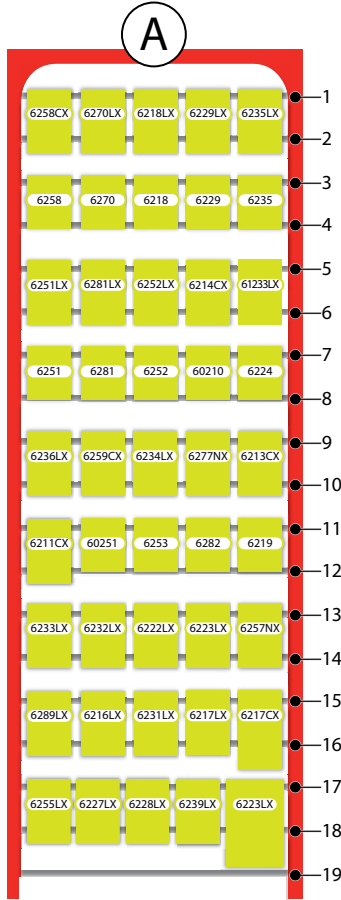

PANEL

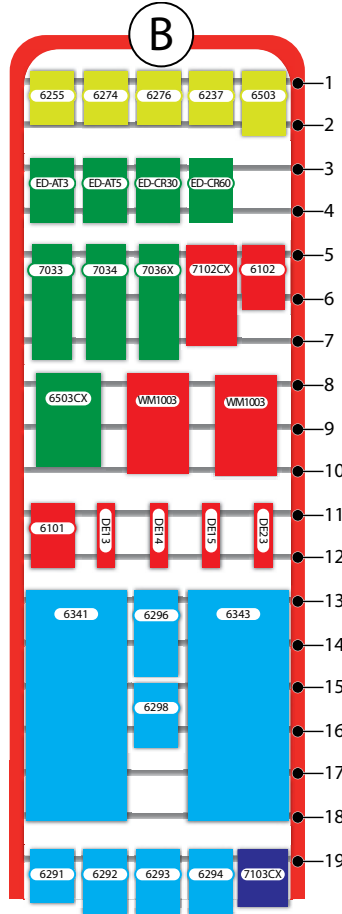

MKT-POP-DEVEZC

PANEL

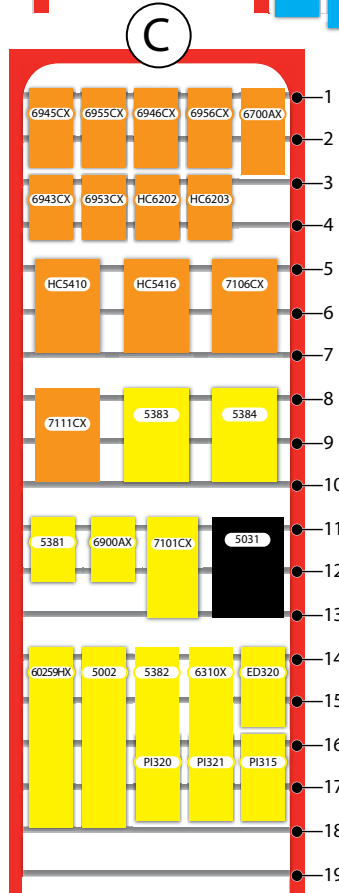

PANEL

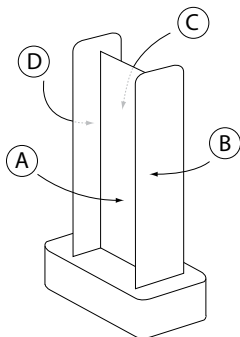
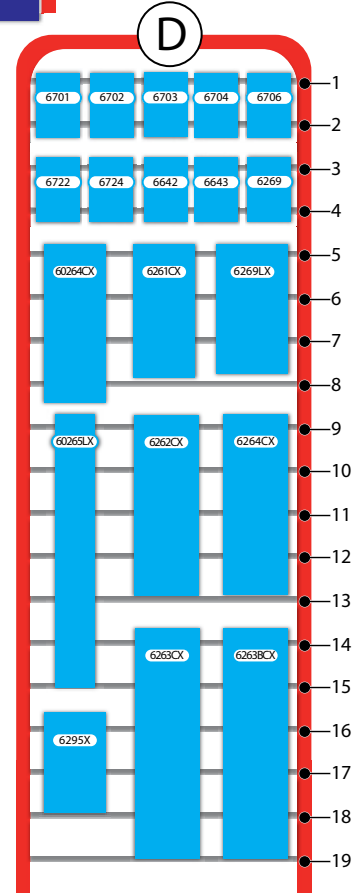

MKT-POP-DEVEZC
Merchandising Rack
72" x 22" x 20.5"



PLAN-O-GRAM FOR DEVCO COMBO RACK (MKT-POP-DEVCOMBO)

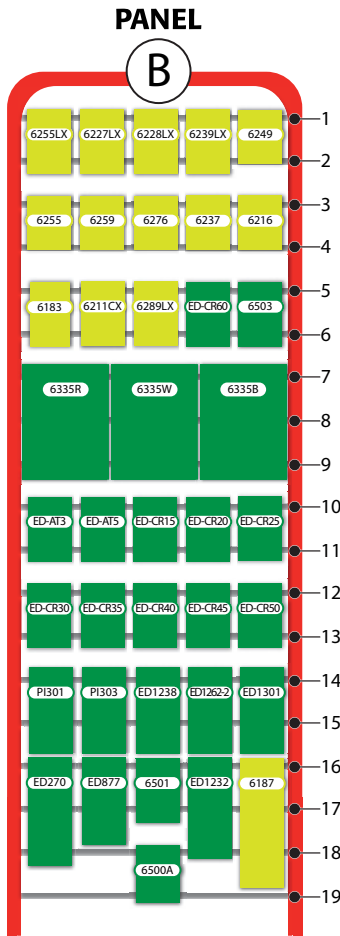
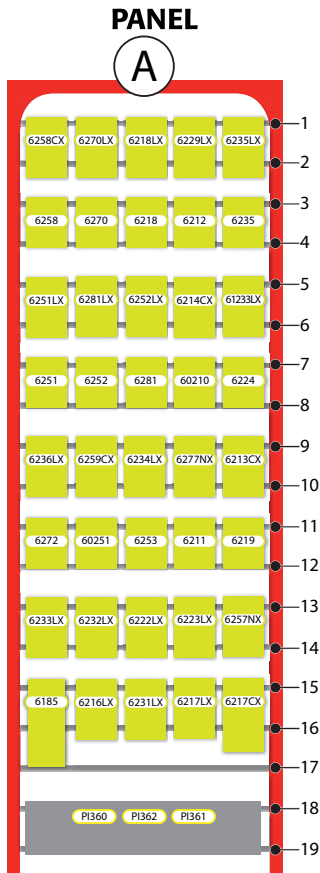

MKT-POP-DEVCOMBO

PANEL C

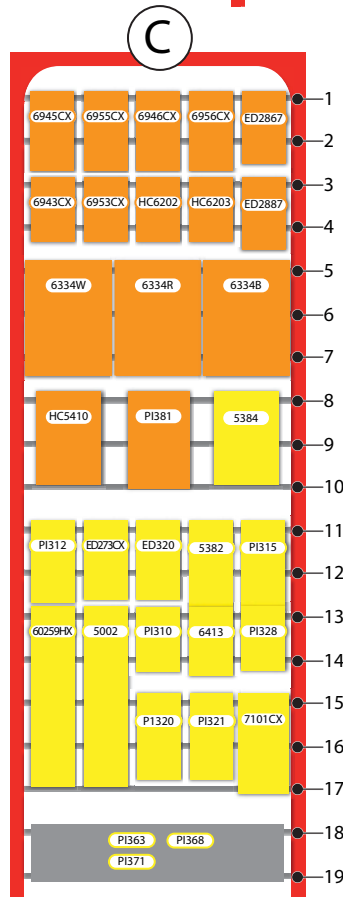

PANEL D

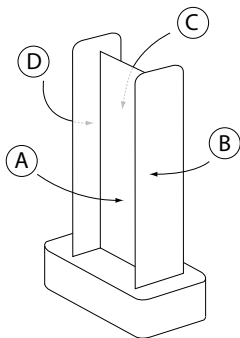
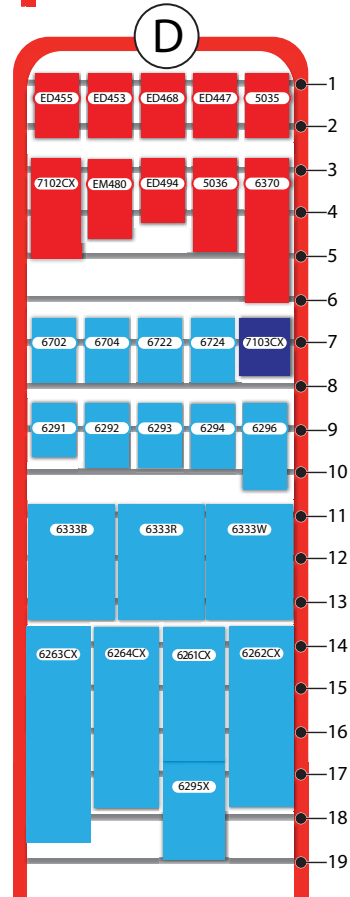

MKT-POP-DEVCOMBO Merchandising Rack
72" x 22" x 20.5"

NOTE: Item numbers in **RED** indicate Made in the U.S.A.



DEVCO RACKS MASTER ITEM LIST (BY RACK)

This DEVCO product list includes any DEVCO item that is part of the plan-o-gram display for either the EZC, ELEC or COMBO versions of the DEVCO rack. This cross reference indicates on which display rack each item should be placed.

ITEM #	ITEM DESCRIPTION	ELEC	EZC	COMBO
5002	Crimp Tool w/ Cutter & Stripper Ins.		X	X
5031	Test Leads (ins. Alligator clips) Low Voltage 22in 8pcs	X	X	
5033	Alligator Clips (steel) 2in long for probes .075in-.08in	X		
5035	Alligator Clips (copper) B&R Ins 2in long	X		X
5036	Test Clip (steel 20A) B&R Insulators 2-7/16in long	X		X
5041	Test Leads Low Voltage Hook Ty22ga 36in red & black	X		
5223	Triple Outlet 2 Pole 3 Wire 15A-125V Polarized plastic	X		
5381	Nylon Cable Clamp 1/8in I.D.		X	
5382	Nylon Cable Clamp 1/4in I.D.		X	X
5383	Nylon Cable Clamp 3/8in I.D.		X	
5384	Nylon Cable Clamp 1/2in I.D.		X	X
6900AX	Self-Drilling Screw Repair Kit		X	
6101	Motor Shaft Keys (1/8in 3/16in 1/4in 3/16in x 1/4in) zn Pltd.		X	
6102	Motor Shaft Keys (1/4insq 5/16insq 3/8insq) zn Pltd.		X	
6183	Terminal Block 20A-250V 6 pos			X
6185	Terminal Block 20A-250V 10 pos			X
6187	Terminal Block 20A-250V 14 pos			X
6211	Tab Ad. S. F Dbl M. .250 Non-Ins.			X
6212	Dbl. M. Tab Ad. . S. F . Non-Ins.			X
6216	Ring 16-14 Ins. #10 Stud			X
6218	Slip-on F 16-14 Ins. .250		X	X
6219	Slip-on M 16-14 Ins. .250		X	X
6224	Flag F QD 12-10 Non-Ins. .250		X	X
6229	Slip-on F 16-14 Full Ins. .250		X	
6235	Slip-on F 22-18 Ins. .250		X	X
6237	Spade 22-18 Ins. #8 Stud		X	X
6249	M Tab 1 pair bent 90 Non-Ins.			X
6251	Slip-on F 12-10 Ins. .250		X	X
6252	Ring 12-10 Ins. #10 Stud		X	X
6253	Ring 12-10 Ins. 1/4in Stud		X	X
6255	Spade 12-10 Ins. #10 Stud		X	X
6258	Comp. Flag F. 16-14 Non-Ins. .250		X	X
6259	Comp. Flag F. 12-10 Non-Ins. .250			X
6269	Cable Tie Mount		X	
6270	Comp. Flag F. 12-8 Non-Ins. .250		X	X
6272	Ring 16-14 Ins. #6 Stud			X
6274	Spade 16-14 Ins. #6 Stud		X	
6276	Spr. Spade 16-14 Ins. #6 Stud		X	X
6281	Slip-on F 16-14 Ins. .187		X	X
6282	Slip-on F 22-18 Ins. .187		X	
6291	Wire Connector Mini-Gray		X	X
6292	Wire Connector Tiny-Blue		X	X
6293	Wire Connector Small-Orange		X	X
6294	Wire Connector Medium-Yellow		X	X
6296	Wire Connector Large-Red		X	X
6298	Wire Connector XLarge-Gray		X	
6336	Thermostat Wire 3 Conduct.40 ft.	X		
6337	Thermostat Wire 5 Conduct.40 ft.	X		
6341	SJTO Service Cord 16 GA 20 ft.	X	X	
6343	SJTO Service Cord 14 GA 20 ft.	X	X	
6370	Heat Shrink Tubing Assort. B&W 1/8in & 1/4in supplied 6in	X		X
6413	Fin. Hex Nut 1/4in-20 zn Pltd.			X
6501	Fin. Hex Nut 1/4in-20 zn Pltd.		X	X
6503	Fin. Hex Nut 3/8in-16 zn Pltd.		X	X
6642	HH Cap Screw 3/8in-16 x 1in		X	
6643	HH Cap Screw 3/8in-16 x1 1/2in		X	
6701	Flat Washer 3/16in Uss zn Pltd.		X	
6702	Flat Washer 1/4in Uss zn Pltd.		X	X

ITEM #	ITEM DESCRIPTION	ELEC	EZC	COMBO
6703	Flat Washer 5/16in Uss zn Pltd.		X	
6704	Flat Washer 3/8in Uss zn Pltd.		X	X
6706	Flat Washer 1/2in Uss zn Pltd.		X	
6722	Fender Washer 1/4in zn Pltd.		X	X
6724	Fender Washer 3/8in zn Pltd.		X	X
7033	Toggle Bolt w/wing 3/16inx4inzn Pltd.		X	
7034	Toggle Bolt w/wing 1/4inx4in zn Pltd.		X	
60210	Tab Ad. Ins. .250 16-14 multi stack male & female		X	X
60251	Slip-On F 12-10 Non-Ins. .250		X	X
60259HX	Comp. Lead Kt 12in 10ga wire		X	X
60264CX	Cable Tie 6in w/ #8 Hole 30# 1-3/8in B. Dia nat 100/PK		X	
60265LX	Cable Tie 14in 50# 4in B. Dia natural 50 pcs		X	
61233LX	Slip-on M & F 16-14 .250 Full Ins Nylon 50 pcs		X	X
6211CX	Tab Ad. S. F Dbl M Non-Ins.100 pcs		X	X
6213CX	Flag F QD 16-14 Non-Ins. .250 100 pcs		X	X
6214CX	Slip-on F 16-14 Non-Ins. .250 100 pcs		X	X
6216LX	Ring 16-14 Ins. #10 Stud 50 pcs		X	X
6217CX	Butt Conn. 16-14 Ins. 100 pcs		X	X
6217LX	Butt Conn. 16-14 Ins. 50 pcs		X	X
6218LX	Slip-on F 16-14 Ins. .250 50 pcs		X	X
6222LX	Dead End Conn. 22-14 Fully Ins. 50 pcs		X	X
6223LX	Dead End Conn. 18-10 Fully Ins. 50 pcs		X	X
6227LX	Spade 16-14 Ins. #8 Stud		X	X
6228LX	Spade 16-14 Ins. #10 Stud 50 pcs		X	X
6229LX	Slip-on F 16-14 Full Ins. .250		X	X
6231LX	Butt Conn. 12-10 Ins. 50 pcs		X	X
6232LX	Butt Conn. 22-18 Ins. 50 pcs		X	X
6233LX	Slip-on F 16-14 .250 Full Ins. Nylon 50 pcs		X	X
6234LX	Slip-on M 16-14 .250 Full Ins. Nylon 50 pcs		X	X
6235LX	Slip-on F 22-18 Ins. .250 50 pcs		X	X
6236LX	Ring 22-18 Ins. #8 Stud 50 pcs		X	X
6239LX	Spr. Spade 16-14 Ins. #8 Stud		X	X
6251LX	Slip-on F 12-10 Ins. .250		X	X
6252LX	Ring 12-10 Ins. #10 Stud		X	X
6255LX	Spade 12-10 Ins. #10 Stud 50 pcs		X	X
6257NX	Ring #8 Ins. 1/4in Stud 25 pc		X	X
6258CX	Comp. Flag F. 16-14 Non-Ins. .250 100 pcs		X	X
6259CX	Comp. Flag F. 12-10 Non-Ins. .250 100 pcs		X	X
6261CX	Cable Tie 6in 18# 1-3/8in B. Dia natural 100 pcs		X	X
6262CX	Cable Tie 7-1/2in 50# 1-3/4in B. Dia natural 100 pcs		X	X
6263CX	Cable Tie 11in 50# 3in B. Dia natural 100 pcs		X	X
6263BCX	Cable Tie 11in 50# 3in B. Dia black 100 pcs		X	
6264CX	Cable Tie 7in w/ #10 Hole 50# 1-3/4in B. Dia nat 100/PK		X	X
6269LX	Cable Tie Mount 50 pcs		X	
6270LX	Comp. Flag F. 12-8 Non-Ins. .250 50 pcs		X	X
6277NX	Flag F QD 16-14 .250 Fully Ins. Nylon 25 pcs		X	X
6281LX	Slip-on F 16-14 Ins. .187 50 pcs		X	X
6289LX	Bullet Plug & Rec. 16-14 Ins. 50 pcs		X	X
6295X	Assorted Wire Connectors		X	X
6310X	Grease Fitting Assortment box		X	
6332B	Hook-up Wire 16ga blk. 48 ft	X		
6332R	Hook-up Wire 16ga red. 48 ft	X		
6332W	Hook-up Wire 16ga wht. 48 ft	X		
6333B	Hook-up Wire 14ga blk. 48 ft			X
6333G	Hook-up Wire 14ga grn. 48 ft			
6333R	Hook-up Wire 14ga red. 48 ft			X
6333W	Hook-up Wire 14ga wht. 48 ft			X
6334B	Hook-up Wire 12ga blk. 48 ft			X

continued

DEVCO RACKS MASTER ITEM LIST (BY RACK) cont'd

ITEM #	ITEM DESCRIPTION	ELEC	EZC	COMBO
6334R	Hook-up Wire 12ga red 48 ft	X		X
6334W	Hook-up Wire 12ga wht. 48 ft			X
6335B	Hook-up Wire 10ga blk. 48 ft	X		X
6335R	Hook-up Wire 10ga red 48 ft	X		X
6335W	Hook-up Wire 10ga wht. 48 ft	X		X
6500A	Asst Mach. Screw Hex Nuts 6-32 8-32 10-32 zn Pltd.			X
6503CX	Fin. Hex Nut 3/8in-16 zn Pltd. 100 pcs		X	
6700AX	Flat Washer Assortment Pack 3/16 1/4 5/16 3/8 1/2 5/8 inch		X	
6943CX	Self Drilling Screw #8x1/2in 1/4in Hex Head zn Pltd. 100/PK	X	X	
6945CX	Self Drilling Screw #8x3/4in 1/4in Hex Head zn Pltd. 100/PK	X	X	
6946CX	Self Drilling Screw #8x1in 1/4in Hex Head zn Pltd. 100/PK	X	X	
6953CX	Drill Tip Screw #10x1/2in 5/16in Hex Head 100/PK	X	X	
6955CX	Drill Tip Screw #10x3/4in 5/16in Hex Head 100/PK	X	X	
6956CX	Self Drilling Screw #10x1in 5/16in Hex Head zn Pltd. 100/PK	X	X	
7036X	Toggle Bolt w/wing 3/8inx4in zn Pltd.		X	
7101CX	Anch Kit Yellow #8x1in w 3/16in bit 100 s + 100 a		X	X
7102CX	Anch Kit Red #10x1-1/4in w 1/4in bit 100 s + 100 a		X	X
7103CX	Anch Kit Blue #4x3/4in w 5/32in bit 100 s + 100 a		X	X
7106CX	Plug Anchor Kit Green #10x1in 1/4in bit 100 s + 100 a bag		X	
7111CX	Plug Anchor Kit Blue #14x1in w 5/16in bit 100 s + 100 a bag		X	
DE13	Magnetic Hex Chuck 1/4in x 1-3/4in		X	
DE14	Magnetic Hex Chuck 5/16in x 1-3/4in		X	
DE15	Magnetic Hex Chuck 3/8in x 1-7/8 in		X	
DE23	Magnetic Hex Chuck 1/4in x 2-9/16 in		X	
ED1232	Toggle Switch D.P. 30A-120/277V brown			X
ED1238	Toggle Switch S.P. 20A-120/277V brown			X
ED1240-2	Toggle Switch S.P. 15A-120/277V brown	X		
ED1262-2	Toggle Switch D.P. 15A-120/277V brown			X
ED1301	Toggle Switch S.P. 15A-120V brown	X		X
ED1876	Single Receptacle 20A-250V 2 pl. 3 wr. brown	X		
ED1876-I	Single Receptacle 20A-250V 2 pl. 3 wr. ivory	X		
ED270	Duplex Receptacle 15A-125V 2 pl. 3 wr. brown			X
ED270-I	Duplex Receptacle 15A-125V 2 pl. 3 wr. ivory	X		
ED273CX	Electrical Staple insul size #5 5/8in x 1/4in 100/PK	X	X	
ED2867	Armored Plug 15A-125V 2pl. 3 wr. vinyl enclosed			X
ED2887	Armored Connector 15A-125V 2pl. 3 wr. vinyl enclosed			X
ED320	Vinyl Grommet Asst. contains: ED300 thru ED316	X	X	X
ED447	Bat Handle Switch metal SPST on-off 10A/277V-20A/125V AC	X	X	
ED453	Bat Handle Switch metal DPDT on-on 10A/277V-20A/125V AC	X	X	
ED454	Bat Handle Switch metal SPDT on-on 10A/277V-20A/125V AC	X		
ED455	Bat Handle Switch metal DPST on-off 10A/277V-20A/125V AC	X	X	
ED468	Bat Handle Switch metal SPDT on-off-on 10A/277V-20A/125V	X	X	
ED494	Bat Handle Switch metal DPDT on-off-on 10A/277V-20A/125V	X	X	
ED5225	Switch & Receptacle 2p 3w (sw:15A-120VAC& rec:15A-125VAC) brn	X		
ED600	Indicator Light 28V red PC lens incandescent bulb	X		
ED601	Indicator Light 28V green PC lens incandescent bulb	X		
ED602	Indicator Light 28V amber PC lens incandescent bulb	X		
ED610	Indicator Light 105-125V AC red nylon lens neon bulb	X		
ED611	Indicator Light 105-125V AC grn PC lensneon blb-G2B Imp&resstr	X		
ED877	Duplex Receptacle 20A-125V 2 pl. 3 wr. brown			X
EM480	In-Line Fuse Holder 1-1/4 x 1/4in fuses to 20A/32V 14ga	X	X	
ED-AT3	Blade Fuses - 3 Amp - Purple, Pack of 10	X	X	X
ED-AT5	Blade Fuses - 5 Amp - Tan, Pack of 10	X	X	X
ED-CR15	Dual Element Fuses - 15 Amp, Pack of 2	X		X
ED-CR20	Dual Element Fuses - 20 Amp, Pack of 2	X		X
ED-CR25	Dual Element Fuses - 25 Amp, Pack of 2	X		X
ED-CR30	Dual Element Fuses - 30 Amp, Pack of 2	X	X	X
ED-CR35	Dual Element Fuses - 35 Amp, Pack of 2	X		X
ED-CR40	Dual Element Fuses - 40 Amp, Pack of 2	X		X
ED-CR45	Dual Element Fuses - 45 Amp, Pack of 2	X		X

ITEM #	ITEM DESCRIPTION	ELEC	EZC	COMBO
ED-CR50	Dual Element Fuses - 50 Amp, Pack of 2	X		X
ED-CR60	Dual Element Fuses - 60 Amp, Pack of 2	X	X	X
HC5410	Hose Clamp 9/16in-1-1/8in SShousing&band st hex screw		X	X
HC5416	Hose Clamp 3/4in-1-1/2in SShousing&band st hex screw		X	
HC6202	Hose Clamp 1/4in-5/8in SS housing&band st hex screw		X	X
HC6203	Hose Clamp 5/16in-7/8in SShousing&band st hex screw		X	X
PI301	Cond Nip 1/2in offset zn w pltd. stl locknuts insul. bushings			X
PI303	Cond Nip 1/2in strt galv steel w pltd. stl lock insul.			X
PI310	Reduc. Wash 3/4in to 1/2in Rsd Fin Galv St			X
PI312	BX Conct set screw 3/8in Tr. 1/2in KO. zn die cast			X
PI315	BX Connector 90 3/8inTr. 1/2in KO zn die cast	X	X	X
PI316	Knockout Seal for 1/2in KO zn Pltd. steel	X		
PI319	Romex Connector 3/4in Tr. 3/4in KO. zn Pltd. die cast	X		
PI320	Romex Connector 3/8in Tr. 1/2in KO. zn Pltd. die cast 25/PK	X	X	X
PI321	Romex Connector 3/8in Tr. 1/2 in KO. zn Pltd. die cast	X	X	X
PI322	BX Conct str saze 3/8in Tr. 1/2in KO. zn die cast	X		
PI328	Split Bolt Connector Cu use (6 max sol & 7 max strnd)			X
PI330	Romex Stop plastic 3/8inx1/2in for 2 cond. romex 12/2-14/2	X		
PI331	Plastic in Anti-Shortin Bush 14/2 14/3 & 12/2 BX cable	X		
PI340	Combo Cable Connector for romex & BX 3/8in Tr. 1/2in KO	X		
PI350	Metal LT Conn straight 1/2in Tr. 1/2in K.O	X		
PI351	Metal LT Conn straight 3/4in Tr. 3/4in K.O.	X		
PI352	Liquid Tight Connector 90 1/2in Tr. 1/2in K.O. zn die cast	X		
PI353	Liquid Tight Connector 90 3/4in Tr. 3/4in K.O. zn die cast	X		
PI360	Box galv. steel 4in x 2-1/8inx 1-7/8in 1/2in KO 13 in ³	X		X
PI361	Box galv. steel 4in x 2-1/8inx 2-1/8in 1/2in KO 14.5 in ³	X		X
PI362	1900 Box galv. steel 4X4X1-1/2 1/2&3/4 KO 21 in ³	X	X	X
PI363	1900 Box galv. steel 4X4X2-1/8in 1/2&3/4 KO 30.3 in ³	X	X	X
PI365	Utility Cover Toggle Switch 2-11/32in x 4-1/4in Pltd. steel	X		
PI368	1900 Cover Sw/Dup Rec cad fin. steel 4in x 4in raisd 1/2in	X		X
PI371	1900 Cover Blank Flat galv. steel	X		X
PI378	1900 Cover Duplex Recep cadil fin. steel 4X4 raisd 1/2in	X		
PI381	Fuse Outlet & Switch w cover 1/2HP-125V AC galv. steel			X
PI382	Weatherproof Cover Blank Al 1 Gang w gasket anodized	X		
PI385	Wthprf Box AL2-3/4inx4-1/2inx23 1/2in holes 2 plugs 19in ³	X		
WM1002	Cable Marker Book alpha numer	X		
WM1003	Cable Marker Book numeric contains 10 each: 1 - 45	X	X	
WM1009	Cable Marker Book line & term	X		



SLIP-ON SOLDERLESS TERMINALS

Insulated Male Slip-Ons

These male terminals crimp to the wires which relieves the need to solder. A variety of sizes are available and the slip ons are fully insulated in either vinyl or nylon.



CATALOG NO.	DESCRIPTION	WIRE RANGE	TAB SIZE	UOM	ORDER MULTIPLE
60219	Insulated Male Slip-On, pack of 23	22-18	.250	PK	1
60220	Insulated Male Slip-On, pack of 23	16-14	.187	PK	1
60220LX	Insulated Male Slip-On, pack of 50	16-14	.187	PK	1
6219	Insulated Male Slip-On, pack of 22	16-14	.250	PK	1
6219LX	Insulated Male Slip-On, pack of 50	16-14	.250	PK	1
61221LX	Insulated Male Slip-On, pack of 50	12-10	.250	PK	1
61221CX	Insulated Male Slip-On, pack of 100	12-10	.250	PK	1

Insulated Female Slip-Ons

These female terminals crimp to the wires which relieves the need to solder. A variety of sizes are available and the slip ons are fully insulated in either vinyl or nylon.



CATALOG NO.	DESCRIPTION	WIRE RANGE	TAB SIZE	UOM	ORDER MULTIPLE
6282	Insulated Female Slip-On, pack of 22	22-18	.187	PK	1
6282LX	Insulated Female Slip-On, pack of 50	22-18	.187	PK	1
6235	Insulated Female Slip-On, pack of 22	22-18	.250	PK	1
6235LX	Insulated Female Slip-On, pack of 50	22-18	.250	PK	1
6235CX	Insulated Female Slip-On, pack of 100	22-18	.250	PK	1
6281	Insulated Female Slip-On, pack of 22	16-14	.187	PK	1
6281LX	Insulated Female Slip-On, pack of 50	16-14	.187	PK	1
6218	Insulated Female Slip-On, pack of 22	16-14	.250	PK	1
6218LX	Insulated Female Slip-On, pack of 50	16-14	.250	PK	1
6218CX	Insulated Female Slip-On, pack of 100	16-14	.250	PK	1
6251	Insulated Female Slip-On, pack of 17	12-10	.250	PK	1
6251LX	Insulated Female Slip-On, pack of 50	12-10	.250	PK	1
6251CX	Insulated Female Slip-On, pack of 100	12-10	.250	PK	1
61223LX	Insulated Female Slip-On, pack of 50	12-10	.340	PK	1

Fully Insulated Female Slip-Ons

These female terminals crimp to the wires which relieves the need to solder. A variety of sizes are available and the slip ons are fully insulated in either vinyl or nylon. This terminal features insulation grip. This terminal is usually supplied vinyl and has an insulation grip.



CATALOG NO.	DESCRIPTION	WIRE RANGE	TAB SIZE	UOM	ORDER MULTIPLE
6229**	Fully Insulated Female Slip-On, pack of 11	16-14	.250	PK	1
6229LX**	Fully Insulated Female Slip-On, pack of 50	16-14	.250	PK	1
6233	Fully Insulated Female Slip-On, pack of 14	16-14	.250	PK	1
6233LX	Fully Insulated Female Slip-On, pack of 50	16-14	.250	PK	1
61234LX	Fully Insulated Female Slip-On, pack of 50	12-10	.250	PK	1

*This terminal features insulation grip.

**This terminal is usually supplied vinyl and has an insulation grip.

Non-Insulated Male Slip-Ons

These non insulated male terminals crimp to the wires which relieves the need to solder. A variety of sizes are available



CATALOG NO.	DESCRIPTION	WIRE RANGE	TAB SIZE	UOM	ORDER MULTIPLE
6220	Non-Insulated Male Slip-On, pack of 38	16-14	.250	PK	1
6220CX	Non-Insulated Male Slip-On, pack of 100	16-14	.250	PK	1
61220	Non-Insulated Male Slip-On, pack of 37	16-14	.250	PK	1

Non-Insulated Female Slip-Ons

These non insulated female terminals crimp to the wires which relieves the need to solder. A variety of sizes are available. This terminal features insulation grip.



CATALOG NO.	DESCRIPTION	WIRE RANGE	TAB SIZE	UOM	ORDER MULTIPLE
6214	Non-Insulated Female Slip-On, pack of 35	16-14	.250	PK	1
6214CX	Non-Insulated Female Slip-On, pack of 100	16-14	.250	PK	1
60251	Non-Insulated Female Slip-On, pack of 26	12-10	.250	PK	1
60251CX	Non-Insulated Female Slip-On, pack of 100	12-10	.250	PK	1

*This terminal features insulation grip.

Fully Insulated Male Slip-Ons

These male terminals crimp to the wires which relieves the need to solder. A variety of sizes are available and the slip ons are fully insulated in either vinyl or nylon.



CATALOG NO.	DESCRIPTION	WIRE RANGE	TAB SIZE	UOM	ORDER MULTIPLE
6234	Fully Insulated Male Slip-On, pack of 14	16-14	.250	PK	1
6234LX	Fully Insulated Male Slip-On, pack of 50	16-14	.250	PK	1
61235LX	Fully Insulated Male Slip-On, pack of 50	12-10	.250	PK	1

Non-Insulated Flag Female Slip-Ons

These non insulated female terminals crimp to the wires which relieves the need to solder. A variety of sizes are available. Part 6213 features insulation grip.



CATALOG NO.	DESCRIPTION	WIRE RANGE	TAB SIZE	UOM	ORDER MULTIPLE
6213	Non-Insulated Flag Female Slip-On, pack of 34	16-14	.250	PK	1
6213CX	Non-Insulated Flag Female Slip-On, pack of 100	16-14	.250	PK	1
6224	Non-Insulated Flag Female Slip-On, pack of 20	12-10	.250	PK	1
6224CX	Non-Insulated Flag Female Slip-On, pack of 100	12-10	.250	PK	1





SLIP-ON SOLDERLESS TERMINALS cont'd

Fully Insulated Flag Female Slip-Ons

These female terminals crimp to the wires which relieves the need to solder. A variety of sizes are available and the slip ons are fully insulated in either vinyl or nylon.



CATALOG NO.	DESCRIPTION	WIRE RANGE	TAB SIZE	UOM	ORDER MULTIPLE
6277	Fully Insulated Flag Female Slip-On, pack of 9	16-14	.250	PK	1
6277NX	Fully Insulated Flag Female Slip-On, pack of 25	16-14	.250	PK	1

Combination Pack: Set of 6233 and 6234

Our Combination pack holds both a Fully Insulated Male and Female Slip On.



CATALOG NO.	DESCRIPTION	WIRE RANGE	TAB SIZE	UOM	ORDER MULTIPLE
61233LX	Set of Fully Insulated M/F Slip-Ons, pack of 25 pairs	16-14	.250	PK	1

Flag Female Compressor Terminal Kit

Parts 6258, 6271, 6259, 6273, 6270 in a four compartment, clear plastic box. Parts 6270 and 6273 are put in the same compartment.



CATALOG NO.	DESCRIPTION	UOM	ORDER MULTIPLE
6200HX	Flag Female Compressor Terminal Kit	EA	1

Flag Female Compressor Terminals

Also known as hermetic header terminals, these non-insulated terminals are designed with a larger distance between the "rolls" to allow for the rod in hermetic header applications. The increased distance allows the rod to slip in between them. Parts 6258 and 6259 are notched for bending. The notches are cut between the slip-on portion and the conductor barrel and enable the back of the slip-on portion to be folded against the conductor barrel after the wire connection is made. This terminal features insulation grip.



CATALOG NO.	DESCRIPTION	WIRE RANGE	FITS	UOM	ORDER MULTIPLE
6270	Flag Female Compressor Terminal, pack of 9	12-8	.250 tab	PK	1
6270LX	Flag Female Compressor Terminal, pack of 50	12-8	.250 tab	PK	1
6258*	Flag Female Compressor Terminal, pack of 17	16-14	.250 tab	PK	1
6258CX*	Flag Female Compressor Terminal, pack of 100	16-14	.250 tab	PK	1
6259	Flag Female Compressor Terminal, pack of 14	12-10	.250 tab	PK	1
6259CX	Flag Female Compressor Terminal, pack of 100	12-10	.250 tab	PK	1

*This terminal features insulation grip.

Compressor Lead Kit

Our Compressor Lead kit includes the following products: a flag female compressor terminal (.250 tab; part 62589), a waterproof butt connector (12 10 wire range; part 62231), and a piece of 10 gauge wire.



CATALOG NO.	DESCRIPTION	UOM	ORDER MULTIPLE
60259HX	Compressor Lead Kit with 12" wire	EA	1

SPECIAL PURPOSE SOLDERLESS TERMINALS

Insulated Plugs

These insulated terminals crimp to the wires which relieves the need to solder.



CATALOG NO.	DESCRIPTION	WIRE RANGE	UOM	ORDER MULTIPLE
6283LX	Insulated Plugs, pack of 50	22-18	PK	1
6285	Insulated Plugs, pack of 17	16-14	PK	1
6285LX	Insulated Plugs, pack of 50	16-14	PK	1

Combination Packs

These insulated terminals crimp to the wires which relieves the need to solder.



CATALOG NO.	DESCRIPTION	UOM	ORDER MULTIPLE
6288	Combination Pack with parts 6283 and 6284, pack of 7 pairs	PK	1
6288LX	Combination Pack with parts 6283 and 6284, pack of 25 pairs	PK	1
6289	Combination Pack with parts 6285 and 6286, pack of 7 pairs	PK	1
6289LX	Combination Pack with parts 6285 and 6286, pack of 25 pairs	PK	1

Fully Insulated Receptacles

These insulated terminals crimp to the wires which relieves the need to solder.



CATALOG NO.	DESCRIPTION	WIRE RANGE	UOM	ORDER MULTIPLE
6286	Fully Insulated Receptacles, pack of 12	16-14	PK	1

SPECIAL PURPOSE SOLDERLESS TERMINALS cont'd

Tab Adapters – Quick Disconnect with Screw

These insulated terminals crimp to the wires which relieves the need to solder.



CATALOG NO.	DESCRIPTION	UOM	ORDER MULTIPLE
6209	Fits .250 Tab, #6-32 x 1/4" Screw, pack of 5	PK	1
6209LX	Fits .250 Tab, #6-32 x 1/4" Screw, pack of 50	PK	1

Tab Adapters – Single Female Double Male Tabs

These insulated terminals crimp to the wires which relieves the need to solder. .250 male, .250 female.



CATALOG NO.	DESCRIPTION	TAB SIZE	UOM	ORDER MULTIPLE
6208	Tab Adapter; 1 female, 2 male; Bent 90°, pack of 12	.250	PK	1
6208LX	Tab Adapter; 1 female, 2 male; Bent 90°, pack of 50	.250	PK	1
6211	Tab Adapter; 1 female, 2 male; Wye, pack of 27	.250	PK	1
6211CX	Tab Adapter; 1 female, 2 male; Wye, pack of 100	.250	PK	1
6212	Tab Adapter; 1 female, 2 male; Stacked, pack of 16	.250	PK	1
6212CX	Tab Adapter; 1 female, 2 male; Stacked, pack of 100	.250	PK	1

Tap Connectors

These insulated terminals crimp to the wires which relieves the need to solder. Designed to make tap splices.



CATALOG NO.	DESCRIPTION	WIRE RANGE	UOM	ORDER MULTIPLE
6241	Tap Splice – blue, pack of 15	16-14	PK	1

Tab Adapters – Piggy Back Slip-Ons

These insulated terminals crimp to the wires which relieves the need to solder. Multi-stack, .250 male tab, .250 female slip-on.



CATALOG NO.	DESCRIPTION	WIRE RANGE	UOM	ORDER MULTIPLE
6210	Non-Insulated Piggy Back Slip-Ons, pack of 20	16-14	PK	1
60210	Insulated Piggy Back Slip-Ons, pack of 11	16-14	PK	1
60210LX	Insulated Piggy Back Slip-Ons, pack of 50	16-14	PK	1
60210CX	Insulated Piggy Back Slip-Ons, pack of 100	16-14	PK	1

Tab Adapters – Male Tabs

These insulated terminals crimp to the wires which relieves the need to solder.



CATALOG NO.	DESCRIPTION	TAB SIZE	STUD	UOM	ORDER MULTIPLE
6230	Male Tabs – Straight, pack of 28	.250	#8	PK	1
6230CX	Male Tabs – Straight, pack of 100	.250	#8	PK	1

Fully Insulated Dead End Connectors

These insulated terminals crimp to the wires which relieves the need to solder.



CATALOG NO.	DESCRIPTION	WIRE RANGE	UOM	ORDER MULTIPLE
6222	Fully Insulated Dead End Connectors, pack of 27	22-14	PK	1
6222LX	Fully Insulated Dead End Connectors, pack of 50	22-14	PK	1
6223	Fully Insulated Dead End Connectors, pack of 21	18-10	PK	1
6223LX	Fully Insulated Dead End Connectors, pack of 50	18-10	PK	1

STANDARD SOLDERLESS TERMINALS

Insulated Hooks

These insulated terminals crimp to the wires which relieves the need to solder.



CATALOG NO.	DESCRIPTION	WIRE RANGE	STUD	UOM	ORDER MULTIPLE
6242	Insulated Hooks, pack of 22	22-18	#8	PK	1
6242LX	Insulated Hooks, pack of 50	22-18	#8	PK	1
6244	Insulated Hooks, pack of 20	16-14	#8	PK	1
6244LX	Insulated Hooks, pack of 50	16-14	#8	PK	1

Insulated Butt Connectors

These insulated terminals crimp to the wires which relieves the need to solder.



CATALOG NO.	DESCRIPTION	WIRE RANGE	UOM	ORDER MULTIPLE
6232	Insulated Butt Connector, pack of 26	22-18	PK	1
6232LX	Insulated Butt Connector, pack of 50	22-18	PK	1
6232CX	Insulated Butt Connector, pack of 100	22-18	PK	1
6217	Insulated Butt Connector, pack of 27	16-14	PK	1
6217LX	Insulated Butt Connector, pack of 50	16-14	PK	1
6217CX	Insulated Butt Connector, pack of 100	16-14	PK	1
6231	Insulated Butt Connector, pack of 16	12-10	PK	1
6231LX	Insulated Butt Connector, pack of 50	12-10	PK	1
6231CX	Insulated Butt Connector, pack of 100	12-10	PK	1
6287XX	Insulated Butt Connector, pack of 10	8	PK	1
6287CX	Insulated Butt Connector, pack of 100	8	PK	1





STANDARD SOLDERLESS TERMINALS cont'd

Butt Connector Assortment Kit

This Assortment is a perfect addition to the HVAC kit. It includes an Insulated Butt Connector, a Non Insulated Butt Connector, and a Nylon Insulated Butt Connector. Includes parts 6217, 6231, and 6232.



CATALOG NO.	DESCRIPTION	UOM	ORDER MULTIPLE
6200BSX	Butt Connector Assortment Kit	EA	1

Insulated Spades

These insulated terminals crimp to the wires which relieves the need to solder.



CATALOG NO.	DESCRIPTION	WIRE RANGE	STUD	UOM	ORDER MULTIPLE
61214	Insulated Spades, pack of 23	22-18	#6	PK	1
6237	Insulated Spades, pack of 22	22-18	#8	PK	1
6237LX	Insulated Spades, pack of 50	22-18	#8	PK	1
61256LX	Insulated Spades, pack of 50	22-18	#10	PK	1
6274	Insulated Spades, pack of 22	16-14	#6	PK	1
6274LX	Insulated Spades, pack of 50	16-14	#6	PK	1
6227	Insulated Spades, pack of 22	16-14	#8	PK	1
6227LX	Insulated Spades, pack of 50	16-14	#8	PK	1
6228	Insulated Spades, pack of 22	16-14	#10	PK	1
6228LX	Insulated Spades, pack of 50	16-14	#10	PK	1
60254	Insulated Spades, pack of 18	12-10	#8	PK	1
60254LX	Insulated Spades, pack of 50	12-10	#8	PK	1
60254CX	Insulated Spades, pack of 100	12-10	#8	PK	1
6255	Insulated Spades, pack of 17	12-10	#10	PK	1
6255LX	Insulated Spades, pack of 50	12-10	#10	PK	1
6255CX	Insulated Spades, pack of 100	12-10	#10	PK	1

Non-Insulated Rings

These non insulated terminals crimp to the wires which relieves the need to solder.



CATALOG NO.	DESCRIPTION	WIRE RANGE	STUD	UOM	ORDER MULTIPLE
6215	Non-Insulated Rings, pack of 27	16-14	#8	PK	1

Non-Insulated Spades

These non insulated terminals crimp to the wires which relieves the need to solder.



CATALOG NO.	DESCRIPTION	WIRE RANGE	STUD	UOM	ORDER MULTIPLE
6226CX	Non-Insulated Spades, pack of 100	16-14	#10	PK	1

Insulated Spring Spades

These insulated terminals crimp to the wires which relieves the need to solder.



CATALOG NO.	DESCRIPTION	WIRE RANGE	STUD	UOM	ORDER MULTIPLE
6238	Insulated Spring Spades, pack of 22	22-18	#8	PK	1
6238LX	Insulated Spring Spades, pack of 50	22-18	#8	PK	1
6276	Insulated Spring Spades, pack of 21	16-14	#6	PK	1
6276LX	Insulated Spring Spades, pack of 50	16-14	#6	PK	1
6239	Insulated Spring Spades, pack of 22	16-14	#8	PK	1
6239LX	Insulated Spring Spades, pack of 50	16-14	#8	PK	1
60256CX	Insulated Spring Spades, pack of 100	12-10	#8	PK	1

Insulated Rings

These insulated terminals crimp to the wires which relieves the need to solder.



CATALOG NO.	DESCRIPTION	WIRE RANGE	STUD	UOM	ORDER MULTIPLE
61202	Insulated Rings, pack of 22	22-18	#6	PK	1
6236LX	Insulated Rings, pack of 50	22-18	#8	PK	1
6272	Insulated Rings, pack of 22	16-14	#6	PK	1
6216	Insulated Rings, pack of 23	16-14	#10	PK	1
6216LX	Insulated Rings, pack of 50	16-14	#10	PK	1
6216CX	Insulated Rings, pack of 100	16-14	#10	PK	1
60247	Insulated Rings, pack of 17	12-10	#6	PK	1
60252CX	Insulated Rings, pack of 100	12-10	#8	PK	1
6252	Insulated Rings, pack of 17	12-10	#10	PK	1
6252LX	Insulated Rings, pack of 50	12-10	#10	PK	1
6253LX	Insulated Rings, pack of 50	12-10	1/4"	PK	1
6253CX	Insulated Rings, pack of 100	12-10	1/4"	PK	1
6257	Insulated Rings, pack of 6	8	1/4"	PK	1
6257NX	Insulated Rings, pack of 25	8	1/4"	PK	1
61252NX	Insulated Rings, pack of 25	6	5/16"	PK	1

HIGH TEMPERATURE SOLDERLESS TERMINALS

High Temperature Male Slip-Ons

The High Temperature Male Slip Ons are constructed of nickel plated steel. These non insulated terminals are rated at 900 degree F (482 degree C).



4220

CATALOG NO.	DESCRIPTION	WIRE RANGE	TAB SIZE	UOM	ORDER MULTIPLE
4220	High Temp. Male Slip-Ons, pack of 21	16-14	.250	PK	1
4220CX	High Temp. Male Slip-Ons, pack of 100	16-14	.250	PK	1

High Temperature Flag Female Slip-Ons

The High Temperature Flag Female Slip Ons are constructed of nickel plated steel. These non insulated terminals are rated at 900 degree F (482 degree C).



4213

CATALOG NO.	DESCRIPTION	WIRE RANGE	TAB SIZE	UOM	ORDER MULTIPLE
4213	High Temp. Flag Female Slip-Ons, pack of 16	16-14	.250	PK	1
4213CX	High Temp. Flag Female Slip-Ons, pack of 100	16-14	.250	PK	1
4224	High Temp. Flag Female Slip-Ons, pack of 11	12-10	.250	PK	1
4224NX	High Temp. Flag Female Slip-Ons, pack of 25	12-10	.250	PK	1
4224CX	High Temp. Flag Female Slip-Ons, pack of 100	12-10	.250	PK	1

High Temperature Rings

The High Temperature Rings are constructed of nickel plated steel. These non insulated terminals are rated at 900 degree F (482 degree C).



4252

CATALOG NO.	DESCRIPTION	WIRE RANGE	STUD	UOM	ORDER MULTIPLE
4215	High Temp. Rings, pack of 21	16-14	#10	PK	1
4215CX	High Temp. Rings, pack of 100	16-14	#10	PK	1
4205CX	High Temp. Rings, pack of 100	16-14	1/4"	PK	1
4252	High Temp. Rings, pack of 14	12-10	#10	PK	1
4252CX	High Temp. Rings, pack of 100	12-10	#10	PK	1
4253	High Temp. Rings, pack of 14	12-10	1/4"	PK	1
4253CX	High Temp. Rings, pack of 100	12-10	1/4"	PK	1

High Temperature Female Slip-Ons

The High Temperature Female Slip Ons are constructed of nickel plated steel. These non insulated terminals are rated at 900 degree F (482 degree C).



4221

CATALOG NO.	DESCRIPTION	WIRE RANGE	TAB SIZE	UOM	ORDER MULTIPLE
4221	High Temp. Female Slip-Ons, pack of 20	16-14	.187	PK	1
4221CX	High Temp. Female Slip-Ons, pack of 100	16-14	.187	PK	1
4214	High Temp. Female Slip-Ons, pack of 21	16-14	.250	PK	1
4214CX	High Temp. Female Slip-Ons, pack of 100	16-14	.250	PK	1
4204	High Temp. Female Slip-Ons, pack of 17	12-10	.250	PK	1
4204CX	High Temp. Female Slip-Ons, pack of 100	12-10	.250	PK	1

High Temperature Spades

The High Temperature Spades Slip Ons are constructed of nickel plated steel. These non insulated terminals are rated at 900 degree F (482 degree C).



4226

CATALOG NO.	DESCRIPTION	WIRE RANGE	STUD	UOM	ORDER MULTIPLE
4226	High Temp. Spades, pack of 23	16-14	#10	PK	1
4226CX	High Temp. Spades, pack of 100	16-14	#10	PK	1
4254CX	High Temp. Spades, pack of 100	12-10	#10	PK	1

High Temperature Butt Connectors

The High Temperature Butt Connectors are constructed of nickel plated steel. These non insulated terminals are rated at 900 degree F (482 degree C).



4231

CATALOG NO.	DESCRIPTION	WIRE RANGE	UOM	ORDER MULTIPLE
4231	High Temp. Butt Connectors, pack of 17	12-10	PK	1

High Temperature Assortment















The High Temperature Assortment Pack holds terminals that are constructed of nickel plated steel. These non insulated terminals are rated at 900 degree F (482 degree C). Includes parts 4213, 4215, and 4204, and 4254.



4200AX

CATALOG NO.	DESCRIPTION	UOM	ORDER MULTIPLE
4200AX	High Temp. Assortment	EA	1

DEVCO TERMINAL KITS

CATALOG NO.	DESCRIPTION	TERMINALS															
	NOTE: Some kits have parts not shown in chart. Please refer to the DESCRIPTION for these parts. Except where noted, kits come in clear plastic boxes.			HIGH TEMP													
6200HX	Flag Female Compressor Terminal Kit: 8-18 wire range in a 4-compartment box with parts 6270 and 6273 in the same compartment.											6258	6259	6270 6271 6273			
6200MX 6200MSX*	.187, .250 tabs; 12-10 wire range; #8, #10 studs in a 13-compartment polypropylene box.	6217 6231 6232	6218 6235 6251 6281		6216 6252				6213				6259			6211	
6201MX	.187, .250 tabs; 22-10 wire range; #8, #10 studs in a 21-compartment metal box. (Includes parts 6233, 6234, and 6277, not shown in chart).	6217 6231 6232	6218 6235 6251 6281 6282		6216 6236 6252	6228	6238 6239		6224			6258	6259			6211	
6202MX	Insulated Terminal Kit: .187, .250 tabs; 22-10 wire range; #8, #10, #6, 1/4" studs in an 18-compartment box. Parts 6233 & 6234, and parts 6222 & 6223 are pairs (not shown in chart).	6217 6231 6232	6218 6235 6251 6281 6282		6216 6252 6253 6272 60246	60254	6238 6239										
6203MX	Non-Insulated Terminal Kit: Includes High Temp. Terminals and Flag Female Compressor Terminals. .250 tab; 22-10 wire range; #8, #10 studs in an 18-compartment box. (Includes parts 6209 and 6210, not shown in chart).		4204 4213 4214 4215 4252 4254					6214	6213	6224		6258	6259	6270 6271	6230	6208	6211
4200AX	High Temperature Terminal Kit: .250 tab; 16-10 wire; #10 stud in a bag.		4204 4213 4215 4254														
6200X	.250 tab; 16-14 wire; #8 stud in a 6-compartment box.	6217						6214	6213		6215				6230		6211
6200AX	.250 tab; 16-14 wire range; #8, #10 studs in a 6-compartment box.	6217	6218		6216				6213						6230		6211
6200BSX	22-10 wire range in a bag.	6217 6231 6232															
6200CX	.250 tab; 16-14 wire; #10 stud in a 4-compartment box.		6218		6216				6213								6211

*Contains a crimper.

ANCHORS

Metal Drive Anchors

The anchors offer a Quick and Easy Solution for Light Duty Anchoring Jobs in Concrete and Masonry and Easy through type fastening, even when used in bottomless holes

7236RLX



CATALOG NO.	DESCRIPTION	SIZE	EMBEDMENT	PULLOUT LOAD	UOM	ORDER MULTIPLE
7233RLX	Drive Anchor, pack of 50	1/4" X 3/4"	5/8"	500 lb.	PK	1
7234RLX	Drive Anchor, pack of 50	1/4" X 1"	7/8"	944 lb.	PK	1
7235RLX	Drive Anchor, pack of 50	1/4" X 1-1/4"	1-1/8"	1,146 lb.	PK	1
7236RLX	Drive Anchor, pack of 50	1/4" X 1-1/2"	1-3/8"	854 lb.	PK	1

Drop-In Expansion Anchor Setting Tool

This tool is great for use while setting an anchor.

7146

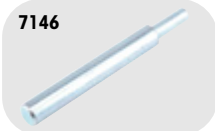

CATALOG NO.	DESCRIPTION	UOM	ORDER MULTIPLE
7146	For use with anchor part number 7142	EA	1

Self-Drilling Gypsum Wallboard Anchors

These anchors pre drill precise holes in gypsum wallboard with no special tools required. The anchors are easily installed with a #2 or #3 Phillips screwdriver, slotted driver, or power driver. Plastic plugs toggles and toggles are easily replaced with the deep threaded products. There is a full range to cover all wall fastening applications and are available in corrosion resistant and non conductive white nylon. The product has a low profile head and can easily be backed out. They provide and strong engagement in 3/4 in., 1/2 in., and 5/8 in. gypsum wallboard and are supplied with combo head screws.

7321X



CATALOG NO.	DESCRIPTION	SCREW SIZE	MAX. FIXTURE	UOM	ORDER MULTIPLE
7316X	E-Z Ancor®, nylon, pack of 10	#8 x 1-1/4"	3/4"	PK	1
7316L	E-Z Ancor®, nylon, pack of 50	#8 x 1-1/4"	3/4"	PK	1
7311L	E-Z Ancor®, zinc die cast*, pack of 50	#6 x 1-1/4"	3/4"	PK	1
7317X	E-Z Ancor Lite™; nylon, pack of 10	#6 x 1-1/4"	3/4"	PK	1
7317L	E-Z Ancor Lite™; nylon, pack of 50	#6 x 1-1/4"	3/4"	PK	1
7321X	E-Z Toggle™; zinc die cast; heavy-duty, pack of 10	#8 x 2-1/8"	5/8"	PK	1

*Smaller version of the E-Z Ancor® with a versatile core that can use #6 or #8 sheet metal screws or #6, #7, #8 drywall screws.

Drive Fasteners

These steel fasteners can be driven into dry wall like a nail and are secured by turning the screw down completely to expand the ribs.

7303



CATALOG NO.	DESCRIPTION	HOLE SIZE	GRIP RANGE	UOM	ORDER MULTIPLE
7302	Drive Fastener, pack of 6	1/4"	1/8" to 1/2"	PK	1
7303	Drive Fastener, pack of 6	1/4"	1/8" to 3/16"	PK	1

Drop-In Expansion Anchors

These heavy duty anchors are made of carbon steel. They are set by means of an internal plug and setting tool.

7142



CATALOG NO.	DESCRIPTION	BOLT SIZE	THREADS PER INCH	HOLE DEPTH	THREAD DEPTH	DRILL BIT SIZE	UOM	ORDER MULTIPLE
7142	Anchor, pack of 4	3/8"	18	1-5/8"	1/2"	1/2"	PK	1
7142LX	Anchor, pack of 50	3/8"	18	1-5/8"	1/2"	1/2"	PK	1

DEVCO PLASTIC ANCHOR KITS

CATALOG NO.		ANCHOR	DRILL SIZE	DRILL BIT INCLUDED	SCREW	SCREW SIZE
SMALL PACK*	100 PACK					
	7103CX		<u>5/32</u> 			#4 x 3/4"
	7101CX		<u>3/16</u> 			#8 x 1"
	7101HCX					#8 x 1"
	7102CX		<u>1/4</u> 			#10 x 1-1/4"
	7102HCX					#10 x 1"
	7106CX		<u>1/4</u> 			#10 x 1
7105LX			<u>5/16</u> 			#14 x 1-1/2"
7111X	7111CX		<u>5/16</u> 			#14 x 1"

*SMALL PACK	COUNT
7106	28
7111X	40
7105LX	50



BOXES, RINGS, AND COVERS

Steel Utility Boxes*

Steel Utility Boxes are used for convenience outlets, switch boxes and small junction boxes. Galvanized steel.



CATALOG NO.	LENGTH	WIDTH	DEPTH	CAPACITY (cubic in.)	KNOCKOUT (in.)	UOM	ORDER MULTIPLE
PI360	4"	2-1/8"	1-7/8"	13.0	1/2	EA	1
PI361	4"	2-1/8"	2-1/8"	14.5	1/2	EA	1

Steel 1900 Boxes*

Steel Utility Boxes are used for convenience outlets, switch boxes and small junction boxes. Galvanized steel.



CATALOG NO.	LENGTH	WIDTH	DEPTH	CAPACITY (cubic in.)	KNOCKOUT (in.)	UOM	ORDER MULTIPLE
PI362	4"	4"	1-1/2"	21.0	3/4 & 1/2	EA	1
PI363	4"	4"	2-1/8"	30.3	3/4 & 1/2	EA	1

Device Rings*

Device rings are designed for projects of preexisting locations. They can help narrow an opening for a box in the sheet rock. They are also known as Plaster Rings. Galvanized steel.



CATALOG NO.	DESCRIPTION	NUMBER DEVICES	RAISED	UOM	ORDER MULTIPLE
PI387	1900 Device Ring	1	1/2"	EA	1

Extension Rings*

Extension rings are used when extra cubic inch capacity is needed for additional wiring. Galvanized steel.



CATALOG NO.	LENGTH	WIDTH	DEPTH	CAPACITY (cubic in.)	KNOCKOUT (in.)	UOM	ORDER MULTIPLE
PI390	4"	2-1/8"	1-7/8"	13.0	1/2	EA	1
PI391	4"	4"	1-1/2"	21.0	3/4 & 1/2	EA	1

Utility Covers*

These covers are 4 1/4in. x 2 11/32in. and are designed for appliances or emergency oil burners.



CATALOG NO.	DESCRIPTION	UOM	ORDER MULTIPLE
PI383	Appliance Switch, .4687" dia. hole, baked cadillite finish	EA	1
PI374	Red finish, "Emergency Gas Burner" in white letters	EA	1

Plated Steel Utility Covers*

Ideal for exposed work applications, providing an easy method for the installation of electrical devices (switches, receptacles, fans, lights, etc.)



CATALOG NO.	DESCRIPTION	WIDTH	LENGTH	UOM	ORDER MULTIPLE
PI365	Toggle Switch	2-11/32"	4-1/4"	EA	1
PI366	Duplex Receptacle	2-11/32"	4-1/4"	EA	1
PI367	Blank Cover	2-11/32"	4-1/4"	EA	1
PI375	Standard Single Receptacle	2-11/32"	4-1/4"	EA	1

Utility Plates*

These plates are 4 1/4in. x 2 11/32in. and are designed for emergency oil burners.



CATALOG NO.	DESCRIPTION	UOM	ORDER MULTIPLE
PI393	Red finish, "Emergency Oil Burner" in white letters	EA	1
PI394	Red finish, "Emergency Gas Burner" in white letters	EA	1

*Items in this section are Underwriter's Laboratories listed or recognized under the prime manufacturer's name.



BOXES, RINGS, AND COVERS cont'd

Steel 1900 Covers*

The covers are baked in a cadillite finished steel and are raised 1/2in. with fully depressed corners. Size: 4" x 4".



CATALOG NO.	DESCRIPTION	UOM	ORDER MULTIPLE
PI377	Single Toggle	EA	1
PI378	Single Duplex Receptacle	EA	1
PI379	One Standard Single Receptacle	EA	1
PI368	Toggle Switch and Duplex Receptacle	EA	1
PI370	Toggle Switch and Standard Single Receptacle	EA	1
PI371	Flat, Blank, Galvanized steel (not Cadillite finished)	EA	1

Weatherproof Covers*

These covers can be used with item PI385 and come with gaskets.

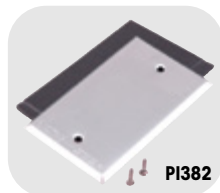

CATALOG NO.	DESCRIPTION	UOM	ORDER MULTIPLE
PI382	Blank Cover	EA	1
PI386	Lever Switch Cover for standard toggle type switches	EA	1
PI389	Duplex Receptacle Cover	EA	1
PI389-GFI	GFI Receptacle Cover	EA	1

Weatherproof Boxes*

Heavy duty die cast aluminum with baked aluminum finish. Boxes have two closure plugs and three holes. Item is Underwriter's Laboratories listed or recognized under the prime manufacturer's name.



CATALOG NO.	LENGTH	WIDTH	DEPTH	CAPACITY (cubic in.)	HOLE SIZE (in.)	UOM	ORDER MULTIPLE
PI385	4-1/2"	2-3/4"	2"	19.0	1/2	EA	1
PI385-34	4-1/2"	2-3/4"	2"	19.0	3/4	EA	1

Weatherproof Box with Lever Switch Cover*

The box is heavy duty die cast aluminum with baked aluminum finish and has two closure plugs and three holes. The cover comes with the gaskets. Includes parts PI385 and PI386.



CATALOG NO.	DESCRIPTION	UOM	ORDER MULTIPLE
PI384	Weatherproof Box and Lever Switch Cover	EA	1

Safety Plates*

Safety plates, also called nail in plates, or nail plates, install quickly and protect wire, cable and pipes that may be installed in upright wood stud walls.



CATALOG NO.	DESCRIPTION	UOM	ORDER MULTIPLE
PI232CX	Safety Plate – approximately 6"	EA	100

CABLE CONNECTORS

Zinc Plated Die Cast Steel Romex Connectors*

These zinc plated die cast connectors are for use with Romex, Service, and UF Cables.



CATALOG NO.	DESCRIPTION	TRADE SIZE	KNOCKOUT	UOM	ORDER MULTIPLE
PI321	Zinc plated die cast Romex Connector, pack of 8	3/8"	1/2"	PK	1
PI320	Zinc plated die cast Romex Connector, pack of 25	3/8"	1/2"	PK	1
PI319	Zinc plated die cast Romex Connector, pack of 4	3/4"	3/4"	PK	1
PI319CX	Zinc plated die cast Romex Connector, pack of 100	3/4"	3/4"	PK	1

Rigid Conduit Bodies*

These bodies are Aluminum and can be use indoor or outdoor. Use to gain access to the interior of a raceway for wire pulling, splicing (with limitations as specified by the NEC), and maintenance. This item comes with cover and gasket.



CATALOG NO.	DESCRIPTION	TRADE SIZE	BODY TYPE	UOM	ORDER MULTIPLE
PI458	Includes steel cover, screws, gasket	1/2"	Back (LB)	EA	1
PI459	Includes steel cover, screws, gasket	3/4"	Back (LB)	EA	1

*Items in this section are Underwriter's Laboratories listed or recognized under the prime manufacturer's name.

CABLE CONNECTORS cont'd

BX and Greenfield Connectors*

These connectors are used to terminate Flexible Metal Conduit to a knock out in a dry location box or enclosure. Zinc die cast.



CATALOG NO.	DESCRIPTION	TRADE SIZE	KNOCKOUT	UOM	ORDER MULTIPLE
PI311	Set Screw Type Connector, 25 per pack	3/8"	1/2"	PK	1
PI312	Set Screw Type Connector, 8 per pack	3/8"	1/2"	PK	1
PI322	Straight Connector, squeeze type, for armored cable and flexible conduit, 8 per pack	3/8"	1/2"	PK	1
PI315	90° Connector, 3 per pack	3/8"	1/2"	PK	1
PI341	90° Connector, 4 per pack	1/2"	1/2"	PK	1
PI340	Combination Cable Connector suitable for Romex or BX and Greenfield, 8 per pack	3/8"	1/2"	PK	1
PI318	Duplex Connector with single screw, clamp type, 2 per pack	3/8"	1/2"	PK	1

Liquid-Tite Connectors*

These connectors are made of zinc die cast and can be used with Flexible Metal Conduits and non metallic conduits. Zinc die cast.



CATALOG NO.	DESCRIPTION	TRADE SIZE	KNOCKOUT	UOM	ORDER MULTIPLE
PI350	Straight Liquid-Tite Connector, 2 per pack	1/2"	1/2"	PK	1
PI351	Straight Liquid-Tite Connector, 2 per pack	3/4"	3/4"	PK	1
PI352	90° Liquid-Tite Connector	1/2"	1/2"	EA	1
PI353	90° Liquid-Tite Connector	3/4"	3/4"	EA	1

Thinwall E.M.T. Connectors*

These are used to join EMT conduit to boxes on enclosures. Zinc die cast.



CATALOG NO.	DESCRIPTION	TRADE SIZE	KNOCKOUT	UOM	ORDER MULTIPLE
PI411	Compression Type Connectors, 8 per pack	1/2"	1/2"	PK	1
PI412	Compression Type Connectors, 8 per pack	3/4"	3/4"	PK	1
PI416	Compression Type Couplings, 8 per pack	3/4"		PK	1
PI426	Compression Type Straight Connectors for connecting E.M.T. to Liquid-Tight, 8 per pack	3/4"		PK	1
PI419	Set Screw Type Connectors, 8 per pack	1/2"	1/2"	PK	1

CABLE TIES AND ACCESSORIES

Heavy Duty Nylon Cable Ties

Black ties are weather and UV resistant. Items in this section are Underwriters' Laboratories listed or recognized under the prime manufacturer's name.

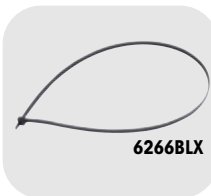

CATALOG NO.	DESCRIPTION	LENGTH	COLOR	MAX. BUNDLE DIAMETER	TENSILE STRENGTH	UOM	ORDER MULTIPLE
6265BLX	Nylon; Heavy-duty, pack of 50	14"	Black	4"	175 lb.	PK	1
6265BCX	Nylon; Heavy-duty, pack of 100	14"	Black	4"	175 lb.	PK	1
6266BLX	Nylon; Heavy-duty, pack of 50	36"	Black	11"	175 lb.	PK	1

Nylon Cable Ties with Mounting Hole

Black ties are weather and UV resistant. Items in this section are Underwriters' Laboratories listed or recognized under the prime manufacturer's name.



CATALOG NO.	DESCRIPTION	MOUNTING HOLE	LENGTH	COLOR	MAX. BUNDLE DIAMETER	TENSILE STRENGTH	UOM	ORDER MULTIPLE
60264CX	Tie w/mtg. hole, pack of 100	#8	6"	Natural	1-3/8"	30 lb.	PK	1
60264BCX	Tie w/mtg. hole, pack of 100	#8	6"	Black	1-3/8"	30 lb.	PK	1
6264LX	Tie w/mtg. hole, pack of 50	#10	7"	Natural	1-3/4"	50 lb.	PK	1
6264CX	Tie w/mtg. hole, pack of 100	#10	7"	Natural	1-3/4"	50 lb.	PK	1
6264BCX	Tie w/mtg. hole, pack of 100	#10	7"	Black	1-3/4"	50 lb.	PK	1
60263CX	Tie w/mtg. hole, pack of 100	#10	11"	Natural	3"	50 lb.	PK	1
60263BLX	Tie w/mtg. hole, pack of 50	#10	11"	Black	3"	50 lb.	PK	1
60263BCX	Tie w/mtg. hole, pack of 100	#10	11"	Black	3"	50 lb.	PK	1

*Items in this section are Underwriter's Laboratories listed or recognized under the prime manufacturer's name.



CABLE TIES AND ACCESSORIES cont'd

Nylon Cable Ties

Black ties are weather and UV resistant. Items in this section are Underwriters' Laboratories listed or recognized under the prime manufacturer's name.

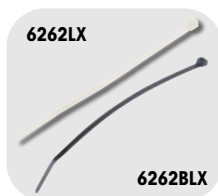

CATALOG NO.	DESCRIPTION	LENGTH	COLOR	MAX. BUNDLE DIAMETER	TENSILE STRENGTH	UOM	ORDER MULTIPLE
6267MX	Nylon Cable Ties, pack of 1,000	4"	Natural	13/16"	18 lb.	PK	1
6261CX	Nylon Cable Ties, pack of 100	6"	Natural	1-3/8"	18 lb.	PK	1
6261BCX	Nylon Cable Ties, pack of 100	6"	Black	1-3/8"	18 lb.	PK	1
6268BMX	Nylon Cable Ties, pack of 1,000	6"	Black	1-3/8"	30 lb.	PK	1
6262LX	Nylon Cable Ties, pack of 50	7-1/2"	Natural	1-3/4"	50 lb.	PK	1
6262CX	Nylon Cable Ties, pack of 100	7-1/2"	Natural	1-3/4"	50 lb.	PK	1
6262MX	Nylon Cable Ties, pack of 1,000	7-1/2"	Natural	1-3/4"	50 lb.	PK	1
6262BLX	Nylon Cable Ties, pack of 50	7-1/2"	Black	1-3/4"	50 lb.	PK	1
6262BCX	Nylon Cable Ties, pack of 100	7-1/2"	Black	1-3/4"	50 lb.	PK	1
6262BMX	Nylon Cable Ties, pack of 1,000	7-1/2"	Black	1-3/4"	50 lb.	PK	1
6263LX	Nylon Cable Ties, pack of 50	11"	Natural	3"	50 lb.	PK	1
6263CX	Nylon Cable Ties, pack of 100	11"	Natural	3"	50 lb.	PK	1
6263DX	Nylon Cable Ties, pack of 500	11"	Natural	3"	50 lb.	PK	1
6263BLX	Nylon Cable Ties, pack of 50	11"	Black	3"	50 lb.	PK	1
6263BCX	Nylon Cable Ties, pack of 100	11"	Black	3"	50 lb.	PK	1
6263BDX	Nylon Cable Ties, pack of 500	11"	Black	3"	50 lb.	PK	1
60265LX	Nylon Cable Ties, pack of 50	14"	Natural	4"	50 lb.	PK	1
60265BLX	Nylon Cable Ties, pack of 50	14"	Black	4"	50 lb.	PK	1

Black Nylon Cable Tie Assortment

Black ties are weather and UV resistant. Items in this section are Underwriters' Laboratories listed or recognized under the prime manufacturer's name.

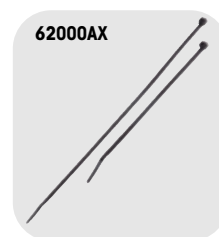

CATALOG NO.	DESCRIPTION	LENGTH	COLOR	MAX. BUNDLE DIAMETER	TENSILE STRENGTH	UOM	ORDER MULTIPLE
62000AX	Assortment	7-1/2"	Black	1-3/4"	50 lb.	PK	1
		11"	Black	3"	50 lb.		

Cable Tie Mounts

Approximately 1in. square adhesive backed. These mounts can be mounted with a screw and will accept up to 75 lb. ties.



CATALOG NO.	DESCRIPTION	UOM	ORDER MULTIPLE
6269	Cable Tie Mounts; 1" square; adhesive backed, pack of 11	PK	1
6269LX	Cable Tie Mounts; 1" square; adhesive backed, pack of 50	PK	1
6269MX	Cable Tie Mounts; 1" square; adhesive backed, pack of 1,000	PK	1

CONDUIT FITTINGS

Straps

Our zinc plated steel straps are designed to hold conduit pipe.



CATALOG NO.	DESCRIPTION	UOM	ORDER MULTIPLE
PI306	Straps fit 1/2" E.M.T. Conduit, pack of 20	PK	1
PI306CX	Straps fit 1/2" E.M.T. Conduit, pack of 100	PK	1
PI307	Straps fit 3/4" E.M.T. Conduit, pack of 12	PK	1
PI307CX	Straps fit 3/4" E.M.T. Conduit, pack of 100	PK	1
PI908	Straps fit 1" E.M.T. Conduit, pack of 10	PK	1
PI908CX	Straps fit 1" E.M.T. Conduit, pack of 100	PK	1
PI909LX	Straps fit 1-1/4" E.M.T. Conduit, pack of 50	PK	1
PI206	Straps for 14-2 Romex, pack of 20	PK	1

Knockout Seals and Hole Plug



CATALOG NO.	DESCRIPTION	UOM	ORDER MULTIPLE
PI316	For 1/2" knockouts, zinc plated steel, pack of 10	PK	1
PI317	For 3/4" knockouts, zinc plated steel, pack of 10	PK	1
ED406	Nylon Hole Plug for 3/8" hole, pack of 28	PK	1

Reducing Washers

Reducing washers are for reducing knockout holes. These washers have raised flanges for a tight fit and are made of galvanized steel. PI308 reduces hole to fit appliance switch.



CATALOG NO.	DESCRIPTION	UOM	ORDER MULTIPLE
PI304	Reducing Washer - reduces hole from 1" to 1/2", pack of 10	PK	1
PI305	Reducing Washer - reduces hole from 1" to 3/4", pack of 10	PK	1
PI310	Reducing Washer - reduces hole from 3/4" to 1/2", pack of 28	PK	1
PI310LX	Reducing Washer - reduces hole from 3/4" to 1/2", pack of 50	PK	1
PI912	Reducing Washer - reduces hole from 2" to 3/4", pack of 5	PK	1
PI912LX	Reducing Washer - reduces hole from 2" to 3/4", pack of 50	PK	1
PI913	Reducing Washer - reduces hole from 1-1/2" to 1/2", pack of 4	PK	1
PI914	Reducing Washer - reduces hole from 1-1/2" to 3/4", pack of 4	PK	1

Conduit Nipples*

Used to connect two electrical utility boxes where room is limited. Zinc die cast steel. Comes with plated steel locknuts.



CATALOG NO.	DESCRIPTION	SIZE	CONNECTION	UOM	ORDER MULTIPLE
PI203	Conduit Nipple, pack of 6	1/2"	Straight	PK	1

CONDUIT FITTINGS cont'd

Conduit Nipples*

PI301 is zinc die cast steel. PI303 is galvanized steel. All come with plated steel locknuts and plastic insulating bushings.



CATALOG NO.	DESCRIPTION	SIZE	CONNECTION	UOM	ORDER MULTIPLE
PI301	Conduit Nipple, pack of 2	1/2"	Offset	PK	1
PI303	Conduit Nipple, pack of 2	1/2" x 2"	Straight	PK	1

Bushings and Locknuts

The locknuts and bushing are straight connectors provide excellent pullout strength and can be installed without disassembly. The compression nut ratchet prevents unintentional loosening.



CATALOG NO.	DESCRIPTION	UOM	ORDER MULTIPLE
PI331	Plastic "Anti-Short" Bushings for 14/2, 14/3, 12/2 BX cable, pack of 35	PK	1

Electrical Staples

We have steel, insulated copper finish, and plastic electrical staples available.



CATALOG NO.	DESCRIPTION	SIZE	UOM	ORDER MULTIPLE
PI330	Plastic; for 2 conductor Romex and other NM cable conductor; 12/2-14/2 range; UV protected, pack of 50	3/8" x 1/2"	PK	1
PI332	Plastic; for 3 conductor Romex and other NM cable conductor; 12/3-14/3 range; UV protected, pack of 50	3/8" x 3/4"	PK	1
PI309	Steel; non-insulated for Romex and NM cable; 14/2-10/3 range, pack of 154	1" x 1/2"	PK	1
ED273	Insulated coppered finish; size #5, pack of 50	5/8" x 1/4"	PK	1
ED273CX	Insulated coppered finish; size #5, pack of 100	5/8" x 1/4"	PK	1

GENERAL TOOLS

Devco Crimpers

Crimps insulated and non insulated terminals 22 to 10 AWG, cuts bolts #4 40 through #10 24, and strips stranded wire 22 to 10 AWG and solid wire 18 to 8 AWG. Features two precision ground wire cutters, one on the nose and the other behind the pivot point. Plastic cushion handle.



CATALOG NO.	DESCRIPTION	UOM	ORDER MULTIPLE
5002	Devco Crimpers; plastic coated handle	EA	1

Blind Rivet Tools

Heavy duty hand rivet tool that offers long handles to increase leverage and to secure the rivet in the nosepiece while the tool is in use. Powerful riveting capacity with 4 standard nosepieces to set 3/32, 1/8, 5/32, and 3/16" blind rivets.



CATALOG NO.	DESCRIPTION	UOM	ORDER MULTIPLE
5107	Heavy-duty tool; 4 interchangeable nose pieces to accommodate 3/32", 1/8", 5/32", 3/16" steel or aluminum rivets	EA	1

Magnetic Hex Chucks

Magnetic Hex Chucks may be used with an electric drill to drive hex washer head screws.



CATALOG NO.	DESCRIPTION	HEX HEAD SIZE	HEX HEAD DIAMETER	LENGTH	UOM	ORDER MULTIPLE
DE13	Magnetic Hex Chuck	1/4"	7/16"	1-3/4"	EA	1
DE14	Magnetic Hex Chuck	5/16"	1/2"	1-3/4"	EA	1
DE15	Magnetic Hex Chuck	3/8"	9/16"	1-7/8"	EA	1
DE23	Magnetic Hex Chuck	1/4"	7/16"	2-9/16"	EA	1
DE24	Magnetic Hex Chuck	5/16"	1/2"	2-9/16"	EA	1
DE33**	Magnetic Hex Chuck	1/4"	7/16"	3"	EA	1

**Magnetic insert bit holder with a "C" ring retainer

*Items in this section are Underwriter's Laboratories listed or recognized under the prime manufacturer's name.



NUTS AND BOLTS

Finished Hex Nuts

The hex nuts are zinc plated steel.



CATALOG NO.	DESCRIPTION	SIZE	UOM	ORDER MULTIPLE
6501	Finished Hex Nuts, pack of 60	1/4" - 20	PK	1
6501CX	Finished Hex Nuts, pack of 100	1/4" - 20	PK	1
6502	Finished Hex Nuts, pack of 38	5/16" - 18	PK	1
6503	Finished Hex Nuts, pack of 25	3/8" - 16	PK	1
6503CX	Finished Hex Nuts, pack of 100	3/8" - 16	PK	1
6505	Finished Hex Nuts, pack of 11	1/2" - 13	PK	1
6505LX	Finished Hex Nuts, pack of 50	1/2" - 13	PK	1

Stove Bolts

Stove Bolts are a combination of slotted round head machine screws and finished hex nuts. They are made of zinc plated steel.



CATALOG NO.	DESCRIPTION	SIZE	LENGTH	UOM	ORDER MULTIPLE
6401	Stove Bolts, pack of 42	#10 - 24	1/2"	PK	1
6402	Stove Bolts, pack of 38	#10 - 24	3/4"	PK	1
6403	Stove Bolts, pack of 34	#10 - 24	1"	PK	1
6404	Stove Bolts, pack of 27	#10 - 24	1-1/2"	PK	1
6411	Stove Bolts, pack of 22	1/4" - 20	1/2"	PK	1
6412	Stove Bolts, pack of 20	1/4" - 20	3/4"	PK	1
6413	Stove Bolts, pack of 18	1/4" - 20	1"	PK	1
6414	Stove Bolts, pack of 15	1/4" - 20	1-1/2"	PK	1
6415	Stove Bolts, pack of 13	1/4" - 20	2"	PK	1
6416	Stove Bolts, pack of 11	1/4" - 20	2-1/2"	PK	1

Flat Washers

These washers are zinc plated steel with a USS Classification.

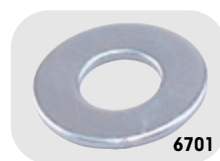

CATALOG NO.	DESCRIPTION	SIZE	INNER DIAMETER	OUTER DIAMETER	UOM	ORDER MULTIPLE
6701	Flat Washers (USS), pack of 160	3/16"	1/4"	9/16"	PK	1
6702	Flat Washers (USS), pack of 72	1/4"	5/16"	3/4"	PK	1
6703	Flat Washers (USS), pack of 33	5/16"	3/8"	7/8"	PK	1
6704	Flat Washers (USS), pack of 37	3/8"	7/16"	1"	PK	1
6704-2X	Flat Washers (USS), pack of 134	3/8"	7/16"	1"	PK	1
6706	Flat Washers (USS), pack of 11	1/2"	9/16"	1-3/8"	PK	1
6706-2X	Flat Washers (USS), pack of 52	1/2"	9/16"	1-3/8"	PK	1
6700AX	Assortment	All sizes included			EA	1

Machine Screw Hex Nuts

The hex nuts are zinc plated steel.



CATALOG NO.	DESCRIPTION	SIZE	UOM	ORDER MULTIPLE
6526	Machine Screw Hex Nuts, pack of 49	#8 - 32	PK	1
6528	Machine Screw Hex Nuts, pack of 44	#10 - 24	PK	1
6500A	Assortment, 23 of each	#6-32, #8-32, #10-32	EA	1

Toggle Bolts

The toggle bolts are slotted round head machine screws with spring wings and are made of zinc plated steel.



CATALOG NO.	DESCRIPTION	LENGTH	BOLT SIZE	HOLE SIZE	UOM	ORDER MULTIPLE
7033	Toggle Bolts, pack of 6	4"	3/16"	1/2"	PK	1
7034	Toggle Bolts, pack of 5	4"	1/4"	5/8"	PK	1
7036X	Toggle Bolts, pack of 4	4"	3/8"	1"	PK	1
7066X	Toggle Bolts, pack of 4	6"	3/8"	1"	PK	1

Hex Head Cap Screws

Hex Screw Cap Screws are made of low carbon, grade 2 steel and are USS Classified. The total thread length on these screws equal 2x diameter + 1/4in.



CATALOG NO.	DESCRIPTION	SIZE	LENGTH	UOM	ORDER MULTIPLE
6601	Hex Head Cap Screws, pack of 28	1/4" - 20	3/4"	PK	1
6602	Hex Head Cap Screws, pack of 25	1/4" - 20	1"	PK	1
6603	Hex Head Cap Screws, pack of 18	1/4" - 20	1-1/2"	PK	1
6622	Hex Head Cap Screws, pack of 15	5/16" - 18	1"	PK	1
6623	Hex Head Cap Screws, pack of 12	5/16" - 18	1-1/2"	PK	1
6641	Hex Head Cap Screws, pack of 14	3/8" - 16	3/4"	PK	1
6642	Hex Head Cap Screws, pack of 12	3/8" - 16	1"	PK	1
6643	Hex Head Cap Screws, pack of 8	3/8" - 16	1-1/2"	PK	1
6644	Hex Head Cap Screws, pack of 7	3/8" - 16	2"	PK	1
6645	Hex Head Cap Screws, pack of 5	3/8" - 16	2-1/2"	PK	1
6685	Hex Head Cap Screws, pack of 3	1/2" - 13	2-1/2"	PK	1

Medium Split Lock Washers

Spring type. These washers are made of zinc plated steel.



CATALOG NO.	DESCRIPTION	SIZE	UOM	ORDER MULTIPLE
6730	Medium Split Lock Washers, pack of 95	3/16"	PK	1
6731	Medium Split Lock Washers, pack of 72	1/4"	PK	1
6732	Medium Split Lock Washers, pack of 59	5/16"	PK	1
6733	Medium Split Lock Washers, pack of 38	3/8"	PK	1
6735	Medium Split Lock Washers, pack of 18	1/2"	PK	1

NUTS AND BOLTS cont'd

Fender Washers

These washers are made of zinc plated steel.

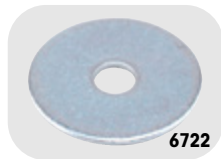

CATALOG NO.	DESCRIPTION	SIZE	INNER DIAMETER	OUTER DIAMETER	UOM	ORDER MULTIPLE
6722	Fender Washers, pack of 20	1/4"	9/32"	1-1/4"	PK	1
6722-2X	Fender Washers, pack of 92	1/4"	9/32"	1-1/4"	PK	1
6724	Fender Washers, pack of 12	3/8"	13/32"	1-1/2"	PK	1
6724-2X	Fender Washers, pack of 66	3/8"	13/32"	1-1/2"	PK	1

POWER CORDS AND WORK LIGHTS

Round Extension Cords*

Comes in bright orange or yellow, depending upon availability.



CATALOG NO.	DESCRIPTION	WIRE	LENGTH	RATING	UOM	ORDER MULTIPLE
5230	Round Extension Cord	14/3	100'	13A/125V	EA	1

Trouble Lights*

These all weather lights are extra flexible with metal guards.



CATALOG NO.	DESCRIPTION	WIRE	CORD LENGTH	RATING	UOM	ORDER MULTIPLE
5200	Trouble Light	16/3	25'	13A/125V	EA	1
5201	Trouble Light	16/3	50'	13A/125V	EA	1

SCREWS

Combo Head Sheet Metal Screws

These screws are used on sheet metal items.



CATALOG NO.	DESCRIPTION	LENGTH	SCREW SIZE	UOM	ORDER MULTIPLE
6853	Combo Head Screws, pack of 48	1/2"	#10	PK	1
6855	Combo Head Screws, pack of 46	3/4"	#10	PK	1
6858	Combo Head Screws, pack of 26	1-1/2"	#10	PK	1
6859	Combo Head Screws, pack of 19	2"	#10	PK	1
6865	Combo Head Screws, pack of 32	3/4"	#12	PK	1
6866	Combo Head Screws, pack of 26	1"	#12	PK	1
6876	Combo Head Screws, pack of 20	1"	#14	PK	1

Sheet Metal Screw Assortments

6800BX and 6800HX come in a four compartment, clear plastic box.



CATALOG NO.	DESCRIPTION	UOM	ORDER MULTIPLE
6800HX	Slotted Hex Washer Head Screws: #6 x 3/8", #8 x 1/2", #8 x 3/4", #10 x 3/4", #10 x 1"	EA	1

Self-Drilling Screw Repair Kit

These screws are used for replacements in striped holes.



CATALOG NO.	DESCRIPTION	UOM	ORDER MULTIPLE
6900AX	Contains: #12 x 3/4", #12 x 1", #14 x 3/4", #14 x 1"	EA	1

Self-Drilling Screws

Zinc plated steel. Self drilling screws drill and tap holes in one step. Hex washer heads. #8 and #10 screws are designed for use with material thickness of .035" to .110"; #12 and #14 screws are designed for use with .110" to .220" material thickness.



CATALOG NO.	DESCRIPTION	UOM	ORDER MULTIPLE
6943CX	Hex Head Self Drilling Screw, 1/4in. Head #8 x 1/2in., 100 pcs	EA	1
6945CX	Hex Head Self Drilling Screw, Zinc Plated, #8 x 3/4in., 100 pcs	EA	1
6946CX	Hex Head Self Drilling Screw, 1/4in. Head #8 x 1in, 100 pcs	EA	1
6953CX	Hex Washer Head Self Drilling Screws 5/16in. Head #10 x 1/2in 100 pcs	EA	1
6955CX	Hex Head Self Drilling Screw, 5/16in. Head #10 x 3/4in., 100 pcs	EA	1
6956CX	Hex Washer Head Self Drilling Screws 5/16in. Head #10 x 1in 100 pcs	EA	1



SPECIALTY FASTENERS

Nylon Cable Clamps

These cable clamps are perfect for securing wire or pipes.



CATALOG NO.	DESCRIPTION	FITS PIPE OUTER DIAMETER	THICKNESS	WIDTH	UOM	ORDER MULTIPLE
5381	Nylon Cable Clamps, pack of 54	1/8"	.050"	3/8"	PK	1
5382	Nylon Cable Clamps, pack of 48	1/4"	.050"	3/8"	PK	1
5383	Nylon Cable Clamps, pack of 41	3/8"	.050"	3/8"	PK	1
5384	Nylon Cable Clamps, pack of 35	1/2"	.050"	3/8"	PK	1
5385	Nylon Cable Clamps, pack of 21	5/8"	.060"	1/2"	PK	1
5380AX	Assortment	1/8" - 1"			EA	1

Pipe Hanging Strap

Non plated Steel Pipe hanging Strap is perfect for hanging pipes, fastening faucets and valves, as well as repair jobs.



CATALOG NO.	DESCRIPTION	SIZE	UOM	ORDER MULTIPLE
P1335	Pipe Hanging Strap; 28 gauge AWG	3/4" x 10'	EA	1

Cotter Pins

Cotter Pins provide smooth locking between two parts. This set includes an assortment of regular Cotter Pins with extended prongs.



CATALOG NO.	DESCRIPTION	UOM	ORDER MULTIPLE
6011	Cotter Pins: 1/16" x 1-1/2"; 3/32" x 1-1/2"; 1/8" x 1-1/2", pack of 51	PK	1

Motor Shaft Key Assortments

You can use choose from either a large assortment or a small assortment. The keys are made of cold rolled 1018 steel and are zinc plated.



CATALOG NO.	DESCRIPTION	UOM	ORDER MULTIPLE
6101	Small Assortment includes: 1/8" x 1/8" x 1-3/16"; 3/16" x 3/16" x 1-3/16"; 3/16" x 1/4" x 1-3/16"; 1/4" x 1/4" x 1-3/4"	EA	1
6102	Large Assortment includes: 1/4" x 1/4" x 1-3/4"; 5/16" x 5/16" x 3"; 3/8" x 3/8" x 3	EA	1

Hose Clamps

Hose Clamps have stainless steel housings and bands. The screws are plated steel and have slotted hex heads allowing a socket wrench, nut driver, or screwdriver to be used.



CATALOG NO.	DESCRIPTION	SAE NO.	SAE DIAMETER RANGE (in.)	APPROX. RANGE (in.)	UOM	ORDER MULTIPLE
HC6202	Hose Clamps, pack of 6	*	N/A	1/4 to 5/8	PK	1
HC6203	Hose Clamps, pack of 6	6	.44 - .78	5/16 to 7/8	PK	1
HC5410	Hose Clamps, pack of 6	10	.56 - 1.06	9/16 to 1-1/8	PK	1
HC5410X	Hose Clamps, pack of 10	10	.56 - 1.06	9/16 to 1-1/8	PK	1
HC5416	Hose Clamps, pack of 6	16	.81 - 1.50	3/4 to 1-1/2	PK	1
HC5416X	Hose Clamps, pack of 10	16	.81 - 1.50	3/4 to 1-1/2	PK	1
HC5420	Hose Clamps, pack of 6	20	.81 - 1.75	13/16 to 1-3/4	PK	1
HC5424	Hose Clamps, pack of 6	24	1.06 - 2.00	1-1/16 to 2	PK	1
HC5436	Hose Clamps, pack of 4	36	1.81 - 2.75	1-1/2 to 2-3/4	PK	1

Set Screws

Set Screws have cup points and hex socket heads. Class 3A threads. Made of heat treated alloy steel.



CATALOG NO.	DESCRIPTION	SIZE	UOM	ORDER MULTIPLE
6000	Large Assortment; course thread	1/4"-20; 5/16"-18; 3/8"-16	EA	1
6001	Small Assortment; fine thread	#8-32; #10-32; 1/4"-28	EA	1

*Items in this section are Underwriter's Laboratories listed or recognized under the prime manufacturer's name.



SPECIALTY FITTINGS

Grease Fittings

Case hardened steel fittings plated with yellow dip chromate and built-in ball checks. Assortment available in clear plastic box.

CATALOG NO.	DESCRIPTION	UOM	ORDER MULTIPLE
6311	Grease Fittings: 1/4"-28 Tapered Thread; straight, pack of 8	PK	1
6312	Grease Fittings: 1/8" Pipe Thread; straight, pack of 5	PK	1
6321	Grease Fittings: 1/4"-28 Tapered Thread; 90°, pack of 3	PK	1
6322	Grease Fittings: 1/8" Pipe Thread; 90°, pack of 3	PK	1
6310X	Assortment includes: 6311, 6312, 6321, 6322	EA	1

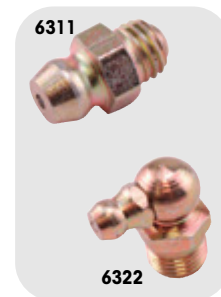

STORAGE CONTAINERS

Metal Parts Boxes

Metal Parts Boxes are prime cold rolled steel with baked gray enamel finish. The finish is rust and acid resistant. Each box comes with high impact plastic tray, positive pull down catch, and stick back parts labels for lid interiors.



CATALOG NO.	DESCRIPTION	NO. OF COMPARTMENTS	DIMENSIONS (L x W x D)	UOM	ORDER MULTIPLE
8200M	Metal Parts Box	21	13-3/8" x 9-1/4" x 2"	EA	1
8220M	Metal Parts Box	24	18" x 12" x 3"	EA	1

Satchel Style Case

Parts box made from rugged copolymer material with high impact translucent lid and handle on the side. 15 removable dividers allow up to 24 compartments.



CATALOG NO.	DESCRIPTION	NO. OF COMPARTMENTS	DIMENSIONS (L x W x D)	UOM	ORDER MULTIPLE
8233	Satchel Style Case	Up to 24	15" x 11-3/4" x 2-1/2"	EA	1

Polypropylene Parts Boxes

This box is ideal for holding your different sized nuts and bolts along with your additional bits. It can be stored in a tool box as well.



CATALOG NO.	DESCRIPTION	COLOR	NO. OF COMPARTMENTS	DIMENSIONS (L x W x D)	UOM	ORDER MULTIPLE
8201C	Polypropylene Parts Box Translucent		13	11" x 6-3/4" x 1-1/4"	EA	1
8203C	Polypropylene Parts Box Translucent		24	13-1/8" x 9" x 2-5/8"	EA	1

TAPES

Tape

Vinyl electrical tape. Part 5247 holds up to 7 pounds per square inch when attached to steel surface.



CATALOG NO.	DESCRIPTION	LENGTH	UOM	ORDER MULTIPLE
5255	Vinyl Electrical Tape	3/4" x 60'	EA	1

Teflon® Tape

This PTFE Tape is made of non toxic, pure white PTFE. The tape can be used with chemicals, solvents, oxygen, and on food lines. The product can withstand up to 2000 psi of pressure.



CATALOG NO.	DESCRIPTION	LENGTH	UOM	ORDER MULTIPLE
5246	Teflon® Thread Seal Tape	1/2" x 520'	EA	1



TESTERS, LEADS, CLIPS, FUSES

Clips

The clips are alligator clips and have vinyl red and black insulators.



CATALOG NO.	DESCRIPTION	UOM	ORDER MULTIPLE
5033	Steel Alligator Clips for use with test probes (.075"-.080"); 1-31/32" long; jaws open 5/16" max., pack of 2 red, 2 black, 4 clips	PK	1
5035	Copper Alligator Clips; 1-31/32" long; jaws open 5/16" max.; crimper slotted screw connection, pack of 2 red, 2 black, 4 clips	PK	1
5036	Steel Test Clips; 20A, 2-7/16" long; jaws open 5/8" max.; crimper slotted screw connection, pack of 1 red, 1 black, 2 clips	PK	1

Blade (Auto) Fuses

These fuses are used to protect circuits in the wiring harness that are usually found under the hood, in a fuse panel or supplementary panel near the battery. MAX fuses are used in domestic and import vehicles.



CATALOG NO.	DESCRIPTION	UOM	ORDER MULTIPLE
ED-AT3	Blade Fuse – 3 Amp – Purple, pack of 10	PK	1
ED-AT5	Blade Fuse – 5 Amp – Tan, pack of 10	PK	1

Test Leads

These are replacement leads.



CATALOG NO.	DESCRIPTION	UOM	ORDER MULTIPLE
5031	Low Voltage Test Leads; eight 22" long, color-coded leads with fully insulated alligator clips	EA	1
5041	Small Hook Type Low Voltage Test Leads; retractable hooks, 36" thermoplastic 22 gauge wire, nylon body/plunger, red/black	EA	1
5042	Large Hook Type Low Voltage Test Leads; retractable hooks, 36" PVC insulated 20 gauge wire, nylon body/plunger, red/black	EA	1
5046	Flexible Test Leads; steel alligator clips with vinyl red and black insulators; 36" 20 gauge wire; extremely flexible	EA	1

Dual Element Fuses – 250V

Provides time delay for temporary over-current conditions and motor running protection for heating and air conditioning equipment. Eliminates unnecessary maintenance from harmless overloads.



CATALOG NO.	DESCRIPTION	UOM	ORDER MULTIPLE
ED-CR15	Dual Element Fuse – 15 Amps, pack of 2	PK	1
ED-CR20	Dual Element Fuse – 20 Amps, pack of 2	PK	1
ED-CR25	Dual Element Fuse – 25 Amps, pack of 2	PK	1
ED-CR30	Dual Element Fuse – 30 Amps, pack of 2	PK	1
ED-CR35	Dual Element Fuse – 35 Amps, pack of 2	PK	1
ED-CR40	Dual Element Fuse – 40 Amps, pack of 2	PK	1
ED-CR45	Dual Element Fuse – 45 Amps, pack of 2	PK	1
ED-CR50	Dual Element Fuse – 50 Amps, pack of 2	PK	1
ED-CR60	Dual Element Fuse – 60 Amps, pack of 2	PK	1

U.L. Class RK-5, Standard for Safety 198E, Current Limiting Fuses, Interrupting Rating 200,000 Amps. rms. A.C.

WIRE

TFFN Stranded Hook-Up Wire*

Packaged in handy dispenser bag. Polyvinyl chloride insulation. Wire rating: 600V, 90°C. Insulation: oil resistant nylon coating.



CATALOG NO.	COLOR	GAUGE	STRANDS	O.D.	LENGTH	UOM	ORDER MULTIPLE
60331B	Black, pack of 50'	18	16	.09"	48'	PK	1
60331BE	Blue, pack of 50'	18	16	.09"	48'	PK	1
60331R	Red, pack of 50'	18	16	.09"	48'	PK	1
6332B	Black, pack of 50'	16	26	.10"	48'	PK	1
6332G	Green, pack of 50'	16	26	.10"	48'	PK	1
6332R	Red, pack of 50'	16	26	.10"	48'	PK	1
6332W	White, pack of 50'	16	26	.10"	48'	PK	1

THHN Stranded Hook-Up Wire*

Packaged in handy dispenser bag. Polyvinyl chloride insulation. Wire rating: 600V, 90°C. Insulation: oil resistant nylon coating.

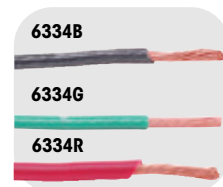

CATALOG NO.	COLOR	GAUGE	STRANDS	O.D.	LENGTH	UOM	ORDER MULTIPLE
6333B	Black, pack of 50'	14	19	.11"	48'	PK	1
6333G	Green, pack of 50'	14	19	.11"	48'	PK	1
6333R	Red, pack of 50'	14	19	.11"	48'	PK	1
6333W	White, pack of 50'	14	19	.11"	48'	PK	1
6334B	Black, pack of 50'	12	19	.13"	48'	PK	1
6334G	Green, pack of 50'	12	19	.13"	48'	PK	1
6334R	Red, pack of 50'	12	19	.13"	48'	PK	1
6334W	White, pack of 50'	12	19	.13"	48'	PK	1
6335B	Black, pack of 50'	10	19	.17"	48'	PK	1
6335G	Green, pack of 50'	10	19	.17"	48'	PK	1
6335R	Red, pack of 50'	10	19	.17"	48'	PK	1
6335W	White, pack of 50'	10	19	.17"	48'	PK	1
6360B	Black, pack of 50'	8	19	.22"	25'	PK	1
6360R	Red, pack of 50'	8	19	.22"	25'	PK	1
6360W	White, pack of 50'	8	19	.22"	25'	PK	1

WIRE cont'd

Thermostat Wire*

Thermoplastic insulated, jacketed wire for low voltage applications. Conductors are solid copper, individually insulated and color coded.



CATALOG NO.	DESCRIPTION	CONDUCTORS	WIRE GAUGE	LENGTH	UOM	ORDER MULTIPLE
6331	Thermostat Wire, pack of 40'	2	20	40'	PK	1
6336	Thermostat Wire, pack of 40'	3	20	40'	PK	1
6330-4	Thermostat Wire, pack of 40'	4	20	40'	PK	1
6337	Thermostat Wire, pack of 40'	5	20	40'	PK	1
6330-6	Thermostat Wire, pack of 40'	6	20	40'	PK	1
6338	Thermostat Wire, pack of 40'	8	20	40'	PK	1
6339XL	Thermostat Wire, pack of 40'	10	20	40'	PK	1

High Temperature Range Wire*

200°C glass braided, three conductor twisted wire. 600V; silicone rubber insulated. This product also contains a crimper.



CATALOG NO.	COLOR	WIRE GAUGE	LENGTH	UOM	ORDER MULTIPLE
6383-35	Black, Red, and White, pack of 5'	14	5'	PK	1
6383-325	Black, Red, and White, pack of 25'	14	25'	PK	1
6384-35	Black, Red, and White, pack of 5'	12	5'	PK	1
6384-325	Black, Red, and White, pack of 25'	12	25'	PK	1

SJTO Service Cord*

Features stranded bare copper, PVC insulation; PVC jacket. Cord is oil resistant. Cords have 3 individually insulated conductors. Ratings: 300V; 60°C.

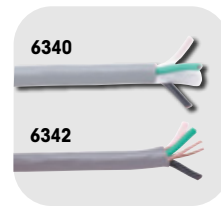

CATALOG NO.	DESCRIPTION	WIRE GAUGE	LENGTH	UOM	ORDER MULTIPLE
6340	SJTO Service Cord, pack of 12'	16	12'	PK	1
6341	SJTO Service Cord, pack of 20'	16	20'	PK	1
6342	SJTO Service Cord, pack of 12'	14	12'	PK	1
6343	SJTO Service Cord, pack of 20'	14	20'	PK	1

Stranded High Temperature Wire*

Thermoplastic equipment insulated wire. CSA listed at 105°C; 600V. Insulation thickness: .03". MTW/AWM/TEW

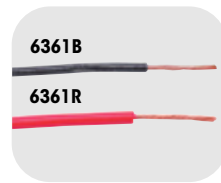

CATALOG NO.	COLOR	GAUGE	STRANDS	O.D.	LENGTH	UOM	ORDER MULTIPLE
6361B	Black, pack of 48'	18	16	.113"	48'	PK	1
6361R	Red, pack of 48'	18	16	.113"	48'	PK	1
6362B	Black, pack of 48'	16	26	.125"	48'	PK	1
6362W	White, pack of 48'	16	26	.125"	48'	PK	1
6363W	White, pack of 48'	14	19	.139"	48'	PK	1
6364B	Black, pack of 48'	12	19	.158"	48'	PK	1
6364R	Red, pack of 48'	12	19	.158"	48'	PK	1
6364W	White, pack of 48'	12	19	.158"	48'	PK	1
6365R	Red, pack of 48'	10	19	.182"	48'	PK	1

WIRING DEVICES

Thermoplastic Handle Plug*

This plug is a standard grade with flexible spring prongs and is furnished with a face washer. This product's rating is a 15A 125V and also contains a crimper.



CATALOG NO.	DESCRIPTION	MAX. CORD DIAMETER	POLES	WIRES	MATERIAL	UOM	ORDER MULTIPLE
ED179	Handle Plug	.406"	2	2	Thermoplastic	EA	1

Grounding Rubber Handle Plug*

The rubber back design allows for sure grip and protection against dirt and moisture entry. This plug is designed to operate in the widest possible temperature ranges.



CATALOG NO.	DESCRIPTION	FITS CORD DIAMETER	POLES	WIRES	RATING	UOM	ORDER MULTIPLE
ED1709	Grounding Handle Plug	.25"-.60"	2	3	15A-125V	EA	1

Tandem Grounding Rubber Handle Plug*

The rubber back design allows for sure grip and protection against dirt and moisture entry. This plug is designed to operate in the widest possible temperature ranges



CATALOG NO.	DESCRIPTION	FITS CORD DIAMETER	POLES	WIRES	RATING	UOM	ORDER MULTIPLE
ED1711	Tandem Handle Plug	.25"-.60"	2	3	15A-250V	EA	1

Armored Plug*

This plug has a round dead front and is vinyl enclosed.



CATALOG NO.	DESCRIPTION	FITS CORD DIAMETER	POLES	WIRES	RATING	UOM	ORDER MULTIPLE
ED2867	Armored Plug	.25"-.625"	2	3	15A-125V	EA	1



WIRING DEVICES cont'd

Right Angle Plug*

Our right angle plug is ergonomically designed fluted body with radial gripping ridge creates an ideal surface for gripping and pulling.



CATALOG NO.	DESCRIPTION	FITS CORD DIAMETER	POLES	WIRES	RATING	UOM	ORDER MULTIPLE
ED4409	Right Angle Plug	.25"-.655"	2	3	20A-125V	EA	1
ED4509	Right Angle Plug	.25"-.655"	2	3	20A-250V	EA	1
ED4867	Right Angle Plug	.25"-.655"	2	3	15A-125V	EA	1

Armored Connector*

The Armor Connector is ideal for shops, garages, and heavier duty work areas. Vinyl enclosed.



CATALOG NO.	DESCRIPTION	FITS CORD DIAMETER	POLES	WIRES	RATING	UOM	ORDER MULTIPLE
ED2887	Armored Connector	.225"-.60"	2	3	15A-125V	EA	1

Triple Outlets*

These outlets are polarized and are made of high impact resistant plastic.



CATALOG NO.	DESCRIPTION	RATING	UOM	ORDER MULTIPLE
5223	Heavy duty, 2 pole, 3 wire	15A-125V	EA	1

Receptacles*

Our receptacles are available in either singles or duplexes. This is a 2 pole, 3 wire product with ground included. Standard Grade.



CATALOG NO.	DESCRIPTION	RATING	COLOR	UOM	ORDER MULTIPLE
ED1876	Single Receptacle	20A-250V	Brown	EA	1
ED1876-I	Single Receptacle	20A-250V	Ivory	EA	1
ED1877	Single Receptacle	20A-125V	Brown	EA	1
ED270**	Duplex Receptacle	15A-125V	Brown	EA	1
ED270-I**	Duplex Receptacle	15A-125V	Ivory	EA	1
ED877	Duplex Receptacle	20A-125V	Brown	EA	1

**Standard Grade

Rubber Connector*

This is a standard grade rubber connector with a 3 pole opening.



CATALOG NO.	DESCRIPTION	FITS CORD DIAMETER	POLES	WIRES	RATING	UOM	ORDER MULTIPLE
ED252	Rubber Connector	.25"-.60"	2	3	15A-125V	EA	1

Ground Adapter*

This adapter is polarized with 2 pole to 3 wire grounding. The body is made of polypropylene.



CATALOG NO.	DESCRIPTION	RATING	UOM	ORDER MULTIPLE
ED419	Ground Adapter	15A-125V	EA	2

Power Supply Replacement Cords*

For power tools or appliances. Black vinyl cord is flexible in very cold environments. Wire type is SJEW-A.



CATALOG NO.	DESCRIPTION	WIRE	RATING	LENGTH	UOM	ORDER MULTIPLE
5240	Black Replacement Cord	16/3	13A/125V	10'	EA	1
5242	Black Replacement Cord	14/3	15A/125V	10'	EA	1

Toggle Switch and Receptacle Combination Device*

This device is a single pole switch with 15A 120V AC. The receptacle is 15A 125V AC and it is a 2 pole, three wire grounding.



CATALOG NO.	DESCRIPTION	UOM	ORDER MULTIPLE
ED5225	Toggle Switch and Receptacle - Brown Body	EA	1

*Items in this section are Underwriter's Laboratories listed or recognized under the prime manufacturer's name.

WIRING DEVICES cont'd

Metal Bat Handle Toggle Switches*

Features black phenolic plastic case; brass terminals; steel and zinc chromate frame and support; all other external parts are brass/bright nickel. These heavy duty toggle switches have screw terminals. Part ED447 has an "ON-OFF" face plate.

Specifications: 10A/277V–20A/125V AC

Single Pole: 3/4HP 125–250V AC

Double Pole: 1-1/2HP 125–250V AC



ED447

CATALOG NO.	DESCRIPTION	SEQUENCE	CIRCUIT	UOM	ORDER MULTIPLE
ED447	Bat Handle Toggle Switch	ON-OFF	Single Pole, Single Throw	EA	1
ED453	Bat Handle Toggle Switch	ON-ON	Double Pole, Double Throw	EA	1
ED454	Bat Handle Toggle Switch	ON-ON	Single Pole, Double Throw	EA	1
ED455	Bat Handle Toggle Switch	ON-OFF	Double Pole, Single Throw	EA	1
ED468	Bat Handle Toggle Switch	ON-OFF-ON	Single Pole, Double Throw	EA	1
ED494	Bat Handle Toggle Switch	ON-OFF-ON	Double Pole, Double Throw	EA	1
ED448B	Bat Handle Toggle Switch	ON-OFF	Single Pole, Single Throw	EA	1

Toggle Switch with Neon Pilot Light Combination Device*

Switch: 15A-120V AC

Neon Pilot Light: 1/25W, 120V AC



ED277

CATALOG NO.	DESCRIPTION	UOM	ORDER MULTIPLE
ED277	Toggle Switch with Neon Pilot Light – Brown Body	EA	1

Utility Fuse Outlets*

This is designed to break up electrical surges on equipment.



PI381

CATALOG NO.	DESCRIPTION	UOM	ORDER MULTIPLE
PI381	Utility Fuse Outlet and Switch with Cover; 1/2HP-125V AC only; galvanized steel construction	EA	1

6180 Series Terminal Blocks*

These terminal blocks are constructed of high barrier thermoplastic are rated 20A 250V.



6182

CATALOG NO.	DESCRIPTION	NO. OF POSITIONS	LENGTH (in.)	WIDTH (in.)	SCREW SIZE	MAX. WIRE SIZE	UOM	ORDER MULTIPLE
6182	Terminal Block	4	2.16	.88	6-32	22-14	EA	1
6183	Terminal Block	6	2.91	.88	6-32	22-14	EA	1
6184	Terminal Block	8	3.66	.88	6-32	22-14	EA	1
6185	Terminal Block	10	4.41	.88	6-32	22-14	EA	1
6186	Terminal Block	12	5.16	.88	6-32	22-14	EA	1
6187	Terminal Block	14	5.91	.88	6-32	22-14	EA	1

Toggle Switches*

Our toggle switch is a silent switch with ground included. Standard Grade.

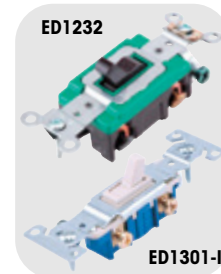

ED1232

ED1301-I

CATALOG NO.	DESCRIPTION	RATING	COLOR	UOM	ORDER MULTIPLE
ED1240-2	Single Pole	15A–120/277V AC	Brown	EA	1
ED1238	Single Pole	20A–120/277V AC	Brown	EA	1
ED1301**	Single Pole	15A–120V AC	Brown	EA	1
ED1301-I**	Single Pole	15A–120V AC	Ivory	EA	1
ED1262-2	Double Pole	15A–120/277V AC	Brown	EA	1
ED1262-2I	Double Pole	15A–120/277V AC	Ivory	EA	1
ED1232	Double Pole	30A–120/277V AC	Brown	EA	1

**Standard Grade

Porcelain Outlet Box Lampholders*

Features one-piece pull chain. Two screw terminals, 2 pole, 2 wire. 4-1/2" outer diameter. These lamp- holders fit 3-1/4" and 4" boxes. Rating: Lampholder: 660W/125V. Outlet: 15A/125V.



ED9726

CATALOG NO.	DESCRIPTION	UOM	ORDER MULTIPLE
ED9726	Porcelain Outlet Box Lampholder – U ground outlet	EA	1

Fuse Holders

Used to mount and protect fuses, fuse holders also enable fuses to be changed quickly and easily. Fuse holders are used in a variety of applications, including consumer electronics, industrial, telecom and datacom, automotive, and many others.



EM480

EM484

CATALOG NO.	DESCRIPTION	UOM	ORDER MULTIPLE
EM480	In-Line Fuse Holder for use with 1-1/4 x 1/4" fuses up to 20 amps, 32 volts, 15" lead; 14 gauge red vinyl insulated wire	EA	1
EM484	Self-Stripping Fuse Holder mates with blade-type fuse .205 x .025". 18-14 AWG. Size: 1.37" L x .44" H x .95" W Max. Insulation Outer Diameter: .145"	EA	2

*Items in this section are Underwriter's Laboratories listed or recognized under the prime manufacturer's name.



WIRING DEVICES cont'd

Vinyl Grommet Assortment Packs

These grommets exhibit high dielectric strength and are oil, ozone, and UV resistant.



CATALOG NO.	DESCRIPTION	UOM	ORDER MULTIPLE
ED320	General Assortment – contains all grommet sizes	EA	1

Heat Shrink Tubing Assortments*

Heat Shrink Tubing is made of flame-retardant polyolefin. Thin walled, all purpose tubing. Rated 600V, 125°C. 2500 volts/mil. dielectric strength. Inert to fungus. Virtually unaffected by corrosives, common fluids, and solvents. Pieces are 6" in length.



CATALOG NO.	COLOR	INNER DIAMETER		UOM	ORDER MULTIPLE
		MAX SUPPLIED	MIN. RECOVERED		
6370	Black & White, pack of 12	1/8", 1/4"	1/16", 1/8"	PK	1
6371	Black & White, pack of 7	1/8", 1/4", 3/8"	1/16", 1/8", 3/16"	PK	1
63070	Black, pack of 3	3/8" – 1/2"	3/16" – 1/4"	PK	1

Indicator Lights

Terminals are tin plated brass. Wire leads are 22 AWG, 4.4"–4.8" long, 1/2" stripped. Mounting will snap-fit into .500-.505 diameter hole in .020"-.100" thick panels.



CATALOG NO.	LENS COLOR	LENS MATERIAL	VOLTAGE	BULB TYPE	UOM	ORDER MULTIPLE
ED600	Red, pack of 2	Polycarbonate	28V	Incandescent	PK	1
ED601	Green, pack of 2	Polycarbonate	28V	Incandescent	PK	1
ED602	Amber, pack of 2	Polycarbonate	28V	Incandescent	PK	1
ED603	Blue, pack of 2	Polycarbonate	28V	Incandescent	PK	1
ED610	Red, pack of 2	Nylon	105–125V AC	Neon	PK	1
ED611	Green, pack of 2	Polycarbonate	105–125V AC	Neon**	PK	1
ED612	Amber, pack of 2	Nylon	105–125V AC	Neon	PK	1
ED613	Blue, pack of 2	Polycarbonate	105–125V AC	Neon†	PK	1
ED620	Red, pack of 2	Polycarbonate	208–250V AC	Neon	PK	1
ED621	Green, pack of 2	Polycarbonate	208–250V AC	Neon**	PK	1

6190 Series Terminal Blocks*

These terminal blocks are constructed of phenolic 9/16 in. centers. They are rated 30A 600V.



CATALOG NO.	DESCRIPTION	NO. OF POSITIONS	LENGTH (in.)	WIDTH (in.)	SCREW SIZE	MAX. WIRE SIZE	UOM	ORDER MULTIPLE
6193	Terminal Block	6	4.34	1.31	8-32	14-12	EA	1
6194	Terminal Block	8	5.47	1.31	8-32	14-12	EA	1
6195X	Terminal Block	10	6.59	1.31	8-32	14-12	EA	1

Indicator Lights*

Terminals are tin plated brass. Wire leads are 22 AWG, 4.4"–4.8" long, 1/2" stripped. .31" minimum diameter mounting.



CATALOG NO.	LENS COLOR	LENS MATERIAL	VOLTAGE	BULB TYPE	UOM	ORDER MULTIPLE
ED710	Red, pack of 2	Polycarbonate	105–125V AC	Neon	PK	1

Winged Wire Connectors*

Durable thermoplastic material. Flame retardant, abrasion resistant, non porous, and non corrosive. Expandable spring grips into the wire and adjusts itself to the wire size and shape so pre twisting is unnecessary. Even during temperature changes, they resist vibrations and retain holding power. Parts 8284 and 8286 are for use with copper to copper, aluminum to aluminum, and copper to aluminum (dry locations only).



CATALOG NO.	DESCRIPTION	UOM	ORDER MULTIPLE
8284	Small Yellow Winged Wire Connectors, pack of 18	PK	1
8284CX-B	Small Yellow Winged Wire Connectors, pack of 100	PK	1
8286	Medium Red Winged Wire Connectors, pack of 14	PK	1
8286CX-B	Medium Red Winged Wire Connectors, pack of 100	PK	1
8282LX	X-Large Blue Winged Wire Connectors, pack of 50	PK	1

-B indicates boxed product. All other catalog numbers are poly bagged.

*Items in this section are Underwriter's Laboratories listed or recognized under the prime manufacturer's name.

Standard Wire Connectors*

Connectors are color coded with spring inserts. Heat resistant (105°C) thermoplastic. Connectors are for copper to copper connections. Parts 6294 and 6296 can connect aluminum to aluminum and copper to aluminum (dry locations only).

6292



CATALOG NO.	DESCRIPTION	UOM	ORDER MULTIPLE
6291	Mini Gray Standard Wire Connectors, pack of 29	PK	1
6291CX	Mini Gray Standard Wire Connectors, pack of 100	PK	1
6292	Tiny Blue Standard Wire Connectors, pack of 25	PK	1
6292CX	Tiny Blue Standard Wire Connectors, pack of 100	PK	1
6293	Small Orange Standard Wire Connectors, pack of 20	PK	1
6293CX	Small Orange Standard Wire Connectors, pack of 100	PK	1
6294	Medium Yellow Standard Wire Connectors, pack of 18	PK	1
6294CX	Medium Yellow Standard Wire Connectors, pack of 100	PK	1
6296	Large Red Standard Wire Connectors, pack of 12	PK	1
6296CX	Large Red Standard Wire Connectors, pack of 100	PK	1
6298	X-Large Gray Standard Wire Connectors, pack of 6	PK	1
6298LX	X-Large Gray Standard Wire Connectors, pack of 50	PK	1
6295X	Assortment: Includes 6291, 6292, 6293, 6294, 6296	EA	1

Aluminum Solderless Lugs*

Our aluminum solder less lug are made from high strength aluminum alloy. These lugs are suitable for use with either copper or aluminum conductors.



PI221

CATALOG NO.	DESCRIPTION	WIRE RANGE	AMP RATING	UOM	ORDER MULTIPLE
PI221	Small Lug for aluminum or copper wire, pack of 6	4-14	2	PK	1
PI222	Large Lug for aluminum or copper wire, pack of 6	2-14	2	PK	1

Pigtails

The wire has a #10 spade on one end and a 10 32 x 3/8in. slotted round head screw on the other. This allows for easy positioning in the outlet box.

PI337-3



CATALOG NO.	DESCRIPTION	WIRE LENGTH	WIRE GAUGE	WIRE TYPE	UOM	ORDER MULTIPLE
PI337-3	Pigtails, pack of 5	8"	14	Stranded	PK	1

Cable Markers

Cable markers come in books of 450 markers with matching terminal markers. Markers are mounted on dispenser cards in the book. Cable markers are suitable for above and below ground applications. Books are made of vinyl impregnated cloth that resists moderate amounts of dirt, oil and heat. The blank Write-On Markers (WM1014) are made of durable vinyl film that resists water, oils, and fungus. They can also withstand extremes in temperature.



WM1002

CATALOG NO.	DESCRIPTION	UOM	ORDER MULTIPLE
WM1002	Alpha-Numeric Cable Marker Book; contains 10 each: A-Z, 0-15, +, -, /	EA	1
WM1003	Numeric Cable Marker Book; contains 10 each: 1-45	EA	1
WM1009	Line and Terminal Cable Marker Book; contains 45 each: 1, 2, 3, A, B, C; contains 30 each: T1, T2, T3, L1, L2, L3	EA	1
WM1014	180 Blank Write-On Markers, 1/2" x 1-1/2"	EA	1

Porcelain Wire Connectors*

For high temperature applications over 105°C (300 volts maximum). For stranded copper connections only.

4293



CATALOG NO.	DESCRIPTION	UOM	ORDER MULTIPLE
4293	Small White Porcelain Wire Connectors, pack of 17	PK	1
4293CX	Small White Porcelain Wire Connectors, pack of 100	PK	1
4294	Medium White Porcelain Wire Connectors, pack of 15	PK	1
4294CX	Medium White Porcelain Wire Connectors, pack of 100	PK	1
4296	Large White Porcelain Wire Connectors, pack of 13	PK	1
4296CX	Large White Porcelain Wire Connectors, pack of 100	PK	1

Electrolytic Copper Solderless Lugs*

Our solder less lugs are manufactured from high strength pure electrolytic copper to insure both maximum strength and conductivity.

PI227



CATALOG NO.	DESCRIPTION	WIRE RANGE	AMP RATING	UOM	ORDER MULTIPLE
PI227	Medium Lug for copper wire, pack of 6	6-14	35-50	PK	1
PI228	Large Lug for copper wire, pack of 6	4-14	70	PK	1

Split Bolt Connectors*

These connectors are made of silicone bronze and are designed for copper use only.

PI327



CATALOG NO.	DESCRIPTION	MAX. SOLID WIRE	MAX. STRANDED WIRE	UOM	ORDER MULTIPLE
PI326	Split Bolt Connector, pack of 3	10	12	PK	1
PI327	Split Bolt Connector, pack of 3	8	8	PK	1
PI328	Split Bolt Connector, pack of 3	6	7	PK	1
PI929	Split Bolt Connector, pack of 3	4	5	PK	1

Ground Fitting Clamp*

A ground fitting clamp is ideal for surface mounting small amounts of electrical wiring or communication cables.

PI237



CATALOG NO.	DESCRIPTION	UOM	ORDER MULTIPLE
PI237	For 8, 6, 4 bare grounding wire; fits 1/2"-1" pipe	EA	1

*Items in this section are Underwriter's Laboratories listed or recognized under the prime manufacturer's name.

**Neon bulb incorporates G2B lamp and resistor.

* Neon bulb incorporates T2B lamp and resistor.

ELECTRICAL

Capacitors.....	95-96
Conduit, Fittings, Cable	93-94
Contactors.....	98-99
DiversiTech Electrical Disconnects.....	92
Eaton Electrical Disconnects.....	93
Electrical Supplies	104-107
Electrical Tapes.....	108-109
Fan Centers.....	101
Fuses	101-102
Hard Start Kits	98
Monitors.....	103
Motor Brackets	93
Motor Run Capacitors (USA Made).....	97
Motors	86-90
Relays.....	100
Stranded Copper THHN Wire.....	113-114
Surge Protectors	104
Terminals, Connectors.....	109-110
Thermal Controls	111
Thermostat Guards	112
Thermostat Wire	113
Thermostats	111
Time Delays	103
Transformers	100
Whips	91-92
Wire Connectors.....	114-115
Wire/Cable Ties, Mounts, Clamps	115-116



MOTORS

Wagner® Single Speed Condenser Fan Motors

- Installs with all Standard 48 Frame Mounting Brackets
- Standard Shaft Length, Diameter, and Flats
- Drain Holes with Plugs in both end plates
- Automatic Thermal Overload Protector
- Standard 48 Frame Motor Casing Size
- Low Power Consumption
- 60 C Ambient Design
- Electrically Reversible
- Continuous Air Over
- Class B Insulation
- Quiet Operation
- Extended Studs
- 30" Leads
- 60 HZ



BALL BEARINGS NOW STANDARD



CATALOG NO.	HP	VOLTAGE	SPEED	FLA	UOM	ORDER MULTIPLE
WG840727	1/6	208-230	1075/1	1.3	EA	1
WG840728	1/4	208-230	1075/1	2.2	EA	1
WG840729	1/3	208-230	1075/1	2.8	EA	1
WG840730	1/2	208-230	1075/1	4.2	EA	1
WG840731	3/4	208-230	1075/1	4.5	EA	1
WG840203	1/6	208-230	825/1	1.3	EA	1
WG840204	1/4	208-230	825/1	1.5	EA	1
WG840205	1/3	208-230	825/1	2.2	EA	1
WG840746	1/2	208-230	825/1	2.9	EA	1

Wagner® High Temperature Condenser Fan Motors

- 70°C Ambient Temperature
- Installs with all Standard 48 Frame Mounting Brackets
- Standard Shaft Length, Diameter, and Flats
- Drain Holes with Plugs in both end plates
- Automatic Thermal Overload Protector
- Standard 48 Frame Motor Casing Size
- Low Power Consumption
- Electrically Reversible
- Continuous Air Over
- Class B Insulation
- Quiet Operation
- Extended Studs
- 30" Leads
- 60 HZ



BALL BEARINGS NOW STANDARD



CATALOG NO.	HP	VOLTAGE	SPEED	FLA	UOM	ORDER MULTIPLE
WG840727HT	1/6	208-230	1075/1	1.3	EA	1
WG840728HT	1/4	208-230	1075/1	2.2	EA	1
WG840729HT	1/3	208-230	1075/1	2.8	EA	1
WG840730HT	1/2	208-230	1075/1	4.2	EA	1
WG840731HT	3/4	208-230	1075/1	5.3	EA	1
WG840736HT	1/4	460	1075/1	1.65	EA	1
WG840737HT	1/3	460	1075/1	2.85	EA	1
WG840738HT	1/2	460	1075/1	4.3	EA	1
WG840739HT	3/4	460	1075/1	5.3	EA	1
WG840203HT	1/6	208-230	825/1	1.3	EA	1
WG840204HT	1/4	208-230	825/1	1.5	EA	1
WG840205HT	1/3	208-230	825/1	2.2	EA	1
WG840746HT	1/2	208-230	825/1	2.9	EA	1

Wagner® Multiple Horsepower Condenser Fan Motors

The Multi-Horsepower motors are specially designed to cover a range of applications. The condenser fan motors range from 1/2 to 1/5; 1/3 to 1/6 both at 1075 rpm; 1/3 to 1/6 at 825rpm. These motors feature reversing plugs, extended thru bolts 36 inch leads and are designed for 370 volt capacitors. Installs with all 48 frame mounting brackets.



BALL BEARINGS NOW STANDARD



CATALOG NO.	APPLICATION	VOLTAGE	SPEED	(1) HP-FLA	(2) HP-FLA	(3) HP-FLA	(4) HP-FLA	(5) HP-FLA	UOM	ORDER MULTIPLE
WG840458	CF	208-230	1075/1	1/3-2.8	1/4-1.8	1/5-1.7	1/6-1.6	-	EA	1
WG840459	CF	208-230	825/1	1/3-2.1	1/4-1.55	1/5-1.4	1/6-1.34	1/8-1.3	EA	1
WG840465	CF	208-230	1075/2	1/3-2.8	1/4-2.0	1/5-1.7	1/6-1.5	-	EA	1
WG840468	CF	208-230	1075/2	1/2-3.0	1/3-2.5	1/4-2.0	1/5-1.3	-	EA	1
WG840469	CF	208-230	825/2	1/3-2.1	1/4-1.7	1/5-1.5	1/6-1.2	-	EA	1

Wagner® High Temperature Multiple Horsepower Condenser Fan Motors

The Multi-Horsepower motors are specially designed to cover a range of applications. The condenser fan motors range from 1/2 to 1/5; 1/3 to 1/6 both at 1075 rpm; 1/3 to 1/6 at 825rpm. These motors feature reversing plugs, extended thru bolts, 36 inch leads and are designed for 370 volt capacitors. Installs with all 48 frame mounting brackets.



**BALL BEARINGS
NOW STANDARD**



CATALOG NO.	APPLICATION	VOLTAGE	SPEED	(1) HP-FLA	(2) HP-FLA	(3) HP-FLA	(4) HP-FLA	(5) HP-FLA	UOM	ORDER MULTIPLE
WG840465HT	CF	208-230	1075/2	1/3-2.8	1/4-2.0	1/5-1.7	1/6-1.5	-	EA	1
WG840469HT	CF	208-230	825/2	1/3-1.9	1/4-1.7	1/5-1.5	1/6-1.2	-	EA	1
WG840468HT	CF	208-230	1075/2	1/2-3.8	1/3-2.5	1/4-2.0	1/5-1.5	-	EA	1
WG840459HT	CF	208-230	825/1	1/3-2.1	1/4-1.55	1/5-1.4	1/6-1.34	1/8-1.3	EA	1
WG840458HT	CF	208-230	1075/1	1/3-2.8	1/4-1.8	1/5-1.7	1/6-1.6	-	EA	1
WG840884HT	CF	460	825/1	1/3-1.1	1/4-0.82	1/5-0.72	1/6-0.7	1/8-0.68	EA	1

Wagner® Direct Drive Furnace Blower Motors

- Installs with all Standard 48 Frame Mounting Brackets
- Standard Shaft Length, Diameter, and Flats
- Uses 370V Capacitors
- Standard 48 Frame Motor Casing Size
- 2.5" Diameter Hub Rings included
- Low Power Consumption
- Automatic Thermal Overload Protector
- Continuous Duty, Air Over
- Electrically Reversible
- Class B Insulation
- Speed: 1075/3
- Quiet Operation
- 60 HZ



CATALOG NO.	HP	VOLTAGE	SPEED	FLA	UOM	ORDER MULTIPLE
WG840583	1/4	115	1075/3	4.2	EA	1
WG840584	1/4	208-230	1075/3	2.0	EA	1
WG840585	1/3	115	1075/3	5.5	EA	1
WG840586	1/3	208-230	1075/3	2.8	EA	1
WG840587	1/2	115	1075/3	7.5	EA	1
WG840588	1/2	208-230	1075/3	3.6	EA	1
WG840589	3/4	115	1075/3	10.2	EA	1
WG840590	3/4	208-230	1075/3	5.5	EA	1
WG840595	1	115	1075/3	12.6	EA	1
WG840596	1	208-230	1075/3	5.59	EA	1

Wagner® Multiple Horsepower Furnace Blower Motors

The Multi-Horsepower motors are specially designed to cover a range of applications. The direct drive furnace blower motors range from 1/2 to 1/6 in both 115 and 230 volts and 3/4 to 1/5 in both 115 and 230 volts all at 1075rpm. These motors feature reversing plugs, extended thru bolts 36 inch leads and are designed for 370 volt capacitors. Installs with all 48 frame mounting brackets.

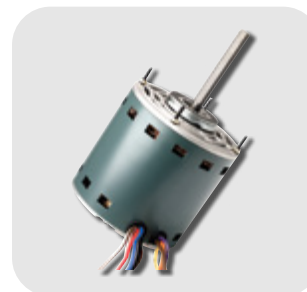

CATALOG NO.	APPLICATION	VOLTAGE	SPEED	(1) HP-FLA	(2) HP-FLA	(3) HP-FLA	(4) HP-FLA	(5) HP-FLA	UOM	ORDER MULTIPLE
WG840463	DDFB	115	1075/4	1/2-7.0	1/3-6.7	1/4-4.4	1/5-3.2	1/6-2.4	EA	1
WG840464	DDFB	208-230	1075/4	1/2-3.9	1/3-3.6	1/4-2.5	1/5-1.8	1/6-1.3	EA	1
WG840466	DDFB	115	1075/4	3/4-8.1	1/2-6.6	1/3-4.6	1/4-3.8	1/5-3.1	EA	1
WG840467	DDFB	208-230	1075/4	3/4-3.8	1/2-3.7	1/3-2.5	1/4-1.8	1/5-1.7	EA	1

MOTORS cont'd

Evergreen® CM ECM Motors

The Evergreen CM is made with the same field-proven, high-efficiency ECM technology that has been used for more than 20 years in new HVAC equipment. It features flexible control methods to help the installer balance airflow in HVAC systems such as VAV (Variable Air Volume) boxes and Packaged HVAC systems. The Evergreen CM is designed as a direct replacement for OEM (Original Equipment Manufacturer) Genteq model X13 (Constant Torque ECM) or as a field replacement for existing PSC (Permanent Split Capacitor) motors.

CATALOG NO.	HP	VOLTAGE	SPEED	FLA	RPM	SHAFT	UOM	ORDER MULTIPLE
6703CM	1/3	208-230/277	5/PWM	2.8	1075	.5"X4" (3.5" SF)	EA	1
6705CM	1/2	208-230/277	5/PWM	4.1	1075	.5"X4" (3.5" SF)	EA	1
6707CM	3/4	208-230/277	5/PWM	6.0	1075	.5"X4" (3.5" SF)	EA	1
6710CM	1	208-230/277	5/PWM	7.6	1075	.5"X4" (3.5" SF)	EA	1
6405CM	1/2	460	5/PWM	2.1	1075	.5"X4" (3.5" SF)	EA	1
6407CM	3/4	460	5/PWM	3.2	1075	.5"X4" (3.5" SF)	EA	1
6410CM	1	460	5/PWM	4.0	1075	.5"X4" (3.5" SF)	EA	1

6703CM



Evergreen® EM ECM Motors

The Evergreen EM was designed to replace direct-drive blower motors in residential and light commercial indoor furnaces, air handlers and package systems that were designed with a standard ECM motor, such as X13 or equivalent competitor model. It can also be used to retrofit PSC motors in commercial building series VAV boxes and packaged heat pump systems. It is NOT intended to replace premium ECM constant airflow products, such as EON, 2.3, 3.0 and 2.5.

CATALOG NO.	HP	VOLTAGE	SPEED	FLA	RPM	SHAFT	UOM	ORDER MULTIPLE
6103E	1/3	115	5/PWM	4.8	1075	.5" X 5" (4.5" SF)	EA	1
6105E	1/2	115	5/PWM	6.8	1075	.5" X 5" (4.5" SF)	EA	1
6107E	3/4	115	5/PWM	8.4	1075	.5" X 5" (4.5" SF))	EA	1
6110E	1	115	5/PWM	10.9	1075	.5" X 5" (4.5" SF)	EA	1
6203E	1/3	208/230	5/PWM	2.8	1075	.5" X 5" (4.5" SF)	EA	1
6205E	1/2	208/230	5/PWM	4.1	1075	.5" X 5" (4.5" SF)	EA	1
6207E	3/4	208/230	5/PWM	6.0	1075	.5" X 5" (4.5" SF)	EA	1
6210E	1	208/230	5/PWM	7.6	1075	.5" X 5" (4.5" SF)	EA	1

6103E



Evergreen® IM ECM Motors

The Evergreen IM is an ECM designed to replace an existing PSC (Permanent Split Capacitor), direct drive, indoor blower motor. It is constructed with more than 20 years of proven ECM technology and reliability.

CATALOG NO.	HP	VOLTAGE	SPEED	FLA	RPM	SHAFT	UOM	ORDER MULTIPLE
6005	1/2 (1/2, 1/3, 1/4)	115/230	5	6.7/4.0	1075	.5" X 5" (4.5" SF)	EA	1
6010	1 (1, 3/4, 1/2)	115/230	5	11.0/6.7	1075	.5" X 5" (4.5" SF)	EA	1

6005



Evergreen® OM ECM Motors

The Evergreen Outdoor Motor, also known as Evergreen OM, is designed for direct-drive fan propeller applications in residential systems up to 5-tons. Easily replaces 6 Pole (1,100 rpm rated) and 8 pole (850 rpm rated) shaded pole or PSC motors.

CATALOG NO.	HP	VOLTAGE	SPEED	FLA	RPM	SHAFT	UOM	ORDER MULTIPLE
6301	1/5	208-240	2	2.8	850/1100	.5" X 3" (2.5" SF)	EA	1
6303	1/3	208-240	2	3.5	850/1100	.5" X 3" (2.5" SF)	EA	1
6903	1/3	460	2/PWM	1.6	850/1100	.5" X 6" (5.5" SF)	EA	1
6905	1/2	460	2/PWM	2.5	850/1100	.5" X 6" (5.5" SF)	EA	1
6907	3/4	460	2/PWM	3.1	850/1100	.5" X 6" (5.5" SF)	EA	1



Evergreen® PF ECM Motors

The Evergreen PF is a drop-in replacement or proactive upgrade for pedestal and wall mount fan motors in warehouses, factory floors, amusement parks, institutional buildings and other similar applications. With a rated efficiency of up to 82% and three operating speeds, Evergreen PF makes is easy to provide energy savings and reduce operating noise. It is easy for retrofit as it comes with a power cord, switch and welded mount. The Evergreen PF also includes a pull chain for easy speed selection from 1160/970/650 operating speeds.

CATALOG NO.	HP	VOLTAGE	SPEED	FLA	RPM	SHAFT	UOM	ORDER MULTIPLE
6803	1/3	115	3	5.8	1160/970/650	.5" X 3" (2.5" SF)	EA	1



Evergreen® InTune™ Programmer for ECM Motors

InTune is two components - a WIFI programmer (catalog #5K006) that connects in series with the motors existing connections and a free app. The WIFI programmer is purchased once and re-used on each motor during the tuning process. Free apps are available at the App Store and Google Play.

CATALOG NO.	Description	UOM	ORDER MULTIPLE
5K006	Evergreen InTune™ WIFI Programmer	EA	1



MOTORS cont'd

Fasco® OEM Replacement Draft Inducers

Designed, engineered and life-tested in the USA by FASCO. OEM approved for aftermarket replacement.

- Performance to match the original design.
- Fit for proper operation of the safety pressure switch and condensate management system.
- UL recognized, CSA or cUL certified.
- Safety for your customers and your business.



CATALOG NO.	HP	VOLTAGE	SPEED	AMPS	TYPE	RPM	ROT.	BRNG.	FRAME	OEM CROSS REFERENCE	UOM	ORDER MULTIPLE
AMANA												
A129	1/20	115	1	1.95	SP	3250	CW	SLV	3.3	Amana, 7021-9064, 7021-9259	EA	1
ARMSTRONG												
A155	1/30	115	1	1.4	SP	3000	CCW	BALL	3.3	7021-10046	EA	1
GOODMAN												
A140	1/50	115	1	1.4	SP	3400	CW	SLV	3.3	7021-9087, 7021-9000	EA	1
A157	1/35	115	1	1.3	SP	3000	CCW	SLV	-	7002-2307	EA	1
A182	1/35	115	1	1.2	SP	3125	CCW	SLV	3.3	7002-3036, B4059000	EA	1
INTERCITY PRODUCTS												
A051	1/60	115	1	1.6	SP	3000	CW	BALL	-	1013833, J238-1393	EA	1
A067	1/20	115	1	2.6	SP	3000	CW	BALL	3.3	1014338 119225-00	EA	1
A134	1/25	115	1	1.5	SP	3060	CW	SLV	3.3	7021-9335, 7021-8735, 7021-9499, 7021-8736	EA	1
A169	1/25	230	1	0.75	SP	2800	CW	SLV	3.3	7021-10048, 7021-10580	EA	1
A170	1/25	115	1	2.3	SP	3400	CCW	BALL	3.3	7021-10702, 7021-10299	EA	1
A171	1/25	115	1	0.7	PSC	3450	CCW	BALL	3.3	7062-4783, 1011412	EA	1
A172	1/35	115	1	1.6	SP	3000	CW	BALL	-	7002-2792, 1010975P	EA	1
A173	1/18	115	1	0.8	PSC	3450	CCW	BALL	3.3	7062-4578, 1011350	EA	1
JANITROL												
A079	1/50	115	1	1.1	SP	3000	CCW	SLV	3.3	7062-6804	EA	1
JOHNSON FURNACE												
A081¹	1/40	230	1	0.5	SP	3000	CCW	BALL	3.3	HWC Series Unit	EA	1
LENNOX												
A163	1/20	115	1	1.8	SP	3400	CCW	BALL	3.3	7021-9450	EA	1
A200	1/30	115	1	1.95	SP	3000	CCW	BALL	-	7002-2975, 31L5501	EA	1
A202	1/30	115	1	1.8	SP	3400	CCW	BALL	3.3	7021-10602, 45037-001	EA	1
A213	1/25	115	2	2.1	SP	3200	CCW	BALL	3.3	7021-10376, 18L0401	EA	1
RHEEM-RUUD												
A066	1/30	120	1	1.27	SP	3000	CW	BALL	3.3	70-24157-03, 117847-00	EA	1

All rotation is determined by looking at shaft end.
 Note: 1. 3-1/2" motor body length

MOTOR BRACKETS

DiversiTech® Motors Bracket

These brackets help hold the motor securely.

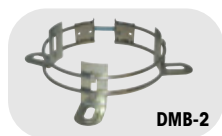

CATALOG NO.	DESCRIPTION	UOM	ORDER MULTIPLE
DMB-1	Fixed Lug Assembly for 5-1/2" diameter motors	EA	1
DMB-2	Adjustable Lug Assembly for 5-1/2" diameter motors	EA	1

Motor Mount – Flex Bracket

Torsion Flex Bracket holds motor securely. Fits 5-1/2" motors. Typically used for Goodman equipment.



CATALOG NO.	DESCRIPTION	UOM	ORDER MULTIPLE
DMB-3	5-1/2" Motor Mount Torsion Flex Bracket	EA	1

WHIPS

DiversiWhips

Liquid tight flexible conduit system. A labor saving convenience kit for A/C unit hookup. Also use for heat pumps, refrigeration, hot tubs, swimming pools and outdoor lighting. Three distinct wire colors for ease of hook up. 1 straight and 1 90 degree metallic or non metallic connector. 90 degree connector is removable for straight connections. (Second straight connector not included.) U.L. and C.U.L. Listed.



CATALOG NO.	DESCRIPTION	UOM	ORDER MULTIPLE
6-12-4	1/2" x 4' #10 THHN Wire – Metallic Connectors	EA	6
6-12-6	1/2" x 6' #10 THHN Wire – Metallic Connectors	EA	6
6-34-4	3/4" x 4' #8 THHN Wire – Metallic Connectors	EA	6
6-34-6	3/4" x 6' #8 THHN Wire – Metallic Connectors	EA	6
6-34-8	3/4" x 8' #8 THHN Wire – Metallic Connectors	EA	3
6-12-4NM	1/2" x 4' #10 THHN Wire – Non-Metallic Connectors	EA	6
6-12-6NM	1/2" x 6' #10 THHN Wire – Non-Metallic Connectors	EA	6
6-34-4NM	3/4" x 4' #8 THHN Wire – Non-Metallic Connectors	EA	6
6-34-6NM	3/4" x 6' #8 THHN Wire – Non-Metallic Connectors	EA	6
6-34-8NM	3/4" x 8' #8 THHN Wire – Non-Metallic Connectors	EA	3
6-12-6NMS	1/2" x 6' #10 THHN Wire – 2 Non-Metallic Straight Connectors	EA	6
6-34-6NMS	3/4" x 6' #8 THHN Wire – 2 Non-Metallic Straight Connectors	EA	6
6-12-6NM-2	1/2" x 6' #10 THHN Wire, 2-piece Non-Metallic Connectors	EA	6
6-34-6NM-2	3/4" x 6' #8 THHN Wire, 2-piece Non-Metallic Connectors	EA	6

*For DiversiWhips produced with 2 straight connectors, add S to part number (ex: 6-12-4S).

DiversiWhips Pallet Packs

DiversiWhips are now available in a convenient, bulk packaged pallet pack at a discounted price. Pallet pack makes an attractive floor standing display. 1 straight and 1 90 degrees metallic or non metallic connector.



CATALOG NO.	DESCRIPTION	UOM	ORDER MULTIPLE
B6-12-4	1/2 x 4' #10 THHN Wire – Metallic Connectors	EA	90
B6-12-6	1/2 x 6' #10 THHN Wire – Metallic Connectors	EA	60
B6-34-6	3/4 x 6' #8 THHN Wire – Metallic Connectors	EA	45
B6-12-4NM	1/2 x 4' #10 THHN Wire – Non-Metallic Connectors	EA	90
B6-12-6NM	1/2 x 6' #10 THHN Wire – Non-Metallic Connectors	EA	60
B6-34-4NM	3/4 x 4' #8 THHN Wire – Non-Metallic Connectors	EA	60
B6-34-6NM	3/4 x 6' #8 THHN Wire – Non-Metallic Connectors	EA	45

DiversiWhips with Extended Length Wires

DiversiWhips are available with extra long lead wires for those difficult to wire applications. These whips offer 10in. of lead wire on the straight side and 18in. of lead wire on the 90 degree side.



CATALOG NO.	DESCRIPTION	UOM	ORDER MULTIPLE
6-12-6NMR	1/2 x 6' #10 THHN Wire – Non-Metallic Connectors	EA	6
6-34-6NMR	3/4 x 6' #8 THHN Wire – Non-Metallic Connectors	EA	6

WHIPS cont'd

DiversiWhip - Up to 30 Amp

An economical whip for applications up to 30 Amp. A labor saving convenience kits for A/C hookup, heat pumps, refrigeration, hot tubs, swimming pools and outdoor lighting. One straight and one 90 degree non-metallic connector included.



6-12-6NMP

CATALOG NO.	DESCRIPTION	UOM	ORDER MULTIPLE
6-12-6NMP	1/2" x 6' #12 THHN Wire – Non-Metallic Connectors, Up to 30 Amp	EA	6

DiversiWhips for the Swimming Pool Industry

A labor saving kit for hookup of swimming pool motors, pumps, filters, and timers. Three distinct wire colors for ease of hookup. 1 straight and 1 90 degree non-metallic connector included.



6-12-4NMSWP

CATALOG NO.	DESCRIPTION	UOM	ORDER MULTIPLE
6-12-4NMSWP	1/2" x 4' #10 THHN Wire – In Box	EA	6
6-12-6NMSWP	1/2" x 6' #10 THHN Wire – In Box	EA	6
6-34-4NMSWP	3/4" x 4' #8 THHN Wire – In Box	EA	6
6-34-6NMSWP	3/4" x 6' #8 THHN Wire – In Box	EA	6

Solid Wire Whips

CATALOG NO.	DESCRIPTION	UOM	ORDER MULTIPLE
6-12-4NMSWP	1/2" x 4' #12 Solid 3 Wire – Non-Metallic Conn.	EA	6
6-12-6NMSWP	1/2" x 6' #12 Solid 3 Wire – Non-Metallic Conn.	EA	6
6-12-8NMSWP	1/2" x 8' #12 Solid 3 Wire – Non-Metallic Conn.	EA	3

DIVERSITECH ELECTRICAL DISCONNECTS

Disconnects—Metal Case

Fused model designed with fuses in pull out handle for easy replacement. The line, load, and ground terminals are aligned for ease of wiring. This product has a reversible door which opens to either the left or right. The side open door opens more than 180 degrees for maximum access and has a full dead front. The fused models have indicator lights for blown fuses. This is rain tight and sleet resistant. The UL Listed number is IRF9, NEMA Type 3R and the US Patent is 6,630,637.



DDS-60

CATALOG NO.	DESCRIPTION	UOM	ORDER MULTIPLE
DDS-30	30A Fusible Disconnect Switch	EA	10
DDS-60	60A Fusible Disconnect Switch	EA	10
DDS-60U	60A Non-Fusible Disconnect Switch	EA	10

Low Profile Disconnects—Metal Case

This low profile disconnect switch is a slightly smaller design than that of the standard DiversiTech disconnects. This has a side opening door with a full dead front. This is rain tight and sleet resistant. The UL Listed number is IRF9, NEMA Type 3R.



EDS-60U

EDS-12-6NM

CATALOG NO.	DESCRIPTION	UOM	ORDER MULTIPLE
EDS-60U	60A Non-Fusible Disconnect Switch	EA	10
EDS-12-6NM	Disconnect and Whip Combo Kit	EA	3

Disconnects—Non-Metallic Case

This 60 amp non-fusible disconnect is housed in a lightweight, non-metallic case. It features a side opening door with more than 180° access, full dead front, and a locking tab.



750-P60NF

CATALOG NO.	DESCRIPTION	UOM	ORDER MULTIPLE
750-P60NF	60A Non Fusible Disconnect Switch, Non-Metallic Case, Plastic	EA	10

Molded Case Switch Disconnect

The DDS-60SW Molded Case Switch Disconnect is rugged and easy to use like an ordinary light switch. It eliminates the pullout handle used in traditional AC disconnects and is easy to install. It is UL listed and rated for indoor and outdoor applications with NEMA 3R rating.



DDS-60SW

CATALOG NO.	DESCRIPTION	UOM	ORDER MULTIPLE
DDS-60SW	Molded Case Switch Disconnect, 60A 240 VAC	EA	10

3 Pole Switch for Mini-Splits

Three-pole, 30 Amp, 600 Volt rated disconnect switch provides safe, reliable manual ON/OFF switching control for Mini-splits and HVAC systems. This switch meets the local code requirements of breaking both the power lines (L1 and L2) and the communication line of the mini-split's indoor unit for service.



755-303SW

CATALOG NO.	DESCRIPTION	UOM	ORDER MULTIPLE
755-303SW	3 Pole Switch for Mini-Splits	EA	1

EATON ELECTRICAL DISCONNECTS

Eaton Switch A/C Disconnect

This A/C Disconnect is 60 amps switch rated for 10 HP motors at 240VAC. The switch is an on off circuit breaker with no pull out head that could be lost or stolen. It has easy-to-remove front cover with no screws or fasteners to remove.



DPB222R



CATALOG NO.	DESCRIPTION	UOM	ORDER MULTIPLE
DPB222R	60A molded case switch	EA	1

Eaton Three Phase Disconnects

These disconnects are UL listed and meet UL 98 for enclosed switches and NEMA Std. KS-1. They are suitable as service entrance equipment when applied with neutral or ground lug kit. They come with rainproof NEMA 3R enclosure.



DG322NRB



CATALOG NO.	DESCRIPTION	UOM	ORDER MULTIPLE
DG321NRB	Fusible 30 Amp, 240VAC	EA	1
DG322NRB	Fusible 60 Amp, 240VAC	EA	1
DG322URB	Non-fusible 60 Amp, 240VAC	EA	1

CONDUIT, FITTINGS, CABLE

DiversiTech™ Flexible Conduit

For electrical applications: outside, inside and industrial uses including transformer connections, air conditioning and heating. Joins with metallic or non-metallic connectors, easy to cut. Impact resistant, chemical resistant, and will not kink. U.L. and C.U.L. Listed. For use as indicated in Article 351 of the 1987 NEC.



750-12100

CATALOG NO.	DESCRIPTION	UOM	ORDER MULTIPLE
750-38100	3/8" x 100' Liquid Tite Conduit – Non-Metallic, 100' per roll	EA	1
750-12100	1/2" x 100' Liquid Tite Conduit – Non-Metallic, 100' per roll	EA	1
750-500	1/2" x 100' Liquid Tite Conduit – Metallic, 100' per roll	EA	1
750-34100	3/4" x 100' Liquid Tite Conduit – Non-Metallic, 100' per roll	EA	1
750-600	3/4" x 100' Liquid Tite Conduit – Metallic, 100' per roll	EA	1
750-10100	1" x 100' Liquid Tite Conduit – Non-Metallic, 100' per roll	EA	1
750-125100	1-1/4" x 100' Liquid Tite Conduit – Non-Metallic, 100' per roll	EA	1
750-1550	1-1/2" x 50' Liquid Tite Conduit – Non-Metallic, 50' per roll	EA	1
750-2050	2" x 50' Liquid Tite Conduit – Non-Metallic, 50' per roll	EA	1
750-10500	1" x 500' Liquid Tite Conduit – Non-Metallic, 500' per roll	EA	1
750-121000	1/2" x 1000' Liquid Tite Conduit – Non-Metallic, 1000' per roll	EA	1
750-34800	3/4" x 800' Liquid Tite Conduit – Non-Metallic, 800' per roll	EA	1

Liquid Tite Connectors

For use with metallic and non metallic liquid tite conduit, Type B. Provides smooth connection, no sharp edges to strip wire. Wiring easily pulled through. U. L. Listed. C.U.L. Listed.



750-MLT50 750-NMLT50

750-NMLT9050

CATALOG NO.	DESCRIPTION	UOM	ORDER MULTIPLE
750-NMLT50	1/2" Non-Metallic Straight Connector	EA	25
750-NMLT4550	1/2" Non-Metallic 45 Degree Elbow Connector	EA	10
750-NMLT9050	1/2" Non-Metallic 90 Degree Elbow Connector	EA	10
750-NMLT75	3/4" Non-Metallic Straight Connector	EA	10
750-NMLT4575	3/4" Non-Metallic 45 Degree Elbow Connector	EA	10
750-NMLT9075	3/4" Non-Metallic 90 Degree Elbow Connector	EA	10
750-NMLT100	1" Non-Metallic Straight Connector	EA	5
750-NMLT90100	1" Non-Metallic 90 Degree Elbow Connector	EA	5
750-MLT50	1/2" Metallic Straight Connector	EA	25
750-MLT9050	1/2" Metallic 90 Degree Elbow Connector	EA	10
750-MLT75	3/4" Metallic Straight Connector	EA	10
750-MLT9075	3/4" Metallic 90 Degree Elbow Connector	EA	10
750-NMLT125	1-1/4" Non-Metallic Straight Connector	EA	1
750-NMLT150	1-1/2" Non-Metallic Straight Connector	EA	10
750-NMLT90125	1-1/4" Non-Metallic 90 Degree Elbow Connector	EA	1
750-NMLT5090-F	1/2" Non-Metallic Adjustable Connector	EA	10
750-NMLT7590-F	3/4" Non-Metallic Adjustable Connector	EA	10
750-TZNMLT200	2" NM Topaz	EA	2
750-TZNMLT150	1-1/2" NM Topaz	EA	5
750-TZNMLT90150	1-1/2" NM Topaz 90 Degree	EA	2
750-TZNMLT125	1-1/4" NM Topaz	EA	5
750-TZNMLT90125	1-1/4" NM Topaz 90 Degree	EA	2
750-TZNMLT100	1" NM Topaz	EA	5
750-TZNMLT90100	1" NM Topaz 90 Degree	EA	5
750-TZNMLT38	3/8" NM Topaz	EA	10
750-TZNMLT9038	3/8" NM Topaz 90 Degree	EA	25
750-TZNMLT9050	1/2" NM Topaz 90 Degree	EA	10
750-TZNMLT9075	3/4" NM Topaz 90 Degree	EA	10

Single Piece Liquid Tite Fittings

Conduit threads onto ferrule and up inside the outer body. An inside taper squeezes down on the outside of conduit for a superior liquid tight seal. The cut portion of the conduit does not show, giving a more finished appearance. Easy to use at a lower cost than regular liquid tite fittings.



750-SLTC9050

750-SLTC50

CATALOG NO.	DESCRIPTION	UOM	ORDER MULTIPLE
750-SLTC50	1/2" Straight Screw-On Fitting	EA	25
750-SLTC9050	1/2" 90° Screw-On Fitting	EA	25
750-SLTC75	3/4" Straight Screw-On Fitting	EA	25
750-SLTC9075	3/4" 90° Screw-On Fitting	EA	25

CONDUIT, FITTINGS, CABLE cont'd

Two-Piece Liquid Tite Fittings

These 2-piece Liquid Tite compression fittings are for use with non-metallic Type B Liquid Tite conduit to terminate and seal conduit to enclosures. Easy to use with no disassembly required, cULus listed.



CATALOG NO.	DESCRIPTION	UOM	ORDER MULTIPLE
750-2LTC50	1/2" Straight, 2-piece Compression, Non-Metallic, Liquid-Tite Fitting	EA	25
750-2LTC9050	1/2" 90°, 2-piece Compression, Non-Metallic, Liquid-Tite Fitting	EA	25
750-2LTC75	3/4" Straight, 2-piece Compression, Non-Metallic, Liquid-Tite Fitting	EA	25
750-2LTC9075	3/4" 90°, 2-piece Compression, Non-Metallic, Liquid-Tite Fitting	EA	25

Romex Connectors – Metallic

These Metallic Romex Connectors are made of zinc die cast are cable connectors for Romex wire. U.L. Listed C.S.A. Approved.



CATALOG NO.	DESCRIPTION	UOM	ORDER MULTIPLE
750-RC841	3/8" Romex Connector for 1/2" Knockouts	EA	100
750-RC842	3/4" Romex Connector for 3/4" Knockouts	EA	50

U.L. Listed and C.S.A. Approved.

BX Set Screw Connectors

These connectors are for BX cable range of .445 to .630 in diameter. This product is UL listed and CSA approved.



CATALOG NO.	DESCRIPTION	UOM	ORDER MULTIPLE
640-845	Trade Size – 3/8"	EA	100

Non-Metallic Sheathed Cable (Romex Wire)

600V building wire. Easy to pull and strip, flame and moisture resistant. Saves time, labor and money. Color coded conductors of copper, PVC insulation and outer jacket with ground. U.L. Listed 719 Federal Specifications J C94.



CATALOG NO.	DESCRIPTION	UOM	ORDER MULTIPLE
620-6-2	6 AWG, 2 Conductors with Ground – 125' per pack	EA	1
620-8-2	8 AWG, 2 Conductors with Ground – 125' per pack	EA	1
620-10-2	10 AWG, 2 Conductors with Ground – 250' per pack	EA	1
620-12-2	12 AWG, 2 Conductors with Ground – 250' per pack	EA	1
620-14-2	14 AWG, 2 Conductors with Ground – 250' per pack	EA	1

U.L. Listed 719 Federal Specifications J-C94.

Aluminum Armored MC Cable

90°, C Rated aluminum metal clad cable system. THHN solid copper with specially compounded heat-resistant U.L. Listed insulation and jacket. Flexible interlocked aluminum armor. Extremely durable – withstands severe handling. U.L. Listed #4. Conforms to NEC article 333.



CATALOG NO.	DESCRIPTION	UOM	ORDER MULTIPLE
640-122	12-2 Aluminum Armored MC Cable – 100' per roll	EA	1
640-142	14-2 Aluminum Armored MC Cable – 100' per roll	EA	1

EMT (Thinwall) Fittings

These are used to join EMT conduit to boxes on enclosures.



CATALOG NO.	DESCRIPTION	UOM	ORDER MULTIPLE
625-800	Set Screw Connector – 1/2"	EA	50
625-801	Set Screw Connector – 3/4"	EA	25
625-304	Strap – One Hole – 1/2"	EA	100
625-305	Strap – One Hole – 3/4"	EA	100
625-810	Set Screw Coupling – 1/2"	EA	50
625-811	Set Screw Coupling – 3/4"	EA	25

Cable Staples

Cable Staples for NMB Cable (Romex) and Copper Insulated Staples for thermostat wire.



CATALOG NO.	DESCRIPTION	UOM	ORDER MULTIPLE
625-183	Romex Staples – 1/2", pack of 100	PK	1
625-IS5	Copper Insulated #5 Staples for T-Stat Wire	EA	100

CAPACITORS

Motor Run Capacitors—370VAC, Metal, Oval Can

These single capacitance oval, metal can capacitors are designed for continuous run.



CATALOG NO.	uf	UOM	ORDER MULTIPLE
37030H	3	EA	1
37040H	4	EA	1
37050H	5	EA	1
37050HB	5	EA	100*
37060H	6	EA	1
37075H	7.5	EA	1
37075HB	7.5	EA	100*
37100H	10	EA	1
37100HB	10	EA	100*
37125H	12.5	EA	1
37150H	15	EA	1
37175H	17.5	EA	1
37200H	20	EA	1
37250H	25	EA	1
37300H	30	EA	1
37350H	35	EA	1
37400H	40	EA	1
37450H	45	EA	1
37500H	50	EA	1
37600H	60	EA	1
37700H	70	EA	1
37800H	80	EA	1

*100 per pack

Motor Run Capacitors—370VAC

This single capacitance round, metal can capacitors are designed for continuous run.



CATALOG NO.	uf	UOM	ORDER MULTIPLE
37050R	5	EA	1
37075R	7.5	EA	1
37125R	12.5	EA	1
37150R	15	EA	1
37175R	17.5	EA	1
37200R	20	EA	1
37250R	25	EA	1
37300R	30	EA	1
37350R	35	EA	1
37400R	40	EA	1
37450R	45	EA	1
37500R	50	EA	1
37550R	55	EA	1
37600R	60	EA	1
37800R	80	EA	1
37300R-SWP*	30	EA	1
37350R-SWP*	35	EA	1

*Compact size, ideal for swimming pool motors.

Motor Run Capacitors—370VAC

Dual capacitance. Oval, metal can.



CATALOG NO.	uf	UOM	ORDER MULTIPLE
3GJ0515	15+5	EA	1
3GJ0520	20+5	EA	1
3GJ1520	20+15	EA	1
3GJ0525	25+5	EA	1
3GJ1025	25+10	EA	1
3GJ0330	30+3	EA	1
3GJ0530	30+5	EA	1
3GJ7530	30+7.5	EA	1
3GJ0535	35+5	EA	1
3GJ7535	35+7.5	EA	1
3GJ7545	45+7.5	EA	1
3GJ0540	40+5	EA	1
3GJ0545	45+5	EA	1
3GJ0555	55+5	EA	1
3GJ7555	55+7.5	EA	1
3GJ1060	60+10	EA	1

Motor Run Capacitors—370VAC

This dual capacitance round metal can capacitors are designed for continuous run.



CATALOG NO.	uf	UOM	ORDER MULTIPLE
3GR0515	15+5	EA	1
3GR0520	20+5	EA	1
3GR0325	25+3	EA	1
3GR0425	25+4	EA	1
3GR0525	25+5	EA	1
3GR0330	30+3	EA	1
3GR0530	30+5	EA	1
3GR7530	30+7.5	EA	1
3GR0335	35+3	EA	1
3GR0435	35+4	EA	1
3GR0535	35+5	EA	1
3GR1035	35+10	EA	1
3GR0340	40+3	EA	1
3GR0540	40+5	EA	1
3GR7540	40+7.5	EA	1
3GR0545	45+5	EA	1
3GR0550	50+5	EA	1
3GR0555	55+5	EA	1
3GR7555	55+7.5	EA	1
3GR0560	60+5	EA	1
3GR7560	60+7.5	EA	1
3GR0570	70+5	EA	1
3GR0580	80+5	EA	1
3GR7580	80+7.5	EA	1
3GR1080	80+10	EA	1

CAPACITORS cont'd

Motor Run Capacitors—440VAC

These single capacitance oval, metal can capacitors are designed for continuous run.



CATALOG NO.	uf	UOM	ORDER MULTIPLE
45020H	2	EA	1
45030H	3	EA	1
45040H	4	EA	1
45050H	5	EA	1
45060H	6	EA	1
45075H	7.5	EA	1
45100H	10	EA	1
45125H	12.5	EA	1
45150H	15	EA	1
45175H	17.5	EA	1
45200H	20	EA	1
45250H	25	EA	1
45300H	30	EA	1
45350H	35	EA	1
45400H	40	EA	1
45450H	45	EA	1
45500H	50	EA	1
45550H	55	EA	1
45600H	60	EA	1
45700H	70	EA	1
45800H	80	EA	1

Motor Run Capacitor—440VAC

Single capacitance. Round, metal can.



CATALOG NO.	uf	UOM	ORDER MULTIPLE
45050R	5	EA	1
45075R	7.5	EA	1
45100R	10	EA	1
45125R	12.5	EA	1
45150R	15	EA	1
45200R	20	EA	1
45250R	25	EA	1
45300R	30	EA	1
45350R	35	EA	1
45400R	40	EA	1
45450R	45	EA	1
45500R	50	EA	1
45550R	55	EA	1
45600R	60	EA	1
45700R	70	EA	1
45800R	80	EA	1

Motor Run Capacitor—440VAC

Dual capacitance. Oval, metal can.



CATALOG NO.	uf	UOM	ORDER MULTIPLE
4JJ0525	25+5	EA	1
4JJ0530	30+5	EA	1
4JJ0535	35+5	EA	1
4JJ0540	40+5	EA	1
4JJ0545	45+5	EA	1
4JJ0555	55+5	EA	1
4JJ7535	35+7.5	EA	1
4JJ7540	40+7.5	EA	1
4JJ7545	45+7.5	EA	1
4JJ1055	55+10	EA	1
4JJ0560	60+5	EA	1

Motor Run Capacitor—440VAC

Dual capacitance. Round, metal can.



CATALOG NO.	uf	UOM	ORDER MULTIPLE
4JR0520	20+5	EA	1
4JR0525	25+5	EA	1
4JR7525	25+7.5	EA	1
4JR0530	30+5	EA	1
4JR7530	30+7.5	EA	1
4JR0535	35+5	EA	1
4JR7535	35+7.5	EA	1
4JR0440	40+4	EA	1
4JR0540	40+5	EA	1
4JR7540	40+7.5	EA	1
4JR0545	45+5	EA	1
4JR7545	45+7.5	EA	1
4JR0550	50+5	EA	1
4JR7550	50+7.5	EA	1
4JR0555	55+5	EA	1
4JR1055	55+10	EA	1
4JR7555	55+7.5	EA	1
4JR0560	60+5	EA	1
4JR7560	60+7.5	EA	1
4JR1060	60+10	EA	1
4JR0570	70+5	EA	1
4JR7570	70+7.5	EA	1
4JR0580	80+5	EA	1
4JR7580	80+7.5	EA	1
4JR1080	80+10	EA	1

MOTOR RUN CAPACITORS (USA MADE)

Made in the U.S.A. Capacitors Round Metal Can

Line of made in the USA capacitors featuring dual voltage for both 370V and 440V applications. Designed specifically for the demands of aftermarket service parts.



CATALOG NO.	VOLTAGE	uf	UOM	ORDER MULTIPLE
4JR0525U	370V/440V	25+5	EA	1
4JR0530U	370V/440V	30+5	EA	1
4JR7530U	370V/440V	30+7.5	EA	1
4JR0535U	370V/440V	35+5	EA	1
4JR7535U	370V/440V	35+7.5	EA	1
4JR0540U	370V/440V	40+5	EA	1
4JR7540U	370V/440V	40+7.5	EA	1
4JR0545U	370V/440V	45+5	EA	1
4JR7545U	370V/440V	45+7.5	EA	1
4JR0550U	370V/440V	50+5	EA	1
4JR7550U	370V/440V	50+7.5	EA	1
4JR0555U	370V/440V	55+5	EA	1
4JR7555U	370V/440V	55+7.5	EA	1
4JR0560U	370V/440V	60+5	EA	1
4JR7560U	370V/440V	60+7.5	EA	1
4JR0580U	370V/440V	80+5	EA	1

Motor Start Capacitors – 110/125 VAC

Variable capacitance. Round, plastic can.



CATALOG NO.	uf	UOM	ORDER MULTIPLE
56-72	56-72	EA	1
88-108	88-108	EA	1
108-130	108-130	EA	1
124-156	124-156	EA	1
145-175	145-175	EA	1
161-193	161-193	EA	1
189-227	189-227	EA	1
200-240	200-240	EA	1
216-259	216-259	EA	1
233-292	233-292	EA	1
270-324	270-324	EA	1
324-388	324-388	EA	1
340-408	340-408	EA	1
378-440	378-440	EA	1
400-480	400-480	EA	1
460-552	460-552	EA	1
540-648	540-648	EA	1
590-708	590-708	EA	1
708-850	708-850	EA	1
829-995	829-995	EA	1
1000-1200	1000-1200	EA	1

Made in the U.S.A. Capacitors Oval Metal Can

Line of made in the USA capacitors featuring dual voltage for both 370V and 440V applications. Designed specifically for the demands of aftermarket service parts.



CATALOG NO.	VOLTAGE	uf	UOM	ORDER MULTIPLE
45050HU	370V/440V	5	EA	1
45075HU	370V/440V	7.5	EA	1
45100HU	370V/440V	10	EA	1
45150HU	370V/440V	15	EA	1
45200HU	370V/440V	20	EA	1
45250HU	370V/440V	25	EA	1
45300HU	370V/440V	30	EA	1
45350HU	370V/440V	35	EA	1
45400HU	370V/440V	40	EA	1
45450HU	370V/440V	45	EA	1
45125HU	370V/440V	12.5	EA	1
45500HU	370V/440V	50	EA	1
45600HU	370V/440V	60	EA	1
45700HU	370V/440V	70	EA	1
45800HU	370V/440V	80	EA	1

Motor Start Capacitors – 220/250 VAC

Variable capacitance. Round, plastic can.



CATALOG NO.	uf	UOM	ORDER MULTIPLE
43-53220	43-53	EA	1
56-72220	56-72	EA	1
72-88220	72-88	EA	1
88-108220	88-108	EA	1
108-130220	108-130	EA	1
124-156220	124-156	EA	1
145-175220	145-175	EA	1
161-193220	161-193	EA	1
189-227220	189-227	EA	1
216-259220	216-259	EA	1
233-292220	233-292	EA	1
270-324220	270-324	EA	1

Motor Start Capacitors – 330 VAC

Variable capacitance. Round, plastic can.



CATALOG NO.	uf	UOM	ORDER MULTIPLE
72-88330	72-88	EA	1
88-108330	88-108	EA	1
108-130330	108-130	EA	1
124-156330	124-156	EA	1
145-175330	145-175	EA	1
161-193330	161-193	EA	1
189-227330	189-227	EA	1
216-259330	216-259	EA	1
270-324330	270-324	EA	1

HARD START KITS

Torque Plus—Hard Start Kits

Totally solid state, our DST 5 is just right for all permanent split capacitor (PSC) compressors from 1/2 to 10 H.P. It can be used on units that operate on 120 through 288 Volts. The DST 6 offers a larger capacitor for severely hard to start compressors. The DST 6 can be used on all PSC single phase compressors from 1 1/2 to 10 H.P. A unique combination of relay and safety timer. The capacitor is automatically disconnected in 0.5 seconds if the compressor fails to start.



CATALOG NO.	DESCRIPTION	UOM	ORDER MULTIPLE
DST-5	Torque Plus – 300% Torque Multiplier	EA	1
DST-6	Torque Plus – 500% Torque Multiplier	EA	1

DiversiTech Hard Start Kits

DiversiTech hard start kits reduce contractor call backs by boosting the starting capacitor for a compressor. This prevents home brownouts and improves homeowner satisfaction with your service. DiversiTech's hard start kits feature a potential relay that disconnects the start capacitor from the circuit at exactly the moment it is no longer needed to boost the compressor. This results in a precision compressor start even under hard starting conditions. Replaces the Kickstart KS-1 and the 5-n-1 kit.



CATALOG NO.	DESCRIPTION	UOM	ORDER MULTIPLE
HSK1	Hard Start Kit for 3.5 to 5HP Compressor	EA	1
HSK5	Hard Start Kit for 1 to 3HP Compressor	EA	1

CONTACTORS

DiversiTech® Two Pole Definite Purpose Contactors

Definite purpose contactors can be used for heating, air conditioning, refrigeration, data processing, and food service equipment. Quick connect terminals provide for easy wiring. This contactor comes as a two pole on a small frame.



CATALOG NO.	FL AMPS	COIL VAC	UOM	ORDER MULTIPLE
EC25224	25	24	EA	1
EC252120	25	120	EA	1
EC252240	25	240	EA	1
EC252277	25	277	EA	1
EC30224	30	24	EA	1
EC302120	30	120	EA	1
EC302240	30	240	EA	1
EC40224	40	24	EA	1
EC402120	40	120	EA	1
EC402240	40	240	EA	1

DiversiTech® Three Pole Definite Purpose Contactors

Definite purpose contactors can be used for heating, air conditioning, refrigeration, data processing, and food service equipment. Quick connect terminals provide for easy wiring. This contactor comes as a three pole on a large frame.



CATALOG NO.	FL AMPS	COIL VAC	UOM	ORDER MULTIPLE
EC30324	30	24	EA	1
EC303120	30	120	EA	1
EC303240	30	240	EA	1
EC303277	30	277	EA	1
EC40324	40	24	EA	1
EC403120	40	120	EA	1
EC403240	40	240	EA	1
EC403277	40	277	EA	1
EC50324	50	24	EA	1
EC503120	50	120	EA	1
EC503240	50	240	EA	1
EC503277	50	277	EA	1
EC60324	60	24	EA	1
EC603120	60	120	EA	1
EC603240	60	240	EA	1
EC603277	60	277	EA	1
EC75324	75	24	EA	1
EC753120	75	120	EA	1
EC753240	75	240	EA	1
EC753277	75	277	EA	1
EC90324	90	24	EA	1
EC903120	90	120	EA	1
EC903240	90	240	EA	1
EC903277	90	277	EA	1

Eaton Definite Purpose Contactors - Three and Four Pole

These are Eaton's standard line of C25 DP contactors. They feature pressure plates with quick connects for 25A and 30A contactors, and lugs and quick connects for 40A to 90A contactors. They are UL recognized and CSA certified components. These contactors are designed for the HVAC and refrigeration applications.



CATALOG NO.	POLES	FL AMPS	COIL VAC	UOM	ORDER MULTIPLE
DPE253120	3	25	120	EA	1
DPE25324	3	25	24	EA	1
DPE253240	3	25	240	EA	1
DPE303120	3	30	120	EA	1
DPE30324	3	30	24	EA	1
DPE303240	3	30	240	EA	1
DPE303277	3	30	277	EA	1
DPE303480	3	30	480	EA	1
DPE403120	3	40	120	EA	1
DPE40324	3	40	24	EA	1
DPE403240	3	40	240	EA	1
DPE403480	3	40	480	EA	1
DPE503120	3	50	120	EA	1
DPE50324	3	50	24	EA	1
DPE503240	3	50	240	EA	1
DPE603120	3	60	120	EA	1
DPE60324	3	60	24	EA	1
DPE603240	3	60	240	EA	1
DPE753120	3	75	120	EA	1
DPE75324	3	75	24	EA	1
DPE753240	3	75	240	EA	1
DPE903120	3	90	120	EA	1
DPE90324	3	90	24	EA	1
DPE903240	3	90	240	EA	1
DPE304120	4	30	120	EA	1
DPE30424	4	30	24	EA	1
DPE304240	4	30	240	EA	1
DPE304277	4	30	277	EA	1
DPE404120	4	40	120	EA	1
DPE404240	4	40	240	EA	1
DPE404277	4	40	277	EA	1

Eaton Definite Purpose Contactors - One and Two Pole

These are single- and two-pole, Type C25 contactors feature a compact, efficient design with a low VA coil and straight-through wiring. Its housing design effectively limits dust and other contaminants from magnet structure—reduces or eliminates noise. They are UL recognized/CSA certified, ampere rated devices are well suited for use in heating/air conditioning, refrigeration, data processing and food service applications.



CATALOG NO.	POLES	FL AMPS	COIL VAC	UOM	ORDER MULTIPLE
DPE301120	1	30	120	EA	1
DPE30124	1	30	24	EA	1
DPE301240	1	30	240	EA	1
DPE401120	1	40	120	EA	1
DPE40124	1	40	24	EA	1
DPE252120	2	25	120	EA	1
DPE25224	2	25	24	EA	1
DPE252240	2	25	240	EA	1
DPE302120	2	30	120	EA	1
DPE30224	2	30	24	EA	1
DPE302240	2	30	240	EA	1
DPE302277	2	30	277	EA	1
DPE402120	2	40	120	EA	1
DPE40224	2	40	24	EA	1
DPE402240	2	40	240	EA	1
DPE402480	2	40	480	EA	1
DPE602120	2	60	120	EA	1

Eaton Contactor Accessories

These auxiliary contacts are side mounted contact kits for Eaton's definite purpose contactors with contact rating of 15A to 75A.



CATALOG NO.	DESCRIPTION	UOM	ORDER MULTIPLE
DPEAUX10	15-75A, 1NO	EA	1
DPEAUX11	15-75A, 1NO-1NC	EA	1
DPEAUX11QC	15-75A, 1NO-1NC with Quick Connect	EA	1
DPEAUX22	25-75A, 2NO-2NC	EA	1

TRANSFORMERS

**Transformers – Class 2 1585
UL Recognized**

The transformers provide the power source for heating, air conditioning, or refrigeration systems.



CATALOG NO.	VA	PRI	SEC	UOM	ORDER MULTIPLE
T1401	40	120	24	EA	1
T1404	40	120/208/240	24	EA	1

**Transformers – Class 2 1585
UL Recognized**

The transformers provide the power source for heating, air conditioning, or refrigeration systems. These are multi mounted with wire connection secondary.



CATALOG NO.	VA	PRI	SEC	UOM	ORDER MULTIPLE
T3401	40	120	24	EA	1
T3403	40	120/208/240	24	EA	1
T3501	50	120/208/240	24	EA	1
T5401	40	120	24	EA	1

**Transformers – Class 2 1585
UL Recognized**

The transformers provide the power source for heating, air conditioning, or refrigeration systems.

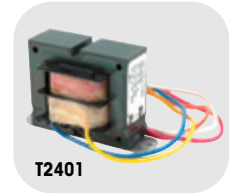

CATALOG NO.	VA	PRI	SEC	UOM	ORDER MULTIPLE
T2401	40	120	24	EA	1
T2403	40	208/240	24	EA	1
T2404	40	120/208/240	24	EA	1

**Transformers – Class 2 1585
UL Recognized**

Heavy duty with external fuse (T67XX) or circuit breaker (T77XX).



CATALOG NO.	VA	PRI	SEC	UOM	ORDER MULTIPLE
T6752	75	120/208/240	24	EA	1
T6753	75	120/208/240/480	24	EA	1
T7752	75	120/208/240/480	24	EA	1

RELAYS

General Purpose Relays – 9400 Series

This product features quick connect terminals with universal mounting with break away tabs.

CATALOG NO.	DESCRIPTION	AMPS RES	FLA/LRA@125V	FLA/LRA@250V	COIL VOLTAGE	UOM	ORDER MULTIPLE
D90-360	SPST-NO	18	12/60	8/48	24 VAC	EA	1
D90-370	SPDT	18	14/84	8/48	24 VAC	EA	1
D90-372	SPDT	18	14/84	8/48	120 VAC	EA	1
D90-380	SPST NO+NC	18	12/60	8/48	24 VAC	EA	1
D90-382	SPST NO+NC	18	12/60	8/48	120 VAC	EA	1
D90-384	SPST NO+NC	18	12/60	8/48	240 VAC	EA	1



**General Purpose Relays –
8400 Series**

This product features quick connect terminals with universal mounting with break away tabs.



CATALOG NO.	DESCRIPTION	AMPS RES/IND	COIL VOLTAGE	UOM	ORDER MULTIPLE
D90-290Q	SPST-NO	16/8	24 VAC	EA	1
D90-291Q	SPST-NO	16/8	120 VAC	EA	1
D90-292Q	SPST-NO	16/8	240 VAC	EA	1
D90-293Q	SPDT	8/8	24 VAC	EA	1
D90-294Q	SPDT	8/8	120 VAC	EA	1
D90-295Q	SPDT	8/8	240 VAC	EA	1

Potential Relays

The Potential Relay has SPST NC configurations and offers a variety of mounting positions.



CATALOG NO.	COIL VOLTAGE	PICK-UP MIN	PICK-UP MAX	DROP-OUT MAX	UOM	ORDER MULTIPLE
DPR064	395	242	272	140	EA	1
DPR066	395	223	252	130	EA	1

**General Purpose
Switching Relays**

The Switching Relay has quick connect terminals for termination. The base is designed for easy replacement of competitive relays.



CATALOG NO.	COIL VOLTAGE	TERMINALS 1-2-3	TERMINALS 4-5-6	UOM	ORDER MULTIPLE
D-90340	24	POWER	POWER	EA	1
D-90341	110/120	POWER	POWER	EA	1
D-90342	208/240	POWER	POWER	EA	1

FAN CENTERS

Fan Centers

The fan centers offer low voltage for one and two speed fan motors; auxiliary circuits in heating cooling, or heating/ cooling applications. This has a DPDT Relay and is UL rated. There are color coded pre stripped leads on this center. This product has a 24V coil voltage, power, and duty rated contacts. It mounts directly to a 4in. electrical box.



CATALOG NO.	VOLTAGE	UOM	ORDER MULTIPLE
D-90113	120	EA	1
D-90118	208/240	EA	1

FUSES

Dual Element Fuses – 250V

Provides time delay for temporary over current conditions and motor running protection for heating and air conditioning equipment. Eliminates unnecessary maintenance from harmless overloads. U.L. Class RK 5, Standard for Safety 198E, Current Limiting Fuses, Interrupting Rating 200,000 Amps. rms. A.C.



CATALOG NO.	DESCRIPTION	UOM	ORDER MULTIPLE
7-CRNR15	15 Amps	EA	10
7-CRNR20	20 Amps	EA	10
7-CRNR25	25 Amps	EA	10
7-CRNR30	30 Amps	EA	10
7-CRNR35	35 Amps	EA	10
7-CRNR40	40 Amps	EA	10
7-CRNR45	45 Amps	EA	10
7-CRNR50	50 Amps	EA	10
7-CRNR60	60 Amps	EA	10
7-CRNR70	70 Amps	EA	5
7-CRNR80	80 Amps	EA	5
7-CRNR90	90 Amps	EA	5
7-CRNR100	100 Amps	EA	5

U.L. Class RK-5, Standard for Safety 198E, Current Limiting Fuses, Interrupting Rating 200,000 Amps. rms. A.C.

Time Delay Fuses – 600V

These plugs offer safe protection during momentary overload. No adapter necessary. U.L. Listed., Class RK5



CATALOG NO.	DESCRIPTION	UOM	ORDER MULTIPLE
626-HASR10	10 Amp	EA	10
626-HASR15	15 Amp	EA	10
626-HASR20	20 Amp	EA	10
626-HASR25	25 Amp	EA	10
626-HASR30	30 Amp	EA	10
626-HASR40	40 Amp	EA	10
626-HASR60	60 Amp	EA	10

U.L. Listed.

One Time Fuses

Protection to lighting, heating, and other non transient circuits. U.L. Class K5, Standard for Safety 1988, One Time Fuse Interrupting Rating 10,000 Amps. rms. A.C., 250 VAC/VDC



CATALOG NO.	DESCRIPTION	UOM	ORDER MULTIPLE
7-10KOTN30	30 Amps	EA	10
7-10KOTN35	35 Amps	EA	10
7-10KOTN40	40 Amps	EA	10
7-10KOTN45	45 Amps	EA	10
7-10KOTN50	50 Amps	EA	10
7-10KOTN60	60 Amps	EA	10
7-10KOTN70	70 Amps	EA	5
7-10KOTN80	80 Amps	EA	5
7-10KOTN90	90 Amps	EA	5
7-10KOTN100	100 Amps	EA	5

U.L. Class K5, Standard for Safety 1988, One Time Fuse Interrupting Rating 10,000 Amps. rms. A.C.

Time Delay Plug Fuses

These plugs offer safe protection during momentary overload. No adapter necessary. U.L. Listed.



CATALOG NO.	DESCRIPTION	UOM	ORDER MULTIPLE
626-10T	Type "T" Plug Fuse – 10 Amp	EA	4
626-15T	Type "T" Plug Fuse – 15 Amp	EA	4
626-20T	Type "T" Plug Fuse – 20 Amp	EA	4
626-25T	Type "T" Plug Fuse – 25 Amp	EA	4
626-30T	Type "T" Plug Fuse – 30 Amp	EA	4

U.L. Listed.

FUSES cont'd

Plug Fuses

Expels gases caused by the blowing fuse, but doesn't allow flame to escape. Glass top for safety against shock. Positive visual indication of OK condition or blown condition. Distinguishes between overload and dead short conditions. Magnifying center of face. Shapes of face openings identify ratings. Meets Federal Specification WF 791E/Gen. Type 791/1. Base "W" fuses. U.L. Listed.



CATALOG NO.	DESCRIPTION	UOM	ORDER MULTIPLE
626-15	Plug Fuse Type TL – 15 Amp	EA	4
626-20	Plug Fuse Type TL – 20 Amp	EA	4
626-25	Plug Fuse Type TL – 25 Amp	EA	4
626-30	Plug Fuse Type TL – 30 Amp	EA	4

U.L. Listed.

In-Line Fuse Holder

For fusing all control circuits up to 30 amp. Features rigid plastic protective covering for each fuse. Used on AC and DC circuits. U.L. Listed.

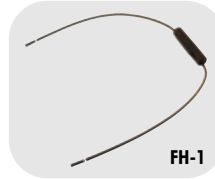

CATALOG NO.	DESCRIPTION	UOM	ORDER MULTIPLE
FH-1	In-Line Fuse Holder, Pack of 10	EA	1

U.L. Listed.

EasyID® Blade Fuses

The EasyID® series of illuminating blade fuses use Light Emitting Diode (LED) technology to indicate that a fuse has opened, making it easy to spot the opened fuse in a dark control panel. It makes it easy for a contractor to troubleshoot a problem and save time.



CATALOG NO.	DESCRIPTION	UOM	ORDER MULTIPLE
626-AT03LED	EasyID® Blade Fuse – 3 Amp – Violet, pack of 5	EA	100
626-AT05LED	EasyID® Blade Fuse – 5 Amp – Tan, pack of 5	EA	100

Fuse Pullers

Our fuse pullers are used to safely pull fuses.



CATALOG NO.	DESCRIPTION	UOM	ORDER MULTIPLE
626-38071	Fuse Puller – For Fuse Sizes 1/4" to 1/2"	EA	1
626-38073	Fuse Puller – For Fuse Sizes 1" to 1-3/4"	EA	1

Fuseblocks

The fuse blocks are designed to allow the fuse to blow or burn out before the component can be damaged.



CATALOG NO.	DESCRIPTION	UOM	ORDER MULTIPLE
626-23133	Fuseblock – 1 Pole Screw Class H, 250V	EA	1
626-26311	Fuseblock – 3 Pole Box Lug Class H, 250V	EA	1

Type "S" Non-Tamper Fuses

Provides specific overcurrent protection. Time delay element protects against premature blowing from motors in air conditioners or compressors. Visual indication of good or blown condition. U.L. Listed. C.S.A. Approved.



CATALOG NO.	DESCRIPTION	UOM	ORDER MULTIPLE
626-6S	Type "S" Fuse – 6.25 Amp	EA	4
626-10S	Type "S" Fuse – 10 Amp	EA	4
626-15S	Type "S" Fuse – 15 Amp	EA	4
626-20S	Type "S" Fuse – 20 Amp	EA	4
626-30S	Type "S" Fuse – 30 Amp	EA	4

U.L. Listed. C.S.A. Approved.

Blade (Auto) Fuses

These fuses are fast acting low voltage supplementary fuses, automotive blade style fuse.



CATALOG NO.	DESCRIPTION	UOM	ORDER MULTIPLE
626-AT0003	Blade Fuse – 3 Amp – Purple, pack of 5	EA	100
626-AT0005	Blade Fuse – 5 Amp – Tan, pack of 5	EA	100

Fuse Adapters

Fuse adapters are used to retrofit fuses into existing installations.



CATALOG NO.	DESCRIPTION	UOM	ORDER MULTIPLE
626-38632	Fuse Adapter – 60 to 30 Reducer for Class H, 250V	EA	1
626-38636	Fuse Adapter – 60 to 30 Reducer for Class H, 600V	EA	1

Box Cover Units

The maximum amps on this box cover unit are 15 and the maximum AC voltage of 125. These units are designed for use with the Type T plug fuses. U.L. Listed and C.S.A. Certified.



CATALOG NO.	DESCRIPTION	UOM	ORDER MULTIPLE
620-608	Switch/Fuse Combo (ESSU)	EA	1
620-6081	Plug Fuse Base Only (ESOU)	EA	1
620-6082	Receptacle/Fuse Combo (ESRU)	EA	1
620-6083	Switch/Fuse Combo Square (ESSY)	EA	1

U.L. Listed and C.S.A. Certified.

TIME DELAYS

Adjustable Delay on Break Timer

Adjusts from 6 seconds to 8 minutes. Spin-proof knob. Works with 24, 120 or 240 VAC control circuits. Supports up to 1.0 Amps. Two wire hookup for easy installation. Solid state with quick disconnect terminals. Mounts with one self-tapping screw. Conformal coated circuitry protects against moisture and shock. UR recognized for USA and Canada. Works with anticipator type thermostats.

HOW IT WORKS: Immediately upon application of power, the Delay on Break timer enables circuit operation. Once power is interrupted, the circuit opens for the time set on the dial. After the time period elapses, the circuit closes, allowing the protected motor or compressor to start. For typical HVAC applications, the operation of the timer is transparent and will go unnoticed.



Adjustable Delay on Make Timer

Ideal for random starting of multiple units. Adjusts from 6 seconds to 8 minutes. Spin proof knob. Works with 24, 120 or 240 VAC control circuits. Supports up to 1.0 Amps. Two wire hookup for easy installation. Solid state with quick-disconnect terminals. Mounts with one self-tapping screw. Conformal coated circuitry protects against moisture and shock. UR recognized for US and Canada. Works with anticipator type thermostats.

HOW IT WORKS: These timers delay circuit closure upon application of power. Only after the set time period elapses and power remains ON will the circuit close, allowing the protected motor or compressor to start. For typical HVAC installations, timers are adjusted to random times to prevent power circuit overloads, thus are often called random start timers.



CATALOG NO.	DESCRIPTION	UOM	ORDER MULTIPLE
ADB-1	Adjustable Delay on Break	EA	1
ADB-2	Adjustable Delay on Break w/Wire Leads	EA	1

CATALOG NO.	DESCRIPTION	UOM	ORDER MULTIPLE
ADM-1	Adjustable Delay on Make	EA	1
ADM-2	Adjustable Delay on Make w/Wire Leads	EA	1

MONITORS

Digital Three Phase Line Voltage Monitor

Offers continuous protection against voltage anomalies which can damage compressors, motors and other sensitive electrically operated devices.

PROTECTION: Loss of Phase, Phase Reversal, Voltage Imbalance, Low Voltage, High Voltage

DISPLAY: Large custom LCD display indicates all operating conditions at a glance. Three large sets of digits provide easy system troubleshooting.

VOLTMETER: Three independent voltmeters read both line and contactor load (backside) voltages.

MONITORED VOLTAGE: 160 to 600 Volts 50-60 Hz.

POWER SUPPLY: Power for the WPC-500 is automatically derived from any active phase. System operation is not dependent on the control voltage or a specific phase for power.

CONTROL VOLTAGE: 19-277 VAC. Anticipator load is provided for operation with 24 volt electronic and mechanical thermostats.

OPERATING VOLTAGE SET POINT: 175 to 650 VAC. Digitally adjustable in one volt increments.

VOLTAGE TRIP POINT: Adjustable in 1% increments between 6% and 18% of selected operating voltage. Restart voltage set point (hysteresis) fixed at cutout voltage + 3%.

VOLTAGE SYMMETRY: Adjustable imbalance trip point from 2% to 25% of selected operating voltage.

RESPONSE TIMES:

Phase Loss/Reversal: 100 mS max.

Imbalance: Adjustable Response Timer

Over or Under Voltage: Adjustable Response Timer
LOCKOUT DELAY TIMER: Fully adjustable 0 to 720 Seconds (0 to 12 minutes). Digital display shows re-remaining time and user set points.

SEQUENTIAL START TIMER: 0 to 30 seconds in one second increments.

RESPONSE TIMER: 0.1 to 20 Seconds. Digital display shows remaining time and user set points.

MEMORY: Up to 25 past fault conditions are stored for later retrieval and analysis. The faults may be displayed or cleared by the front panel buttons.



Digital Single Phase Line Voltage Monitor

Automatic voltage monitor and control system. Continuously measures incoming line voltage, allowing detection of any voltage outside the tolerances that you set. If these limits are exceeded, the response timer begins counting. You may also set response time – a short time for a quick response or a long time to avoid nuisance tripping. If the voltage remains outside the tolerance after the time has elapsed, the DSP-1 will turn off its output relay and protect your device. While output is off, an additional delay timer activates to avoid rapid restarts.

FEATURES:

Digital voltmeter displays instantaneous line voltage;

Automatic voltage tester adjusts from 90 to 300 volts;

Adjustable response timer (0.1 to 10 sec.) prevents nuisance tripping;

Adjustable delay timer (1 to 720 sec.) prevents rapid restarts;

Digital display makes for easy viewing and operation

SPECIFICATIONS:

Voltmeter: 70 to 325 Volts

Voltage Set Point: 90 to 300 Volts

Tolerance Limits: 6 to 18%

Response Timer: 0.1 to 10 seconds

Delay Timer: 1 to 720 seconds

Output Relay: 10 Amps, 250 VAC resistive, single-pole/double-throw

Control Input: 18 to 250 VAC with anticipator load for 24 volt thermostats



CATALOG NO.	DESCRIPTION	UOM	ORDER MULTIPLE
DTP-3	Digital 3-Phase Motor Protector	EA	1

CATALOG NO.	DESCRIPTION	UOM	ORDER MULTIPLE
DSP-1	Digital Single Phase Motor Protector	EA	1

SURGE PROTECTORS

Surge-Trap Type 1 STXH

The most compact of the STX series offering, the Surge-Trap® Type 1 STXH meets requirements for UL1449 4th Edition and is suitable for any 120/240VAC split phase application. The STXH Series SPD features TPMOV® technology inside making it the safest product available in its category. Its compact size, performance and reliability are especially ideal for HVAC applications and direct mounting to air condition disconnect switches.



CATALOG NO.	DESCRIPTION	UPC	UOM	ORDER MULTIPLE
STXH120P05	STXH Type 1 50kA 120V Single Phase	0782001472511	EA	1
STXH240S05	STXH Type 1 50kA 240/120V Split Phase	0782001472504	EA	1

Surge-Trap Type 1 STXR

The most popular range in the STX series offering, the Surge-Trap® Type 1 STXR meets requirements for UL1449 4th Edition and is ideal for the replacement of obsolete surge arrestors. The STXR Series SPDs feature TPMOV® technology inside, making them the safest product available. With a small, compact design and line or load installation flexibility, the STXR series is the perfect fit for branch panel and/or individual equipment protection.



CATALOG NO.	DESCRIPTION	UPC	UOM	ORDER MULTIPLE
STXR208Y05N	STXR Type 1 50kA 208Y/120V N-G	0782001469962	EA	1
STXR480Y05N	STXR Type 1 50kA 480Y/277V N-G	0782001469986	EA	1
STXR240D05	STXR Type 1 50kA 240V 3-Phase DELTA	0782001469900	EA	1
STXR480D05	STXR Type 1 50kA 480V 3-Phase DELTA	0782001469917	EA	1
STXRMBK	STXR Surge Protector Mounting Bracket Kit	0782001470760	EA	1

ELECTRICAL SUPPLIES

Electrical Toggle Switches

Side wire design with automatic grounding and large binding head terminal screws for fast wiring. Lubricated cam provides smooth lever action. U.L. Listed. C.S.A. Certified. Verified to Federal Spec. WS896E



CATALOG NO.	DESCRIPTION	UOM	ORDER MULTIPLE
620-600	20A-1 HP 120V, Single Pole, Brown	EA	10
620-601	20A-1 HP 120V, Single Pole, Ivory	EA	10
625-CS120W	20A-1HP 120V Single Pole, White	EA	10
625-1301W	15A-1/2HP 120V Single Pole, White	EA	10
620-604	15A-1/2 HP 120V, Single Pole, Brown	EA	10
620-605	15A-1/2 HP 120V, Single Pole, Ivory	EA	10

U.L. Listed. C.S.A. Certified. Verified to Federal Spec. WS896E.

Electrical Duplex Receptacles

Automatic grounding for fast installation. Heavy duty mounting strap for additional assembly strength. Copper alloy power/ground contacts for optimum continuity. Side wire design with large binding head terminal screws for fast wiring. U.L. Listed. C.S.A. Certified (NEMA 5 15 Type).



CATALOG NO.	DESCRIPTION	UOM	ORDER MULTIPLE
620-700	15A, 125V, Brown	EA	10
620-701	15A, 125V, Ivory	EA	10
625-CR15W	15A 125V, White	EA	10
620-702	20A, 125V, Brown	EA	10
620-703	20A, 125V, Ivory	EA	10
625-CR20W	20A 125V, White	EA	10
620-704	15A, 125V, Brown – Residential	EA	10
620-705	15A, 125V, Ivory – Residential	EA	10
625-270W	15A 125V, White – Residential	EA	10

U.L. Listed. C.S.A. Certified (NEMA 5-15 Type).

Electrical Outlet Boxes, Extensions and Covers

We have 4in. steel square boxes, extensions, and covers available. Conforms to Article 370 of NEC. U.L. Listed.



CATALOG NO.	DESCRIPTION	UOM	ORDER MULTIPLE
620-401	2-1/8" Deep, 1/2" and 3/4" K.O.s	EA	25
620-403	1-1/2" Deep, 1/2" K.O.s	EA	50
620-404	1-1/2" Deep, 1/2" and 3/4" K.O.s Extension	EA	50
620-406	Flat Blank Cover	EA	50
620-409	Flat, One Duplex Receptacle Cover	EA	50
620-411	One Switch and One Duplex Receptacle Cover	EA	50

Conforms to Article 370 of NEC. U.L. Listed.

Plastic Wall Plates

Non flammable thermoplastic, phenolic or urea material. Color matched 1/2in. long steel mounting screws furnished. Smooth surface – no recessed areas to collect dirt, discolor. Easy to clean. Full weight and thickness provide high dielectric strength, minimum moisture absorption, impact resistance. Warp resistant, fit flush to wall. U.L. Listed. C.S.A. Approved.



CATALOG NO.	DESCRIPTION	UOM	ORDER MULTIPLE
625-2132B	Duplex Receptacle Cover – Brown	EA	25
625-2132V	Duplex Receptacle Cover – Ivory	EA	10
625-2132W	Duplex Receptacle Cover – White	EA	10
625-2134V	Single Toggle Cover – Ivory	EA	25
625-2134W	Single Toggle Cover – White	EA	25

U.L. Listed. C.S.A. Approved.

Electrical Outlet Boxes, Extensions and Covers

Standard steel utility (Handy) boxes and covers.

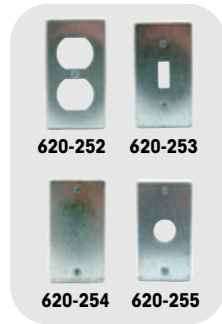

CATALOG NO.	DESCRIPTION	UOM	ORDER MULTIPLE
620-200	1-1/2" Deep, 1/2" K.O.s	EA	50
620-201	1-7/8" Deep, 1/2" K.O.s	EA	50
620-202	2-1/8" Deep, 1/2" K.O.s	EA	50
620-252	Flat, Two Duplex Receptacle Cover	EA	100
620-253	Flat, Toggle Switch Cover	EA	100
620-254	Flat Blank Cover	EA	100
620-255	Flat Cover 1/2" K.O.	EA	100

Conforms to Article 370 of NEC. U.L. Listed.

Switch Covers

Our switch covers come with gas, oil, or emergency already printed on them.



CATALOG NO.	SIZE	TYPE	DESCRIPTION	UOM	ORDER MULTIPLE
625-S17	4" X 4"	Gas	4" Square Box	EA	10
625-S16	4-1/4" X 2-3/4"	Gas	Utility/Handy Box	EA	1
625-S15	4-1/2" X 2-1/2"	Gas	Flush Mount	EA	25
625-S14	4" X 4"	Oil	4" Square Box	EA	1
625-S13	4-1/4" x 2-3/4"	Oil	Utility/Handy Box	EA	1
625-S19	4-1/2" X 2-1/2"	Oil	Flush Mount	EA	1
625-S20	4-3/4" X 2-1/2"	Emergency	Switch Plate	EA	1
625-S18	3/4"		Switch Guard (Wall plate/ switch not included)	EA	1

Eaton Circuit Breakers - Type CH

Type CH Circuit Breakers are 3/4-inch per pole plug-on circuit breakers designed for Eaton's Type CH Loadcenters. They are 10 kAIC arc fault circuit interrupters rated for 120VAC or 240VAC applications.



CATALOG NO.	DESCRIPTION	UOM	ORDER MULTIPLE
CH115	Single Pole, 15A	EA	10
CH120	Single Pole, 20A	EA	10
CH215	Two Pole, 15A	EA	5
CH220	Two Pole, 20A	EA	5
CH230	Two Pole, 30A	EA	5
CH240	Two Pole, 40A	EA	5
CH250	Two Pole, 50A	EA	5
CH260	Two Pole, 60A	EA	5

Switch/Plug Combo

Use with air handlers and condensate pumps. Touch-A-Matic design, with exclusive spring loaded steel ball mechanism for smooth, positive contact movement. Small neon pilot light ON when switch is ON, is built-in to the switch on switch/receptacle.



CATALOG NO.	DESCRIPTION	UOM	ORDER MULTIPLE
620-274W	White 2P 3W Grounding—15A 120V	EA	10

U.L. Listed. C.S.A. Approved.

Eaton Circuit Breakers - Type BR

Type BR Circuit Breakers are 1-inch per pole plug-on circuit breakers designed for Eaton's Type BR Loadcenters. They are 10 kAIC arc fault circuit interrupters rated for 120VAC or 240VAC applications.



CATALOG NO.	DESCRIPTION	UOM	ORDER MULTIPLE
BR115	Single Pole, 15A	EA	10
BR120	Single Pole, 20A	EA	10
BR130	Single Pole, 30A	EA	10
BR215	Two Pole, 15A	EA	5
BR220	Two Pole, 20A	EA	5
BR230	Two Pole, 30A	EA	5
BR240	Two Pole, 40A	EA	5
BR250	Two Pole, 50A	EA	5
BR260	Two Pole, 60A	EA	5
BR2100	Two Pole, 100A	EA	5

UL Certified Universal Circuit Breakers

These Type CL replacement circuit breakers are classified as direct replacements of brand specified circuit breakers by Underwriters Laboratories. These breakers are tested extensively in numerous Square D® HOME-LINE®, General Electric®, Crouse-Hinds®, Thomas & Betts®, Murray® and ITE®/Siemens® Loadcenters.



CATALOG NO.	DESCRIPTION	UOM	ORDER MULTIPLE
625-CL115	UL Circuit Breaker 1-pole, 15A, 0.5"	EA	10
625-CL120	UL Circuit Breaker 1-pole, 20A, 0.5"	EA	10
625-CL220	UL Circuit Breaker 2-pole, 20A, 1.0"	EA	5
625-CL230	UL Circuit Breaker 2-pole, 30A, 1.0"	EA	5
625-CL240	UL Circuit Breaker 2-pole 40A, 1.0"	EA	5
625-CL250	UL Circuit Breaker 2-pole, 50A, 1.0"	EA	5

ELECTRICAL SUPPLIES cont'd

Toggle Switches

These switches are available in single pole double pole. They are UL listed and furnished with screw terminals. The ratings are A:20A 125VAC, 20 250 VAC, 1 HP at 120 240 V and B 15A 125/250 VAC, ¾ HP at 240 V.



CATALOG NO.	DESCRIPTION	RATING	UOM	ORDER MULTIPLE
TS-1	Toggle Switch – SP-ST – ON/OFF	A	EA	1
TS-3	Toggle Switch – SP-DT-CO – ON/OFF/ON	B	EA	1
TS-4	Toggle Switch – DP-ST – ON/OFF	A	EA	1

Replacement Power Supply Cord

- Extends power cords for refrigerators, microwaves, air conditioners and other appliances
- Stripped at one end and angled male plug at other end
- 3-Prong flat cord
- 125VAC



CATALOG NO.	WIRE GAUGE/CONDUCTORS	AMPS	LENGTH	UOM	ORDER MULTIPLE
89221	16/3	15	6'	EA	1
89223	14/3	15	6'	EA	50
89224	14/3	15	6'	EA	50

Dryer Cords

- Thick vinyl insulation with right angle male plug
- 4 Wire - 10/4 Round SRDT Wire
- NEMA 14-30
- 30 Amp @ 125V/250V



CATALOG NO.	WIRE GAUGE/CONDUCTORS	LENGTH	UOM	ORDER MULTIPLE
89231	10/4	4'	EA	12
89233	10/4	6'	EA	12

Right Angle Tri-Tap Portable GFCI

- For indoor or temporary outdoor use
- Provides portable protection on tools, appliances, outdoor equipment, etc.
- Great for jobsites, workshops or marinas
- 3 outlet power cord GFCI protection against hazardous shock
- 15 Amp 120 Volt
- Automatic Reset
- Class A GFCI 4-6mA Trip
- 1875 Watt
- Grounded & Open Neutral Protection
- Insulation Volts: 1500 V RMS
- NEMA 5-15P & (3) 5-15R
- 2' 12/3 AWG SSJTW Cord
- Rainproof
- Complies with NEC 305-6
- Operating Temperature: -31°F to 151°F (-35°C to 66°C)



CATALOG NO.	DESCRIPTION	UOM	ORDER MULTIPLE
89000	Right Angle Tri-Tap Portable GFCI	EA	24

Toggle Switch Cover

Weatherproof body for toggle switches up to 15/16" long.



CATALOG NO.	DESCRIPTION	UOM	ORDER MULTIPLE
625-B1	Toggle Switch Cover	EA	5

Power Supply Cord (Pigtails)

Stranded bare copper conductors. Grounding conductors. PVC jacket. Right and straight angle male plug. 110 Volt. 16 AWG x 6' long. SPT 2.



CATALOG NO.	DESCRIPTION	UOM	ORDER MULTIPLE
625-16-6	Power Supply Cord – Straight Plug	EA	50
625-16-690	Power Supply Cord – 90 Degree Plug	EA	50

Generator Power Cord Sets

- 20 Amp & 30 Amp Cord Sets are designed for use with manual transfer switches, transfer panels and power inlet boxes
- One Piece molded Cord Plugs
- L14 Twist Lock Male/Female Receptacles
- 300 Volt SJTOW Rubber Cord
- -30°F (-34°C) Outdoor Use & Oil Resistant
- L14-20P
- L14-20R
- L14-30P
- L14-30R



CATALOG NO.	AMPS	SIZE	LENGTH	NEMA#	MAX GEN INPUT	UOM	ORDER MULTIPLE
89350	30	10/4	20'	L14-30	7.5 KW	EA	6

Range Cords

- Thick vinyl insulation with right angle male plug
- 4 Wire - 6/2 & 8/2 round SRDT Wire
- NEMA 14-60
- 50A @ 125V/250V



CATALOG NO.	WIRE GAUGE/CONDUCTORS	LENGTH	UOM	ORDER MULTIPLE
89236	6/2+8/2	4'	EA	12
89238	6/2+8/2	6'	EA	12

Heavy Duty Tri-Tap Extension Cord - 3 Outlets

- Heavy Duty 2 Foot Extension Cord with Prong Plug & Lighted Block Style Receptacles
- 15A 125V 12/3 STW Cord with Molded Plug Receptacle
- Lighted Female End to detect power
- Approved under OSHA Standards for Outdoor and Indoor Use



CATALOG NO.	LENGTH	UOM	ORDER MULTIPLE
89312	2'	EA	20

In-Line Tri-Tap Portable GFCI



- For indoor or temporary outdoor use
- Provides portable protection on tools, appliances, outdoor equipment, etc.
- Great for jobsites, workshops or marinas
- 3 outlet power cord GFCI protection against hazardous shock
- 15 Amp 120 Volt
- Automatic Reset
- Class A GFCI 4-6mA Trip
- 1875 Watt
- Grounded & Open Neutral Protection
- Insulation Volts: 1500 V RMS
- NEMA 5-15P & (3) 5-15R
- 2' 12/3 AWG SSJTW Cord
- Rainproof
- Complies with NEC 305-6
- Operating Temperature: -31°F to 151°F (-35°C to 66°C)

CATALOG NO.	DESCRIPTION	UOM	ORDER MULTIPLE
89006	In-Line Tri-Tap Portable GFCI	EA	24

Single Portable GFCI Adapter



- GFCI Protected Plug Only
- Fits any standard 3 wire outlet
- Provides instant GFCI protection
- Immediately detects ground fault from damaged cords or exposure to water and shuts off power to avoid electrocution
- 15 Amp 120 Volt
- Automatic Reset
- Class A GFCI 4-6mA Trip
- 1875 Watt
- Grounded & Open Neutral Protection
- Insulation Volts: 1500 V RMS
- NEMA 5-15P & 5-15R
- 2' 12/3 AWG SSJTW Cord
- Rainproof
- Complies with NEC 305-6
- Operating Temperature: -31°F to 151°F (-35°C to 66°C)

CATALOG NO.	DESCRIPTION	UOM	ORDER MULTIPLE
89002	Single Portable GFCI Adapter	EA	24

4-Outlet GFCI Power Pack



- Automatic Reset
- Right Angle GFCI Plug with power 'ON' LED indicator
- (4) NEMA 5-15R Outlets with separate covers for each outlet
- (1) NEMA 5-15P Plug
- 15 Amp 120 Volt
- 6' 12/3 SJTW Cord
- 15A Circuit Breaker
- Automatic Reset
- Class A GFCI 4-6mA Trip
- 1875 Watt
- Grounded & Open Neutral Protection
- Insulation Volts: 1500 V RMS
- Complies with NEC 305-6
- Operating Temperature: -31°F to 151°F (-35°C to 66°C)



CATALOG NO.	DESCRIPTION	UOM	ORDER MULTIPLE
89008	4-Outlet GFCI Power Pack	EA	24

Right Angle GFCI Plug - Field Wired



- User Attachable
- Compatible with 15 Amp U-ground outlets and plugs
- Trip Level 4-6 mA
- Automatic Reset
- Rated for indoor and outdoor use
- Class "A" people protection and GFCI
- 15 Amp 120 Volt
- 1875 Watts, 60 Hz
- LED Power 'ON' Indicator
- Open Neutral and Ground Neutral protection
- Operating Temperature: -31°F to 151°F (-35°C to 66°C)
- Impact resistant case



CATALOG NO.	DESCRIPTION	UOM	ORDER MULTIPLE
89003	Right Angle GFCI Plug - Field Wired	EA	63

5-Outlet GFCI Shock Buster

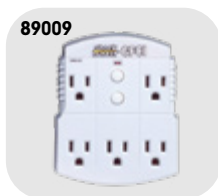

- GFCI Protected
- Plug into any 3-prong dual outlet
- Converts electrical outlet into a safety outlet
- Ideal for family TV rooms, dens, dormitory rooms, garage workshops and rec-rooms
- Protects from damaged electrical cords and hazardous electrical leakage levels
- Quick power shut off to avoid electrocution
- Built-in sensing device to detect leakage currents as low as 4mA
- 15 Amp 120 Volt



CATALOG NO.	DESCRIPTION	UOM	ORDER MULTIPLE
89009	5-Outlet GFCI Shock Buster	EA	60

ELECTRICAL TAPES

7 Mil Professional Grade Electrical Tape

- 3/4" x 66' x 7 Mil
- All Weather Professional Grade Splicing Tape used as primary insulation up to 600V and as a protective outer jacket up to 69KV
- Flame retardant and weather resistant
- Excellent cold weather resistant properties -1°F to 221°F (-18°C to 105°C)
- High dielectric strength, high adhesion and shear
- Highly elastic polymeric vinyl backing - excellent elongation
- Resistant to acids, alkalis, chemicals, oils, moisture and corrosion
- UL 510 and CSA 22.2 approved
- ASTM-D-3005 HH-I-595C
- Lead free



CATALOG NO.	COLOR	SIZE	PACKAGING TYPE	UOM	ORDER MULTIPLE
60110	Black	3/4" x 66'	Plastic Cup	EA	100

7 Mil Commercial Grade Electrical Tape

- 3/4" x 66' x 7 Mil
- Used for General Purpose Splicing as primary insulation to 600V and as a protective outer jacket at higher voltages
- Flame retardant and weather resistant
- Cold weather resistant -1°F to 221°F (-18°C to 105°C)
- Good dielectric strength, high adhesion and shear
- Resistant to acids, alkalis, chemicals, oils, moisture and corrosion
- UL 510 and CSA 22.2 approved
- MIL-I-7798A
- Lead free



CATALOG NO.	COLOR	SIZE	PACKAGING TYPE	UOM	ORDER MULTIPLE
60100	Black	3/4" x 66'	Cello	EA	100

General Purpose Vinyl Electrical Tape

- 3/4" x 60' x 7 Mil
- Used for protective jacketing & bundling/harnessing
- Resistant to acids, alkalis, chemicals, oils, moisture, sunlight and corrosion
- Flame retardant and weather resistant
- UL 510 and CSA 22.2 approved
- Lead free
- 600V



CATALOG NO.	COLOR	PACKAGE TYPE	SLEEVE QTY	UOM	ORDER MULTIPLE
60000	Black	Cello	10	EA	100
60010	Red	Cello	10	EA	100
60020	White	Cello	10	EA	100
60030	Yellow	Cello	10	EA	100
60040	Green	Cello	10	EA	100
60050	Blue	Cello	10	EA	100
60070	Orange	Cello	10	EA	100

8.5 Mil Commercial Grade Electrical Tape

- 3/4" x 66' x 8.5 Mil
- Heavier thickness for added mechanical & electrical protection
- Used for General Purpose Splicing as primary insulation to 600V and as a protective outer jacket at higher voltages
- Flame retardant and weather resistant
- Cold weather resistant -1°F to 221°F (-18°C to 105°C)
- Good dielectric strength, high adhesion and shear
- Resistant to acids, alkalis, chemicals, oils, moisture and corrosion
- UL 510 and CSA 22.2 approved
- MIL-I-7798A
- Lead free



CATALOG NO.	COLOR	SIZE	PACKAGING TYPE	UOM	ORDER MULTIPLE
60200	Black	3/4" x 66'	Cello	EA	100
60202	Black	2" x 66'	Cello	EA	40

Scotch 3M Super 33+ Electrical Tape

Premium grade, 7 mil thick, all-weather vinyl insulating tape. Performs continuously in a temperature ambient of up to 220°F and as low as 0°F. Resealable plastic case. Made in USA.



CATALOG NO.	DESCRIPTION	UOM	ORDER MULTIPLE
ET33	Super 33+ Electrical Tape – 3/4" x 66'	EA	10

Scotch 3M Super 88 Electrical Tape

Premium grade, 8.5 mil thick, all-weather vinyl insulating tape. Performs continuously in a temperature ambient of up to 220°F and as low as 0°F. Excellent resistance to abrasion, moisture, acids and corrosion. Packaged in a resealable plastic case. Made in the USA.



CATALOG NO.	DESCRIPTION	UOM	ORDER MULTIPLE
ET44	Super 88 Electrical Tape – 3/4" x 66'	EA	10

Scotch 35 Vinyl Electrical Tape

This 7 mil premium grade electrical vinyl tape stretches to conform to virtually any shape that requires color-coded insulation. Abrasion and weather resistant. Measures 3/4" x 66'.



CATALOG NO.	DESCRIPTION	UOM	ORDER MULTIPLE
ET35N	Vinyl Electrical Tape – Orange	EA	10
ET35G	Vinyl Electrical Tape – Green	EA	10
ET35R	Vinyl Electrical Tape – Red	EA	10
ET35W	Vinyl Electrical Tape – White	EA	10

ELECTRICAL TAPES cont'd

Economy Electrical Tape

This tape is suitable for use up to 175 F (80C) and not more than 600V. The electrical tape is excellent for adhesion and UL listed.



CATALOG NO.	DESCRIPTION	UOM	ORDER MULTIPLE
6-3460	3/4" x 60' Economy Electrical Tape	EA	10

Glass Cloth, Moisture Sealing, and Economy Electrical Tapes

This is a woven glass cloth tape designed to operate in 600 volt dry applications, requiring high mechanical strength and resistance to high temperatures. The glass cloth is specially treated and prepared to provide corrosion free protection. It will not shrink, rot, or burn and has a high tensile strength. It contains pressure sensitive thermosetting adhesive which performs as Class B temperature (266 degrees F / 130 degrees C). Provides hear stable insulation for hot spot applications Highlight: Color White. Width 1/2in. Length 66 ft. Thickness 7 mil. Tensile Strength (2) 150 lb./in. Material Glass Cloth.



CATALOG NO.	DESCRIPTION	UOM	ORDER MULTIPLE
GC275	1/2" x 66' Glass Cloth Electrical Tape by 3M	EA	10
GC277	3/4" x 66' Glass Cloth Electrical Tape by 3M	EA	10
ET130C1	1" x 30' Moisture Sealing Splicing Tape by 3M	EA	24
ET22	3/4" x 66' Hiawatha Electrical Tape by 3M	EA	10
AT-1700	3/4" x 66' TemFlex™ by 3M	EA	10

TERMINALS, CONNECTORS

Compressor Repair Kit

Finally, a product that simplifies the repair of burned or damaged spade terminals when reconnecting or replacing a compressor. Fits both non burned and burned terminals. Connects to the compressor via precision brass cylinders that fit over the terminals and connect with stainless steel set screws. Wires are permanently attached. Standard factory 600V, 65 strand machine wire. Easy to install and guaranteed for the life of the compressor.



CATALOG NO.	DESCRIPTION	UOM	ORDER MULTIPLE
TLC-3-8	3 Wire, 8 Gauge Connection Kit	EA	1
TLC-3-10	3 Wire, 10 Gauge Connection Kit	EA	1
TLC-3-12	3 Wire, 12 Gauge Connection Kit	EA	1

Transparent Plastic Boxes with Terminal Assortments

Boxes are made of soft, pliable, durable K resin with 18 compartments containing the most popular terminals, including hi temp and compressor terminals.



CATALOG NO.	DESCRIPTION	UOM	ORDER MULTIPLE
PA10	180 Terminals (10 Each Kind)	EA	1
PA25	360 Terminals (20 Each Kind)	EA	1
PA25AP	Appliance Parts Technician Assortment (mostly Hi-Temp)	EA	1
PA18	"K" Resin Plastic Box Only	EA	1

Replacement Compressor Leads

Extreme heat within compressors typically causes failure of wiring insulation. This can cause corrosion to the inner strands of copper within the wire used for compressor hook up. This reduces the power flow to the compressor causing the unit to overheat and can prevent the compressor from starting. A MINIMUM of 12in. of wire must be removed. The DiversiTech Replacement Compressor Leads are ideal for replacing this corroded wiring. 24in. leads also available for replacing wire all the way to the contactor and capacitor.



CATALOG NO.	DESCRIPTION	UOM	ORDER MULTIPLE
CC33	Compressor Leads – 12" with Butt, pack of 3	PK	1
CC33-18	Compressor Leads – 18" with Butt, pack of 3	PK	1
CC33-24	Compressor Leads – 24" with Ring, pack of 3	PK	1

Compartmented Storage Boxes

These boxes can be used to store your compressor terminals, nylon ties and clamps.



CATALOG NO.	DESCRIPTION	UOM	ORDER MULTIPLE
MB21	21 Compartmented Metal Box	EA	1
MB22	21 Compartmented Metal Box w/230 popular items including hi-temp and compressor terminals, nylon ties and clamps	EA	1

TERMINALS, CONNECTORS cont'd

**Grommets – Vinyl
(By Panel Hole Size)**

Grommets safely route cables and wires through sharp edged cutouts.



CATALOG NO.	DESCRIPTION	UOM	ORDER MULTIPLE
GV06*	Grommets – 3/8", pack of 18	PK	1
GV07	Grommets – 7/16", pack of 12	PK	1
GV08*	Grommets – 1/2", pack of 12	PK	1
GV10*	Grommets – 5/8", pack of 7	PK	1
GV12	Grommets – 3/4", pack of 3	PK	1
GV14*	Grommets – 7/8", pack of 4	PK	1
GVA1	Assortment – Small – GV04, GV05, GV06, GV07, GV08, pack of 15	PK	1
GVA2	Assortment – Large – GV08, GV10, GV12, GV14, GV16, pack of 5	PK	1

Sizes shown above also available in 100 packs. Replace "" with "C" for part number.

**Heat Shrink Tubing –
Polyolefin 50% Shrink, Black
Commercial Grade**

Our shrinking tube is economical and mechanically tough heat shrinkable tubing used for insulating, jacketing and identification.



CATALOG NO.	DESCRIPTION	UOM	ORDER MULTIPLE
HS03	3/16" I.D. Expanded – 4" Long, pack of 8	PK	1*
HS04	1/4" I.D. Expanded – 4" Long, pack of 7	PK	1*
HS06	3/8" I.D. Expanded – 4" Long, pack of 6	PK	1*
HS08	1/2" I.D. Expanded – 4" Long, pack of 5	PK	1*
HSA1	Assorted 3/16", 1/4", 3/8" – 4" Long, pack of 7	PK	1
HSA2	Assorted 1/2", 3/4", 1" – 4" Long, pack of 4	PK	1

Available in lengths up to 250 ft.

*These items are also available in bulk. To order, enter the catalog number followed by the letter "B". For example, HS03B is the bulk part number for HS03. Bulk items are priced and shipped by the foot.

200 Piece Terminal Kit

- High impact re-usable plastic box
- Assortment of ring & spade terminals, butt connectors, male & female disconnects

TERMINALS IN KIT

DESCRIPTION	QTY
Ring Terminal 22-16 #6	4
Ring Terminal 22-16 #8	4
Ring Terminal 22-16 #10	4
Ring Terminal 16-14 #6	4
Ring Terminal 16-14 #8	4
Ring Terminal 16-14 #10	5
Ring Terminal 12-10 #8	4
Ring Terminal 12-10 #10	6
Ring Terminal 12-10 1/4"	5
Ring Terminal 12-10 5/16"	4
Spade Terminal 22-16 #6	11
Spade Terminal 22-16 #8	13
Spade Terminal 22-16 #10	4
Spade Terminal 16-14 #6	5
Spade Terminal 16-14 #8	4
Spade Terminal 16-14 #10	4
Spade Terminal 12-10 #8	4
Spade Terminal 12-10 #10	16
Spade Terminal 12-10 1/4"	4
Butt connector 22-18	11
Butt connector 16-14	11
Butt connector 12-10	9
Vinyl Male Disconnect 22-16 .250	4
Vinyl Male Disconnect 22-14 .250	4
Vinyl Male Disconnect 22-10 .250	4
Vinyl Female Disconnect 22-18 .250	5
Vinyl Female Disconnect 16-14 .187	4
Vinyl Female Disconnect 16-14 .250	11
Vinyl Female Disconnect 12-10 .250	13
Nyl Full Ins Fem Discon 22-18	4
Nyl Full Ins Fem Discon 16-14	5
Nyl Full Ins Fem Discon 12-10 .250	4
Nyl Full Ins Male Discon 22-18 .250	4
Nyl Full Ins Male Discon 16-14 .250	4



CATALOG NO.	DESCRIPTION	UOM	ORDER MULTIPLE
10816	200 Piece Terminal Kit	EA	5

THERMAL CONTROLS

Fusible Links

Fusible Links are temperature sensitive, one time devices. Engineered as safety links, they open the circuit if the designed limit temperature is reached.

CATALOG NO.	FUSIBLE TEMP °F	TYPE	PRONG TYPE	QTY/PACK	UOM	ORDER MULTIPLE
HFL-4257	257°	In-Line		pack of 4	PK	1
HFL-4300	300°	In-Line		pack of 4	PK	1
HFL-4333	333°	In-Line		pack of 4	PK	1
HFL-5257	257°	Face Plate	Straight	pack of 2	PK	1
HFL-5258	257°	Face Plate	Right Angle	pack of 2	PK	1
HFL-5300	300°	Face Plate	Straight	pack of 2	PK	1
HFL-5301	300°	Face Plate	Right Angle	pack of 2	PK	1
HFL-5333	333°	Face Plate	Straight	pack of 2	PK	1



Replacement Element Kits

Field repair damaged element sections of electric heaters. Each kit contains a specific KW replacement element, two ceramic terminal insulator sets, plated bolts, nuts and washers.

CATALOG NO.	WATTAGE AT		IN PLACE LENGTH (INCHES)		UOM	ORDER MULTIPLE
	240V	208V	MINIMUM	MAXIMUM		
HEK-500	5000	3750	54"	162"	EA	1



Sequencers

The sequencers are used in electric heat systems to stage blower motors and heating elements. All sequencers are for 24V control.

CATALOG NO.	NO. CIRCUITS	KILXON NO.	SWITCH CONFIGURATION	DELAY ON TIME MIN.-MAX. SECONDS	DELAY OFF TIME MIN.-MAX. SECONDS	UOM	ORDER MULTIPLE
HDR-101	1 Main	60000A0211	SPST-NO	1-24	45-75	EA	1
HDR-102	1 Main	60000A0147	SPST-NO	30-75	1-40	EA	1
HDR-201	2 Main	60000E0110	DPST-NO	1-24	45-75	EA	1
HDR-202	2 Main	60000E0109	DPST-NO	30-70	1-40	EA	1
HDR-211	2 Main Staged	60200A0117	DPST-NO	30-110	1-40	EA	1
HDR-212	2 Main Staged	60200A0127	DPST-NO	1-25	50-110	EA	1
HDR-221	3 Main Staged	51172-131-1	DPST-NO SPST-NO	1-25	50-110	EA	1
HDR-222	4 Main Staged	51172-131-2	2 DPST-NO	1-40	50-110	EA	1

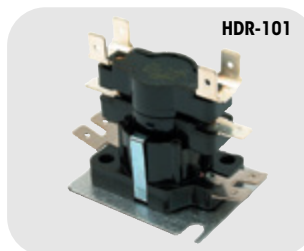

Manual Reset Fire Stat

This bi metal switch is used as a manual reset. When temperature condition is met, the device opens. The manual reset can only be reset after proper cool down of the switch. The HMR 130 is a popular fire stat in ducted air distribution systems. Should temperatures in the duct exceed 130 degree F, the switch opens, shutting down the whole system so no fire or smoke can be spread by the fan.

CATALOG NO.	DESCRIPTION	UOM	ORDER MULTIPLE
HMR-130	Bi-metal Manual Reset Fire Stat	EA	1



THERMOSTATS

LuxPro Thermostats

LuxPro thermostats are designed to be a reliable, simple solution to in home comfort, so that everyone can enjoy the benefits and comforts of advanced temperature control. Diversitech offers a variety of LuxPro models and options to match any installation need.

CATALOG NO.	DESCRIPTION	UOM	ORDER MULTIPLE
675-P521U	5-2 program, 2 H/1 C, Programmable	EA	1
675-P621U	5-1-1 program, 2 H/1 C, Programmable	EA	1
675-P721UT	7 Day, 2 H/1 C, Programmable, Touchscreen	EA	1
675-P722U	7 Day, Programmable, 2 H/2 C for Conventional, 2 H/1 C for Heat Pumps	EA	1
675-PSD010BF	Digital for Heat Only, with Fan Switch	EA	1
675-PSD111	1 H/1 C, Non-Programmable, Vertical/Horizontal	EA	1
675-PSDH121	1 or 2 H/C, Non-Programmable, Vertical/Horizontal	EA	1
675-PSM30SA	Heat Only Mechanical	EA	1
675-PSM40SA	Heating & Cool Mechanical	EA	1



THERMOSTAT GUARDS

Plastic Thermostat Guards

Use to prevent tampering with thermostats. The covers are clear, allowing complete viewing of the thermostat and current settings. Furnished complete with ring and/or solid base. Includes vent holes for easy airflow across the thermostat. Lockable with universal key. Internal dimensional clearance/sizing for thermostats as noted.



CATALOG NO.	DESCRIPTION	T-STAT CLEARANCE	UOM	ORDER MULTIPLE
585-TG	Clear Plastic w/Two Bases	8-1/4" x 4-1/2" x 3-1/4"	EA	1
585-TG1	Clear Plastic w/Two Bases	5-3/4" x 3-1/2" x 2-3/4"	EA	1
585-TG2	Clear Plastic w/Two Bases	4-3/4" x 4-1/4" x 2-3/4"	EA	1
585-TG5	Clear Plastic w/Solid Base	3-1/2" x 3-1/4" x 2-1/4"	EA	1
585-TG6	Clear Plastic w/Two Bases	6-1/4" x 3-3/4" x 1-3/4"	EA	1
585-F336	Key for Thermostat Guard		EA	1

Cross Reference

DIVERSITECH PART NO.	BEKO PART NO.	BRAMEC PART NO.	MARS PART NO.
585-TG	BTG-UK2	13012	70220
585-TG1	BTG-RK	13016	70210
585-TG2	BTG-K	13008	70205
585-TG5	BTG-EK	13004	70201
585-TG6	BTG-DK	13018	70217
585-TG8	BTG-54VLW	13001	70216

Steel Thermostat Guards

Steel thermostat guards are used to prevent tampering with thermostats. The covers are steel, giving complete tamper protection of the thermostat, and physical impact protection. Great for warehouse and industrial locations. Furnished complete with ring and/or solid base as noted. Includes vent holes for easy airflow across the thermostat. Lockable with universal key. Internal dimensional clearance/sizing for thermostats as noted.



CATALOG NO.	DESCRIPTION	T-STAT CLEARANCE	UOM	ORDER MULTIPLE
585-TG3	Beige Steel w/Solid Base	6" x 4" x 3"	EA	1
585-TG4	Beige Steel w/Ring Base	6" x 4" x 3"	EA	1
585-TG7	Beige Steel w/Solid Base	5-1/2" x 3-1/2" x 2-3/4"	EA	1
585-TG8	Beige Steel w/Ring Base	5" x 3" x 2-3/4"	EA	1
585-TG9	Beige Steel w/Two Bases	6" x 4" x 3"	EA	1

THERMOSTAT WIRE

Thermostat Wire

Class 2 thermostat wire for indoor wiring needs. Soft drawn bare copper wire, semi rigid PVC insulation and PVC overall jacket. Packaged on aluminum spool.



CATALOG NO.	DESCRIPTION	UOM	ORDER MULTIPLE
620-18-2	18 AWG, 2 Conductors – 500 ft. Spool	EA	4
620-18-3	18 AWG, 3 Conductors – 500 ft. Spool	EA	4
620-18-4	18 AWG, 4 Conductors – 250 ft. Spool	EA	4
620-18-5	18 AWG, 5 Conductors – 250 ft. Spool	EA	4
620-18-6	18 AWG, 6 Conductors – 250 ft. Spool	EA	4
620-18-7	18 AWG, 7 Conductors – 250 ft. Spool	EA	4
620-18-8	18 AWG, 8 Conductors – 250 ft. Spool	EA	4
620-18-10	18 AWG, 10 Conductors – 250 ft. Spool	EA	4
620-20-3	20 AWG, 3 Conductors – 500 ft. Spool	EA	4
620-20-4	20 AWG, 4 Conductors – 250 ft. Spool	EA	4
620-20-5	20 AWG, 5 Conductors – 250 ft. Spool	EA	4
620-20-6	20 AWG, 6 Conductors – 250 ft. Spool	EA	4
620-20-7	20 AWG, 7 Conductors – 250 ft. Spool	EA	4
620-20-8	20 AWG, 8 Conductors – 250 ft. Spool	EA	4
620-20-10	20 AWG, 10 Conductors – 250 ft. Spool	EA	4

U.L. Listed. Meets Subject 13 per Article 725, 1990 NEC.

Plenum Thermostat Wire

The Plenum Thermostat Wire is UL Listed type CL2P NEC Article 725 and is designed for use in thermostat control applications.



CATALOG NO.	DESCRIPTION	UOM	ORDER MULTIPLE
620-18-2P	18 AWG, 2 Conductors – 500 ft. Spool	EA	4
620-18-3P	18 AWG, 3 Conductors – 500 ft. Spool	EA	4
620-18-6P	18 AWG, 6 Conductors – 250 ft. Spool	EA	4
620-18-8P	18 AWG, 8 Conductors – 250 ft. Spool	EA	4

Wire for Mini-Split Installation

Wire and cabling specific for mini split installation power supply and control circuits.

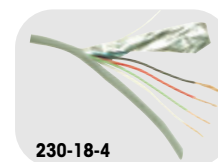

CATALOG NO.	DESCRIPTION	UOM	ORDER MULTIPLE
230-18-4	Stranded Shielded CL3R, 50' per roll	EA	1
230-14-4	Stranded Non-Shielded CL3R, 50' per roll	EA	1
230-14-7	Stranded Non-Shielded CL3R, 50' per roll	EA	1
230-14-4S	Stranded Shielded CL3R, 50' per roll	EA	1

THERMOSTAT WIRE

HVAC Mini-Split Wiring Solutions

Southwire® is a market leader with its EZ-In™ Mini-Split cable designed specifically for mini-split installations. EZ-In™ Mini-Split cable, available in both shielded and non-shielded configurations, has brought ease of installation and savings to HVAC mini-split installations by eliminating the use of conduit or cable trays. Now, Southwire® has enhanced its offering with connectors and tools specifically designed with mini-split installations in mind.

CATALOG NO.	DESCRIPTION	UOM	ORDER MULTIPLE
59351202	EZ-IN Shielded Mini-Split Cable, 14-4 Stranded, 600V, 250FT Reel	EA	1
59351203	EZ-IN Shielded Mini-Split Cable, 14-4 Stranded, 600V, 50FT Bag	EA	1
64235201	EZ-IN Shielded Mini-Split Cable Liquid Tight Straight Connector, 1/2" Hub Size	EA	25
64275801	EZ-IN Shielded Mini-Split Cable Liquid Tight 90 Degree Connector, 1/2" Hub Size	EA	15
58278040	Wire Strippers and Cutters, Heavy Duty, Stainless Steel, for 18-10AWG Wires	EA	5
58282040	Compact Conduit and Metal Scorer, Jacket Cutter	EA	3
58282240	Rotary Armor Cable Cutter with Rotary Blade	EA	2
58282340	Replacement Rotary Cutter Blades	EA	5
64846401	Point of Purchase Display with Liquid Tight Straight and 90 Degree Connectors, Cutter, Replacement Blades	EA	1



STRANDED COPPER THHN WIRE

Stranded Copper Wire in Clear Dispenser Pack, 194°F

This copper wire is UL listed and THHN wire. It is 19 strand copper and is 600 V as well as 90°C Stranded.



CATALOG NO.	DESCRIPTION	UOM	ORDER MULTIPLE
W801	08 Gauge, 10 ft., Black	EA	1
W802	08 Gauge, 10 ft., Red	EA	1
W803	08 Gauge, 10 ft., Green	EA	1
W805	08 Gauge, 10 ft., White	EA	1
W101	10 Gauge, 10 ft., Black	EA	1
W102	10 Gauge, 10 ft., Red	EA	1
W103	10 Gauge, 10 ft., Green	EA	1
W104	10 Gauge, 10 ft., Blue	EA	1
W105	10 Gauge, 10 ft., White	EA	1
W121	12 Gauge, 15 ft., Black	EA	1
W122	12 Gauge, 15 ft., Red	EA	1
W123	12 Gauge, 15 ft., Green	EA	1
W124	12 Gauge, 15 ft., Blue	EA	1
W125	12 Gauge, 15 ft., White	EA	1
W141	14 Gauge, 20 ft., Black	EA	1
W142	14 Gauge, 20 ft., Red	EA	1
W143	14 Gauge, 20 ft., Green	EA	1
W144	14 Gauge, 20 ft., Blue	EA	1
W145	14 Gauge, 20 ft., White	EA	1

Stranded Copper Wire on Spool

This copper wire is UL listed and THHN wire. It is 19 strand copper and is 600 V as well as 90°C Stranded. This comes 100 ft. per spool.



CATALOG NO.	DESCRIPTION	UOM	ORDER MULTIPLE
W801-100	08 Gauge, 100 ft. Spool, Black	EA	1
W802-100	08 Gauge, 100 ft. Spool, Red	EA	1
W803-100	08 Gauge, 100 ft. Spool, Green	EA	1
W804-100	08 Gauge, 100 ft. Spool, Blue	EA	1
W805-100	08 Gauge, 100 ft. Spool, White	EA	1
W101-100	10 Gauge, 100 ft. Spool, Black	EA	1
W102-100	10 Gauge, 100 ft. Spool, Red	EA	1
W103-100	10 Gauge, 100 ft. Spool, Green	EA	1
W104-100	10 Gauge, 100 ft. Spool, Blue	EA	1
W105-100	10 Gauge, 100 ft. Spool, White	EA	1
W121-100	12 Gauge, 100 ft. Spool, Black	EA	1
W122-100	12 Gauge, 100 ft. Spool, Red	EA	1
W123-100	12 Gauge, 100 ft. Spool, Green	EA	1
W124-100	12 Gauge, 100 ft. Spool, Blue	EA	1
W125-100	12 Gauge, 100 ft. Spool, White	EA	1
W141-100	14 Gauge, 100 ft. Spool, Black	EA	1
W142-100	14 Gauge, 100 ft. Spool, Red	EA	1
W143-100	14 Gauge, 100 ft. Spool, Green	EA	1
W144-100	14 Gauge, 100 ft. Spool, Blue	EA	1
W145-100	14 Gauge, 100 ft. Spool, White	EA	1

STRANDED COPPER THHN WIRE cont'd

Stranded Copper Wire on Spool

This copper wire is UL listed and THHN wire. It is 19 strand copper and is 600 V as well as 90°C Stranded. This comes 50 ft. per spool.



CATALOG NO.	DESCRIPTION	UOM	ORDER MULTIPLE
W801-50	08 Gauge, 50 ft. Spool, Black	EA	1
W802-50	08 Gauge, 50 ft. Spool, Red	EA	1
W803-50	08 Gauge, 50 ft. Spool, Green	EA	1
W804-50	08 Gauge, 50 ft. Spool, Blue	EA	1
W101-50	10 Gauge, 50 ft. Spool, Black	EA	1
W102-50	10 Gauge, 50 ft. Spool, Red	EA	1
W103-50	10 Gauge, 50 ft. Spool, Green	EA	1
W104-50	10 Gauge, 50 ft. Spool, Blue	EA	1
W105-50	10 Gauge, 50 ft. Spool, White	EA	1
W121-50	12 Gauge, 50 ft. Spool, Black	EA	1
W122-50	12 Gauge, 50 ft. Spool, Red	EA	1
W123-50	12 Gauge, 50 ft. Spool, Green	EA	1
W124-50	12 Gauge, 50 ft. Spool, Blue	EA	1
W125-50	12 Gauge, 50 ft. Spool, White	EA	1
W141-50	14 Gauge, 50 ft. Spool, Black	EA	1
W142-50	14 Gauge, 50 ft. Spool, Red	EA	1
W143-50	14 Gauge, 50 ft. Spool, Green	EA	1
W144-50	14 Gauge, 50 ft. Spool, Blue	EA	1
W145-50	14 Gauge, 50 ft. Spool, White	EA	1

High Temperature Wire, 400°F (204°C), 600 V.

7 strand tin coated copper wire with silicone rubber insulation protected by a braided fiberglass jacket. Use on the front of all gas furnaces with spark ignition because of flame roll out on start up. Also on all power feeds to electric strip and duct heaters. Also used on all heat producing food preparation equipment.



CATALOG NO.	DESCRIPTION	UOM	ORDER MULTIPLE
WHT20	14 gauge, 10 ft. black, 10 ft. white	EA	1
WHTB14-50	14 gauge, black, 50 ft.	EA	1
WHTR14-50	14 gauge, red, 50 ft.	EA	1
WHTW14-50	14 gauge, white, 50 ft.	EA	1
WHTB12-50	12 gauge, black, 50 ft.	EA	1
WHTB10-50	10 gauge, black, 50 ft.	EA	1

WIRE CONNECTORS

Wire Connectors—Screw On, U.L. Listed, C.S.A Approved

Color coded connectors make quick, secure connections for positive continuity. High dielectric thermoplastic shell resists chemical action from hydrocarbons, dilute acid or alkaline solutions. Deep skirt design prevents exposure of bare wire.



CATALOG NO.	DESCRIPTION	UOM	ORDER MULTIPLE
623-001	Gray Screw-On – Size 71B, #22 to #16 AWG, 300V Max., pack of 100	PK	1
623-002	Blue Screw-On – Size 72B, #22 to #16 AWG, 300V Max., pack of 100	PK	1
623-003	Orange Screw-On – Size 73B, #22 to #14 AWG, 600V Max., pack of 100	PK	1
623-004	Yellow Screw-On – Size 74B, #18 to #10 AWG, 600V Max., pack of 100	PK	1
623-005	Red Screw-On – Size 76B, #18 to #10 AWG, 600V Max., pack of 100	PK	1

U.L. Listed. CSA Approved.

Wire Connectors—Winged, U.L. Listed, C.S.A Approved

Wings give surer grip; offset center design provides great twisting leverage. Expandable square-wire spring instantly adjusts to shape and size to create a strong, vibration-resistant connection. Same tough shell as screw-on type.



CATALOG NO.	DESCRIPTION	UOM	ORDER MULTIPLE
623-000	Lg. Gray Winged – Size 78B, #14 to #8 AWG, 600V Max., pack of 50	PK	1
623-006	Yellow Winged – Size 84, #22 to #10 AWG, 600V Max., pack of 100	PK	1
623-007	Red Winged – Size 86, #18 to #10 AWG, 600V Max., pack of 100	PK	1
623-008	Blue Winged – Size 89, #10 to #6, 600V Max., pack of 50	PK	1

U.L. Listed. C.S.A. Approved.

Twist-On Wire Connectors Combo Kit

The 623-MIX Twist-On Wire Connectors Combo Kit is a very handy and convenient wire connector kit. It contains 600 pieces of color-coded, twist-on and winged twist-on wire connectors in 9 commonly used sizes. Its durable and configurable Plano box is a great organizer for wire connector refills and storage. A wiring combinations chart for each connector is also included. It is a great truck stock item for contractors.



CATALOG NO.	DESCRIPTION	UOM	ORDER MULTIPLE
623-MIX	Twist-On Wire Connectors Combo Kit, Pack of 600	PK	1

U.L. Listed. CSA Approved.

Wire Connectors—Contractor Packs, U.L. Listed, C.S.A Approved

These connectors have a high dielectric thermoplastic shell. These are UL listed and CSA approved. This product is great for making quick and secure connections.



CATALOG NO.	DESCRIPTION	UOM	ORDER MULTIPLE
C222	Closed End Connectors 22-14 W, pack of 18	PK	1
C222C	Closed End Connectors 22-14 W, pack of 100	PK	1
C223	Closed End Connectors 18-10 W, pack of 15	PK	1
C223C	Closed End Connectors 18-10 W, pack of 100	PK	1
C241	Blue Wire Connectors 22-16 W, pack of 20	PK	1
C241L	Blue Wire Connectors 22-16 W, pack of 50	PK	1
C243	Orange Wire Connectors 22-14 W, pack of 15	PK	1
C243L	Orange Wire Connectors 22-14 W, pack of 50	PK	1
C245	Yellow Wire Connectors 18-10 W, pack of 13	PK	1
C245L	Yellow Wire Connectors 18-10 W, pack of 50	PK	1
C247	Red Wire Connectors 18-10 W, pack of 10	PK	1
C312	Yellow Winged Wire Connectors, pack of 13	PK	1
C312L	Yellow Winged Wire Connectors, pack of 50	PK	1
C512	Red Winged Wire Connectors, pack of 10	PK	1
C512L	Red Winged Wire Connectors, pack of 50	PK	1

U.L. Listed. CSA Approved.

Wire Connectors—Screw On, U.L. Listed, C.S.A Approved

Color coded connectors make quick, secure connections for positive continuity. High dielectric thermoplastic shell resists chemical action from hydrocarbons, dilute acid or alkaline solutions. Deep skirt design prevents exposure of bare wire. New handy carry handle and grip bottle. U.L. Listed. C.S.A. Approved.



CATALOG NO.	DESCRIPTION	UOM	ORDER MULTIPLE
623-012	Blue Screw-On – Size 72B, #22 to #16 AWG, 300V Max., pack of 600	PK	1
623-013	Orange Screw-On – Size 73B, #22 to #14 AWG, 600V Max., pack of 300	PK	1
623-014	Yellow Screw-On – Size 74B, #18 to #10 AWG, 600V Max., pack of 200	PK	1

U.L. Listed. CSA Approved.

Porcelain Wire Connectors

Porcelain Wire Connectors are used in high temperature applications such as appliances.



CATALOG NO.	DESCRIPTION	AWG	UOM	ORDER MULTIPLE
CPN1	Porcelain – Small, pack of 15	22-16, 2 Strand Wire	PK	1
CPN1C	Porcelain – Small, pack of 100	22-16, 2 Strand Wire	PK	1
CPN2	Porcelain – Medium, pack of 10	18-14, 2 Strand Wire	PK	1
CPN2C	Porcelain – Medium, pack of 100	18-14, 2 Strand Wire	PK	1
CPN3	Porcelain – Large, pack of 10	18-14, 3 Strand Wire	PK	1
CPN3C	Porcelain – Large, pack of 100	18-14, 3 Strand Wire	PK	1
CPN2M	Porcelain – Medium, pack of 1000	18-14, 2 Strand Wire	PK	1

WIRE/CABLE TIES, MOUNTS, CLAMPS

Cable Tie Assortment Pack

6.6 nylon, the heavy duty duct straps feature smooth insertion, and a locking mechanism that gives ductwork a firm hold. Accommodates 7 to 15 inch duct. Tensioning tool for 32"+ allows operator to adjust strap to any desired tension.



CATALOG NO.	DESCRIPTION	UOM	ORDER MULTIPLE
7-711	Natural Cable Tie Assortment – 7" and 11", pack of 150	PK	25
7-711-B	Black Cable Tie Assortment – 7" and 11", pack of 150	PK	25
7-5811	Natural Cable Tie Assortment – 5", 8", and 11", pack of 450	PK	30
7-5811-B	Black Cable Tie Assortment – 5", 8", and 11", pack of 450	PK	30

Heavy Duty Cable Ties

6.6 nylon, the heavy duty duct straps feature smooth insertion, and a locking mechanism that gives ductwork a firm hold. Accommodates 7 to 15 inch duct. Tensioning tool for 32"+ allows operator to adjust strap to any desired tension.



CATALOG NO.	DESCRIPTION	UOM	ORDER MULTIPLE
7-P24	24" Long – Fits up to 6" Duct – 175 lb. Tensile	EA	50
7-P36	36" Long – Fits up to 10" Duct – 175 lb. Tensile	EA	50
7-P36B	36" Long – Black – Fits up to 10" Duct – 175 lb. Tensile	EA	50
7-P48	48" Long – Fits up to 14" Duct – 175 lb. Tensile	EA	50
7-P48B	48" Long – Black – Fits up to 14" Duct – 175 lb. Tensile	EA	25
7-L300	Tensioning Tool for 120-175 lb. Ties	EA	1

WIRE/CABLE TIES, MOUNTS, CLAMPS cont'd

White Nylon Ties with Mounting Hole

These wire ties are perfect for securing wires. You can choose from an assortment of sizes.



CATALOG NO.	DESCRIPTION	TENSILE STRENGTH	UOM	ORDER MULTIPLE
WTM05	White Wire Ties with Mounting Hole – 5" Nylon, pack of 13	18	PK	1
WTM05C	White Wire Ties with Mounting Hole – 5" Nylon, pack of 100	18	PK	1
WTM07	White Wire Ties with Mounting Hole – 7" Nylon, pack of 11	50	PK	1
WTM07C	White Wire Ties with Mounting Hole – 7" Nylon, pack of 100	50	PK	1
WTM11	White Wire Ties with Mounting Hole – 11" Nylon, pack of 6	50	PK	1
WTM11C	White Wire Ties with Mounting Hole – 11" Nylon, pack of 100	50	PK	1
WTM14C	White Wire Ties with Mounting Hole – 14" Nylon, pack of 100	50	PK	1

Black Nylon Ties with Mounting Hole

These wire ties are perfect for securing wires. You can choose from an assortment of sizes.



CATALOG NO.	DESCRIPTION	TENSILE STRENGTH	UOM	ORDER MULTIPLE
WTMB05C	Black Wire Ties with Mounting Hole – 5" Nylon, pack of 100	18	PK	1
WTMB07	Black Wire Ties with Mounting Hole – 7" Nylon, pack of 10	50	PK	1
WTMB07C	Black Wire Ties with Mounting Hole – 7" Nylon, pack of 100	50	PK	1
WTMB11	Black Wire Ties with Mounting Hole – 11" Nylon, pack of 6	50	PK	1
WTMB11C	Black Wire Ties with Mounting Hole – 11" Nylon, pack of 100	50	PK	1
WTMB14C	Black Wire Ties with Mounting Hole – 14" Nylon, pack of 100	50	PK	1

Wire and Cable Clamps – Nylon

These wire ties are perfect for securing wires. You can choose from an assortment of diameter sizes.



CATALOG NO.	DESCRIPTION	UOM	ORDER MULTIPLE
WC02	Wire and Cable Clamps – 1/8" Diameter, pack of 40	PK	1
WC03	Wire and Cable Clamps – 3/16" Diameter, pack of 40	PK	1
WC04	Wire and Cable Clamps – 1/4" Diameter, pack of 35	PK	1
WC05	Wire and Cable Clamps – 5/16" Diameter, pack of 35	PK	1
WC06	Wire and Cable Clamps – 3/8" Diameter, pack of 30	PK	1
WC08	Wire and Cable Clamps – 1/2" Diameter, pack of 25	PK	1
WC09	Wire and Cable Clamps – 9/16" Diameter, pack of 20	PK	1
WC10	Wire and Cable Clamps – 5/8" Diameter, pack of 20	PK	1
WC12	Wire and Cable Clamps – 3/4" Diameter, pack of 15	PK	1
WC14	Wire and Cable Clamps – 7/8" Diameter, pack of 15	PK	1
WC16	Wire and Cable Clamps – 1" Diameter, pack of 14	PK	1
WCA1	Wire and Cable Clamps Assortment – 1/8" to 1", pack of 26	PK	1

All above sizes are available in 100 packs. Add "C" to the end of the part number.

White Nylon Wire Ties

These wire ties are perfect for securing wires. You can choose from an assortment of sizes.

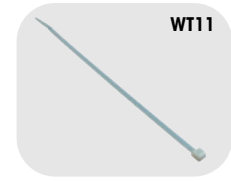

CATALOG NO.	DESCRIPTION	TENSILE STRENGTH	UOM	ORDER MULTIPLE
WT04	White Wire Ties – 4" Nylon, pack of 40	18	PK	1
WT04C	White Wire Ties – 4" Nylon, pack of 100	18	PK	1
WT05	White Wire Ties – 5" Nylon, pack of 35	18	PK	1
WT05C	White Wire Ties – 5" Nylon, pack of 100	18	PK	1
WT07	White Wire Ties – 7" Nylon, pack of 30	50	PK	1
WT07C	White Wire Ties – 7" Nylon, pack of 100	50	PK	1
WT11	White Wire Ties – 11" Nylon, pack of 15	50	PK	1
WT11C	White Wire Ties – 11" Nylon, pack of 100	50	PK	1
WT11L	White Wire Ties – 11" Nylon, pack of 50	50	PK	1
WT15	White Wire Ties – 15" Nylon, pack of 12	50	PK	1
WT15C	White Wire Ties – 15" Nylon, pack of 100	50	PK	1
WTA1	White Wire Ties – Assorted 4", 7", and 11" Nylon, pack of 30		PK	1

Black Nylon Wire Ties

These wire ties are perfect for securing wires. You can choose from an assortment of sizes. Ultraviolet resistant for outdoor use.

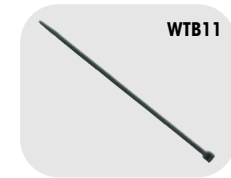

CATALOG NO.	DESCRIPTION	TENSILE STRENGTH	UOM	ORDER MULTIPLE
WTB05	Black Wire Ties – 6" Nylon, pack of 35	18	PK	1
WTB05C	Black Wire Ties – 6" Nylon, pack of 100	18	PK	1
WTB07	Black Wire Ties – 7" Nylon, pack of 30	50	PK	1
WTB07C	Black Wire Ties – 7" Nylon, pack of 100	50	PK	1
WTB07M	Black Wire Ties – 7" Nylon, pack of 1000	50	PK	1
WTB11	Black Wire Ties – 11" Nylon, pack of 15	50	PK	1
WTB11C	Black Wire Ties – 11" Nylon, pack of 100	50	PK	1
WTB11CR	Black Wire Ties, Releasable – 11" Nylon, pack of 100	50	PK	25
WTB11D	Black Wire Ties – 11" Nylon, pack of 500	50	PK	1
WTB11M	Black Wire Ties – 11" Nylon, pack of 1000	50	PK	1
WTB15	Black Wire Ties – 14" Nylon, pack of 12	50	PK	1
WTB15C	Black Wire Ties – 15" Nylon, pack of 100	50	PK	1
WTBA1	Black Wire Ties – Assorted 4", 7", and 11" Nylon, pack of 28	50	PK	1

Wire Tie Mounts

These mounts are use for mounting wires in electrical work.



CATALOG NO.	DESCRIPTION	UOM	ORDER MULTIPLE
WTM1	White Wire Tie Mounts – Adhesive Back, pack of 4	PK	1
WTM1C	White Wire Tie Mounts – Adhesive Back, pack of 100	PK	1
WTM2	White Wire Tie Mounts – #8 Screw, pack of 7	PK	1
WTM2C	White Wire Tie Mounts – #8 Screw, pack of 100	PK	1

TOOLS

Brushes.....	119-120
Channellock® Products	120
Electrical Supplies	121
Fin Tools	121-122
Gauges	123
Manometers, Pressure And Test Kits	124
Miscellaneous Tools.....	124
Monitors.....	125
Refractometers	125
Rehvac Nitrogen Purging Equipment.....	118
Rehvac Refillable Gas Cylinders.....	118
Saws and Saw Blades.....	126
Screwdrivers, Driver Sets	126
Snips, Notchers, Crimpers, Seamers	127
SPIN Tools	125
Staples and Staple Guns.....	124
Straps, Truck Rope.....	127-128
Test Leads	128
Testers	129
Thermometers/Probes	129
Tube Working Tools	130
Welding Torches, Supplies	130
Worklights by Cliplight®	122-123



REHVAC NITROGEN PURGING EQUIPMENT

Regulators

Rehvac nitrogen and CO₂ regulators feature a machined brass piston with internal bleed-down safety. This design makes the Rehvac regulator long lasting and reliable.



CT-475M

CATALOG NO.	DESCRIPTION	UOM	ORDER MULTIPLE
CA-252C	Rehvac Adjustable Regulator, 0-250psi	EA	1
CT-475M	Regulator, N/CO ₂ – 0-475 psi	EA	1

Gauges

Rehvac replacement gauges are reliable and easy to read.



GA-06

CATALOG NO.	DESCRIPTION	UOM	ORDER MULTIPLE
GA-06	Rehvac 600psi Low Pressure Replacement Gauge	EA	1
GA-30	Rehvac 3000psi High Pressure Replacement Gauge	EA	1

Hoses

Rehvac hoses are designed specifically for air, nitrogen, or CO₂ service. Featuring a 600psi working pressure and a 2200psi burst pressure, Rehvac hoses are abrasion resistant and long lasting.



CW-30

CATALOG NO.	DESCRIPTION	UOM	ORDER MULTIPLE
CW-30	Rehvac 30" Whip Hose	EA	1

Nitrogen Purge Tool

The Nitrogen Purge Tool is a quick and easy way to purge copper pipes with nitrogen. Then, with a turn of the dial, quickly switch to a very low flow of nitrogen to properly braze the copper. It has a durable aluminum design so you can just throw it into your tool bag when you are done.



DP-1

CATALOG NO.	DESCRIPTION	UOM	ORDER MULTIPLE
DP-1	Nitrogen Purge Tool	EA	1

REHVAC REFILLABLE GAS CYLINDERS

Nitrogen Cylinders

Rehvac aluminum nitrogen cylinders from DiversiTech are commonly used in the HVAC industry for line cleaning and purging, pressure testing and braze purging. Made in the USA.



N20-SD

CATALOG NO.	DESCRIPTION	UOM	ORDER MULTIPLE
N20-SD	Rehvac Nitrogen Cylinder 57 cu ft	EA	1

CO₂ Cylinders

Rehvac aluminum CO₂ cylinders from DiversiTech are commonly used in the HVAC industry for condensate line cleaning.



C10

CATALOG NO.	DESCRIPTION	UOM	ORDER MULTIPLE
C10	Rehvac 10# Aluminum Cylinder	EA	1
C1-2-6	Rehvac 1.2# Cylinder	EA	1
C20	Rehvac 20# Aluminum Cylinder	EA	1
C2-5	Rehvac Cylinder, 2.5#	EA	1
C5	Rehvac 5# Aluminum Cylinder	EA	1

BRUSHES

Chip Brushes

100% pure bristle, wood handle. Poly sleeve over bristles. Inexpensive (use once and throw away). Excellent for applying duct adhesive.



CATALOG NO.	DESCRIPTION	UOM	ORDER MULTIPLE
B-501	Chip Brush – 1”	EA	36
B-502	Chip Brush – 1-1/2”	EA	36
B-503	Chip Brush – 2”	EA	24
B-504	Chip Brush – 2-1/2”	EA	12
B-505	Chip Brush – 3”	EA	12

Welder’s Brush

Stainless steel bristles used for cleaning all metals. Great for cleaning aluminum prior to soldering.

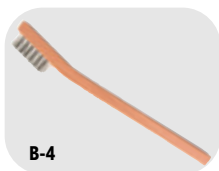

CATALOG NO.	DESCRIPTION	UOM	ORDER MULTIPLE
B-4	Welder’s Brush	EA	12

Parts Cleaning Brush

The heavy duty black polypropylene bristles are secured in a strong plastic handle.



CATALOG NO.	DESCRIPTION	UOM	ORDER MULTIPLE
542-25015	Parts Cleaning Brush	EA	12

2-in-1 Copper Tube Cleaning Brush

Easy to hold combination tool that really works. One end cleans the fitting. The other cleans the tube.



CATALOG NO.	DESCRIPTION	UOM	ORDER MULTIPLE
B-998	2-in-1 Copper Tube Cleaning Brush – 3/4” ID (7/8” OD)	EA	1

Tin Handle Acid Brushes

Manufactured with electrolyte tin plate and filled with 100% pure stiff horsehair, tied with a steel staple. This combination gives lasting qualities when used with heat and acids or other cleaning agents.

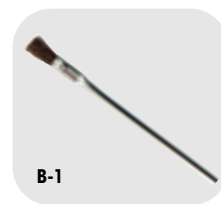

CATALOG NO.	DESCRIPTION	UOM	ORDER MULTIPLE
B-1	Tin Handle Acid Brush 3/8”	EA	144
B-2	Tin Handle Acid Brush 1/2”	EA	144

Refrigerator Coil Brush

Clean refrigerator coils, fan blades and areas under and behind appliances. 27-1/2” in length with 11-3/4” brush length. Bristles are 3/4” on the end tapering to 1-1/2” toward the handle.



CATALOG NO.	DESCRIPTION	UOM	ORDER MULTIPLE
B-27	Refrigerator Coil Brush	EA	1

Duct Cleaning Brush

These brushes are made of black fiber bristles twisted in wire. They are 1 1/8in. diameter by 7in. brush x 48in. overall length. These are idea for cleaning hard to reach areas in duct work.



CATALOG NO.	DESCRIPTION	UOM	ORDER MULTIPLE
542-76220	Duct Cleaning Brush	EA	1

BRUSHES cont'd

Copper Tube Fitting Brushes

Highest quality brushes to clean fittings faster, easier and more safely. Made with strong, resilient, rustproof stainless steel bristles secured in a 4-ply wire with easy-to-grip plastic handle. Economy models feature same quality stainless steel, but secured in 2-ply wire.



CATALOG NO.	DESCRIPTION	UOM	ORDER MULTIPLE
B-124	Copper Tube Fitting Brush – Economy 1/4" O.D., 9/32" Brush Dia.	EA	6
B-125	Copper Tube Fitting Brush – Economy 3/8" O.D., 13/32" Brush Dia.	EA	6
B-126	Copper Tube Fitting Brush – Economy 1/2" O.D., 17/32" Brush Dia.	EA	6
B-127	Copper Tube Fitting Brush – Economy 5/8" O.D., 11/16" Brush Dia.	EA	6
B-128	Copper Tube Fitting Brush – Economy 3/4" O.D., 13/16" Brush Dia.	EA	6
B-129	Copper Tube Fitting Brush – Economy 7/8" O.D., 15/16" Brush Dia.	EA	6
B-131	Copper Tube Fitting Brush – Economy 1-1/8" O.D., 1-1/4" Brush Dia.	EA	6
B-132	Copper Tube Fitting Brush – Economy 1-3/8" O.D., 1-1/2" Brush Dia.	EA	6
B-924	Copper Tube Fitting Brush – 1/4" O.D., 9/32" Brush Dia.	EA	1
B-925	Copper Tube Fitting Brush – 3/8" O.D., 13/32" Brush Dia.	EA	1
B-926	Copper Tube Fitting Brush – 1/2" O.D., 17/32" Brush Dia.	EA	1
B-927	Copper Tube Fitting Brush – 5/8" O.D., 11/16" Brush Dia.	EA	1
B-928	Copper Tube Fitting Brush – 3/4" O.D., 13/16" Brush Dia.	EA	1
B-929	Copper Tube Fitting Brush – 7/8" O.D., 15/16" Brush Dia.	EA	1
B-930	Copper Tube Fitting Brush – 1" O.D., 1-1/8" Brush Dia.	EA	1
B-931	Copper Tube Fitting Brush – 1-1/8" O.D., 1-1/4" Brush Dia.	EA	1
B-932	Copper Tube Fitting Brush – 1-3/8" O.D., 1-1/2" Brush Dia.	EA	1
B-934	Copper Tube Fitting Brush – 1-5/8" O.D., 1-3/4" Brush Dia.	EA	1
B-935	Copper Tube Fitting Brush – 2-1/8" O.D., 2-1/4" Brush Dia.	EA	1

Carbon Steel Curved Handle Scratch Brush

Carbon Steel Curved Handle Scratch Brushes are used for general purpose cleaning.



CATALOG NO.	DESCRIPTION	UOM	ORDER MULTIPLE
B-10	Carbon Steel Curved Handle Scratch Brush	EA	1

Fin Whisk

A plastic handled whisk for cleaning condenser and evaporator fins.



CATALOG NO.	DESCRIPTION	UOM	ORDER MULTIPLE
B-26	Fin Whisk Brush	EA	12

Condenser/Heat Exchanger Brushes

Ideal for cleaning mineral deposits from inside metal tubes. Especially recommended for use with power tools, although handle for manual use is available.

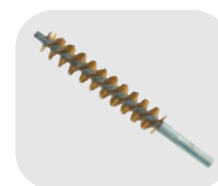

CATALOG NO.	DESCRIPTION	UOM	ORDER MULTIPLE
B-622	Condenser/Heat Exchanger Brush – 3/4" Brass 12-24 Female	EA	1

CHANNELLOCK® PRODUCTS

Tongue and Groove Pliers

These patented design pliers have permalock fasteners and reinforcing edge. The grips are also dipped in plastic for a more comfortable hold.



CATALOG NO.	DESCRIPTION	UOM	ORDER MULTIPLE
545-420	9-1/2" Tongue and Groove Pliers	EA	1
545-422	9-1/2" Curved Jaw Tongue and Groove Pliers	EA	1
545-426	6-1/2" Tongue and Groove Pliers	EA	1

CATALOG NO.	DESCRIPTION	UOM	ORDER MULTIPLE
545-430	10" Tongue and Groove Pliers	EA	1
545-440	12" Tongue and Groove Pliers	EA	1
545-442	12" Curved Jaw Tongue and Groove Pliers	EA	1
545-460	16" Tongue and Groove Pliers	EA	1

ELECTRICAL SUPPLIES

Outdoor Extension Cord

Heavy duty, round, vinyl extension cord designed for industrial use. Orange vinyl jacket protects against oil, grease, ozone, and gives added flexibility at below freezing temperatures. Vinyl plugs and connectors are molded on and won't break or pull off cord.



CATALOG NO.	DESCRIPTION	UOM	ORDER MULTIPLE
7-ECC12100	100' Extension Cord, 12/3 SJTW-A, 15 AMP	EA	3
7-ECC1225	25' Extension Cord, 12/3 SJTW-A, 15 AMP	EA	10
7-ECC1250	50' Extension Cord, 12/3 SJTW-A, 15 AMP	EA	6
7-ECC16100	100' 13 Amp Extension Cord SJTW-A 16/3	EA	6
7-ECC1625	25' 15 Amp Extension Cord SJTW-A 16/3	EA	24
7-ECC1650	50' 15 Amp Extension Cord SJTW-A 16/3	EA	12
7-ECC50725	25' 15 AMP Extension Cord SJTW-A 14/3	EA	14
7-ECC50730	50' 15 AMP Extension Cord SJTW-A 14/3	EA	10
7-ECC50735	100' 13 AMP Extension Cord SJTW-A 14/3	EA	5

Type: SJTW-A U.L. Listed, meets OSHA Requirements.

Power Blocks

Professional design gives contractors and industrial personnel maximum flexibility in arranging portable power needs at the job site. Vinyl connectors are solid molded for high resistance to breakage and abuse.

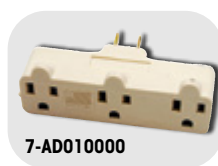

CATALOG NO.	DESCRIPTION	UOM	ORDER MULTIPLE
7-ADO10000	Triple tap power block adapter converts single 15 AMP 125V U-ground outlet to 3 15A, 125V U-ground outlets	EA	10

Metal Guard Trouble Lights

Designed for rugged use by contractors and industrial. Tough plastic handles are heat and shock resistant, with switch and 15A, 125V grounding side outlet.



CATALOG NO.	DESCRIPTION	UOM	ORDER MULTIPLE
7-TLC10625	25' Metal Guard Trouble Light	EA	1
7-TLC10630	50' Metal Guard Trouble Light	EA	1

AWG: 16/3 TYPE: SJTW-A U.L. Listed, meets OSHA Requirements.

Cable Clamp PRO

The Cable Clamp PRO is the ultimate reusable cable management tool. Featuring a unique push button release and integrally attached carry handle serrated for easy grip. Carry handle also includes built-in lanyard hole allowing for attachment of rope, wire, or hook. Lanyard hole may be used for tethering of Cable Clamp PRO to cords, cable, and other devices. The medium size is for bundles up to 2-inch and the large size is for bundles up to 3-inch.



CATALOG NO.	DESCRIPTION	UOM	ORDER MULTIPLE
CCP-M	Cable Clamp PRO Display Box with 34 Medium	EA	34
CCP-L	Cable Clamp PRO Display Box with 24 Large	EA	25

FIN TOOLS

Multi-Head Fin-Tool

Conveniently straightens and cleans condenser and evaporator fins. Each nylon head slides into the master handle and tightens in place. Heads are designed to fit units with fin spacing of 4–24 fins per inch. Each head is engraved with its own size and is color coded for fast identification. Heads are angled so that when inserted in the handle, the hand is a safe distance from the sharp fins. Heads may also be reversed in the handle so that combing with an upward stroke (recommended method) may be done easily with proper leverage. The master handle rests comfortably in a man size grip, is rigid and long-lasting.

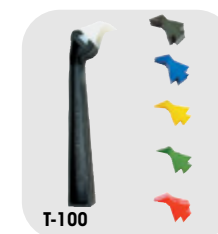

CATALOG NO.	DESCRIPTION	UOM	ORDER MULTIPLE
T-10	Head 10 FPI – Natural, pack of 3	PK	1
T-11	Head 11 FPI – Blue, pack of 3	PK	1
T-12	Head 12 FPI – Green, pack of 3	PK	1
T-13	Head 13 FPI – Pink, pack of 3	PK	1
T-14	Head 14 FPI – Lt. Green, pack of 3	PK	1
T-20	Head 20 FPI – Purple, pack of 3	PK	1
T-21	Head 21 & 22 FPI – Rose (for Carrier unit), pack of 3	PK	1
T-100	T-8, T-9, T-10, T-11, T-12, T-14 (1 handle & 6 heads)	PK	1

U.S. Patent No. 4,018,076.

FIN TOOLS cont'd

SuperComb

Easier to grip, easier to use tool for straightening condenser and evaporator fins. Straightens 50% more fins in one stroke. Keeps hands a safe distance from fins. Easy to grip, strong, durable, heavy duty nylon. Color coded for easy identification. Sold individually or 6 per set. Sales display available.



T-409

CATALOG NO.	DESCRIPTION	UOM	ORDER MULTIPLE
T-400	Set of 6 – 1 Ea.: T-408, T-409, T-411, T-410, T-417, T-418	EA	1

WORKLIGHTS BY CLIPLIGHT®

Clipstrip™ / Clipstrip 2™

Clipstrip™ is a powerful pocket light with 140 lumens and includes a pivoting magnetic clip. It is available in yellow or camo with three AAA batteries included.



CATALOG NO.	DESCRIPTION	UOM	ORDER MULTIPLE
111112	Clipstrip™ Pocket Light	EA	12
111116	Clipstrip™ Pocket Camo Light	EA	12
111118	Clipstrip 2™ Pocket Light	EA	9

PIVOT™

The PIVOT™ is a light that has a 360° swivel hook with 240 lumens and magnetic base and back. Three AA batteries included.



CATALOG NO.	DESCRIPTION	UOM	ORDER MULTIPLE
111114	PIVOT™ Pivoting Work Light	EA	9

PIVOT™ 33

The Pivot™ 33 is a light that has a 360° swivel hook with 160 lumens and magnetic back and pivoting base. Lights on front and top with three AA batteries included. Available in yellow or camo.



CATALOG NO.	DESCRIPTION	UOM	ORDER MULTIPLE
24-458	PIVOT™ 33 Work Light	EA	9
24-460	PIVOT™ 33 Work Light, Camo	EA	9

Clipstrip™ Aqua

Clipstrip™ Aqua is a waterproof light with 180 lumens and includes a magnetic clip and floats. It is available in yellow and comes with a rechargeable 2200 mAh lithium-ion battery. Sold individually.



CATALOG NO.	DESCRIPTION	UOM	ORDER MULTIPLE
111113	Clipstrip™ Aqua Light	EA	1

PIVOT™ mini

The PIVOT™ mini is a light that has a 360° swivel hook with 120 lumens and magnetic back and base. Lights on front and top with three AAA batteries included. Available in yellow or camo.



CATALOG NO.	DESCRIPTION	UOM	ORDER MULTIPLE
111115	PIVOT™ mini Pivoting Work Light	EA	12
111117	PIVOT™ mini Pivoting Work Light, Camo	EA	12

PIVOT™ Tough-Light

The PIVOT™ Tough Light has 150 lumens with a hanging hook and magnetic base. It also has 180 degree pivoting capability with three AAA batteries included.



CATALOG NO.	DESCRIPTION	UOM	ORDER MULTIPLE
111123	PIVOT™ Tough-Light Work Light	EA	8

WORKLIGHTS BY CLIPLIGHT® cont'd

Clip-On Zoom Light

The Clip-On Zoom Light provides 150 lumens, 90° pivoting capability coupled with the ability to zoom from broad to narrow. It includes a magnetic base and includes three AAA batteries.



CATALOG NO.	DESCRIPTION	UOM	ORDER MULTIPLE
111128	Clip-On Zoom Worklight	EA	8

Cliplight Extends

The Cliplight Extends has 120 lumens at the top and 140 lumens in the front with a pivoting head. The light comes with a telescopic system and magnetic base. Four AAA batteries included.



CATALOG NO.	DESCRIPTION	UOM	ORDER MULTIPLE
111130	Cliplight Extends Worklight	EA	8

HEMImini™

The HEMImini™ has up to 1000 lumens of power (4 hours - full power) with a 4400 mAh lithium-ion rechargeable battery. It includes a 180 degree swivel hook with an optional magnetic cover.



CATALOG NO.	DESCRIPTION	UOM	ORDER MULTIPLE
114301	HEMImini™ Work Light	EA	1
410239	Magnetic Cover for HEMImini™ Work Light	EA	1

HEMIPLUS™ 2

The HEMIPLUS™ 2 has up to 1200 lumens of power (4 hours - full power) with a 4400 mAh lithium-ion rechargeable battery. It includes a metal hook and removable magnetic cover.



CATALOG NO.	DESCRIPTION	UOM	ORDER MULTIPLE
114302	HEMIPLUS™ 2 Work Light	EA	1

Spotlight

The Spotlight is a cordless work light solution with up to 1200 lumens of power (3 hours - full power) with a 4000 mAh lithium-ion rechargeable battery. It includes two adjustable joints on magnetic stand for different angles. It has three power modes including a dimmer.



CATALOG NO.	DESCRIPTION	UOM	ORDER MULTIPLE
111121	Spotlight Cordless Work Light	EA	1

Curve Light

The Curve Light provides 300 lumens of lighting using chip-on board technology. Designed with a curved shape to protect the lens and rubber bumper for durability. It is rugged yet sleek. A hanging hook, magnetic base and three AA batteries are included.

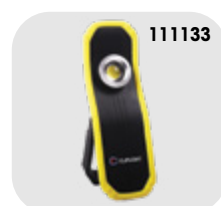

CATALOG NO.	DESCRIPTION	UOM	ORDER MULTIPLE
111133	Curve Heavy Duty Work Light	EA	6

Flex Light

The Flex Light provides 120 lumens of lighting for tight spaces with the ability to bend 90 degrees backwards and forwards. Designed with flexibility in mind, this light comes with a magnetic base and three AAA batteries.



CATALOG NO.	DESCRIPTION	UOM	ORDER MULTIPLE
111131	Flex Pocket Work Light	EA	8

GAUGES

Manifold Gauge

DiversiTech's MG-1 Manifold Gauge provides the technician with a precision diagnostic and monitoring analog gauge set complete with hoses.

The Manifold Gauge and Hose Set includes:

- 2 valve brass manifold
- 5' long high pressure hose set
- For use with the following refrigerants:
 - R-410A
 - R-22
 - R-407C
- Detailed gauge readings in PSI°F

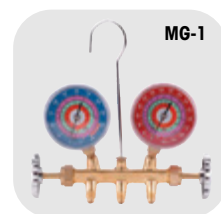

CATALOG NO.	DESCRIPTION	UOM	ORDER MULTIPLE
MG-1	Manifold Gauge and Hose Set	EA	1
MG-RGB	Replacement Gauge – blue	EA	1
MG-RGR	Replacement Gauge – red	EA	1

MANOMETERS, PRESSURE AND TEST KITS

Hydrogauge Manometer

Economical Pressure measurements.

- Replaces ordinary U-tube manometers
 - Measures gas pressure easily and efficiently
 - Direct reading, no plus or minus readings to add together as in old fashioned U-tubes
 - Fills like a glass of water, no more air bubbles
 - Strong magnet for mounting
 - Heavy-duty construction
 - Made of industrial grade, flexible PVC plastic
 - Lightweight; Easy to use
 - 6-HG15 water column height: 15"
 - Plastic: 30" to 36" of industrial grade flexible plastic
 - Hose fitting: All brass
- Includes: Mounting magnet.

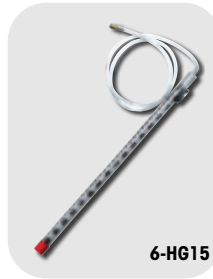

6-HG15

CATALOG NO.	DESCRIPTION	UOM	ORDER MULTIPLE
6-HG15	Hydrogauge Manometer	EA	1

Gas Pressure Test Kit

Rugged, Heavy Duty Field Use.

- Measure Natural gas (methane) or LP gas pressure across appliance manifolds.
 - Test gas stoves, furnaces, dryers and other gas appliances. Can also be used for other non-corrosive gases.
 - Large 2" sensitive diaphragm gauge is calibrated in inches of water column, also shows ounces per square inch
 - Magnified lens
 - Easier to use than a manometer
 - Range: 0 to 35 inches of water column (in. H₂O) 0 to 20 ounces per square inch (oz./in²)
- Includes: 2" sensitive diaphragm gauge; 3' of rubber tubing; brass fitting for quick connection to the appliance manifold 3/8" NPT; molded hard case.



6-GPK035

CATALOG NO.	DESCRIPTION	UOM	ORDER MULTIPLE
6-GPK035	Gas Pressure Test Kit	EA	1

STAPLES AND STAPLE GUNS

T-50 Series Staples and Staple Guns

The #1 selling staple gun in the world! Used extensively by building contractors, home do-it-yourselfers and specialty trade applications for tacking insulation, ceiling tile, window screening, cornerite, and 1001 other jobs ranging from light to heavy duty work. The T-50 Outward Clinch Staple Gun is ideal for fiberglass ductwork.

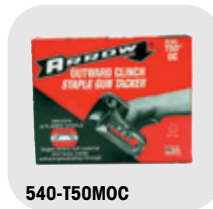

540-T50MOC



CATALOG NO.	DESCRIPTION	UOM	ORDER MULTIPLE
540-506	3/8" Leg Staples for T50 Staple Guns (1,250)	EA	4
540-508	1/2" Leg Staples for T50 Staple Guns (1,250)	EA	4
540-509	9/16" Leg Staples for T50 Staple Guns (1,250)	EA	4
540-T50M	T50M Heavy Duty Staple Gun Tacker	EA	1
540-T50MOC	T50MOC Outward Clinch Staple Gun	EA	1

MISCELLANEOUS TOOLS

Compressor TOTE

Makes light work of a heavy job. Powder coated, strong steel construction. Recommended for use with all compressors up to 5 tons. Compatible with high efficiency compressors. Pick up a compressor from its box. Carry a compressor up a ladder. Now with black protective finish.



ACT-6

CATALOG NO.	DESCRIPTION	UOM	ORDER MULTIPLE
ACT-6	Compressor Tote	EA	6

4-Piece Hook and Pick Set

For separating wires, removing small fuses, "O" rings, retrieving washers and loose parts too small to pick up with your fingers. Bright-dipped, anodized hex-shaped aluminum handles with powerful magnet on end. Handy screw-in hook, pick, point and scribe. High carbon polished needle steel. All in a compact zip-lock vinyl pouch that fits in your shirt pocket! Set includes four screw-in tips plus handle.



MHP-4

CATALOG NO.	DESCRIPTION	UOM	ORDER MULTIPLE
MHP-4	4-Piece Hook and Pick Set	EA	1

MONITORS

007 Control Checker

A lifetime tool for monitoring and checking safety controls and operating controls. One unit for all voltages 24-460 VAC or DC without switching dials or meters. Compact, 4 oz, reliable. Saves troubleshooting. For normally closed controls, 007 connects in parallel with safety control. When the safety control opens in response to a problem in the system, 007 red LED turns on and remains on until reset manually. With intermittent problem, the LED remains on indicating the control is open. For operating controls, 007 verifies the status of all types indicating if there is power to the holding coil, the NC contact is open or closed, the thermostat contacts are open or closed, there is power to the contactor or starting holding coil, the overloads are open or closed, or there is a bad connection either on control or power side. NOTE: May use with lockout relays. Features battery check and reset switch. Includes 9-volt battery. 007 may be used over and over.



TC-007

CATALOG NO.	DESCRIPTION	UOM	ORDER MULTIPLE
TC-007	007 Control Checker	EA	1

U.S. Pat. No. 4,092,625.

Tattle-Tale Control Monitor

Identifies open controls in seconds. A single use monitoring device for determining which safety control has opened in response to a malfunction. Saves wasted hours tracing a safety control shutdown, even if intermittent. A quick, inexpensive way to visually spot where the problem is. Simply install in parallel with each safety control. When a control opens, the red indicator flag pops up. You will know immediately which area of the system is experiencing problems. Disposable, safe, simple to use, and pocket sized. Monitors safety controls, fuses, overload relays, motor protectors, freeze controls, limit controls, safety switches, fusible links, or steam control. CAUTION: Not to be used with lockout relays, use TC-007.



TT-24

CATALOG NO.	DESCRIPTION	UOM	ORDER MULTIPLE
TT-120	Tattle-Tale Control Monitor - 120 Volt AC or DC, pack of 3	PK	1
TT-24	Tattle-Tale Control Monitor - 24 Volt AC or DC, pack of 3	PK	1
TT-240	Tattle-Tale Control Monitor - 240 Volt AC or DC, pack of 3	PK	1

Tolerance on all voltages shown is ± 20%. U.S. Pat. No. 4,250,480.

REFRACTOMETERS

Refractometer

The Refractometer can measure the freezing point of coolants, glycol and the Charge Condition of Batteries.



6-REF401

CATALOG NO.	DESCRIPTION	UOM	ORDER MULTIPLE
6-REF401	Refractometer	EA	1

SPIN TOOLS

SPIN Tools

SPIN® Flaring and Swaging bits deliver the best flares and swages in seconds! Gives you consistent sizes on flares and swages, every time. Using an innovative technology, SPIN® tools are designed to quickly flare or swage virtually any copper or aluminum tube. Perfect for mini splits and ductless A/C copper and aluminum tubes, it keeps the tubing thickness for high pressure refrigerant fluids such as R410A, R22, etc. Available in sets from 4 up to 6 pieces for HVAC/R applications; and 3 pieces for plumbing applications.



F1034

FLARING

CATALOG NO.	DESCRIPTION	UOM	ORDER MULTIPLE
F4000	4 pc Flaring Set - 1/4", 3/8", 1/2", 5/8"	PK	1
F5000	5 pc Flaring Set - 1/4", 3/8", 1/2", 5/8", 3/4"	PK	1
F6000	6 pc Flaring Set - 1/4", 3/8", 1/2", 5/8", 3/4", 7/8"	EA	1
F1014	Flaring Tool, 1/4", Individual	EA	1
F1516	Flaring Tool, 5/16", Individual	EA	1
F1038	Flaring Tool, 3/8", Individual	EA	1
F1012	Flaring Tool, 1/2", Individual	EA	1
F1058	Flaring Tool, 5/8", Individual	EA	1
F1034	Flaring Tool, 3/4", Individual	EA	1
F1078	Flaring Tool, 7/8", Individual	EA	1
F1100	Flaring Tool, 1", Individual	EA	1

SWAGING

CATALOG NO.	DESCRIPTION	UOM	ORDER MULTIPLE
S4000	4 pc Swaging Set - 1/4", 3/8", 1/2", 5/8"	PK	1
S5000	5 pc Swaging Set - 1/4", 3/8", 1/2", 5/8", 3/4"	PK	1
S6000	6 pc Swaging Set - 1/4", 3/8", 1/2", 5/8", 3/4", 7/8"	PK	1
S1014	Swaging Tool - 1/4", Individual	EA	1
S1516	Swaging Tool - 5/16", Individual	EA	1
S1038	Swaging Tool - 3/8", Individual	EA	1
S1012	Swaging Tool - 1/2", Individual	EA	1
S1058	Swaging Tool - 5/8", Individual	EA	1
S1034	Swaging Tool - 3/4", Individual	EA	1
S1078	Swaging Tool - 7/8", Individual	EA	1

PLUMBING

CATALOG NO.	DESCRIPTION	UOM	ORDER MULTIPLE
P3000	3 pc Plumbing Set - 1/2", 3/4", 1"	EA	1

SAWS AND SAW BLADES

Deluxe Hi-Tension Hacksaw

Hackframe featuring handle and end pieces made of die cast aluminum. Lightweight yet rigid and highly tensioned (up to 25,000 psi) for cleaner, surer cut. Permanent blade pins feature versatile angling (up to 55°) for flush cutting. Blade can be inserted in handle to be used as compass saw. Frame will fit most standard tool boxes.



CATALOG NO.	DESCRIPTION	UOM	ORDER MULTIPLE
540-278BM0024	Replacement Blades for Hacksaw Frame 12" x 24T	EA	10
540-278HX0002	Hacksaw Frame with Blade	EA	1

Bi-Metal Reciprocating Saw Blades

Premium high speed steel with a flexible alloy back. Bi-metal blades fit all reciprocating saws with 1/2" shank.



CATALOG NO.	DESCRIPTION	UOM	ORDER MULTIPLE
540-RBCCRf	Cast Iron-Ceramic Tile Carbide Grit 8" Long	EA	1
540-RB125W	12" x 6T Wood and Nail 3/4" x 12" x .050	EA	5
540-RB414M	4" x 14T Short Metal Cutting 3/4" x 4" x .035	EA	5
540-RB418M	4" x 18T Short Metal Cutting 5/8" x 4" x .035	EA	5
540-RB610HDM	6" x 10T HD Metal Cutting 3/4" x 6" x .035	EA	5
540-RB614HDM	6" x 14T HD Metal Cutting 3/4" x 6" x .035	EA	5
540-RB618HDM	6" x 18T HD Metal Cutting 3/4" x 6" x .035	EA	5
540-RB624HDM	6" x 24T HD Metal Cutting 3/4" x 6" x .035	EA	5
540-RB636DW	Drywall Cutting with V Head 5/8" x 6" x .035	EA	5
540-RB636W	6" x 6T Wood and Nail Slope 3/4" x 6" x .050	EA	5
540-RB656WS	6" x 6T Wood and Nail Scroll 3/4" x 6" x .050	EA	5
540-RB810HDM	8" x 10T HD Metal Cutting 3/4" x 8" x .035	EA	5
540-RB814HDM	8" x 14T HD Metal Cutting 3/4" x 8" x .035	EA	5
540-RB956W	9" x 6T Wood and Nail 3/4" x 9" x .050	EA	5

SCREWDRIVERS, DRIVER SETS

Pocket 4-in-1 Mini Screwdriver

This screwdriver set is ideal for technicians, hobbyists, and do it yourselfers. There are 2 double-ended vanadium blades. You can change blades instantly and the blades are held in the carrier handled. The dimensions are 1/16 in. and 1/8 in. slotted tips and #1 and #00 cross point. The Mini Screwdriver comes in with a convenient pocket clip and capped ends.



CATALOG NO.	DESCRIPTION	UOM	ORDER MULTIPLE
6-T744	Pocket 4-in-1 Mini Screwdriver – Length: 5-1/8" (130mm)	EA	1

Combination Screwdrivers

Multiple bits in one handy screwdriver. No need for a toolbox for those quick jobs. Lifetime guarantee.



CATALOG NO.	DESCRIPTION	UOM	ORDER MULTIPLE
5-41	4-in-1 with #1 and #2 Phillips, 3/16" and 5/16" Slotted	EA	12
5-61	6-in-1 with #1 and #2 Phillips, 3/16" and 5/16" Slotted 1/4" Nut Driver, and 5/16" Nut Driver	EA	12

SNIPS, NOTCHERS, CRIMPERS, SEAMERS

Aviation Snips

Moly alloy tool steel blade is hot drop-forged and scientifically heat-treated to provide a strong, longer lasting cutting edge. Durable serrated blades are designed to grip the metal for cutting ease. The patent pending spring on these snips is guaranteed to last for the life of the tool. Will cut 18 gauge cold-rolled steel.



CATALOG NO.	DESCRIPTION	UOM	ORDER MULTIPLE
540-6716B	Aviation Snip – Bulldog Notching Snip – Blue Handle	EA	6
540-6716L	Aviation Snip – Cuts Left – Red Handle	EA	6
540-6716R	Aviation Snip – Cuts Right – Green Handle	EA	6
540-6716S	Aviation Snip – Cuts Straight – Yellow Handle	EA	6

HVAC Tools

Hot drop-forged carbon steel blades. Compound leverage action handles. Heavy duty plastic grips.



CATALOG NO.	DESCRIPTION	UOM	ORDER MULTIPLE
540-FCTMC5	8" Crimper – 22 Ga. Crimping Capacity	EA	1
540-FCTMN1	8" Notcher – 31° Cutting Angle	EA	1
540-FCTMS1	3" Straight Seamer – 22 Ga. Capacity	EA	1
540-FCTMS2	3" Offset Seamer – 22 Ga. Capacity	EA	1

Offset Snips

The same high quality construction as the Aviation Snips with an additional advantage – the Offset Snips allow your hand to stay above metal for cutting ease and comfort.



CATALOG NO.	DESCRIPTION	UOM	ORDER MULTIPLE
540-6510L	Offset Snip – Cuts Left – Red Handle	EA	6
540-6510R	Offset Snip – Cuts Right – Green Handle	EA	6

Upright Snips

This snip significantly improves sheet metal cutting. The ergonomic design allows for easier cutting in tight places, improved safety by elevating hands above metal working surfaces, and increases wrist range motion.



CATALOG NO.	DESCRIPTION	UOM	ORDER MULTIPLE
540-6900L	Upright Snips – Left-handed Model	EA	6
540-6900R	Upright Snips – Right-handed Model	EA	6

STRAPS, TRUCK ROPE

Truck Rope

All-purpose high strength polypropylene truck rope is C.H.P. approved.



CATALOG NO.	DESCRIPTION	UOM	ORDER MULTIPLE
25001	Truck Rope – 3/8" x 50'	EA	1
CR070	Truck Rope – 3/8" x 50' (Yellow)	EA	1

Lashing Strap

Quickly lashes and secures refrigerators, air conditioners, washers, driers, etc. Strong nylon webbing rated at 3000 lbs. and end hooks at 1200 lbs. tensile strength. Hand loop for easy tightening. Steel cam lever buckle is easy to adjust and releases quickly. Secures a maximum load of 1000 pounds. 12' long.



CATALOG NO.	DESCRIPTION	UOM	ORDER MULTIPLE
HS-144	Lashing Strap – 144"	EA	6

STRAPS, TRUCK ROPE cont'd

Ratchet Strap

Easy ratcheting permits tie-down of appliances securely. An innovative latch and a fast release cam reduces socket wear. Cadmium-plated steel buckle has a positive lock that eliminates release due to vibration. When closed, the handle locks the latch into the sprocket to prevent inadvertent release. 16' nylon webbing rated at 3000 PSI tensile. Vinyl coated end hooks rated at 1200 PSI tensile.



HS-192

CATALOG NO.	DESCRIPTION	UOM	ORDER MULTIPLE
HS-192	Ratchet Strap – 16'	EA	3

Hanging Strap

Strong, versatile, easy way to secure loose gear safely. Tie down ladders, tubing, cylinders or almost anything in seconds. Cannot snap back. Strong, durable 1" polypropylene webbing. Reinforced grommet lets you hang it up, tie it up, hook it up or attach it permanently. Spring loaded adjustable buckle. Easy to get firm tension with no slipping. Make an endless length by connecting 2 or more together.



HS-30

CATALOG NO.	DESCRIPTION	UOM	ORDER MULTIPLE
HS-30	Hanging Strap – 31"	EA	24
HS-30-2	Hanging Strap – 31", 2 Straps per Card, pack of 12	PK	1
HS-60	Hanging Strap – 60"	EA	24
HS-60-2	Hanging Strap – 60", 2 Straps per Card, pack of 12	PK	1

Rubber Tie Down Strap

Can stretch to double its length. Quickly ties down ladders, tubing, cylinders or almost anything. Extra heavy steel "S" hooks on each end. Resists cracking and deterioration.



RS-15

CATALOG NO.	DESCRIPTION	UOM	ORDER MULTIPLE
RS-9	Rubber Tie Down Strap – 10"	EA	10
RS-15	Rubber Tie Down Strap – 15"	EA	10
RS-20	Rubber Tie Down Strap – 20"	EA	10
RS-31	Rubber Tie Down Strap – 31"	EA	10
RS-41	Rubber Tie Down Strap – 41"	EA	10

Carabiners

Carabiners come in a 2 piece package and are made of 8 mm anodized aluminum. Great for attaching ropes and clipping to tool belts. For indoor or outdoor use – work or leisure. Various colors.



540-CARABINER

CATALOG NO.	DESCRIPTION	UOM	ORDER MULTIPLE
540-CARABINER	Carabiner Clip, pack of 2	PK	1

TEST LEADS

Test Leads

Alligator clips are covered by pure vinyl boots for flexibility at any temperature without cracking.



FTL3

CATALOG NO.	DESCRIPTION	UOM	ORDER MULTIPLE
ACK4	2 Red and 2 Black Boots w/4 Alligator Clips	EA	1
FTL3	Pair, Red and Black – 36"	EA	1
FTL3D	Pair, Red and Black – Super Heavy Duty – 36"	EA	1

Multi Color Test Leads

Easy to use multi-colored test leads. 5 colors (white, red, black, yellow, green) with 2 connections each for easy testing on the job. Wire is 18 gauge, 18" long.



CT800

CATALOG NO.	DESCRIPTION	UOM	ORDER MULTIPLE
CT800	Multi Color Test Leads	EA	1

Magjumper

Magjumper from DiversiTech is a magnetic jumper for low voltage troubleshooting. It features a 20" length with magnetic tips that won't pop off like alligator clips sometimes can. It stays flexible even in cold weather and is perfect for recessed terminals. Magjumper is ideal for use on control boards, zone panels, thermostats, hydronics and automation controllers.



MAG-1

CATALOG NO.	DESCRIPTION	UOM	ORDER MULTIPLE
MAG-1	Magjumper Terminal Kit	EA	1

TESTERS

Test Cord (Female)

Heavy duty red and black boots are on this cord. The cord has large clips, 3 wires, and is 24in. With this cord, you can get power in remote areas without an 110V outlet. The voltage is 3 to 20 V and has 125 AMPs. The wire gauge is 16 and the weight is .36 lb.



CATALOG NO.	DESCRIPTION	UOM	ORDER MULTIPLE
6-CT700F	Test Cord (Female)	EA	1

Leak Test Gauge

This Gas gauge test is ideal for teasing all new installations of or leaks and passing inspection code. The special sensitive diaphragm gauges for more accurate low pressure readings.



CATALOG NO.	DESCRIPTION	UOM	ORDER MULTIPLE
TG-05	Leak Test Gauge – 3/4" FPT., 15 psi	EA	1
TG-30-12	Leak Test Gauge – 1/2" FPT. Conn., 30 psi	EA	1
TG-30	Leak Test Gauge – 3/4" FPT. Conn., 30 psi	EA	1
TG-30-1	Leak Test Gauge – 1" FPT. Conn., 30 psi	EA	1

THERMOMETERS/PROBES

Digital Thermometer

Temperature range from -40°F to 230°F. Packaged on attractive display card.



CATALOG NO.	DESCRIPTION	UOM	ORDER MULTIPLE
541-300	Digital Thermometer	EA	1

Horizontal Refrigerator/Freezer Analog Thermometer

With this analog thermometer, you can use it either hanging or free standing. The easy to ready display can be seen with a horizontal reading. Both F and C scales are reflected on the thermometer and the range is -40° to 80°F (-40° to 27°C).



CATALOG NO.	DESCRIPTION	UOM	ORDER MULTIPLE
6-FT80H	Horizontal Refrigerator/Freezer Analog Thermometer	EA	1

Deluxe Digital Pocket Thermometer

Deluxe Digital Pocket Thermometers are water and drop resistant and have a rugged construction. There is an auto power off and an F/C Switch. The probe is 2.5 in. and the range is from -40 degrees F to 300 degrees F or -40 degrees C to 150 degrees C. This thermometer comes with a protective cover with clip.



CATALOG NO.	DESCRIPTION	UOM	ORDER MULTIPLE
6-HDT304K	Deluxe Digital Pocket Thermometer	EA	1

Analog Pocket Thermometer with Magnifying Lens

- Range 6-320: -40° to 160°F
 - Range 6-321: -0° to 220°F
 - Rugged stainless steel probe
- Includes: Protective sheath with pocket clip.

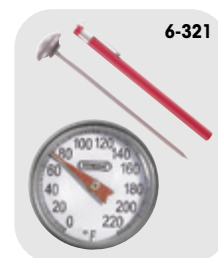

CATALOG NO.	DESCRIPTION	UOM	ORDER MULTIPLE
6-321	Analog Pocket Thermometer: Range -0° to 220°F	EA	1

Refrigerator/Freezer Analog Thermometer

This analog thermometer is stainless steel and can be used either hanging or free standing. The easy to read round dial is in F only. There are temperature indicators with a range -20° to 80°F (-29° to 27°C)



CATALOG NO.	DESCRIPTION	UOM	ORDER MULTIPLE
6-FT80R	Refrigerator/Freezer Analog Thermometer	EA	1

TUBE WORKING TOOLS

Kut-All Plastic Tube and Hose Cutter

Tough, durable nylon. Blade closes into its own handle for safe handling. Replaceable high carbon, teflon coated steel blades. Ideal for cutting up to 1-1/8" I.D. plastic tubing, reinforced plastic tubing, rigid plastic pipe, and rubber hose.



CATALOG NO.	DESCRIPTION	UOM	ORDER MULTIPLE
PK-2	Kut-All Plastic Tube and Hose Cutter	EA	1

Swivel Head Deburring Tool

This Swivel head Deburring Tool has the professional quality and the performance of a higher price deburring tool without the price tag. This product has two interchangeable blades.



CATALOG NO.	DESCRIPTION	UOM	ORDER MULTIPLE
6-T482	Handle length: 5-1/8" (130mm)	EA	1

One-Handed PVC/Hose Cutter

The ratchet system holds the blade in place while you adjust your grip to increase the pressure. The high carbon steel blade maintains sharpness and resists chipping. These cutters can be used for cutting PVC, CPVC, Polyethylene, PEX, and ABS tubing. The cutters have a quick-blade reset and can be used as a one handed operation. With the handle locking strap for safe storage, the easy replacing blade feature, and the ergonomically designed handle, these cutters are a perfect addition to any tool box.



CATALOG NO.	DESCRIPTION	UOM	ORDER MULTIPLE
6-T1191	Capacity: 1/8" to 1-5/8"; Length: 8-1/4" (210mm)	EA	1

WELDING TORCHES, SUPPLIES

Heat Resistant Cloth

This flame barrier drop cloth withstands temperatures to 3,000°F. No asbestos. Protects walls, floors, equipment, components and adjacent surfaces from torch flames when soldering, brazing or welding. All cloths have edges taped and sewn with grommets at each corner. Highly resistant to many chemicals and acids.

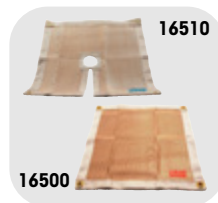

CATALOG NO.	DESCRIPTION	UOM	ORDER MULTIPLE
16500	18" x 18" Plain	EA	1
16510	18" x 18" Keyhole w/cutout for draping over pipes/tubes	EA	1
16520	36" x 36" Plain	EA	1

Map-Pro and Propane Gas

Map-Pro and Propane Gas are tanks that can be used to weld products.



CATALOG NO.	DESCRIPTION	UOM	ORDER MULTIPLE
525-MT1	Map-Pro Gas – 14 oz.	EA	12
525-PT1	Propane Gas – 14.1 oz.	EA	12

Portable Hand Torch

Self igniting hand torch eliminates the need for a flint lighter. Lightweight and portable, this flame tool can be operated with Propane or MAP-Pro™ (Propylene). Features trigger lock with instant safety release, full size comfort grip and 360° swivel tip. Operates in any position, even upside down. Includes swirl combustion tip end.



CATALOG NO.	DESCRIPTION	UOM	ORDER MULTIPLE
525-TORCH	Portable Hand Torch	EA	1

PLUMBING

CPVC-CTS Pipe and Fittings.....	132
Nylon Fittings	132-133
Oatey® Products	134
PVC Condensate Pipe	136
PVC DWV Fittings	136
PVC Primer and Cement	135
PVC Schedule 40 Pressure Fittings	137-139
Supports	140
Tubing, Clamps, and Kits	140



CPVC-CTS PIPE AND FITTINGS

CPVC-CTS Pipe by FlowGuard® Gold™

CTS = Copper Tube Size

CATALOG NO.	DESCRIPTION	UOM	ORDER MULTIPLE
4700-12	1/2" x 10' CPVC Pipe, 500'	EA	500'
4700-34	3/4" x 10' CPVC Pipe, 250'	EA	250'



4700-12

CPVC-CTS Fittings by FlowGuard® Gold™

CTS = Copper Tube Size

CATALOG NO.	DESCRIPTION	UOM	ORDER MULTIPLE
4701-12	1/2" Coupling S x S	EA	20
4704-12	1/2" Adapter M x S	EA	20
4707-12	1/2" 90° Elbow S x S	EA	20
4711-12	1/2" Tee S x S x S	EA	20
47072-12	1/2" 90° Street Ell S x S	EA	10
4718-12	3/4" x 1/2" CPVC Bushing	EA	10
4701-34	3/4" Coupling S x S	EA	20
4703-34	3/4" Adapter F x S	EA	25
4704-34	3/4" Adapter M x S	EA	10
4706-34	3/4" 45° Elbow S x S	EA	20
4707-34	3/4" 90° Elbow S x S	EA	20
4711-34	3/4" Tee S x S x S	EA	20
47072-34	3/4" 90° Street Ell S x S	EA	10



4703-34

NYLON FITTINGS*

Male Adapter (Barb x MIPT)



701-001

CATALOG NO.	DESCRIPTION	UOM	ORDER MULTIPLE
701-001	Adapter – 1/2" Barb x 1/2" MIPT, pack of 2	PK	1
701-002	Adapter – 1/2" Barb x 3/4" MIPT, pack of 2	PK	1
701-003	Adapter – 1/2" Barb x 3/8" MIPT, pack of 2	PK	1
701-007	Adapter – 3/4" Barb x 3/4" MIPT, pack of 2	PK	1
701-012	Adapter – 3/8" Barb x 1/2" MIPT, pack of 2	PK	1
701-013	Adapter – 3/8" Barb x 3/8" MIPT, pack of 2	PK	1
701-014	Adapter – 5/8" Barb x 3/4" MIPT, pack of 2	PK	1
701-043	Adapter – 3/8" Barb x 3/4" MIPT, pack of 2	PK	1

Female Adapter (Barb x FIPT)



701-006

CATALOG NO.	DESCRIPTION	UOM	ORDER MULTIPLE
701-006	Adapter – 3/4" Barb x 3/4" NPT, pack of 2	PK	1
701-041	Adapter – 1/2" Barb x 1/2" NPT, pack of 2	PK	1

Bushing (MIPT x FIPT)



701-015

CATALOG NO.	DESCRIPTION	UOM	ORDER MULTIPLE
701-015	Bushing – 1" MIPT x 3/4" FIPT, pack of 2	PK	1
701-017	Bushing – 3/4" MIPT x 1/2" FIPT, pack of 2	PK	1

Garden Hose Adapters



701-009

CATALOG NO.	DESCRIPTION	UOM	ORDER MULTIPLE
701-009	Adapter – 3/4" MGHT x 3/4" FIPT, pack of 2 PK	1	
701-011	Adapter – 3/4" MIPT x 3/4" FGHT, pack of 2 PK	1	

*All fittings packaged with identification. To order nylon fittings in bulk, enter catalog number followed by the letter "B." For example, 701-001B is the bulk part number for 701-001. Bulk sold in packs of 100.

Elbow (Barb x Barb)



CATALOG NO.	DESCRIPTION	UOM	ORDER MULTIPLE
701-018	Elbow – 1/2" Barb, pack of 2	PK	1
701-023	Elbow – 3/4" Barb, pack of 2	PK	1
701-040	Elbow – 5/8" Barb, pack of 2	PK	1
701-046	Elbow – 3/8" Barb, pack of 2	PK	1

Male Adapter Elbow (Barb x MIPT)



CATALOG NO.	DESCRIPTION	UOM	ORDER MULTIPLE
701-020	Elbow – 1/2" Barb x 3/4" MIPT, pack of 2	PK	1
701-025	Elbow – 3/4" Barb x 3/4" MIPT, pack of 2	PK	1
701-028	Elbow – 5/8" Barb x 3/4" MIPT, pack of 2	PK	1

Tee (Barb x Barb x Barb)



CATALOG NO.	DESCRIPTION	UOM	ORDER MULTIPLE
701-034	Tee – 1/2" Barb, pack of 2	PK	1
701-035	Tee – 1/2" x 3/4" x 1/2" Barb, pack of 2	PK	1
701-037	Tee – 3/4" Barb, pack of 2	PK	1
701-038	Tee – 3/8" Barb, pack of 2	PK	1
701-039	Tee – 5/8" Barb, pack of 2	PK	1

Female Adapter Elbow (Barb x FIPT)



CATALOG NO.	DESCRIPTION	UOM	ORDER MULTIPLE
701-019	Elbow – 1/2" Barb x 3/4" NPT, pack of 2	PK	1

Hose Mender (Barb x Barb)



CATALOG NO.	DESCRIPTION	UOM	ORDER MULTIPLE
701-029	Hose Mender – 1/2" Barb, pack of 2	PK	1
701-030	Hose Mender – 1/4" Barb, pack of 2	PK	1
701-031	Hose Mender – 3/4" Barb, pack of 2	PK	1
701-032	Hose Mender – 3/8" Barb, pack of 2	PK	1
701-033	Hose Mender – 5/8" Barb, pack of 2	PK	1

*All fittings packaged with identification. To order nylon fittings in bulk, enter catalog number followed by the letter "B." For example, 701-001B is the bulk part number for 701-001. Bulk sold in packs of 100.

OATEY® PRODUCTS

PVC Cement – Clear

PVC Cement is clear. All cans have brush-top applicator.



5-12

CATALOG NO.	DESCRIPTION	UOM	ORDER MULTIPLE
5-14	Oatey #31012 – 1/4 Pint	EA	24
5-12	Oatey #31013 – 1/2 Pint	EA	24
5-10	Oatey #31014 – 1 Pint	EA	24
5-32	Oatey #31015 – 32 oz.	EA	12

Purple Primer for PVC Pipe and Fittings (Black Label)

Recommended for all PVC and CPVC installations – all sizes/schedules. Purple tinted primer formulated to remove surface dirt and grease as well as soften the pipe surface to allow for a fast, secure and permanent solvent weld. For use in areas where codes call for primer verification.



530-30756

CATALOG NO.	DESCRIPTION	UOM	ORDER MULTIPLE
530-30755	Purple Primer – 4 oz.	EA	24
530-30756	Purple Primer – 8 oz.	EA	24
530-30757	Purple Primer – 16 oz.	EA	24

NSF and UPC listed. Exceeds ASTM F-656.

Heavy Duty PVC Cement

Heavy bodied clear cement recommended for use on PVC pipe and fittings up to 12" in diameter for Sch. 40 and Sch. 80 potable water pressure pipe, gas, conduit, drain waste and vent pipe. Exceeds ASTM D-2564.



530-30863

CATALOG NO.	DESCRIPTION	UOM	ORDER MULTIPLE
530-30850	Heavy Duty Cement – 4 oz.	EA	24
530-30863	Heavy Duty Cement – 8 oz.	EA	24
530-30876	Heavy Duty Cement – 16 oz.	EA	24

Rain-R-Shine Blue Cement

Medium bodied blue colored cement for PVC pipe and fittings up to 6 inches in diameter. A very fast setting cement formulated for wet conditions and/or when quick pressurization and fast installation is needed. Exceeds ASTM D-2564.



530-30891

CATALOG NO.	DESCRIPTION	UOM	ORDER MULTIPLE
530-30890	Rain-R-Shine Cement – 4 oz.	EA	24
530-30891	Rain-R-Shine Cement – 8 oz.	EA	24
530-30893	Rain-R-Shine Cement – 16 oz.	EA	24

Medium Orange CPVC Cement

Medium Orange CPVC Cement is formulated for use on all schedules and classes of CPVC pipe and fittings up to 6" diameter with interference fit.



530-11029

CATALOG NO.	DESCRIPTION	UOM	ORDER MULTIPLE
530-11029	Medium Orange CPVC Cement – 4 oz.	EA	24

PVC Primer – Clear

Recommended for all PVC and CPVC applications. Can be used on all sizes and schedules. Formulated to remove all surface dirt, grease, and grime as well as soften the pipe in preparation for solvent cement. This primer can be used when you want a cleaner installation. Meets ASTM F-656 and is NSF listed.



530-30752

CATALOG NO.	DESCRIPTION	UOM	ORDER MULTIPLE
530-30752	PVC Primer – Clear – 16 oz.	EA	24

All-Purpose Clear Cement for ABS, PVC and CPVC Pipe and Fittings

Heavy-bodied clear cement recommended for use on ABS, PVC, and CPVC pipe and fittings up to 12" in diameter. Flows freely and provides a thick layer of cement on the pipe. Apply at temperatures 40° to 90°F.



530-30821

CATALOG NO.	DESCRIPTION	UOM	ORDER MULTIPLE
530-30818	Clear Cement – 4 oz.	EA	24
530-30821	Clear Cement – 8 oz.	EA	24
530-30834	Clear Cement – 16 oz.	EA	24

PVC Gray Cement for High Efficiency Furnaces, Vent and Make-Up Air

Medium-bodied gray colored cement for use on Sch. 40 conduit, drain waste, and vent pipe. Flows freely and covers with a thicker layer than regular PVC. Can be applied at temperatures 40° to 100°F.



530-30884

CATALOG NO.	DESCRIPTION	UOM	ORDER MULTIPLE
530-30884	Gray Cement – 8 oz.	EA	24
530-30885	Gray Cement – 16 oz.	EA	24

NSF and UPC listed. Exceeds ASTM D-2564.

All Weather PVC Cement

Medium bodied cement for PVC pipe and fittings up to 6". Formulated for fast initial set-up from -15°F to 100°F. Exceeds ASTM D-2564.



530-31132

CATALOG NO.	DESCRIPTION	UOM	ORDER MULTIPLE
530-31132	All Weather Cement – 16 oz.	EA	24

Clear Cleaner

Clear Cleaner is a simple and effective cleaner formulated for ABS, PVC and CPVC pipe and fittings that flows freely and evaporates quickly.



530-10202

CATALOG NO.	DESCRIPTION	UOM	ORDER MULTIPLE
530-10202	Clear Cleaner – 16 oz.	EA	24
530-10203	Clear Cleaner – 8 oz.	EA	24

PVC PRIMER AND CEMENT

Pro-Weld™ PVC Cement (Regular Body)

Pro-Weld™ PVC Cement is a clear, regular bodied solvent cement designed to be used on Type I and II PVC pipe and fittings up to and including 4 inch diameter. Pro-Weld™ meets ASTM Standard D-2564.

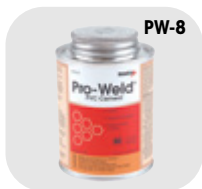

PW-8

CATALOG NO.	DESCRIPTION	UOM	ORDER MULTIPLE
PW-4	Pro-Weld™ – 4 oz. Brush-Top Container – Regular Body	EA	24
PW-8	Pro-Weld™ – 8 oz. Brush-Top Container – Regular Body	EA	24
PW-16	Pro-Weld™ – 16 oz. Brush-Top Container – Regular Body	EA	24
PW-32	Pro-Weld™ – 32 oz. Brush-Top Container – Regular Body	EA	12

Pro-Weld™ PVC Cement (Heavy Body)

Pro-Weld™ Heavy Body is a clear, heavy bodied, very high strength industrial grade PVC cement. It has a medium setting time and works with all rigid schedule 40 and 80 pipe diameters up to 12 inches. Complies with ASTM D2564 and NSF.



PWH-8

CATALOG NO.	DESCRIPTION	UOM	ORDER MULTIPLE
PWH-4	Pro-Weld™ – 4 oz. Brush-Top Container – Heavy Body	EA	24
PWH-8	Pro-Weld™ – 8 oz. Brush-Top Container – Heavy Body	EA	24
PWH-16	Pro-Weld™ – 16 oz. Brush-Top Container – Heavy Body	EA	24

Pro-Weld™ PVC Cement (Pool and Turf – Blue)

Pro-Weld™ Blue Pool and Turf is a blue colored, medium bodied, high strength PVC cement for welding rigid or flexible PVC in wet conditions where the system needs to be pressurized quickly. Pro-Weld Blue Pool and Turf sets up very fast and works with all rigid and flexible schedule 40 and 80 pipe diameters up to 6 inches. Complies with ASTM D2564 and NSF.

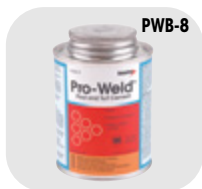

PWB-8

CATALOG NO.	DESCRIPTION	UOM	ORDER MULTIPLE
PWB-4	Pro-Weld™ – 4 oz. Brush-Top Container – Pool and Turf – Blue	EA	24
PWB-8	Pro-Weld™ – 8 oz. Brush-Top Container – Pool and Turf – Blue	EA	24
PWB-16	Pro-Weld™ – 16 oz. Brush-Top Container – Pool and Turf – Blue	EA	24

Un-Purple Primer

Hercules® Un-Purple Primer is formulated for use on all schedules and classes of PVC pipe and fittings. It appears clear, but shows purple under UV light. It makes every installation clean and look professional.



530-60445

CATALOG NO.	DESCRIPTION	UOM	ORDER MULTIPLE
530-60445	Hercules® Un-Purple Primer, 16 oz.	EA	1

Pro-Weld™ PVC Cement (Universal – PVC/ABS/CPVC)

Pro-Weld™ Universal Cement is a clear, medium bodied, high strength cement for use on PVC to PVC, CPVC to CPVC, and ABS to ABS connections. Pro-Weld Universal sets up fast and works with all rigid schedule 40 and 80 piping up to 6 inches in diameter. Complies with ASTM D2564, D2235, and F493.

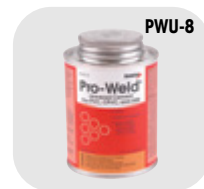

PWU-8

CATALOG NO.	DESCRIPTION	UOM	ORDER MULTIPLE
PWU-4	Pro-Weld™ – 4 oz. Brush-Top Container – Universal – PVC/ABS/CPVC	EA	24
PWU-8	Pro-Weld™ – 8 oz. Brush-Top Container – Universal – PVC/ABS/CPVC	EA	24
PWU-16	Pro-Weld™ – 16 oz. Brush-Top Container – Universal – PVC/ABS/CPVC	EA	24

Pro-Prime™ PVC Primer (Purple)

A purple-tinted primer formulated to remove dirt and oil from the surface of Type I and II PVC piping, as well as soften the piping in preparation for solvent welding. Pro-Prime™ contains purple pigment which provides verification that the primer has been applied to the pipe surface. Pro-Prime™ meets ASTM Standard F-656.



PP-8

CATALOG NO.	DESCRIPTION	UOM	ORDER MULTIPLE
PP-4	Pro-Prime™ – 4 oz. Brush-Top Container	EA	24
PP-8	Pro-Prime™ – 8 oz. Brush-Top Container	EA	24
PP-16	Pro-Prime™ – 16 oz. Brush-Top Container	EA	24
PP-32	Pro-Prime™ – 32 oz. Can	EA	12

Pro-Prime™ Clear PVC Primer

Clear primer that removes dirt and oil from the surface of Type I and II PVC piping. Softens the piping to prepare for solvent welding. Pro-Prime Clear primer meets ASTM Standard F-656.



PPC-8

CATALOG NO.	DESCRIPTION	UOM	ORDER MULTIPLE
PPC-4	Pro-Prime™ Clear – 4 oz. Brush-Top Container	EA	24
PPC-8	Pro-Prime™ Clear – 8 oz. Brush-Top Container	EA	24
PPC-16	Pro-Prime™ Clear – 16 oz. Brush-Top Container	EA	24

Pro-Weld™ Weather-ALL

Pro-Weld™ PVC Cement is a clear, regular bodied solvent cement designed to be used on Type I and II PVC pipe and fittings up to and including 4 inch diameter. Pro-Weld™ meets ASTM Standard D-2564 and is usable in cold weather to -15°F and hot weather to 110°F.



PWW-8

CATALOG NO.	DESCRIPTION	UOM	ORDER MULTIPLE
PWW-4	Pro-Weld™ – 4 oz. Brush-Top Container – All Weather Regular Body	EA	24
PWW-8	Pro-Weld™ – 8 oz. Brush-Top Container – All Weather Regular Body	EA	24
PWW-16	Pro-Weld™ – 16 oz. Brush-Top Container – All Weather Regular Body	EA	24

PVC CONDENSATE PIPE

Polyvinyl Chloride, White PVC 1120



CATALOG NO.	DESCRIPTION	UOM	ORDER MULTIPLE
5-2002	3/4" PVC – PSI 200 – 10' Straight End	EA	500'
5-2005	3/4" PVC – PSI 200 – 20' Belled End	EA	500'
5-407	3/4" PVC – Sch. 40 – 20' Belled End	EA	500'
5-404	2" PVC – Sch.40/DWW,ASTM 2665 – 10' Straight End	EA	100'
5-405	3" PVC – Sch.40/DWW,ASTM 2665 – 10' Straight End	EA	50'
5-416	1" PVC – Sch. 40 – 20' Belled End	EA	200'
5-417	1-1/4" PVC – Sch. 40 – 20' Belled End	EA	200'
5-418	1-1/2" PVC – Sch. 40 – 20' Belled End	EA	200'

PVC DWV FITTINGS

Couplings (Hub x Hub)



CATALOG NO.	DESCRIPTION	UOM	ORDER MULTIPLE
5-100020	2" Couplings (Hub x Hub)	EA	100
5-100030	3" Couplings (Hub x Hub)	EA	60
510-D102338	3" x 2" Couplings (Hub x Hub)	EA	20

90 Elbow (Hub x Hub)



CATALOG NO.	DESCRIPTION	UOM	ORDER MULTIPLE
5-300020	2" 90 Elbow (Hub x Hub)	EA	50
5-300030	3" 90 Elbow (Hub x Hub)	EA	25
510-D304020	2" Long Sweep 90 Elbow (Hub x Hub)	EA	25
510-D304030	3" Long Sweep 90 Elbow (Hub x Hub)	EA	10

45 Elbows



CATALOG NO.	DESCRIPTION	UOM	ORDER MULTIPLE
5-321020	2" 45 Elbow (Hub x Hub)	EA	50
5-321030	3" 45 Elbow (Hub x Hub)	EA	20
510-D323020	2" 45 Street Elbow (Hub x SPIG)	EA	50
510-D323030	3" 45 Street Elbow (Hub x SPIG)	EA	20

DWV Bend Fittings



CATALOG NO.	DESCRIPTION	UOM	ORDER MULTIPLE
510-D309020	2" Long Sweep (Hub x SPIG)	EA	25
510-D309030	3" Long Sweep (Hub x SPIG)	EA	20

DWV Vent Tee



CATALOG NO.	DESCRIPTION	UOM	ORDER MULTIPLE
510-D441020	2" Vent Tee	EA	25

DWV Bushings



CATALOG NO.	DESCRIPTION	UOM	ORDER MULTIPLE
510-437338	3" x 2" Reducing Bushing (SPIG x SLIP)	EA	10
510-438338	3" x 2" Bushing (SPIG x FIPT)	EA	10

PVC SCHEDULE 40 PRESSURE FITTINGS

Tee (Slip x Slip x Slip)



CATALOG NO.	DESCRIPTION	UOM	ORDER MULTIPLE
5-401005	1/2" Tee	EA	50
5-401007	3/4" Tee	EA	50
5-401010	1" Tee	EA	50
5-401020	2" Tee	EA	25
5-401030	3" Tee	EA	10

Tee (Slip x FIPT x Slip)



CATALOG NO.	DESCRIPTION	UOM	ORDER MULTIPLE
5-402007	3/4" Tee (S x S x FIPT)	EA	50

90 Ell (Slip x Slip)

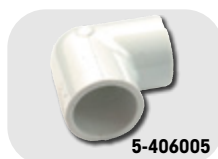

CATALOG NO.	DESCRIPTION	UOM	ORDER MULTIPLE
5-406005	1/2" 90 Ell	EA	50
5-406007	3/4" 90 Ell	EA	50
5-406010	1" 90 Ell	EA	50
5-406020	2" 90 Ell	EA	25
5-406030	3" 90 Ell	EA	10

Traps

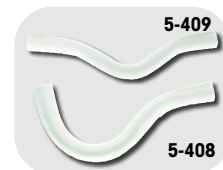

CATALOG NO.	DESCRIPTION	UOM	ORDER MULTIPLE
5-408	3/4" "P" Trap	EA	100
5-409	3/4" Running Trap	EA	100
5-410	3/4" Mini "P" Trap	EA	100
5-411	1" "P" Trap	EA	50
5-412	1/2" "P" Trap	EA	100
5-414	3/4" "J" Trap	EA	100

90 Ell (Slip x FIPT)



CATALOG NO.	DESCRIPTION	UOM	ORDER MULTIPLE
5-407005	1/2" 90 Ell	EA	50
5-407007	3/4" 90 Ell	EA	50

90 Ell Reducing (Slip x FIPT)



CATALOG NO.	DESCRIPTION	UOM	ORDER MULTIPLE
5-407131	1" x 3/4" 90 Ell Reducing	EA	50

90 Street Ell (SPIG x Slip)



CATALOG NO.	DESCRIPTION	UOM	ORDER MULTIPLE
5-409005	1/2" 90 Street Ell	EA	50
5-409007	3/4" 90 Street Ell	EA	50
5-409010	1" 90 Street Ell	EA	50

45 Ell (Slip x Slip)



CATALOG NO.	DESCRIPTION	UOM	ORDER MULTIPLE
5-417005	1/2" 45 Ell	EA	50
5-417007	3/4" 45 Ell	EA	50
5-417010	1" 45 Ell	EA	50
5-417012	1-1/4" 45 Ell	EA	25
5-417020	2" 45 Ell	EA	25
5-417030	3" 45 Ell	EA	10

PVC SCHEDULE 40 PRESSURE FITTINGS cont'd

Plug (Slip)



CATALOG NO.	DESCRIPTION	UOM	ORDER MULTIPLE
5-449007	3/4" Plug	EA	50
5-449030	3" Plug	EA	10

90 Street Ell (MIPT x Slip)



CATALOG NO.	DESCRIPTION	UOM	ORDER MULTIPLE
5-410005	1/2" 90 Street Ell	EA	50
5-410007	3/4" 90 Street Ell	EA	50
5-410010	1" 90 Street Ell	EA	50

Female Adapter (Slip x FIPT)



CATALOG NO.	DESCRIPTION	UOM	ORDER MULTIPLE
5-435005	1/2" Female Adapter	EA	100
5-435007	3/4" Female Adapter	EA	50
5-435010	1" Female Adapter	EA	50

Female Adapter Reducing (Slip x FIPT)



CATALOG NO.	DESCRIPTION	UOM	ORDER MULTIPLE
5-435101	3/4" x 1/2" Female Adapter Reducing	EA	50
5-435102	3/4" x 1" Female Adapter Reducing	EA	50

Coupling (Slip x Slip)



CATALOG NO.	DESCRIPTION	UOM	ORDER MULTIPLE
5-429005	1/2" Coupling	EA	100
5-429007	3/4" Coupling	EA	50
5-429010	1" Coupling	EA	50
5-429015	1-1/2" Coupling	EA	25
5-429020	2" Coupling	EA	25
5-429030	3" Coupling	EA	10

Cap (Slip)



CATALOG NO.	DESCRIPTION	UOM	ORDER MULTIPLE
5-447007	3/4" Cap	EA	100
5-447010	1" Cap	EA	100

Male Adapter (MIPT x Slip)



CATALOG NO.	DESCRIPTION	UOM	ORDER MULTIPLE
5-436005	1/2" Male Adapter	EA	100
5-436007	3/4" Male Adapter	EA	50
5-436010	1" Male Adapter	EA	50

Plug (MIPT)



CATALOG NO.	DESCRIPTION	UOM	ORDER MULTIPLE
5-450007	3/4" Plug	EA	50

Male Adapter Reducing (MIPT x Slip)



CATALOG NO.	DESCRIPTION	UOM	ORDER MULTIPLE
5-436074	1/2" x 3/4" Male Adapter Reducing	EA	50
5-436101	3/4" x 1/2" Male Adapter Reducing	EA	50
5-436102	3/4" x 1" Male Adapter Reducing	EA	50
5-436131	1" x 3/4" Male Adapter Reducing	EA	50

Reducer Bushing (SPIG x Slip)



CATALOG NO.	DESCRIPTION	UOM	ORDER MULTIPLE
5-437101	3/4" x 1/2" Reducer Bushing	EA	100
5-437130	1" x 1/2" Reducer Bushing	EA	100
5-437131	1" x 3/4" Reducer Bushing	EA	100
5-437210	1-1/2" x 3/4" Reducer Bushing	EA	25

Reducer Bushing (SPIG X FIPT)



CATALOG NO.	DESCRIPTION	UOM	ORDER MULTIPLE
5-438101	3/4" x 1/2" Reducer Bushing	EA	100
5-438131	1" x 3/4" Reducer Bushing	EA	100

Cap (FIPT)



CATALOG NO.	DESCRIPTION	UOM	ORDER MULTIPLE
5-448007	3/4" Cap	EA	100

Adapter (Insert x Slip)



CATALOG NO.	DESCRIPTION	UOM	ORDER MULTIPLE
5-474007	3/4" Adapter (Insert x Slip)	EA	50

Clean Out Tee



CATALOG NO.	DESCRIPTION	UOM	ORDER MULTIPLE
510-3400-10	3/4" Clean Out Tee	EA	10
510-3400	3/4" Clean Out Tee	EA	50

SUPPORTS

Plastic DWV J-Hooks



515-J2000

CATALOG NO.	DESCRIPTION	UOM	ORDER MULTIPLE
515-J2000	2" x 9" DWV Swiveling J-Hook	EA	25
515-J3000	3" x 7-1/2" DWV Swiveling J-Hook	EA	25

TUBING, CLAMPS, AND KITS

Polyethylene Tubing

F.D.A. approved, flexible, non-toxic tubing. Tasteless and odorless, lightweight, low density. Ideal for drinking water lines, evaporative coolers, and radiant heating.



PE-104

CATALOG NO.	DESCRIPTION	UOM	ORDER MULTIPLE
PE-104	Polyethylene Tubing - 1 1/64ID, 1/4OD, 100FT	EA	1
PE-012	Polyethylene Tubing - 3/8ID, 1/2OD, 100FT	EA	1
PE-014	Polyethylene Tubing - 1/8ID, 1/4OD, 100FT	EA	1
PE-038	Polyethylene Tubing - 1/4ID, 3/8 OD, 100FT	EA	1
PE-058	Polyethylene Tubing - 1/2ID, 5/8OD, 100FT	EA	1

Icemaker Kit

Supplies water to most refrigerators with automatic icemakers, humidifiers and evaporative coolers. Contains self-tapping valve and all necessary fittings.



750-402

CATALOG NO.	DESCRIPTION	UOM	ORDER MULTIPLE
750-401	Icemaker Kit - Poly Tube - 25'	EA	1
750-402	Icemaker Kit - Copper - 25'	EA	1

Hose Clamps

Partial stainless, worm drive, adjustable. 300 series stainless steel 1/2" band with plated 5/16" slotted hex head screw and housing, except the B-4H which has a 5/16" band and 1/4" nut. Recommended for most applications. 100% interlock construction features one-piece housing which directly locks into band. Spot weld free design.

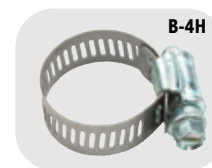

B-4H

CATALOG NO.	DESCRIPTION	UOM	ORDER MULTIPLE
B-4H	No. 4, 7/32" - 5/8" dia., 3/16" - 5/16" hose I.D.	EA	10
B-6H	No. 6, 7/16" - 25/32" dia., 1/4" - 3/8" hose I.D.	EA	10
B-8H	No. 8, 1/2" - 29/32" dia., 5/16" - 1/2" hose I.D.	EA	10
B-10H	No. 10, 9/16" - 1-1/16" dia., 3/8" - 5/8" hose I.D.	EA	10
B-12H	No. 12, 11/16" - 1-1/4" dia., 5/8" - 3/4" hose I.D.	EA	10
B-16H	No. 16, 13/16" - 1-1/2" dia., 3/4" - 1" hose I.D.	EA	10
B-20H	No. 20, 13/16" - 1-3/4" dia., 1" - 1-1/4" hose I.D.	EA	10
B-24H	No. 24, 1-1/16" - 2" dia., 1-1/4" - 1-1/2" hose I.D.	EA	10
B-28H	No. 28, 1-5/16" - 2-1/4" dia., 1-1/4" - 1-3/4" hose I.D.	EA	10
B-32H	No. 32, 1-9/16" - 2-1/2" dia., 1-1/2" - 2" hose I.D.	EA	10
B-36H	No. 36, 1-13/16" - 2-3/4" dia., 1-3/4" - 2-1/4" hose I.D.	EA	10
B-48H	No. 48, 2-9/16" - 3-1/2" dia., 1-3/4" - 2-1/4" hose I.D.	EA	10
B-72H	No. 72, 1-7/8" - 5" dia., 1-3/4" - 2-1/4" hose I.D.	EA	10

Self Tapping Water Valve

Installs on all copper tube lines from 3/8" O.D. to 1-1/8" O.D. without shutting off water. No drilling required. Features 1/4" compression fitting. Stainless steel piercing needle. Special molded gasket seals on both tubing and valve. Will not slip or turn on tubing.



QAV-2

CATALOG NO.	DESCRIPTION	UOM	ORDER MULTIPLE
QAV-2	Self Tapping Water Tap Valve	EA	1

DUCTLESS SYSTEMS

EasyGuard™ Fittings	149-150
EasyGuard™ Line Set Cover System	149
Lineset Cutting Tools	148
Roof Inlets.....	148
SpeediChannel™ Fittings	145-148
SpeediChannel™ Line Set Cover System	145

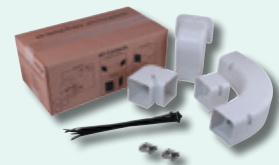

DiversiTech® SpeediChannel™ System

SIZING CHART AND SELECTION INFORMATION

Maximum Line Set, Drain Pipe, and Cable Capacity using 3/8" Insulation

Model	230-D3A, D3B, D3W	230-D4A, D4B, D4W	230-D6, D6W
Dimensions	3" x 2-1/2"	4" x 2-3/4"	6" x 3"
Length	78"	78"	78"

Mini-Split Systems – Liquid and Suction Line with 3/8" Insulation

Liquid Line	3/8"	2 x 1/4"	1 x 1/4" + 2 x 3/8"
Suction Line	5/8"	2 x 3/8"	1 x 1/2" + 2 x 5/8"
Drain Hose	3/4" OD	2 x 3/4" OD	3 x 3/4" OD
Power Cable	1 x UF 14-3	2 x 1/2" SealTite	3 x 1/2" SealTite
Control Cable	1 Pair 18 AWG	2 Pairs 18 AWG	3 Pairs 18 AWG
Nominal Tonnage	1–3 Tons	1x3 Ton or 2x1 Ton	1x3 Ton or 2x2 Ton

Conventional Split Systems – Liquid Line Plain, Suction Line with 3/8" Insulation

Liquid Line	3/8"	3/8"	3/8"
Suction Line	3/4" or 7/8"	1-1/8"	1-1/8"
Drain Hose	3/4" PVC	3/4" PVC	3/4" PVC
Power Cable	1 x UF 14-2	1 x 1/2" SealTite	1 x 1/2" SealTite
Control Cable	1 Pair 18 AWG	1 Pair 18 AWG	1 Pair 18 AWG
Nominal Tonnage	Up to 3.5 Tons	4–5 Tons	7.5 Tons and up

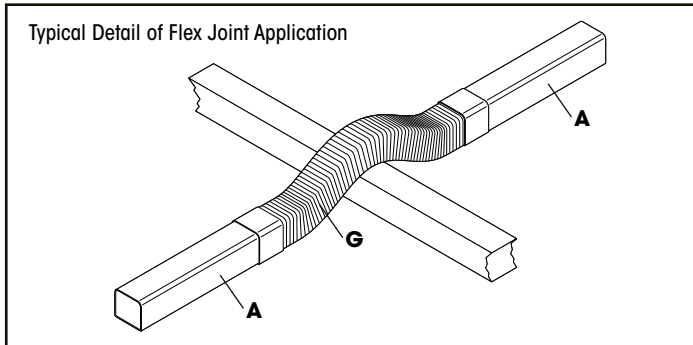
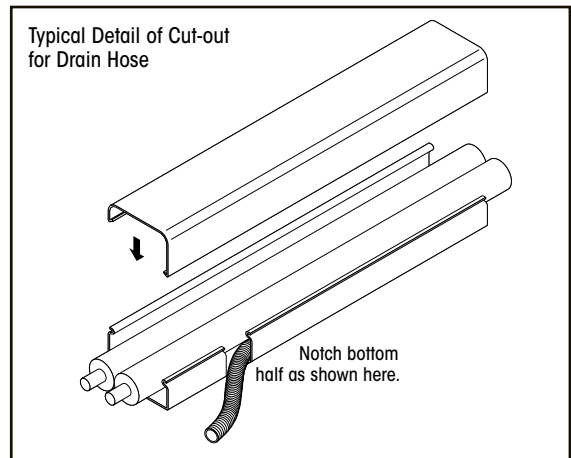
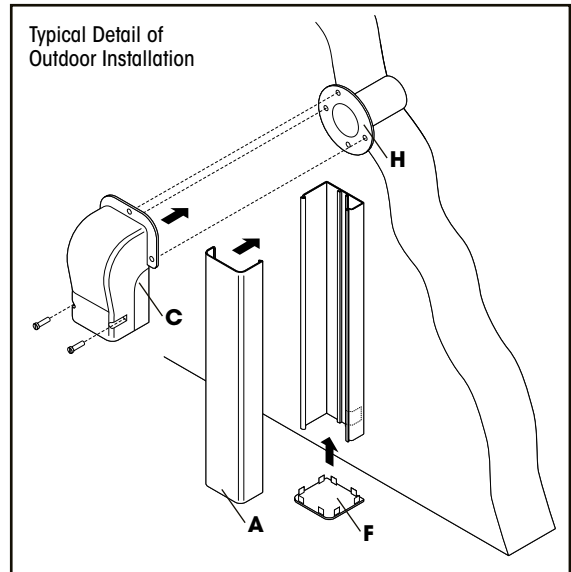
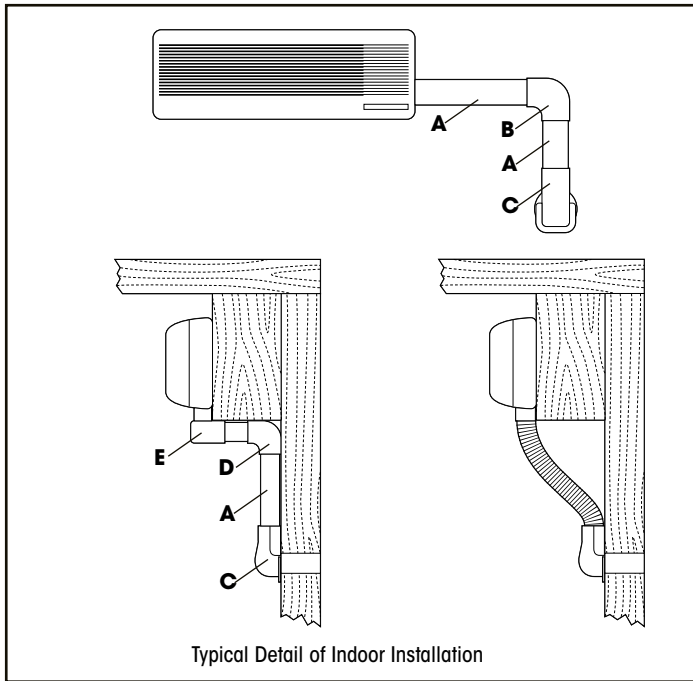

- A** -230-D
 - B** -230-FB
 - C** -230-WC
 - D** -230-EB
 - E** -230-EIN
 - F** -230-DC
 - G** -230-FJ
 - H** -230-WS2
- NOTE:
Suffix parts A-G
with the duct
size needed
(3,4, or 6)

DiversiTech® SpeediChannel™ System

TECHNICAL SPECIFICATIONS

Color	Natural, Brown or White in select 3" & 4" sizes			
Size	230-D3: 3" x 2-1/2" OD	230-D4: 4" x 2-3/4" OD	230-D6: 6" x 3-1/8" OD	Standard Length: 78"
Material	Weather Resistant PVC, UV Stabilized and Fire Resistant			
Temperature Range	Fire Rating Meets UL 94V-0			
Weather Resistance	Tested to over 2,000 hours			
Fixing Screws	Stainless Steel			

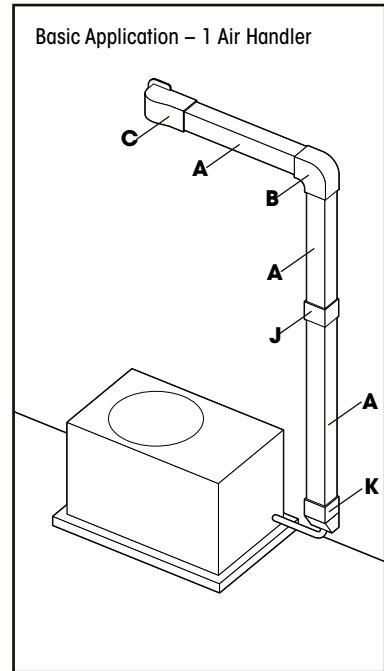
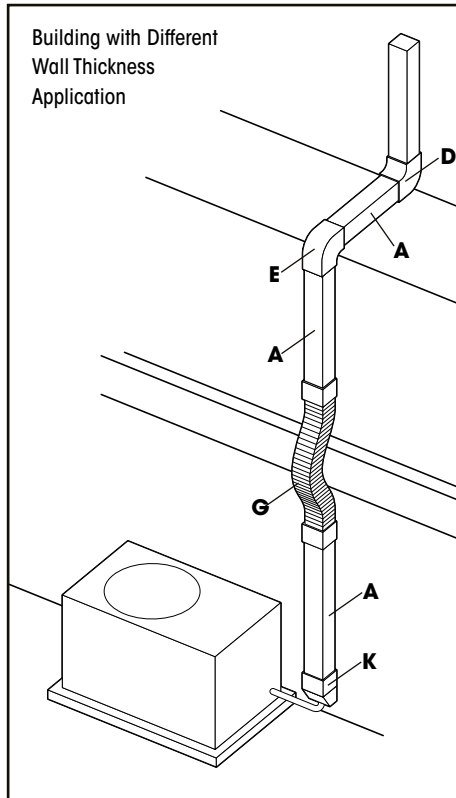
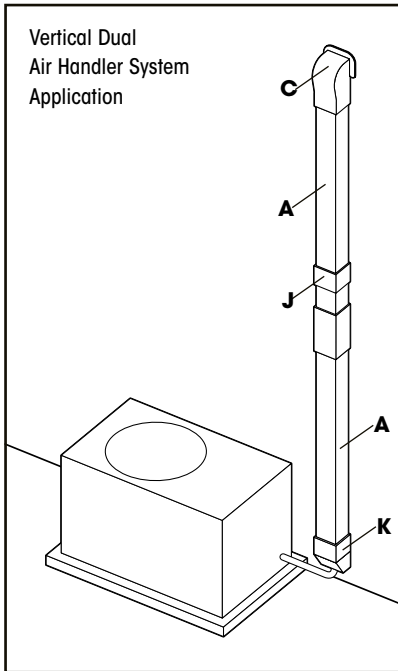
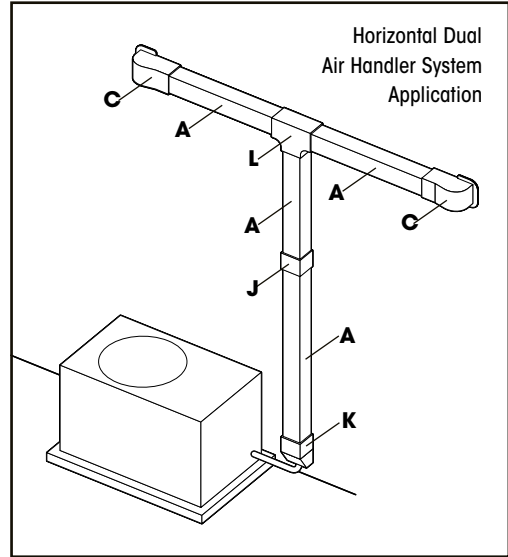
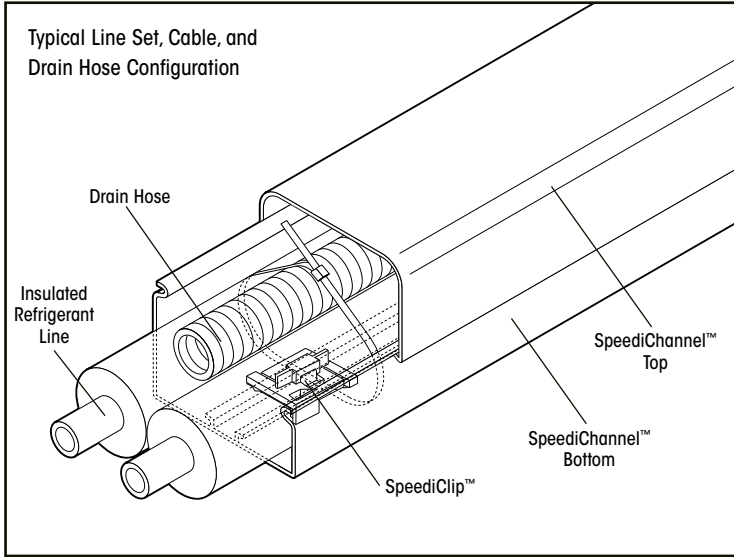

- A - 230-D
- B - 230-FB
- C - 230-WC
- D - 230-EB
- E - 230-EIN
- F - 230-DC
- G - 230-FJ
- H - 230-WS2
- J - 230-CP
- K - 230-DE
- L - 230-TC

NOTE:
Suffix parts A-G
with the duct
size needed
(3, 4, or 6)

SpeediChannel™ System Installation

Step 1

Attach the SpeediChannel™ base to the wall about every 15 inches with screws suitable for the wall construction (siding, stucco, brick, etc.). Screw through the center of the molded rail. Slide the connecting piece (elbow, union, tee, etc.) under the SpeediChannel™ before attaching the end of the channel to the wall. When cutting lengths of SpeediChannel™, allow 1/8" gap between the end of the SpeediChannel™ and the stop inside the fitting to allow for thermal expansion.



Step 4

Attach the SpeediChannel™ to the base.



Step 2

Attach one SpeediClip™ with cable tie about every 20 inches along the inside sliding rail.



Step 5

Attach the fitting covers with the screws provided.



Step 3

Install the line set, drain line, and wires inside the SpeediChannel™. Test the equipment installation prior to tightening the cable ties. Tighten the cable ties snug, but not so tight they damage the tubing insulation or kink the drain line. Trim excess length from the cable tie.



Step 6

When complete, paint the SpeediChannel™ to match surface of installation (if desired). Follow painting specifications as published.

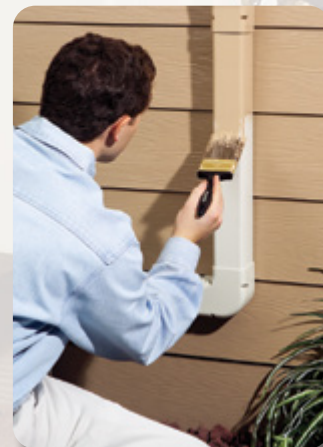

SPEEDICHANNEL™ LINE SET COVER SYSTEM

SpeediChannel™

The DiversiTech SpeediChannel™ is available in three widths, all in 6-1/2 feet lengths. Includes pack of SpeediClips™.

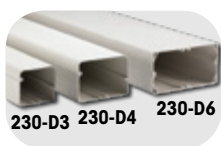

CATALOG NO.	DESCRIPTION	UOM	ORDER MULTIPLE
230-D3A	3" SpeediChannel™	EA	6
230-D3B	3" SpeediChannel™, Brown	EA	6
230-D3W	3" SpeediChannel™, White	EA	6
230-D4A	4" SpeediChannel™	EA	6
230-D4B	4" SpeediChannel™, Brown	EA	6
230-D4W	4" SpeediChannel™, White	EA	6
230-D6	6" SpeediChannel™	EA	5
230-D6W	6" SpeediChannel™, White	EA	5

Channel must ship LTL.



SPEEDICHANNEL™ FITTINGS

Adjustable Flat Bend

Adjustable flat bends flex from 45 to 90 degrees and make it easy to route the SpeediChannel™ around an obstacle. Each adjustable bend is individually packed and includes stainless steel screws.



CATALOG NO.	DESCRIPTION	ORDER UOM	ORDER MULTIPLE
230-AFB3	3in. Adjustable Flat Bend	EA	10
230-AFB3W	3in. Adjustable Flat Bend, White	EA	10
230-AFB4	4in. Adjustable Flat Bend	EA	10
230-AFB4W	4in. Adjustable Flat Bend, White	EA	10

Soffit Fittings

Ideal for outdoor applications where the SpeediChannel™ runs up an exterior wall and enters the house vertically through the soffit. Its large flat surface area easily covers the rough opening cut in the soffit. Furnished in two parts, the Soffit Fitting easily snaps onto the SpeediChannel™ for a clean installation.



CATALOG NO.	DESCRIPTION	ORDER UOM	ORDER MULTIPLE
230-SF3	3" Soffit Fitting	EA	10
230-SF3W	3" Soffit Fitting, White	EA	10
230-SF4	4" Soffit Fitting	EA	10
230-SF4W	4" Soffit Fitting, White	EA	10

Wall Penetration

Wall sleeves and penetration covers are used to transition from the SpeediChannel™ system to a through wall penetration. The wall sleeve creates a neat hole through the wall, and the line set is covered by the wall cover. DiversiTech's wall covers are designed to allow for easy installation - even after the line set has been installed. A unique hooking and fastening arrangement allows for quick and easy installation. Each wall cover is individually packed, and is furnished complete with stainless steel screws to attach the wall cover to the base. Three screws (supplied by others) are needed to fasten the wall cover to whatever type of wall construction the system is being installed on.



CATALOG NO.	DESCRIPTION	UOM	ORDER MULTIPLE
230-WC3	3" Wall Penetration Cover	EA	10
230-WC3B	3" Wall Penetration Cover, Brown	EA	10
230-WC3W	3" Wall Penetration Cover, White	EA	10
230-WC4	4" Wall Penetration Cover	EA	10
230-WC4B	4" Wall Penetration Cover, Brown	EA	10
230-WC4W	4" Wall Penetration Cover, White	EA	10
230-WC6	6" Wall Penetration Cover	EA	10
230-WC6W	6" Wall Penetration Cover, White	EA	10
230-WS2	2-1/2" Wall Sleeve	EA	10

90° Flat Bend

90° flat bends are used to route the SpeediChannel™ around an obstacle. Each bend is individually packed, and is furnished complete with stainless steel screws.



CATALOG NO.	DESCRIPTION	UOM	ORDER MULTIPLE
230-FB3	3" 90 degree Flat Bend	EA	10
230-FB3B	3" 90 degree Flat Bend, Brown	EA	10
230-FB3W	3" 90 degree Flat Bend, White	EA	10
230-FB4	4" 90 degree Flat Bend	EA	10
230-FB4B	4" 90 degree Flat Bend, Brown	EA	10
230-FB4W	4" 90 degree Flat Bend, White	EA	10
230-FB6	6" 90 degree Flat Bend	EA	10
230-FB6W	6" 90 degree Flat Bend, White	EA	10

SPEEDICHANNEL™ FITTINGS cont'd

90° Long Radius Bend

90° long radius flat bends are used to route the SpeediChannel™ around an obstacle. The long radius of the elbow allows a gentle bending radius on the copper line set. Each elbow is individually packed, and is furnished complete with stainless steel screws.



230-LFB4

CATALOG NO.	DESCRIPTION	UOM	ORDER MULTIPLE
230-LFB3	3" 90 degree Long Radius Bend	EA	10
230-LFB3B	3" 90 degree Long Radius Bend, Brown	EA	10
230-LFB3W	3" 90 degree Long Radius Bend, White	EA	10
230-LFB4	4" 90 degree Long Radius Bend	EA	10
230-LFB4B	4" 90 degree Long Radius Bend, Brown	EA	10
230-LFB4W	4" 90 degree Long Radius Bend, White	EA	10
230-LFB6	6" 90 degree Long Radius Bend	EA	10
230-LFB6W	6" 90 degree Long Radius Bend, White	EA	10

90° Inside Elbow

90° inside elbows are used to route the SpeediChannel™ around an inside corner. Each elbow is individually packed, and is furnished complete with stainless steel screws.



230-EB3



CATALOG NO.	DESCRIPTION	UOM	ORDER MULTIPLE
230-EB3	3" 90 degree Inside Elbow	EA	10
230-EB3B	3" 90 degree Inside Elbow, Brown	EA	10
230-EB3W	3" 90 degree Inside Elbow, White	EA	10
230-EB4	4" 90 degree Inside Elbow	EA	10
230-EB4B	4" 90 degree Inside Elbow, Brown	EA	10
230-EB4W	4" 90 degree Inside Elbow, White	EA	10
230-EB6	6" 90 degree Inside Elbow	EA	10
230-EB6W	6" 90 degree Inside Elbow, White	EA	10

Union Coupling

Used for joining two pieces of SpeediChannel™ — each cover being the same size. Each coupling is individually packed, and is furnished complete with stainless steel screws.



230-CP3



CATALOG NO.	DESCRIPTION	UOM	ORDER MULTIPLE
230-CP3	3" Union Coupling	EA	10
230-CP3B	3" Union Coupling, Brown	EA	10
230-CP3W	3" Union Coupling, White	EA	10
230-CP4	4" Union Coupling	EA	10
230-CP4B	4" Union Coupling, Brown	EA	10
230-CP4W	4" Union Coupling, White	EA	10
230-CP6	6" Union Coupling	EA	10
230-CP6W	6" Union Coupling, White	EA	10

45° Flat Bend

45° flat bends are used to route the SpeediChannel™ around an obstacle. Each bend is individually packed, and is furnished complete with stainless steel screws.



230-FB453

CATALOG NO.	DESCRIPTION	UOM	ORDER MULTIPLE
230-FB453	3" 45 degree Flat Bend	EA	10
230-FB453B	3" 45 degree Flat Bend, Brown	EA	10
230-FB453W	3" 45 degree Flat Bend, White	EA	10
230-FB454	4" 45 degree Flat Bend	EA	10
230-FB454B	4" 45 degree Flat Bend, Brown	EA	10
230-FB454W	4" 45 degree Flat Bend, White	EA	10
230-FB456	6" 45 degree Flat Bend	EA	10
230-FB456W	6" 45 degree Flat Bend, White	EA	10

90° Outside Elbow

90° outside elbows are used to route the SpeediChannel™ around an outside corner. Each elbow is individually packed, and is furnished complete with stainless steel screws.



230-EIN3



CATALOG NO.	DESCRIPTION	UOM	ORDER MULTIPLE
230-EIN3	3" 90 degree Outside Elbow	EA	10
230-EIN3B	3" 90 degree Outside Elbow, Brown	EA	10
230-EIN3W	3" 90 degree Outside Elbow, White	EA	10
230-EIN4	4" 90 degree Outside Elbow	EA	10
230-EIN4B	4" 90 degree Outside Elbow, Brown	EA	10
230-EIN4W	4" 90 degree Outside Elbow, White	EA	10
230-EIN6	6" 90 degree Outside Elbow	EA	10
230-EIN6W	6" 90 degree Outside Elbow, White	EA	10

T-Joint

Used for creating a tee connection between three pieces of SpeediChannel™ — all covers being the same size. The tee can be combined with the reducing coupling to join SpeediChannel™s of different sizes. Each tee is individually packed, and is furnished complete with stainless steel screws.



230-TJ4



CATALOG NO.	DESCRIPTION	UOM	ORDER MULTIPLE
230-TJ4	4" T-Joint	EA	10
230-TJ4B	4" T-Joint, Brown	EA	10
230-TJ4W	4" T-Joint, White	EA	10
230-TJ6	6" T-Joint	EA	10
230-TJ6W	6" T-Joint, White	EA	10

SPEEDICHANNEL™ FITTINGS cont'd

Flex Joint

An accordion style piece of SpeediChannel™, the flex joint can be extremely flexible routing a SpeediChannel™ system around virtually any type of obstacle. Each joint is 20" long and can be combined together for longer flex runs. Unlike competitor systems, the DiversiTech flex joint does NOT require the use of a union coupling. The DiversiTech flex joint slides tightly inside the SpeediChannel™ system.



230-FJ3

CATALOG NO.	DESCRIPTION	UOM	ORDER MULTIPLE
230-FJ3	3" Flex Joint	EA	10
230-FJ3W	3" Flex Joint, White	EA	10
230-FJ4	4" Flex Joint	EA	10
230-FJ4W	4" Flex Joint, White	EA	10

Duct End

The duct end is used to terminate a run of SpeediChannel™ to a small opening – just large enough for the line set and condensate drain line to pass through. Gives a neat/clean installation.



230-DE3 230-DE4

CATALOG NO.	DESCRIPTION	UOM	ORDER MULTIPLE
230-DE3	3" Duct End	EA	10
230-DE3B	3" Duct End, Brown	EA	10
230-DE3W	3" Duct End, White	EA	10
230-DE4	4" Duct End	EA	10
230-DE4B	4" Duct End, Brown	EA	10
230-DE4W	4" Duct End, White	EA	10
230-DE6	6" Duct End	EA	10
230-DE6W	6" Duct End, White	EA	10

Flat Wall Escutcheon

Typically used to cover a rough opening in a soffit, wall, or ceiling penetration. One side of the escutcheon is flat to allow for a SpeediChannel™ run going along a wall, and penetrating through an adjacent wall or ceiling. This is the most common type of wall penetration. Furnished in two parts, the escutcheon easily snaps onto the SpeediChannel™.



230-FR3

CATALOG NO.	DESCRIPTION	UOM	ORDER MULTIPLE
230-FR3	3" Flat Wall Escutcheon	EA	10
230-FR3W	3" Flat Wall Escutcheon, White	EA	10
230-FR4	4" Flat Wall Escutcheon	EA	10
230-FR4W	4" Flat Wall Escutcheon, White	EA	10
230-FR6	6" Flat Wall Escutcheon	EA	10
230-FR6W	6" Flat Wall Escutcheon, White	EA	10

Reducer Coupling

Used for joining two pieces of SpeediChannel™ — each cover being a different size. Each coupling is individually packed, and is furnished complete with stainless steel screws.



230-TC34

CATALOG NO.	DESCRIPTION	UOM	ORDER MULTIPLE
230-TC34	3" x 4" Reducer Coupling	EA	10
230-TC34W	3" x 4" Reducer Coupling, White	EA	10
230-TC46	4" x 6" Reducer Coupling	EA	10
230-TC46W	4" x 6" Reducer Coupling, White	EA	10

Cap

Used to cap the end of a SpeediChannel™ run. Easily snaps into the end of the SpeediChannel™.

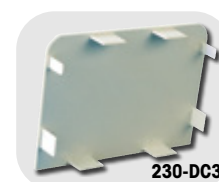

230-DC3

CATALOG NO.	DESCRIPTION	UOM	ORDER MULTIPLE
230-DC3	3" Cap	EA	10
230-DC3W	3" Cap, White	EA	10
230-DC4	4" Cap	EA	10
230-DC4W	4" Cap, White	EA	10
230-DC6	6" Cap	EA	10
230-DC6W	6" Cap, White	EA	10

Wall Escutcheon

Typically used to cover a rough opening in a wall or ceiling penetration. The hole in the escutcheon is centered to allow for a free standing SpeediChannel™ to penetrate through a wall or ceiling. This is the fairly un-common type of wall or ceiling penetration. Check carefully, as you may need the Flat Wall Escutcheon. Furnished in two parts, the escutcheon easily snaps onto the SpeediChannel™.



230-WR3

CATALOG NO.	DESCRIPTION	UOM	ORDER MULTIPLE
230-WR3	3" Wall Escutcheon	EA	10
230-WR3W	3" Wall Escutcheon, White	EA	10
230-WR4	4" Wall Escutcheon	EA	10
230-WR4W	4" Wall Escutcheon, White	EA	10
230-WR6	6" Wall Escutcheon	EA	10
230-WR6W	6" Wall Escutcheon, White	EA	10

SPEEDICHANNEL™ FITTINGS cont'd

SpeediChannel™ Accessories

A variety of accessories that are complementary or required for installing DiversiTech's SpeediChannel™ system.

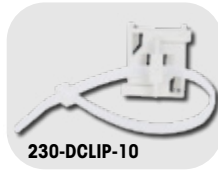

CATALOG NO.	DESCRIPTION	UOM	ORDER MULTIPLE
230-DCLIP-10	SpeediClip™ and 11" Cable Ties, pack of 10	PK	1
230-DCLIP	*SpeediClip™, pack of 50	PK	1
230-DSCREW	SpeediChannel™ screws, pack of 100	PK	1
WTB11C	Black Wire Ties – 11", pack of 100	PK	1

Universal Pump Elbow

The Universal Pump Elbow lets an installer use any mini pump of their choice and install it with SpeediChannel. Includes pump elbow and reservoir mounting brackets to fit most mini-split pumps.



CATALOG NO.	DESCRIPTION	UOM	ORDER MULTIPLE
230-PFB3	Universal Pump Elbow	EA	1

SpeediChannel™ Kits

The SpeediChannel™ Fitting Kit provides a simple mix of the basic fittings used in a typical SpeediChannel™ installation job. Included are one coupling, one wall penetration, one inside elbow, one long radius flat bend, and one pack of ten SpeediClips and 11" cable ties. The 230-IKC3 and 230-IKC4 Installation Kits include three 48" pieces of channel and selected fittings.



CATALOG NO.	DESCRIPTION	UOM	ORDER MULTIPLE
230-IK3	3" SpeediChannel™ Fitting Kit	EA	1
230-IK3W	3" SpeediChannel™ Fitting Kit, White	EA	1
230-IK4	4" SpeediChannel™ Fitting Kit	EA	1
230-IK4W	4" SpeediChannel™ Fitting Kit, White	EA	1
230-IKC3	3" SpeediChannel™ Installation Kit	EA	1
230-IKC3W	3" SpeediChannel™ Installation Kit, White	EA	1
230-IKC4	4" SpeediChannel™ Installation Kit	EA	1
230-IKC4W	4" SpeediChannel™ Installation Kit, White	EA	1

SpeediChannel™ Flex Hose Kits

A flexible hose kit of SpeediChannel that protects the line set from the condensing unit to the wall. Also provides a quick easy connection between two lengths of channel over or around obstacles. The kit comes with everything needed for a clean professional installation.



CATALOG NO.	DESCRIPTION	UOM	ORDER MULTIPLE
230-FH3-KIT	3" Flex Hose Kit	EA	1
230-FH3W-KIT	3" Flex Hose Kit, White	EA	1
230-FH4-KIT	4" Flex Hose Kit	EA	1
230-FH4-KITW	4" Flex Hose Kit, White	EA	1

LINESET CUTTING TOOLS

Lineset Cover Cutter

The 230-CUTTER is designed to easily cut lineset covers that protect linesets and insulations in HVAC applications. The 230-CUTTER has a ratcheting cutting blade that makes cutting lineset covers easy and clean. It has cutting capacity for various duct sizes, ranging from 1.38" x 1.18" up to 3.54" x 2.55".

- Easy to open and close
- Cut cleanly with ratcheting blade
- Strong metal body and handle
- Safety hook to keep blade closed
- Lightweight and easy to carry



CATALOG NO.	DESCRIPTION	UOM	ORDER MULTIPLE
230-CUTTER	Lineset Cover Cutter	EA	1

ROOF INLETS

Roof Inlets

"Roof entrance" adapters for linesets are the ultimate solution for a professional flat roof installation. Manufactured from UV weather resistant plastics or painted aluminum, the Roof Inlet combines a series of features:

- The Roof Inlet body part is equipped with a slope avoiding possible damage to the insulation and preventing kinks into the copper tubes.
- The Roof Inlet base holes allow a steady fixation (depending on the roof surface type and composition).
- The Roof Inlet cap is firmly fixed to the body with stainless steel bolts.



230-INJ465

CATALOG NO.	DESCRIPTION	UOM	ORDER MULTIPLE
230-INJ465	SpeediChannel™ Roof Inlet – 5" x 5" PVC	EA	1
230-INJ462	SpeediChannel™ Roof Inlet – 10" x 5" PVC	EA	1
230-INJ463A	SpeediChannel™ Roof Inlet – 3" x 3" Aluminum	EA	1
230-INJ465A	SpeediChannel™ Roof Inlet – 5" x 5" Aluminum	EA	1
230-INJ462A	SpeediChannel™ Roof Inlet – 5" x 10" Aluminum	EA	1

EASYGUARD™ LINE SET COVER SYSTEM

EasyGuard™

The DiversiTech EasyGuard™ is available in two widths, both in 6-1/2 feet lengths. Includes pack of SpeediClips™.

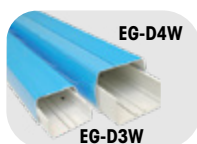

CATALOG NO.	DESCRIPTION	UOM	ORDER MULTIPLE
EG-D3W	3" EasyGuard - 6-1/2' long	EA	1
EG-D4W	4" EasyGuard - 6-1/2' long	EA	1

Channel must ship LTL.

EASYGUARD™ FITTINGS

Wall Penetration

Wall sleeves and penetration covers are used to transition from the EasyGuard™ system to a through wall penetration. The wall sleeve creates a neat hole through the wall, and the line set is covered by the wall cover. DiversiTech's wall covers are designed to allow for easy installation - even after the line set has been installed. A unique hooking and fastening arrangement allows for quick and easy installation. Each wall cover is individually packed, and is furnished complete with stainless steel screws to attach the wall cover to the base. Three screws (supplied by others) are needed to fasten the wall cover to whatever type of wall construction the system is being installed on.



EG-WC3W

CATALOG NO.	DESCRIPTION	UOM	ORDER MULTIPLE
EG-WC3W	3" Wall Penetration Cover	EA	1
EG-WC4W	4" Wall Penetration Cover,	EA	1

Soffit Fittings

Ideal for outdoor applications where the EasyGuard™ runs up an exterior wall and enters the house vertically through the soffit. Its large flat surface area easily covers the rough opening cut in the soffit. Furnished in two parts, the Soffit Fitting easily snaps onto the EasyGuard™ for a clean installation.



EG-SF3W

CATALOG NO.	DESCRIPTION	ORDER UOM	ORDER MULTIPLE
EG-SF3W	3" Soffit Fitting	EA	1
EG-SF4W	4" Soffit Fitting	EA	1

90° Flat Bend

90° flat bends are used to route the EasyGuard™ around an obstacle. Each bend is individually packed, and is furnished complete with stainless steel screws.



EG-FB3W

CATALOG NO.	DESCRIPTION	UOM	ORDER MULTIPLE
EG-FB3W	3" 90 degree Flat Bend	EA	1
EG-FB4W	4" 90 degree Flat Bend	EA	1

EASYGUARD™ FITTINGS cont'd

90° Inside Elbow

90° inside elbows are used to route the EasyGuard™ around an inside corner. Each elbow is individually packed, and is furnished complete with stainless steel screws.



CATALOG NO.	DESCRIPTION	UOM	ORDER MULTIPLE
EG-EB3W	3" 90 degree Inside Elbow	EA	1
EG-EB4W	4" 90 degree Inside Elbow, Brown	EA	1

Union Coupling

Used for joining two pieces of EasyGuard™—each cover being the same size. Each coupling is individually packed, and is furnished complete with stainless steel screws.



CATALOG NO.	DESCRIPTION	UOM	ORDER MULTIPLE
EG-CP3W	3" Union Coupling	EA	1
EG-CP4W	4" Union Coupling	EA	1

T-Joint

Used for creating a tee connection between three pieces of EasyGuard™ – all covers being the same size. The tee can be combined with the reducing coupling to join SpeediChannel™s of different sizes. Each tee is individually packed, and is furnished complete with stainless steel screws.



CATALOG NO.	DESCRIPTION	UOM	ORDER MULTIPLE
EG-TJ3W	3" T-Joint	EA	1
EG-TJ4W	4" T-Joint	EA	1

Duct End

The duct end is used to terminate a run of EasyGuard™ to a small opening – just large enough for the line set and condensate drain line to pass through. Gives a neat/clean installation.



CATALOG NO.	DESCRIPTION	UOM	ORDER MULTIPLE
EG-DE3W	3" Duct End	EA	1
EG-DE4W	4" Duct End	EA	1

90° Outside Elbow

90° outside elbows are used to route the EasyGuard™ around an outside corner. Each elbow is individually packed, and is furnished complete with stainless steel screws.



CATALOG NO.	DESCRIPTION	UOM	ORDER MULTIPLE
EG-EIN3W	3" 90 degree Outside Elbow	EA	1
EG-EIN4W	4" 90 degree Outside Elbow	EA	1

Flex Hose Connection Kit

A flexible hose kit of EasyGuard™ that protects the line set from the condensing unit to the wall. Also provides a quick easy connection between two lengths of channel over or around obstacles. The kit comes with everything needed for a clean professional installation.



CATALOG NO.	DESCRIPTION	UOM	ORDER MULTIPLE
EG-FH3W	3" Flex Hose Connection Kit	EA	1
EG-FH4W	4" Flex Hose Connection Kit	EA	1

Reducer Coupling

Used for joining two pieces of EasyGuard™-each cover being a different size. Each coupling is individually packed, and is furnished complete with stainless steel screws.



CATALOG NO.	DESCRIPTION	UOM	ORDER MULTIPLE
EG-TC34W	3" x 4" Reducer Coupling	EA	1

MAINTENANCE CHEMICALS

Accessories	155-156
Additives	162
Coil Cleaners	154-155
Coil Cleaning Aerosols	156
Drain Pan Disinfectant	156
Flushing Products	157
Glycols	156-157
Hoses, Sprayers	158
Ice Machine Products	159
Leak Detectors and Accessories	159-160
Leak Sealants	160-161
Maintenance Chemical Quick Reference Guide	152-153
Odor Neutralizers	161
Refrigeration Oils	161
System Cleaners	162
Test Kits	162
Thread Sealants	162
Vacuum Pump Oil	162



Maintenance Chemical Solution Quick Reference Guide

EQUIPMENT TYPE	PRODUCT TYPE			
	TRIPLE-D®	ECO-COIL™	PRO-BROWN™	PRO-BLUE™
Condenser Units	X	X	X	X
(No-Rinse)		X		
Evaporator Units	X	X		
(No-Rinse)	X	X		
Rubber Roof Tops	X			
Fan Blades, Grilles, Etc.	X	X		
Electronic Air Filters	X	X		
Permanent Filters	X	X		
Microchannel Coils	X	X		
Small Condenser Coils	X	X	X	X
Small Evaporator Coils	X	X		
Mini-Splits	X	X		
APPLICATION SOLUTION				
Brightener			X	X
Condensate "Gunk"	X	X	X	X
Degreasing	X	X	X	X
Deodorizer	X	X		
Dirt and Grime	X	X	X	X
Disinfectant	USE SANI C-N-D™ COIL AND DRAIN DISINFECTANT			
Heresite Coated Coils		X		
Oxide Deposits			X	X
Remove Minerals				
CHEMICAL TYPE				
Alkaline	X	X	X	X
Acidic				
DILUTION (PRODUCT: H2O)				
Condensers	1:6	1:3	1:3	1:3
Evaporators	1:10	1:6		
Evaporators (No-Rinse)	1:20	1:6		
PACKAGING AVAILABLE				
19 Ounce Aerosol	TRIPLE-D-AER	ECO-COIL-AER	PRO-BROWN-AER	PRO-BLUE-AER
1 Quart Trigger Sprayer	TRIPLE-D-RTU			
32 Oz. Bottle	TRIPLE-D-32	ECO-COIL-32	PRO-BROWN-32	PRO-BLUE-32
1 Gallon	TRIPLE-D	ECO-COIL	PRO-BROWN	PRO-BLUE
5 Gallon	TRIPLE-D-5	ECO-COIL-5	PRO-BROWN-5	PRO-BLUE-5
55 Gallon Drum	TRIPLE-D-55	ECO-COIL-55	PRO-BROWN-55	PRO-BLUE-55
1 LB Granular	TRIPLE-D-GRAN			
ENVIRONMENTAL				
Biodegradable	X	X	X	X
Meets EPA's Design for the Environment Alternative Program as Green		X		
FOOD COMPLIANCE				
USDA Approved	X	X		X
NSF Registered	X	X		X

EQUIPMENT TYPE	PRODUCT TYPE			
	PRO-GREEN™	PRO-RED PLUS™	PRO-YELLOW™	PRO-KLEEN™
Condenser Units	X	X	X	X
(No-Rinse)	X			
Evaporator Units	X			
(No-Rinse)	X			
Rubber Roof Tops				
Fan Blades, Grilles, Etc.	X			
Electronic Air Filters	X			
Permanent Filters	X			
Microchannel Coils	X			
Small Condenser Coils	X	X	X	X
Small Evaporator Coils	X			
Mini-Splits	X			
APPLICATION SOLUTION				
Brightener		X	X	X
Condensate "Gunk"	X	X	X	X
Degreasing		X	X	X
Deodorizer				
Dirt and Grime	X	X	X	X
Disinfectant	USE SANI C-N-D™ COIL AND DRAIN DISINFECTANT			
Heresite Coated Coils				
Oxide Deposits		X	X	X
Remove Minerals				X
CHEMICAL TYPE				
Alkaline	X	X	X	
Acidic				X
DILUTION (PRODUCT: H2O)				
Condensers	1:3	1:3	1:2	1:3
Evaporators	1:3			
Evaporators (No-Rinse)	1:3			
PACKAGING AVAILABLE				
19 Ounce Aerosol	PRO-GREEN-AER	PRO-RED+AER	PRO-YELLOW-AER	
1 Quart Trigger Sprayer				
32 Oz. Bottle	PRO-GREEN-32	PRO-RED+32	PRO-YELLOW-32	
1 Gallon	PRO-GREEN	PRO-RED+	PRO-YELLOW	PRO-KLEEN
5 Gallon	PRO-GREEN-5	PRO-RED+5	PRO-YELLOW-5	PRO-KLEEN-5
55 Gallon Drum	PRO-GREEN-55	PRO-RED+55	PRO-YELLOW-55	PRO-KLEEN-55
1 LB Granular				
ENVIRONMENTAL				
Biodegradable	X	X	X	X
Meets EPA's Design for the Environment Alternative Program as Green				
FOOD COMPLIANCE				
USDA Approved	X			
NSF Registered	X			

COIL CLEANERS

Triple-D® Universal Coil Cleaner

Triple-D® is the ultimate universal coil cleaner that can be used on condensers, evaporators, microchannels, roof-top units, and mini-split applications. The triple active synergistic highly effective solution is formulated to remove a broad range of soils while degreasing and deodorizing. It is ideal for cleaning most metals including aluminum and copper while extending equipment life and diminishing the potential for refrigerant leaks. Using 75% less than comparable products, it reduces the amount of solution needed to clean. Triple-D® is biodegradable, NSF approved and available in seven different packaging configurations.



CATALOG NO.	DESCRIPTION	UOM	ORDER MULTIPLE
TRIPLE-D	Triple-D® – 1 gallon concentrate	EA	4
TRIPLE-D-5	Triple-D® – 5 gallon concentrate	EA	1
TRIPLE-D-AER	Triple-D® – 19 oz. Aerosol	EA	12
TRIPLE-D-AER-6	Triple-D® – 19 oz. Aerosol	EA	6
TRIPLE-D-GRAN	Triple-D® – 1 lb. Granular	EA	12
TRIPLE-D-32	Triple-D® – 32 oz. bottle – concentrate	EA	12
TRIPLE-D-RTU	Triple-D® – 1 quart trigger sprayer – pre-diluted	EA	12
TRIPLE-D-55	Triple-D® – 55 gallon drum	EA	1

Eco-Coil™ Environmentally Friendly Coil Cleaner

Eco-Coil™ is an environmentally friendly no rinse non-corrosive cleaner ideal for evaporator and condenser coils, electronic and permanent filters, fan blades, grilles, mini-split and microchannel applications. Eco-coil quickly cleans away dirt, dust, and deposits while deodorizing with no harmful risks to animal, aquatic or plant life. Tested to provide the highest level of performance, Eco-Coil not only reduces the number of products required to clean but also has different water mixture ratios to maximize solution usage. Furthermore, it brightens, biodegradable, NSF approved, and meets the EPA's Design for the Environment Alternative Program as a "green" product.



CATALOG NO.	DESCRIPTION	UOM	ORDER MULTIPLE
ECO-COIL-32	Eco-Coil™ Environmentally Friendly Coil Cleaner – 32 oz. bottle	EA	12
ECO-COIL	Eco-Coil™ Environmentally Friendly Coil Cleaner – 1 gallon container	EA	4
ECO-COIL-55	Eco-Coil™ Environmentally Friendly Coil Cleaner – 55 gallon drum	EA	1
ECO-COIL-AER	Eco-Coil™ – 19 oz. Aerosol	EA	1

Pro-Brown™

Pro-Brown™ is a heavy duty alkaline cleaner that pulls out deeply embedded dirt removing greasy soils and oxidation while brightening and cleaning coils. Ideal for air-cooled condensers and mini-splits thanks to its dual action foaming capabilities. It is biodegradable and NSF approved.



CATALOG NO.	DESCRIPTION	UOM	ORDER MULTIPLE
PRO-BROWN	Pro-Brown™ Foaming Coil Cleaner – 1 gallon container	EA	4
PRO-BROWN-5	Pro-Brown™ Foaming Coil Cleaner – 5 gallon pail	EA	1
PRO-BROWN-AER	Pro-Brown™ – 19 oz. Aerosol	EA	6

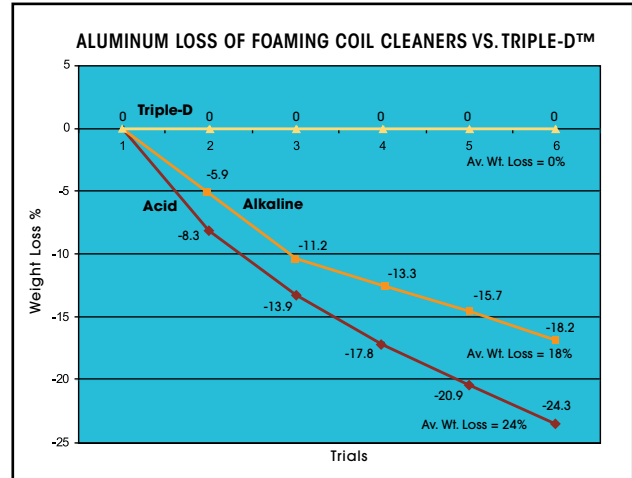

Conventional foaming acid and non-acid coil cleaners attack and chemically react with the aluminum coil components. This reaction is exhibited by a foaming action. The attack/reaction dissolves the aluminum, destroying the heat-transfer ability of the coil and creating the potential for refrigerant leaks.

Pro-Blue™

Pro-Blue™ is a heavy foaming alkaline-based solution designed for condensers and mini-splits that penetrates dirt and grease removing deposits resulting in clean and brightened coils. Pro-Blue is biodegradable, NSF approved, and available in numerous packaging configurations.



CATALOG NO.	DESCRIPTION	UOM	ORDER MULTIPLE
PRO-BLUE-32	Pro-Blue™ Foaming Concentrate (non-acid) – 32 oz. bottle	EA	12
PRO-BLUE	Pro-Blue™ Foaming Concentrate (non-acid) – 1 gallon container	EA	4
PRO-BLUE-5	Pro-Blue™ Foaming Concentrate (non-acid) – 5 gallon pail	EA	1
PRO-BLUE-55	Pro-Blue™ Foaming Concentrate (non-acid) – 55 gallon drum	EA	1
PRO-BLUE-AER	Pro-Blue™ – 19 oz. Aerosol	EA	6

Pro-Green™

Pro-Green™ is a no rinse, mild alkaline coil cleaner that can be used on air-cooled condensers, evaporators, electronic and permanent filters, fan blades, grilles, mini-split and microchannel applications. Pro-Green cleans deposits on coils and rids condensate pans of slime. It is NSF approved for use in federally inspected plants and available in numerous packaging configurations.



CATALOG NO.	DESCRIPTION	UOM	ORDER MULTIPLE
PRO-GREEN-32	Pro-Green™ No Rinse (non-toxic) – 32 oz. bottle	EA	12
PRO-GREEN	Pro-Green™ No Rinse (non-toxic) – 1 gallon container	EA	4
PRO-GREEN-5	Pro-Green™ No Rinse (non-toxic) – 5 gallon pail	EA	1
PRO-GREEN-AER	Pro-Green™ – 19 oz. Aerosol	EA	6

COIL CLEANERS cont'd

Pro-Red Plus™

Pro-Red Plus™ is a fast acting cleaning solution for condensers, microchannels, and mini-splits that foams and lifts away stubborn deposits including tarnish and corrosion. Its non-acid formula is as effective as conventional acid cleaners without the use of hydrofluoric acid. The vigorous foaming action eliminates the need for prolonged soaking, steam cleaning or scrubbing coils and without emitting corrosive fumes or rusting ferrous metals. Pro-Red Plus™ is biodegradable, NSF approved, and available in a number of convenient packaging solutions.



CATALOG NO.	DESCRIPTION	UOM	ORDER MULTIPLE
PRO-RED+32	Pro-Red Plus™ Cleaner and Brightener (non-acid) – 32 oz. bottle	EA	12
PRO-RED+	Pro-Red Plus™ Cleaner and Brightener (non-acid) – 1 gallon container	EA	4
PRO-RED+5	Pro-Red Plus™ Cleaner and Brightener (non-acid) – 5 gallon pail	EA	1
PRO-RED+AER	Pro-Red Plus™ – 19 oz. Aerosol	EA	6

Aerosol Starter Kit

DiversiTech has created a 12 pack of aerosol cans consisting of two each of PRO-BLUE-AER, PRO-RED+-AER, PRO-GREEN-AER, PRO-BROWN-AER, PRO-YELLOW-AER, and ECO-COIL-AER. This starter kit allows wholesalers the opportunity to stock a limited quantity of these new cans.



CATALOG NO.	DESCRIPTION	UOM	ORDER MULTIPLE
AEROSOL-STARTER-KIT	Aerosol Starter Kit – 2 each, 12 cans total	PK	1

Pro-Yellow™

Pro-Yellow™ is a powerful cleaner ideal for condensers, microchannels, and mini-splits that targets large concentrations of dirt and grime. With its heavy foaming alkaline-based solution, debris will be removed from the coil while providing excellent brightening. Pro-Yellow is biodegradable, NSF approved and available in a number of packaging solutions.



CATALOG NO.	DESCRIPTION	UOM	ORDER MULTIPLE
PRO-YELLOW-32	Pro-Yellow™ (non-toxic) – 32 oz. bottle	EA	12
PRO-YELLOW	Pro-Yellow™ (non-toxic) – 1 gallon container	EA	4
PRO-YELLOW-55	Pro-Yellow™ (non-toxic) – 55 gallon drum	EA	1
PRO-YELLOW-AER	Pro-Yellow™ – 19 oz. Aerosol	EA	6

Pro-Kleen™

A unique foaming acid coil cleaner designed to replace hazardous hydrofluoric acid coil cleaners. It contains a synergistic combination of mineral acids, corrosion inhibitors, biodegradable surfactants, penetrants, and degreasers that emulsify, solubilize and neutralize soils leaving a clean, bright, efficient coil surface.



CATALOG NO.	DESCRIPTION	UOM	ORDER MULTIPLE
PRO-KLEEN	Pro-Kleen™ Outdoor Coil Cleaner – 1 gallon container	EA	4

ACCESSORIES

Coil Guard™

Ideally used in coastal areas, where salt air accelerates rust and decay. Highly recommended for use in all geographical areas to prolong the life of a unit. When applied properly, Coil Guard™ dries quickly and immediately resists salt spray, acids, and soap solutions. Weather will not blacken it. Coil Guard™ has high dielectric properties and has no effect on heat transfer. Our blue tinted product is used to ensure complete coverage of coating.



CATALOG NO.	DESCRIPTION	UOM	ORDER MULTIPLE
CG-AER	Clear Coil Guard™ – 20 oz. Aerosol	EA	12
CGB-AER	Blue Coil Guard™ – 20 oz. Aerosol	EA	12

Cool-Weld™ Heat Barrier Spray

Spray on thick gel formula that protects surfaces from heat and damage. Odorless, non-toxic gel coats rubber, plastic, and painted surfaces to shield them during welding or soldering.



CATALOG NO.	DESCRIPTION	UOM	ORDER MULTIPLE
COOLWELD-32	Cool-Weld™ Heat Barrier Spray – 32 oz. Container	EA	12

ACCESSORIES cont'd

Pan-Patch™

Pan-Patch™ is a two part epoxy coating designed for HVAC applications. It is a self leveling formula that is ideal in a damp or wet environment. Pan-Patch™ resists corrosion and stops pan leaks without replacing the pan. Light gray in color, one gallon covers about 160 square feet with 10 mil thickness.

PANPATCH-BAG



CATALOG NO.	DESCRIPTION	COVERAGE	UOM	ORDER MULTIPLE
PANPATCH-BAG	Pan-Patch™ Pan Sealant – Bag, pack of 10	8 sq. ft.	EA	10
PANPATCH	Pan-Patch™ Pan Sealant – 1 Gallon	160 sq. ft.	EA	4

COIL CLEANING AEROSOLS

Foam-Plus™ Aerosol Foaming Coil Cleaner

Heavy-duty foaming detergent coil cleaner in an aerosol can. Non-flammable and water-based with no chlorinated solvents. Blasting foam stream reaches into tight areas for maximum cleaning. The foaming alkaline detergent quickly liquifies dirt, grease, oil or other residue and is completely self-rinsing on condensate producing coils.

358-20



CATALOG NO.	DESCRIPTION	UOM	ORDER MULTIPLE
358-20	Foam-Plus™ Foaming Coil Cleaner – 19 oz.	EA	12

DRAIN PAN DISINFECTANT

Sani C-N-D™ Coil and Drain Pan Disinfectant

Sani C-N-D™ is an EPA registered disinfectant, fungicide, mildewstat and viricide. It is ready-to-use and assures consistent, effective results. Sani C-N-D™ destroys "dirty sock," mildew and other malodors.

SANI-CND



CATALOG NO.	DESCRIPTION	UOM	ORDER MULTIPLE
SANI-CND-32	Sani C-N-D™ Disinfectant – 32 oz. Container	EA	12
SANI-CND	Sani C-N-D™ Disinfectant – 1 Gal. Container	EA	4
SANI-CND-5	Sani C-N-D™ Disinfectant – 5 Gallon Pail	EA	1
SANI-CND-55	Sani C-N-D™ Disinfectant – 55 Gallon Drum	EA	1

Pan-Kote Heavy Duty Drain Pan Patch

A super-durable rubberized coating used to fill-in and patch HVAC drain pans. Seals out rust and corrosion. Stays flexible in variable weather conditions.

641-14



CATALOG NO.	DESCRIPTION	UOM	ORDER MULTIPLE
641-14	Pan-Kote Drain Pan Patch – 14 oz. Aerosol	EA	12

GLYCOLS

DiversiTech produces the most complete line of industrial coolant and heat transfer products in the HVAC/R Industry. Our product line includes ProTek PG propylene glycol products formulated with food-grade corrosion inhibitors and ProTek EG ethylene glycol products for industrial applications. Both product groups are designed to provide freeze and burst protection and are formulated with inhibitors and antifoam agents to provide long-term stability against system corrosion and fouling.

ProTek EG™

An inhibited ethylene glycol based heat transfer fluid designed for use in hydronic, chilled and closed water.

CATALOG NO.	DESCRIPTION	GLYCOL/WATER RATIO	UOM	ORDER MULTIPLE
EG	ProTek EG™ – 1 Gallon Jug	95/5	EA	4
EG-5	ProTek EG™ – 5 Gallon Pail	95/5	EA	1
EG-55	ProTek EG™ – 55 Gallon Drum	95/5	EA	1

EG



GLYCOLS cont'd

ProTek™ Closed Loop Heat Transfer Fluid

ProTek™ for closed loop water recirculation systems is a blue liquid. Available in three concentrations: original ProTek-100™, ProTek-50™, and ProTek-Plus™. Each concentration may be further diluted to alter freeze and burst temperatures. Refer to the technical data sheet for specific information.



CATALOG NO.	DESCRIPTION	GLYCOL/WATER RATIO	UOM	ORDER MULTIPLE
PG-50	ProTek-50™ – 1 Gallon Jug	35/65	EA	4
PG-50-5	ProTek-50™ – 5 Gallon Pail	35/65	EA	1
PG-50-55	ProTek-50™ – 55 Gallon Drum	35/65	EA	1

ProTek PG Plus™

ProTek PG PLUS™ is an inhibited propylene glycol based industrial heat transfer fluid and anti freeze that contains food grade corrosion inhibitors. It is suitable for use in potable water systems. ProTek PG PLUS™ is designed to provide freeze and burst protection, excellent thermal conductance, protection against corrosion and fouling and long term stability in closed recirculating water loops. ProTek PG PLUS™ must be mixed with water to provide freeze and burst protection. Freeze points and burst points are controlled by the propylene glycol to water ratio.



CATALOG NO.	DESCRIPTION	GLYCOL/WATER RATIO	UOM	ORDER MULTIPLE
PG-PLUS	ProTek-Plus™ – 1 Gallon Jug	95/5	EA	4
PG-PLUS-5	ProTek-Plus™ – 5 Gallon Pail	95/5	EA	1
PG-PLUS-55	ProTek-Plus™ – 55 Gallon Drum	95/5	EA	1

ProTek PG 100™

ProTek 100™ is an inhibited propylene glycol based industrial heat transfer fluid and antifreeze that contains food grade corrosion inhibitors. It is suitable for use in potable water systems. ProTek 100™ is designed to provide freeze and burst protection, excellent thermal conductance, protection against corrosion and fouling and long term stability in closed recirculating water loops. ProTek 100™ provides burst protection to 100°F. Freeze points and burst points are controlled by the propylene glycol to water ratio.



CATALOG NO.	DESCRIPTION	GLYCOL/WATER RATIO	UOM	ORDER MULTIPLE
PG-100	ProTek-100™ – 1 Gallon Jug	70/30	EA	4
PG-100-5	ProTek-100™ – 5 Gallon Pail	70/30	EA	1
PG-100-55	ProTek-100™ – 55 Gallon Drum	70/30	EA	1

ProTek BG™ for Cast Iron Water Boilers

A red liquid boiler grade product formulated specifically with corrosion inhibitors necessary for use in water boilers.



CATALOG NO.	DESCRIPTION	GLYCOL/WATER RATIO	UOM	ORDER MULTIPLE
PG-BG	ProTek-BG™ – 1 Gallon Jug	70/30	EA	4
PG-BG-5	ProTek-BG™ – 5 Gallon Pail	70/30	EA	1
PG-BG-55	ProTek-BG™ – 55 Gallon Drum	70/30	EA	1

FLUSHING PRODUCTS

Pro-Flush® HVAC Flushing Solvent

A flushing solvent for A/C and refrigeration systems formulated for R410A retrofits, refrigerant conversions and compressor burnouts. Compatible with all refrigerants and compressor oils. All solvents in Pro-Flush® conform to EPA SNAP standards, and are low toxicity and residue free. Available as a kit or in an 8 or 16 oz. solvent refill. The kit makes servicing quick, easy, and safe, as well as assuring you get to the job site with all necessary hardware in hand for 1 stop servicing. The kit includes: 8 oz. container of Pro-Flush® solvent, refillable Pro-Flush® injector tool pressure tank, pressure relief valve for added safety, large rubber adapter that flushes up to 1-1/4" line sets, service hose.



CATALOG NO.	DESCRIPTION	UOM	ORDER MULTIPLE
PF-KIT	Pro-Flush® Kit – injector, 8 oz. refill, nozzle adapter and hose	EA	3
PF-08	Pro-Flush® HVAC Flushing Solvent – 8 oz. Refill	EA	6
PF-16	Pro-Flush® HVAC Flushing Solvent – 16 oz. Refill	EA	6
PF-ADAPTER	Pro-Flush® Line Set Adapter	EA	1
PF-IGUN	Replacement Injector Tool	EA	1
PF-IHOSE	2' Replacement Hose	EA	1

Super Change™

Super Change eliminates oil change outs replacing R22 line set conversion flushes. Ideal for dry charged units, retrofits, and drop-in refrigerants, Super Change maximizes oil return and heat transfer including POE charged compressors. Reusable hose (20122) sold separately. Also available in flexible injectable hose (991).



CATALOG NO.	DESCRIPTION	UOM	ORDER MULTIPLE
981	Super Change™ - Up to 6 Tons	EA	6
20122	Reusable Charging Hose for Super Change™	EA	1
991	Super Change™ Inject	EA	4

HOSES, SPRAYERS

Power Sprayer

DiversiTech's Power Sprayer makes coil cleaning easier and faster! Designed as a backpack sprayer, it holds up to 4 gallons of coil cleaning solution. The battery powered unit will spray continuously for 10 hours on a single charge. Included are three different nozzles to give you the right spray for any situation. It also features: padded backpack straps for a comfortable fit, plug-in charger for fast recharging, a convenient center mount handle, an extra long spray wand with curved tip for accurate application, and a large on/off valve which can lock in position for easier spraying of big jobs. The large tank opening also makes it easy to add coil cleaner and mix to the correct ratio. The Power Sprayer is compatible with all DiversiTech coil cleaners.



CATALOG NO.	DESCRIPTION	UOM	ORDER MULTIPLE
PS-1	Battery powered/rechargeable backpack sprayer for coil cleaning	EA	1

Dial-a-Mix Sprayer

Save time and money by dialing in the exact mix ratio to properly clean the coil. This sprayer features 5 mix ratios (1:3, 1:4, 1:6, 1:9, 1:10), a 1/2 gallon capacity bottle and a quick disconnect for fast and easy rinsing.



CATALOG NO.	DESCRIPTION	UOM	ORDER MULTIPLE
540-GUN	Dial-a-Mix Sprayer	EA	6

Garden Hose

High quality product priced for high volume sales. Soft-Flex formulation makes the 5 ply Hose easy to handle. Withstands 500 psi water pressure. Heavy duty solid brass couplings and collar. Full Lifetime Guarantee!

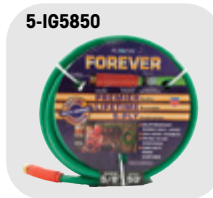

CATALOG NO.	DESCRIPTION	UOM	ORDER MULTIPLE
5-IG5850	Green Flexon 5-Ply Forever Garden Hose	EA	5

All Purpose Sprayers

Lightweight, versatile gallon size bottle has a 28" flexible hose and easy-to-carry handle. Best for big jobs in hard-to-reach places. Adjustable nozzle will atomize any low viscosity liquid. Adjusts from a mist to a 12' jet stream or anything in between. One pint container has a measured ounce guide. Ideal for water-based chemicals.



CATALOG NO.	DESCRIPTION	UOM	ORDER MULTIPLE
BS-32	Quart Size Sprayer	EA	12

Compression Sprayers

Acid impervious poly design with a 36" (91cm) reinforced hose, shut-off with lock-on feature for continuous spraying, a 2-piece nozzle that's detachable for easy clean up and fits directly to the shut-off or extension wand. The Hand-Held Sprayer has a 48 oz. (1.4 l) capacity, perfect for small areas. All sprayers have a full 5 year warranty.



CATALOG NO.	DESCRIPTION	UOM	ORDER MULTIPLE
1002	Hand Held Sprayer	EA	1
2601	1 Gallon Wand Sprayer	EA	1
2602	2 Gallon Wand Sprayer	EA	1
2603	3 Gallon Wand Sprayer	EA	1

Hot Water Hose

High burst strength. 500 PSI. Withstands hot water up to 160°F. EPDM tube. Heavy duty solid brass couplings.



CATALOG NO.	DESCRIPTION	UOM	ORDER MULTIPLE
5-HW5850	5/8" x 50' Hot Water Hose	EA	5

Pistol Grips & Water Nozzle

Pistol Grip – 540-572 Insulated:
For spraying hot or cold water. Heavy-duty, self adjusting "duck" packing for lifetime proof seal.
Water Nozzle – 540-573 Un-insulated:
Heavy-duty and holds open clip for continuous spraying. Self-adjusting "duck" for leak proof seal.



CATALOG NO.	DESCRIPTION	UOM	ORDER MULTIPLE
540-572	Insulated Pistol Grip	EA	12
540-573	Uninsulated Water Nozzle	EA	12

ICE MACHINE PRODUCTS

Super-Kool™ Nickel-Safe and Metal-Safe Ice Machine Cleaner

An economical, fast-acting, non-foaming acid sequestrant formula that quickly removes soil and mineral buildup. This safe, highly-concentrated, inhibited formula will not attack nickel or other metal components. USDA AUTHORIZED



CATALOG NO.	DESCRIPTION	UOM	ORDER MULTIPLE
SUPER-KOOL-16	Super-Kool™ Ice Machine Cleaner – 16 oz. Bottle	EA	12
SUPER-KOOL	Super-Kool™ Ice Machine Cleaner – 1 Gallon Container	EA	4

LEAK DETECTORS AND ACCESSORIES

Bubble-N-Trouble™ Freeze Protected Spray-On Leak Detector

Non-corrosive, non-toxic, and biodegradable. Does not attack metal or interfere with brazing or soldering. Spray-on application allows easy access for hard to reach places. Tacking agent holds solution on test surface making Bubble-N-Trouble™ very economical. USDA AUTHORIZED



CATALOG NO.	DESCRIPTION	UOM	ORDER MULTIPLE
BNT-32	Bubble-N-Trouble™ Freeze Protected Leak Detector – 32 oz. Spray	EA	12
BNT-1	Bubble-N-Trouble™ Freeze Protected Leak Detector – 1 Gallon Container	EA	4

Radiant Leak Finder™

Radiant color and viscous clinging formula exposes the smallest leaks. Freeze-protected – remains effective down to 0° F.



CATALOG NO.	DESCRIPTION	UOM	ORDER MULTIPLE
RLF-8	Radiant Leak Finder™ – 8 oz. Container	EA	12

Flash™ Detect UV Leak Detection Kit

Flash™ Detect UV leak detection kit include 3 cans of Flash dye, a reusable clear hose, heavy-duty storage case, and choice of UV light.



CATALOG NO.	DESCRIPTION	UOM	ORDER MULTIPLE
98084KIT	Flash™ Detect with 3 cans, hose, and SEEKERmini™ Worklight	EA	1
98087KIT	Flash™ Detect with 3 cans, hose, and SEEKERmax™ Rechargeable UV Inspection Worklight	EA	1

Pro-Bubble™ Leak Detector

Easy-to-use, high-bubbling, viscoelastic blue leak detector. New improved formula.



CATALOG NO.	DESCRIPTION	UOM	ORDER MULTIPLE
PRO-BUBBLE-32	Pro-Bubble™ Leak Detector – 32 oz. Bottle with Spray Top	EA	12

Flash™ Detect UV Dye

Flash™ Detect Inject (990) is an integrated UV dye solution that injects like Flex Inject® Sealant without the use of tools or manifold gauges. Flash™ Detect (980) travels with the speed of the refrigerant once installed, finding leaks within minutes. Using a patented misting orifice, Flash™ Detect Inject uses the refrigerant as the propellant, ensuring a no-mess injection every time. Can be used with all HFC refrigerants. (20122 reusable hose sold separately for 980).



CATALOG NO.	DESCRIPTION	UOM	ORDER MULTIPLE
980	Flash™ Detect Universal UV Dye - Up to 5 Tons	EA	12
20122	Reusable Hose, Clear for 980	EA	1
990	Flash™ Detect Inject - Up to 6 Tons	EA	6

SEEKERmini™

High powered UV light with 3 AAA batteries included with no UV enhancing glasses required.



CATALOG NO.	DESCRIPTION	UOM	ORDER MULTIPLE
84DCPLUS	SEEKERmini™ UV LED Worklight	EA	1

LEAK DETECTORS AND ACCESSORIES cont'd

SEEKERmax™

High powered UV light with rechargeable 2200 mAh lithium-ion battery with no UV enhancing glasses required. Finds leaks day or night. 4 hours of continuous use.



CATALOG NO.	DESCRIPTION	UOM	ORDER MULTIPLE
87DCPLUS	SEEKERmax™ UV LED Worklight	EA	1

UV Pocket Light

UV Pocket Light with 3 AAA batteries included. A great light to pair with 995 Flex Inject® Sealant and 990 Flash™ Detect Inject.



CATALOG NO.	DESCRIPTION	UOM	ORDER MULTIPLE
89DC	UV Pocket Light	EA	12

Patriot Pocket Worklight

A three light integrated rechargeable system that includes a red top light (30 lumens), 250 lumen front light, and a 390-400nm wavelength UV light. Patriot charger sold separately (111110A).



CATALOG NO.	DESCRIPTION	UOM	ORDER MULTIPLE
111110	Patriot Worklight	EA	6
111110A	Patriot Worklight Charger	EA	6

LEAK SEALANTS

Flex Inject® Sealant Advanced & Total

Flex Inject® Sealant Advanced is the fastest, most effective proven way to permanently seal and prevent minor air conditioning and refrigeration (AC/R) leaks. With no tools or gauges required, the Flex Inject® Sealant Advanced works by travelling through the system with the oil and refrigerant fixing leaks immediately (up to 300 microns). Flex Inject® Sealant Advanced works with all compressors, heat pumps, condensers, and other system components and it will not plug up manifold gauges, metering devices, thermostatic expansion valves (TXVs), pistons or cause cap tube blockages. It meets the ASHRAE ARI 700 refrigerant standard and is compatible with any refrigerant including R-410A with no pump downs or recoveries required. Flex Inject® Sealant Advanced is suitable for use in aluminum and copper coils and is microchannel friendly. Flex Inject® Sealant Total has all the benefits of Advanced and includes UV dye.



CATALOG NO.	DESCRIPTION	UOM	ORDER MULTIPLE
985	Flex Inject® Sealant Advanced	EA	6
995	Flex Inject® Sealant Total	EA	6
999KIT	Flex Inject® and Flash™ Detect Merchandiser Kit Four each of 985, 990, 995 (Case of 12)	EA	1

Super Seal™ Sealant Advanced

Super Seal™ Sealant Advanced includes a stop leak sealant and Dry R™ moisture eliminator. Provides for a fast install with no pump down or recovery, even for R410A. Compatible with all oils and refrigerants. Hose included.



CATALOG NO.	DESCRIPTION	UOM	ORDER MULTIPLE
947KIT	Super Seal™ Sealant Advanced - Up to 1.5 Tons	EA	12
944KIT	Super Seal™ Sealant Advanced - 1.5 to 5 Tons	EA	12
948KIT	Super Seal™ Sealant Advanced - 5+ Tons	EA	1

Super Seal™ Sealant Total

Super Seal™ Sealant Total includes a stop leak sealant, Dry R™ moisture eliminator, and Flash™ UV dye. It offers all the benefits of Super Seal™ Sealant Advanced plus UV dye. Hose included.

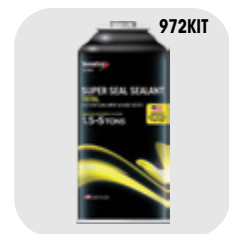

CATALOG NO.	DESCRIPTION	UOM	ORDER MULTIPLE
971KIT	Super Seal™ Sealant Total - Up to 1.5 Tons	EA	12
972KIT	Super Seal™ Sealant Total - 1.5 Tons to 5 Tons	EA	12

Seal-N-Go® Self-Sealing Refrigerant

Seal-N-Go® is an excellent solution for taking R410A refrigerant on job sites and installing Super Seal™ Sealant Advanced. It allows technicians to fill and stop and prevent leaks simultaneously. With a reusable charging hose (sold separately), the 25.7 ounce lightweight cannister is great for topping off multiple systems and perfect for mini-split installs. Reusable charging hose (20133) sold separately.



CATALOG NO.	DESCRIPTION	UOM	ORDER MULTIPLE
9410SSR	Seal-N-Go® 25.7 R410 Refrigerant plus Super Seal™ Sealant Advanced	EA	6
20133	Reusable Charging Hose with Gauge	EA	1

LEAK SEALANTS cont'd

Super Seal™ Sealant Sure Shot

Super Seal™ Sealant Sure Shot includes a stop leak sealant and Eco Boost. Hose and cartridge included.

CATALOG NO.	DESCRIPTION	UOM	ORDER MULTIPLE
983KIT	Super Seal™ Sealant Sure Shot - Up to 6 Tons	EA	12
984	Super Seal™ Sealant Sure Shot - Up to 6 Tons Replacement Cartridge	EA	12



ODOR NEUTRALIZERS

Duct-Fresh™ Gel

A non-toxic, super-effective odor neutralizer for HVAC ducts, proficient at destroying stubborn odors including pet, smoke, and musty smells in residential, industrial and commercial applications. Effective for up to 6 months.



CATALOG NO.	DESCRIPTION	UOM	ORDER MULTIPLE
DUCT-FRESH-8	Duct-Fresh™ Gel – 8 oz.	EA	12
DUCT-FRESH-16	Duct-Fresh™ Gel – 16 oz.	EA	8
DUCT-FRESH-40	Duct-Fresh™ Gel – 40 oz.	EA	8

Duct-Fresh™ Spray

A non-toxic, instantaneous, super-effective odor neutralizer for HVAC ducts. Destroys stubborn pet odors, smoke, and musty smells in residential, industrial and commercial applications. Great for spot-treating malodor problem areas.



CATALOG NO.	DESCRIPTION	UOM	ORDER MULTIPLE
DUCT-FRESH-32	Duct-Fresh™ Spray – 1 Quart	EA	12

The Purifier™

The Purifier™ is an electric device that removes stubborn odors like tobacco smoke. It eliminates mold, mildew and bacteria from HVAC systems, using the latest in ozone purification technology. The Purifier™ completes most jobs in just 20 minutes. Includes programmable timer with LCD display.



CATALOG NO.	DESCRIPTION	UOM	ORDER MULTIPLE
170AIR	The Purifier™ Fresh Air Ozone Machine	EA	1
170AIRFAN	Replacement Fan	EA	1
170AIRPCB	Replacement Circuit Board	EA	1
UVEC-07G	12V Charger for Cigarette Lighter	EA	1
410212	Replacement UV Bulb	EA	1

Odor-Aid™

Cleans and deodorizes with an easy pump spray. Eliminates bacteria, germs and microorganism's offensive odors.



CATALOG NO.	DESCRIPTION	UOM	ORDER MULTIPLE
171AIR	Odor-Aid™ – 7 oz. Bottle with Spray Top	EA	12

REFRIGERATION OILS

Pro-Lube™ Mineral Oil

Specialty Chemical mineral oil (by Calumet) is a superior mineral naphthenic refrigeration oil designed to meet the operating requirements of modern residential and commercial air conditioning and refrigeration compressors. These oils have a low pour point, low wax floc temperature and are chemically and thermally stable in the presence of refrigerants. OEM approved by Copeland, Carlyle, Trane, and other major compressor manufacturers. Always follow compressor manufacturer's oil viscosity recommendations. Mineral oil is specially recommended for lubrication of compressors containing ammonia, R-11, 12, 13, 22, 113, 114, 123, 500 and 502 refrigerants in residential, industrial and commercial service. DO NOT USE WITH HFC REFRIGERANTS SUCH AS R-134A.



CATALOG NO.	DESCRIPTION	UOM	ORDER MULTIPLE
3WF-01	SUS150 ISO32 Pro-Lube™ Mineral Oil – 1 Gallon Jug	EA	4
4WF-01	SUS300 ISO68 Pro-Lube™ Mineral Oil – 1 Gallon Jug	EA	4

Pro-Lube-POE™ Polyolester

Specialty Chemical POE is custom formulated for use in refrigeration compressors. This series contains no ozone depleting substances and is compatible with new HFC refrigerants as well as existing CFC and HCFC refrigerants. POE is also compatible with traditional mineral oil lubricants. Available in several ISO viscosity grades.



CATALOG NO.	DESCRIPTION	UOM	ORDER MULTIPLE
POE32-32	SUS150 ISO32 Pro-Lube-POE™ Polyolester – 1 Quart Can	EA	12
POE32-01	SUS150 ISO32 Pro-Lube-POE™ Polyolester – 1 Gallon Can	EA	6
POE68-32	SUS300 ISO68 Pro-Lube-POE™ Polyolester – 1 Quart Can	EA	12
POE68-01	SUS300 ISO68 Pro-Lube-POE™ Polyolester – 1 Gallon Can	EA	6
POE100-32	SUS500 ISO100 Pro-Lube-POE™ Polyolester – 1 Quart Can	EA	12
POE100-01	SUS500 ISO100 Pro-Lube-POE™ Polyolester – 1 Gallon Can	EA	6

SYSTEM CLEANERS

D'Scale™ Acid Scale Remover for Cooling Towers

D'Scale™ is a low-foaming scale remover that quickly removes scale, corrosion and rust from cooling towers. D'Scale™ has pH indicating dye. The color changes to yellow when acid has been consumed. Each gallon dissolves 3 pounds of scale.



CATALOG NO.	DESCRIPTION	UOM	ORDER MULTIPLE
D-SCALE	D'Scale™ Acid Scale Remover – 1 Gallon Container	EA	4

THREAD SEALANTS

PRO-TITE™ Resin Based Thread Sealant

Resin based thread sealant that adheres to internal surfaces, fills voids while forming a flexible fluid tight seal. Specifically formulated for use on metals and plastics subject to extreme vibration. Serviceable at temperatures from 100°F (73°C) to 400°F (204°C) and from full vacuum to 10,000 PSI. Pro-Tite™ is impervious to most chemicals including refrigerants, petroleum products, gases, steam, etc. Alcohol based.



CATALOG NO.	DESCRIPTION	UOM	ORDER MULTIPLE
CLL-1	Pro-Tite™ Thread Sealant – 1-1/3 oz. Squeeze Tube	EA	12
CLL-4	Pro-Tite™ Thread Sealant – 4 oz. Brush Top	EA	12

ADDITIVES

Acid Eliminator

Keeps acid away; compatible with all refrigerants and oils. Chemically neutralizes and prevents acids that are formed in air conditioning and refrigeration systems due to refrigerant and refrigeration oil break-down, moisture, and compressor burnout. Easy-to-use, no complicated charts. Works fast, circulates quickly, and leaves no solids or solid residuals. Will not harm system components. Can prevent system breakdown.



CATALOG NO.	DESCRIPTION	UOM	ORDER MULTIPLE
ACID-ELIM	Acid Eliminator – 4 oz. Plastic Bottle	EA	12

Pro-Thaw™ Liquid Dryer for Refrigerants

Chemically dries all refrigerants (R-12, R-22, R-134a, etc.), methyl chloride and methylene chloride. Frees up systems frozen due to moisture contamination in 5 minutes and prevents refreezing. Does not contain any dissolved solids, leaves no residue and works with or without solid dryers.



CATALOG NO.	DESCRIPTION	UOM	ORDER MULTIPLE
PRO-THAW-1	Pro-Thaw™ – 1 oz. Plastic Bottle	EA	24
PRO-THAW	Pro-Thaw™ – 4 oz. Plastic Bottle	EA	12

TEST KITS

Acid Test Kit™

Detects acid in refrigeration oil. Convenient, one-step test means no chemicals to mix. Easy to evaluate. Color change indicates acidity; color intensity reveals the amount of acid present in the oil sample.



CATALOG NO.	DESCRIPTION	UOM	ORDER MULTIPLE
ATK-4	Acid Test Kit™, pack of 4	EA	4
ATK-1	Acid Test Kit™	EA	1
ATK-1P	Acid Test Kit™ for POE Oil	EA	1

VACUUM PUMP OIL

Pro-Lube-VAC™ Vacuum Pump Oil

VP-68 Premium Vacuum Pump Oil is now based on a highly refined paraffinic based stock. This new improved formulation is lighter in color and provides better viscosity and oxidation stability than the previous formulation. VP-68 provides excellent cold start performance; formulated to meet minimum moisture content specifications.



CATALOG NO.	DESCRIPTION	UOM	ORDER MULTIPLE
VP68-32	Pro-Lube-VAC™ Vacuum Pump Oil – 1 Quart Jug	EA	12
VP68-01	Pro-Lube-VAC™ Vacuum Pump Oil – 1 Gallon Jug	EA	4
VP68-05	Pro-Lube-VAC™ Vacuum Pump Oil – 5 Gallon Pail	EA	1

Dry R™

DRY R™ enhances the function of driers and metering devices by removing non-condensables, eliminating moisture and ice crystals, and breaking down blockages by removing scale and sludge on moving parts such as TXVs. Dry R™ is compatible with all oils and refrigerants.



CATALOG NO.	DESCRIPTION	UOM	ORDER MULTIPLE
973KIT	Dry R™ Moisture Eliminator - Up to 5 tons	EA	12

Boost Juice® & Boost Juice® Inject

Boost Juice® is an HVAC/R system performance improvement additive that lowers energy costs by reducing the amperage draw up to 22% (testing average of 13%) on a system when running. It lubricates internal components, reducing noise levels, and removes internal moisture.



CATALOG NO.	DESCRIPTION	UOM	ORDER MULTIPLE
992	Boost Juice® Inject - Up to 6 Tons	EA	4
993KIT	Boost Juice® Kit - Up to 6 Tons	EA	6

INLINE COMPONENTS

Access Fittings	168
Brass Fittings.....	170-172
Copper Fittings	165-167
Cushion Clamps	172
Driers, Sight Glasses.....	173-174
Line Piercing Valves and Tools	169
Refrigerant Charging.....	174
Refrigerant Tubing.....	175-178
Refrigerant Labels.....	178
Refrigerant Recovery Products.....	179
Sentry™ Refrigerant Locking Caps	164
Tubing Insulation	179-180



SENTRY™ REFRIGERANT LOCKING CAPS

Sentry™ Refrigerant Locking Caps - R-410, Red, 1/4"

The Sentry™ Refrigerant Locking Caps are quick and easy way to comply with the IRC and IMC codes requirement that all outdoor access ports on A/C and refrigerant equipment have to be tamper resistant. This cap is anodized in red color for easy identification of R-410 refrigerant. It is designed for 1/4" access ports. An O-ring seal is also pre-installed to prevent leaks.

RSC-RED-02



CATALOG NO.	DESCRIPTION	UOM	ORDER MULTIPLE
RSC-RED-02	Sentry™ Refrigerant Locking Caps - 1/4", Red, 2 pcs Pack	PK	1
RSC-RED-04K	Sentry™ Refrigerant Locking Caps - 1/4", Red, 4 pcs Pack w/1 Universal Key	PK	1
RSC-RED-10	Sentry™ Refrigerant Locking Caps - 1/4", Red, 10 pcs Pack	PK	1
RSC-RED-50K	Sentry™ Refrigerant Locking Caps - 1/4", Red, 50 pcs Pack w/2 Universal Keys	PK	1
RSC-RED-500	Sentry™ Refrigerant Locking Caps - 1/4", Red, 50 pcs Pack w/5 Driver Bits	PK	1

Sentry™ Refrigerant Locking Caps - R-410, Red, 5/16"

The Sentry™ Refrigerant Locking Caps are quick and easy way to comply with the IRC and IMC codes requirement that all outdoor access ports on A/C and refrigerant equipment have to be tamper resistant. This cap is anodized in red color for easy identification of R-410 refrigerant. It is designed for 5/16" access ports typically used on mini-splits and European styles of A/C systems. An O-ring seal is also pre-installed to prevent leaks.

RSC-RED-02-E



CATALOG NO.	DESCRIPTION	UOM	ORDER MULTIPLE
RSC-RED-02-E	Sentry™ Refrigerant Locking Caps - 5/16", Red, 2 pcs Pack w/ Universal Key	PK	1
RSC-RED-04K-E	Sentry™ Refrigerant Locking Caps - 5/16", Red, 4 pcs Pack w/1 Universal Key	PK	1
RSC-RED-10-E	Sentry™ Refrigerant Locking Caps - 5/16", Red, 10 pcs Pack	PK	1
RSC-RED-50K-E	Sentry™ Refrigerant Locking Caps - 5/16", Red, 50 pcs Pack w/2 Universal Keys	PK	1

Sentry™ Universal Key for Refrigerant Locking Caps

This Universal Key is not only for DiversiTech's Sentry™ Refrigerant Locking Caps. It has three different keys that is fit to lock and unlock most of the refrigerant locking caps in the market. It is compact and easy to carry. This is the key contractors needed to get the job done!

RSC-TOOL



CATALOG NO.	DESCRIPTION	UOM	ORDER MULTIPLE
RSC-TOOL	Universal Key for Refrigerant Locking Caps	EA	1

Sentry™ Refrigerant Locking Caps - R-22, Green, 1/4"

The Sentry™ Refrigerant Locking Caps are quick and easy way to comply with the IRC and IMC codes requirement that all outdoor access ports on A/C and refrigerant equipment have to be tamper resistant. This cap is anodized in green color for easy identification of R-22 refrigerant. It is designed 1/4" access ports. An O-ring seal is also pre-installed to prevent leaks.

RSC-GRN-02



CATALOG NO.	DESCRIPTION	UOM	ORDER MULTIPLE
RSC-GRN-02	Sentry™ Refrigerant Locking Caps - 1/4", Green, 2 pcs Pack	PK	1
RSC-GRN-04K	Sentry™ Refrigerant Locking Caps - 1/4", Green, 4 pcs Pack w/1 Universal Key	PK	1
RSC-GRN-10	Sentry™ Refrigerant Locking Caps - 1/4", Green, 10 pcs Pack	PK	1
RSC-GRN-50K	Sentry™ Refrigerant Locking Caps - 1/4", Green, 50 pcs Pack w/2 Universal Keys	PK	1

Sentry™ Refrigerant Locking Caps - Universal, Silver, 1/4"

The Sentry™ Refrigerant Locking Caps are quick and easy way to comply with the IRC and IMC codes requirement that all outdoor access ports on A/C and refrigerant equipment have to be tamper resistant. This cap is anodized in silver color and could be used on different types of refrigerants. It is designed for 1/4" access ports. An O-ring seal is also pre-installed to prevent leaks.

RSC-SLV-02



CATALOG NO.	DESCRIPTION	UOM	ORDER MULTIPLE
RSC-SLV-02	Sentry™ Refrigerant Locking Caps - 1/4", Silver, 2 pcs Pack	PK	1
RSC-SLV-04K	Sentry™ Refrigerant Locking Caps - 1/4", Silver, 4 pcs Pack w/1 Universal Key	PK	1
RSC-SLV-10	Sentry™ Refrigerant Locking Caps - 1/4", Silver, 10 pcs Pack	PK	1
RSC-SLV-50K	Sentry™ Refrigerant Locking Caps - 1/4", Silver, 50 pcs Pack w/2 Universal Keys	PK	1
RSC-SLV-500	Sentry™ Refrigerant Locking Caps - 1/4", Silver, 500 pcs Pack w/5 Driver Bits	PK	1



COPPER FITTINGS

Male Adapter C x M

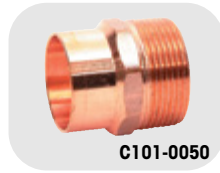

CATALOG NO.	O.D. SIZE	I.D. SIZE	UOM	ORDER MULTIPLE
C101-0050	5/8" x 1/2"	1/2" x 1/2"	EA	25
C101-0100	7/8" x 3/4"	3/4" x 3/4"	EA	25
C101-0150	1-1/8" x 1"	1" x 1"	EA	10

Female Adapter C x F



CATALOG NO.	O.D. SIZE	I.D. SIZE	UOM	ORDER MULTIPLE
C105-0057	5/8" x 3/4"	1/2" x 3/4"	EA	25
C105-0100	7/8" x 3/4"	3/4" x 3/4"	EA	25
C105-0150	1-1/8" x 1"	1" x 1"	EA	10
C105-0215	1-3/8" x 1-1/4"	1-1/4" x 1-1/4"	EA	10

90 Degree Ell C x C



CATALOG NO.	O.D. SIZE	I.D. SIZE	UOM	ORDER MULTIPLE
C235-0002	3/8"	1/4"	EA	25
C235-0025	1/2"	3/8"	EA	25
C235-0050	5/8"	1/2"	EA	25
C235-0090	3/4"	5/8"	EA	25
C235-0100	7/8"	3/4"	EA	25
C235-0150	1-1/8"	1"	EA	10
C235-0215	1-3/8"	1-1/4"	EA	10

90 Degree Long Turn Street Ell Ftg. x C



CATALOG NO.	O.D. SIZE	I.D. SIZE	UOM	ORDER MULTIPLE
C272-0002	3/8"	1/4"	EA	25
C272-0025	1/2"	3/8"	EA	25
C272-0050	5/8"	1/2"	EA	25
C272-0090	3/4"	5/8"	EA	25
C272-0100	7/8"	3/4"	EA	10
C272-0150	1-1/8"	1"	EA	10
C272-0215	1-3/8"	1-1/4"	EA	10

90 Degree Street Ell Ftg. x C



CATALOG NO.	O.D. SIZE	I.D. SIZE	UOM	ORDER MULTIPLE
C254-0002	3/8"	1/4"	EA	25
C254-0100	7/8"	3/4"	EA	25
C254-0150	1-1/8"	1"	EA	10

45 Degree Ell C x C



CATALOG NO.	O.D. SIZE	I.D. SIZE	UOM	ORDER MULTIPLE
C290-0002	3/8"	1/4"	EA	25
C290-0025	1/2"	3/8"	EA	25
C290-0050	5/8"	1/2"	EA	25
C290-0090	3/4"	5/8"	EA	25
C290-0100	7/8"	3/4"	EA	25
C290-0150	1-1/8"	1"	EA	10
C290-0215	1-3/8"	1-1/4"	EA	60

COPPER FITTINGS cont'd

90 Degree Long Turn Ell C x C



CATALOG NO.	O.D. SIZE	I.D. SIZE	UOM	ORDER MULTIPLE
C242-0001	1/4"	1/8"	EA	25
C242-0002	3/8"	1/4"	EA	25
C242-0025	1/2"	3/8"	EA	25
C242-0050	5/8"	1/2"	EA	25
C242-0090	3/4"	5/8"	EA	25
C242-0100	7/8"	3/4"	EA	10
C242-0150	1-1/8"	1"	EA	10
C242-0215	1-3/8"	1-1/4"	EA	35
C242-0295	1-5/8"	1-1/2"	EA	25
C242-0390	2-1/8"	2"	EA	12

Coupling (Socket) with Rolled Tube Stop C x C



CATALOG NO.	O.D. SIZE	I.D. SIZE	UOM	ORDER MULTIPLE
C165-0001	1/4"	1/8"	EA	25
C165-0002	3/8"	1/4"	EA	25
C165-0025	1/2"	3/8"	EA	25
C165-0050	5/8"	1/2"	EA	25
C165-0090	3/4"	5/8"	EA	25
C165-0100	7/8"	3/4"	EA	25
C165-0150	1-1/8"	1"	EA	10
C165-0215	1-3/8"	1-1/4"	EA	10
C165-0295	1-5/8"	1-1/2"	EA	60
C165-0390	2-1/8"	2"	EA	40

Reducer Coupling w/Stop C x C



CATALOG NO.	O.D. SIZE	I.D. SIZE	UOM	ORDER MULTIPLE
C165-0007	3/8" x 1/4"	1/4" x 1/8"	EA	25
C165-0032	1/2" x 3/8"	3/8" x 1/4"	EA	25
C165-0058	5/8" x 1/2"	1/2" x 3/8"	EA	25
C165-0093	3/4" x 5/8"	5/8" x 1/2"	EA	25
C165-0107	7/8" x 5/8"	3/4" x 1/2"	EA	25
C165-0149	7/8" x 3/4"	3/4" x 5/8"	EA	25
C165-0159	1-1/8" x 7/8"	1" x 3/4"	EA	10
C165-1498	1-1/8" x 3/4"	1" x 5/8"	EA	10
C165-0222	1-3/8" x 1-1/8"	1-1/4" x 1"	EA	10
C165-0223	1-3/8" x 7/8"	1-1/4" x 3/4"	EA	10
C165-0304	1-5/8" x 1-1/8"	1-1/2" x 1"	EA	10

45 Degree Street Ell Ftg. x C



CATALOG NO.	O.D. SIZE	I.D. SIZE	UOM	ORDER MULTIPLE
C295-0002	3/8"	1/4"	EA	25
C295-0090	3/4"	5/8"	EA	25
C295-0100	7/8"	3/4"	EA	25
C295-0150	1-1/8"	1"	EA	10

Fitting Reducer Coupling Ftg. x C



CATALOG NO.	O.D. SIZE	I.D. SIZE	UOM	ORDER MULTIPLE
C410-0032	1/2" x 3/8"	3/8" x 1/4"	EA	25
C410-0058	5/8" x 1/2"	1/2" x 3/8"	EA	25
C410-0093	3/4" x 5/8"	5/8" x 1/2"	EA	25
C410-0107	7/8" x 5/8"	3/4" x 1/2"	EA	25
C410-0149	7/8" x 3/4"	3/4" x 5/8"	EA	25
C410-0159	1-1/8" x 7/8"	1" x 3/4"	EA	10
C410-0222	1-3/8" x 1-1/8"	1-1/4" x 1"	EA	10

Cap



CATALOG NO.	O.D. SIZE	I.D. SIZE	UOM	ORDER MULTIPLE
C154-0100	7/8"	3/4"	EA	25

U-Type Strap



CATALOG NO.	O.D. SIZE	I.D. SIZE	UOM	ORDER MULTIPLE
C947-0025	1/2"	3/8"	EA	25
C947-0050	5/8"	1/2"	EA	25
C947-0100	7/8"	3/4"	EA	25
C947-0150	1-1/8"	1"	EA	25
C947-0215	1-3/8"	1-1/4"	EA	100
C947-0295	1-5/8"	1-1/2"	EA	100
C947-0390	2-1/8"	2"	EA	50

Copper Coupling with No Stop



CATALOG NO.	O.D. SIZE	I.D. SIZE	UOM	ORDER MULTIPLE
C172-0090	3/4"	5/8"	EA	25
C172-0100	7/8"	3/4"	EA	25
C172-0150	1-1/8"	1"	EA	10
C172-0215	1-3/8"	1-1/4"	EA	10

P-Traps



CATALOG NO.	O.D. SIZE	I.D. SIZE	UOM	ORDER MULTIPLE
C533-0050	5/8"	1/2"	EA	5
C533-0150	1-1/8"	1"	EA	3

Copper Coupling w/Dimple Stop



CATALOG NO.	O.D. SIZE	I.D. SIZE	UOM	ORDER MULTIPLE
C170-0003	5/16"	1/4"	EA	25

Tee C x C x C



CATALOG NO.	O.D. SIZE	I.D. SIZE	UOM	ORDER MULTIPLE
C460-0002	3/8"	1/4"	EA	25
C460-0025	1/2"	3/8"	EA	25
C460-0050	5/8"	1/2"	EA	25
C460-0090	3/4"	5/8"	EA	25
C460-0100	7/8"	3/4"	EA	10
C460-0150	1-1/8"	1"	EA	10

ACCESS FITTINGS

A convenient low-cost port for refrigeration servicing. May be installed in any position on either high or low side for charging, purging, quick testing or pressure checking. DiversiTech's access fittings have 1/4" SAE male flare access ports and include a quick seal cap and a stainless and brass special refrigerant valve core.

CATALOG NO.	DESCRIPTION	CONNECTION	QTY PER PACK	UOM	ORDER MULT.
VA-3-346	3 Way Solder Type, pack of 6	For 3/16" O.D. tube or 1/4" and 3/8" solder fitting	6	PK	1
VA-34	Straight Solder Type, pack of 6	3/16" O.D.S. x 1/4" O.D.F.	6	PK	1
VA-46	Straight Solder Type, pack of 6	1/4" O.D.S. x 3/8" O.D.F.	6	PK	1
VA-68	Straight Solder Type, pack of 6	3/8" O.D.S. x 1/2" O.D.F.	6	PK	1
VAU-24	Half Union, pack of 6	1/8" MPT	6	PK	1
VAU-45	Half Union, pack of 6	1/4" MPT	6	PK	1
VAX-2	Extended Copper Tube	1/8" O.D. tube	6	PK	1
VAX-3	Extended Copper Tube	3/16" O.D. x 1/8" I.D.	6	PK	1
VAX-4	Extended Copper Tube	1/4" O.D. x 3/16" I.D.	6	PK	1
VAX-5	Extended Copper Tube	5/16" O.D. x 1/4" I.D.	3	PK	1
VAX-6	Extended Copper Tube	3/8" O.D. x 5/16" I.D.	3	PK	1
VAX-8	Extended Copper Tube	1/2" O.D.	3	PK	1
VS-4	Swivel Nut w/Depressor, pack of 6	1/4" female flare forged swivel nut	6	PK	1
VST-4	Swivel Tee w/Permanent Depressor, pack of 3	1/4" Access on run x 1/4" female flare w/depressor on female swivel branch end	3	PK	1
VST-44	Swivel Tee w/Perm. Depressor, pack of 3	1/4" Access on run x 1/4" access on "T" - female swivel on run	3	PK	1
VTR-24	Threaded Tee, pack of 3	1/8" MPT x 1/4" male flare on run x access on branch	3	PK	1
VTS-10	Solder Tee Type	5/8" O.D. tube	1	EA	1
VTS-12	Solder Tee Type	3/4" O.D. tube	1	EA	1
VTS-14	Solder Tee Type	7/8" O.D. tube	1	EA	1
VTS-46	Solder Tee Type, pack of 3	1/4" O.D.S. x 5/16" O.D.F.	3	PK	1
VTS-56	Solder Tee Type, pack of 3	5/16" O.D.S. x 3/8" O.D.F.	3	PK	1
VTS-68	Solder Tee Type, pack of 3	3/8" O.D.S.	3	PK	1
VTS-810	Solder Tee Type, pack of 3	1/2" O.D.S.	3	PK	1
VC-4	Flare Cap, pack of 12	1/4"	12	PK	1
VC-4R	Flare Cap w/Core Remover, pack of 12	1/4"	12	PK	1
VVC-1	Valve Core, pack of 6		6	PK	1



Brass Adapters

The MSA-45 is used on the new R410 Mini Split systems that have the larger unique fitting on the service valve. The description of that fitting is 1/2" acme Male-20 UN. This adapter will screw onto the 1/2" Acme Male-20 UN fitting and allow you to connect a standard 1/4 service hose to it.



MSA-45

CATALOG NO.	DESCRIPTION	UOM	ORDER MULTIPLE
MSA-45	1/4" Male flare x 1/2" - 20 UNF Female	EA	1

Cop-Cap™ Locking Valve Cover

An effective way to discourage and prevent the removal of refrigerant. COP-CAP™ fits this standard service valve on all central AC units and mini-splits. It helps prevent access by unauthorized persons and can only be removed with the included special tool. Simply thread COP-CAP™ assembly onto existing 1/4" flare connection on system and lock set screw in place with hex wrench provided.



VCC-4

- Seals service valve to prevent leaks
- Prevents illegal venting or theft of refrigerant
- Stops unauthorized access in unsecured areas

CATALOG NO.	DESCRIPTION	UOM	ORDER MULTIPLE
VCC-4	Cop-Cap™, Pack of 2	PK	1
VCC-4B	Cop-Cap™ bulk, 100 per case	EA	100

LINE PIERCING VALVES AND TOOLS

Quick-Tap

Features a valve core in the 1/4" male port. Simply pierce the line and back seat the needle. Flow starts when depressor type charging hose is connected. Flow shuts off automatically when hose is removed. If valve core is not desired, it may be removed. Connect hose, pierce line and back seat needle. This method offers full unrestricted flow. Valve core can be removed or changed at any time without loss of refrigerant if needle is front seated.

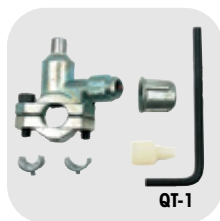

CATALOG NO.	DESCRIPTION	UOM	ORDER MULTIPLE
QT-1	Quick-Tap – 1/4", 5/16", 3/8" O.D. Tube Size	EA	1
QT-2	Quick-Tap – 1/2", 5/8" O.D. Tube Size	EA	1

MAC—The Ultimate in Line Piercing Valves

Install valve. Connect charging hose. Service. That's all there is to it! MAC features uniport: 1 connection for piercing and servicing. Sealed with refrigerant resistant "O" rings. Needle automatically back seats after servicing, leaving line free of restriction. Connect to tubing with 2 socket-head screws. (Hex wrench is included with each valve.) Needle depressor is inserted into head of needle. Wing cap is turned down easily by hand until line is pierced. Wing cap is removed and system may be serviced with any charging hose with built-in depressor. When hose is removed, spring loaded needle back-seats forming a leak proof seal. Needle depressor is discarded and wing cap forms extra precautionary seal.



CATALOG NO.	DESCRIPTION	UOM	ORDER MULTIPLE
QTM-1	MAC Line Piercing Valve – 1/4", 5/16", 3/8" O.D. Tube Size	EA	36
QTM-2	MAC Line Piercing Valve – 1/2", 5/8" O.D. Tube Size	EA	36

Copper Saddle Valve

For copper-to-copper brazing. Penetrates line in one easy operation with no holes to drill. Steel pin with valve core pierces line and is locked into valve body by tightening cap. Teflon ring assures positive seal. Available in sizes from 1/4" to 1-1/8".



CATALOG NO.	DESCRIPTION	UOM	ORDER MULTIPLE
VLC-4	Copper Saddle Valve – 1/4" O.D. Tube Size, pack of 6	PK	1
VLC-5	Copper Saddle Valve – 5/16" O.D. Tube Size, pack of 6	PK	1
VLC-6	Copper Saddle Valve – 3/8" O.D. Tube Size, pack of 6	PK	1
VLC-8	Copper Saddle Valve – 1/2" O.D. Tube Size, pack of 4	PK	1
VLC-10	Copper Saddle Valve – 5/8" O.D. Tube Size, pack of 3	PK	1
VLC-12	Copper Saddle Valve – 3/4" O.D. Tube Size, pack of 2	PK	1
VLC-18	Copper Saddle Valve – 1-1/8" O.D. Tube Size, pack of 2	PK	1
VLC-25	Additional Teflon Rings, pack of 25	PK	1

Quick-Tap-2

Identical to Quick-Tap except that a nylon handle replaces the hex wrench. Phillips-head screws are used.



CATALOG NO.	DESCRIPTION	UOM	ORDER MULTIPLE
QTH-1	Quick-Tap-2 – 1/4", 5/16", 3/8" O.D. Tube Size	EA	1
QTH-2	Quick-Tap-2 – 1/2", 5/8" O.D. Tube Size	EA	1

Insta-Tap Refrigerant Recovery Tool

The fastest, easiest way to evacuate refrigerant before disposal of a unit. Snaps onto refrigerant line for full and immediate flow. Punctures super large hole for maximum full flow discharge to recovery unit. One tool fits all sizes from 3/16" to 7/8" O.D. hard tubing. Replaceable needle.



CATALOG NO.	DESCRIPTION	UOM	ORDER MULTIPLE
QT-100	Quick-Tap-2 – 1/4", 5/16", 3/8" O.D. Tube Size	EA	1
QT-100N	Replaceable Hardened Steel Needle and Gasket	EA	1
QT-100G	Replacement Gasket Only	EA	3

Core Storer

All steel valve core remover and storage container. Completely knurled for easier grip, eliminating slippage when using with oily or greasy hands. Core Storer features a compartment for storing extra valve cores. Four replacement cores are included with each tool.



CATALOG NO.	DESCRIPTION	UOM	ORDER MULTIPLE
VCR-1	Core Remover and Storer	EA	1

Core Removal Tool

Designed to remove and replace valve cores without losing the refrigerant charge. Connects to any 1/4" male flare fitting. Saves time, saves refrigerant.



CATALOG NO.	DESCRIPTION	UOM	ORDER MULTIPLE
VCR-1	Core Removal Tool	EA	1

BRASS FITTINGS

Compression Sleeve



CATALOG NO.	DESCRIPTION	UOM	ORDER MULTIPLE
D60A-4	1/4" Compression Sleeve	EA	100
D60A-8	1/2" Compression Sleeve	EA	100
D60A-10	5/8" Compression Sleeve	EA	100

Compression Connector



CATALOG NO.	DESCRIPTION	UOM	ORDER MULTIPLE
D68A-4B	1/4" x 1/4" Compression Connector	EA	10
D68A-6C	3/8" x 3/8" Compression Connector	EA	10

Compression Nut



CATALOG NO.	DESCRIPTION	UOM	ORDER MULTIPLE
D61A-4	1/4" Compression Nut	EA	10
D61A-8	1/2" Compression Nut	EA	10

Compression Elbow



CATALOG NO.	DESCRIPTION	UOM	ORDER MULTIPLE
D69A-4A	1/4" x 1/8" Compression Elbow	EA	10
D69A-8D	1/2" x 1/2" Compression Elbow	EA	10

Compression Union



CATALOG NO.	DESCRIPTION	UOM	ORDER MULTIPLE
D62A-44	1/4" Compression Union	EA	10
D62A-66	3/8" Compression Union	EA	10
D62A-88	1/2" Compression Union	EA	10
D62A-1010	5/8" Compression Union	EA	10

Compression Tee



CATALOG NO.	DESCRIPTION	UOM	ORDER MULTIPLE
D64A-44	1/4" Compression Tee	EA	10
D64A-66	3/8" Compression Tee	EA	10
D64A-88	1/2" Compression Tee	EA	10
D64A-1010	5/8" Compression Tee	EA	10

Flare x MIP Elbow



CATALOG NO.	DESCRIPTION	UOM	ORDER MULTIPLE
DE1-4B	1/4" Flare x 1/4" MIP Elbow	EA	10
DE1-6C	3/8" Flare x 3/8" MIP Elbow	EA	10
DE1-8D	1/2" Flare x 1/2" MIP Elbow	EA	10

Flare x MIP Reducing Elbow



CATALOG NO.	DESCRIPTION	UOM	ORDER MULTIPLE
DE1-6B	3/8" Flare x 1/4" MIP Reducing Elbow	EA	10
DE1-6D	3/8" Flare x 1/2" MIP Reducing Elbow	EA	10
DE1-8E	1/2" Flare x 3/4" MIP Reducing Elbow	EA	10
DE1-10D	5/8" Flare x 1/2" MIP Reducing Elbow	EA	10

Short Nut



CATALOG NO.	DESCRIPTION	UOM	ORDER MULTIPLE
DN1-3	3/16" Short Nut	EA	10
DN1-4	1/4" Short Nut	EA	10
DN1-6	3/8" Short Nut	EA	10
DN1-10	5/8" Short Nut	EA	10

Flare Tee



CATALOG NO.	DESCRIPTION	UOM	ORDER MULTIPLE
DT2-4	1/4" Flare Tee	EA	10
DT2-6	3/8" Flare Tee	EA	10
DT2-8	1/2" Flare Tee	EA	10
DT2-10	5/8" Flare Tee	EA	5

Cap



CATALOG NO.	DESCRIPTION	UOM	ORDER MULTIPLE
DN5-4	1/4" Cap	EA	10
DN5-6	3/8" Cap	EA	10

Flare x MIP Union

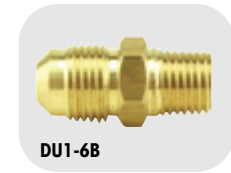

CATALOG NO.	DESCRIPTION	UOM	ORDER MULTIPLE
DU1-4B	1/4" Flare x 1/4" MIP Union	EA	10
DU1-6B	3/8" Flare x 1/4" MIP Union	EA	10
DU1-6C	3/8" Flare x 3/8" MIP Union	EA	10
DU1-6D	3/8" Flare x 1/2" MIP Union	EA	10
DU1-6E	3/8" Flare x 3/4" MIP Union	EA	10
DU1-8B	1/2" Flare x 1/4" MIP Union	EA	10
DU1-8D	1/2" Flare x 1/2" MIP Union	EA	10
DU1-8E	1/2" Flare x 3/4" MIP Union	EA	10
DU1-10D	5/8" Flare x 1/2" MIP Union	EA	10
DU1-10E	5/8" Flare x 3/4" MIP Union	EA	10
DU1-12D	3/4" Flare x 1/2" MIP Union	EA	10

Short Forged Flare Nut



CATALOG NO.	DESCRIPTION	UOM	ORDER MULTIPLE
DNS4-4	1/4" Short Forged Flare Nut	EA	10
DNS4-6	3/8" Short Forged Flare Nut	EA	10
DNS4-8	1/2" Short Forged Flare Nut	EA	10
DNS4-10	5/8" Short Forged Flare Nut	EA	10
DNS4-12	3/4" Short Forged Flare Nut	EA	10
DNS4-14	7/8" Short Forged Flare Nut	EA	5

Flare Union

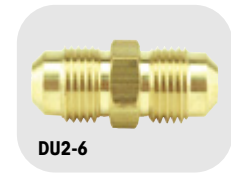

CATALOG NO.	DESCRIPTION	UOM	ORDER MULTIPLE
DU2-4	1/4" Flare Union	EA	10
DU2-6	3/8" Flare Union	EA	10
DU2-8	1/2" Flare Union	EA	10
DU2-10	5/8" Flare Union	EA	10
DU2-12	3/4" Flare Union	EA	10

Plug



CATALOG NO.	DESCRIPTION	UOM	ORDER MULTIPLE
DP2-4	1/4" Plug	EA	10
DP2-6	3/8" Plug	EA	10
DP2-8	1/2" Plug	EA	10
DP2-10	5/8" Plug	EA	10

BRASS FITTINGS cont'd

Flare x FIP Union



CATALOG NO.	DESCRIPTION	UOM	ORDER MULTIPLE
DU3-6D	3/8" x 1/2" Flare x FIP Union	EA	10
DU3-10E	5/8" x 3/4" Flare x FIP Union	EA	10

Flare x Flare Swivel Union

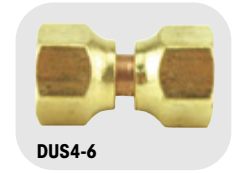

CATALOG NO.	DESCRIPTION	UOM	ORDER MULTIPLE
DUS4-4	1/4" Flare x 1/4" Flare Swivel Union	EA	10
DUS4-6	3/8" Flare x 3/8" Flare Swivel Union	EA	10

CUSHION CLAMPS

Cushion Clamps

An industry standard universal clamp that mounts to standard strut. Steel with electro-dichromate finish to resist corrosion. The lock nut has a nylon insert for a positive lock. The polymeric grommet withstands temperatures from -25°C to 125°C and resists the effects of most oils, chemicals, and industrial cleaning compounds.



CATALOG NO.	DESCRIPTION	UOM	ORDER MULTIPLE
538-1/4	Cushion Clamp – 1/4"	EA	25
538-3/8	Cushion Clamp – 3/8"	EA	25
538-1/2	Cushion Clamp – 1/2"	EA	25
538-5/8	Cushion Clamp – 5/8"	EA	25
538-3/4	Cushion Clamp – 3/4"	EA	25
538-7/8	Cushion Clamp – 7/8"	EA	25
538-1-1/8	Cushion Clamp – 1-1/8"	EA	10
538-1-3/8	Cushion Clamp – 1-3/8"	EA	10
538-1-5/8	Cushion Clamp – 1-5/8"	EA	10
538-2-1/8	Cushion Clamp – 2-1/8"	EA	10
538-2-5/8	Cushion Clamp – 2-5/8"	EA	10
538-3-1/8	Cushion Clamp – 3-1/8"	EA	10
538-4-1/8	Cushion Clamp – 4-1/8"	EA	10

Liquid Line Driers

High moisture and acid capacity. Maximum filtration capacity. Exceptional compatibility with new polyester oils. Compatible with all existing and new refrigerants and blends including 134a, 401A/B, 402A/B, 404A, 407A/B/C, 410A, 502, 507A. Spring loaded, molecular sieve XH-9 dessiccant. Solid copper sweat fittings. Powder paint exterior coating surpasses 500 hour ASTM salt spray test and resists corrosion. Eliminates concern of additive stripping.



Suction Line Driers

The solid-core clean-up dryer was developed for use in a system suction line. The compact design incorporates a large outside diameter shell, which results in a shorter lay-in length, and a larger core, which provides a greater filtration area for maximum operating efficiency. The core material has controlled porosity which effectively removes and holds a maximum amount of contaminants with a minimum of pressure drop. It collects and holds inorganic acids and other harmful contaminants from a motor burnout. This binding process protects the core from acid decomposition. Access valves on both the inlet and outlet sides make it easy to measure pressure accurately. Occasionally, enough contaminant matter may collect in the filter core to cause a slight pressure drop. The access valves on the SLD make it easy to determine if a pressure drop exists and to measure the amount of the drop. The original DSLD, solid core, XH-9 molecular sieve dessiccant suction line filter dryer. High acid capacity. Low pressure drop – exceptionally high flow rates. Designed for system clean-up. 500 hours salt spray protection. Shortest system cut-out lengths allow installation in tight areas. Two access valves simplify pressure drop measurement. Flare or solid copper sweat fittings.



CATALOG NO.	VIRGINIA KMP	CONNECTION	CUBIC INCH	UOM	ORDER MULTIPLE
DAD032	WLD-032 FLARE	1/4	3	EA	1
DAD032S	WLD-032 SWEAT	1/4	3	EA	1
DAD052	WLD-052 FLARE	1/4	5	EA	1
DAD052S	WLD-052 SWEAT	1/4	5	EA	1
DAD053S	WLD-053 SWEAT	3/8	5	EA	1
DAD082	WLD-082 FLARE	1/4	8	EA	1
DAD082S	WLD-082 SWEAT	1/4	8	EA	1
DAD083S	WLD-083 SWEAT	3/8	8	EA	1
DAD084S	WLD-084 SWEAT	1/2	8	EA	1
DAD163	WLD-163 FLARE	3/8	16	EA	1
DAD163S	WLD-163 SWEAT	3/8	16	EA	1
DAD164S	WLD-164 SWEAT	1/2	16	EA	1
DAD303	WLD303 FLARE	3/8	30	EA	1
DAD303S	WLD-303 SWEAT	3/8	30	EA	1
DAD304S	WLD-304 SWEAT	1/2	30	EA	1
DAD305	WLD-305 FLARE	5/8	30	EA	1

CATALOG NO.	VIRGINIA KMP	CONNECTION	CUBIC INCH	UOM	ORDER MULTIPLE
DSL13-5SVHH	AL-24-55C Sweat	5/8	13	EA	1
DSL13-6SVHH	AL-30-6SC Sweat	3/4	13	EA	1
DSL27-7SVHH	AL-30-7SC Sweat	7/8	27	EA	1
DSL27-9SVHH	AL-44-9SC Sweat	1-1/8	27	EA	1

Universal Spun Copper Driers

Manufactured with the latest generation molecular sieves compatible with more than 20 different types of refrigerants, including R-134A. They can be used in all hermetic and open refrigeration systems using CFC, HCFC and HFC gases and mixes such as commercial and domestic refrigerators, freezers and air conditioners ranging from 1/8 to 2.0 HP. Hermetically sealed with extended ends.

CATALOG NO.	OUTLET	INLET	DIAMETER	LENGTH GRAMS	DESSICCANT R12	RECOMM. R22	TONNAGE QUANTITY	UOM	ORDER MULTIPLE
DX-3	1/4"	1/4"	3/4"	7-11/16"	10	1/3	1/2	EA	24
DX-4	Multiple	1/4"	1"	9"	18	3/4	1-1/2	EA	1
DXA-5	1/4"	1/4"	1"	9-1/4"	20	3/4	1-1/2	EA	1



DRIERS, SIGHT GLASSES cont'd

Bi Flow Driers

The "DBF" Series is designed specifically for heat pump or reverse cycle application. External check valves are not required since they are incorporated within the filter dryer shell. The core design filters out contaminant particles down to 25 microns. 100% copper sweat or nickel plated flare fittings. Desiccant core provides reliable and effective, removal of solid contaminants, acid and moisture. Provides three times the filtration as the standard bi-flow. Core is cushioned in fiber gaskets to protect core and to insure trouble-free performance. Powder paint exterior coating surpasses 500 hour ASTM salt spray test and resists corrosion.



DBF163S

CATALOG NO.	VIRGINIA KMP	CONNECTION	CUBIC INCH	UOM	ORDER MULTIPLE
DBF083S	V2A-083 Sweat	3/8	8	EA	1
DBF084S	V2A-084 Sweat	1/2	8	EA	1
DBF163	V2A-163 Flare	3/8	16	EA	1
DBF163S	V2A-163 Sweat	3/8	16	EA	1
DBF164S	V2A-164 Sweat	1/2	16	EA	1
DBF165S	V2A-165S Sweat	5/8	16	EA	1

Sight Glasses

Sight Glass and Moisture Indicator provides a quick visual diagnosis of refrigerant and moisture levels within a system. The sight glass indicates if the system has the proper refrigerant level, a restricted dryer or excessive pressure-drop. The moisture indicator recognizes moisture within the system. Provides early warning that a potential failure exists resulting in corrosion, chemical damage, restricted flow, or even compressor failure. Etch-resistant glass with a simple color comparison provides easy viewing and quick diagnostics. Flare models feature forged brass body and fittings for corrosion resistance. Sweat models feature copper fittings to permit solder installation without disassembly. Leak-proof design is compact and short in length to easily fit within a unit and provide accuracy in performance.



DPSG-2S

CATALOG NO.	VIRGINIA KMP	DESCRIPTION	CONNECTION	UOM	ORDER MULTIPLE
DPSG-3MF	LDE-3-MF	MALE/FEMALE	3/8	EA	1
DPSG-2S	LDE-2-S	SWEAT	1/4	EA	1
DPSG-3S	LDE-3-S	SWEAT	3/8	EA	1

REFRIGERANT CHARGING

Insta-Charge

Faster, safer and more economical method for charging LIQUID refrigerant through the low pressure side of an air conditioning or refrigeration system, without damaging the compressor. Insta-Charge's unique internal restrictor reduces liquid flow to a level below the capacity of the compressor. Converts liquid refrigerant to a saturated vapor for fast entry. Insta-Charge connects directly to the refrigerant can or cylinder valve. Adds liquid tracing dye faster. Eliminates heating of refrigerant cylinder. Made of light weight aluminum. Sold at a fraction of the cost of other fast charging devices.



RC-1

CATALOG NO.	DESCRIPTION	UOM	ORDER MULTIPLE
RC-1	Insta-Charge	EA	1

REFRIGERANT TUBING

DiversiTech Line Sets

DiversiTech Line Sets are individually packaged in sturdy corrugated cardboard, designed and tested for individual parcel shipment.

Line Sets are designed for air conditioning and refrigeration systems. The copper tube is refrigeration grade tubing to ASTM B280. The suction line is pre-insulated with Armaflex AP pipe insulation. This insulation is a black flexible elastomeric thermal insulation. The expanded closed-cell structure makes it an efficient insulation. It is manufactured without the use of CFC's, HFC's or HCFC's. AP Armaflex contains Microban® antimicrobial product protection for added defense against mold on the insulation. DiversiTech Min-Split Line Sets are similar to Standard

Line Sets but come with additional insulation on the liquid line and flared line ends. Copper tubing complies with ASTM B280 for Seamless Copper Tube for ACR.

AP Armaflex insulation meets ASTM C534, Type I – Tubular Grade 1, ASTM E84, NFPA 255, UL723, CAN/ULC S102, UL94 5V-5A, V-0 (E55798), NFPA 90A/90B, UL181, ASTM G21/C1338, ASTM G22, ASTM D1056 2B1, MIL-P-15280J form T, MIL-C-3133C grade SB E3, MEA 96-85-M, and City of LA RR7642.



STANDARD LINE SETS

CATALOG NO.	LENGTH (FT)	INSULATION WALL	SUCTION LINE	LIQUID LINE	UOM	ORDER MULTIPLE
D61220250	25	1/2	3/4	3/8	EA	1
D61220300	30	1/2	3/4	3/8	EA	1
D61220350	35	1/2	3/4	3/8	EA	1
D61220400	40	1/2	3/4	3/8	EA	1
D61220500	50	1/2	3/4	3/8	EA	1
D61230250	25	3/4	3/4	3/8	EA	1
D61230400	40	3/4	3/4	3/8	EA	1
D61230500	50	3/4	3/4	3/8	EA	1
D61280250	25	3/8	3/4	3/8	EA	1
D61280300	30	3/8	3/4	3/8	EA	1
D61280350	35	3/8	3/4	3/8	EA	1
D61280400	40	3/8	3/4	3/8	EA	1
D61280500	50	3/8	3/4	3/8	EA	1
D61420250	25	1/2	7/8	3/8	EA	1
D61420300	30	1/2	7/8	3/8	EA	1
D61420350	35	1/2	7/8	3/8	EA	1
D61420400	40	1/2	7/8	3/8	EA	1
D61420500	50	1/2	7/8	3/8	EA	1
D61430300	30	3/4	7/8	3/8	EA	1
D61430350	35	3/4	7/8	3/8	EA	1
D61430400	40	3/4	7/8	3/8	EA	1
D61430500	50	3/4	7/8	3/8	EA	1
D61480250	25	3/8	7/8	3/8	EA	1
D61480300	30	3/8	7/8	3/8	EA	1
D61480350	35	3/8	7/8	3/8	EA	1
D61480400	40	3/8	7/8	3/8	EA	1
D61480500	50	3/8	7/8	3/8	EA	1
D61820250	25	3/8	1-1/8	1/2	EA	1
D61820500	50	3/8	1-1/8	1/2	EA	1
D61830250	25	3/4	1-1/8	3/8	EA	1
D61830300	30	3/4	1-1/8	3/8	EA	1
D61830350	35	3/4	1-1/8	3/8	EA	1
D61830400	40	3/4	1-1/8	3/8	EA	1
D61880250	25	3/8	1-1/8	3/8	EA	1
D61880300	30	3/8	1-1/8	3/8	EA	1
D61880400	40	3/8	1-1/8	3/8	EA	1
D61880500	50	3/8	1-1/8	3/8	EA	1
D61210250	25	1	3/4	3/8	EA	1
D61210300	30	1	3/4	3/8	EA	1
D61210350	35	1	3/4	3/8	EA	1
D61210400	40	1	3/4	3/8	EA	1
D61210500	50	1	3/4	3/8	EA	1
D61410250	25	1	7/8	3/8	EA	1
D61410300	30	1	7/8	3/8	EA	1
D61410350	35	1	7/8	3/8	EA	1
D61410400	40	1	7/8	3/8	EA	1
D61410500	50	1	7/8	3/8	EA	1
D61810250	25	1	1-1/8	3/8	EA	1
D61810400	40	1	1-1/8	3/8	EA	1
D61810500	50	1	1-1/8	3/8	EA	1

MINI-SPLIT LINE SETS

CATALOG NO.	LENGTH (FT)	INSULATION WALL	SUCTION LINE	LIQUID LINE	UOM	ORDER MULTIPLE
D40680250B3B6	25	3/8	3/8	1/4	EA	1
D40680350B3B6	35	3/8	3/8	1/4	EA	1
D40680500B3B6	50	3/8	3/8	1/4	EA	1
D40880250B3B6	25	3/8	1/2	1/4	EA	1
D40880350B3B6	35	3/8	1/2	1/4	EA	1
D40880500B3B6	50	3/8	1/2	1/4	EA	1
D41080250B3B6	25	3/8	5/8	1/4	EA	1
D41080350B3B6	35	3/8	5/8	1/4	EA	1
D41080500B3B6	50	3/8	5/8	1/4	EA	1
D61080250B3B6	25	3/8	5/8	3/8	EA	1
D61080350B3B6	35	3/8	5/8	3/8	EA	1
D61080500B3B6	50	3/8	5/8	3/8	EA	1
D40620250B3B6	25	1/2	3/8	1/4	EA	1
D40620350B3B6	35	1/2	3/8	1/4	EA	1
D40620500B3B6	50	1/2	3/8	1/4	EA	1
D40820250B3B6	25	1/2	1/2	1/4	EA	1
D40820350B3B6	35	1/2	1/2	1/4	EA	1
D40820500B3B6	50	1/2	1/2	1/4	EA	1
D41020250B3B6	25	1/2	5/8	1/4	EA	1
D41020350B3B6	35	1/2	5/8	1/4	EA	1
D41020500B3B6	50	1/2	5/8	1/4	EA	1
D61020250B3B6	25	1/2	5/8	3/8	EA	1
D61020350B3B6	35	1/2	5/8	3/8	EA	1
D61020500B3B6	50	1/2	5/8	3/8	EA	1

If ordering by pallet, 15 line sets are packed per pallet.

LineSet Box™

The NEW LINESET BOX™ is a rough-in box for new construction line set protection for all types of HVAC installations. The architecturally pleasing and professional looking LINESET BOX is easy to install and provides superior protection of refrigerant line sets and condensate drain lines. Provides a clean termination point for new construction projects and reserves the bay for the HVAC system installation. The LINESET BOX also protects the lineset from damage during construction. It helps to eliminate damage such as kinks that can drastically increase HVAC installation time.



CATALOG NO.	DESCRIPTION	UOM	ORDER MULTIPLE
LSB10-W	LINESET BOX™ - White	EA	1
LSB10-BL	LINESET BOX™ - Black	EA	1

REFRIGERANT TUBING cont'd

DiversiTech Tear-Resistant Line Sets

Designed for air conditioning and refrigeration systems, the new DiversiTech Tear-Resistant Line sets include a durable flexible polymeric jacket that minimizes insulation damage and easily conforms to bends. Simplifying installation and saving technician time, an expanded closed-cell structure and unique formation resists moisture vapor intrusion and UV damage. No field-applied coating or jacket translates to more installs in a day. Refrigeration grade copper tubing conforms to ATSM B280. These new Tear-Resistant Standard Line Sets are available in a wide range of sizes and lengths to serve all standard application requirements.



D612K0250

CATALOG NO.	LENGTH (FT)	INSULATION WALL	SUCTION LINE	LIQUID LINE	UOM	ORDER MULTIPLE
D612K0250	25	1/2	3/4	3/8	EA	1
D612K0300	30	1/2	3/4	3/8	EA	1
D612K0350	35	1/2	3/4	3/8	EA	1
D612K0400	40	1/2	3/4	3/8	EA	1
D612K0500	50	1/2	3/4	3/8	EA	1
D614K0250	25	1/2	7/8	3/8	EA	1
D614K0350	35	1/2	7/8	3/8	EA	1
D614K0400	40	1/2	7/8	3/8	EA	1
D614K0500	50	1/2	7/8	3/8	EA	1
D618K0250	25	1/2	1-1/8	3/8	EA	1
D614K0300	30	1/2	1-1/8	3/8	EA	1
D618K0400	40	1/2	1-1/8	3/8	EA	1
D618K0500	50	1/2	1-1/8	3/8	EA	1
D612L0250	25	3/4	3/4	3/8	EA	1
D612L0300	30	3/4	3/4	3/8	EA	1
D612L0350	35	3/4	3/4	3/8	EA	1
D612L0400	40	3/4	3/4	3/8	EA	1
D612L0500	50	3/4	3/4	3/8	EA	1
D614L0250	25	3/4	7/8	3/8	EA	1
D614L0350	35	3/4	7/8	3/8	EA	1
D614L0400	40	3/4	7/8	3/8	EA	1
D614L0500	50	3/4	7/8	3/8	EA	1
D618L0250	25	3/4	1-1/8	3/8	EA	1
D614L0300	30	3/4	1-1/8	3/8	EA	1
D618L0400	40	3/4	1-1/8	3/8	EA	1
D618L0500	50	3/4	1-1/8	3/8	EA	1
D612M0250	25	1	3/4	3/8	EA	1
D612M0300	30	1	3/4	3/8	EA	1
D612M0350	35	1	3/4	3/8	EA	1
D612M0400	40	1	3/4	3/8	EA	1
D612M0500	50	1	3/4	3/8	EA	1
D614M0250	25	1	7/8	3/8	EA	1
D614M0300	30	1	7/8	3/8	EA	1
D614M0350	35	1	7/8	3/8	EA	1
D614M0400	40	1	7/8	3/8	EA	1
D614M0500	50	1	7/8	3/8	EA	1
D618M0250	25	1	1-1/8	3/8	EA	1
D618M0300	30	1	1-1/8	3/8	EA	1
D618M0400	40	1	1-1/8	3/8	EA	1
D618M0500	50	1	1-1/8	3/8	EA	1

DiversiTech Tear-Resistant Mini-Split Line Sets

Designed for Mini-Split air conditioning systems, DiversiTech offers a new line of Tear-Resistant Line Sets that simplify installation and save technician time with no field-applied coating required. A durable polymeric jacket minimizes installation damage and easily conforms to bends, and an expanded closed-cell structure and unique formulation resists moisture vapor intrusion and UV damage. Refrigeration grade copper tubing conforms to ATSM B280. These new Mini-Split Tear-Resistant Line Sets are available in a wide range of sizes and lengths. Available with or without fittings.



CATALOG NO.	LENGTH (FT)	INSULATION WALL	SUCTION LINE	LIQUID LINE	UOM	ORDER MULTIPLE
D406K0250B3B6	25	1/2	3/8	1/4	EA	1
D406K0350B3B6	35	1/2	3/8	1/4	EA	1
D406K0500B3B6	50	1/2	3/8	1/4	EA	1
D408K0250B3B6	25	1/2	1/2	1/4	EA	1
D408K0350B3B6	35	1/2	1/2	1/4	EA	1
D408K0500B3B6	50	1/2	1/2	1/4	EA	1
D410K0250B3B6	25	1/2	5/8	1/4	EA	1
D410K0350B3B6	35	1/2	5/8	1/4	EA	1
D410K0500B3B6	50	1/2	5/8	1/4	EA	1
D610K0250B3B6	25	1/2	5/8	3/8	EA	1
D610K0350B3B6	35	1/2	5/8	3/8	EA	1
D610K0500B3B6	50	1/2	5/8	3/8	EA	1
D406L0250B3B6	25	3/4	3/8	1/4	EA	1
D406L0350B3B6	35	3/4	3/8	1/4	EA	1
D406L0500B3B6	50	3/4	3/8	1/4	EA	1
D408L0250B3B6	25	3/4	1/2	1/4	EA	1
D408L0350B3B6	35	3/4	1/2	1/4	EA	1
D408L0500B3B6	50	3/4	1/2	1/4	EA	1
D410L0250B3B6	25	3/4	5/8	1/4	EA	1
D410L0350B3B6	35	3/4	5/8	1/4	EA	1
D410L0500B3B6	50	3/4	5/8	1/4	EA	1
D610L0250B3B6	25	3/4	5/8	3/8	EA	1
D610L0350B3B6	35	3/4	5/8	3/8	EA	1
D610L0500B3B6	50	3/4	5/8	3/8	EA	1
D406M0250B3B6	25	1	3/8	1/4	EA	1
D406M0350B3B6	35	1	3/8	1/4	EA	1
D406M0500B3B6	50	1	3/8	1/4	EA	1
D408M0250B3B6	25	1	1/2	1/4	EA	1
D408M0350B3B6	35	1	1/2	1/4	EA	1
D408M0500B3B6	50	1	1/2	1/4	EA	1
D410M0250B3B6	25	1	5/8	1/4	EA	1
D410M0350B3B6	35	1	5/8	1/4	EA	1
D410M0500B3B6	50	1	5/8	1/4	EA	1
D610M0250B3B6	25	1	5/8	3/8	EA	1
D610M0350B3B6	35	1	5/8	3/8	EA	1
D610M0500B3B6	50	1	5/8	3/8	EA	1

If ordering by pallet, 15 line sets are packed per pallet.

REFRIGERANT TUBING cont'd

White Pipe™

White Pipe™ pre-insulated refrigerant line is ideal for a variety of installation jobs and works for every air conditioning application including ductless mini-split, heat pump and centralized air ducted units. Available in a variety of sizes and lengths.



Flexible Refrigerant Line

Flexible Refrigerant Line, with installed flare nut, allows a kink-free connection from the mini-split wall unit to the lineset for easier and faster installation.



CATALOG NO.	DESCRIPTION	UOM	ORDER MULTIPLE
WP1214-50	White Pipe, 1/4 x 1/2 in x 50 ft	EA	13
WP1238-50	White Pipe, 3/8 x 1/2 in x 50 ft	EA	11
WP1212-50	White Pipe, 1/2 x 1/2 in x 50 ft	EA	10
WP1258-50	White Pipe, 5/8 x 1/2 in x 50 ft	EA	7
WP1234-50	White Pipe, 3/4 x 1/2 in x 50 ft	EA	5
WP1278-50	White Pipe, 7/8 x 1/2 in x 50 ft	EA	5
WP1214-164	White Pipe, 1/4 x 1/2 in x 164 ft	EA	5
WP1238-164	White Pipe, 3/8 x 1/2 in x 164 ft	EA	4
WP1212-164	White Pipe, 1/2 x 1/2 in x 164 ft	EA	4
WP1258-164	White Pipe, 5/8 x 1/2 in x 164 ft	EA	3
WP1234-82	White Pipe, 3/4 x 1/2 in x 82 ft	EA	3
WP1278-82	White Pipe, 7/8 x 1/2 in x 82 ft	EA	3

CATALOG NO.	DESCRIPTION	UOM	ORDER MULTIPLE
FRL14-F	Flexible Refrigerant Line – 1/4 in. x 36"	EA	15
FRL38-F	Flexible Refrigerant Line – 3/8 in. x 36"	EA	14
FRL12-F	Flexible Refrigerant Line – 1/2 in. x 36"	EA	11
FRL58-F	Flexible Refrigerant Line – 5/8 in. x 36"	EA	10

REFRIGERANT LABELS

DiversiTech Refrigerant ID Labels

Refrigerant labels are designed for proper identification of refrigerant in a recovery cylinder. These 3" x 4" self-adhesive vinyl refrigeration labels use a high-tack acrylic adhesive and UV cured screen printing. Each label indicates the type of refrigerant (eg. R-438A), the chemical name (eg. pentafluoroethane) and the UN No. (eg. UN3163).



- Color coded
- Large and easy to read refrigerant identification
- Durable UV cured screen printed

CATALOG NO.	DESCRIPTION	UOM	ORDER MULTIPLE
REFRIGERANT IDENTIFICATION LABELS (3" x 4")			
04022	R-22 Refrigerant ID Labels, pack of 10	PK	1
04134	R-134a Refrigerant ID Labels, pack of 10	PK	1
04404	R-404A (HP62/FX70) Refrigerant ID Labels, pack of 10	PK	1
04407	R-407C (SUVA 9000/KLEA 66) Refrigerant ID Labels, pack of 10	PK	1
04410	R-410A (AZ20) Refrigerant ID Labels, pack of 10	PK	1
04099	R-438A Refrigerant ID Labels, pack of 10	PK	1
04402	R-402A Refrigerant ID Labels, pack of 10	PK	1
04421	R-421A Refrigerant ID Labels, pack of 10	PK	1
04137	R-437A Refrigerant ID Labels, pack of 10	PK	1
SYSTEM REFRIGERANT/OIL LABELS (3" x 4")			
04850	Refrigerant Removed Labels, pack of 10	PK	1

REFRIGERANT RECOVERY PRODUCTS

Refrigerant Recovery Cylinders

DOT Classified for recovery, recycling, service and reclaim. Liquid and vapor valves ("Y" valve or separate valve configurations) are installed in all cylinders. Painted yellow/gray per ARI guidelines. Float switches have 3-pin Brad Harrison connectors.

CATALOG NO.	DESCRIPTION	DOT CLASS	3/4" NPT PLUG	FLOAT SWITCH	WATER CAP.	TARE WT.	UOM	ORDER MULTIPLE
02033	30 lb.	4BA400	YES	NO	26.2 lbs.	17 lbs.	EA	1
02053	50 lb.	4BA400	YES	NO	47.7 lbs.	28 lbs.	EA	1
02100	100 lb.	4BW400	NO	NO	123 lbs.	48 lbs.	EA	1
02255	250 lb.	4BW260	YES	NO	239 lbs.	85 lbs.	EA	1



Caution: Never overfill cylinders. Maximum refrigerant capacity is limited to 80% of the water capacity of the cylinder in lbs. (see table above). DOT requires cylinders to be retested every five years. Some recovery equipment uses weight scales to cut off refrigerant fill at 80% of capacity. Be sure cylinder tare weight is correct for this type of equipment.

DOT Classification Example: 4BA400: 400 psi working pressure; 800 psi test pressure (double the working pressure); 1,600 psi minimum burst pressure (double the test pressure). Pressure relief/safety valve is set to release at between 75-100% of the test pressure. For example, in the 4BA400 tanks which have a 800 psi test pressure, the relief valve opens at between 600 psi and 800 psi.

TUBING INSULATION

Tubing Insulation

Highest quality tubing insulation by Armacell. AC Accoflex® tubing insulation is a flexible rubber product from the inventors of elastomeric foam insulation. It is designed exclusively for HVAC, with a tough surface and excellent resistance to ultraviolet damage, condensation and mold.



3/8" WALL

CATALOG NO.	DESCRIPTION	TOTAL FEET	UOM	ORDER MULTIPLE
7-3838	3/8" ID x 3/8" Wall, pack of 100,	600'	PK	1
7-3812	1/2" ID x 3/8" Wall, pack of 80	480'	PK	1
7-3858	5/8" ID x 3/8" Wall, pack of 65	390'	PK	1
7-3834	3/4" ID x 3/8" Wall, pack of 55	330'	PK	1
7-3878	7/8" ID x 3/8" Wall, pack of 45	270'	PK	1
7-381-18	1-1/8" ID x 3/8" Wall, pack of 35	210'	PK	1
7-381-38	1-3/8" ID x 3/8" Wall, pack of 30	180'	PK	1
7-381-58	1-5/8" ID x 3/8" Wall, pack of 20	120'	PK	1
7-382-18	2-1/8" ID x 3/8" Wall, pack of 16	96'	PK	1
7-382-58	2-5/8" ID x 3/8" Wall, pack of 12	72'	PK	1

3/4" WALL

CATALOG NO.	DESCRIPTION	TOTAL FEET	UOM	ORDER MULTIPLE
7-3438	3/8" ID x 3/4" Wall, pack of 40	240'	PK	1
7-3412	1/2" ID x 3/4" Wall, pack of 35	210'	PK	1
7-3458	5/8" ID x 3/4" Wall, pack of 24	144'	PK	1
7-3434	3/4" ID x 3/4" Wall, pack of 23	138'	PK	1
7-3478	7/8" ID x 3/4" Wall, pack of 20	120'	PK	1
7-341-18	1-1/8" ID x 3/4" Wall, pack of 15	90'	PK	1
7-341-58	1-5/8" ID x 3/4" Wall, pack of 10	60'	PK	1
7-342-18	2-1/8" ID x 3/4" Wall, pack of 9	54'	PK	1
7-342-58	2-5/8" ID x 3/4" Wall, pack of 8	48'	PK	1

1/2" WALL

CATALOG NO.	DESCRIPTION	TOTAL FEET	UOM	ORDER MULTIPLE
7-1238	3/8" ID x 1/2" Wall, pack of 75	450'	PK	1
7-1212	1/2" ID x 1/2" Wall, pack of 66	396'	PK	1
7-1258	5/8" ID x 1/2" Wall, pack of 50	300'	PK	1
7-1234	3/4" ID x 1/2" Wall, pack of 40	240'	PK	1
7-1278	7/8" ID x 1/2" Wall, pack of 35	210'	PK	1
7-121-18	1-1/8" ID x 1/2" Wall, pack of 25	150'	PK	1
7-121-38	1-3/8" ID x 1/2" Wall, pack of 20	120'	PK	1
7-121-58	1-5/8" ID x 1/2" Wall, pack of 15	90'	PK	1
7-122-18	2-1/8" ID x 1/2" Wall, pack of 10	60'	PK	1
7-122-58	2-5/8" ID x 1/2" Wall, pack of 10	60'	PK	1
7-123-18	3-1/8" ID x 1/2" Wall, pack of 7	42'	PK	1

1" WALL

CATALOG NO.	DESCRIPTION	TOTAL FEET	UOM	ORDER MULTIPLE
7-1058	5/8" ID x 1" Wall, pack of 20	120'	PK	1
7-1078	7/8" ID x 1" Wall, pack of 15	90'	PK	1

TUBING INSULATION cont'd

Self-Sealing Split Tubing Insulation

The Tubolit® semi-slit tubing insulation is made of 100% non-particulating polyethylene foam pipe insulation. Its closed-cell structure won't wick moisture and helps prevent the absorption of condensation that could cause mold to develop over time. It is pre-slit with a factory applied pressure sensitive adhesive to both seam surfaces and has a release liner for easy installation. Available in 3/8", 1/2", 3/4" and 1" wall thickness options with inner diameters from 3/8" to 3-1/8".



3/8" WALL

CATALOG NO.	DESCRIPTION	TOTAL FEET	UOM	ORDER MULTIPLE
7-S3838	3/8" ID x 3/8" Wall, pack of 90	540'	PK	1
7-S1238	1/2" ID x 3/8" Wall, pack of 76	456'	PK	1
7-S5838	5/8" ID x 3/8" Wall, pack of 66	396'	PK	1
7-S3438	3/4" ID x 3/8" Wall, pack of 50	300'	PK	1
7-S7838	7/8" ID x 3/8" Wall, pack of 46	276'	PK	1
7-S11838	1-1/8" ID x 3/8" Wall, pack of 37	222'	PK	1
7-S13838	1-3/8" ID x 3/8" Wall, pack of 30	180'	PK	1
7-S15838	1-5/8" ID x 3/8" Wall, pack of 23	138'	PK	1
7-S11038	1-1/2" ID x 3/8" Wall, pack of 21	126'	PK	1
7-S21838	2-1/8" ID x 3/8" Wall, pack of 16	96'	PK	1
7-S20038	2-3/8" ID x 3/8" Wall, pack of 14	84'	PK	1
7-S25838	2-5/8" ID x 3/8" Wall, pack of 12	72'	PK	1
7-S21038	2-7/8" ID x 3/8" Wall, pack of 10	60'	PK	1
7-S31838	3-1/8" ID x 3/8" Wall, pack of 9	54'	PK	1

1/2" WALL

CATALOG NO.	DESCRIPTION	TOTAL FEET	UOM	ORDER MULTIPLE
7-S3812	3/8" ID x 1/2" Wall, pack of 69	414'	PK	1
7-S1212	1/2" ID x 1/2" Wall, pack of 56	336'	PK	1
7-S5812	5/8" ID x 1/2" Wall, pack of 50	300'	PK	1
7-S3412	3/4" ID x 1/2" Wall, pack of 44	264'	PK	1
7-S7812	7/8" ID x 1/2" Wall, pack of 40	240'	PK	1
7-S10012	1" ID x 1/2" Wall, pack of 35	210'	PK	1
7-S11812	1-1/8" ID x 1/2" Wall, pack of 31	186'	PK	1
7-S12512	1-1/4" ID x 1/2" Wall, pack of 28	168'	PK	1
7-S13812	1-3/8" ID x 1/2" Wall, pack of 25	150'	PK	1
7-S15812	1-5/8" ID x 1/2" Wall, pack of 20	120'	PK	1
7-S11012Y	1-1/2" ID x 1/2" Wall, pack of 17	102'	PK	1
7-S21812	2-1/8" ID x 1/2" Wall, pack of 14	84'	PK	1
7-S0012	2-3/8" ID x 1/2" Wall, pack of 12	72'	PK	1
7-S25812	2-5/8" ID x 1/2" Wall, pack of 10	60'	PK	1
7-S21012	2-7/8" ID x 1/2" Wall, pack of 9	54'	PK	1
7-S31812	3-1/8" ID x 1/2" Wall, pack of 8	48'	PK	1
7-S35812	3-5/8" ID x 1/2" Wall, pack of 6	36'	PK	1
7-S41812Y	4-1/8" ID x 1/2" Wall, pack of 5	30'	PK	1
7-S40012	4-1/2" ID x 1/2" Wall, pack of 4	24'	PK	1

3/4" WALL

CATALOG NO.	DESCRIPTION	TOTAL FEET	UOM	ORDER MULTIPLE
7-S3834	3/8" ID x 3/4" Wall, pack of 25	228'	PK	1
7-S1234	1/2" ID x 3/4" Wall, pack of 35	210'	PK	1
7-S5834	5/8" ID x 3/4" Wall, pack of 30	180'	PK	1
7-S3434	3/4" ID x 3/4" Wall, pack of 27	162'	PK	1
7-S7834	7/8" ID x 3/4" Wall, pack of 25	150'	PK	1
7-S11834	1-1/8" ID x 3/4" Wall, pack of 20	120'	PK	1
7-S13834	1-3/8" ID x 3/4" Wall, pack of 16	96'	PK	1
7-S15834	1-5/8" ID x 3/4" Wall, pack of 14	84'	PK	1
7-S11034	1-1/2" ID x 3/4" Wall, pack of 11	66'	PK	1
7-S21834	2-1/8" ID x 3/4" Wall, pack of 9	54'	PK	1
7-S20034	2-3/8" ID x 3/4" Wall, pack of 9	54'	PK	1
7-S25834	2-5/8" ID x 3/4" Wall, pack of 8	48'	PK	1
7-S21034	2-7/8" ID x 3/4" Wall, pack of 7	42'	PK	1
7-S31834	3-1/8" ID x 3/4" Wall, pack of 6	36'	PK	1
7-S35834	3-5/8" ID x 3/4" Wall, pack of 5	30'	PK	1
7-S41834	4-1/8" ID x 3/4" Wall, pack of 4	24'	PK	1
7-S40034	4-1/2" ID x 3/4" Wall, pack of 4	24'	PK	1

1" WALL

CATALOG NO.	DESCRIPTION	TOTAL FEET	UOM	ORDER MULTIPLE
7-S3810	3/8" ID x 1" Wall, pack of 25	150'	PK	1
7-S1210	1/2" ID x 1" Wall, pack of 21	126'	PK	1
7-S5810	5/8" ID x 1" Wall, pack of 20	120'	PK	1
7-S3410	3/4" ID x 1" Wall, pack of 20	120'	PK	1
7-S7810	7/8" ID x 1" Wall, pack of 16	96'	PK	1
7-S10010	1" ID x 1" Wall, pack of 16	96'	PK	1
7-S11810	1-1/8" ID x 1" Wall, pack of 14	84'	PK	1
7-S13810	1-3/8" ID x 1" Wall, pack of 12	72'	PK	1
7-S15810	1-5/8" ID x 1" Wall, pack of 10	60'	PK	1
7-S11010	1-1/2" ID x 1" Wall, pack of 9	54'	PK	1
7-S21810	2-1/8" ID x 1" Wall, pack of 9	54'	PK	1
7-S20010	2-3/8" ID x 1" Wall, pack of 7	42'	PK	1
7-S25810	2-5/8" ID x 1" Wall, pack of 6	36'	PK	1
7-S21010	2-7/8" ID x 1" Wall, pack of 5	30'	PK	1
7-S31810	3-1/8" ID x 1" Wall, pack of 4	24'	PK	1
7-S35810	3-5/8" ID x 1" Wall, pack of 4	24'	PK	1
7-S41810	4-1/8" ID x 1" Wall, pack of 4	24'	PK	1
7-S40010	4-1/2" ID x 1" Wall, pack of 3	18'	PK	1

DISTRIBUTOR SUPPORT

Literature.....	182
Merchandising.....	183
U.S. General Terms & Conditions	184



LITERATURE

Catalogs

CATALOG NO.	DESCRIPTION	STANDARD PACK
LIT-CAT-HVAC	Issue 24 Catalog	10

Tri-Folds

Each DiversiTech tri-fold brochure has a specific product focus. The tri-folds can be used as counter handouts, or mailed to a contractor. Brochure holders are also available. Most tri-folds are 8-1/2" high by 3-5/8" wide.

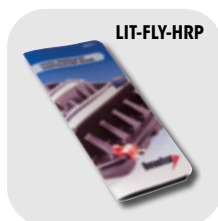

Literature Holders

CATALOG NO.	DESCRIPTION	STANDARD PACK
MKT-POP-BROCH	Brochure Holder w/DiversiTech Logo Imprinted	1
MKT-POP-BROCH4	4-Pocket Brochure Holder	1
MKT-POP-EASEL	Acrylic Tri-Fold Brochure Holder	1

CATALOG NO.	DESCRIPTION	STANDARD PACK
LIT-FLY-3D	Triple-D™ Brochure	25
LIT-FLY-3D-S	Triple-D™ Brochure (Spanish)	25
LIT-FLY-BPPPOOL	The Black Pad® Brochure	25
LIT-FLY-CDLC	Condensate Drain Line Cleaners Brochure	25
LIT-FLY-CLAD	CladLite® Pad Brochure	25
LIT-FLY-CLRVUE	ClearVue™ Pump Brochure	25
LIT-FLY-COIL	Coil Cleaning Solution Guide	25
LIT-FLY-COIL-S	Coil Cleaner Solution Guide (Spanish)	25
LIT-FLY-CS1200	CS1200 A/C Shutoff Brochure	25
LIT-FLY-CVMINI	ClearVue™ Mini Pump Brochure	25
LIT-FLY-CVMINI-S	ClearVue™ Mini Pump Brochure (Spanish)	25
LIT-FLY-DISC	Fusible Disconnect Brochure	25
LIT-FLY-DST10	Hard Start Kit Brochure	25
LIT-FLY-DTP3	Three Phase Motor Protector Brochure	25
LIT-FLY-DTP3ES	Three Phase Motor Protector Brochure (Spanish)	25
LIT-FLY-ELITE	E Lite® Pad Brochure	25
LIT-FLY-ET	A/C Easy Tee® Brochure	25
LIT-FLY-FLEX	Flex Inject® Brochure	25
LIT-FLY-FLXHOSEKIT	SpeediChannel™ Flex Hose Kit Flyer	25
LIT-FLY-FLOW	Flow Plus™ Brochure	25
LIT-FLY-FOOT	Hef-T-Foot™ Brochure	25
LIT-FLY-HEAT	Heat Pump Pad™ Brochure	25
LIT-FLY-HPAD	Hurricane Pad Brochure	25
LIT-FLY-HRP	High Rise Pan™ Brochure	25
LIT-FLY-HSI	Universal Hot Surface Igniter Brochure	25
LIT-FLY-MDP	Metal Drain Pan Brochure	25
LIT-FLY-MOTORS	Motor Brochure	25
LIT-FLY-PF	Pro-Flush Brochure	25
LIT-FLY-PF-S	Pro-Flush Brochure (Spanish)	25
LIT-FLY-PUMP	Condensate Pump Line Brochure	25
LIT-FLY-QS	Quick-Sling® Brochure	25
LIT-FLY-RPC	Rapid Positioning Clips Brochure	25
LIT-FLY-RPC-S	Rapid Positioning Clips Brochure (Spanish)	25
LIT-FLY-RSC	Sentry™ Refrigerant Locking Caps Brochure	25
LIT-FLY-SEAL	Cliplight® Brochure	25
LIT-FLY-SPCH18	SpeediChannel™ Brochure and Poster	25
LIT-FLY-SPRAYER	Power Sprayer Brochure	25
LIT-FLY-SPRAYER-S	Power Sprayer Brochure (Spanish)	25
LIT-FLY-SPTEAROFF	SpeediChannel™ Tearpad	25
LIT-FLY-SWITCH	Condensate Switches Brochure	25
LIT-FLY-TRIPBOOST	Triple-D®/Boost Juice® Brochure	25
LIT-FLY-PADS	Pads Brochure	25
LIT-FLY-UC	UltraLite® Pad Brochure	25
LIT-FLY-UCSTRAP	UltraLite® Earthquake Pad Brochure	25
LIT-FLY-UV	Pure-Beam™ UV Light Brochure	25

CATALOG NO.	DESCRIPTION	STANDARD PACK
LIT-FLY-VENTS	Vent Termination Kits Brochure	25
LIT-FLY-WS	Wet Switch® Brochure	25

MERCHANDISING

Posters

CATALOG NO.	DESCRIPTION	STANDARD PACK
MKT-POSTER-CHT24E	Chemical Maintenance Solution Quick Reference Guide - 24" x 36"	1
MKT-POSTER-CHT24S	Chemical Maintenance Solution Quick Reference Guide - 24" x 36" (Spanish)	1
MKT-POSTER-CHT36E	Chemical Maintenance Solution Quick Reference Guide - 36" x 48"	1
MKT-POSTER-CLRVUE	ClearVue™ Pump Poster	1
MKT-POSTER-HPAD	The Hurricane Pad™ poster	1
MKT-BANNER	DiversiTech® Vinyl Banner 2' x 5'	1

P.O.P. Merchandisers/Displays

CATALOG NO.	DESCRIPTION	STANDARD PACK
MKT-MAT-COILTAB	Chemical Maintenance Solution Quick Reference Guide - Mat	1
MKT-MERCH-USACAPS	Merchandising Kit for USA Capacitors	1
MKT-MERCH-CHEM	Chemical Display for Gondola	1
MKT-MERCH-DPWIRE	DP-1 Wire Rack	1
MKT-MERCH-FLEX	Flex-Inject® Counter Display	1
MKT-MERCH-RSC	Sentry™ Wall Display	1
MKT-MERCH-SENTRY	Sentryman Display	1
MKT-MERCH-SWITCHWIRE	Wire Display Rack	1
MKT-POP-CDLC	Condensate Drain Line Cleaner Display	1
MKT-POP-CHEM	DiversiTech® Chemical Display 26" base x 73" height	1
MKT-POP-CLRGOND	ClearVue™ Pump Display for Gondola	1
MKT-POP-CVTUBE	ClearVue™ Tube Display	1
MKT-POP-DEVBACKS	DEVCO® Background Graphics for pegboard	Set of 2
MKT-POP-DEVBACKSSLAT	DEVCO® Background Graphics for Slatwall	1
MKT-POP-DEVCOMBO	DEVCO® Display Rack – Combo	1
MKT-POP-DEVELEC	DEVCO® Display Rack – Electrical	1
MKT-POP-DEVEZC	DEVCO® Display Rack – EZC	1
MKT-POP-DTBACKS	DiversiTech® Background Graphics for pegboard	Set of 2
MKT-POP-DTBACKSSLAT	DiversiTech® Background Graphics for Slatwall	1
MKT-POP-DUCT	SpeediChannel™ Counter Display	1
MKT-POP-DUCTSPIN	SpeediChannel™ Floor Spinner	1
MKT-POP-ET	A/C Easy Tee® Merchandiser	1
MKT-POP-HSI	Merchandiser Display for TrueStar® Hot Surface Igniters	1
MKT-POP-PF	Pro-Flush® Display	1
MKT-POP-QSBACK	Quick-Sling® Display Background	1
MKT-POP-QSMSBOX	Mini-Split Outside Unit Box	1
MKT-POP-QSWIBOX	Unit Heater Box	1
MKT-POP-SWITCHBACK	Background Display for Condensate Switches	1

MKT-POP-QSWIBOX



MKT-MERCH-DPWIRE



MKT-POP-HSI



MKT-POP-PF



MKT-POP-CDLC



MKT-POP-ET



MKT-POP-CHEM

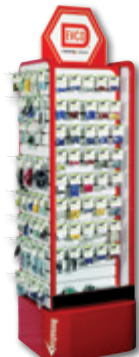

MKT-POP-DEVCOMBO



MKT-POP-DEVELEC



MKT-POP-DEVEZC

U.S. GENERAL TERMS AND CONDITIONS**General Policy****WE ARE COMMITTED TO DO WHAT IT TAKES TO DELIVER WORLD CLASS SERVICE AND PRODUCTS.**

All items not ordered in multiples of standard package quantities will automatically be increased to the next standard package quantity. All purchase orders submitted by our customers are assumed as accepting our general terms and conditions as stated herein, any conflicting terms stated on the purchase order cannot supersede our terms.

Order Discrepancies:

All order discrepancies must be reported to us within 5 working days from the date of delivery. Any discrepancies reported after this period cannot be honored.

Terms:

1% 15 days. Net 30 days. Late charges of 1-1/2% per month will be charged following the due date of the invoice.

Prices:

Subject to change without notice.

Minimum Order:

\$250.00 minimum order on all original orders. Less than pallet quantities are not available for equipment pads.

Freight Policy

CONTINENTAL U.S.: All orders in excess of \$2,000 will ship prepaid. This policy applies to any combination of DiversiTech, Wagner, Specialty Chemical, and Devco products. Exports will ship freight collect from Buford, GA.

Pick Up Allowance

3% of net invoice, 24-hour notice requested. Order must qualify for prepaid freight to receive pick up allowance.

Lost or Damaged Freight

Although we take special care to insure the safe arrival of your merchandise, our responsibility for damages cease when the customer accepts the shipment. To protect your interest, we suggest that you thoroughly inspect all items before accepting delivery. If your order was damaged in shipment or contains a shortage, report the loss or damage AT ONCE to DiversiTech. Any claims for lost or damaged freight must be noted on the Bill of Lading at the time of delivery. If damage is present, you MUST hold the original carton and merchandise for credit by your Sales Representative – otherwise, no claim can be honored.

Returns:

No merchandise will be accepted for return without prior authorization. Call our Customer Service Department to request permission to return goods. Instructions on method of return will be given to you at that time. All returns are subject to a 25% restocking charge.

Warranty Disclaimer

DiversiTech has made a diligent effort to illustrate and describe the products in this catalog accurately; however, such illustrations and descriptions are for the sole purpose of identification, and do not express or imply a warranty that the products are merchantable or fit for a particular purpose, or that the products will necessarily conform to the illustrations or descriptions. DiversiTech assumes no liability for typographical or photographic errors.

DiversiTech reserves the right to make changes in design, material or finish in an effort to improve our products without special notification. If necessary, DiversiTech reserves the right to replace any product shown in catalog with another comparable product without special notification. All DiversiTech products include a 1 year standard limited warranty unless otherwise noted.

DiversiTech's ULTRALITE®, CLADLITE®, and E LITE® Limited Lifetime Warranty

To the original owner of the ULTRALITE®, CLADLITE®, or E LITE® equipment base, DiversiTech warrants the base to be free of defects in materials and workmanship for the life of the equipment under which it is installed so long as the installing homeowner lives there. All defective merchandise must be returned to the factory, transportation prepaid, and if the same is found to be defective, it will be repaired or replaced free of charge, F.O.B. factory. This warranty does not cover replacement labor cost, or any cost claim incident to the defect, replacement, or reinstallation, nor field repair expenses. This warranty gives you specific legal rights and you may also have other rights which vary from state to state. Some states do not allow the exclusion or limitation of incidental or consequential damages, so the above limitation of exclusion may not apply to you.

Exclusions and Limitations

DiversiTech's ULTRALITE®, CLADLITE®, and E LITE® equipment pads are designed and manufactured to be used as bases for light, ground supported equipment such as air conditioning condensers, swimming pool filters and heat pumps. Use of ULTRALITE®, CLADLITE®, and E LITE® pads for purposes other than those listed above or improper installation of ULTRALITE®, CLADLITE®, and E LITE® pads may result in pad failure. DiversiTech Corporation disclaims any liability due to such misuse or improper installation. If you have questions concerning the proper installation or use of DiversiTech's ULTRALITE®, CLADLITE®, and E LITE® equipment pads, you should contact our Customer Service Department at (800)995-2222.

Made in the U.S.A.

All item numbers in RED indicate Made in the U.S.A. This information was accurate at time of catalog printing. Visit www.diversitech.com to verify country of origin for any DiversiTech product.

CATEGORY INDEX

007 Control Checker.....	125	90 Degree Long Turn Ell C x C (Copper)	166	All-Purpose Clear Cement for ABS, PVC and CPVC Pipe and Fittings. 134
1 Hole EMT Pipe Straps.....	19	90 Degree Long Turn Street Ell Ftg. x C (Copper)	165	Aluminum Armored MC Cable 94
1 Hole Rigid Pipe Straps - Heavy Duty – Steel	19	90 Degree Outside Elbow (EasyGuard)	150	Aluminum Dryer Vent Hoods, Kits, and Fittings
2 Hole PVC Pipe Straps	19	90 Degree Outside Elbow (SpeediChannel)	146	Aluminum Equipment Stand .. 11-12
2 Hole Rigid Pipe Straps Steel.....	19	90 Degree Street Ell	33	Aluminum Foil Tape
200 Piece Terminal Kit	110	90 Degree Street Ell Ftg. x C (Copper)	165	Aluminum Solderless Lugs..... 84
25 Year Acrylic Latex Painter's Caulk. 52		90 Elbow (Hub x Hub)	136	Analog Pocket Thermometer with Magnifying Lens
2-in-1 Copper Tube Cleaning Brush	119	90 Ell (Slip x FIPT)	137	Anchor Kit
3 Pole Switch for Mini-Splits.....	92	90 Ell (Slip x Slip).....	137	Anchors
3 Rail Large Mini-Split Stands.....	11	90 Ell Reducing (Slip x FIPT)	137	Anti-Vibration Pads
3-36® Multi-Purpose Lubricant & Corrosion Inhibitor	47	90 Street Ell (MIPT x Slip).....	138	Armored Connector
45 Degree Ell	32	90 Street Ell (SPIG x Slip).....	137	Armored Plug
45 Degree Ell C x C (Copper)....	165	A/C Condensate Drain Pan Fittings ..38		Aviation Snips.....
45 Degree Flat Bend (SpeediChannel)	146	A/C Easy Tee.....	37	Base Pad.....
45 Degree Street Ell Ftg. x C (Copper)	166	A/C Secondary Condensate Drain Pans	40	Batteries by Rayovac.....
45 Elbows	136	A/C Security Cages	13	Beam Clamps.....
45 Ell (Slip x Slip).....	137	Abrasive Cloths.....	42	Bi Flow Driers
4-Outlet GFCI Power Pack	107	Access Fittings	168	Bi-Metal Reciprocating Saw Blades
4-Piece Hook and Pick Set	124	Accessories (Chemicals).....	155 126
5-Outlet GFCI Shock Buster	107	Acid Eliminator	162	Black Jack Roof Cement
6180 Series Terminal Blocks	82	Acid Test Kits	162	Black Nylon Cable Tie Assortment 73
6190 Series Terminal Blocks	83	Adapter (Insert x Slip)	139	Black Nylon Ties with Mounting Hole
7 Mil Commercial & Professional Grade Electrical Tape	108	Additives	162 116
8.5 Mil Commercial Grade Electrical Tape.....	108	Adjustable Delay on Break Time & Make Timer.....	103	Black Nylon Wire Ties.....
90 Degree Ell	32	Adjustable Equipment Risers.....	8 32
90 Degree Ell C x C (Copper)....	165	Adjustable Flat Bend (SpeediChannel)	145	Blade (Auto) Fuses - Devco.....
90 Degree Flat Bend (EasyGuard) .	149	Aerosol Starter Kit.....	155 79
90 Degree Flat Bend (SpeediChannel)	145	Aerosols	42	Blade (Auto) Fuses - Electrical... 102
90 Degree Inside Elbow (EasyGuard)	150	Air Conditioner Brackets.....	10	Blind Rivet Tools.....
90 Degree Inside Elbow (SpeediChannel)	146	Air Handler Base - Heavy Duty Adjustable	12 74
90 Degree Long Radius Bend (SpeediChannel)	146	Air Handler Blocks	8	Boiler Bracket
		All Purpose Cleaning Pads	42	Boost Juice & Boost Juice Inject162
		All Purpose Sprayers.....	158	Box Cover Units
		All Weather PVC Cement.....	134 102
				Box Handler Gloves
				Box Stabilizer Support.....
				Box To T-Bar Fastener.....
				Boxes, Rings, and Covers.....
			 70
				Braided Clear Vinyl Tubing.....
			 39
				Brass Adapters.....
			 168
				Brass Fittings.....
			 170
				Bridle Rings.....
			 18
				Brushes.....
			 119

CATEGORY INDEX cont'd

Bubble-N-Trouble™ Freeze	Clean Out Tee.....	139	Copper Saddle Valve.....	169
Protected Spray-On Leak Detector .	Clear Cleaner.....	134	Copper Tube Fitting Brushes.....	120
Bushing	Clear Vinyl Tubing	38	Core Removal Tool.....	169
Bushing (MIPT x FIPT)	ClearVue™ Tube & Traps.....	36	Core Storer.....	169
Bushings and Locknuts.....	Cliplight Extends.....	123	Cork Insulation Tape	39
Butt Connector Assortment Kit.....	Clip-On Zoom Light.....	123	Cotter Pins	77
BX 1 Hole Strap	Clips	79	Coupling - Heating Products	33
BX and Greenfield Connectors	Clipstrip Aqua.....	121	Coupling (Slip x Slip).....	138
BX Set Screw Connectors.....	Clipstrip	121	Coupling (Socket) with Rolled Tube	
Cable Clamp Pro	Cloth Duct Tape	26	Stop C X C.....	166
Cable Connectors.....	CO ₂ Cylinders.....	118	Couplings (Hub x Hub)	136
Cable Markers	Coil Cleaners.....	154	Coveralls	44
Cable Staples.....	Coil Guard.....	155	CP-22 Pumps	36
Cable Tie Assortment Pack	Combination Packs.....	63	CPVC-CTS Pipe and Fittings.....	132
Cable Tie Channel Clips.....	Combination Screwdrivers	126	Cross Reference - Thermostat	
Cable Tie Mounts.....	Combo Head Sheet Metal Screws..	76	Guards.....	112
Cable Ties and Accessories.....	Compartmented Storage Boxes .	107	Curve Light.....	123
Canvas Drop Cloths	Compression Connector	170	Cushion Clamps - Mounting	
Cap (Copper)	Compression Elbow, Nut, Sleeve	170	Systems	15
Cap (FIPT).....	Compression Sprayers	158	Cushion Clamps - Inline	
Cap (Slip)	Compression Tee	170	Components	172
Cap (SpeediChannel).....	Compression Union	170	Cut Resistant Gloves.....	48
Capacitors.....	Compressor Lead Kit.....	63	Cutting Oil.....	47
Carabiners	Compressor Repair Kit	107	D'Scale Acid Scale Remover	162
Carbon Monoxide & Smoke Alarms.	Compressor TOTE.....	124	Degreasers.....	44
Carbon Monoxide Alarms	Concentric Vents	29	Deluxe Digital Pocket Thermometer	
Carbon Steel Curved Handle Scratch	Condensate Drain Line Cleaning .	37	129
Brush	Condensate Drain Pans	38	Deluxe Hi-Tension Hacksaw.....	126
Carton Sealing Tape and Dispenser	Condensate Fittings, Adapters	38	Devco Crimpers.....	74
.....	Condenser/Heat Exchanger Brushes		Devco Plastic Anchor Kits.....	69
.....	120	Devco Racks Master Item List.....	60
Carton Tape Dispenser	Conduit Fittings	73	Devco Terminal Kits.....	67
Catalogs	Conduit, Fittings, Cable	93	Device Rings	70
Caulk Gun.....	Conduit Nipples.....	73	Dial-a-Mix Sprayer	158
CBC II Contact Cleaner	Connection Plates for 1-5/8" Strut		Digital Single Phase Line Voltage	
Channel Nuts	Channels	16	Monitor	103
Channel Post Base for 1-5/8" Strut	Contact Cleaners.....	44	Digital Thermometer	129
Channels	Contactors	98	Digital Three Phase Line Voltage	
Channellock® Products	Cool-Weld Heat Barrier Spray	155	Monitor	103
Chip Brushes.....	Cop-Cap™ Locking Valve Cover .	168	Direct Replacement Igniters	28
Chlor-Free Degreaser.....	Copper Coupling with Dimple Stop		Disconnects - Metal Case & Non-	
Citrus Degreaser.....	& with No Stop (Copper)	167	Metallic Case	92
CladLite® Lightweight Concrete	Copper Fittings.....	165	DiversiGum Sealing Compound ..	52
Equipment Pads				

Diversitech Electrical Disconnects	92	Duct End (SpeediChannel™)	147	Evergreen CM ECM Motors	88
Diversitech Gas Connectors	30	Duct Fans	22	Evergreen EM ECM Motors	88
Diversitech Hard Start Kits	98	Duct Strap, Ties, Clamps	24	Evergreen IM ECM Motors	88
Diversitech Line Sets	175	Duct Strap - Woven Polypropylene	25	Evergreen InTune Motors	89
Diversitech Motors Brackets	91	Duct-Fresh Gel & Spray	161	Evergreen OM ECM Motors	89
Diversitech Refrigerant ID Labels	178	Ductless Cassette Hangers	10	Evergreen PF ECM Motors	89
Diversitech Tear-Resistant Line Sets	176	DWV Bend Fittings, Bushings, Vent Tee	136	Extended Lengths for Concentric Vents	29
Diversitech Tear-Resistant Mini-Split Line Sets	177	E Lite® Plastic Equipment Pads	3	Extension Rings	70
DiversiTech 2 & 3 Pole Definite Purpose Contactors	98	EasyFlex® Tankless Water Heater Connection Kits	30	Fan Centers	101
DiversiTite Flexible Conduit	93	EasyGuard™ Line Set Cover System	149	Fasco® OEM Replacement Draft Inducers	90
DiversiWhips	91	EasyGuard™ Fittings	149	Fast Cure Epoxy	51
DiversiWhips for the Swimming Pool Industry	92	EasyID Blade Fuses	102	Fast Orange Hand Cleaner	45
DiversiWhips Pallet Packs	91	Eaton Circuit Breakers - Type BR & Type CH	105	Felt Tip Markers	48
DiversiWhips with Extended Length Wires	91	Eaton Contactor Accessories	99	Female Adapter (Barb x FIPT)	132
DiversiWhips - Up to 30 Amp	92	Eaton Definite Purpose Contactors	99	Female Adapter (Slip x FIPT)	138
Dormont 20 & 30 Series	31	Eaton Electrical Disconnects	93	Female Adapter C x F (Copper)	165
Dormont Gas Connectors and Valves	31	Eaton Switch A/C Disconnect	93	Female Adapter Elbow (Barb x FIPT)	133
Drain Line, Tubing	38	Eaton Three Phase Disconnects	93	Female Adapter Reducing (Slip x FIPT)	138
Drain Pan Disinfectant	156	Eco-Coil™ Environmentally Friendly Coil Cleaner	154	Fender Washers	76
Drain Trap Kits	38	Economy Electrical Tape	107	Fin Tools	121
DrainDawg™	37	EcoPad™ Black Plastic Equipment Pads	5	Fin Whisk	120
DrainDawg™ and DrainKat™ Fittings	37	Egg Crate Louvers - Air Return Diffusers	22	Finished Hex Nuts	75
DrainGun™ and Cartridges	37	Elbow (Barb x Barb)	133	Firestop Products for Class A Buildings	52
DrainKat™	37	Electrical Duplex Receptacles	104	First Aid Kits	50
Driers, Sight Glasses	173	Electrical Outlet Boxes, Extensions and Covers	104	Fitting Reducer Coupling Ftg. x C	166
Drive Fasteners	68	Electrical Staples	74	SpeediChannel Fittings	145
Drop Cloths	45	Electrical Supplies	121	SpeediChannel Flex Hose Kits	148
Drop-In Expansion Anchors & Setting Tool	68	Electrical Tapes	108	Flag Female Compressor Terminal	63
Dry R™	162	Electrical Toggle Switches	104	Flange Mount Conduit Assembly (bottom & side mount)	17
Dryer Cords	106	Electrolytic Copper Solderless Lugs	84	Flare Tee	171
Dryer Duct, Vent Hose, Hose Clamps	23	Electronic Degreaser	44	Flare Union	171
Dual Element Fuses - 250V	79	EMT (Thinwall) Fittings	94	Flare x FIP Union	172
Dual Element Fuses - 250V	101	EMT Strut Clamp	16	Flare x Flare Swivel Union	172
Duct Cleaning Brush	119	Equipment Stands	11	Flare x MIP Elbow	170
Duct End (EasyGuard™)	150	EVA Anti-Vibration Pad	6	Flare x MIP Reducing Elbow	170
				Flare x MIP Union	171
				Flash Detect UV Leak Detection Kit	159

CATEGORY INDEX cont'd

Flat Surface Adapter	15	General Purpose Relays.....	100	Hef-T-Block™	8
Flat Wall Escutcheon		General Purpose Spray Paint.....	48	Hef-T-Brackets™	9
(SpeediChannel™).....	147	General Purpose Switching Relays..	100	Hef-T-Foot™	9
Flat Washers	75	General Purpose Vinyl Electrical		HEMImini™	123
Flex Duct Tape	25	Tape.....	108	HEMIPLUS™ 2	123
Flex Hose Connection Kit		General Tools	74	Hex Head Cap Screws.....	75
(EasyGuard™)	150	Generator Power Cord Sets	106	HF™ Contact Cleaner	43
Flex Inject® Sealant Advanced & Total		Glass Cleaner.....	42	H-Frame Kits.....	16
.....	160	Glass Cloth, Moisture, Sealing &		High Heat Spray Paint	48
Flex Joint (SpeediChannel).....	147	Economy Electrical Tape	107	High Rise Pans	40
Flex Light.....	123	Glycols.....	156	High Temp Red Silicone Sealant ..	52
Flexible Refrigerant Line.....	178	Gorilla Tube Clear Vinyl Tubing....	39	High Temperature Assortment	
Flexi-Patch™	51	Grease Fittings	78	Terminals	66
Flow Plus® Condensate Pan		Grip-Cut	42	High Temperature Butt Connectors ..	66
Treatment.....	164	Grommets - Vinyl	110	High Temperature Female Slip-Ons..	66
Flue Caps.....	22	Ground Adapter	81	High Temperature Flag Female Slip-	
Flushing Products	157	Ground Fitting Clamp.....	84	Ons.....	66
Foam Insulation Tape.....	39	Grounding Rubber Handle Plug... 80		High Temperature Male Slip-Ons..	66
Foam Sealant - One Component .51		Hand Cleaners	45	High Temperature Range Wire	80
Foam-Plus™ Aerosol Foaming Coil		Hand Warmer	50	High Temperature Rings	66
Cleaner	156	Hanging Brackets	13	High Temperature Solderless	
Foil Scrim Kraft Tape	25	Hanging Strap	128	Terminals	66
Fully Insulated Dead End		Hanging Wire	24	High Temperature Spades	66
Connectors	64	Hard Start Kits	98	High Temperature Wire.....	114
Fully Insulated Female Slip-Ons... 62		Heat Pump Pad	6	Hooks, Springs and Fixture Support..	18
Fully Insulated Flag Female Slip-Ons. 63		Heat Pump Risers	8	Horizontal Air Handler Stand	12
Fully Insulated Male Slip-Ons	62	Heat Pump Stand	11	Horizontal Refrigerator/Freezer	
Fully Insulated Receptacles.....	63	Heat Resistant Cloth	130	Analog Thermometer	129
Furnace Mounting Blocks.....	8	Heat Shrink Tubing - 50% Polyolefin		Horizontal Vent Termination Kits... 29	
Furnace Pans	40	110	Hose Clamps - Devoc	77
Fuse Adapters, Blocks, Pullers.... 102		Heat Shrink Tubing Assortments... 83		Hose Clamps - Plumbing	140
Fuse Holders	82	Heating Equipment Service Products		Hose Mender (Barb x Barb)..... 133	
Fuses	101	28	Hoses, Sprayers	158
Fusible Links	111	Heavy Duty Cable Ties.....	24	Hot Water Hose	158
Garden Hose	158	Heavy Duty Cable Ties.....	115	HVAC Mini-split Wiring Solutions 113	
Garden Hose Adapters	132	Heavy Duty Degreaser	44	HVAC Tools	127
Gas Ball Valve	31	Heavy Duty High Rise Pans.....	40	Hydrogauge Manometer	124
Gas Equipment Service Tools	28	Heavy Duty Nylon Cable Ties.....	72	Ice Machine Products	159
Gas Pressure Test Kit.....	124	Heavy Duty PVC Cement	134	Icemaker Kit	140
Gauges	118	Heavy Duty Silicone Mold Release..47		Indicator Lights.....	83
Gauges	123	Heavy Duty Tri-Tap Extension Cord -		Industrial Enamel	48
General Policy	184	3 Outlets	106	Industrial Towels	45
General Purpose Pumps	36	Heavy Duty Work Gloves	49	In-Line Fuse Holder.....	102

In-Line Tri-Tap Portable GFCI	107	Low Profile Disconnects - Metal Case	92	Monitors - Tools	125
Insta-Charge.....	174	Lubricants	46	Motor Brackers	91
Insta-Tap Refrigerant Recovery Tool..	169	LuxPro Thermostats.....	111	Motor Mount - Flex Bracket.....	91
Insulated Butt Connectors	64	Machine Screw Hex Nuts	75	Motor Run Capacitors - 370VAC ..	95
Insulated Female Slip-Ons	62	MAC-The Ultimate in Line Piercing Valves	169	Motor Run Capacitors - 440VAC ..	96
Insulated Hooks.....	64	Made in the U.S.A. Capacitors Oval & Round Metal Can	97	Motor Run Capacitors (USA made)..	97
Insulated Male Slip-Ons	62	Magjumper	128	Motor Shaft Key Assortments.....	77
Insulated Plugs.....	63	Magnetic Hex Chucks	74	Motor Start Capacitors (110/125 VAC, 220/250 VAC, 330 VAC).....	97
Insulated Rings, Spades, Spring Spades	65	Male Adapter (Barb x MIPT).....	132	Motors	86
InsulClips	15	Male Adapter (MIPT x Slip)	138	Mounting Accessories.....	13
IoPhic Smoke & Fire, Carbon Monoxide & Natural Gas Alarm ...	31	Male Adapter C x M (Copper)	165	Mounting Blocks.....	8
Iso-Cube Economy Anti-Vibration Pad	6	Male Adapter Elbow (Barb x MIPT) .	133	Mounting Brackets.....	9
Jackson Safety G40 Foam Nitrile & Latex Coated Gloves	50	Male Adapter Reducing (MIPT x Slip)	139	Mounting Straps	19
Jackson Safety V30 Nemesis Safety Glasses	50	Malleable Black Iron Pipe Fittings	32	Multi Color Test Leads	128
J-B Weld	51	Manifold Gauges	123	Multi-Head Fin-Tool	121
J-Hooks.....	18	Manometers, Pressure and Test Kits.	124	Nitrile Gloves.....	49
Kimberly-Clark® Waterless Hand Wipes	45	Manual Reset Fire Stat	111	Nitrogen Cylinders	118
Kimtex® Shop Towels.....	45	Map-Pro and Propane Gas	130	Nitrogen Purge Tool	118
KleenGuard®	44	Markers.....	48	Non-Insulated Female Slip-Ons ...	62
Knock'er Loose® Penetrating Solvent ..	46	Masks	50	Non-Insulated Flag Female Slip Ons .	62
Knockout Seals and Hole Plug.....	73	Masonry Bit	53	Non-Insulated Male Slip-Ons.....	62
Kut-All Plastic Tube and Hose Cutter	130	Masonry Screw.....	53	Non-Insulated Rings	65
Large Mini-Split Stands	11	Medium Orange CPVC Cement .	134	Non-Insulated Spades.....	65
Lashing Strap	127	Medium Split Lock Washers	75	Non-Metallic Sheathed Cable (Romex Wire)	94
Latex Gloves.....	49	Merchandising	183	Nuts and Bolts.....	75
Leak Detectors and Accessories	159	Metal Bat Handle Toggle Switches ..	82	Nylon Cable Clamps	77
Leak Sealants.....	160	Metal Drive Anchors.....	68	Nylon Cable Ties.....	73
Leak Test Gauge	129	Metal Guard Trouble Lights.....	121	Nylon Cable Ties with Mounting Hole.....	72
Leather Work Gloves	49	Metal Parts Boxes	78	Nylon Fittings	132
Line Piercing Valves and Tools ...	169	Metallic Duct - 2 Ply	24	Oatey® Products	134
LineSet Box	175	Metallic Duct - 5 Ply	23	Odor Neutralizers	161
LineSet Cutting Tools.....	148	Mini-Split Condensate Drain Line..	38	Offset Snips.....	127
Liquid Line Driers.....	173	Mini-Split Double Stack Stand	11	One Piece Heat Pump Risers.....	8
Liquid Tite Connectors.....	93	Mini-Split Drain Adapters.....	41	One Time Fuses.....	101
Liquid-Tite Connectors	72	Mini-Split Dual Fan Stands	11	One-Handed PVC/hose cutter....	130
Literature.....	182	Mini-Split Stands	10	Outdoor Extension Cord	121
Louvered Dryer Vent Hood.....	23	Mini-Split Super Stand	11	P.O.P. Merchandisers / Displays .	183
		Miscellaneous Tools.....	124	Paints and Primers	48
		Molded Case Switch Disconnect .	92	Pan Treatments/Disinfectants.....	164
		Monitors - Electrical.....	103		

CATEGORY INDEX cont'd

Pan-Kote Heavy Duty Drain Pan Patch	156	Power Cords and Work Lights	76	Purple Primer for PVC Pipe and Fittings	134
Pan-Patch	156	Power Sprayer	158	PVC Cement - Clear	134
Parts Cleaning Brush	119	Power Supply Cords (Pigtails)....	106	PVC Condensate Pipe	136
Patriot Pocket Worklight	160	Power Supply Replacement Cords	81	PVC DWV Fittings.....	136
Periscope Connection Kit	24	Pro-Air Duct Sealant – UL 181 AM-BM Listed	52	PVC Gray Cement for High Efficiency Furnaces, Vent and Make-Up Air	134
Pigtails	84	Pro-Air Industrial Grade Spray Adhesive	52	PVC Primer - Clear	134
Pipe Hanging Strap.....	77	Pro-Blue™	154	PVC Primer and Cement	135
Pistol Grips & Water Nozzle.....	158	Pro-Brown™	154	PVC Schedule 40 Pressure Fittings .	137
Pitched Roof Mini-Split Mounting Bracket.....	10	Pro-Bubble™ Leak Detector	159	QD® Contact Cleaner.....	43
Pivot™ Lights	122	Pro-Flush® HVAC Flushing Solvent..	157	Quick Swivel “U” Mount - Unit Heater Bracket.....	13
Plan-O-Gram for Devco Combo Rack..	59	Pro-Green™	154	Quick Swivel Flush Mount w/ “H” Bracket - Unit Heater Bracket	13
Plan-O-Gram for Devco Elec Rack.	57	Pro-Kleen™	155	Quick Swivel Flush Mount w/ “I” Bracket - Unit Heater Bracket	13
Plan-O-Gram for Devco Ezc Rack.	58	Pro-Lube™ Mineral Oil.....	161	Quick-Sling® Air Handler Hanging Bracket.....	13
Plastic DWV J-Hooks.....	140	Pro-Lube-POE Polyolester	161	Quick-Sling® Accessories - Steel & Wood Beam Adapters	14
Plastic Hanger Strap	24	Pro-Lube-VAC™ Vacuum Pump Oil .	162	Quick-Tap	169
Plastic Thermostat Guards.....	112	Pro-Prime™ Clear PVC Primer....	135	Radiant Leak Finder.....	159
Plastic Wall Plates	104	Pro-Prime™ PVC Primer (Purple)	135	Rain-R-Shine Blue Cement	134
Plastic White End Caps	17	Pro-Red Plus™	155	Range Cords	106
Plastic Wide Mouth Dryer Vent Hood.	23	ProTek™ BG for Cast Iron Water Boilers	157	Rapid Positioning Clips	14
Plated Steel Utility Covers	70	ProTek™ Closed Loop Heat Transfer Fluid	157	Ratchet Strap	128
Plenum Duct Strap - UL rated	24	ProTek EG™	156	Rayovac® Lantern Batteries	43
Plenum Thermostat Wire	112	ProTek PG 100™	157	Rayovac® Industrial Maximum Alkaline Batterie (Shrink & Contractor packs)	43
Plenum-Rated Condensate Switches..	38	ProTek PG Plus™	157	Receptacles	81
Plug - Heating Products	33	Pro-Thaw™ Liquid Dryer for Refrigerants.....	162	Reducer Bushing (SPIG X FIPT)..	139
Plug - Inline Components.....	171	PRO-TITE™ Resin Based Thread Sealant	162	Reducer Bushing (SPIG x Slip) ..	139
Plug (MIPT)	138	Pro-Treat®	164	Reducer Coupling (EasyGuard) .	150
Plug (Slip).....	138	Pro-Treat® 350 Condensate Drain Pan Treatment	164	Reducer Coupling (SpeediChannel) .	147
Plug Fuses	102	Pro-Treat® Pan Strips.....	164	Reducer Coupling w/Stop C x C (Coupling).....	166
Pocket 4-in-1 Mini Screwdriver ..	126	Pro-Weld™ PVC Cement	135	Reducing Coupling - Heating Products.....	33
Polyethylene Tubing	140	Pro-Weld™ Weather - ALL	135	Reducing Tee.....	33
Polypropylene Parts Boxes.....	78	Pro-Yellow™	155	Reducing Washers.....	73
Polyvinyl Chloride, White PVC 1120.	136	PTFE Tape.....	39	Refractometer.....	125
Porcelain Outlet Box Lampholders .	82	P-Traps (Copper)	167		
Porcelain Wire Connectors	84	Pull-A-Spout Oiler	47		
Porcelain Wire Connectors	115	Pump Parts & Accessories	36		
Portable Hand Torch.....	130	Pure-Beam™ Ultraviolet Light.....	23		
Posters.....	183				
Potential Relays.....	100				
Powder Free Unlined Nitrile Disposable Gloves	49				
Power Blocks	121				

Refrigerant Charging.....	174	Screwdrivers, Driver Sets	126	Special Purpose Solderless	
Refrigerant Labels.....	178	Screwloose Industrial Penetrating		Terminals	63
Refrigerant Recovery Cylinders &		Oil	46	Specialty Fasteners.....	77
Products.....	179	Screws	76	Specialty Fittings	78
Refrigerant Tubing.....	175	Sealant, Epoxy, Glue	51	SpeediChannel™ Accessories....	148
Refrigeration Oils.....	161	Sealing Compounds, Adhesive	51	SpeediChannel™ Line Set Cover	
Refrigerator Coil Brush	119	Seal-N-Go® Self-Sealing Refrigerant..	160	System.....	145
Refrigerator/Freezer Analog		SeekerMax™	160	SPIN Tools	125
Thermometer.....	129	SeekerMini™.....	159	Split Bolt Connectors	84
Regulators.....	118	Self Tapping Water Valve	140	Spotlight	125
Rehvac Nitrogen Purging Equipment..	118	Self-Drilling Gypsum Wallboard		Spring Fittings & Beam Clamps... 17	
Rehvac Refillable Gas Cylinders	118	Anchors	68	Spring Steel Beam Clamps.....	17
Relays.....	100	Self-Drilling Screw Repair Kit	76	Spring Steel Cable Clip	17
Replacement Compressor Leads	107	Self-Drilling Screws.....	76	Standard Solderless Terminals....	64
Replacement Element Kits	111	Self-Sealing Split Tubing Insulation.	180	Standard Wire Connectors	84
Replacement Power Supply Cord .	106	Semi-Rigid Aluminum Duct	23	Staples and Staple Guns.....	124
Right Angle GFCI Plug - Field Wired .	107	Sentry™ Refrigerant Locking Caps .	164	Sta-Plex™ Premium Red Grease ..	47
Right Angle Plug	81	Sentry™ Universal Key for		Steel 1900 Boxes	70
Right Angle Tri-Tap Portable GFCI	106	Refrigerant Locking Cap	164	Steel 1900 Covers	71
Rigid Conduit Bodies	71	Sequencers.....	111	Steel Thermostat Guards.....	112
Rigid Strut Clamp	15	Set Screws	77	Steel Utility Boxes	70
Romex Connectors - Metallic.....	94	Sheet Metal Screw Assortments... 76		Stick-E-Tape.....	25
Roof Bracket.....	13	Sheet Metal Screws	53	Sting Less Wasp & Hornet Killer ..	54
Roof Flashing	22	Shoe Covers.....	49	Storage Containers.....	78
Roof Inlets.....	149	Shop Towels	46	Stove Bolts	75
Roof Louver	22	Short Forged Flare Nut.....	171	Stranded Copper Wire in Clear	
Round Extension Cords.....	76	Short Nut	171	Dispenser Pack, 194°F	113
Rubber / Cork Anti-Vibration Pad....	6	ShuBee® Shoe Covers.....	49	Stranded Copper Wire on Spool	113
Rubber Connector	81	ShuBee® Surface Liner.....	54	Stranded High Temperature Wire .	80
Rubber Tie Down Strap.....	128	ShuBee® Trishield Coverall	44	Strapping Hanger Iron.....	24
Safety Plates	71	ShuBee® Black Gauntlet® Silver		Straps	73
Safety Supplies, Devices	48	Edition Nitrile Disposable Gloves.	49	Straps, Truck Rope.....	127
Saf-N-Kleen™ Aerosol Solvent Coil		Sight Glasses	174	Strut Clips & Clamps	14
Cleaner.....	158	Silicone Sealant	52	Strut, Threaded Rod and Accessories .	16
Sani C-N-D™ Coil and Drain Pan		Single Piece Liquid Tite Fittings ...	93	Strut to Beam Clamps.....	16
Disinfectant.....	158	Single Portable GFCI Adapter.....	107	Studded Clips.....	14
Satchel Style Case.....	78	SJTO Service Cord	80	Suction Line Driers	173
Saws and Saw Blades.....	126	Slip-On Solderless Terminals	62	Super Change™.....	157
Scotch® 35 Vinyl Electrical Tape	108	Smokeys	22	Super Glue.....	51
Scotch® 3M Super 33+ Electrical		Snips, Notchers, Crimpers, Seamers..	127	Super Seal™ Sealant Advanced .	160
Tape.....	108	Soffit Fitting (EasyGuard)	149	Super Seal™ Sealant Sure Shot	161
Scotch® 3M Super 88 Electrical Tape		Soffit Fitting (SpeediChannel) ...	145	Super Seal™ Sealant Total.....	160
.....	108	SP-400 Corrosion Inhibitor	47	SuperComb.....	122

CATEGORY INDEX cont'd

Super-Kool™ Nickel-Safe & Metal	The Black Pad Black Plastic	Truestart Flame Sensors..... 29
Safe Ice Machine Cleaner..... 159	Equipment Pads 5	Truestart Ignition Accessories 29
Supports 140	The Hurricane Pad Concrete	Tube Working Tools 130
Sure-Stick Heavy Duty Adhesive	Equipment Pads 4	Tubing Insulation 179
Spray 42	The Hurricane Pad Tie Down Clips . 5	Tubing, Clamps, and Kits 140
Surface Protection 54	The Purifier™ 161	Twist-On Wire Connectors 115
Surge Protectors 104	Thermal Controls 111	Two Piece Heat Pump Risers 8
Surge-Trap Type 1 STXH, STXR.... 104	Thermometers/Probes..... 129	Two-Piece Liquit Tite Fittings 94
Sweat-Free Pipe Insulation Spray 42	Thermoplastic Handle Plug 80	Type "S" Non-Tamper Fuses..... 102
Switch Covers..... 105	Thermostat Guards 112	UL Certified Universal Circuit Breaker. 105
Switch/Plug Combo 105	Thermostat Wire - Devco 80	UL Listed Foil Tape 26
Swivel Head Deburring Tool..... 130	Thermostat Wire - Electrical 112	Ultra Lite® 3-36® Ultra Thin Non
Swoosh® Gun & Cartridges 37	Thermostats 111	Staining Lubricant 46
System Cleaners..... 162	THHN Stranded Hook-Up Wire..... 79	UltraLite® Lightweight Concrete
T-50 Series Staples and Staple Guns. 124	Thinwall E.M.T. Connectors..... 72	Equipment Pads 2
Tab Adapters 64	Thread Sealant with PTFE..... 51	UltraLite® Wedge Pads 2
Tandem Grounding Rubber Handle .80	Thread Sealants 162	Union - Heating Products 33
Tankless Water Heater Connection	Time Delay Fuses 101	Union Coupling (EasyGuard).... 150
Kits 30	Time Delay Plug Fuses..... 101	Union Coupling (SpeediChannel). 146
Tap Connectors 64	Time Delays 103	Universal Alarm 36
Tape - Heating Products 34	Tin Handle Acid Brushes 119	Universal Pump Elbow 148
Tape - Devco 78	T-Joint (EasyGuard) 150	Universal Silicon Carbide Igniters.. 28
Tapes - Condensate Management 39	T-Joint (SpeediChannel) 146	Universal Spun Copper Driers.... 173
Tapes - Air Movement..... 25	Toggle Bolts..... 75	Universal Strut Clamp 15
Tattle-Tale Control Monitor..... 125	Toggle Switch and Receptacle	UN-Purple Primer 135
T-Bar Scissor Clips 18	Combo Device..... 81	Upright Snips..... 127
Tee..... 33	Toggle Switch Cover 106	Utility Covers 70
Tee (Barb x Barb x Barb) 133	Toggle Switch with Neon Pilot Light	Utility Fuse Outlets..... 82
Tee (Slip x FIPT x Slip) 137	Combo Device..... 82	Utility Plates 70
Tee (Slip x Slip x Slip) 137	Toggle Switches - Devco 82	U-Type Strap (Copper) 167
Tee C x C x C (Copper) 167	Toggle Switches - Electrical..... 106	UV Pocket Light 160
Teflon Tape 78	Tongue and Groove Pliers 120	Vacuum Pump Oil 162
Teri® Reinforced Towels 45	Torque Plus - Hard Start Kits 98	Valve Action Marker 48
Terminals, Connectors..... 107	Transformers 100	Valve Action Paint Marker..... 48
Terry Towels 46	Transparent Plastic Boxes with	Vent Termination Kits..... 29
Test Cord (Female) 129	Terminal Assortments..... 107	Ventilation Products..... 22
Test Kits..... 162	Traps 137	Versa Cap Flue and Hot Stack 22
Test Leads - Devco..... 79	Tri-Fold Brochures 182	Vertical Air Handler Stand 12
Test Leads 128	Triple Outlets 81	Vibration Isolation Strips for Mini-
Testers 129	Triple-D® Universal Coil Cleaner 154	Split & VRF/VRV12 12
Testers, Leads, Clips, Fuses 79	Trouble Lights 76	Vinyl Grommet Assortment Packs . 83
TFFN Stranded Hook-Up Wire..... 79	Truck Rope 127	VRF/VRV SuperStand..... 12
	Truestart Hot Surface Igniters 28	Wagner® Adhesive Sealant..... 51

Wagner® Direct Drive Furnace Blower Motors	87	Wire/Cable Ties, Mounts, Clamps .	115
Wagner® High Temperature Condenser Fan Motors.....	86	Wiring Devices	80
Wagner High Temperature Multiple Horsepower Condenser Fan Motors .87		Wolverine® Universal Hot Surface Igniter	28
Wagner® Multiple Horsepower Condenser Fan Motors.....	86	Worklights by Cliplight®.....	121
Wagner® Multiple Horsepower Furnace Blower Motors	87	WypAll® Plus Towels	45
Wagner® Single Speed Condenser Fan Motors.....	86	WypAll® ShopPro X80 Towels.....	45
Wall Bracket Siding.....	10	WypAll® X70 Cloths	46
Wall Brackets (Flat Wall, Siding, Foundation Mount).....	9	Yellow Epoxy Coated Gas Connectors	30
Wall Escutcheon (SpeediChannel) .	147	Yellow PTFE Thread Seal Tape.....	34
Wall Penetration (EasyGuard) ...	149	Yellow PTFE Thread Seal Tape	42
Wall Penetration (SpeediChannel) .	145	Z Purlin Hanger	17
Wasp & Hornet Killer by Enforcer .	54	Zinc Plated DC Steel Romex Connectors	71
Wasp, Hornet, and Yellow Jacket Killers.....	54	Zinc-It® Instant Cold Galvanize....	47
Water Heater Pans.....	38		
WD-40®	47		
Weatherproof Box with Lever Switch Cover	71		
Weatherproof Boxes & Covers.....	71		
WeatherShield.....	13		
Welder's Brush	119		
Welding Torches, Supplies.....	130		
Whips	91		
White Lithium Grease	46		
White Nylon Ties with Mounting Hole.....	116		
White Nylon Wire Ties	116		
White Pipe	178		
Wind Baffles.....	13		
Winged Wire Connectors	83		
Wire.....	79		
Wire and Cable Clamps - Nylon .	116		
Wire Connectors.....	114		
Wire Connectors-Contractor	115		
Wire for Mini-Split Installation....	112		
Wire Tie Mounts.....	116		

PART NUMBER INDEX

0171451	1425022	1754516	189-22722097	230-14-7112
0172451	1434022	1754616	189-22733097	230-18-4112
02033179	145-17597	1754716	1940019	230-AFB3145
02053179	145-17522097	1761616	1940119	230-AFB3W145
02100179	145-17533097	1761816	1940219	230-AFB4145
02255179	161-19397	1762616	1942619	230-AFB4W145
04022178	161-19322097	1762816	1943619	230-B2L9
04044178	161-19333097	1763016	1943719	230-B2M9
04099178	1636-33	1763216	1943819	230-BP17W8
04134178	1649152	1763316	1943919	230-CP3146
04137178	16500130	1763416	1944019	230-CP3B146
04402178	16510130	1763616	1944119	230-CP3W146
04407178	16520130	1763816	1944319	230-CP4146
04410178	170AIR161	1768217	1944419	230-CP4B146
04421178	170AIRFAN161	1768417	1944519	230-CP4W146
04850178	170AIRPCB161	1801617	1944619	230-CP6146
1000-120097	171AIR161	1801817	1946319	230-CP6W146
1002158	1741216	1802617	1949019	230-CUTTER148
108-13097	1742016	1805017	1949219	230-D3A145
108-13022097	1743016	1805218	1949419	230-D3B145
108-13033097	1743816	1805418	1949619	230-D3W145
10816110	1744216	1805618	1949819	230-D4A145
111110160	1745016	1805818	1950019	230-D4B145
111110A160	1745216	1806018	1950119	230-D4W145
111112122	1745416	1812317	1950219	230-D6145
111113122	1746216	1812417	1950319	230-D6W145
111114122	1746416	1813018	200-24097	230-DC3147
111115122	1751515	1814018	20122157	230-DC3W147
111116122	1751615	1816017	20122159	230-DC4147
111117122	1751815	1816117	20133160	230-DC4W147
111118122	1751915	1818017	20-3132-1831	230-DC6147
111121123	1752015	1820017	20-3132-2431	230-DC6W147
111123122	1752115	1820217	20-3132-3631	230-DCLIP148
111128123	1752215	1823117	20-3132-4831	230-DCLIP-10148
111130123	1752315	1823217	20-3135-1831	230-DE3147
111131123	1753215	1824017	20-3135-2431	230-DE3B147
111133123	1753315	1837018	20-3135-3631	230-DE3W147
114301123	1753415	1838718	20-3135-4831	230-DE4147
114302123	1753515	1842118	216-25997	230-DE4B147
124-15697	1753615	1842218	216-25922097	230-DE4W147
124-15622097	1753715	1842518	216-25933097	230-DE6147
124-15633097	1754216	1842618	2301049	230-DE6W147
1414522	1754316	1842718	230-14-4112	230-DL1638
1417522	1754416	189-22797	230-14-4S112	230-DL16-2038

PART NUMBER INDEX cont'd

230-DLF16 38	230-FH4-KITW 148	230-TJ4W 146	30-3132-30 31	37200H 95
230-DLF18 38	230-FJ3 147	230-TJ6 146	30-3132-36 31	37200R 95
230-DLF20 38	230-FJ3W 147	230-TJ6W 146	30-3132-48 31	37250H 95
230-DLF25 38	230-FJ4 147	230-WC3 145	30-3132-60 31	37250R 95
230-DLF32 38	230-FJ4W 147	230-WC3B 145	30-3132-72 31	37300H 95
230-DLFY 38	230-FR3 147	230-WC3W 145	3036-2 3	37300R 95
230-DPPL 38	230-FR3W 147	230-WC4 145	3036-3 3	37300R-SWP 95
230-DPPM 38	230-FR4 147	230-WC4B 145	3040-2 3	37350H 95
230-DSCREW 148	230-FR4W 147	230-WC4W 145	3040-3 3	37350R 95
230-EB3 146	230-FR6 147	230-WC6 145	3143-2 3	37350R-SWP 95
230-EB3B 146	230-FR6W 147	230-WC6W 145	315-20 42	37400H 95
230-EB3W 146	230-IK3 148	230-WR3 147	3232-2 3	37400R 95
230-EB4 146	230-IK3W 148	230-WR3W 147	3232-3 3	37450H 95
230-EB4B 146	230-IK4 148	230-WR4 147	3237-3 3	37450R 95
230-EB4W 146	230-IK4W 148	230-WR4W 147	324-388 97	37500H 95
230-EB6 146	230-IKC3 148	230-WR6 147	325-12 42	37500R 95
230-EB6W 146	230-IKC3W 148	230-WR6W 147	340-408 97	37550R 95
230-EIN3 146	230-IKC4 148	230-WS2 145	3434-2 3	37600H 95
230-EIN3B 146	230-IKC4W 148	233-292 97	358-20 156	37600R 95
230-EIN3W 146	230-INJ462 149	233-292220 97	362-16 42	37700H 95
230-EIN4 146	230-INJ465 149	2424-2 3	3636-2 3	37800H 95
230-EIN4B 146	230-LFB3 146	2424-3 3	3636-3 3	37800R 95
230-EIN4W 146	230-LFB3B 146	2436-2 3	3640-2 3	378-440 97
230-EIN6 146	230-LFB3W 146	2436-3 3	3640-3 3	3842-3 3
230-EIN6W 146	230-LFB4 146	2442-2 3	3648-2 3	3GJ0330 95
230-FB3 145	230-LFB4B 146	24-458 122	3648-3 3	3GJ0515 95
230-FB3B 145	230-LFB4W 146	24-460 122	3660-3 3	3GJ0520 95
230-FB3W 145	230-LFB6 146	2448-3 3	37030H 95	3GJ0525 95
230-FB4 145	230-LFB6W 146	25001 127	37040H 95	3GJ0530 95
230-FB453 146	230-MB14W 8	2601 158	37050H 95	3GJ0535 95
230-FB453B 146	230-MB17W 8	2602 158	37050HB 95	3GJ0540 95
230-FB453W 146	230-MB36W 8	2603 158	37050R 95	3GJ0545 95
230-FB454 146	230-MBCW 8	2626-3 3	37060H 95	3GJ0555 95
230-FB454B 146	230-PFB3 148	270-324 97	37075H 95	3GJ1025 95
230-FB454W 146	230-SF3 145	270-324220 97	37075HB 95	3GJ1060 95
230-FB456 146	230-SF3W 145	270-324330 97	37075R 95	3GJ1520 95
230-FB456W 146	230-SF4 145	3030-2 3	37100H 95	3GJ7530 95
230-FB4B 145	230-SF4W 145	3030-3 3	37100HB 95	3GJ7535 95
230-FB4W 145	230-TC34 147	30-3131-24 31	37125H 95	3GJ7545 95
230-FB6 145	230-TC34W 147	30-3131-36 31	37125R 95	3GJ7555 95
230-FB6W 145	230-TC46 147	30-3131-48 31	37150H 95	3GR0325 95
230-FH3-KIT 148	230-TC46W 147	30-3132-12 31	37150R 95	3GR0330 95
230-FH3W-KIT 148	230-TJ4 146	30-3132-18 31	37175H 95	3GR0335 95
230-FH4-KIT 148	230-TJ4B 146	30-3132-24 31	37175R 95	3GR0340 95

PART NUMBER INDEX cont'd

3GR0425.....95	4226CX.....66	45350H.....96	4JJ0530.....96	4JR7550U.....97
3GR0435.....95	4231.....66	45350HU.....97	4JJ0535.....96	4JR7555.....96
3GR0515.....95	4252.....66	45350R.....96	4JJ0540.....96	4JR7555U.....97
3GR0520.....95	4252CX.....66	45400H.....96	4JJ0545.....96	4JR7560.....96
3GR0525.....95	4253.....66	45400HU.....97	4JJ0555.....96	4JR7560U.....97
3GR0530.....95	4253CX.....66	45400R.....96	4JJ0560.....96	4JR7570.....96
3GR0535.....95	4254CX.....66	45450H.....96	4JJ1055.....96	4JR7580.....96
3GR0540.....95	4293.....84	45450HU.....97	4JJ7535.....96	4WF-01.....161
3GR0545.....95	4293CX.....84	45450R.....96	4JJ7540.....96	5002.....74
3GR0550.....95	4294.....84	45500H.....96	4JJ7545.....96	50302.....25
3GR0555.....95	4294CX.....84	45500HU.....97	4JR0440.....96	5031.....79
3GR0560.....95	4296.....84	45500R.....96	4JR0520.....96	5033.....79
3GR0570.....95	4296CX.....84	4550-3.....3	4JR0525.....96	5035.....79
3GR0580.....95	43-53220.....97	45550H.....97	4JR0525U.....97	5036.....79
3GR1035.....95	436-20.....54	45550R.....97	4JR0530.....96	5041.....79
3GR1080.....95	45020H.....96	4558-3.....3	4JR0530U.....97	5042.....79
3GR7530.....95	45030H.....96	45600H.....96	4JR0535.....96	5046.....79
3GR7540.....95	45040H.....96	45600HU.....97	4JR0535U.....97	5053-3.....3
3GR7555.....95	45050H.....96	45600R.....96	4JR0540.....96	5-05790.....45
3GR7560.....95	45050HU.....97	45700H.....96	4JR0540U.....97	5-10.....134
3GR7580.....95	45050R.....96	45700HU.....97	4JR0545.....96	5-100020.....136
3WF-01.....161	45060H.....96	45700R.....96	4JR0545U.....97	5-100030.....136
400-480.....97	45075H.....96	45800H.....96	4JR0550.....96	510-437338.....136
4042-3.....3	45075HU.....97	45800HU.....97	4JR0550U.....97	510-438338.....136
410212.....161	45075R.....96	45800R.....96	4JR0555.....96	5107.....74
410239.....123	45100H.....96	460-552.....97	4JR0555U.....96	510-D102338....136
4200AX.....66	45100HU.....97	4700-12.....132	4JR0560.....96	510-D304020....136
4204.....66	45100R.....96	4700-34.....132	4JR0560U.....97	510-D304030....136
4204CX.....66	45125H.....96	4701-12.....132	4JR0570.....96	510-D309020....136
4205CX.....66	45125HU.....97	4701-34.....132	4JR0580.....96	510-D309030....136
4213.....66	45125R.....96	4703-34.....132	4JR0580U.....97	510-D323020....136
4213CX.....66	45150H.....96	4704-12.....132	4JR1055.....96	510-D323030....136
4214.....66	45150HU.....97	4704-34.....132	4JR1060.....96	510-D441020....136
4214CX.....66	45150R.....96	4706-34.....132	4JR1080.....96	5-11830.....22
4215.....66	45175H.....96	4707-12.....132	4JR7525.....96	5-11840.....22
4215CX.....66	45200H.....96	47072-12.....132	4JR7530.....96	5-11853.....22
4220.....66	45200HU.....97	47072-34.....132	4JR7530U.....97	5-11866.....22
4220CX.....66	45200R.....96	4707-34.....132	4JR7535.....96	5-11879.....22
4221.....66	45250H.....96	4711-12.....132	4JR7535U.....97	5-12.....134
4221CX.....66	45250HU.....97	4711-34.....132	4JR7540.....96	513-31403D.....39
4224.....66	45250R.....96	4718-12.....132	4JR7540U.....97	5-14.....134
4224CX.....66	45300H.....96	4766-3.....3	4JR7545.....96	515-J2000.....140
4224NX.....66	45300HU.....97	4848-3.....3	4JR7545U.....97	515-J3000.....140
4226.....66	45300R.....96	4JJ0525.....96	4JR7550.....96	5200.....76

PART NUMBER INDEX cont'd

5-2002 136	5380AX..... 77	540-42545 48	540-FCTMN1 127	5-4227R 45
5-2005 136	5381 77	5-405 136	540-FCTMS1 127	542-76220 119
5201 76	538-1/2 15	540-506 124	540-FCTMS2 127	5-429005 138
5223 81	538-1/2 172	540-508 124	540-GUN..... 158	5-429007 138
5230 76	538-1/4 15	540-509 124	540-HU1L..... 49	5-429010 138
5240 81	538-1/4 172	540-572 158	540-R8CCRF..... 126	5-429015 138
5242 81	538-1-1/8 15	540-573 158	540-RB125W 126	5-429020 138
5246 78	538-1-1/8 172	5-406005 137	540-RB414M..... 126	5-429030 138
5255 78	538-1-3/8 15	5-406007 137	540-RB418M..... 126	5-435005 138
525-MT1 130	538-1-3/8 172	5-406010 137	540-RB610HDM .126	5-435007 138
525-PT1 130	538-1-5/8 15	5-406020 137	540-RB614HDM .126	5-435010 138
525-TORCH 130	538-1-5/8 172	5-406030 137	540-RB618HDM .126	5-435101 138
5-300020 136	5382 77	540-648 97	540-RB624HDM .126	5-435102 138
5-300030 136	538-2-1/8 15	540-6510L..... 127	540-RB636DW ... 126	5-436005 138
530-10202 134	538-2-1/8 172	540-6510R 127	540-RB636W 126	5-436007 138
530-10203 134	538-2-5/8 15	540-6716B 127	540-RB656WS ... 126	5-436010 138
530-11029 134	538-2-5/8 172	540-6716L..... 127	540-RB810HDM .126	5-436074 139
530-11908 22	5383 77	540-6716R 127	540-RB814HDM .126	5-436101 139
530-11909 22	538-3/4 15	540-6716S 127	540-RB956W 126	5-436102 139
530-11910 22	538-3/4 172	540-6900L..... 127	540-T50M..... 124	5-436131 139
530-11911 22	538-3/8 15	540-6900R 127	540-T50MOC 124	5-437101 139
530-11919 22	538-3/8 172	5-407 136	5-41 126	5-437130 139
530-30752 134	538-3-1/8 15	5-407005 137	5-410 137	5-437131 139
530-30755 134	538-3-1/8 172	5-407007 137	5-410005 138	5-437210 139
530-30756 134	5384 77	5-407131 137	5-410007 138	5-438101 139
530-30757 134	538-4-1/8 15	540-799 48	5-410010 138	5-438131 139
530-30818 134	538-4-1/8 172	5-408 137	5-41041 45	5-447007 138
530-30821 134	5385 77	540-800 48	5-411 137	5-447010 138
530-30834 134	538-5/8 15	540-805 48	5-412 137	5-448007 139
530-30850 134	538-5/8 172	540-806 48	541-300 129	5-449007 138
530-30863 134	538-7/8 15	540-807 48	5-414 137	5-449030 138
530-30876 134	538-7/8 172	540-808 48	5-41411 46	5-450007 138
530-30884 134	5-401005 137	540-811B 48	5-41455 46	545-420 120
530-30885 134	540-1005L..... 49	5-409 137	5-416 136	545-422 120
530-30890 134	5-401007 137	5-409005 137	5-417 136	545-426 120
530-30891 134	5-401010 137	5-409007 137	5-417005 137	545-430 120
530-30893 134	5-401020 137	5-409010 137	5-417007 137	545-440 120
530-31132 134	5-401030 137	540-98237 48	5-417010 137	545-442 120
530-60445 135	5-402007 137	540-AK100..... 53	5-417012 137	545-460 120
5-32 134	540-2110C 43	540-BH1L..... 50	5-417020 137	5-474007 139
5-321020 136	540-2114 49	540-CARABINER.. 128	5-417030 137	5-61 126
5-321030 136	540-278BM0024 . 126	540-DB6 53	5-418 136	56-72 97
5-33570 45	540-278HX0002 . 126	540-DISP..... 43	542-25015 119	56-72220 97
5-34790 45	5-404 136	540-FCTMC5 127	5-42272 45	58278040 113

PART NUMBER INDEX cont'd

58282040 113	5-SCR83-4DPBULK.53	60251CX 62	6-12-6NMR 91	6-202-2 52
58282240 113	5-SCR81-12BULK..53	60252CX 65	6-12-6NMS 91	620-252 105
58282340 113	5-SCR81-12W 53	60254 65	6-12-6NMSP 92	620-253 105
585-F336..... 112	5-SCR81-2 53	60254CX 65	6-12-6NMSWP 92	620-254 105
585-TG 112	5-SCR81-25M..... 53	60254LX 65	6-12-8NMSWP 92	620-255 105
585-TG1 112	5-SCR81-2BULK... 53	60256CX 65	6182 82	620-274W 105
585-TG2 112	5-SCR81-2DP 53	60259HX 62	6183 82	6203E..... 88
585-TG3 112	5-SCR81-2DPBULK.53	60263BCX..... 72	6184 82	620-401 104
585-TG4 112	5-SCR81BULK..... 53	60263BLX 72	6185 82	620-403 104
585-TG5 112	5-SCR81DP 53	60263CX 72	6186 82	620-404 104
585-TG6 112	5-SCR81DPBULK... 53	60264BCX..... 72	6187 82	620-406 104
585-TG7 112	5-SCR82 53	60264CX 72	6193 83	620-409 104
585-TG8 112	5-SCR82-100 53	60265BLX 73	6194 83	620-411 104
585-TG9 112	5-SCR82BULK..... 53	60265LX 73	6195X..... 83	6205E..... 88
590-708 97	5-SCR82W 53	60331B 79	6-2 38	620-600 104
59351202 113	5-SCR83-4 53	60331BE..... 79	62000AX..... 73	620-601 104
59351203 113	5-SCR83-4BULK... 53	60331R 79	6200BSX..... 65	620-604 104
5-HW5850 158	5-SCR83-4DP 53	6-1 38	6200HX 63	620-605 104
5-IG5850 158	5-SCR83-4DPBULK.53	6101 77	620-10-2 94	620-608 102
5K006..... 89	5-SCRMS..... 53	6102 77	620-12-2 94	620-6081 102
5-SCR101 53	6000 77	6103E..... 88	620-14-2 94	620-6082 102
5-SCR101-12DP...53	60000 108	6105E..... 88	620-18-10 112	620-6083 102
5-SCR101-12DPBULK.53	6001 77	6107E..... 88	620-18-2 112	620-6-2 94
5-SCR101-2 53	60010 108	6110E..... 88	620-18-2P 112	620-700 104
5-SCR101-2DP 53	60020 108	6-1200 22	620-18-3 112	620-701 104
5-SCR101-2DPBULK.53	60030 108	61202 65	620-18-3P 112	620-702 104
5-SCR101BULK..... 53	60040 108	61214 65	620-18-4 112	620-703 104
5-SCR101DP 53	6005 88	61220 62	620-18-5 112	620-704 104
5-SCR101DPBULK.53	60050 108	61221CX 62	620-18-6 112	620-705 104
5-SCR102DP 53	60070 108	61221LX 62	620-18-6P 112	6207E..... 88
5-SCR102DPBULK.53	6010 88	61223LX 62	620-18-7 112	6208 64
5-SCR103-4 53	60100 108	61233LX 63	620-18-8 112	620-8-2 94
5-SCR103-4BULK..53	6011 77	61234LX 62	620-18-8P 112	6208LX..... 64
5-SCR103-4DP 53	60110 108	61235LX 62	620-200 105	6209 64
5-SCR103-4DP100.53	60200 108	6-12-4 91	620-201 105	6209LX..... 64
5-SCR103-4DPBULK.53	60202 108	6-12-4NM 91	620-20-10 112	6210 64
5-SCR61-2DP 53	60210 64	6-12-4NMSP 92	620-202 105	6210E..... 88
5-SCR61-2DPBULK.53	60210CX 64	6-12-4NMSWP 92	620-20-3 112	6211 64
5-SCR63-8 53	60210LX..... 64	61252NX 65	620-20-4 112	6211CX 64
5-SCR63-8BULK.... 53	60219 62	6-12-6 91	620-20-5 112	6212 64
5-SCR71-2 53	60220 62	61256LX 65	620-20-6 112	6212CX 64
5-SCR71-2BULK.... 53	60220LX..... 62	6-12-6NM-2 91	620-20-7 112	6213 62
5-SCR81 53	60247 65	6-12-6NM 91	620-20-8 112	6213CX 62
5-SCR81-12 53	60251 62	6-12-6NMP 92	6-202-1 52	6214 62

PART NUMBER INDEX cont'd

6214CX 62	6231LX 64	6255CX 65	626-20S 102	626-HASR25 101
6215 65	6232 64	6255LX 65	626-20T 101	626-HASR30 101
6216 65	6232CX 64	6257 65	626-23133 102	626-HASR40 101
6216CX 65	6232LX 64	6257NX 65	626-25 102	626-HASR60 101
6216LX 65	6233 62	6258 63	626-25T 101	6270 63
6217 64	6233LX 62	625-800 94	626-26311 102	6270LX 63
6217CX 64	6234 62	625-801 94	6262BCX 73	6272 65
6217LX 64	6234LX 62	625-810 94	6262BLX 73	6274 65
6218 62	6235 62	625-811 94	6262BMX 73	6274LX 65
6218CX 62	6235CX 62	6258CX 63	6262CX 73	6276 65
6218LX 62	6235LX 62	6259 63	6262LX 73	6276LX 65
6219 62	6236LX 65	6259CX 63	6262MX 73	6277 63
6219LX 62	6237 65	625-AF10 22	626-30 102	6277NX 63
6220 62	6237LX 65	625-AF12 22	626-30S 102	6281 62
6220CX 62	6238 65	625-AF14 22	626-30T 101	6281LX 62
6222 64	6238LX 65	625-AF6 22	626-38071 102	6282 62
6222LX 64	6239 65	625-AF8 22	626-38073 102	6282LX 62
6223 64	6239LX 65	625-B1 106	626-38632 102	6283LX 63
6223LX 64	623-MIX 115	625-CL115 105	626-38636 102	6285 63
6224 62	6241 64	625-CL120 105	6263BCX 73	6285LX 63
6224CX 62	6242 64	625-CL220 105	6263BDX 73	6286 63
6226CX 65	6242LX 64	625-CL230 105	6263BLX 73	6287CX 64
6227 65	6244 64	625-CL240 105	6263CX 73	6287XX 64
6227LX 65	6244LX 64	625-CL250 105	6263DX 73	6288 63
6228 65	6251 62	625-CR15W 104	6263LX 73	6288LX 63
6228LX 65	625-1301W 104	625-CR20W 104	6264BCX 72	6289 63
6229 62	625-16-6 106	625-CS120W 104	6264CX 72	6289LX 63
6229LX 62	625-16-690 106	625-IS5 94	6264LX 72	6291 84
6230 64	625-183 94	625-S13 105	6265BCX 72	6291CX 84
623-000 114	6251CX 62	625-S14 105	6265BLX 72	6292 84
623-001 114	6251LX 62	625-S15 105	6266BLX 72	6292CX 84
623-002 114	6252 65	625-S16 105	626-6S 102	6293 84
623-003 114	625-2132B 104	625-S17 105	6267MX 73	6293CX 84
623-004 114	625-2132V 104	625-S18 105	6268BMX 73	6294 84
623-005 114	625-2132W 104	625-S19 105	6269 73	6294CX 84
623-006 114	625-2134V 104	625-S20 105	6269LX 73	6295X 84
623-007 114	625-2134W 104	626-10S 102	6269MX 73	6296 84
623-008 114	625-270W 104	626-10T 101	626-AT0003 102	6296CX 84
623-012 115	6252LX 65	626-15 102	626-AT0005 102	6298 84
623-013 115	625-304 94	626-15S 102	626-AT03LED 102	6298LX 84
623-014 115	625-305 94	626-15T 101	626-AT05LED 102	6-3 38
6230CX 64	6253CX 65	6261BCX 73	626-HASR10 101	6301 89
6231 64	6253LX 65	6261CX 73	626-HASR15 101	6303 89
6231CX 64	6255 65	626-20 102	626-HASR20 101	6-3050 22

PART NUMBER INDEX cont'd

63070 83	6-34-6NMSP 92	6413 75	6603 75	68000HX 76
6310X 78	6-34-8 91	6414 75	6622 75	6803 89
6311 78	6-34-8NM 91	6415 75	6623 75	6853 76
6312 78	6360B 79	6416 75	6641 75	6855 76
6321 78	6360R 79	64235201 113	6642 75	6858 76
6-321 129	6360W 79	64275801 113	6643 75	6859 76
6322 78	6361B 80	64846401 113	6644 75	6865 76
6-330 39	6361R 80	6-5 38	6645 75	6866 76
6330-4 80	6362B 80	650-001 23	6685 75	6876 76
6330-6 80	6362W 80	650-002 23	6700AX 75	6900AX 76
6331 80	6363W 80	650-003 23	6701 75	6903 89
6332B 79	6364B 80	650-005 23	6702 75	6905 89
6332G 79	6364R 80	650-006 23	6703 75	6907 89
6332R 79	6364W 80	650-008 23	6703CM 88	6-9011 22
6332W 79	6365R 80	650-010 23	6704 75	6943CX 76
6333B 79	6370 83	650-011 23	6704-2X 75	6945CX 76
6333G 79	6371 83	650-012 23	6705CM 88	6946CX 76
6333R 79	6383-325 80	650-013 23	6706 75	6953CX 76
6333W 79	6383-35 80	650-014 23	6706-2X 75	6955CX 76
6334B 79	6384-325 80	650-016 23	6707CM 88	6956CX 76
6334G 79	6384-35 80	650-017 23	6-7090 22	6-9718 39
6334R 79	6401 75	650-020 24	6710CM 88	6-CT700F 129
6334W 79	640-122 94	650-021 23	6722 76	6-FT80H 129
6335B 79	640-142 94	650-023 23	6722-2X 76	6-FT80R 129
6335G 79	6402 75	650-031 23	6724 76	6-GPK035 124
6335R 79	6403 75	650-036 23	6724-2X 76	6-HAB-BG 12
6335W 79	6404 75	650-038 23	6730 75	6-HDT304K 129
6336 80	6405CM 88	650-074 23	6731 75	6-HG15 124
6337 80	6407CM 88	6500A 75	6732 75	6-M22 38
6338 80	640-845 94	6501 75	6733 75	6-M24 38
6339XL 80	640-AF2 25	650-100 22	6-733 39	6-M26 38
6340 80	640-AF25 25	6501CX 75	6-734 39	6-M2748 38
6341 80	640-AF3 25	6502 75	6735 75	6-M2763 38
6342 80	640-FD2B 25	650-200 22	6-735 39	6-M30 38
6343 80	640-FD2S 25	6503 75	6-736 39	6-M3030 38
6-34-4 91	640-FD3S 25	650-300 22	675-P521U 111	6-M3050 38
6-34-4NM 91	640-FSK2 25	6503CX 75	675-P621U 111	6-M3060 38
6-34-4NMSP 92	640-FSK3 25	6505 75	675-P721UT 111	6-M3263 38
6-34-6 91	640-UL25 26	6505LX 75	675-P722U 111	6-R50A 22
6-3460 109	640-UL3 26	6-5070 22	675-PSD010BF 111	6-REF401 125
6-34-6NM-2 91	6410CM 88	6526 75	675-PSD111 111	6-T1191 130
6-34-6NM 91	6411 121	6528 75	675-PSDH121 111	6-T482 130
6-34-6NMR 91	641-14 156	6601 75	675-PSM30SA 111	6-T744 126
6-34-6NMS 91	6412 75	6602 75	675-PSM40SA 111	701-001 132

PART NUMBER INDEX cont'd

701-002132	710-10125	7-1258179	7-381-38179	750-MLT9075.....93
701-003132	710-10225	7-1278179	7-381-58179	750-NMLT10093
701-006132	710-10325	7-12B39	7-382-18179	750-NMLT12593
701-007132	710-10424	7-12B5039	7-382-58179	750-NMLT15093
701-009132	710-10524	7-12P.....39	7-3834179	750-NMLT455093
701-011132	710-10624	7-1438	7-3838179	750-NMLT457593
701-012132	710-182G.....24	714268	7-3858179	750-NMLT5093
701-013132	710-185G.....24	7142LX.....68	7-38B39	750-NMLT5090-F..93
701-014132	7101CX69	714668	7-38B5039	750-NMLT7592
701-015132	7101HCX69	7-14B39	7-38P.....39	750-NMLT7590-F..93
701-017132	7102CX69	7-14B5039	7-5838	750-NMLT90100 ..93
701-018133	7102HCX69	7-14P.....39	7-608	750-NMLT90125 ..93
701-019133	7103CX69	7-20052	7-648	750-NMLT905092
701-020133	7-1058179	7233RLX.....68	7-400052	750-NMLT907593
701-023133	7105LX.....69	7234RLX.....68	7-400152	750-P60NF.....92
701-025133	7106CX69	7235RLX.....68	7-410052	750-RC84194
701-028133	7-1078179	7236RLX.....68	741-00147	750-RC84294
701-029133	710-A1610024	72-8822097	741-00247	750-SLTC5093
701-030133	710-A165024	72-8833097	741-00347	750-SLTC7593
701-031133	710-A171024	730268	7-420052	750-SLTC905093
701-032133	7-10KOTN100.....101	730368	7-430052	750-SLTC907593
701-033133	7-10KOTN30.....101	7311L.....68	7-440052	750-TZNMLT100...93
701-034133	7-10KOTN35.....101	7-31638	7-450052	750-TZNMLT125...93
701-035133	7-10KOTN40.....101	7316L.....68	750-1010093	750-TZNMLT150...93
701-037133	7-10KOTN45.....101	7316X.....68	750-1050093	750-TZNMLT200...93
701-038133	7-10KOTN50.....101	7317L.....68	750-1210093	750-TZNMLT38.....93
701-039133	7-10KOTN60.....101	7317X.....68	750-12100093	750-TZNMLT90100.93
701-040133	7-10KOTN70.....101	7321X.....68	750-12510093	750-TZNMLT90.....93
701-041132	7-10KOTN80.....101	7-3438	750-155093	750-TZNMLT90150.93
701-043132	7-10KOTN90.....101	7-3412179	750-205093	750-TZNMLT9038.93
701-046133	7-10P.....39	7-341-18179	750-2LTC5094	750-TZNMLT9050.93
703375	710-P10024	7-341-58179	750-2LTC7594	750-TZNMLT9075.93
703475	7111CX69	7-342-18179	750-2LTC905094	755-303SW92
7036X.....75	7111X.....69	7-342-58179	750-2LTC907594	7-5811115
7066X.....75	7-1238	7-3434179	750-3410093	7-5811-B115
708-85097	7-121-18179	7-3438179	750-3480093	7-58B39
7-1038	7-1212179	7-3458179	750-3810093	7-58B5039
7-10052	7-121-38179	7-3478179	750-401140	7-58P.....39
710-00124	7-121-58179	7-34B39	750-402140	7-711115
710-00224	7-122-18179	7-34B5039	750-50093	7-711-B115
710-00324	7-122-58179	7-34P.....39	750-60093	7-7838
710-00424	7-123-18179	7-3838	750-MLT50.....93	7-78P.....39
710-00524	7-1234179	7-3812179	750-MLT75.....93	7-8004552
710-10025	7-1238179	7-381-18179	750-MLT9050.....93	7-80643

PART NUMBER INDEX cont'd

7-80632 51	7-ECC1250 121	7-S20034 180	7-TLC10630 121	900-5 29
7-80633 51	7-ECC16100 121	7-S20038 180	800-008 52	900-6 29
799-001 48	7-ECC1625 121	7-S21010 180	800-009 52	900-8 29
799-002 48	7-ECC1650 121	7-S21012 180	8200M 78	900-9 29
799-003 48	7-ECC50725 121	7-S21034 180	8201C 78	91-2032 31
799-004 48	7-ECC50730 121	7-S21038 180	8203C 78	91-3042 31
799-005 48	7-ECC50735 121	7-S21810 180	8220M 78	92-3232 31
799-006 48	7-L300 24	7-S21812 180	8233 78	92-4242 31
799-010 48	7-L300 115	7-S21834 180	8282LX 83	9410SSR 160
799-011 48	7-P24 24	7-S21838 180	8284 83	944KIT 160
799-012 48	7-P24 115	7-S25810 180	8284CX-B 83	947KIT 160
799-021 48	7-P36 24	7-S25812 180	8286 83	948KIT 160
799-022 48	7-P36 115	7-S25834 180	8286CX-B 83	971KIT 160
799-024 48	7-P36B 24	7-S25838 180	829-995 97	972KIT 160
799-025 48	7-P36B 115	7-S31810 180	84DCPLUS 159	973KIT 162
799-040 48	7-P48 24	7-S31812 180	87DCPLUS 160	980 159
799-041 48	7-P48 115	7-S31834 180	88-108 97	98084KIT 159
7-AD010000 121	7-P48B 24	7-S31838 180	88-108220 97	98087KIT 159
7-AL9V 43	7-P48B 115	7-S3410 180	88-108330 97	981 157
7-AL9V-12 43	7-S0012 180	7-S3412 180	89000 106	983KIT 161
7-ALAA 43	7-S10010 180	7-S3434 180	89002 107	984 161
7-ALAA-24 43	7-S10012 180	7-S3438 180	89003 107	985 160
7-ALAAA 43	7-S11010 180	7-S35810 180	89006 107	990 159
7-ALAAA-18 43	7-S11012Y 180	7-S35812 180	89008 107	991 157
7-ALC 43	7-S11034 180	7-S35834 180	89009 107	992 162
7-ALC-12 43	7-S11038 180	7-S3810 180	89223 106	993KIT 162
7-ALD 43	7-S11810 180	7-S3812 180	89231 106	995 160
7-ALD-12 43	7-S11812 180	7-S3834 180	89233 106	999KIT 160
7-CRNR100 101	7-S11834 180	7-S3838 180	89236 106	A051 90
7-CRNR15 101	7-S11838 180	7-S40010 180	89238 106	A066 90
7-CRNR20 101	7-S1210 180	7-S40012 180	89312 106	A067 90
7-CRNR25 101	7-S1212 180	7-S40034 180	89350 106	A079 90
7-CRNR30 101	7-S1234 180	7-S41810 180	89DC 160	A081 90
7-CRNR35 101	7-S1238 180	7-S41812Y 180	8-FWH16 54	A129 90
7-CRNR40 101	7-S12512 180	7-S41834 180	8-WH16 54	A134 90
7-CRNR45 101	7-S13810 180	7-S5810 180	900-1 29	A140 90
7-CRNR50 101	7-S13812 180	7-S5812 180	900-10 29	A155 90
7-CRNR60 101	7-S13834 180	7-S5834 180	900-11 29	A157 90
7-CRNR70 101	7-S13838 180	7-S5838 180	900-14 29	A163 90
7-CRNR80 101	7-S15810 180	7-S7810 180	900-15 29	A169 90
7-CRNR90 101	7-S15812 180	7-S7812 180	900-16 29	A170 90
7-CVMINITUBE 38	7-S15834 180	7-S7834 180	900-17 29	A171 90
7-ECC12100 121	7-S15838 180	7-S7838 180	900-3 29	A172 90
7-ECC1225 121	7-S20010 180	7-TLC10625 121	900-4 29	A173 90

PART NUMBER INDEX cont'd

A182..... 90	B-124 120	B-932 120	BPN-17 32	BR230..... 105
A200..... 90	B-125 120	B-934 120	BPN-18 32	BR240..... 105
A202..... 90	B-126 120	B-935 120	BPN-19 32	BR250..... 105
A213..... 90	B-127 120	B-998 119	BPN-2 32	BR260..... 105
ACB-30..... 10	B-128 120	BNT-1 159	BPN-20 32	BS-25..... 37
ACB-30-AL 10	B-129 120	BNT-32..... 159	BPN-21 32	BS-32..... 158
ACB-36..... 10	B-12H 140	BPF-01 32	BPN-22 32	C10 118
ACB-36-AL 10	B-131 120	BPF-02 32	BPN-23 32	C101-0050 165
ACB-42..... 10	B-132 120	BPF-03 32	BPN-24 32	C101-0100 165
ACB-42-AL 10	B-16H 140	BPF-04 32	BPN-25 32	C101-0150 165
ACB-48..... 10	B-2..... 119	BPF-05 32	BPN-26 32	C105-0057 165
ACB-48-AL 10	B-20H 140	BPF-06 32	BPN-28 32	C105-0100 165
ACID-ELIM 162	B-24H 140	BPF-07 33	BPN-3 32	C105-0150 165
ACK4..... 128	B-26..... 120	BPF-08 33	BPN-30 32	C105-0215 165
ACP-10..... 42	B-27..... 119	BPF-09 33	BPN-32 32	C1-2-6 118
ACP24242..... 5	B-28H 140	BPF-10 33	BPN-34 32	C154-0100 166
ACP24243..... 5	B-32H 140	BPF-11 33	BPN-35 32	C165-0001 166
ACP30302..... 5	B-36H 140	BPF-12 33	BPN-37 32	C165-0002 166
ACP30303..... 5	B-4..... 119	BPF-13 33	BPN-38 32	C165-0007 166
ACP32322..... 5	B-48H 140	BPF-14 33	BPN-39 32	C165-0025 166
ACP32323..... 5	B-4H 140	BPF-16 33	BPN-4 32	C165-0032 166
ACP36362..... 5	B-501 119	BPF-17 33	BPN-40 32	C165-0050 166
ACP36363..... 5	B-502 119	BPF-18 33	BPN-41 32	C165-0058 166
ACP36483..... 5	B-503 119	BPF-20 33	BPN-43 32	C165-0090 166
ACP38422..... 5	B-504 119	BPF-21 33	BPN-44 32	C165-0093 166
ACT-6 124	B-505 119	BPF-22 33	BPN-45 32	C165-0094 166
ADB-1 103	B6-12-4 91	BPF-23 33	BPN-47 32	C165-0100 166
ADB-2 103	B6-12-4NM 91	BPF-25 33	BPN-5 32	C165-0107 166
ADM-1..... 103	B6-12-6 91	BPF-26 33	BPN-51 32	C165-0149 166
ADM-2..... 103	B6-12-6NM 91	BPF-27 33	BPN-52 32	C165-0150 166
AER-8..... 8	B6-34-4NM 91	BPF-28 33	BPN-53 32	C165-0159 166
AER-8BL 8	B6-34-6 91	BPF-29 33	BPN-54 32	C165-0215 166
AEROSOL-STARTER- KIT 155	B6-34-6NM 91	BPF-31 33	BPN-6 32	C165-0222 166
AG-25 52	B-6H 140	BPF-32 33	BPN-7 32	C165-0223 166
AP-DD 37	B-72H 140	BPF-33 33	BPN-8 32	C165-0295 166
AP-DK..... 37	B-8H 140	BPF-34 33	BPN-9 32	C165-0304 166
AT-1700 109	B-924 120	BPN-1 32	BPN-A12 32	C165-0390 166
ATK-1 162	B-925 120	BPN-10 32	BPN-A34 32	C165-1498 166
ATK-1P..... 162	B-926 120	BPN-11 32	BR115..... 105	C170-0003 167
ATK-4 162	B-927 120	BPN-12 32	BR120..... 105	C172-0090 167
B-1..... 119	B-928 120	BPN-13 32	BR130..... 105	C172-0100 167
B-10..... 120	B-929 120	BPN-14 32	BR2100..... 105	C172-0150 167
B-10H 140	B-930 120	BPN-15 32	BR215..... 105	C172-0215 167
	B-931 120	BPN-16 32	BR220..... 105	C20 118

PART NUMBER INDEX cont'd

C222 115	C290-0150 165	CG-U-M 13	CRC-6 47	D40680250B3B6.175
C222C 115	C290-0215 165	CG-U-S 13	CRC-7-140 44	D40680350B3B6.175
C223 115	C295-0002 166	CGB-AER 155	CRC-7PS 44	D40680500B3B6.175
C223C 115	C295-0090 166	CH115 105	CRC-7X 44	D406K0250B3B6.177
C235-0002 165	C295-0100 166	CH120 105	CRC-7Z 44	D406K0350B3B6.177
C235-0025 165	C295-0150 166	CH215 105	CRC-8 46	D406K0500B3B6.177
C235-0050 165	C312 115	CH220 105	CRC-9 46	D406L0250B3B6.177
C235-0090 165	C312L 115	CH230 105	CRC-CF2 47	D406L0350B3B6.177
C235-0100 165	C410-0032 166	CH240 105	CT-475M 118	D406L0500B3B6.177
C235-0150 165	C410-0058 166	CH250 105	CT800 128	D406M0250B3B6.177
C235-0215 165	C410-0093 166	CH260 105	CTC-050 15	D406M0350B3B6.177
C241 115	C410-0107 166	CK-141 37	CTC-065 15	D406M0500B3B6.177
C241L 115	C410-0149 166	CLL-1 162	CTC-080 15	D40820250B3B6.175
C242-0001 166	C410-0159 166	CLL-4 162	CVENT-2 29	D40820350B3B6.175
C242-0002 166	C410-0222 166	CM-1000 31	CVENT-2AB 29	D40820500B3B6.175
C242-0025 166	C460-0002 167	CO-1 47	CVENT-2-EXT 29	D40880250B3B6.175
C242-0050 166	C460-0025 167	COOLWELD-32 ... 155	CVENT-3 29	D40880350B3B6.175
C242-0090 166	C460-0050 167	COV-BRL 44	CVENT-3-EXT 29	D40880500B3B6.175
C242-0100 166	C460-0090 167	COV-BR2XL 44	CVENT-4 29	D408K0250B3B6.177
C242-0150 166	C460-0100 167	COV-BRXL 44	CVENTCAP2 29	D408K0350B3B6.177
C242-0215 166	C460-0150 167	COV-WP2XL 44	CVENTCAP3 29	D408K0500B3B6.177
C242-0295 166	C5 118	COV-WP3XL 44	CVENTCAP4 29	D408L0250B3B6.177
C242-0390 166	C512 115	COV-WPL 44	CV-PTRAP 36	D408L0350B3B6.177
C243 115	C512L 115	COV-WPM 44	CV-RTRAP 36	D408L0500B3B6.177
C243L 115	C533-0050 167	COV-WPXL 44	CVS-2 29	D408M0250B3B6.177
C245 115	C533-0150 167	CP-CV 36	CVS-3 29	D408M0350B3B6.177
C245L 115	C947-0025 167	CPN1 115	CV-TUBE 36	D408M0500B3B6.177
C247 115	C947-0050 167	CPN1C 115	CV-UTRAP 36	D41020250B3B6.175
C2-5 118	C947-0100 167	CPN2 115	CW-15 37	D41020350B3B6.175
C254-0002 165	C947-0150 167	CPN2C 115	CW-30 118	D41020500B3B6.175
C254-0100 165	C947-0215 167	CPN2M 115	D20-3132-18 30	D41080250B3B6.175
C254-0150 165	C947-0295 167	CPN3 115	D20-3132-24 30	D41080350B3B6.175
C272-0002 165	C947-0390 167	CPN3C 115	D20-3132-36 30	D41080500B3B6.175
C272-0025 165	CA-252C 118	CR070 127	D20-3132-48 30	D410K0250B3B6.177
C272-0050 165	CAS-2712 51	CR-1 47	D30-3131-24 30	D410K0350B3B6.177
C272-0090 165	CB-03 37	CRC-1 46	D30-3131-36 30	D410K0500B3B6.177
C272-0100 165	CB-2 37	CRC-13 47	D30-3131-48 30	D410L0250B3B6.177
C272-0150 165	CC33 109	CRC-1KB 46	D30-3132-18 30	D410L0350B3B6.177
C272-0215 165	CC33-18 109	CRC-2 47	D30-3132-24 30	D410L0500B3B6.177
C290-0002 165	CC33-24 109	CRC-3 47	D30-3132-36 30	D410M0250B3B6.177
C290-0025 165	CCP-L 121	CRC-4-140 43	D30-3132-48 30	D410M0350B3B6.177
C290-0050 165	CCP-M 121	CRC-4CF 43	D40620250B3B6.175	D410M0500B3B6.177
C290-0090 165	CG-AER 155	CRC-4NU 44	D40620350B3B6.175	D60A-10 170
C290-0100 165	CG-U-L 13	CRC-5 47	D40620500B3B6.175	D60A-4 170

PART NUMBER INDEX cont'd

D60A-8 170	D61430300 175	D614L0250..... 176	D90-360 100	DDS-30 92
D61020250B3B6. 175	D61430350 175	D614L0300..... 176	D90-370 100	DDS-60 92
D61020350B3B6. 175	D61430400 175	D614L0350..... 176	D90-372 100	DDS-60SW 92
D61020500B3B6. 175	D61430500 175	D614L0400..... 176	D90-380 100	DDS-60U 92
D61080250B3B6. 175	D61480250 175	D614L0500..... 176	D90-382 100	DE1-10D 170
D61080350B3B6. 175	D61480300 175	D614M0250 176	D90-384 100	DE13 74
D61080500B3B6. 175	D61480350 175	D614M0300 176	DAD032 173	DE14 74
D610K0250B3B6. 177	D61480400 175	D614M0350 176	DAD032S 173	DE1-4B 170
D610K0350B3B6. 177	D61480500 175	D614M0400 176	DAD052 173	DE15 74
D610K0500B3B6. 177	D61810250 175	D614M0400 176	DAD052S 173	DE1-6B 170
D610L0250B3B6. 177	D61810400 175	D614M0500 176	DAD053S 173	DE1-6C 170
D610L0350B3B6. 177	D6180500 175	D618K0250 176	DAD082 173	DE1-6D 170
D610L0500B3B6. 177	D61820250 175	D618K0400 176	DAD082S 173	DE1-8D 170
D610M0250B3B6. 177	D61820500 175	D618K0500 176	DAD083S 173	DE1-8E..... 170
D610M0350B3B6. 177	D61830250 175	D618L0250..... 176	DAD084S 173	DE23 74
D610M0500B3B6. 177	D61830300 175	D618L0400..... 176	DAD163 173	DE24 74
D61210250 175	D61830350 175	D618L0500..... 176	DAD163S 173	DE33 74
D61210300 175	D61830400 175	D618M0250 176	DAD164S 173	DEP052 51
D61210350 175	D61880250 175	D618M0300 176	DAD303 173	DEP8001 51
D61210400 175	D61880300 175	D618M0400 176	DAD303S 173	DEP8002 51
D61210500 175	D61880400 175	D618M0500 176	DAD304S 173	DF-75..... 37
D61220250 175	D61880500 175	D62A-1010 170	DAD305 173	DG321NRB..... 93
D61220300 175	D61A-4 170	D62A-44 170	DBF083S..... 174	DG322NRB..... 93
D61220350 175	D61A-8 170	D62A-66 170	DBF084S..... 174	DG322URB..... 93
D61220400 175	D612K0250 176	D62A-88 170	DBF163..... 174	DMB-1 91
D61220500 175	D612K0300 176	D64A-1010 170	DBF163S..... 174	DMB-2..... 91
D61230250 175	D612K0350 176	D64A-44 170	DBF164S..... 174	DMB-3..... 91
D61230400 175	D612K0400 176	D64A-66 170	DBF165S..... 174	DN1-10..... 171
D61230500 175	D612K0500 176	D64A-88 170	DC20-3131-18..... 30	DN1-3..... 171
D61280250 175	D612L0250..... 176	D68A-4B 170	DC20-3131-24..... 30	DN1-4..... 171
D61280300 175	D612L0300..... 176	D68A-6C 170	DC20-3131-36..... 30	DN1-6..... 171
D61280350 175	D612L0350..... 176	D69A-4A 170	DC20-3131-48..... 30	DN5-4..... 171
D61280400 175	D612L0400..... 176	D69A-8D 170	DC20-3132-18..... 30	DN5-6..... 171
D61280500 175	D612L0500..... 176	D-90113 101	DC20-3132-24..... 30	DNS4-10..... 171
D61410250 175	D612M0250 176	D-90118 101	DC20-3132-36..... 30	DNS4-12 171
D61410300 175	D612M0300 176	D90-290Q..... 100	DC20-3132-48..... 30	DNS4-14 171
D61410350 175	D612M0350 176	D90-291Q..... 100	DC30-3131-18..... 30	DNS4-4..... 171
D61410400 175	D612M0400 176	D90-292Q..... 100	DC30-3131-48..... 30	DNS4-6..... 171
D61410500 175	D612M0500 176	D90-293Q..... 100	DC30-3132-18..... 30	DNS4-8..... 171
D61420250 175	D614K0250 176	D90-294Q..... 100	DC30-3132-24..... 30	DP-1 118
D61420300 175	D614K0300 176	D90-295Q..... 100	DC30-3132-36..... 30	DP2-10 171
D61420350 175	D614K0350 176	D-90340 100	DC30-3132-48..... 30	DP2-4 171
D61420400 175	D614K0400 176	D-90341 100	DC-4128 45	DP2-6 171
D61420500 175	D614K0500 176	D-90342 100	DC-9128..... 45	DP2-8 171

PART NUMBER INDEX cont'd

DPB222R 93	DPE75324 99	DU2-8 171	EC903240 98	ED603 83
DPE252120 99	DPE753240 99	DU3-10E 172	EC903277 98	ED610 83
DPE25224 99	DPE903120 99	DU3-6D 172	ECO-COIL 154	ED611 83
DPE252240 99	DPE90324 99	DUCT-FRESH-16 .. 161	ECO-COIL-32 154	ED612 83
DPE253120 99	DPE903240 99	DUCT-FRESH-32 .. 161	ECO-COIL-55 154	ED613 83
DPE25324 99	DPEAUX10 99	DUCT-FRESH-8 161	ECO-COIL-AER 154	ED620 83
DPE253240 99	DPEAUX11 99	DUS4-4 172	ED1232 82	ED621 83
DPE301120 99	DPEAUX11QC 99	DUS4-6 172	ED1238 82	ED710 83
DPE30124 99	DPEAUX22 99	DX-3 173	ED1240-2 82	ED877 81
DPE301240 99	DPR064 100	DX-4 173	ED1262-2 82	ED9726 82
DPE302120 99	DPR066 100	DXA-5 173	ED1262-2I 82	ED-AT3 79
DPE30224 99	DPSG-2S 174	EC-1 22	ED1301 82	ED-AT5 79
DPE302240 99	DPSG-3MF 174	EC252120 98	ED1301-I 82	ED-CR15 79
DPE302277 99	DPSG-3S 174	EC25224 98	ED1709 80	ED-CR20 79
DPE303120 99	D-SCALE 162	EC252240 98	ED1711 80	ED-CR25 79
DPE30324 99	DSL13-5SVHH .. 173	EC252277 98	ED179 80	ED-CR30 79
DPE303240 99	DSL13-6SVHH .. 173	EC302120 98	ED1876 81	ED-CR35 79
DPE303277 99	DSL13-7SVHH .. 173	EC30224 98	ED1876-I 81	ED-CR40 79
DPE303480 99	DSL13-9SVHH .. 173	EC302240 98	ED1877 81	ED-CR45 79
DPE304120 99	DSP-1 103	EC303120 98	ED252 81	ED-CR50 79
DPE30424 99	DST-5 98	EC30324 98	ED270 81	ED-CR60 79
DPE304240 99	DST-6 98	EC303240 98	ED270-I 81	EDS-12-6NM 92
DPE304277 99	DT2-10 171	EC303277 98	ED273 74	EDS-60U 92
DPE401120 99	DT2-4 171	EC402120 98	ED273CX 74	EFHC-0118-3Y0 30
DPE40124 99	DT2-6 171	EC40224 98	ED277 82	EFHC-0124-3Y0 30
DPE402120 99	DT2-8 171	EC402240 98	ED2867 80	EFLF-ISV-HCTP 30
DPE40224 99	DTP-3 103	EC403120 98	ED2887 81	EG 156
DPE402240 99	DTT-10 46	EC40324 98	ED320 83	EG-5 156
DPE402480 99	DTT-24 46	EC403240 98	ED406 73	EG-55 156
DPE403120 99	DU1-10D 171	EC403277 98	ED419 81	EG-CP3W 150
DPE40324 99	DU1-10E 171	EC503120 98	ED4409 81	EG-CP4W 150
DPE403240 99	DU1-12D 171	EC50324 98	ED447 82	EG-D3W 149
DPE403480 99	DU1-4B 171	EC503240 98	ED448B 82	EG-D4W 149
DPE404120 99	DU1-6B 171	EC503277 98	ED4509 81	EG-DE3W 150
DPE404240 99	DU1-6C 171	EC603120 98	ED453 82	EG-DE4W 150
DPE404277 99	DU1-6D 171	EC60324 98	ED454 82	EG-EB3W 150
DPE503120 99	DU1-6E 171	EC603240 98	ED455 82	EG-EB4W 150
DPE50324 99	DU1-8B 171	EC603277 98	ED468 82	EG-EIN3W 150
DPE503240 99	DU1-8D 171	EC753120 98	ED4867 81	EG-EIN4W 150
DPE602120 99	DU1-8E 171	EC75324 98	ED494 82	EG-FB3W 149
DPE603120 99	DU2-10 171	EC753240 98	ED5225 81	EG-FB4W 149
DPE60324 99	DU2-12 171	EC753277 98	ED600 83	EG-FH3W 150
DPE603240 99	DU2-4 171	EC903120 98	ED601 83	EG-FH4W 150
DPE753120 99	DU2-6 171	EC90324 98	ED602 83	EG-SF3W 149

PART NUMBER INDEX cont'd

EG-SF4W..... 149	EP2436-2..... 5	FB-1 8	GV10 110	HDR-221 111
EG-TC34W 150	EP2436-3..... 5	FF-1000-S..... 9	GV12 110	HDR-222 111
EG-TJ3W 150	EP2448-3..... 5	FF-1000-S-KIT..... 9	GV14 110	HEK-500..... 111
EG-TJ4W 150	EP2626-2..... 5	FF-250-S 9	GVA1 110	HFL-4257 111
EG-WC3W 149	EP3030-2..... 5	FF-250-UNI..... 9	GVA2 110	HFL-4300 111
EG-WC4W 149	EP3030-3..... 5	FF-400-S 9	H1840-4 4	HFL-4333 111
EL1838-3 3	EP3036-2..... 5	FF-600-S 9	H2424-4 4	HFL-5257 111
EL2424-2 3	EP3232-2..... 5	FF-600-S-KIT 9	H2436-4 4	HFL-5258 111
EL2424-3 3	EP3232-3..... 5	FH-1 102	H3030-4 4	HFL-5300 111
EL2430-2 3	EP3434-2..... 5	FM0450 24	H3232-4 4	HFL-5301 111
EL2436-2 3	EP3434-3..... 5	FP-36 51	H3636-4 4	HFL-5333 111
EL2436-3 3	EP3636-2..... 5	FRL12-F..... 178	H3642-4 4	HMD1840-4 4
EL2448-3 3	EP3636-3..... 5	FRL14-F..... 178	H3648-4 4	HMD3030-4 4
EL2626-2 3	EP3640-3..... 5	FRL38-F..... 178	H3652-4 4	HMD3636-4 4
EL3030-2 3	EP3648-2..... 5	FRL58-F..... 178	H3654-4 4	HMD3648-4 4
EL3030-3 3	EP3648-3..... 5	FTL3..... 128	H3656-4 4	HMD4040-4 4
EL3036-2 3	EP3842-2..... 5	FTL3D 128	H3672-4 4	HMR-130..... 111
EL3040-2 3	EP3842-3..... 5	FULO425 23	H3852-4 4	HP3232-8 6
EL3232-2 3	EP3870-3..... 5	FULO625 23	H3865-4 4	HP3636-8 6
EL3232-3 3	EP4040-3..... 5	GA-06 118	H3872-4 4	HPR-12 8
EL3244-3 3	EP4558-3..... 5	GA-30 118	H4040-4 4	HPR-3..... 8
EL3434-2 3	EP4848-3..... 5	GB3020 28	H4242-4 4	HPR-3-2P..... 8
EL3636-2 3	EP5042-3..... 5	GC275 109	H4558-4 4	HPR-3-2PG 8
EL3636-3 3	EP5060-3..... 5	GC277 109	H5557-4 4	HPR-3BL 8
EL3640-2 3	EP5070-3..... 5	GDK4080 28	HC5410 77	HPR-6..... 8
EL3640-3 3	EP5252-3..... 5	GG-1 37	HC5410X 77	HPR-6-2P..... 8
EL3648-2 3	EP5658-3..... 5	GG-1A..... 37	HC5416 77	HPR-6-2PG 8
EL3648-3 3	ET130C1 109	GG-1BOR 37	HC5416X 77	HPR-6BL 8
EL3842-2 3	ET22 109	GG-1H..... 37	HC5420 77	HPR-EXT 8
EL3842-3 3	ET33 108	GG-1TF 37	HC5424 77	HS03 110
EL3870-3 3	ET35G..... 108	GGC-12..... 37	HC5436 77	HS04 110
EL4040-3 3	ET35N..... 108	G-LC2XL 50	HC6202 77	HS06 110
EL4558-3 3	ET35R 108	G-LCL..... 50	HC6203 77	HS08 110
EL4848-3 3	ET35W 108	G-LCM..... 50	HCO-128..... 45	HS-144 127
EL5042-3 3	ET44 108	G-LCXL..... 50	HCO-15..... 45	HS-192 128
EL5060-3 3	ET75 37	GN-23H..... 52	HCO-7 45	HS-30 128
EL5070-3 3	ET75-KIT..... 37	G-NC2XL 50	HCP-15 45	HS-30-2 128
EL5252-3 3	F-HF-320 16	G-NCM 50	HCP-7 45	HS-60 128
EL5658-3 3	F-HF-500 16	G-NCL 50	HDR-101 111	HS-60-2 128
EM480 82	FA-01 37	G-NCXL 50	HDR-102 111	HSA1 110
EM484 82	FA-02 37	GP1-40BL..... 52	HDR-201 111	HSA2..... 110
EP1838-3..... 5	FA-03 37	GV06 110	HDR-202 111	HSK1 98
EP2424-2..... 5	FAK-10 50	GV07 110	HDR-211 111	HSK5..... 98
EP2424-3..... 5	FAK-25 50	GV08 110	HDR-212 111	HT1840-4..... 4

PART NUMBER INDEX cont'd

HT2436-4.....4	ISO-186	LIT-FLY-SPRAYER..182	MKT-POP-CLRSTAND	MP-18C.....6
HT3030-4.....4	ISO-26	LIT-FLY-SPRAYER-S182183	MP-18E.....6
HT3232-4.....4	ISO-46	LIT-FLY-SPTEAROFF	MKT-POP-CVTUBE.183	MP-2.....6
HT3636-4.....4	JB8265.....51182	MKT-POP-DEVBACKS	MP-2C.....6
HT3648-4.....4	LIT-CAT-HVAC.....182	LIT-FLY-SWITCH....182183	MP-2E.....6
HT3842-4.....4	LIT-FLY-3D.....182	LIT-FLY-TRIPBOOST	MKT-POP-DEVBACKSSLAT	MP-3.....6
HT4040-4.....4	LIT-FLY-3D-S.....182182183	MP-3C.....6
HT4242-4.....4	LIT-FLY-BPPPOOL...182	LIT-FLY-UC.....182	MKT-POP-DEVCOMBO	MP-3E.....6
HT4558-4.....4	LIT-FLY-CDLC.....182	LIT-FLY-UCSTRAP..182183	MP-4.....6
HVENT-2.....29	LIT-FLY-CLAD.....182	LIT-FLY-UV.....182	MKT-POP-DEVELEC	MP-4C.....6
HVENT-2CA.....29	LIT-FLY-CLRVUE....182	LIT-FLY-VENTS.....182183	MP-4E.....6
HVENT-3.....29	LIT-FLY-COIL.....182	LIT-FLY-WS.....182	MKT-POP-DEVEZC.183	MP-6.....6
HVENT-3CA.....29	LIT-FLY-COIL-S.....182	LSB10-BL.....175	MKT-POP-DTBACKS	MP-6C.....6
HW-10P.....50	LIT-FLY-CS1200...182	LSB10-W.....175183	MP-6E.....6
IC00-15.....15	LIT-FLY-CVMINI...182	MAG-1.....128	MKT-POP-DTBACKSSLAT	MP-8.....6
IC00-20.....15	LIT-FLY-CVMINI-S..182	MB21.....109183	MSA-45.....168
IC00-22.....15	LIT-FLY-DISC.....182	MB22.....109	MKT-POP-DUCT...183	N20-SD.....118
IC00-25.....15	LIT-FLY-DST10.....182	MBK-6.....37	MKT-POP-DUCTSPIN	PA10.....109
IC00-28.....15	LIT-FLY-DTP3.....182	MDSCN111.....31183	PA18.....109
IC00-32.....15	LIT-FLY-DTP3ES....182	MG-1.....123	MKT-POP-EASEL..182	PA25.....109
IC00-35.....15	LIT-FLY-ELITE.....182	MG-RGB.....123	MKT-POP-ET.....183	PA25AP.....109
IC00-40.....15	LIT-FLY-ET.....182	MG-RGR.....123	MKT-POP-HSI.....183	PANPATCH.....156
IC00-42.....15	LIT-FLY-FLEX.....182	MHP-4.....124	MKT-POP-PF.....183	PANPATCH-BAG...156
IC00-50.....15	LIT-FLY-FLOW.....182	MKT-BANNER.....182	MKT-POP-QSBACK.183	PC-600-B.....26
IC00-54.....15	LIT-FLY-FLXHOSEKIT	MKT-MERCH-CHEM	MKT-POP-QSMSBOX	PC-600-S.....26
IGN-001.....28182183183	PC-609-B.....26
IGN-110-101.....28	LIT-FLY-FOOT.....182	MKT-MERCH-DPWIRE	MKT-POP-QSWIBOX	PC-609-S.....26
IGN-110-102.....28	LIT-FLY-GG.....182183183	PC-622-B.....26
IGN-110-103.....28	LIT-FLY-HEAT.....182	MKT-MERCH-FLEX183	MKT-POP-SWITCHBACK	PC-622-S.....26
IGN-106.....28	LIT-FLY-HPAD.....182	MKT-MERCH-RSC.183183	PC-857.....26
IGN-108-101.....28	LIT-FLY-HRP.....182	MKT-MERCH-SENTRY	MKT-POSTER-CHT24E	PE-012.....140
IGN-11R.....28	LIT-FLY-HSI.....182183183	PE-014.....140
IGN-2.....28	LIT-FLY-MDP.....182	M K T - M E R C H -	MKT-POSTER-CHT24S	PE-038.....140
IGN-2-6P.....28	LIT-FLY-MOTORS...182	SWITCHWIRE.....183183	PE-058.....140
IGN-401.....28	LIT-FLY-PADS.....182	M K T - M E R C H -	MKT-POSTER-CHT36E	PE-104.....140
IGN-402.....28	LIT-FLY-PF.....182	USACAPS.....183183	PF-08.....157
IGN-403.....28	LIT-FLY-PF-S.....182	MKT-POP-BROCH.182	MKT-POSTER-CLRVUE	PF-16.....157
IGN-405.....28	LIT-FLY-PUMP.....182	MKT-POP-BROCH4183	PF-ADAPTER.....157
IGN-406.....28	LIT-FLY-QS.....182182	MKT-POSTER-HPAD	PF-IGUN.....157
IGN-407.....28	LIT-FLY-RPC.....182	MKT-POP-CDLC...183183	PF-IHOSE.....157
IGN-408.....28	LIT-FLY-RPC-S.....182	MKT-POP-CHEM...183	MP-12.....6	PF-KIT.....157
IGN-409.....28	LIT-FLY-RSC.....182	MKT-POP-CLRGOND	MP-12C.....6	PG-100.....157
IGN-410.....28	LIT-FLY-SEAL.....182183	MP-12E.....6	PG-100-5.....157
IGN-412.....28	LIT-FLY-SPCH18...182		MP-18.....6	PG-100-55.....157

PART NUMBER INDEX cont'd

PG-50.....157	PI332.....74	PI459.....71	PRO-YELLOW-32 .155	QSMS1201SS.....10
PG-50-5.....157	PI335.....77	PI908.....73	PRO-YELLOW-55 .155	QSMS120211
PG-50-55.....157	PI337-3.....84	PI908CX.....73	PRO-YELLOW-AER.155	QSMS120311
PG-BG.....157	PI340.....72	PI909LX73	PS-1.....158	QSMS120411
PG-BG-5.....157	PI341.....72	PI912.....73	PW-16.....135	QSMS120511
PG-BG-55.....157	PI350.....72	PI912LX73	PW-32.....135	QSMS180010
PG-PLUS.....157	PI351.....72	PI913.....73	PW-4.....135	QSMS180110
PG-PLUS-5.....157	PI352.....72	PI914.....73	PW-8.....135	QSMS1801SS.....10
PG-PLUS-55.....157	PI353.....72	PI929.....84	PWB-16.....135	QSMS180211
PI203.....73	PI360.....70	PK-2.....130	PWB-4.....135	QSMS180411
PI206.....73	PI361.....70	POE100-01161	PWB-8.....135	QSMS180511
PI221.....84	PI362.....70	POE100-32161	PWH-16135	QSMS240010
PI222.....84	PI363.....70	POE32-01161	PWH-4135	QSMS240110
PI227.....84	PI365.....70	POE32-32161	PWH-8135	QSMS2401SS.....10
PI228.....84	PI366.....70	POE68-01161	PWU-16135	QSMS240211
PI232CX.....71	PI367.....70	POE68-32161	PWU-4135	QSMS240411
PI237.....84	PI368.....71	PP-16.....135	PWU-8135	QSMS240511
PI301.....74	PI370.....71	PP-32.....135	PWW-16.....135	QSMS3001-1211
PI303.....74	PI371.....71	PP-4.....135	PWW-4.....135	QSMS3001-12EXT.11
PI304.....73	PI374.....70	PP-8.....135	PWW-8.....135	QSMS3001-1811
PI305.....73	PI375.....70	PPC-16.....135	QAV-2140	QSMS3001-18EXT.11
PI306.....73	PI377.....71	PPC-4.....135	QN-S3.....37	QSMS3001-2411
PI306CX.....73	PI378.....71	PPC-8.....135	QSAC100014	QSMS3001-24EXT.11
PI307.....73	PI379.....71	PRO-BLUE.....154	QSAC110014	QSPR100010
PI307CX.....73	PI381.....82	PRO-BLUE-32.....154	QSAC200014	QSRB100013
PI309.....74	PI382.....71	PRO-BLUE-5.....154	QSAC210014	QSSB48-1212
PI310.....73	PI383.....70	PRO-BLUE-55.....154	QSAC510012	QSSB48-1812
PI310LX73	PI384.....71	PRO-BLUE-AER154	QSAC510112	QSSB48-2412
PI311.....72	PI385.....71	PRO-BROWN.....154	QSAC510212	QSSB62-1212
PI312.....72	PI385-34.....71	PRO-BROWN-5....154	QSAC510412	QSSB62-1812
PI315.....72	PI386.....71	PRO-BROWN-AER.154	QSAC510512	QSSB62-2412
PI316.....73	PI387.....70	PRO-BUBBLE-32..159	QSAC520012	QSSB74-1212
PI317.....73	PI389.....71	PRO-GREEN.....154	QSAC520112	QSSB74-1812
PI318.....72	PI389-GFI.....71	PRO-GREEN-32...154	QSAC520212	QSSB74-2412
PI319.....71	PI390.....70	PRO-GREEN-5.....154	QSBB30009	QSSX48-1212
PI319CX.....71	PI391.....70	PRO-GREEN-AER .154	QSBB40009	QSSX48-1812
PI320.....71	PI393.....70	PRO-KLEEN.....155	QSBF-PA03.....13	QSSX48-2412
PI321.....71	PI394.....70	PRO-RED+155	QSBF-PA04.....13	QSSX62-1212
PI322.....72	PI411.....72	PRO-RED+32155	QSBF-PA05.....13	QSSX62-1812
PI326.....84	PI412.....72	PRO-RED+5.....155	QSCH1000.....10	QSSX62-2412
PI327.....84	PI416.....72	PRO-RED+AER155	QSCH2000.....10	QSSX74-1212
PI328.....84	PI419.....72	PRO-THAW.....162	QSLG200013	QSSX74-1812
PI330.....74	PI426.....72	PRO-THAW-1162	QSMS120010	QSSX74-2412
PI331.....74	PI458.....71	PRO-YELLOW155	QSMS120110	QSTD100012

PART NUMBER INDEX cont'd

QSTD2000 12	RM-10..... 52	SC08-25 14	STXR480D05..... 104	TRIPLE-D-5..... 154
QSTD3000 11	RM-1G 52	SC08-28 14	STXR480Y05N ... 104	TRIPLE-D-55..... 154
QSTD3000-12 11	RPC-0012 14	SC08-32 14	STXRMBK..... 104	TRIPLE-D-AER..... 154
QSTD4000 12	RPC-0014 14	SC08-35 14	SUPER-KOOL..... 159	TRIPLE-D-AER-6... 154
QSTD4001 12	RPC-0034 14	SC08-40 14	SUPER-KOOL-16.. 159	TRIPLE-D-GRAN... 154
QSTD4002 12	RPC-0038 14	SC08-42 14	T-10 121	TRIPLE-D-RTU..... 154
QSTD5000 12	RPC-0058 14	SC08-50 14	T-11 121	TS-1 106
QSTD5001 12	RPC-0078 14	SC08-54 14	T-12 121	TS-3 106
QSTD5002 12	RPC-0118 14	SC-1 49	T-13 121	TS-4 106
QSTD6000 12	RPC-0138 14	SC-10 42	T-14 121	TT-120 125
QSTD6001 12	RPC-0158 14	SC10-15 14	T-1401 100	TT-24..... 125
QSTD6002 12	RPC-FB 15	SC10-20 14	T1404..... 100	TT-240 125
QSWB1000 9	RPC-FB-100..... 15	SC10-22 14	T-20 121	U3353-3 2
QSWB1100 9	RS-15..... 128	SC10-25 14	T-21 121	U3650-3 2
QSWB2000 10	RS-20..... 128	SC10-28 14	T2401 100	U3654-3 2
QSWB2000SS 10	RS-31..... 128	SC10-32 14	T2403..... 100	U3660-3 2
QSWB2004 10	RS-41..... 128	SC10-35 14	T2404..... 100	U3865-3 2
QSWB2005 10	RS-9..... 128	SC10-40 14	T3401 100	U3870-3 2
QSWB3000 9	RSC-GRN-02..... 164	SC10-42 14	T3403..... 100	U4054-3 2
QSWB4000 10	RSC-GRN-04K..... 164	SC10-50 14	T3501 100	U4550-3 2
QSWB4000SS 10	RSC-GRN-10..... 164	SC10-54 14	T-400 122	U4558-3 2
QSWI1000 13	RSC-GRN-50K..... 164	SC-1SHU 49	T5401 100	U4848-3 2
QSWI2000 13	RSC-RED-02 164	SC-1WP 49	T6752 100	U4854-3 2
QSWI3000 13	RSC-RED-02-E 164	SC-25 42	T6753 100	U4866-3 2
QSWI3001 13	RSC-RED-04K..... 164	SC-BRSHU 49	T7752..... 100	U5053-3 2
QSWI3002 13	RSC-RED-04K-E... 164	SCM-10..... 42	T-100 121	U5056-3 2
QSWI4000 13	RSC-RED-10 164	SCM-25..... 42	TC-007..... 125	U5252-3 2
QSWI5000 13	RSC-RED-10-E 164	SCM-5..... 42	TC-25..... 37	U5557-3 2
QSWI5001 13	RSC-RED-500 164	SC-WPSHU 50	TDC-4 5	UA-1 36
QSWI5002 13	RSC-RED-50K..... 164	SG-1 37	TDC-6 5	UC1636-3 2
QSWI5003 13	RSC-RED-50K-E... 164	SGC-12 37	TDC-8 5	UC1838-3 2
QSWI6000 13	RSC-SLV-02 164	SG-NV30B..... 50	TDC-10 5	UC1838-3CA 2
QSWI6000 13	RSC-SLV-04K..... 164	SG-NV30BC..... 50	TDC-12 5	UC2424-3 2
QT-1 169	RSC-SLV-10 164	SG-NV30CB..... 50	TG-05 129	UC2424-3CA 2
QT-100..... 169	RSC-SLV-500 164	SG-NV30CC..... 50	TG-10 37	UC2436-3 2
QT-100G 169	RSC-SLV-50K..... 164	SPT-W 54	TG-30 129	UC2436-3CA 2
QT-100N 169	RSC-TOOL..... 164	ST-10 46	TG-30-1 129	UC2442-3 2
QT-2..... 169	SANI-CND..... 156	ST-24 46	TG-30-12 129	UC2448-3 2
QTH-1 169	SANI-CND-32..... 156	ST-4 46	TG-87A..... 37	UC2448-3CA 2
QTH-2 169	SANI-CND-5..... 156	ST75..... 37	TLC-3-10 109	UC2626-3 2
QTM-1 169	SANI-CND-55..... 156	STXH120P05 104	TLC-3-12 109	UC2636-3CA 2
QTM-2..... 169	SC08-15 14	STXH240S05 104	TLC-3-8 109	UC3030-3 2
RC-1 174	SC08-20 14	STXR208Y05N ... 104	TRIPLE-D..... 154	UC3030-3CA 2
RLF-8 159	SC08-22 14	STXR240D05..... 104	TRIPLE-D-32..... 154	UC3036-3CA 2

PART NUMBER INDEX cont'd

UC3040-32	VLC-4169	W124-100113	WG84020386	WG84074686
UC3132-3L2	VLC-5169	W124-50114	WG840203HT86	WG840746HT86
UC3232-32	VLC-6169	W125113	WG84020486	WG840884HT87
UC3232-3CA2	VLC-8169	W125-100113	WG840204HT86	WHT20114
UC3237-32	VP68-01162	W125-50114	WG84020586	WHTB10-50114
UC3434-32	VP68-05162	W141113	WG840205HT86	WHTB12-50114
UC3445-32	VP68-32162	W141-100113	WG84045886	WHTB14-50114
UC3539-3L2	VS-4168	W141-50114	WG840458HT87	WHTR14-50114
UC3636-32	VST-4168	W142113	WG84045986	WHTW14-50114
UC3636-3CA2	VST-44168	W142-100113	WG840459HT87	WM100284
UC3642-32	VTR-24168	W142-50114	WG84046387	WM100384
UC3642-3CA2	VTS-10168	W143113	WG84046487	WM100984
UC3648-32	VTS-12168	W143-100113	WG84046586	WM101484
UC3648-3CA2	VTS-14168	W143-50114	WG840465HT87	WP1212-164178
UC3842-32	VTS-46168	W144113	WG84046687	WP1212-50178
UC4040-32	VTS-56168	W144-100113	WG84046787	WP1214-164178
UC4040-3CA2	VTS-68168	W144-50114	WG84046886	WP1214-50178
UC4042-32	VTS-810168	W145113	WG840468HT87	WP1234-50178
UC4044-3L2	VVC-1168	W145-100113	WG84046986	WP1234-82178
UV-123	W101113	W145-50114	WG840469HT87	WP1238-164178
UV-BULB23	W101-100113	W801113	WG84058387	WP1238-50178
UVEC-07G161	W101-50114	W801-100113	WG84058487	WP1258-164178
VA-3-346168	W102113	W801-50114	WG84058587	WP1258-50178
VA-34168	W102-100113	W802113	WG84058687	WP1278-50178
VA-46168	W102-50114	W802-100113	WG84058787	WP1278-82178
VA-68168	W103113	W802-50114	WG84058887	WT04116
VAU-24168	W103-100113	W803113	WG84058987	WT04C116
VAU-45168	W103-50114	W803-100113	WG84059087	WT05116
VAX-2168	W104113	W804-100113	WG84059587	WT05C116
VAX-3168	W104-100113	W804-50114	WG84059687	WT07116
VAX-4168	W104-50114	W805113	WG84072786	WT07C116
VAX-5168	W105113	W805-100113	WG840727HT86	WT11116
VAX-6168	W105-100113	WC02116	WG84072886	WT11C116
VAX-8168	W105-50114	WC03116	WG840728HT86	WT11L116
VC-4168	W121113	WC04116	WG84072986	WT15116
VC-4R168	W121-100113	WC05116	WG840729HT86	WT15C116
VCC-4168	W121-50114	WC06116	WG84073086	WTA1116
VCC-4B168	W122113	WC08116	WG840730HT86	WTB05116
VCR-1169	W122-100113	WC09116	WG84073186	WTB05C116
VCRT-1169	W122-50114	WC10116	WG840731HT86	WTB07116
VLC-10169	W123113	WC12116	WG840736HT86	WTB07C116
VLC-12169	W123-100113	WC14116	WG840737HT86	WTB07M116
VLC-18169	W123-50114	WC16116	WG840738HT86	WTB11116
VLC-25169	W124113	WCA1116	WG840739HT86	WTB11C116

PART NUMBER INDEX cont'd

WTB11C.....	148
WTB11CR.....	116
WTB11D.....	116
WTB11M.....	116
WTB15.....	116
WTB15C.....	116
WTBA1.....	116
WTM05.....	116
WTM05C.....	116
WTM07.....	116
WTM07C.....	116
WTM1.....	116
WTM11.....	116
WTM11C.....	116
WTM14C.....	116
WTM1C.....	116
WTM2.....	116
WTM2C.....	116
WTMB05C.....	116
WTMB07.....	116
WTMB07C.....	116
WTMB11.....	116
WTMB11C.....	116
WTMB14C.....	116

ABOUT DIVERSITECH

Founded in 1971, DiversiTech® Corporation is North America's largest manufacturer of equipment pads and a leading manufacturer and supplier of components and related products for the heating, ventilating, air conditioning, and refrigeration (HVAC/R) industry. Headquartered in the Atlanta, Ga., metropolitan area, DiversiTech's mission for its wholesaler partners is to simplify their work. The Company is focused on growth through internal product development, external partnerships and acquisition. Manufacturing a suite of products, which includes a wide range of mechanical, electrical, chemical and structural parts for HVACR systems, DiversiTech brings unparalleled scaling capabilities and supplier expertise. The Company holds numerous patents and operates an advanced R&D materials division dedicated to bringing more value to its customers. The Company maintains over 1 million square feet of manufacturing and distribution space in key U.S., Canadian and European locations. DiversiTech has enjoyed a continued history of successful growth and has acquired industry recognized brand names including hilmor®, Imperial®, Quick-Sling®, UltraLite®, Spin® Tools, and SpeedClean®. More information is available at www.diversitech.com.

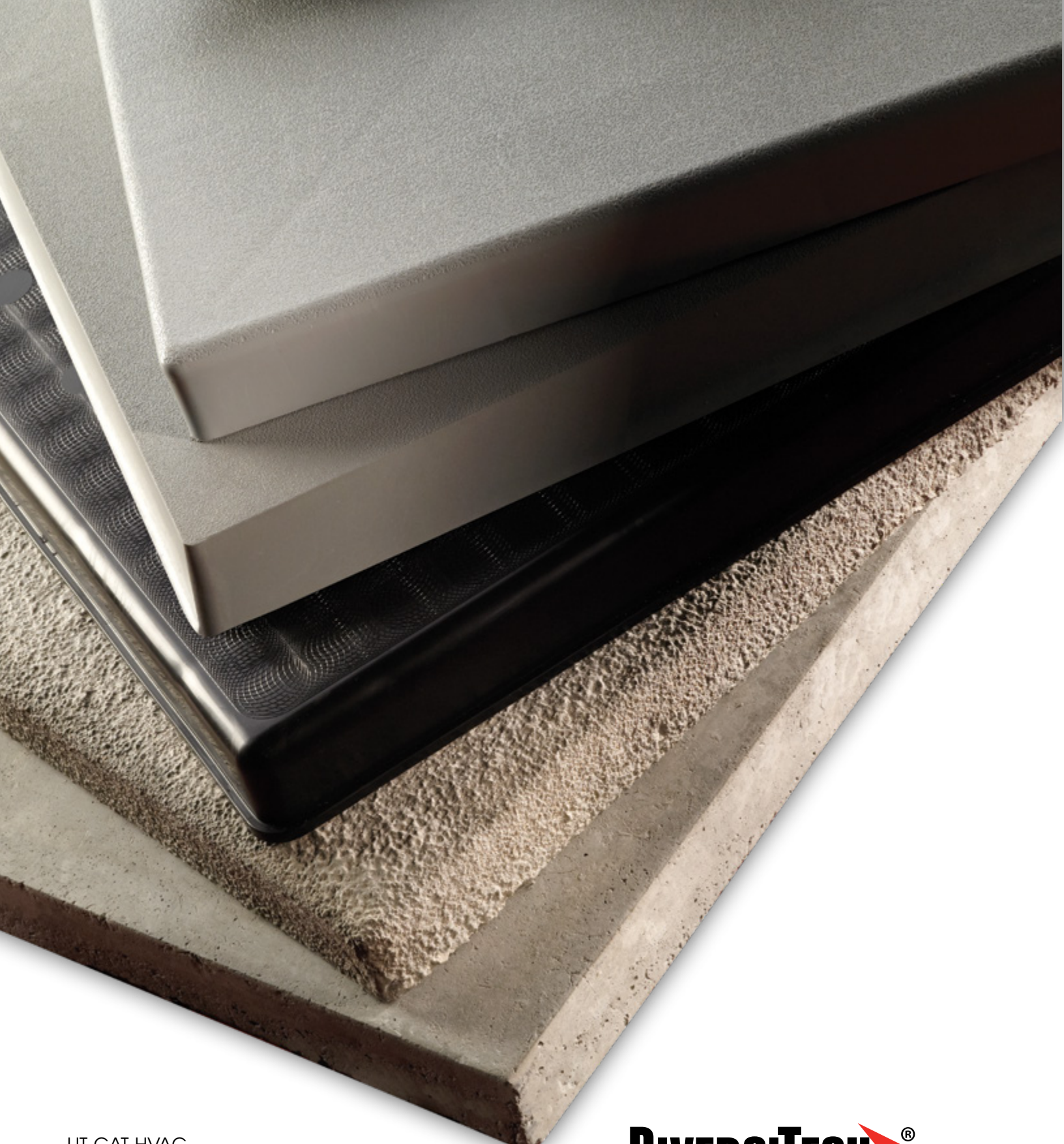

LIT-CAT-HVAC
3039 Premiere Parkway
Suite 600
Duluth, GA 30097
678.542.3600
800.995.2222
www.diversitech.com
©2021 DiversiTech Corporation

