

Free-Standing Gas Range

Installation manual

NX58*565*** / NX58*560***



SAMSUNG

Before you begin

ABOUT THIS MANUAL

Read these instructions completely and carefully.

Important note to the installer

- Read all instructions contained in these installation instructions before installing the range.
- Remove all packing materials from the oven compartments before connecting the electric and gas supply to the range.
- Observe all governing codes and ordinances.
- Be sure to leave these instructions with the consumer.
- Installation of this appliance requires basic mechanical skills.
- Proper installation is the responsibility of the installer.
- Product failure due to improper installation is not covered under the Warranty.

Important note to the consumer

Keep these instructions with your user manual for future reference.

- As when using any appliance generating heat, there are certain safety precautions you should follow.
- Be sure your range is installed and grounded properly by a qualified installer or service technician.
- Make sure the wall coverings around the range can withstand the heat generated by the range.
- Cabinet storage space above the surface burners should be a minimum of 30" (76.2 cm).

Important note to the servicer

The electrical diagram is in an envelope attached to the back of the range.

Safety instructions

SAFETY SYMBOLS

What the icons and signs in this user manual mean:

WARNING

You can be killed or seriously injured if you don't follow instructions.

CAUTION

Minor injury or property damage can result if you don't follow instructions.



Do NOT attempt.



Do NOT disassemble.



Do NOT touch.



Follow directions explicitly.



Unplug the power cord from the electrical outlet.



Make sure the range is plugged into an earth grounded electrical outlet to prevent electric shock. An outlet equipped with a Ground Fault Interrupter (GFI) is highly recommended.



Call the service center for help. See page 32



Note

These warning signs are here to prevent injury to you and others.

Please follow them explicitly.

Do not discard this manual. Please keep it in a safe place for future reference.

Safety instructions

IMPORTANT SAFETY INSTRUCTIONS

⚠ WARNING

If the information in this manual is not followed exactly, a fire or explosion may result causing property damage, personal injury or death.

- **DO NOT** store or use gasoline or other flammable vapors and liquids in the vicinity of this or any other appliance.
- **WHAT TO DO IF YOU SMELL GAS:**
 - **DO NOT** try to light any appliance.
 - **DO NOT** touch any electrical switch.
 - **DO NOT** use any phone in your building.
 - Immediately call your gas supplier from a neighbor's phone. Follow the gas supplier's instructions.
 - If you cannot reach your gas supplier, call the fire department.
- Installation and service must be performed by a qualified installer, service agency, or the gas supplier.

ANTI-TIP DEVICE

⚠ WARNING



Tip-Over Hazard

- A child or adult can tip the range and be killed.
- Install anti-tip device to range and/or structure per installation instructions.
- Engage the range to the anti-tip device installed to the structure.
- Re-engage anti-tip device if range is moved.
- Failure to follow these instructions can result in death or serious burns to children or adults.

- ★ To prevent accidental tipping of the range, attach an approved and packed anti-tip device to the floor. (See Install the Anti-Tip Device on page 24 in this manual.) Check for proper installation by carefully tipping the range forward. The anti-tip device should engage and prevent the range from tipping over.

If the range is pulled out away from the wall for any reason, make sure the anti-tip device is reengaged after the range has been pushed back into place.

Never completely get rid of the leveling legs or the range will not be secured to the anti-tip device properly.

Follow the installation instructions found on page 22 of this manual. Failure to follow these instructions can result in death, serious personal injury, and / or property damage.

DO NOT step / sit / lean on the door or drawer to prevent accidental tipping of the range.

Safety instructions

IMPORTANT SAFETY PRECAUTIONS

WARNING

Follow basic precautions when installing and using this range to reduce the risk of fire, electrical shock, injury, or death to persons, including:

Installation and Service

-  This range must be properly installed and located in accordance with the installation instructions before it is used.

Professional installation is strongly recommended.

Due to the size and weight of the range, it is highly recommended that two or more people move or install this appliance.



All ranges can tip over and cause severe injuries. Install the anti-tip device packed with this range following the instructions found on page 24 in this manual.

Never try to repair or replace this appliance on your own unless it is specifically recommended in this manual. This appliance should be serviced only by a qualified service technician.

Know the location of the gas shut-off valve and how to shut it off if necessary.

Properly remove or destroy the packaging materials after the appliance is unpacked.

Electrical/Mechanical

-  Unplug or disconnect power before servicing.
-  Do not tamper with the controls.

Danger to Children

-  Do not store any object of interest to children on the cooktop or backguard of the range. Children climbing on the range to reach items could be killed or seriously injured.

Keep children away from the door when opening or closing it as they may bump themselves on the door or catch their fingers in the door.

Keep all packaging materials out of reach of children. Failure to dispose of plastic bags could result in suffocation.

Do not leave children alone or unattended in an area where a range is in use. They should never be allowed to sit or stand on any part of a range.

-  Teach children not to touch or play with the controls or any part of the range.

Do not leave the oven door open. An opened door could entice children to hang on the door or crawl inside the oven. It is recommended to utilize the control / door lockout feature to reduce the risk of mis-use from children.





-  Before disposing of the range, cut off the power cord to prevent it being connected to a power source. Remove the door to prevent children and animals from getting trapped.

Fire

-  Do not touch oven burners, drawer burners, or interior surfaces of the oven. Cooking surfaces, grates, cooktop burners and caps, as well as oven walls may be hot even though they are dark in color. Interior oven surfaces can become hot enough to cause burns. During and after use, do not touch or let clothing or other flammable materials contact oven burners, drawer burners, or interior surfaces of the oven until they have had sufficient time to cool.

Keep oven vent ducts unobstructed. Clean vents frequently to avoid grease buildup.

Safety instructions

-  Do not let a pot holder touch a hot heating element. Do not use a towel or other bulky cloth as a pot holder.
Do not use your range to heat unopened food containers or to dry newspapers.
-  Keep oven vent ducts unobstructed. Clean vents frequently to avoid grease buildup.
-  Never use your range for warming or heating a room. Doing so could result in carbon monoxide poisoning and/or overheating of the oven.
Loose-fitting or hanging garments should not be worn while using this appliance.
DO NOT STORE OR USE combustible materials, gasoline, or other flammable vapors or liquids in the vicinity of this appliance. See "WHAT TO DO IF YOU SMELL GAS" under the Gas Warnings.
Do not use water on a grease fire. Water might cause a grease fire to explode, spreading the fire and creating a larger fire and health hazard. Turn off heat source and smother with tight-fitting lid or use a multipurpose dry chemical or foam-type fire extinguisher.
Never leave surface units unattended at high heat settings. Boilovers cause smoking, and greasy spillovers could ignite.
Do not use a flame to check for gas leaks. Use a soapy water mixture around the area you are checking instead.
Do not place portable appliances, or any other object other than cookware on the cooktop. Damage or fire could occur if cooktop is hot.
Do not attempt to operate this appliance if it is damaged, malfunctioning, or has missing or broken parts.
Never place plastic, paper, or other items that could melt or burn near the oven vents or any of the surface burners.
-  If the self-clean mode malfunctions, turn the oven off and disconnect the power supply. Refer to page 79 and 80 in the User Manual to contact a qualified service technician.

Steam and Vapors

-  Use care when opening the oven door. Let hot air or steam escape before removing or placing food in a hot oven.
Use only dry pot holders. Moist or damp pot holders on hot surfaces may result in burns from steam.

GAS WARNINGS

WARNING

If the information in this manual is not followed exactly, a fire or explosion may result, causing death, personal injury, or property damage.

1. DO NOT light a match, candle, or cigarette.
2. DO NOT turn on any gas or electric appliances.
3. DO NOT touch any electrical switches.
4. DO NOT use any phone in your building.
5. Clear the room, building, or area of all occupants.
6. Immediately call your gas supplier from a neighbor's phone. Follow the gas supplier's instructions.
7. If you cannot reach your gas supplier, call the fire department.

Safety instructions

Read instructions completely and carefully.

- ★ Installation of this range must conform with local codes or, in the absence of local codes, with the National Fuel Gas Code, ANSI Z223.1/NFPA.54, latest edition. In Canada, installation must conform with the current Natural Gas Installation Code, CAN/CGA-B149.1, or the current Propane Installation Code, CAN/CGA-B149.2, and with local codes where applicable. This range has been design-certified by ETL according to ANSI Z21.1, latest edition, and Canadian Gas Association according to CAN/CGA-1.1, latest edition.

Installation and service must be performed by a qualified installer, service agency, or gas supplier.

Have the installer show you the location of the gas shut-off valve and how to shut it off.

Always use NEW flexible connectors when installing a gas appliance. Never reuse old flexible connectors. The use of old flexible connectors can cause gas leaks and personal injury.

- ⊠ Never use this appliance as a space heater to heat or warm the room. Doing so may result in carbon monoxide poisoning and overheating of the oven. Never block the oven vents (air openings). They provide the air inlet and exhaust that are necessary for the oven to operate properly with correct combustion.

⚠ WARNING

Gas appliances can cause minor exposure to four of these substances, namely, carbon monoxide, formaldehyde, and soot, caused primarily by the incomplete combustion of natural gas or LP fuels. Properly adjusted burners, indicated by a bluish rather than yellow flame, will minimize incomplete combustion. Exposure to these substances can be minimized by venting with an open window or by using a ventilation fan or hood.

IN THE COMMONWEALTH OF MASSACHUSETTS

- ★ This product must be installed by a qualified plumber or gas fitter by the State of Massachusetts.
When using ball-type gas shut-off valves, they shall be the T-handle type.
Multiple flexible gas lines must not be connected in series.

Safety instructions

ELECTRICAL WARNINGS

Comply with the following electrical instructions and requirements to avoid death, personal injury from electric shock, and/or property damage from fire:



1. Plug into a grounded 3-prong outlet.
2. DO NOT remove ground prong.
3. DO NOT use an adapter.
4. NEVER use an extension cord.

- ★ Use a dedicated 120-volt, 60-Hz, 20-amp, AC, fused electrical circuit for this appliance. A time-delay fuse or circuit breaker is recommended. DO NOT plug more than one appliance in this circuit.

The range is supplied with a 3-prong grounded plug. This cord **MUST** be plugged into a mating, grounded 3-prong outlet that meets all local codes and ordinances. If you are unsure your electrical outlet is properly grounded, have it checked by a licensed electrician.

If codes permit the use of a separate ground wire, it is recommended that a qualified electrician determine the proper path for this ground wire.

Electrical service to the range must conform to local codes. Barring local codes, it should meet the latest ANSI/NFPA No. 70 – Latest Revision (for the U.S.) or the Canadian Electrical Code CSA C22.1 – Latest Revisions.

It is the personal responsibility of the appliance owner to provide the correct electrical service for this appliance.

- ☐ NEVER connect ground wire to plastic plumbing lines, gas lines, or hot water pipes.

DO NOT modify the plug provided with the appliance.

DO NOT have a fuse in a neutral or ground circuit.

GROUNDING INSTRUCTIONS



Grounding a range with a cord connection:

This appliance must be Earth grounded. In the event of a malfunction or breakdown, grounding will reduce the risk of electrical shock by providing a path for the electric current. This appliance is equipped with a cord having a grounding plug. The plug must be firmly plugged into an outlet that is properly installed and grounded in accordance with the local codes and ordinances.

WARNING

Improper connection of the grounding plug can result in a risk of electric shock. Check with a qualified electrician if you have any doubt the appliance is properly grounded.



NEVER modify the plug provided with the appliance. If it does not fit the existing outlet, have a qualified electrician install a proper outlet.

INSTALLATION WARNINGS





Have your range installed and properly grounded by a qualified installer, in accordance with the grounding instructions on page 20. Any adjustment and service should be performed only by qualified gas range installers or service technicians.

Be sure your range is correctly installed and adjusted by a qualified service technician or installer for the type of gas (natural or LP) that is to be used. To utilize LP fuel source, the 5 surface burner orifices, 2 oven orifices must be exchanged with the provided LP orifice set, and the GPR adapter must be reversed.

Safety instructions

▲ WARNING

These adjustments must be made by a qualified service technician in accordance with the manufacturer's instructions and all codes and requirements of the authority having jurisdiction. Failure to follow these instructions could result in serious injury or property damage. The qualified agency performing this work assumes responsibility for the conversion.

-  Do not attempt to repair or replace any part of your range unless it is specifically recommended in this manual. All other service should be referred to a qualified technician.
-  This appliance must be properly grounded. Plug your range into a 120-volt grounded outlet that is only used for this appliance. Do not remove the grounding (third) prong from the plug. Firmly plug the power cord into the wall outlet. If you are not sure your electrical outlet is grounded, it is your personal responsibility and obligation to have a properly grounded, three-prong outlet installed in accordance with local and national codes. Do not use a damaged power plug or loose wall outlet. Do not use an extension cord with this appliance. In addition, do not use an adapter or otherwise defeat the grounding plug. If you do not have a proper outlet or have any doubt, consult a licensed electrician.
-  Locate the range out of kitchen traffic paths and drafty locations to prevent poor air circulation.

This appliance should be positioned in such a way that the power plug is accessible.

Do not install in an area exposed to dripping water or outside weather conditions.

Remove all packaging materials from the range before operating it. These materials can ignite, causing smoke and/or fire damage.

Install this appliance on a level and hard floor that can support its weight. Synthetic flooring, like linoleum, must withstand 180 °F (82 °C) temperatures without shrinking, warping, or discoloring. Never install the range directly over interior kitchen carpeting unless a sheet of 0.25" plywood or similar insulator is placed between the range and carpeting.

-  Never block the vents (air openings) of the range. They provide the air inlet and exhaust necessary for the range to operate properly with correct combustion. Air openings are located behind the range, under the oven control panel, at the top and bottom of the oven door, and under the lower warming or storage drawer.

Large scratches or impacts on door glass can cause the glass to break or shatter.

-  Make sure the wall coverings around the range can withstand heat, up to 200 °F (93 °C), generated by the range.

Avoid placing cabinets above the range. This reduces the hazard caused by reaching over the open flames of operating burners.

If cabinets are placed above the range, allow a minimum clearance of 40" (102 cm) between the cooking surface and the bottom of unprotected cabinets.

Install a ventilation hood or an externally vented Over The Range Microwave Oven over the range cooktop that is as wide as the range, centered over the range, and projects forward beyond the front of the cabinets. See page 17 in this manual.

Remove all tape and packaging. Make sure the burners are properly seated and level.

Remove any accessories from the oven and/or lower drawer.

Check to make sure no range parts have come loose during shipping.

Seal any openings in the wall behind the appliance and in the floor under the appliance after the gas supply line is installed.

Safety instructions

SURFACE BURNER WARNINGS

WARNING

Follow basic precautions when installing and using this range to reduce the risk of fire, electrical shock, injury, or death to persons, including:

-  Use proper pan sizes. Avoid pans that are unstable or warped. Select cookware having flat bottoms large enough to cover the burner grates. To avoid spillovers, make sure cookware is large enough to contain your food. This will save cleaning time and prevent hazardous accumulations of food, since heavy spattering or spillovers left on the range can ignite. Use pans with handles that can be easily grasped and remain cool.

Always use the LITE position when igniting the top burners. Make sure the burners have ignited.

-  Never leave the surface burners unattended at HIGH flame settings. Boilovers cause smoking, and greasy spillovers that might catch on fire.

-  Adjust the top burner flame size so it does not extend beyond the edge of the cookware. Excessive flames past cookware edges can be hazardous.

Only use dry pot holders. Pot holders with moisture in them may result in burns from steam when they come in contact with hot surfaces.

Keep pot holders away from open flames when lifting cookware. Never use a towel or bulky cloth in place of a pot holder.

Keep all plastic away from the surface burners or any open flame.

When using glass cookware, make sure it is designed for top-of-range cooking.

Always make sure cookware handles are turned to the side or rear of the cooktop, but not over other surface burners. This will minimize the chance of burns, spillovers, and ignition of flammable materials due to bumping the pan.

Do not wear loose or hanging garments when using the range. They could ignite and burn you if they touch a surface burner.

Always heat frying oils slowly, and watch as it heats. If foods are being fried at high heat, carefully watch during the cooking process. If a combination of fats or oils are to be used during frying, they need to be stirred together before heating.

Safety instructions

- ★ Use a deep fryer thermometer whenever possible. This prevents overheating the fryer beyond the smoking point.

Use as little oil as possible for shallow or deep-fat frying. Using too much oil can cause spillovers when food is added.

Items should always be removed from the cooktop when they are done cooking. Never leave plastic items on the cooktop. This prevents the hot air from the vent from igniting flammable items, melting, or building up pressure in closed containers.

This cooktop is not designed to flame foods or cooking with a wok or wok ring attachment. If foods are flamed, they should only be flamed under a ventilation hood that is on.

Always make sure foods being fried are thawed and dried. Moisture of any kind can cause hot oil to bubble up and over the sides of the pan.

- ☐ Never move a pan or deep-fat fryer full of hot oil. It should always be cooled before moving.
- ★ Always make sure the controls are OFF and the grates are cool before they are removed to prevent any possibility of burning.
- ☐ If range is located near a window, NEVER hang long curtains or paper blinds on that window. They could blow over the surface burners and ignite, causing a fire hazard.
- ☐ Grease is flammable and should be handled very carefully. Do not use water on grease fires.
- ★ If you smell gas, turn off the gas to the range and call a qualified service technician. NEVER use an open flame to locate a leak.

Always turn off the surface burner controls before removing cookware. All surface burner controls should be turned OFF when not cooking.

Do not use a wok on the cooking surface if the wok has a round metal ring that is placed over the burner grate to support the wok. This ring acts as a heat trap, which may damage the burner grate and burner head. Also, it causes the burner to work improperly. This may cause a carbon monoxide level above that allowed by current standards, resulting in a health hazard.

OVEN WARNINGS

▲ WARNING

NEVER cover any holes or passages in the bottom oven cover. NEVER cover an entire oven rack with aluminum foil or like material. Covering bottom cover and/or racks blocks airflow through the oven and could cause carbon monoxide poisoning.

- ☐ Do not use aluminum foil or foil liners anywhere in the oven. Misuse traps heat and could cause a fire hazard or damage the range.
- ★ Always follow the manufacturers directions when using cooking or roasting bags in the oven.
- ☐ DO NOT clean the door gasket. The door gasket is essential for a good seal. Care should be taken not to damage or move the gasket.
- ★ Stand away from the range when opening the door of a hot oven. The escaping hot air and steam can cause burns to hands, face and eyes.
- ☐ Do not use the oven for storage. Stored items can be damaged or ignite.
- ★ Keep the oven free from grease buildup.
- ☐ Reposition oven racks when the oven is cool to prevent burning or personal injury.
- ☐ Do not heat unopened containers. Pressure in the container could build up, resulting in explosion and/or personal injury.
- ★ Only use glass cookware that is recommended for use in gas ovens.
- ☐ Always remove the broiler pan from the range when broiling is finished. Clean after each use. This prevents fire flare-ups from stored grease buildup.
- ☐ Do not broil meat too close to the burner flame. Trim excess fat from meat before cooking. Meat fat can ignite, causing a fire hazard. Make sure broiler pan is placed correctly to reduce the possibility of grease fires.

Safety instructions

- ★ If a grease fire should occur in the oven, turn off the oven by pressing the Clear/Off pad. Keep the oven door closed to put out the fire.
Always bake and/or broil with the oven door closed. Broiling with the door partially or fully open can damage the surface burner control knobs.
Keep the appliance area clear and free from combustible materials, gasoline, and other flammable vapors and liquids.
- ☒ Do not use the oven to dry newspapers or mail. Such items will catch fire if overheated.
For safety and proper cooking performance, always bake and broil with the oven door closed.

ELECTRIC WARMING DRAWER OR LOWER STORAGE DRAWER WARNINGS

- ★ The warming drawer is designed to keep hot cooked foods at a serving temperature. Always start with hot food. Cold or room-temperature foods cannot be heated, warmed, or cooked in the warming drawer.
- ☒ Do not touch the interior drawer surface or heating element. These surfaces may be hot and could burn you.
- ★ Use care when opening the drawer. Escaping hot air and/or steam can cause burns or personal injury.

- ☒ Do not use aluminum foil to line the lower drawer. Aluminum foil will trap heat and alter the warming performance of the drawer. It could also damage the interior finish.
Never use or self-clean the oven drawer pan in the upper oven.
Never leave jars or cans of fat drippings in or near your drawer.
Do not leave or store paper products, plastics, canned food, or combustible materials in the drawer. Do not use drawer to dry newspapers. They could ignite or melt if overheated.
Do not use the drawer to dry newspapers. If overheated, they can catch on fire.





SELF-CLEANING OVEN WARNINGS

▲ WARNING

Follow basic precautions when installing and using this range to reduce the risk of fire, electrical shock, injury, or death to persons, including:

- ☒ Do not leave children unattended near the range during a self-cleaning cycle. The outside surfaces of the range get hot enough to burn if touched.
- ★ Stand away from the range when opening the oven door after a self-cleaning cycle. The oven will be VERY HOT and the escaping hot air and steam can cause burns.
Remove all racks and other utensils from the oven before starting a self clean cycle. The oven racks may become damaged, and foreign objects could ignite if left within the oven cavity.
Wipe off any excess spillage before using the self-cleaning operation.
Remove any broiler pans, all cookware, oven probe, and any aluminum foil before using the self-cleaning operation.

Safety instructions

-  Never self-clean with the lower drawer or drawer pan placed in the oven.
-  If the self-cleaning operation malfunctions, turn off the oven, disconnect the power supply, and contact a qualified service technician.
-  Do not use oven cleaners. Commercial oven cleaners or oven liners should NEVER be used in or around any part of the oven. Residue from oven cleaners will damage the inside of the oven during a self-cleaning operation.
-  Nickel oven shelves should be removed from the oven during a self-cleaning cycle. Porcelain-coated oven shelves may be cleaned in the oven during a self-cleaning cycle.
-  Do not clean the door gasket. The door gasket is essential for a good seal. Care should be taken not to rub, damage, or move the gasket.

PROPER COOKING OF MEAT AND POULTRY

-  Make sure all meat and poultry is cooked thoroughly. Meat should always be cooked to an internal temperature of 160 °F (71 °C). Poultry should always be cooked to an internal temperature of 180 °F (82 °C). Cooking these foods to these minimally safe temperatures can help protect you and your family from foodborne illnesses.

Contents

Gas range components	13
Overview	13
Gas range specifications	15
Installation requirements	17
Location requirements	17
Gas requirements	18
Special gas requirements (Gas models sold in Massachusetts)	19
Electrical requirements	19
Tools and materials	21
What's in the box	21
Installation instructions	22
Installing your gas range	22
Adjusting the oven burner air adjustment shutters	29

Gas range components

Overview

MODEL NX58*565***

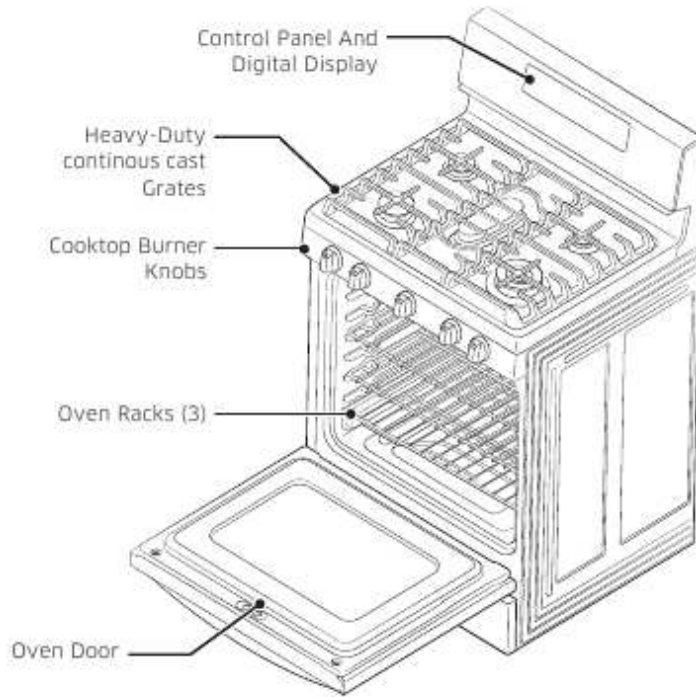

Cooktop Burner Placement

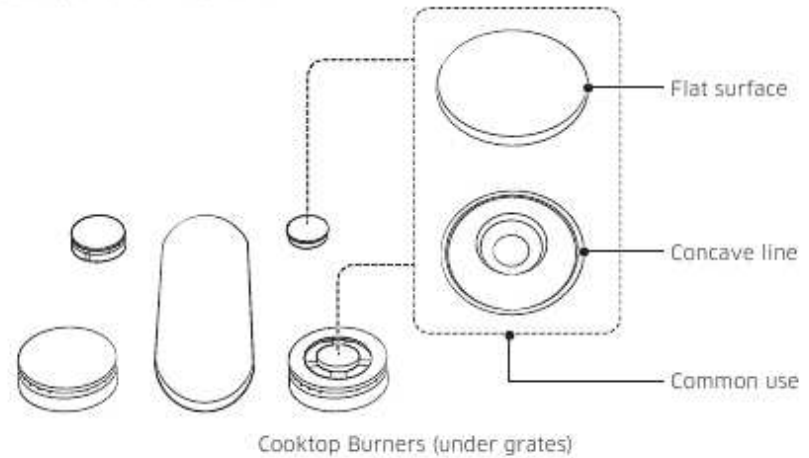

Burner Locations and Output Ratings

Location	Output Rating (Natural Gas)
Left-Front (LF)	15,000 BTU
Left-Rear (LR)	9,500 BTU
Center (CTR)	9,500 BTU
Right-Rear (RR)	5,000 BTU
Right-Front (RF)	18,000 BTU
Warming Drawer (with Full Extension Roller Guide Rails)	

Gas range components

MODEL NX58*560***

Gas range components

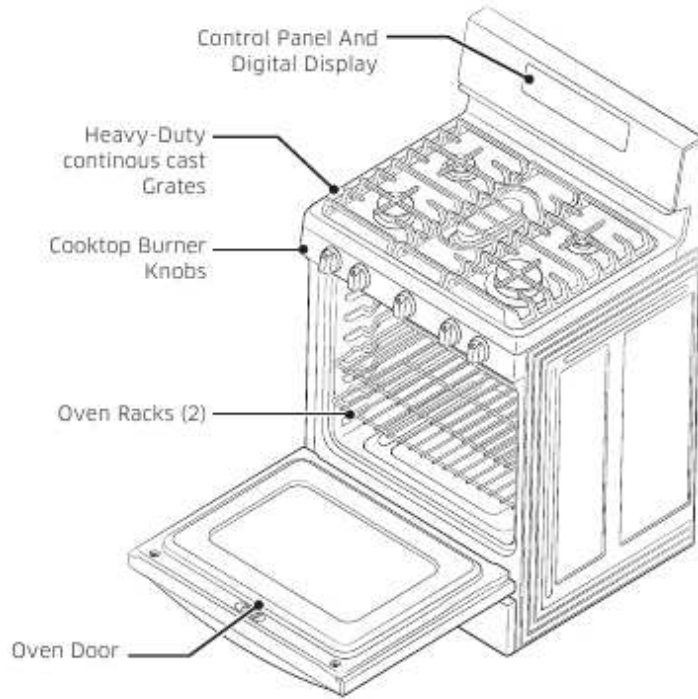

Cooktop Burner Placement

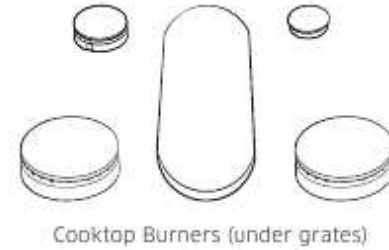

Burner Locations and Output Ratings

Location	Output Rating (Natural Gas)
Left-Front (LF)	15,000 BTU
Left-Rear (LR)	9,500 BTU
Center (CTR)	9,500 BTU
Right-Rear (RR)	5,000 BTU
Right-Front (RF)	17,000 BTU
Storage Drawer	

Gas range components

Gas range specifications

MODEL NX58*565***

DESCRIPTION	Gas Free-Standing Range
OVERALL DIMENSIONS	29 ¹⁵ / ₁₆ " (W) x 46 ¹¹ / ₁₆ " (H) x 28 ⁵ / ₁₆ " (D) 761 mm (W) x 1,186.2 mm (H) x 718.7 mm (D)
NET WEIGHT	204 lb (92.4 Kg)
ELECTRICAL	Refer to the rating label.
GAS, NG (NATURAL GAS)	5-13 in WC
GAS, LP (LIQUID PROPANE)	10-13 in WC
SURFACE BURNERS (NG)	(LF)-15,000 BTU / (LR)-9,500 BTU / (CTR)-9,500 BTU / (RR)-5,000 BTU / (RF)-18,000 BTU
SURFACE BURNERS (LP)	(LF)-11,500 BTU / (LR)-7,500 BTU / (CTR)-7,500 BTU / (RR)-4,000 BTU / (RF)-14,500 BTU
OVEN BURNERS (NG)	Broil (Upper)-13,500 BTU / Bake (Lower)-18,000 BTU
OVEN BURNERS (LP)	Broil (Upper)-11,500 BTU / Bake (Lower)-15,000 BTU

MODEL NX58*560***

DESCRIPTION	Gas Free-Standing Range
OVERALL DIMENSIONS	29 ¹⁵ / ₁₆ " (W) x 46 ¹¹ / ₁₆ " (H) x 28 ⁵ / ₁₆ " (D) 761 mm (W) x 1,186.2 mm (H) x 718.7 mm (D)
NET WEIGHT	186 lb (84.5 Kg)
ELECTRICAL	Refer to the rating label.
GAS, NG (NATURAL GAS)	5-13 in WC
GAS, LP (LIQUID PROPANE)	10-13 in WC
SURFACE BURNERS (NG)	(LF)-15,000 BTU / (LR)-9,500 BTU / (CTR)-9,500 BTU / (RR)-5,000 BTU / (RF)-17,000 BTU
SURFACE BURNERS (LP)	(LF)-10,000 BTU / (LR)-7,500 BTU / (CTR)-7,500 BTU / (RR)-4,000 BTU / (RF)-12,500 BTU
OVEN BURNERS (NG)	Broil (Upper)-13,500 BTU / Bake (Lower)-18,000 BTU
OVEN BURNERS (LP)	Broil (Upper)-11,500 BTU / Bake (Lower)-15,000 BTU

Gas range components

Gas range components

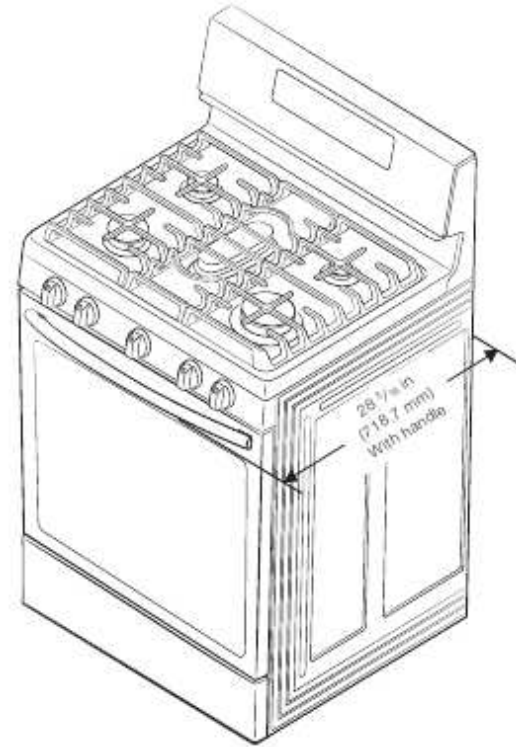
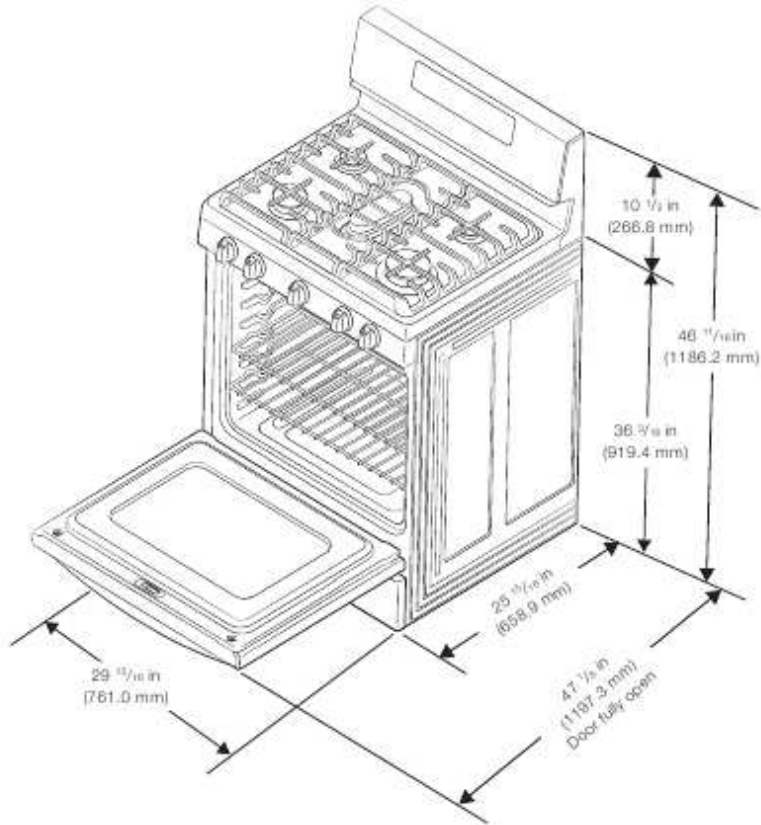

Installation requirements

Location requirements

Clearances and dimensions

NOTE

For DTR over Gas Stove, please follow local GAS CODE.

BEFORE YOU BEGIN to install this appliance, refer to the following information, dimensions, and clearances. **Do not locate the range where it may be subject to strong drafts.** Provide adequate clearances between the range and adjacent combustible surfaces. These dimensions must be met for safe use of the range. The location of the electrical outlet and gas piping may be adjusted to meet the following dimensions and clearances.

For installation in Canada, a free-standing range is not to be installed closer than 4.7" (12 cm) from any adjacent surface.

CAUTION

This range has been designed to comply with the maximum allowable wood cabinet temperature of 194 °F (90 °C). Make sure the wall covering, countertops, and cabinets around the range can withstand the heat (up to 194 °F [90 °C]) generated by the range. If not, discoloration, delamination, or melting may occur.

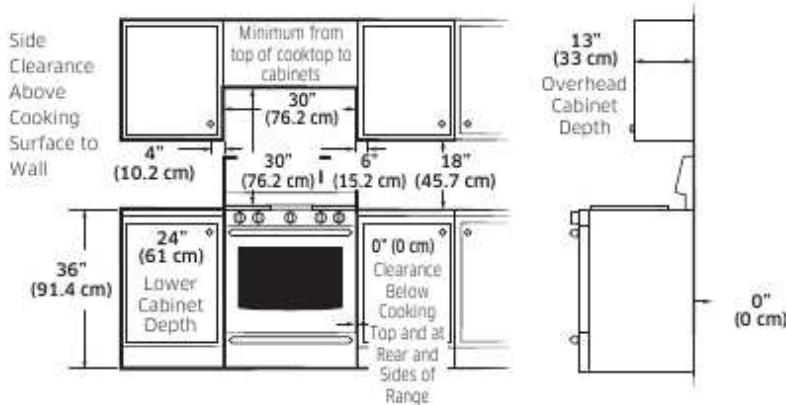

Minimum dimensions

WARNING

If overhead cabinets are provided, a range hood should also be provided that projects horizontally a minimum of 5" (12.7 cm) beyond the front of the cabinets. This will dissipate any heat buildup in the overhead cabinets to prevent death, personal injury, and/or fire hazard. The ventilating hood must be constructed of sheet metal not less than 0.0122" thick. Install above the cooktop with a clearance of not less than 1/4" between the hood and the underside of the combustible material or metal cabinet. The hood must be at least as wide as the appliance and centered over the appliance. Clearance between the cooking surface and the ventilation hood surface must never be less than 24".

Exception: Installation of a listed microwave oven or cooking appliance over the cooktop shall conform to the installations packed with that appliance.

- 30" (101.6 cm) minimum clearance between the top of the cooking surface and the bottom of an unprotected wood or metal cabinet; or if no 30" (101.6 cm) minimum clearance, 24" (61 cm) minimum when the bottom of the wood or metal cabinet is protected by not less than 0.25" (0.64 cm) flame-retardant millboard covered with not less than no. 28 MSG sheet steel, 0.015" (0.038 cm) stainless steel, 0.024" (0.061 cm) aluminum, or 0.020" (0.051 cm) copper.
- 18" (45.7 cm) minimum between the countertop and the adjacent cabinet bottom.

Installation requirements

Recommended locations for gas piping and electrical outlets

(For models NX58*565*** / NX58*560***)

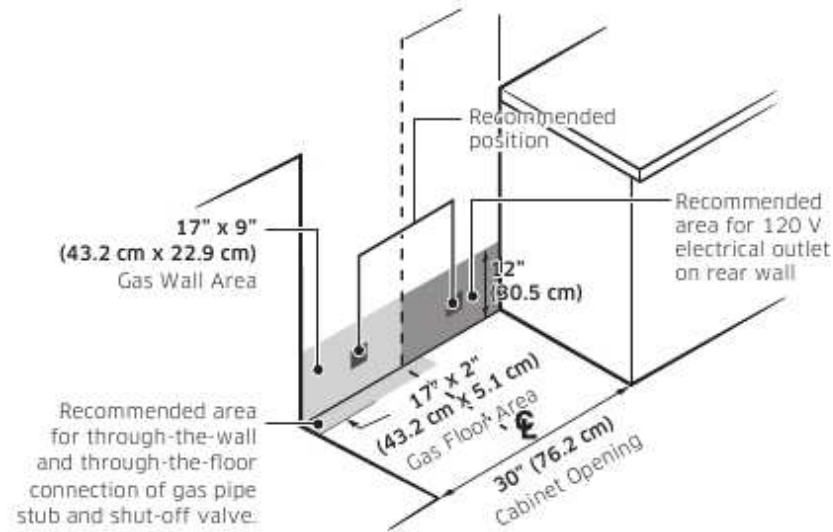

Gas requirements

Provide adequate gas supply

This range is designed to operate at a pressure of 5" (13 cm) of water column on natural gas or 10" (25 cm) of water column on LP gas (propane or butane).

Make sure you are supplying your range with the type of gas for which it is designed. **Do not attempt to convert the appliance from the gas specified in this manual to a different gas without consulting the gas supplier.**

This range is convertible for use on natural or propane gas. If you decide to use this range on LP gas, conversion must be made by a qualified LP installer before attempting to operate the range.

For proper operation, the pressure of natural gas supplied to the regulator must be between 5" and 13" (13 cm and 33 cm) of water column.

For LP gas, the pressure supplied must be between 10" and 13" (25 cm and 33 cm) of water column.

When checking for proper operation of the regulator, the inlet pressure must be at least 1" (2.5 cm) greater than the operating (manifold) pressure as given.

The pressure regulator located at the inlet of the range manifold must remain in the supply line regardless of whether natural or LP gas is being used.

A flexible-metal appliance connector used to connect the range to the gas supply line should have an I.D. of 0.5" (1.3 cm) and be 5 ft (152 cm) in length for ease of installation. In Canada, flexible connectors must be single-wall metal connectors no longer than 6 ft (183 cm) in length.

Do not kink or damage the flexible metal tubing when moving the range.

Installation requirements

Special gas requirements (Gas models sold in Massachusetts)

Commonwealth of Massachusetts requirements:

▲ WARNING

Gas leaks may occur in your system, creating a dangerous situation.

- Gas leaks may not be detected by smell alone.
- Gas suppliers recommend you purchase and install a UL-approved gas detector. Gas detector should be installed in accordance with the manufacturer's instructions.
 - Range must be installed by a qualified plumber or gas fitter by the State of Massachusetts.
 - A T-handle manual gas valve **MUST** be installed in the gas supply line to your range.
 - If a flexible gas connector is used to install your range, multiple flexible gas lines must not be connected in series.

Electrical requirements

▲ WARNING

To reduce the risk of fire, electric shock, or personal injury:

All ranges

- Do not use an extension cord or adapter plug with this range.
- This range must be properly grounded.
- Check with a qualified electrician if you are in doubt as to whether your range is properly grounded.
- Do not modify the plug provided with your range—if it doesn't fit the outlet, have a proper outlet installed by a qualified electrician.
- All wiring and grounding must be done in accordance with local codes or, in the absence of local codes, with the National Electrical Code, ANSI/NFPA No. 70 – Latest Revision (for the U.S.) or the Canadian Electrical Code CSA C22.1 – Latest Revisions and local codes and ordinances.
- Wiring diagram is located on the back of the range. (inside of the cover back wire)
- This range is equipped with an electronic ignition system that will not operate if plugged into an outlet that is not properly polarized.

Gas models

- All gas models are equipped with a power cord with an equipment-grounding conductor and a grounding plug.
- A 120-Volt, 60-Hz, AC, approved electrical service with or 20-amp circuit breaker or time-delay fuse is required for all U.S. and Canadian models.
- Check for $\frac{3}{8}$ " (1.9 cm) UL-listed strain relief where the power cord comes out of the range cabinet.
- Do not reuse a power supply cord from an old range or other appliance.
- The power cord electric supply wiring must be retained at the range cabinet with a suitable UL-listed strain relief.
- A time-delay fuse or circuit breaker is also recommended.

Installation requirements

Grounding

- All ranges must be grounded for personal safety.
- All gas models have a power cord with an equipment-grounding conductor and a grounding plug.
- The plug must be firmly plugged into a three-prong outlet that is properly installed and grounded in accordance with all local codes and ordinances. In the event of a malfunction or breakdown, grounding will decrease the risk of electrical shock by providing a path for the electric current.
- Do not use a damaged power plug or loose wall outlet.
- Do not use an extension cord or adapter with this appliance.
- Do not, under any circumstances, cut, modify, remove, or otherwise defeat the grounding (third) prong from the power cord. If the plug and the outlet do not match or you have any doubt, have a qualified electrician install the proper outlet.
The customer should have the wall receptacle and circuit checked by a qualified electrician to make sure the receptacle is properly grounded. Ground Fault Circuit Interrupters(GFCIs) are not required or recommended for gas range receptacles.
- **NEVER** connect ground wire to plastic plumbing lines, gas lines, or water pipes.



⚠ CAUTION

Failure to follow these instructions can result in death, fire, or electrical shock.

Usage situations where appliance power cord will be disconnected frequently

Do not use an adapter plug in these situations because disconnecting of the power cord places undue strain on the adapter and leads to eventual failure of the adapter ground terminal. Where a standard two-prong wall receptacle is encountered, it is the personal responsibility and obligation of the customer to have it replaced with a three-prong (grounding) receptacle by a qualified electrician before using the appliance.

Additional installation requirements for mobile homes

The installation of appliances designed for mobile home installation must conform with the Manufactured Home Construction and Safety Standard, Title 24 CFR, Part 3280 (formerly the Federal Standard for Mobile Home Construction and Safety, Title 24, HUD, Part 280) or, when such standard is not applicable, the Standard for Manufactured Home Installations, latest edition (Manufactured Home Sites, Communities and Set-Ups), ANSI A225.1, latest edition, or with local codes. In Canada, mobile home installation must be in accordance with the current CAN/CSA Z240/MH Mobile Home Installation Code.

Power cord location

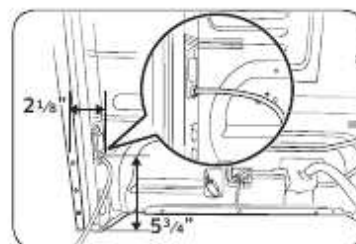

Power cord location

The power cord for this appliance is located on the back of the range, near the bottom right hand corner. The 53" (135 cm) power cord will come installed on the range and taped to the back for shipping.

Tools and materials

What's in the box

Parts supplied

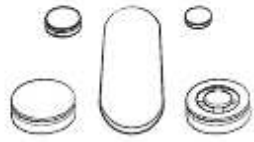

Surface burners and caps (5)
(Model NX58*565***)

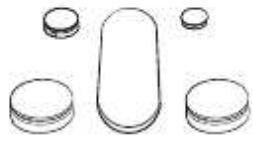

Surface burners and caps (5)
(Model NX58*560***)

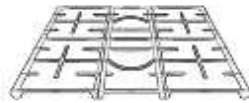

Surface burner grates (3)



Oven racks (3)
Griddle, Wok grate
(NX58*565***)

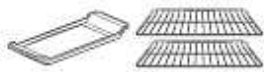

Oven racks (2)
Griddle
(NX58*560***)



Anti-tip bracket kit

- Make sure you have received all of the supplied parts shown above.
- If your range was damaged during shipping or you do not have all of the supplied parts, contact your local retailer.

Parts needed



Gas line shut-off valve



Flexible metal appliance connector 1/2" (ID) x 5 ft



Flare union adapter 1/4" or 1/2" (NPT) x 1/2" (ID)



Flare union adapter 1/2" (NPT) x 1/2" (ID)



135-degree elbow (optional)



Lag bolt or 1/2" (OD) sleeve anchor

Tools needed



Flat-blade screwdriver



Phillips screwdriver



Open-end or adjustable wrench



Pipe wrench (2)



Nut driver



Pencil and ruler



Level



Pipe joint compound



Utility knife



Soapy water solution

Installation instructions

Installing your gas range

IMPORTANT: Please read the following instructions, as well as the Important Safety Instructions section at the front of this manual, completely and carefully BEFORE installing and/or operating the gas range. Improper installation, adjustment, service, or maintenance can cause personal injury or property damage.

NOTE

- To order parts or accessories, contact your local retailer or refer to the last page.
- To ensure proper installation, we strongly recommend that you hire a professional installer.

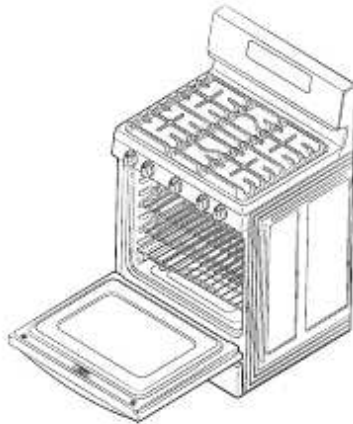

Step 1. Unpack the range

Remove all packaging materials. Failure to remove packaging materials could result in damage to the appliance.

Inventory all loose parts against the Parts supplied components listed on page 21.

Check for shipping damage and/or missing parts. Any damage and/or missing parts should be reported to your local retailer.

Step 2. Connect the range to gas supply

Shut off the main gas supply valve before disconnecting the old range and leave it off until the new hookup has been completed. Don't forget to relight the pilot on other gas appliances when you turn the gas back on.

Because hard piping restricts movement of the range, the use of a CSA International-certified flexible metal appliance connector is recommended unless local codes require a hard-piped connection.

WARNING

If the information in this manual is not followed exactly, a fire or explosion may result, causing death, personal injury, or property damage.

- Do not store or use gasoline or other flammable vapors and liquids in the vicinity of this or any other appliance.
- WHAT TO DO IF YOU SMELL GAS:
 - DO NOT light a match, candle, or cigarette.
 - DO NOT try to light any appliance.
 - DO NOT touch any electrical switch.
 - DO NOT use any phone in your building.
 - Clear the room, building, or area of all occupants.
 - Immediately call your gas supplier from a neighbor's phone. Follow the gas supplier's instructions.
 - If you cannot reach your gas supplier, call the fire department.
- Installation and service must be performed by a qualified installer, service agency, or gas supplier.

Installation instructions

Never use an old connector when installing a new range. If the hard-piping method is used, you must carefully align the pipe; the range cannot be moved after the connection is made.

To prevent gas leaks, apply pipe-joint compound or wrap pipe-thread tape with Teflon on all male (external) pipe threads.

1. Install a manual gas line shut-off valve in the gas line in an easily accessed location outside of the range.
Make sure everyone operating the range knows where and how to shut off the gas supply to the range.
2. Install male 0.5" (1.3 mm) flare union adapter to the 0.5" (1.3 mm) NPT internal thread at the regulator inlet. Use a backup wrench on the regulator fitting to avoid damage.
When installing the range from the front, remove the 90° elbow for easier installation.
3. Install male 0.5" (1.3 mm) or 0.75" (1.9 mm) flare union adapter to the NPT internal thread of the manual shut-off valve, taking care to back up the shut-off valve to keep it from turning.
4. Connect flexible metal appliance connector to the adapter on the range. Position range to permit connection at the shut-off valve.
5. When all connections have been made, make sure all range controls are in the off position and turn on the main gas supply valve. Use a liquid leak detector at all joints and connections to check for leaks in the system.

▲ WARNING

Do not use a flame to check for gas leaks to prevent death, personal injury, explosion, and/or fire hazard.

When using test pressures greater than 1/2 psig to pressure-test the gas supply system of the residence, disconnect the range and individual shut-off valve from the gas supply piping. When using test pressures of 1/2 psig or less to test the gas supply system, simply isolate the range from the gas supply system by closing the individual shut-off valve.

▲ WARNING

Do not exceed 25 ft-lbs of torque when making gas line connections. Overtightening may crack the pressure regulator resulting in a gas leak.

Flexible connector hookup

Installer: Inform the consumer of the location of the gas shut-off valve.

NOTE

- If your area requires a rigid pipe hookup, contact a qualified installer, service agency, or gas supplier.
- The gas shut-off valve should be installed in an accessible location in the gas piping, external to the appliance, for the purpose of turning on or shutting off the gas to the appliance.

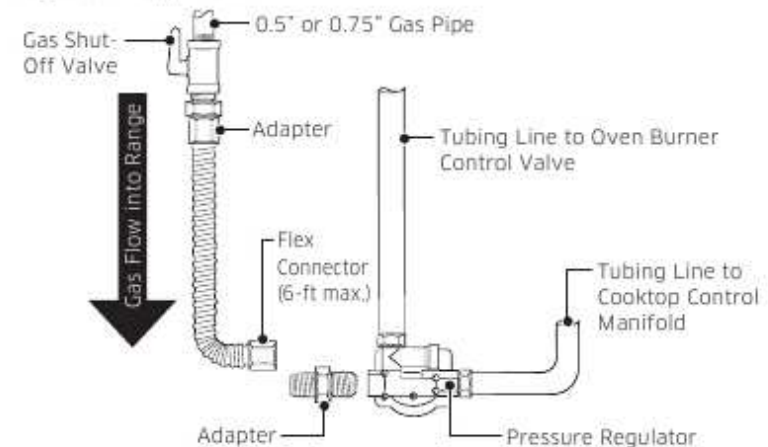

Installation instructions

Step 3. Convert to lp gas (optional)

All new gas ranges are shipped from the factory set up to use natural gas. Any Samsung gas range can be converted to use LP gas. Refer to page 80 in the User Manual to contact a qualified service technician.

The conversion process should only be performed by a qualified LP gas installer. Conversion instructions and LP orifices will be supplied with the LP conversion kit. The conversion to LP requires all burner orifices to be changed (5 surface burners and 2 oven burners).

In addition, the nozzle on the gas pressure regulator needs to be reversed. All replaced orifices must be left with the consumer, including the instructions and retrofit sizes and orifice indication.

BURNER ORIFICE SIZES AND OUTPUT RATINGS (LP Gas [Propane] 10 in WCP)		
Burner Location	BTU Rate	Orifice Size [mm]
RF ¹	14,500	1.12
RF ²	12,500	1.06
LF ¹	11,500	1.04
LF ²	10,000	0.98
RR	4,000	0.62
LR	7,500	0.83
CTR	7,500	0.83
BAKE	15,000	1.15
BROIL	11,500	1.02

¹ Model NX58*565***

² Model NX58*560***

BURNER ORIFICE SIZES AND OUTPUT RATINGS (Natural Gas 5 in WCP)		
Burner Location	BTU Rate	Orifice Size [mm]
RF ¹	18,000	1.92
RF ²	17,000	1.92
LF	15,000	1.78
RR	5,000	1.01
LR	9,500	1.40
CTR	9,500	1.38
BAKE	18,000	1.90
BROIL	13,500	1.64

Step 4. Install the anti-tip device

⚠ WARNING

To reduce the risk of tipping, the appliance must be secured by properly installing the anti-tip device packed with the appliance.

- All ranges can tip, resulting in personal injury.
- Tipping ranges can cause burns from spills, personal injury, and/or death.
- To prevent accidental tipping, install and check the anti-tip bracket following the instructions and template supplied with the bracket.

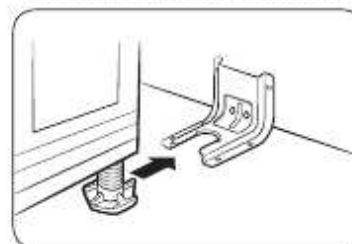

An anti-tip bracket and screws, installation instructions, and template are shipped with every range (PN DG94-00870B). The instructions include information necessary to complete the installation of the anti-tip bracket. Read and follow the instructions on the sheet and use the template for anti-tip bracket installation. If not properly installed, the range could be tipped by you or a child standing, sitting, or leaning on an open oven door.

📖 NOTE

To install an anti-tip bracket, release and extend the leveling leg to a minimum clearance of 21/32" (16.5 mm) between the range bottom and the floor.

To check if the bracket is installed and engaged properly, remove the warming drawer or storage drawer and look underneath the range to see that the leveling leg is engaged in the bracket. Carefully tip the range forward. The bracket should stop the range within 4" (10.2 cm) of tipping. If it does not, the bracket must be reinstalled.

If the range is pulled from the wall for any reason, always repeat this procedure to verify the range is properly secured by the anti-tip bracket. Never completely remove the leveling legs or the range will not be secured to the anti-tip device properly.

Installation instructions

Step 5. Plug in and place

⚠ WARNING

BEFORE OPERATING OR TESTING, follow the grounding requirements on pages 19 ~ 20 in this manual. Improper connection of the grounding plug can result in a risk of electric shock.

- **All gas ranges come with a power cord.** The power cord is connected to the rear of the range. Please review **Electrical requirements** on pages 19 ~ 20.
- All U.S. and Canadian models are produced with a 3-wire, 120-volt, 60-Hertz electrical system. The entire system, including the power cord, is preinstalled and prewired at the factory. Altering any part of this system may result in a short or overload.



1. Plug in the power cord. Make sure the outlet meets local or national electrical codes as referenced on pages 19 ~ 20.
2. Slide the range into place.
3. Check the gas supply line to make sure it did not get damaged and it stayed connected during positioning.
4. Check to make sure the back leg of the range has slid into the anti-tip bracket. Carefully tip the range forward to ensure that the anti-tip bracket engages the back brace and prevents tip-over.

Step 6. Level the range



1. Make sure the range is positioned where you want it.
2. Using a wrench, level the range by turning the front leveling legs in or out as necessary. Counterclockwise shortens the leg and lowers the range. Clockwise lengthens the leg and raises the range.

NOTE

- Adjusting the two front legs is usually sufficient, but all four legs adjust if necessary.
 - Adjust the leveling legs only as far as necessary to level the range. Extending the leveling legs more than necessary or removing legs can cause the range to be unstable.
3. If range is next to or between cabinets, make sure the cooktop (without the surface burner grates) is level with the countertops.
 4. Position an oven rack in the center rack position.
 5. Check the level of the range with a carpenter level using the two positions shown at right.
 6. After the range becomes level, slide the range away from the wall so that the anti-tip bracket can be installed.

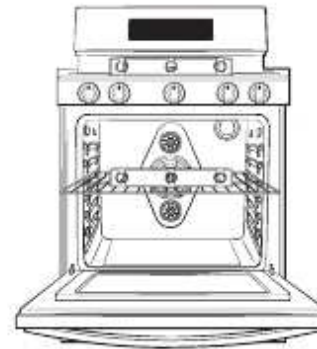

Installation instructions

Step 7. Assemble the surface burners

⚠ CAUTION

Do not operate the surface burners without all burner parts in place.

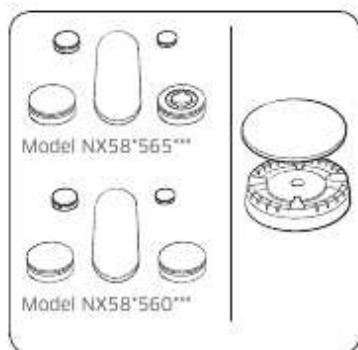

1. Position surface burner heads on top of the surface burner manifolds as shown at right. The electrodes will fit into the slot in the bottom of the heads. Make sure the surface burner heads are flat and parallel with the cooktop.
2. Place the matching size caps on top of each surface burner head.

📖 NOTE

The caps on Precise simmer burner (RR) and inside Dual Burner (RF) can be interchangeably used.

Precise Simmer Burner (RR)



Flat surface



Concave line

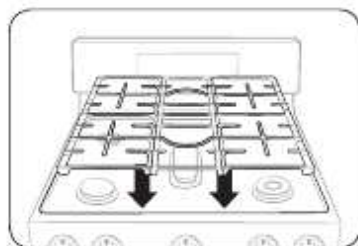

3. Place the left, center, and right surface burner grates on the cooktop. The edges of the grates should match up with the edges of the cooktop.

Step 8. Check the ignition of surface burners and oven burners

Check the operation of all cooktop and oven burners after the range has been installed and assembled, gas supply lines have been carefully checked for leaks, and electrical power cord has been plugged in.

All surface and oven burners have electronic ignition.

To turn on a surface burner:

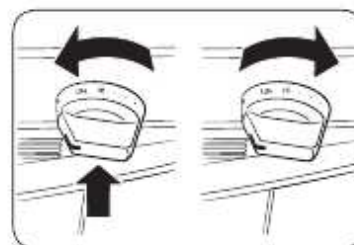

1. Push in and turn the control knob for that surface burner to the LITE position. The "clicking" sound indicates the electronic ignition system is operating properly. The burner will light in about 4 seconds, after the air has been purged from the supply line.
2. After the burner lights, turn the control knob to the desired setting. The "clicking" sound will stop and the flame height will change from Max. to Min. during turning the control knob.
3. Repeat steps 1 and 2 to check the operation of each surface burner in succession.

📖 NOTE

Place food in the oven after preheating if the recipe calls for it. Preheating is important for good baking results. After the oven has reached the desired cooking temperature, it will beep 6 times.

Installation instructions

To start the bake burners:



1. Press the **Bake** pad. The oven will beep every time a pad is pressed. The default temperature **350 °** and the **Start** indicator will blink on the display. If the default temperature is the desired cooking temperature, skip to step 2.

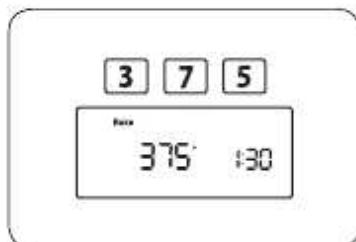

2. Press the number pads to change the temperature setting to the desired temperature setting. The selected cooking temperature and the **Start** indicator will blink on the display.

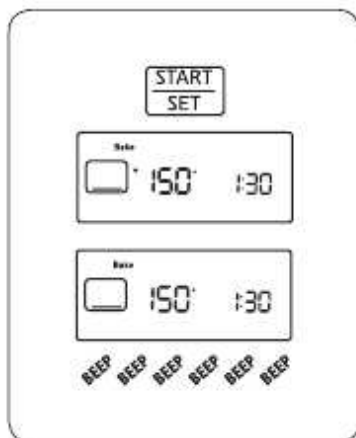

3. Press the **START/SET** pad. The display will show a blinking *****, along with **150 °**, **Bake**, and the bake element icon, until the oven reaches that temperature; then the display will just show the actual oven temperature. The oven will automatically light after 30~90 seconds and start preheating. When the oven reaches the desired baking temperature, it will beep 6 times.

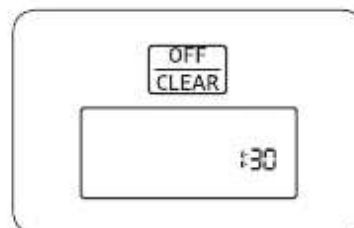

4. Press the **OFF/CLEAR** pad to shut off the oven. The display will show the time of day.

NOTE

The oven burners require electrical power to operate. They cannot be lit manually with a match, so the oven cannot be used during power outages.

To start the broil burners:

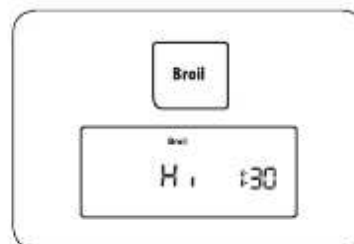

To check ignition of the broil burner, touch the Broil Hi/Lo Pad and then the start pad. After 30~90 seconds, the broil burner will ignite.

Installation instructions

Checking the flame quality:

All combustion flames need to be visually checked to determine their flame quality.

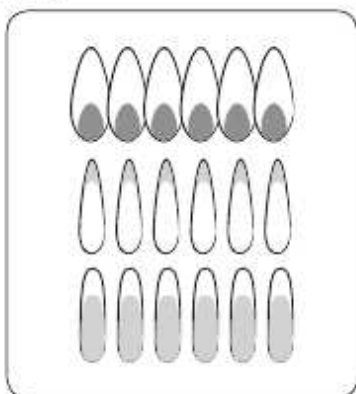

1. **Soft blue flames**—Normal for natural gas operation.
2. **Yellow tips on outer cones**—Normal for LP gas operation.
3. **Yellow flames**—Abnormal for any gas operation; call for service.

NOTE

If burner flame looks like 3, the range should not be used until it is serviced. Call for service. Normal burner flames shall look like 1 or 2, depending on the gas type you use.

Step 9. Final installation checklist

You have just completed installing your range. Make sure all controls are in the off position and the flow of ventilation air to the range is unobstructed. The following is a checklist to confirm your range is safely installed and ready for operation.

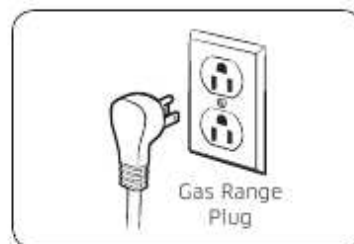

- Gas line has been properly connected to the range. The gas has been turned on. All connections have been checked for leaks.
- Range is plugged into the properly grounded electrical receptacle.

- Approved anti-tip bracket is properly installed and engaged with the range.



- Range is leveled and is firmly sitting on a solid, level floor.
- Gas surface burners have been properly assembled.
- All burners have been tested for proper operation.
- FOR INSTALLER ONLY—Check and/or adjust the broil and oven burner flames as described on page 29 in this manual.

Installation instructions

Adjusting the oven burner air adjustment shutters

All oven burners have an air adjustment shutter. The purpose of the shutter is to regulate the flow of air to the flames. Properly adjusted flames should burn steadily with approximately 1" of blue cone. The flames should never extend past the edge of the burner baffles. Even though these are preset at the factory, they should be checked and, if needed, adjusted periodically to ensure efficient operation.

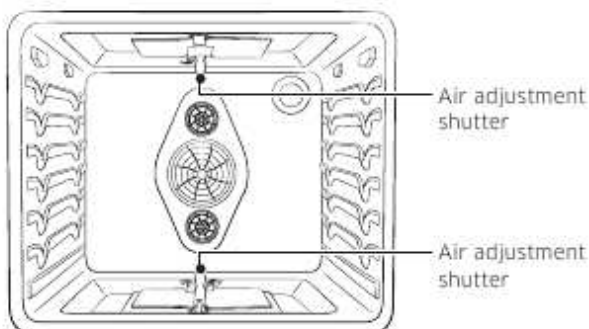

To check and adjust the oven burner air adjustment shutters:

1. Open the oven door.
2. Remove the oven racks.
3. Remove the oven floor.
4. Press the Bake pad, then the START pad.
5. After the oven has lit, visually check the flames coming out of the upper and lower burners. If adjustment is needed, carefully adjust the air adjustment shutters.

The shutters are located at the base of the burner manifolds near the back oven wall.

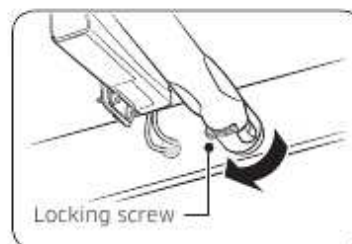

To adjust the shutter, loosen the locking screw and rotate the shutter towards the open or closed position as needed. If flames are lifting off the burner ports, gradually reduce the air shutter opening until the flames are stabilized.

If flames are too yellow and/or too large, gradually increase the air shutter opening until the flames have approximately a 1" blue cone.

NOTE

If the range is set up for natural gas, the flames should burn with no yellow tipping. If the range is set up for LP gas, small yellow tips at the end of the cones are normal.

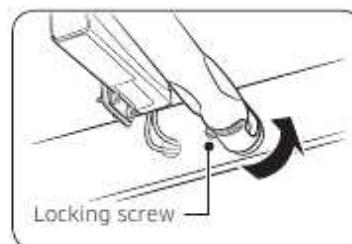

After the flames are adjusted properly, shut off the oven, retighten the locking screws, replace the oven bottom and racks, and close the oven door.

Installation instructions

Memo

To adjust flame low setting

Identify which burner is exhibiting too high or too low of simmer rate via manifold panel graphics.

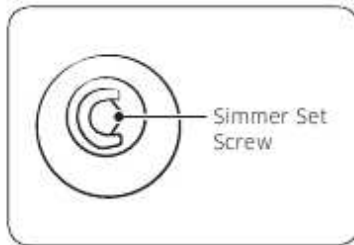

1. Rotate a knob to "LO" position and remove the knob from the valve shaft while the flame is lit.

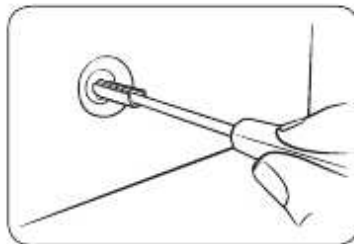

2. Carefully push the screw driver into the C channel of the valve, until it hits the simmer set screw. Make sure the screwdriver flathead is seated into the set screw groove.

3. Rotate valve set screw clockwise to decrease "LO" setting flame output, or rotate set screw counter clockwise to increase "LO" setting flame output.

⚠ WARNING

1. Do not completely remove the valve set screw from the valve stem. The valve set screw is an integral part of the gas valve assembly. Removing the valve set screw will cause gas to leak.
2. After adjusting the valve set screw, inspect the assembly for gas leaks.

Memo



Scan this with your smartphone

Scan the QR code* or visit www.samsung.com/spsn to view our helpful How-to Videos and Live Shows.
* Requires reader to be installed on your smartphone

Please be advised that the Samsung warranty does NOT cover service calls to explain product operation, correct improper installation, or perform normal cleaning or maintenance.

QUESTIONS OR COMMENTS?

COUNTRY	CALL	OR VISIT US ONLINE AT
U.S.A. Consumer Electronics	1-800-SAMSUNG (726-7864)	www.samsung.com/us/support
CANADA	1-800-SAMSUNG (726-7864)	www.samsung.com/ca/support (English) www.samsung.com/ca_fr/support (French)

