

Section 1

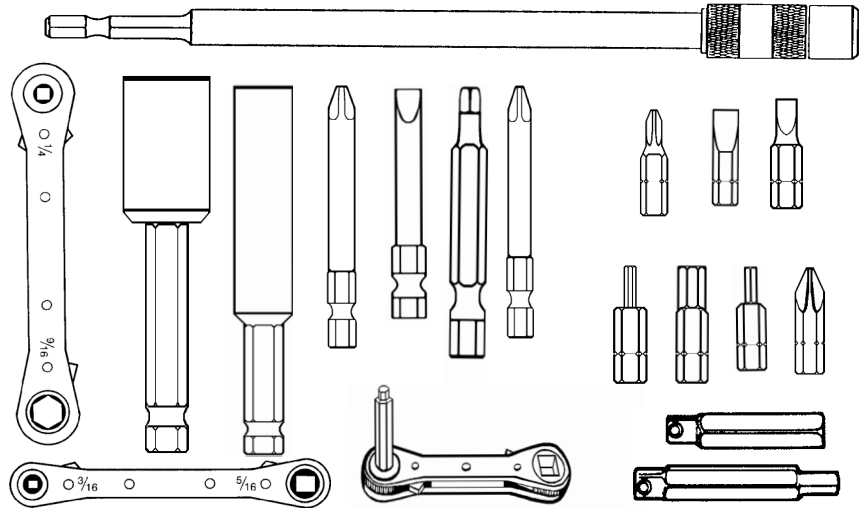

- Chucks
- Bit Holders
- Insert Bits
- Power Bits
- Refrigeration Tools & Bits
- Drive Extensions

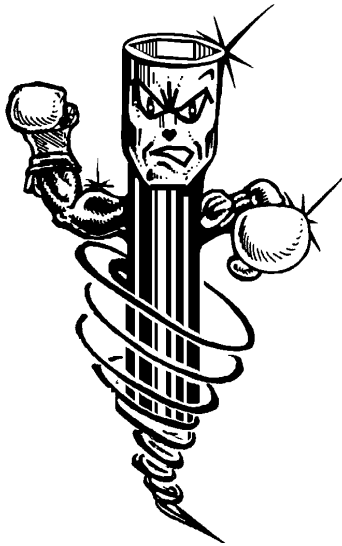

*Hi, Welcome to the All New 2014 Shook Products Catalog. I am **Jiffy**, the Fighting Chuck. Throughout this catalog you'll see me. When you do, BE SURE TO READ WHAT I HAVE TO SAY!*

*By the way, did you know that Shook invented the Hex Magnetic Driver, or like we call it, the "Jiffy" Chuck? That's right! It became known as **The Original Magnetic "Jiffy" Chuck**. This Superior Quality Tool has been an Industry Benchmark for more than 50 years. Remember, when it comes to "Chucks", ask for the original "Jiffy" Chuck!*

Product Packaging Key

POS - Individually packaged for POS (boxed, bagged or carded) for hanging display

CB - Counter Bowl (Plastic)

D - Multiple Display Card

HP - Hang Pack - (Clear Plastic Hang Box or Bag)

PL - Plastic Box or Plastic Tub

J-PK - Plastic Box

PB - Plastic Bucket with Handle

C - Chipboard Box

B - Bulk Packaged - (Loose - Bagged - Boxed)

JP - Jiffy Pail, Handle, & Lid

All Bulk Packaging includes quantity, product description and barcode number.

Custom Packaging and Labeling is Available.

The Original Magnetic

Jiffy Chuck

Industrial Nutdriver

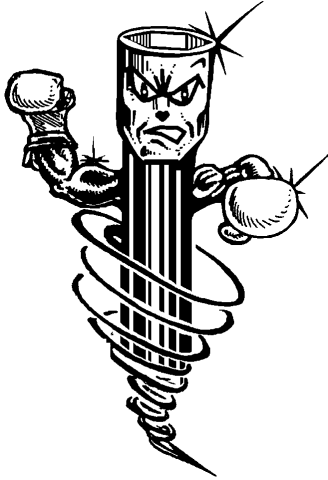

-Precision Manufactured from Tool Steel for Strength and Extended Life.

-Superior Quality Machine Tool Finish

-Strong Magnet

-High Concentricity

-Manufactured to ISO 9000 Standards

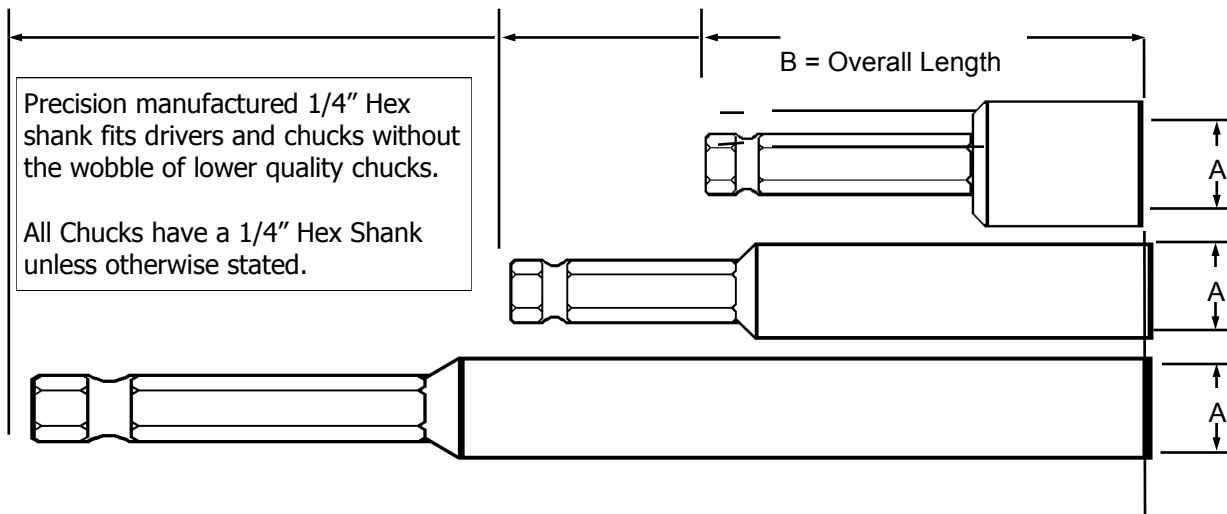

The Original Magnetic "Jiffy" Chuck

1/4" Hex Shank PRECISION MANUFACTURED

Manufactured to ISO 9000 Standards

1/4" Hex Shank has Rounded Groove for use in Power Drivers - Bit Holders - Power Screwdrivers - Drills

 <p>BULK PACK</p>	BAR CODE	HEX OPENING	LENGTH	NOSE DIA.	CROSSREFERENCE	PKG. QTY.
	10014	1/4"	1-3/4"	7/16"	MSH 1/4	1
	10001	1/4"	1-3/4"	7/16"	MSH 1/4	100 J-PK
	10003	1/4"	1-3/4"	7/16"	MSH 1/4	500 J-PK
	10044	1/4"	2-9/16"	7/16"	MSHL 1/4	1
	10005	1/4"	2-9/16"	7/16"	MSHL 1/4	100 J-PK
	10007	1/4"	2-9/16"	7/16"	MSHL 1/4	500 J-PK
	***10109	1/4"	4"	7/16"	MSHL 1/4-4	1
	10021	1/4"	4"	7/16"	MSHL 1/4-4	100 J-PK
	10066	1/4"	6"	7/16"	MSHL 1/4-6	1
	10027	1/4"	6"	7/16"	MSHL 1/4-6	100 J-PK
	10020	5/16"	1-3/4"	1/2"	MSH 5/16	1
	10009	5/16"	1-3/4"	1/2"	MSH 5/16	100 J-PK
	10011	5/16"	1-3/4"	1/2"	MSH 5/16	500 J-PK
	10048	5/16"	2-9/16"	1/2"	MSHL 5/16	1
	10013	5/16"	2-9/16"	1/2"	MSHL 5/16	100 J-PK
	10070	5/16"	4"	1/2"	MSHL 5/16-4	1
	10033	5/16"	4"	1/2"	MSHL 5/16-4	50 J-PK
	10074	5/16"	6"	1/2"	MSHL 5/16-6	1
	10035	5/16"	6"	1/2"	MSHL 5/16-6	50 J-PK
10026	3/8"	1-3/4"	9/16"	MSH 3/8	1	
10008	3/8"	1-3/4"	9/16"	MSH 3/8	100 J-PK	
10052	3/8"	2-9/16"	9/16"	MSHL 3/8	1	
10015	3/8"	2-9/16"	9/16"	MSHL 3/8	50 J-PK	
10078	3/8"	4"	9/16"	MSHL 3/8-4	1	
10037	3/8"	4"	9/16"	MSHL 3/8-4	50 J-PK	
10082	3/8"	6"	9/16"	MSHL 3/8-6	1	
10041	3/8"	6"	9/16"	MSHL 3/8-6	50 J-PK	
10032	7/16"	1-7/8"	5/8"	MSH 7/16	1	
10056	7/16"	2-9/16"	5/8"	MSHL 7/16	1	
10038	1/2"	1-7/8"	3/4"	MSH 1/2	1	
10060	1/2"	2-9/16"	3/4"	MSHL 1/2	1	

*** Note: 10109 was 10062

The Original Magnetic "Jiffy" Chuck

Hex Shank **PRECISION MANUFACTURED**

1 PC. HANG PACK

**POINT OF SALE
PACKAGING**



POS HANG PACK

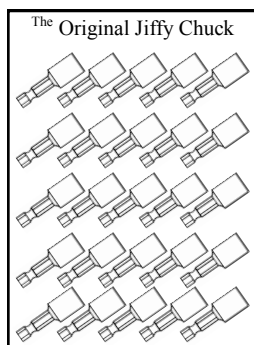

BAR CODE	HEX OPENING	LENGTH	NOSE DIA.	CROSS REFERENCE
10016	1/4"	1-3/4"	7/16"	MSH 1/4
10022	5/16"	1-3/4"	1/2"	MSH 5/16
10028	3/8"	1-3/4"	9/16"	MSH 3/8
10046	1/4"	2-9/16"	7/16"	MSHL 1/4
10050	5/16"	2-9/16"	1/2"	MSHL 5/16
10054	3/8"	2-9/16"	9/16"	MSHL 3/8
10058	7/16"	2-9/16"	5/8"	MSHL 7/16
10061	1/2"	2-9/16"	3/4"	MSHL 1/2
10064	1/4"	4"	7/16"	MSHL 1/4-4
10068	1/4"	6"	7/16"	MSHL 1/4-6
10072	5/16"	4"	1/2"	MSHL 5/16-4
10076	5/16"	6"	1/2"	MSHL 5/16-6
10080	3/8"	4"	9/16"	MSHL 3/8-4
10084	3/8"	6"	9/16"	MSHL 3/8-6

MULTI-PACK CONTRACTOR JIFFY HANG PACK

BAR CODE	HEX OPENING	LENGTH	NOSE DIA	PCS	CROSS REFERENCE
10017	1/4"	1-3/4"	7/16"	3	MSH 1/4
10023	5/16"	1-3/4"	1/2"	3	MSH 5/16
10029	3/8"	1-3/4"	9/16"	3	MSH 3/8
10045	1/4"	2-9/16"	7/16"	2	MSHL 1/4
10049	5/16"	2-9/16"	1/2"	2	MSHL 5/16

25 PC DISPLAY

BAR CODE	HEX OPENING	LENGTH	NOSE DIA.	CROSS REFERENCE
10018	1/4"	1-3/4"	7/16"	MSH 1/4
10024	5/16"	1-3/4"	1/2"	MSH 5/16
10030	3/8"	1-3/4"	9/16"	MSH 3/8

100 PIECE COUNTER BOWLS

10019	1/4"	1-3/4"	7/16"	MSH 1/4
10025	5/16"	1-3/4"	1/2"	MSH 5/16
10031	3/8"	1-3/4"	9/16"	MSH 3/8
10047	1/4"	2-9/16"	7/16"	MSHL 1/4
10051	5/16"	2-9/16"	1/2"	MSHL 5/16
10055	3/8"	2-9/16"	9/16"	MSHL 3/8

The Original Magnetic JIFFY GRIP Chuck For IMPACT Drills & Standard Drills

The **lobular** design reduces stress and significantly increases strength.

The new **stronger** magnet holds ferrous screws better, and provides exceptional performance.

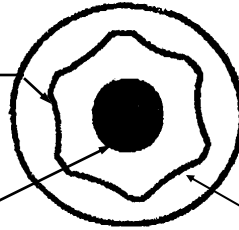

Precision Manufactured to ISO 9000 Standards-Industrial Quality

The **lobular** socket design drives screws on the flats, preventing rounding. Also helps protect the finished screw heads.



POINT OF SALE PACKAGING

1 PC. POS HANG PACK

BAR CODE	HEX OPENING	LENGTH	NOSE DIA.	CROSS REFERENCE
10222	1/4"	1-3/4"	7/16"	MSH 1/4
10228	5/16"	1-3/4"	1/2"	MSH 5/16
10232	3/8"	1-3/4"	9/16"	MSH 3/8
10053	1/4", 5/16", & 3/8"	1-3/4"	Multi Pack	

1/4x2-9/16, 5/16x2-9/16, 3/8x2-9/16 available by request. Please contact factory.

BULK PACK

BAR CODE	HEX OPENING	LENGTH	NOSE DIA.	CROSS REFERENCE
10220	1/4"	1-3/4"	7/16"	MSH 1/4
10240	1/4"	2-9/16"	7/16"	MSHL 1/4
10226	5/16"	1-3/4"	1/2"	MSH 5/16
10244	5/16"	2-9/16"	1/2"	MSHL 5/16

Precision Manufactured HEX MAGNETIC Jiffy Chucks

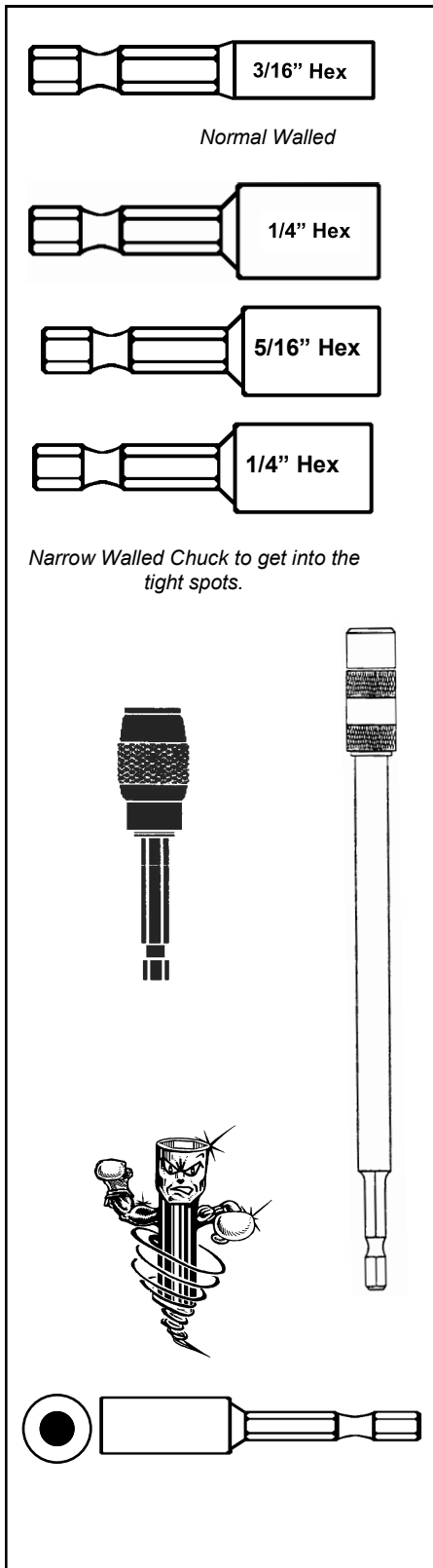

Bar Code Number	Item Description	Size A x B	Package Quantity
10040	3/16" x 2-9/16" 100-B		1 Bulk
10069	1/4" x 8"		1 Bulk
10101	1/4" x 8"		1 POS
10071	1/4" x 12"		1 Bulk
10073	5/16" x 8"		1 Bulk
10075	5/16" x 12"		1 Bulk
10036	7/16" x 6"		1 Bulk
REDUCED HEAD			
10106	1/4 x 1-5/8"		1 Bulk
10108	1/4" x 1-5/8"		1 POS
TAPERED HEAD			
10102	1/4 x 1-5/8"		1 Bulk
10104	1/4 x 1-5/8"		1 POS

JIFFY QUICK CHANGE CHUCK ADAPTERS

10575	Jiffy Quick Change Chuck Adapter 1/4 x 2" with Magnet & Ball Lock for use with 1/4" Hex Insert Bits & Power Bits.	1 POS
10576	Jiffy Quick Change Chuck Adapter 1/4 x 2" with Magnet & Ball Lock for 25 Pc Counter Bowl use with 1/4" Hex Insert Bits & Power Bits.	1 POS
10043	Jiffy Quick Change Chuck Adapter 1/4 x 2" with Magnet & Ball Lock for use with 1/4" Hex Insert Bits & Power Bits.	100 J-PK

Jiffy Quick Change Power Extension

**1/4" Hex Shank with Torque Groove.
Quick Change Snap Chuck Holds 1/4 Hex Insert & Power Bits**

10572	Jiffy Quick Change Extension - 6"	1 POS
10574	Jiffy Quick Change Extension - 10"	1 POS

Hanger Bolt Drivers

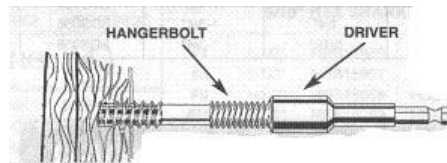

10292	Jiffy Hanger Bolt Driver - 5/16-18 x 2-9/16"	1 Bulk
10286	Jiffy Hanger Bolt Driver - 3/8-16 x 1-3/4"	1 Bulk

The Original Magnetic Jiffy Chuck Multi-Piece Kits

Bar Code	Item Description	Display Qty
10114	<p style="text-align: center;">Kit Part # DC10</p> <p>Contains an assortment of 9 Original Jiffy Magnetic Chucks in a plastic storage box - Contains 1 ea. Of 1/4"x1-3/4", 1/4"x2-9/16", 1/4"x4", 1/4"x6", 5/16"x1-3/4", 5/16"x2-9/16", 5/16"x4", 5/16"x6", 3/8"x1-3/4", and a quick change adapter.</p>	1 Kit
10113	<p style="text-align: center;">Kit Part # DC9</p> <p>Contains an assortment of 9 Original Jiffy Magnetic Chucks in a plastic storage box - Contains 1 ea. Of 1/4"x1-3/4", 1/4"x2-9/16", 1/4"x4", 1/4"x6", 5/16"x1-3/4", 5/16"x2-9/16", 5/16"x4", 5/16"x6", 3/8"x1-3/4"</p>	1 Kit
10120	<p style="text-align: center;">Kit Part # DC-4XL</p> <p>Contains an assortment of Original Jiffy Magnetic Chucks in a plastic storage box - Contains 1 ea. Of 1/4" x 6", 5/16" x 6", 3/8" x 6", 7/16" x 6", and a quick change adapter.</p>	1 Kit
10122	<p style="text-align: center;">Kit Part # DC-5L</p> <p>Contains an assortment of Original Jiffy Magnetic Chucks in a plastic storage box - Contains 1 ea. Of 1/4" x 2-9/16", 5/16" x 2-9/16", 3/8" x 2-9/16", 7/16" x 2-9/16", 1/2" x 2-9/16", and a quick change adapter.</p>	1 Kit
10178	<p style="text-align: center;">Kit Part # DC-6</p> <p style="text-align: center;">Contains 1 ea-1/4", 5/16", 3/8" x 1-3/4', 1 ea. 7/16", 9/16", 1/2" x 1-7/8"</p>	1 Kit
12652	<p style="text-align: center;">Kit Part # DC-3S</p> <p style="text-align: center;">Contains 1 ea. 1/4", 5/16", 3/8" short Jiffy Chucks</p>	1 Kit
12654	<p style="text-align: center;">Kit Part# DC-3L</p> <p style="text-align: center;">Contains 1 ea. 1/4", 5/16", 3/8" Long Jiffy Chucks</p>	1 Kit
12656	<p style="text-align: center;">Kit Part# DC-MBH</p> <p style="text-align: center;">Contains 1- 1/4" Mag. Bit Holder, 1 ea- # 1,2,3 Phillips Insert Bit, 1 ea- # 4, 6, 8 Slotted Insert Bit</p>	1 Kit

ALSO SEE PAGE 83 FOR MORE DC-10 INFORMATION



“Jiffy” Magnetic Nutdrivers & Screwdrivers

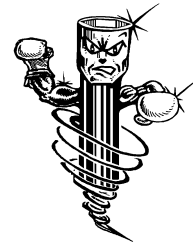
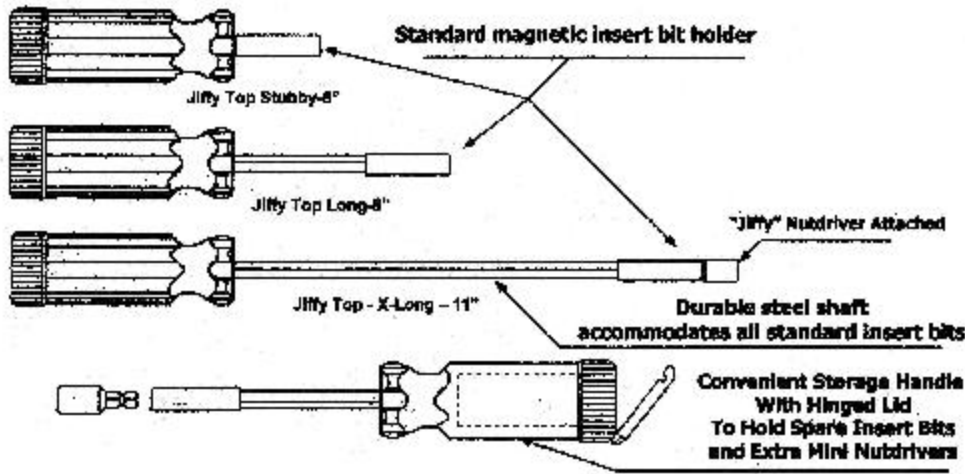

Magnetic Screwdrivers (No bits included)

Bar Code Number	Item Description	Size	Length	Pkg. Qty.
08002	Jiffy Top Stubby		3"	1 Bulk
08004	Jiffy Top Stubby W/ Storage		5"	1 Bulk
08008	Jiffy Top Long W/ Storage		8"	1 Bulk
08028	Jiffy TopX-Long W/ Storage		11"	1 Bulk

Magnetic Screwdrivers with Hex Magnetic Jiffy Chucks

Bar Code Number	Item Description	Size	Length	Pkg. Qty.
08357	Jiffy Top Stubby	w 1/4 & 5/16 Chuck	5"	1
08365	Jiffy Top Long	w 1/4 & 5/16 Chuck	8"	1
08373	Jiffy Top X-Long	w 1/4 & 5/16 Chuck	11"	1

Magnetic Screwdrivers with Insert Bits

Bar Code Number	Item Description	Size	Length	Pkg. Qty.
08064	Jiffy Top Stubby	W/ # 1, 2, 2R, 3 Phillips Bits	5"	1
08068	Jiffy Top Long	W/ # 1, 2, 2R, 3 Phillips Bits	8"	1
08084	Jiffy Top X-Long	W/ # 1, 2, 2R, 3 Phillips Bits	11"	1
08097	Jiffy Top Stubby	1/8, 5/32, & 3/16 Hex Bits	5"	1
08098	Jiffy Top Long	1/8, 5/32, & 3/16 Hex Bits	8"	1
08099	Jiffy Top X-Long	1/8, 5/32, & 3/16 Hex Bits	11"	1

NOTE: Please use bar code numbers to speed your order processing.

“Jiffy” Magnetic Bit Holders

1/4” Hex Shank - For use with 1/4” Insert Bits

Check It Out! Quality NO Other Bit Holders Can Match!

1/4” Hex Shank with Power Groove. Cold Formed for Harder, Denser, more Durable Shank!

Tool Grade Steel for Superior Quality and Corrosion Resistance. Specifications Guaranteed to +/- .001”



A = Hex Opening Size

Magnetic & C-Ring Positive Locking Retainer Clip for Extra Holding Power!



POWERFUL MAGNETS!

Jiffy Magnetic Bit Holders use Large Powerful Magnets that give HOLDING POWER!

Insert Bit Holder - 7/16” Body Dia., 7/16” Nose dia.

10312	Jiffy C-Ring Bit Holder - 6”	1 Bulk
--------------	------------------------------	--------



10370	Jiffy Telescoping Screw Guide	1 POS
--------------	-------------------------------	-------

Supports Long Screws For Easier Starting & Driving



“Jiffy” Hex Drive Extensions

1/4” Hex Drive - Male Square

Bar Code Number	Item Description	Length Inches	Male Square	Package Quantity
09602	1/4” Hex Drive Extension	2”	1/4”	1 POS
09604	1/4” Hex Drive Extension	3”	1/4”	1 POS

Durable Pin Lock

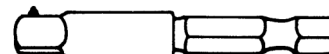

1/4" Hex Shank

NOTE: Insert Bits are 1" in length unless otherwise stated

"Jiffy" Phillips Tip Insert Bits

1/4" Hex Shank x 1" Long - has Retaining Groove for use in Bit Holders and Screwdrivers

Bar Code Number	Item Description	Size	Package Quantity
10402	Phillips Insert Bit- #1		1 Bulk
10380	Phillips Insert Bit- #1		10 J-Pack
10413	Phillips Insert Bit - #1		25 J-Pack
10406	Phillips Insert Bit - #2		1 Bulk
10381	Phillips Insert Bit- # 2		10 J-Pack
09564	Phillips Insert Bit - #2		25 Display
10472	Phillips Insert Bit - #2		25 J-Pack
10473	Phillips Insert Bit - #2		100 J-Pack
10407	Phillips Insert Bit - #2		100 CB
10408	Phillips Insert Bit # 2 Reduced Diameter		1 Bulk
09566	Phillips Insert Bit - #2 Reduced Diameter		25 Display
10374	Phillips Insert Bit - #2 Reduced Diameter		25 J-Pack
10375	Phillips Insert Bit - #2 Reduced Diameter		100 J-Pack
10410	Phillips Insert Bit - #3		1 Bulk
10371	Phillips Insert Bit - #3		25 J-Pack
10372	Phillips Insert Bit - #3		100 J-Pack

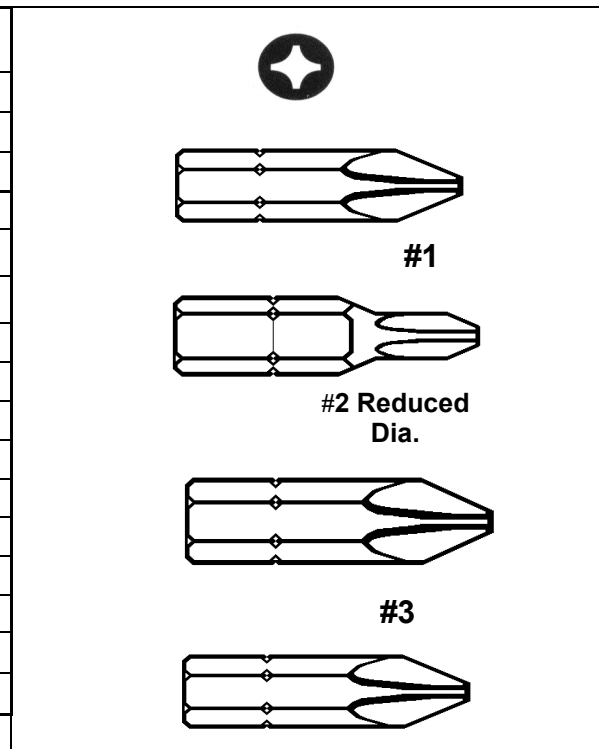

1/4" Hex Shank - has Retaining Groove for use in Bit Holders and Screwdrivers

10373	Phillips Insert Bit - #2 x 1-1/2" Long	3 J-Pack
10412	Phillips Insert Bit - #2- 1-1/2" Long	1 Bulk

"Jiffy" Phillips Tip Insert Bits ACR Style

1/4" Hex Shank x 1" Long - has Retaining Groove for use in Bit Holders and Screwdrivers

Bar Code Number	Item Description	Size	Package Quantity
10376	Phillips ACR Bit #1		10 J-Pack
10377	Phillips ACR Bit #2		10 J-Pack
10378	Phillips ACR Bit #2 Reduced Dia.		10 J-Pack
10379	#3 Phillips ACR Bit		10 J-Pack

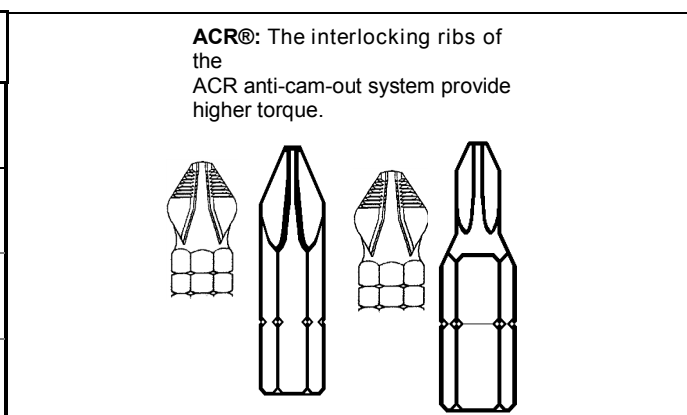

NOTE: Insert Bits are 1" in length unless otherwise stated.

1/4" Hex Shank

“Jiffy” Slotted (Flat Tip) Insert Bits

1/4" Hex Shank x 1" Long - has Retaining Groove for use in Bit Holders and Screwdrivers

Bar Code Number	Item Description	Package Quantity
10383	#8F-10R Slotted Insert Bit	10 J-Pack
10384	#10F-12R Slotted Insert Bit	10 J-Pack
10385	#12F-14R Slotted Insert Bit	10 J-Pack

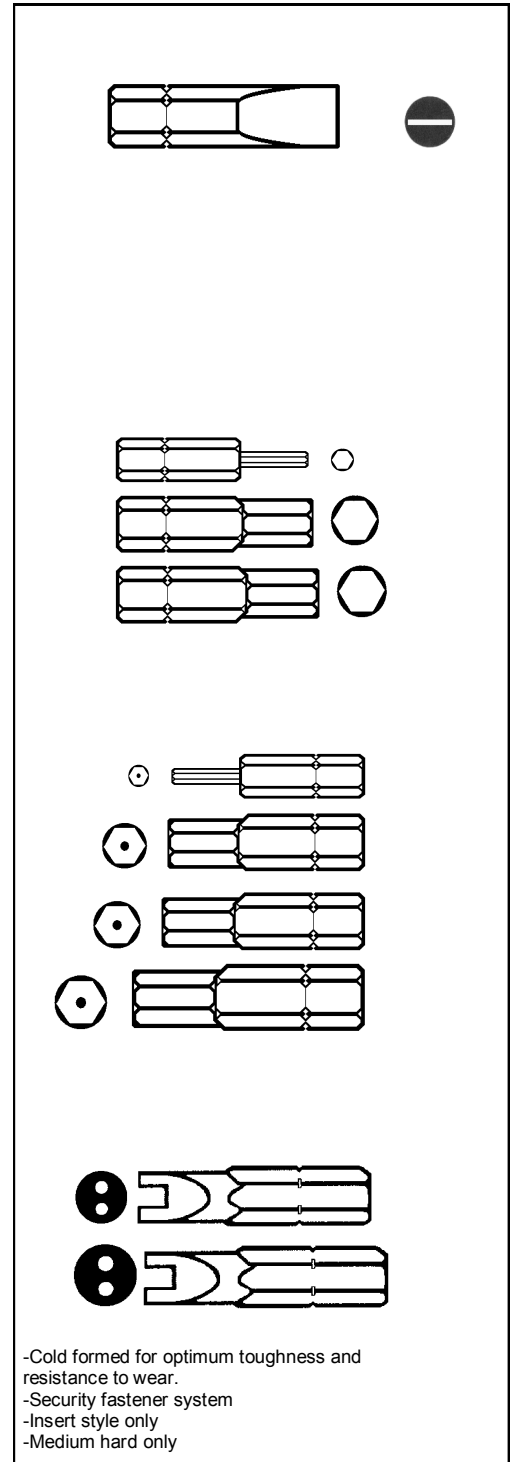

“Jiffy” Hex Drive Insert Bits

1/4" Hex Shank x 1" Long - has Retaining Groove for use in Bit Holders and Screwdrivers

Bar Code Number	Item Description	Size	Package Quantity
09415	Jiffy Hex Drive Insert Bit - 1/8"		10 J-Pack
10386	Jiffy Hex Drive Insert Bit - 5/32"		10 J-Pack
10387	Jiffy Hex Drive Insert Bit - 3/16"		10 J-Pack
10388	Jiffy Hex Drive Insert Bit - 1/4"		10 J-Pack

“Jiffy” Tamper Resistant Hex Insert Bits

1/4" Hex Shank x 1" Long - has Retaining Groove for use in Bit Holders and Screwdrivers

10389	Jiffy Tamper Resist. Hex Insert Bit - 3/32"	10 J-Pack
10390	Jiffy Tamper Resist. Hex Insert Bit - 1/8"	10 J-Pack
10391	Jiffy Tamper Resist. Hex Insert Bit - 5/32"	10 J-Pack
10392	Jiffy Tamper Resist. Hex Insert Bit - 3/16"	10 J-Pack
10393	Jiffy Tamper Resist. Hex Insert Bit - 7/32"	10 J-Pack
10394	Jiffy Tamper Resist. Hex Insert Bit - 5/16"	10 J-Pack

“Jiffy” Spanner Insert Bits

1/4" Hex Shank x 1" Long - has Retaining Groove for use in Bit Holders and Screwdrivers

09401	Jiffy Spanner Insert Bit - #6	10 J-PK
09403	Jiffy Spanner Insert Bit - #8	10 J-PK
09405	Jiffy Spanner Insert Bit - #10	10 J-PK
09407	Jiffy Spanner Insert Bit - #12	10 J-PK
09409	Jiffy Spanner Insert Bit - #14	10 J-PK
09413	Jiffy Spanner Insert Bit—#14 x 1-1/2" 5/16" Drive	10 J-PK

-Cold formed for optimum toughness and resistance to wear.
 -Security fastener system
 -Insert style only
 -Medium hard only

NOTE: Insert Bits are 1" in length unless otherwise stated

"Jiffy" Star Insert Bits

1/4" Hex Shank x 1" Long - has Retaining Groove for use in Bit Holders and Screwdrivers

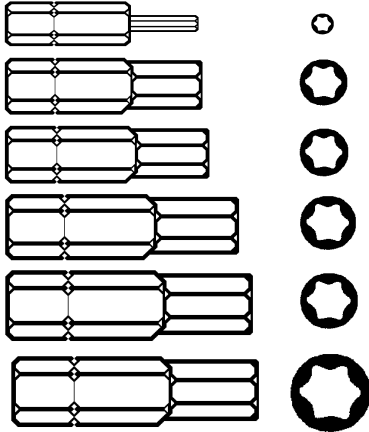

Bar Code Number	Item Description	Size	Package Quantity
10395	Jiffy Star Insert Bit - # T7		10 J-PK
10169	Jiffy Star Insert Bit - # T8		10 J-PK
10170	Jiffy Star Insert Bit - # T9		10 J-PK
10396	Jiffy Star Insert Bit - # T10		10 J-PK
10397	Jiffy Star Insert Bit - # T15		10 J-PK
10398	Jiffy Star Insert Bit - # T20		10 J-PK
10399	Jiffy Star Insert Bit - # T25		10 J-PK
10130	Jiffy Star Insert Bit - # T25		100 J-PK
10131	Jiffy Star Insert Bit - # T27		10 J-PK
10132	Jiffy Star Insert Bit - # T30		10 J-PK
10133	Jiffy Star Insert Bit - # T40		10 J-PK
10134	Jiffy Star Insert Bit 5/16" Hex # 5T45		10 J-PK
10135	Jiffy Star Insert Bit 5/16" Hex # 5T55		10 J-PK

"Jiffy" Tamper Resistant Star Insert Bits

1/4" Hex Shank

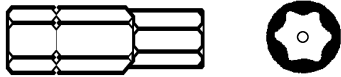

Bar Code Number	Item Description	Size	Package Quantity
10136	Jiffy Tamper Resistant Star Insert Bit - # TR10		10 J-PK
10137	Jiffy Tamper Resistant Star Insert Bit - # TR27		10 J-PK
10138	Jiffy Tamper Resistant Star Insert Bit - # TR30		10 J-PK

"Jiffy" Hex Insert Bit Kits



Bar Code Number	Item Description	Size	Pkg. Qty.
09550	Jiffy 30 Piece Bit Kit includes ... Jiffy Top Storage Handle Magnetic Screwdriver Slotted Insert Bits: 0-1, 3-4, 5-6, 8-10, 12 Phillips Insert Bits: #0, #1, #2, #3 Hex Insert Bits: 5/64, 3/32, 1/8, 9/64 Square Insert Bits: #0, #1, #2, #3 Posidriv® Insert Bits: #1, #2 Torx Insert Bits: T10, T15, T20, T25, T30, T40 1/4" Socket Adapter, Plastic Carrying Case		1 Set
09552	Jiffy 30 Piece Security Bit Kit includes ... Jiffy Top Storage Handle Magnetic Screwdriver 1/4" Bit Holder, 1/4" Square & 1/4" Hex Male Adapter Tamper Resistant Phillips Insert Bit: #2 Tamper Resistant Spanner Insert Bits: #4, #6, #8, #10, #12, #14 Tamper Resistant Hex Insert Bits: 3/32, 1/8, 9/64, 5/32, 3/16, 7/32, 1/4, 2.5mm, 3mm, 5mm Tamper Resistant Torx Insert Bits: T8, T9, T10, T15, T20, T25, T27, T30, T40 Plastic Carrying Case		1 Set

“Jiffy” Drive Recess Square Insert Bits

1/4” Hex Shank X 1” Long - has Retaining Groove for use in Bit Holders and Screwdrivers

-Cold formed for optimum toughness and resistance to wear

-Popular in mobile homes, recreation vehicles, and some furniture

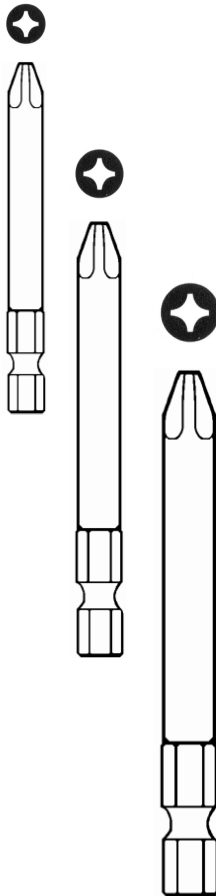

Bar Code Number	Item Description	Size	Package Quantity
10380	Jiffy Square Drive Recess Bit - #1		10 J-Pack
10381	Jiffy Square Drive Recess Bit - #2		10 J-Pack
10382	Jiffy Square Drive Recess Bit - #3		10 J-Pack

“Jiffy” Phillips Tip Power Bits

1/4” Hex Shank x 1-15/16” Long - Has Torque Groove for Use in Power Drivers and Drills

Bar Code Number	Item Description	Size	Package Quantity
10123	Jiffy Phillips Power Bit - #1 Phillips x 1-15/16”-		3 J-PK POS
10124	Jiffy Phillips Power Bit - #1 Phillips x 1-15/16”-		10 J-PK POS
10125	Jiffy Phillips Power Bit - #1 Phillips x 1-15/16”-		100 J-Pack
10480	Jiffy Phillips Power Bit - #2 Phillips x 1-15/16” - 200-P2		1 Bulk
10126	Jiffy Phillips Power Bit - #2 Phillips x 1-15/16”		3 J-PK POS
10127	Jiffy Phillips Power Bit - #2 Phillips x 1-15/16”		10 J-PK POS
10482	Jiffy Phillips Power Bit - #2 Phillips x 1-15/16”- 200-P2-D		25 Display
10483	Jiffy Phillips Power Bit - #2 Phillips x 1-15/16”- 200-P2		100 CB
10128	Jiffy Phillips Power Bit - #2 Phillips x 1-15/16”		100 J-Pack
10484	Jiffy Phillips Power Bit - #3 Phillips x 1-15/16” - 200-P3		1 Bulk
10129	Jiffy Phillips Power Bit - #3 Phillips x 1-15/16”		3 J-PK POS
10139	Jiffy Phillips Power Bit - #3 Phillips x 1-15/16”		10 J-PK POS
10140	Jiffy Phillips Power Bit - #3 Phillips x 1-15/16”		100 J-Pack
10488	Jiffy Phillips Power Bit - #1 Phillips x 2-3/4” - 275-P1		1 Bulk
10141	Jiffy Phillips Power Bit - #1 Phillips x 2-3/4”		3 J-PK POS
10142	Jiffy Phillips Power Bit - #1 Phillips x 2-3/4”		10 J-PK POS
10143	Jiffy Phillips Power Bit - #1 Phillips x 2-3/4”		100 J-Pack
10490	Jiffy Phillips Power Bit - #2 Phillips x 2-3/4” - 275-P2		1 Bulk
10144	Jiffy Phillips Power Bit - #2 Phillips x 2-3/4”		3 J-PK POS
10145	Jiffy Phillips Power Bit - #2 Phillips x 2-3/4”		10 J-PK POS
10146	Jiffy Phillips Power Bit - #2 Phillips x 2-3/4”		100 J-Pack
10492	Jiffy Phillips Power Bit - #3 Phillips x 2-3/4” - 275-P3		1 Bulk
10147	Jiffy Phillips Power Bit - #3 Phillips x 2-3/4”		3 J-PK POS
10148	Jiffy Phillips Power Bit - #3 Phillips x 2-3/4”		10 J-PK POS
10149	Jiffy Phillips Power Bit - #3 Phillips x 2-3/4”		100 J-Pack
10150	Jiffy Phillips Power Bit - #1 Phillips x 3-1/2”		3 J-PK POS
10151	Jiffy Phillips Power Bit - #2 Phillips x 3-1/2”		3 J-PK POS
10152	Jiffy Phillips Power Bit - #3 Phillips x 3-1/2”		3 J-PK POS
10500	Jiffy Phillips Power Bit - #1 Phillips x 6”- 600-P1		1 Bulk
10502	Jiffy Phillips Power Bit - #2 Phillips x 6”- 600-P2		1 Bulk
10504	Jiffy Phillips Power Bit - #3 Phillips x 6”- 600-P3		1 Bulk

“Jiffy” Square Drive Recess Power Bits

1/4” Hex Shank x 1-15/16” Long - Has Torque Groove for Use in Power Drivers and Drills

Bar Code Number	Item Description	Size	Package Quantity
10156	Jiffy Square Drive Power Bit #1 x 1-15/16”		3 J-PK POS
10157	Jiffy Square Drive Power Bit #2 x 1-15/16”		3 J-PK POS
10158	Jiffy Square Drive Power Bit #3 x 1-15/16”		3 J-PK POS
10159	Jiffy Square Drive Power Bit #1 x 2-3/4”		3 J-PK POS
10160	Jiffy Square Drive Power Bit #2 x 2-3/4”		3 J-PK POS
10171	Jiffy Square Drive Power Bit #2 x 2-3/4”		10 J-PK POS
10161	Jiffy Square Drive Power Bit #3 x 2-3/4”		3 J-PK POS

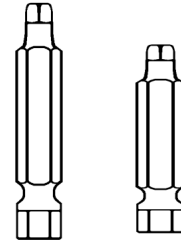

“Jiffy” Star Tip Power Bits

1/4” Hex Shank x 1-15/16” Long - Has Torque Groove for Use in Power Drivers and Drills

Bar Code Number	Item Description	Size	Package Quantity
10162	Jiffy Star Power Bit #T10		3 J-PK POS
10163	Jiffy Star Power Bit #T 15		3 J-PK POS
16164	Jiffy Star Power Bit #T 20		3 J-PK POS
10165	Jiffy Star Power Bit #T 25		3 J-PK POS
10166	Jiffy Star Power Bit #T 30		3 J-PK POS

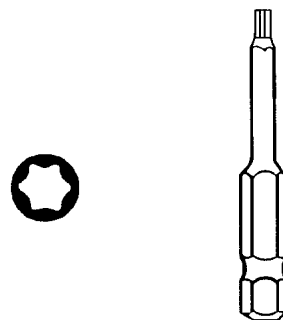

Clutch G Style Power Bits

1/4” Hex Shank x 1-15/16” Long - Has Torque Groove for Use in Power Drivers and Drills

10167	Clutch G Power Bit- 5/32” x 1-15/16”	3 J-PK POS
-------	--------------------------------------	------------

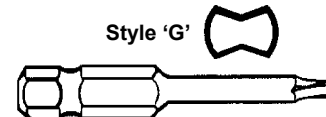

“Jiffy” Power Bits for Posidriv® Fasteners

1/4” Hex Shank x 1-15/16” Long - Has Torque Groove for Use in Power Drivers and Drills

Bar Code Number	Item Description	Package Quantity
10172	Power Bit - Posidriv ® #1 Tip x 1-15/16”	3 J-PK POS
10173	Power Bit - Posidriv ® #2 Tip x 1-15/16”	3 J-PK POS
10174	Power Bit - Posidriv ® #3 Tip x 1-15/16”	3 J-PK POS

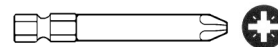

“Jiffy” Slotted (Flat Tip) Power Bits

1/4” Hex Shank x 1-15/16” Long - has Torque Groove for use in Power Drivers and Drills

Bar Code Number	Item Description	Size	Package Quantity
10175	Jiffy Slotted Power Bit - # 4F - 5R Slotted - 20-4S		3 J-PK POS
10176	Jiffy Slotted Power Bit - # 5F - 6R Slotted - 20-6S		3 J-PK POS
10177	Jiffy Slotted Power Bit - # 6F - 7R Slotted - 20-7S		3 J-PK POS
10179	Jiffy Slotted Power Bit - # 8F-10R Slotted - 20-8S		3 J-PK POS
10180	Jiffy Slotted Power Bit-# 12F-14R Slotted -20-10S		3 J-PK POS

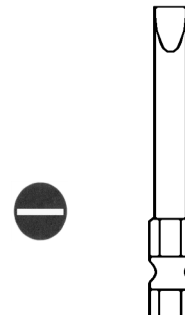

“Jiffy” Air Conditioning & Refrigeration Tools

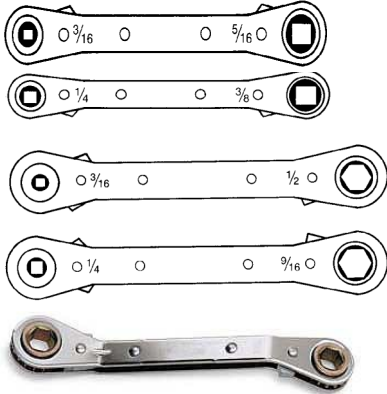

Bar Code Number	Item Description	Size	Package Quantity
10556	Jiffy Refrigeration Ratcheting Tool - 5-7/32" Long - 3/8" & 5/16" Square Drive and 1/4" & 3/16" Square Drive Combos		1 POS
10554	Jiffy Refrigeration Ratcheting Tool - 7" Long - 1/4" & 3/16" Sq. Drive and 9/16" & 1/2" Hex Drive Combos		1 POS
10555	Jiffy Offset Refrigeration Ratcheting Tool - 5-7/32" Long- 3/8" & 5/16" Square Drive and 1/4" & 3/16" Square Drive Combos		1 POS

“Jiffy” Refrigeration Tool Hex Key Bits



1/4" Hex Shank

10550	Jiffy HVACR Hex Bit - 3/16" Hex	1 POS
10569	Jiffy HVACR Hex Bit - 3/16" Hex	100 CB
10551	Jiffy HVACR Hex Bit - 5/16" Hex	1 POS
10573	Jiffy HVACR Hex Bit - 5/16" Hex	100 CB
10549	Jiffy Hex Bit Set- 1 ea. 3/16" & 5/16"	1 POS

“Jiffy” Refrigeration Service Tool Kits

BAR CODE	ITEM DESCRIPTION
10557	REFRIGERATION SERVICE TOOL KIT KIT INCLUDES: 5-7/32" LONG STRAIGHT COMBO-END SQUARE DRIVE 3/16"-5/16", 1/4"-3/16" 7" LONG COMBO END SQUARE DRIVE 3/16"-5/16", 1-4"-3/16" 3/16" HEX REFRIGERATION INSERT BIT 5/16" HEX REFRIGERATION INSERT BIT
10567	JIFFY 2 PC. REFRIGERATION SERVICE KIT - (1 ea 10550, 10556)



REFRIGERATION SERVICE TOOLS ASSORTMENT

QUANTITY	BAR-CODE #	DESCRIPTION
6	10557	4 PIECE SERVICE TOOL KITS - Includes #10554, #10556, #10550, #10551
6	10567	2 PIECE SERVICE TOOL KITS - Includes #10556, #10550
6	10556	COMBO RATCHET TOOL - Includes: 5-7/32 Long-Sq Drive 3/8 & 5/16 & 1/4 & 3/16
6	10554	COMBO RATCHET TOOL - Includes: 7 Long Hex Drive 1/4 & 3/16 & 9/16 & 1/2
6	10555	OFFSET COMBO RATCHET TOOL - Includes: 5-7/32 Sq Drive 3/8 & 5/16 & 1/4 & 3/16
12	10550	3/16 REFRIGERATION HEX INSERT BIT
6	10551	5/16 REFRIGERATION HEX INSERT BIT
48	10510	COMPLETE PLANOGRAM COMES COMPLETE WITH DISPLAY BOARD AND HOOKS AT NO CHARGE



Go DIGITAL!

The next stage in digital HVAC evolution

AK-900 DIGI-COOL Refrigeration Analyzer



- Advanced LCD screen
- Durable design with bar graph display
- Accuracy within +/- 0.5%
- 30+ common refrigeration profiles on-board
- Superheat & supercool accessible on single screen
- User-friendly real time updates
- Charge A/C systems faster
- Comes with a "Reeferman Red" boot

ACCESSORIES AVAILABLE FOR DRSA 1100, 1200, 1600

TB-1120 Bar Clamp
TS-1120 Scissor Clamp



SHOOK DC 10 CHUCK KIT

THE RIGHT TOOL FOR THE JOB



BAR CODE 10114 Kit Part # DC10

Contains an assortment of 9 Original Jiffy Magnetic Chucks in a plastic storage box.

Contains 1 ea.:

1/4"x1-3/4"	1/4"x2-9/16"	1/4"x4"	1/4"x6"
5/16"x1-3/4"	5/16"x2-9/16"	5/16"x4"	5/16"x6"
3/8"x1-3/4"			

Jiffy quick change adapter.

Section 2

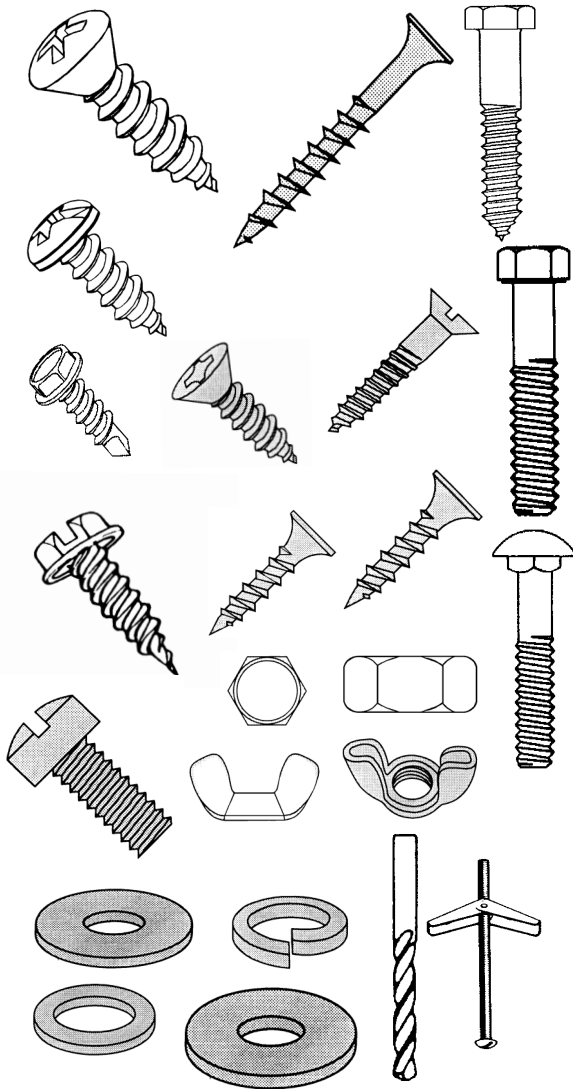

- Jiffy Point Screws
- Driltip Screws
- Painted Speed Screws
- Painted Register Screws
- Sheet Metal Screws
- Framing Screws
- Drywall Screws
- Deck Screws
- Wood Screws
- Concrete Screws
- Machine Screws
- Hex Cap Screws
- Carriage Bolts
- Lag Screws
- Hex Nuts
- Wing Nuts
- Coupling Nuts
- Flat Washers
- Lock Washers
- Fender Washers
- Rivets
- Drill Bits
- Drill Bit Indexes
- Masonry Bits
- Spade Wood Bits
- Anchors
- Anchor Kits
- Wedge Anchors
- Sleeve Anchors
- Drop-In Anchors
- Stove Bolts
- Threaded Rod
- Fastener Assort.
- Rod Hanger Fasteners

Product Packaging Key

POS - Individually packaged for POS (boxed, bagged or carded) for hanging display

CB - Counter Bowl (Plastic)

D - Multiple Display Card

HP - Hang Pack - (Clear Plastic Hang Box or Bag)

PL - Plastic Box or Plastic Tub

PB - Plastic Bucket with Handle & Lid

C - Chipboard Box

B - Bulk Packaged - (Loose - Bagged - Boxed)

JP - Jiffy Pail

All Bulk Packaging includes quantity, product description and barcode number

Custom Packaging and Labeling Available

“Jiffy Point” Screws

Zinc Plated

Full 1/4” (No. 8 & No. 10) Indented
Slotted Hex Washer Head.

*Unique Hard Point ...
Tapered, Sharp & Heat Treated
for Maximum Penetration!*

Undercut Washer Seats
Flush and Holds Tight

*DEEP Threads...
Cut and Hold Tight!*

ALSO AVAILABLE WITH A
BONDED SEALING WASHER

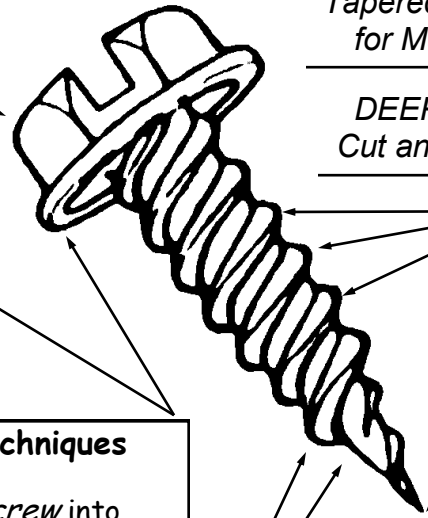

Driving Tips and Techniques

- Place “Jiffy Point” Screw into The *Original Magnetic Jiffy Chuck*.
- Press point of screw firmly against material to be drilled and fastened.
- Depress electric drill trigger to begin drilling.
- Once the screw threads engage the material, feather the drill trigger to tighten the “Jiffy Point” Screw.
- Driving technique may vary for lower speed, cordless drills or drills and screw guns with adjustable torque or automatic clutch features.

Combination Twin Thread ...
Single starting thread machined to the **hard point** of the screw.
Second thread above the point for **faster penetration**

The “Jiffy Point” screw. The perfect screw for easy 1-step fastening of a wide range of materials.
Layered light gauge galvanized sheet metal
Heavy gauge sheet metal
Laminates
Composition board
Plastics
Plywood
Hardwoods
Construction lumber

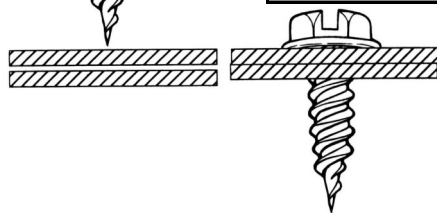
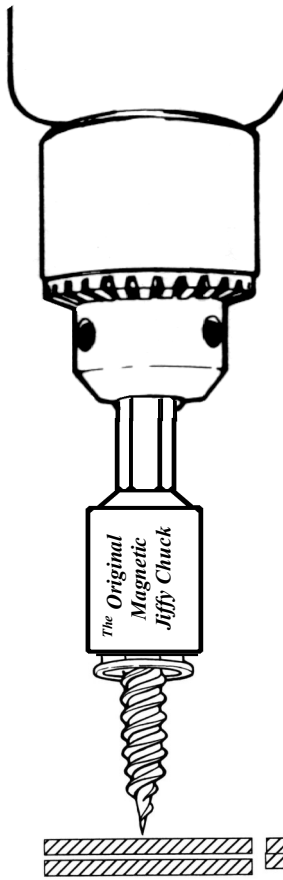

**Note: Each production run is tested for drill time.

Test results available on request

“Jiffy Point” Screws offer excellent performance using an electric drill, screw gun, or driver.



Be sure to read about Shook's
Quality Control Testing Procedures
in the Appendix

"Jiffy Point" Screws

1/4" Indented Hex Washer Head - Slotted, Hardened, Undercut Zinc Plated Sheet Metal Screws

Bar Code Number	Item Description	Size	Package Quantity
10601	Jiffy Point Xtra Sharp Screw - #6 x 3/8"		25 HP
10602	Jiffy Point Xtra Sharp Screw - #6 x 3/8"		100 Box
10604	Jiffy Point Xtra Sharp Screw - #6 x 3/8"		100 HP
10606	Jiffy Point Xtra Sharp Screw - #6 x 3/8"		500 PI Box
10608	Jiffy Point Xtra Sharp Screw - #6 x 3/8"		1000 PI Box
10600	Jiffy Point Xtra Sharp Screw - #6 x 3/8"		20 M Bulk
10603	Jiffy Point Xtra Sharp Screw - #6 x 3/8"		20 M Jiffy Pail
11001	Jiffy Point Xtra Sharp Screw - #7x1/2" - 821-R		25 HP
11002	Jiffy Point Xtra Sharp Screw - #7x1/2" - 821-1		100 Box
11003	Jiffy Point Xtra Sharp Screw - #7x1/2" - 821-1P		100 HP
11004	Jiffy Point Xtra Sharp Screw - #7x1/2" - 821-5		500 PI Box
11006	Jiffy Point Xtra Sharp Screw - #7x1/2" - 821-E		1000 PI Box
30900	Jiffy Point Xtra Sharp Screw - #7x1/2"		1000 PI Jar
11007	Jiffy Point Xtra Sharp Screw - #7x1/2" Includes 1 Jiffy Chuck		1000 PI Box
11008	Jiffy Point Xtra Sharp Screw - #7x1/2" - 821-B		5M PI Bucket
30761	Jiffy Point Xtra Sharp Screw - #7x1/2" -		7500 PI Bkt
11000	Jiffy Point Xtra Sharp Screw - #7x1/2" - 821		15M Bulk
11009	Jiffy Point Xtra Sharp Screw - #7x1/2"		15M Jiffy Pail
11011	Jiffy Point Xtra Sharp Screw - #8x1/2" - 822-R		25 HP
11012	Jiffy Point Xtra Sharp Screw - #8x1/2" - 822-1		100 Box
11013	Jiffy Point Xtra Sharp Screw - #8x1/2" - 822-1P		100 HP
11014	Jiffy Point Xtra Sharp Screw - #8x1/2" - 822-5		500 PI Box
11016	Jiffy Point Xtra Sharp Screw - #8x1/2" - 822-E		1000 PI Box
30904	Jiffy Point Xtra Sharp Screw - #8x1/2"		1000 PI Jar
11017	Jiffy Point Xtra Sharp Screw - #8x1/2" Includes 1 Jiffy Chuck		1000 PI Box
11018	Jiffy Point Xtra Sharp Screw - #8x1/2" - 822-B		5M PI Bucket
30762	Jiffy Point Xtra Sharp Screw - #8x1/2"		7M PI Bucket
11010	Jiffy Point Xtra Sharp Screw - #8x1/2" - 822		15M Bulk
11019	Jiffy Point Xtra Sharp Screw - #8x1/2"		15M Jiffy Pail

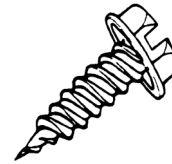

"Jiffy Point" Screws For the Professional Screw User
 Indented Hex Washer Head - Slotted, Hardened, Undercut Zinc Plated Sheet
 Metal Screws 1/4" HEX HEAD



Bar Code Number	Item Description	Size	Package Quantity
11021	Jiffy Point Screw - #8x3/4" -	823-R	25 HP
11022	Jiffy Point Screw - #8x3/4" -	823-1	100 Box
11023	Jiffy Point Screw - #8x3/4" -	823-1P	100 HP
11024	Jiffy Point Screw - #8x3/4" -	823-5	500 PI Box
11026	Jiffy Point Screw - #8x3/4" -	823-E	1000 PI Box
30908	Jiffy Point Screw - #8x3/4" -		1000 PI Jar
11027	Jiffy Point Screw - #8x3/4" -	Includes Jiffy Chuck	1000 PI Box
11028	Jiffy Point Screw - #8x3/4" -	823-B	3M PI Bucket
30763	Jiffy Point Screw - #8x3/4"		5M PI Bucket
11020	Jiffy Point - #8x3/4" -	823	10M Bulk
11029	Jiffy Point Screw - #8x3/4" -		10M Jiffy Pail
11031	Jiffy Point Screw - #8x1" -	824-R	25 HP
11032	Jiffy Point Screw - #8x1" -	824-1	100 Box
11033	Jiffy Point Screw - #8x1" -	824-1P	100 HP
11034	Jiffy Point Screw - #8x1" -	824-5	500 PI Box
30912	Jiffy Point Screw - #8x1" -		500 PI Jar
11035	Jiffy Point Screw - #8x1" -	824-J5 Includes Jiffy Chuck	500 PI Box
11036	Jiffy Point Screw - #8x1" -	824-E	1000 PI Jar
30915	Jiffy Point Screw - #8x1" -	Includes 1 Jiffy Chuck	1000 PI Jar
30764	Jiffy Point Screw - #8x1"		3.5M PI Bkt
11030	Jiffy Point Screw - #8x1" -	824	8M Bulk
11037	Jiffy Point Screw - #8x1"		8M Jiffy Pail
11039	Jiffy Point Screw - #8x1-1/4" -	825-R	25 HP
11040	Jiffy Point Screw - #8x1-1/4" -	825-1	100 Box
11042	Jiffy Point Screw - #8x1-1/4" -	825-5	500 PI Box
11041	Jiffy Point Screw - #8x1-1/4" -	825-J5 w/ Jiffy Chuck	500 PI Box
11044	Jiffy Point Screw - #8x1-1/4" -	825-E	1000 PI Jar
11038	Jiffy Point Screw - #8x1-1/4" -	825	5M Bulk
11043	Jiffy Point Screw - #8x1-1/4"		5M Jiffy Pail
11047	Jiffy Point Screw - #8x1-1/2" -	826-R	25 HP
11049	Jiffy Point Screw - #8x1-1/2" -	826-1P	50 HP
11048	Jiffy Point Screw - #8x1-1/2" -	826-1	100 Box
11050	Jiffy Point Screw - #8x1-1/2" -	826-250	250 PI Box
11051	Jiffy Point Screw - #8x1-1/2" -	Includes 1 Jiffy Chuck	250 PI Box
30916	Jiffy Point Screw - #8x1-1/2"		250 PI Jar
11052	Jiffy Point Screw - #8x1-1/2" -	826-5	500 PI Box
11054	Jiffy Point Screw - #8x1-1/2" -	826-E	1000 PI Jar
30765	Jiffy Point Screw - #8x1-1/2"		2250 PI Bkt
11046	Jiffy Point Screw - #8x1-1/2" -	826	5M Bulk
11055	Jiffy Point Screw - #8x1-1/2"		5M Jiffy Pail

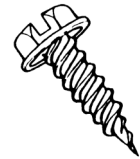

Note: bold bar coded items compare to other manufacturers' stock items.

"Jiffy Point" Screws.... Continued

1/4" HEX HEAD *For the Professional Screw User*

Bar Code Number	Item Description	Size	Package Qty.
11057	Jiffy Point Screw - #8x2" - 827-R		25 HP
11059	Jiffy Point Screw - #8x2" - 827-1P		50 HP
11058	Jiffy Point Screw - #8x2" - 827-1		100 Box
11060	Jiffy Point Screw - #8x2" - 827-250		250 PI Box
30920	Jiffy Point Screw - #8x2" -		250 PI Jar
11061	Jiffy Point Screw - #8x2" Includes 1 Jiffy Chuck		250 PI Box
11062	Jiffy Point Screw - #8x2" - 827-5		500 PI Jar
11064	Jiffy Point Screw - #8x2" - 827-E		1000 Bucket
30766	Jiffy Point Screw - #8x2"		1400 PI Bkt
11056	Jiffy Point Screw - #8x2" - 827		3M Bulk
11053	Jiffy Point Screw - #8x2" -		3M Jiffy Pail
11070	Jiffy Point Screw - #10x1/2"- 828-1		100 Box
11071	Jiffy Point Screw - #10x1/2" - 828-1P		100 HP
11072	Jiffy Point Screw - #10x1/2" - 828-5		500 PI Box
11074	Jiffy Point Screw - #10x1/2" - 828-E		1000 PI Box
30924	Jiffy Point Screw - #10x1/2"		1000 PI Jar
11068	Jiffy Point Screw - #10x1/2" - 828		10M Bulk
30612	Jiffy Point Screw - #10x1/2"		10M Jiffy Pail
11077	Jiffy Point Screw - #10x3/4" - 829-R		25 HP
11078	Jiffy Point Screw - #10x3/4" - 829-1		100 Box
11079	Jiffy Point Screw - #10x3/4" - 829-1P		100 HP
11080	Jiffy Point Screw - #10x3/4" - 829-5		500 PI Box
30927	Jiffy Point Screw - #10x3/4"		500 PI Jar
11082	Jiffy Point Screw - #10x3/4" - 829-E		1000 PI Box
30928	Jiffy Point Screw - #10x3/4"		1000 PI Jar
11083	Jiffy Point Screw - #10x3/4" Includes 1 Jiffy Chuck		1000 PI Box
11076	Jiffy Point Screw - #10x3/4" - 829		8M Bulk
30614	Jiffy Point Screw - #10x3/4"		8M Jiffy Pail

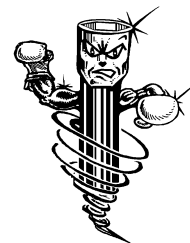
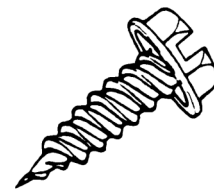
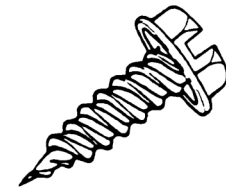

Note: Bold Bar Coded Items compare to other manufacturers' stock

"Jiffy Point" Screws... For the Professional Screw User

Indented Hex Washer Head - Slotted, Hardened, Undercut Zinc Plated Sheet Metal Screws

1/4" HEX HEAD

NOTE:
Items marked "w/
chuck" include a
1/4" x 1-3/4" Jiffy
Chuck in the pack-
age.

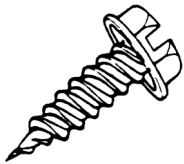

Bar Code Number	Item Description	Size	Package Quantity
11085	Jiffy Point Screw - #10x1" -	830-R	25 HP
11087	Jiffy Point Screw - #10x1" -	830-1P	50HP
11086	Jiffy Point Screw - #10x1" -	830-1	100 Box
11088	Jiffy Point Screw - #10x1" -	830-5	500 PI Box
30932	Jiffy Point Screw - #10x1"		500 PI Jar
11089	Jiffy Point Screw - #10x1" Includes Jiffy Chuck –	830-J5	500 PI Box
11090	Jiffy Point Screw - #10x1" -	830-E	1000 PI Jar
11091	Jiffy Point Screw - #10x1"		3000 PI Bucket
11084	Jiffy Point Screw - #10x1" -	830	5M Bulk
30616	Jiffy Point Screw - #10x1"		5M Jiffy Pail
11093	Jiffy Point Screw - #10x1-1/4" -	831-R	25 HP
11094	Jiffy Point Screw - #10x1-1/4" -	831-1	100 Box
11096	Jiffy Point Screw - #10x1-1/4" -	831-5	500 PI Box
11098	Jiffy Point Screw - #10x1-1/4" -	831-E	1000 PI Jar
11092	Jiffy Point Screw - #10x1-1/4" -	831	4M Bulk
10751	Jiffy Point Screw - #10x1-1/2" 832-R		25 HP
10752	Jiffy Point Screw - #10x1-1/2" 832-1		100 Box
10754	Jiffy Point Screw - #10x1-1/2" 132-5		500 PI Box
10758	Jiffy Point Screw - #10x1-1/2" Includes Jiffy Chuck 832-J5		500 PI Box
10756	Jiffy Point Screw - #10x1-1/2"		1000 PI Jar
10750	Jiffy Point Screw - #10x1-1/2" 832		5M Bulk
30618	Jiffy Point Screw - #10x1-1/2"		5M Jiffy Pail
10761	Jiffy Point Screw - #10x2" 133-R		25 HP
10762	Jiffy Point Screw - #10x2" 833-1		100 Box
10763	Jiffy Point Screw - #10x2" 833-250		250 PI Box
10764	Jiffy Point Screw - #10x2" 833-5		500 PI Jar
10768	Jiffy Point Screw - #10x2" 833-J5 Includes Jiffy Chuck		500 PI Jar
10760	Jiffy Point Screw - #10x2" 833		2M Bulk
30620	Jiffy Point Screw - #10x2"		2M Jiffy Pail
1/4" HEX HEAD w/ 5/16" WASHER			
30645	Jiffy Point Screw - #10x2-1/2"		100 Box
30647	Jiffy Point Screw - #10x3"		100 Box
30649	Jiffy Point Screw - #10x4"		100 Box
30651	Jiffy Point Screw - #10x5"		100 Box

5/16" HEX HEAD

"Jiffy Point" Screws For the Professional Screw User

Indented Hex Combo Washer Head - Hardened, Undercut Zinc Plated Sheet Metal Screws

Bar Code Number	Item Description	Size	Package Quantity
10775	Jiffy Point Screw- #10x1/2"	828-SR	25 HP
10776	Jiffy Point Screw- #10x1/2"	828-S1	100 Box
10778	Jiffy Point Screw- #10x1/2"	828-S5	500 PI Box
10779	Jiffy Point Screw- #10x1/2"		500 PI Jar
10780	Jiffy Point Screw- #10x1/2"	828-SE	1000 PI Box
10774	Jiffy Point Screw- #10x1/2"	828-S	10M Bulk
30622	Jiffy Point Screw- #10x1/2"		10M Jiff Pail
10783	Jiffy Point Screw- #10x3/4"		25 HP
10784	Jiffy Point Screw- #10x3/4"	829-S1	100 Box
10786	Jiffy Point Screw- #10x3/4"	838-S5	500 PI Box
10785	Jiffy Point Screw- #10x3/4"		500 PI Jar
10788	Jiffy Point Screw- #10x3/4"	828-SE	1000 PI Jar
10782	Jiffy Point Screw- #10x3/4"	829-S	8M Bulk
30624	Jiffy Point Screw- #10x3/4"		8M Jiffy Pail
10791	Jiffy Point Screw- #10x1"		25 HP
10792	Jiffy Point Screw- #10x1"	830-S	100 Box
10794	Jiffy Point Screw- #10x1"	830-S5	500 PI Box
10795	Jiffy Point Screw- #10x1"		500 PI Jar
10790	Jiffy Point Screw- #10x1"	830-S	6M Bulk
30626	Jiffy Point Screw- #10x1"		6M Jiffy Pail
30500	Jiffy Point Screw- #10x1-1/4"		100 Box
30502	Jiffy Point Screw- #10x1-1/4"		500 PI Box
30657	Jiffy Point Screw- #10x1-1/4"		5M Bulk
30641	Jiffy Point Screw- #10x1-1/4"		5M Jiffy Pail
10797	Jiffy Point Screw- #10x1-1/2"		25 HP
10798	Jiffy Point Screw- #10x1-1/2"	832-S1	100 Box
10800	Jiffy Point Screw- #10x1-1/2"	832-S250	250 PI Box
10802	Jiffy Point Screw- #10x1-1/2"	828-SE	1000 PI Jar
10796	Jiffy Point Screw- #10x1-1/2"	832-S	4M Bulk
30628	Jiffy Point Screw- #10x1-1/2"		4M Jiffy Pail
10805	Jiffy Point Screw- #10x2"		25 HP
10806	Jiffy Point Screw- #10x2"	833-S1	100 Box
10807	Jiffy Point Screw- #10x2"		250 PI Box
30643	Jiffy Point Screw- #10x2"		500 PI Jar
10804	Jiffy Point Screw- #10x2"	833-S	1M Bulk
30630	Jiffy Point Screw- #10x2"		1M Jiffy Pail

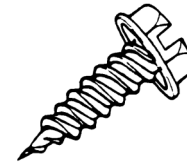

Note: Bold Bar Coded Items compare to other manufacturers' stock items.

Jiffy Pails "Jiffy Point" Screws... Continued

Indented Hex Washer Head - Slotted, Hardened, Undercut Zinc Plated Sheet Metal Screws

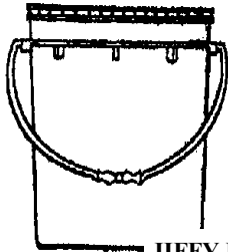

JIFFY PAIL



BAR CODE	SIZE	DESCRIPTION	PKG. QTY.
10603	6x3/8	1/4" Hex Head	20M Jiffy Pail
11009	7x1/2	1/4" Hex Head	15M Jiffy Pail
11019	8x1/2	1/4" Hex Head	15M Jiffy Pail
11029	8x3/4	1/4" Hex Head	10M Jiffy Pail
11037	8x1	1/4" Hex Head	8M Jiffy Pail
11043	8x1 1/4	1/4" Hex Head	5M Jiffy Pail
11055	8x1 1/2	1/4" Hex Head	5M Jiffy Pail
11053	8x2	1/4" Hex Head	3M Jiffy Pail
30612	10x1/2	1/4" Hex Head	10M Jiffy Pail
30614	10x3/4	1/4" Hex Head	8M Jiffy Pail
30616	10x1	1/4" Hex Head	5M Jiffy Pail
30618	10x1-1/2	1/4" Hex Head	5M Jiffy Pail
30620	10x2	1/4" Hex Head	2M Jiffy Pail
30622	10x1/2	5/16" Hex Head	10M Jiffy Pail
30624	10x3/4	5/16" Hex Head	8M Jiffy Pail
30626	10x1	5/16" Hex Head	6M Jiffy Pail
30641	10x1-1/4	5/16" Hex Head	5M Jiffy Pail
30628	10x1-1/2	5/16" Hex Head	4M Jiffy Pail
30630	10x2	5/16" Hex Head	1M Jiffy Pail

High Hat Jiffy Point

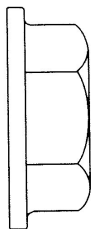

STANDARD HEAD

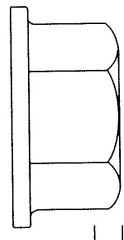

HIGH HAT HEAD

FEATURES 25-35% HIGHER HEAD HEIGHT THAN STANDARD HEAD FOR MORE SECURE DRIVING

SEE INSIDE BACK COVER FOR MORE INFO ON HI HEAD SCREWS

10709	10x1/2	High Hat w 5/16 Washer	100 Box
10711	10x1/2	High Hat w 5/16 Washer	500 PI Box
10713	10x1/2	High Hat w 5/16 Washer	5M Jiffy Pail
10715	10x1/2	High Hat w 5/16 Washer	10M Bulk
10735	10x3/4	High Hat w 5/16 Washer	25 HP
10737	10x3/4	High Hat w 5/16 Washer	100 Box
10739	10x3/4	High Hat w 5/16 Washer	100 HP
10755	10x3/4	High Hat w 5/16 Washer	500 PI Box
10759	10x3/4	High Hat w 5/16 Washer	1000 PI Box
10767	10x3/4	High Hat w 5/16 Washer	1000 PI Box w Chuck
10731	10x3/4	High Hat w 5/16 Washer	9M Jiffy Pail
10733	10x3/4	High Hat w 5/16 Washer	9M Bulk
10701	10x1	High Hat w 5/16 Washer	6M Bulk
30687	10x1-1/2	High Hat w 5/16 Washer	100 Box
30681	10x1-1/2	High Hat w 5/16 Washer	500 PI Box
10717	10x2	High Hat w 5/16 Washer	100 Box
10719	10x2	High Hat w 5/16 Washer	500 PI Jar
10707	10x2	High Hat w 5/16 Washer	2M Bulk

BULK CARTONS

"Jiffy Point" Screws.... Continued
For the Professional Screw

Indented Hex Washer Head - Slotted, Hardened, Undercut Zinc Plated Sheet Metal Screws

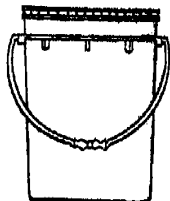
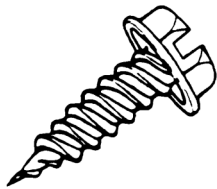

Buckets

BAR CODE	SIZE	DESCRIPTION	STK. #	PKG. QTY.
10600	6x3/8	1/4" Hex Head		20M Bulk
11000	7x1/2	1/4" Hex Head	821	15M Bulk
11010	8x1/2	1/4" Hex Head	822	15M Bulk
11020	8x3/4	1/4" Hex Head	823	10M Bulk
11030	8x1	1/4" Hex Head	824	8M Bulk
11038	8x1 1/4	1/4" Hex Head	825	5M Bulk
11046	8x1 1/2	1/4" Hex Head	826	5M Bulk
11056	8x2	1/4" Hex Head	827	3M Bulk
11068	10x1/2	1/4" Hex Head	828	10M Bulk
11076	10x3/4	1/4" Hex Head	829	8M Bulk
11084	10x1	1/4" Hex Head	830	7M Bulk
11092	10x1 1/4	1/4" Hex Head	831	4M Bulk
10750	10x1 1/2	1/4" Hex Head	832	5M Bulk
10760	10x2	1/4" Hex Head	833	2M Bulk
10774	10x1/2	5/16" Hex Head	828-S	10M Bulk
10782	10x3/4	5/16" Hex Head	829-S	8M Bulk
10790	10x1	5/16" Hex Head	830-S	6M Bulk
30657	10x1 1/4	5/16" Hex Head		5M Bulk
10796	10x1 1/2	5/16" Hex Head	832-S	4M Bulk
10804	10x2	5/16" Hex Head	833-S	1M Bulk
11008	7x1/2	1/4" Hex Head	821-B	5M Bucket
11018	8x1/2	1/4" Hex Head	822-B	5M Bucket
11028	8x3/4	1/4" Hex Head	823-B	3M Bucket
11015	8x1/2	1/4" Hex Head		Sample Pack

Note: Bold Bar Coded Items compare to other manufacturers' stock items.

SUPER "Jiffy" Point

Zinc Plated

Full 1/4" (No. 8) Indented Slotted Hex Washer Head.

Undercut Washer Seats Flush and Holds Tight

Unique Hard Point ... Tapered, Sharp & Heat Treated for Maximum Penetration!

DEEP Threads... Cut and Hold Tight!

EXTRA LONG POINT

12% longer than the standard 7x1/2 & 8x1/2

Available in SUPER 7 and SUPER 8

Combination Twin Thread ...

Single starting thread machined to the **hard point** of the screw.

Second thread above the point for **faster penetration**

AKRON, OHIO U.S.A.
This product contains a mixture of domestic articles and articles from one or more foreign countries, including the following: Japan, Taiwan, Korea, China.

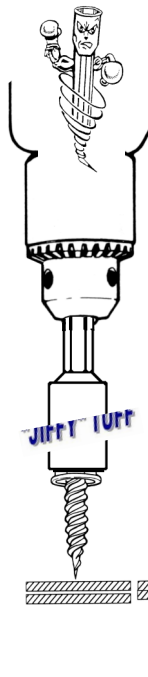

Driving Tips and Techniques

- Place "Jiffy" Point Screw into The *Original Magnetic "Jiffy" Chuck*.
- Press point of screw firmly against material to be drilled and fastened.
- Depress electric drill trigger to begin drilling.
- Once the screw threads engage the material, feather the drill trigger to tighten the "Jiffy" Point Screw.
- Driving technique may vary for lower speed, cordless drills or drills and screw guns with adjustable torque or automatic clutch features.

Test results available on request

"Jiffy" Point Screws offer excellent performance using an electric drill, screw gun, or driver.

BAR CODE	SIZE	DESCRIPTION	PKG. QTY.
30804	7x1/2	Super 7 Jiffy Point	100 Box
30814	8x1/2	Super 8 Jiffy Point	100 Box
30802	7x1/2	Super 7 Jiffy Point	1000 PI Box
30812	8x1/2	Super 8 Jiffy Point	1000 PI Box
30803	7x1/2	Super 7 Jiffy Point	500 PI Box
30813	8x1/2	Super 8 Jiffy Point	500 PI Box
30800	7x1/2	Super 7 Jiffy Point	15M Jiffy Pail
30810	8x1/2	Super 8 Jiffy Point	15M Jiffy Pail
30806	7x1/2	Super 7 Jiffy Point	5M Bucket
30816	8x1/2	Super 8 Jiffy Point	5M Bucket

"Jiffy Point" Screws.... Cont
For the Professional Screw User

Indented Hex Washer Head - Slotted, Hardened, Undercut Zinc Plated Sheet Metal Screws

PAINTED REGISTER SCREWS

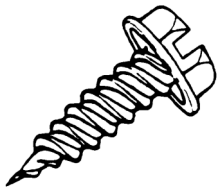

BAR CODE	SIZE	DESCRIPTION	STK. #	PKG. QTY.
10960	8x1 1/2	Hex White Head		50 HP
10958	8x1 1/2	Hex White Head	826-W1	100 Box
10962	8x1 1/2	Hex White Head		250 PI Box
10918	8x1 1/2	Hex White Head		500 PL Box
30632	8x1 1/2	Hex White Head		5M Jiffy Pail
10956	8x1 1/2	Hex White Head	826-W	5M Bulk
10976	8x2	Hex White Head		50 HP
10974	8x2	Hex White Head		100 Box
11063	8x2	Hex White Head		250 PL Box
10926	8x2	Hex White Head		500 PL Box
10920	8x2	Hex White Head		1M Box
10972	8x2	Hex White Head		3M Bulk
30638	8x2	Hex White Head		3M Jiffy Pail
10933	8x2	Phil Oval White Head		50 PL Hang PK
10928	8x2	Phil Oval White Head	850-1	100 Box
10930	8x2	Phil Oval White Head	850-250	250 PL Box
10932	8x2-1/2	Phil Flat White Head		100 Box
10934	8x2 1/2	Phil Flat White Head		250 PI Box
10988	8x2	Phillips Pan Head		100 Box
10990	8x2	Phillips Pan Head		250 PI Box
10954	8x3	Hex White Head		100 Box
10955	8x3	Hex White Head		250 Box
30646	8x3	Hex White Head		2M Jiffy Pail

“Jiffy” Driltilp Screws

High Speed Driltilp Bit Tip...
Drills - Taps - Threads - Inserts
All in 1 EZ Step!

Available with Hex Head
or Pan Head

Undercut Washer Seats
Flush and Holds Tight

ALSO AVAILABLE WITH A
BONDED SEALING WASHER

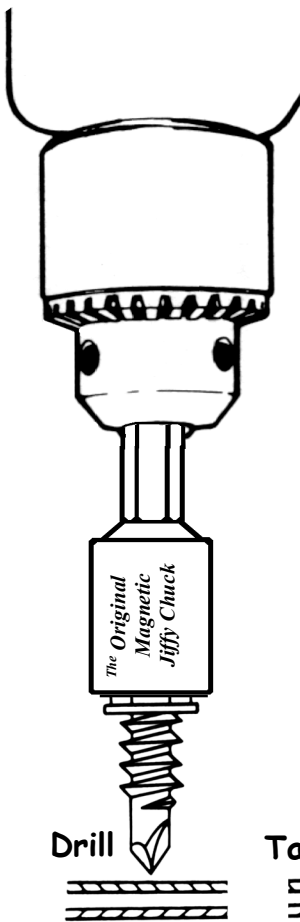
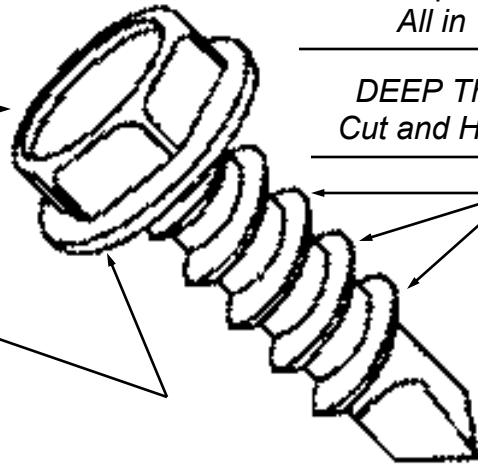

Tips and Techniques

Place *Jiffy Driltilp Screw* into
The *Original Magnetic Jiffy
Chuck*.

Press firmly against material to
be drilled, tapped and fastened.

Depress electric drill trigger to
begin drilling.
Once hole is drilled, feather the
drill trigger to tighten the *Jiffy
Driltilp Screw*.

Screw Size	Threads Per Inch	Drill Point Size
# 8	18	#2
#10	16	#3
#12	14	#3
#14	14	#3

The *Driltilp* Screw. The perfect screw for easy 1-step fastening of a wide range of materials...

- Sheet metal
- Structural steel
- Laminates
- Composition board
- Plastics
- Plywood
- Hardwoods
- Construction lumber

For optimal performance, an electric drill, screw gun, or driver rated at 2500 R.P.M. is recommended when fastening various materials with *Jiffy Driltilp* Screws.

1/4" Hex Head # 2 Point

"Jiffy" Drilltip Screws

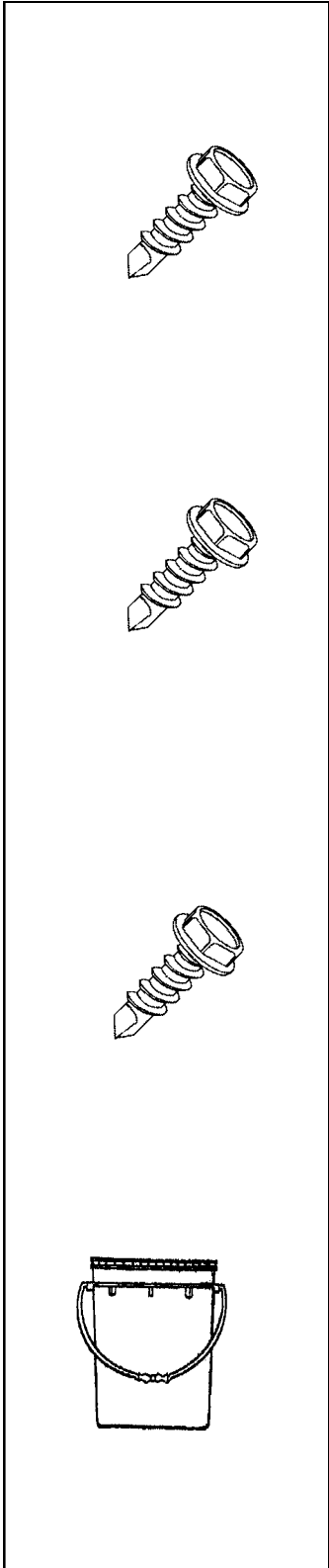

Bar Code Number	Item Description	Size	Package Quantity
11201	Jiffy Drilltip Screw - #8 x 1/2 -	175-R	25 HP
11202	Jiffy Drilltip Screw - #8 x 1/2 -	175-1	100 Box
11203	Jiffy Drilltip Screw - #8 x 1/2		100 HP
11204	Jiffy Drilltip Screw - #8 x 1/2 -	175-5	500 PL Box
30842	Jiffy Drilltip Screw - #8 x 1/2		500 PI Jar
11206	Jiffy Drilltip Screw - #8 x 1/2 -	175-E	1000 PL Box
30850	Jiffy Drilltip Screw - #8 x 1/2		1000 PI Jar
11210	Jiffy Drilltip Screw - #8 x 1/2 Includes Jiffy Chuck		1000 PL Box
11208	Jiffy Drilltip Screw - #8 x 1/2 -	175-B	5000 Bucket
11200	Jiffy Drilltip Screw - #8 x 1/2 -	175	10M Bulk
30650	Jiffy Drilltip Screw - #8 x 1/2		10M Jiffy Pail
11214	Jiffy Drilltip Screw - #8 x 5/8 -	176-1	100 Box
11216	Jiffy Drilltip Screw - #8 x 5/8 -	176-5	500 PL Box
11218	Jiffy Drilltip Screw - #8 x 5/8 -	176-E	1000 PL Box
11221	Jiffy Drilltip Screw - #8 x 3/4 -	177-R	25 HP
11222	Jiffy Drilltip Screw - #8 x 3/4 -	177-1	100 Box
11223	Jiffy Drilltip Screw - #8 x 3/4		100 HP
11224	Jiffy Drilltip Screw - #8 x 3/4 -	177-5	500 PL Box
30846	Jiffy Drilltip Screw - #8 x 3/4		500 PL Screw Top Jar
11226	Jiffy Drilltip Screw - #8 x 3/4 -	177-E	1000 PL Box
30854	Jiffy Drilltip Screw - #8 x 3/4		1000 PI Jar
11228	Jiffy Drilltip Screw - #8 x 3/4 -	177-B	3000 Bucket
11220	Jiffy Drilltip Screw - #8 x 3/4 -	177	10M Bulk
30652	Jiffy Drilltip Screw - #8 x 3/4		10M Jiffy Pail

11233	Jiffy Drilltip Screw - #8 x 1 -	178-R	25 HP
11234	Jiffy Drilltip Screw - #8 x 1 -	178-1	100 Box
11235	Jiffy Drilltip Screw - #8 x 1		100 HP
30857	Jiffy Drilltip Screw - #8 x 1		250 PI Jar
11236	Jiffy Drilltip Screw - #8 x 1 -	178-5	500 PL Box
11238	Jiffy Drilltip Screw - #8 x 1 -	178-E	1000 PL Jar
11240	Jiffy Drilltip Screw - #8 x 1 -178-J Includes Jiffy Chuck		1000 PL Jar
11242	Jiffy Drilltip Screw - #8 x 1-1/4 -	189-1	100 Box
11246	Jiffy Drilltip Screw - #8 x 1-1/2 -	190-1	100 Box
11248	Jiffy Drilltip Screw - #8 x 1-1/2 -	190-250	250 PL Box
30663	Jiffy Drilltip Screw - #8 x 1-1/2		5M Bulk

5/16" Hex Head #3 Point

"Jiffy" Drilltip Screws

Bar Code Number	Item Description	Size	Package Quantity
11250	Jiffy Drilltip Screw - #8 x 2 -	191-1	100 Box
11252	Jiffy Drilltip Screw - #8 x 2 -	191-250	250 PL Box
11258	Jiffy Drilltip Screw - #10 x 1/2 -	179-1	100 Box
11259	Jiffy Drilltip Screw - #10 x 1/2		100 HP
11260	Jiffy Drilltip Screw - #10 x 1/2 -	179-5	500 PL Box
11261	Jiffy Drilltip Screw - #10 x 1/2		500 PL Screw Top Jar
11262	Jiffy Drilltip Screw - #10 x 1/2 -	179-E	1000 PL Box
11256	Jiffy Drilltip Screw - #10 x 1/2 -	179	8M Bulk
30662	Jiffy Drilltip Screw - #10 x 1/2		8M Jiffy Pail
31308	Jiffy Drilltip Screw - #10 x 5/8		100 Box
31310	Jiffy Drilltip Screw - #10 x 5/8		100 PI Box
31312	Jiffy Drilltip Screw - #10 x 5/8		500 PI Box
31300	Jiffy Drilltip Screw - #10 x 5/8		8M Bulk
11266	Jiffy Drilltip Screw - #10 x 3/4 -	180-1	100 Box
11269	Jiffy Drilltip Screw - #10 x 3/4		100 HP
11268	Jiffy Drilltip Screw - #10 x 3/4 -	180-5	500 PI Box
11263	Jiffy Drilltip Screw - #10 x 3/4		500 PL Screw Top Jar
30866	Jiffy Drilltip Screw - #10 x 3/4 Includes 1 Jiffy Chuck		500 PI Box
11270	Jiffy Drilltip Screw - #10 x 3/4		1000 PI Box
30868	Jiffy Drilltip Screw - #10 x 3/4		1000 PI Jar
30870	Jiffy Drilltip Screw - #10 x 3/4 Includes 1 Jiffy Chuck		1000 PI Jar
11271	Jiffy Drilltip Screw - #10 x 3/4 -	180-B	2000 Bucket
11264	Jiffy Drilltip Screw - #10 x 3/4 -	180	7M Bulk
30664	Jiffy Drilltip Screw - #10 x 3/4		7M Jiffy Pail
30731	Jiffy High Hat Head Drilltip Screw - #10 x 3/4		100 Box
30733	Jiffy High Hat Head Drilltip Screw - #10 x 3/4		500 PL Box
30737	Jiffy High Hat Head Drilltip Screw - #10 x 3/4		500 PL Jar w/ Chuck
30739	Jiffy High Hat Head Drilltip Screw - #10 x 3/4		1000 Box
11285	Jiffy High Hat Head Drilltip Screw - #10 x 3/4		6M Bulk
11291	Jiffy High Hat Head Drilltip Screw - #10 x 3/4		6M Jiffy Pail
11274	Jiffy Drilltip Screw - #10 x 1 -	181-1	100 Box
11275	Jiffy Drilltip Screw - #10 x 1		100 HP
11276	Jiffy Drilltip Screw - #10 x 1 -	181-5	500 PI Box
11278	Jiffy Drilltip Screw - #10 x 1 -	181-E	1000 PI Box
11272	Jiffy Drilltip Screw - #10 x 1 -	181	5M Bulk
30666	Jiffy Drilltip Screw - #10 x 1		5M Jiffy Pail
30878	Jiffy Drilltip Screw - #10 x 1-1/4		100 Box
30668	Jiffy Drilltip Screw - #10 x 1-1/4		4M Jiffy Pail
11281	Jiffy Drilltip Screw - #10 x 1-1/2	183-R	25 HP
11282	Jiffy Drilltip Screw - #10 x 1-1/2 -	183-1	100 Box
11284	Jiffy Drilltip Screw - #10 x 1-1/2 -	183-250	250 PI Box
11280	Jiffy Drilltip Screw - #10 x 1-1/2 -	183	3M Bulk
30670	Jiffy Drilltip Screw - #10 x 1-1/2		3M Jiffy Pail

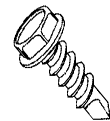

5/16" Hex Head #3 Point **"Jiffy" Driltip Screws ...Continued**

Bar Code Number	Item Description	Size	Package Quantity
11287	Jiffy Driltip Screw - #10 x 2 -	184-R	25 HP
11288	Jiffy Driltip Screw - #10 x 2 -	184-1	100 Box
30882	Jiffy Driltip Screw - #10 x 2		150 PL Jar
11290	Jiffy Driltip Screw - #10 x 2 -	184-250	250 PL Box
31202	Jiffy Driltip Screw - #10 x 2-1/2		100 Box
30884	Jiffy Driltip Screw - #10 x 2-1/2		1 M Jiffy Pail
31208	Jiffy Driltip Screw - #10 x 3		100 Box
31210	Jiffy Driltip Screw - #10 x 3		250 PL Box
31206	Jiffy Driltip Screw - #10 x 3		1M Bulk
30886	Jiffy Driltip Screw - #10 x 3		1M Jiffy Pail
11296	Jiffy Driltip Screw - #12 x 3/4 -	187-1	100 Box
11298	Jiffy Driltip Screw - #12 x 3/4 -	187-5	500 PL Box
30674	Jiffy Driltip Screw - #12 x 3/4		6M Jiffy Pail
11302	Jiffy Driltip Screw - #12 x 1 -	188-1	100 Box
11304	Jiffy Driltip Screw - #12 x 1 -	188-5	500 PL Box
11308	Jiffy Driltip Screw - #12 x 1-1/2 -	182-1	100 Box
11312	Jiffy Driltip Screw - #12 x 2 -	192-1	100 Box
31222	Jiffy Driltip Screw - #12 x 3		100 Box

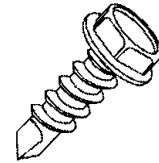
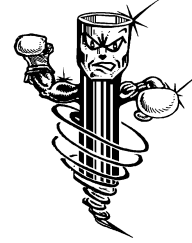

3/8" Hex Head

11320	Jiffy Driltip Screw - #14 x 3/4		100 Box
11326	Jiffy Driltip Screw - #14 x 1		100 Box
11328	Jiffy Driltip Screw - #14 x 1		250 PL Box
11330	Jiffy Driltip Screw - #14 x 1-1/2		100 Box
30887	Jiffy Driltip Screw - #14 x 2		100 Box

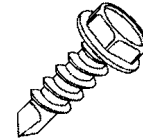

Phillips Pan Head

Bar Code Number	Item Description	Size	Package Quantity
11340	Jiffy Driltip Screw-PH - #8 x 1/2 -	875-1	100 Box
11364	Jiffy Driltip Screw-PH - #10 x 1/2 -	870-5	500 PL Box
11370	Jiffy Driltip Screw-PH - #10 x 3/4 -	871-5	500 PL Box



Slotted Hex Washer Head

30713	Jiffy Driltip Screw- #8 x 1/2		500 PL Jar w/ Screw Lid
30717	Jiffy Driltip Screw- #8 x 1/2		1000 PL Jar w/ Screw Lid



“Jiffy” Driltip Screws ... Continued
5/16” Hex Head with - Bonded Sealing Washers

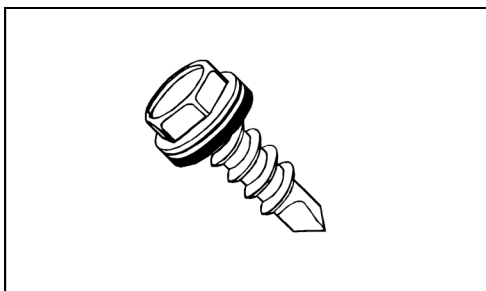

Bar Code Number	Item Description	Size	Package Quantity
11382	Jiffy Driltip Screw – SW	#10 x 3/4 - 880-1	100 Box
11388	Jiffy Driltip Screw – SW	#12 x 3/4 - 887-1	100 Box
11390	Jiffy Driltip Screw – SW	#12 x 3/4 - 887-5	500 PL Box
11396	Jiffy Driltip Screw – SW	#12 x 1 - 888-5	500 PL Box
11392	Jiffy Driltip Screw – SW	#12 x 1 - 888	2.5M Bulk
11402	Jiffy Driltip Screw - SW	#12 x 1-1/2 - 882-5	500 PL Box

Bonded Sealing Washers

-EPDM rubber bonded to steel
 -For Jiffy Driltip Screws, Jiffy Point Screws, & all other sheet metal fasteners to make a weathertight Seal.

Call for price & availability on other sizes



Bar Code Number	Item Description	Size	Package Quantity
11484	Sealing Washer - #8-10	(8 x 1/2” dia.)	100 Bulk
11482	Sealing Washer - #8-10	(8 x 1/2” dia.)	1000 Bulk

“Jiffy” Pails-Driltip Screws

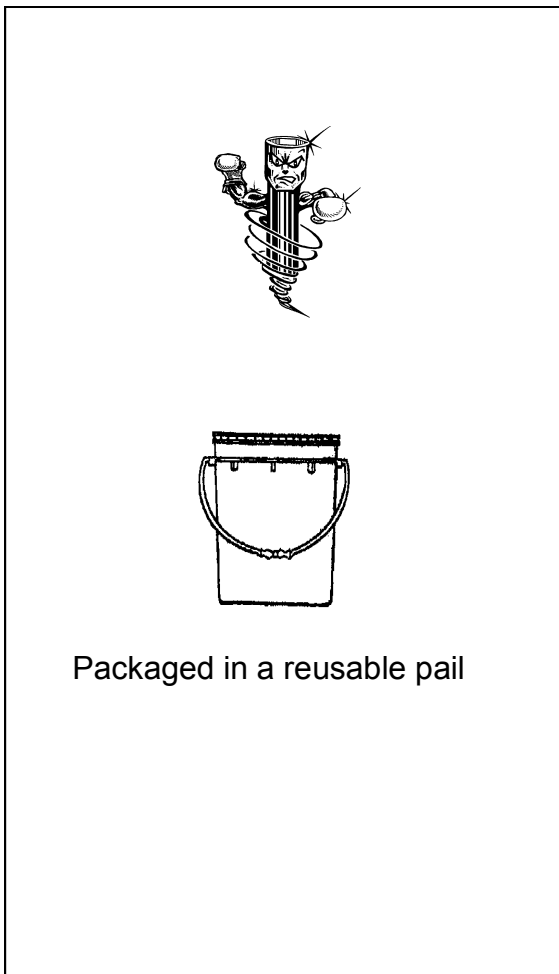

Packaged in a reusable pail

Bar Code Number	Item Description	Size	Package Quantity
30650	1/4” Hex Driltip - #8	x 1/2	10M
30652	1/4” Hex Driltip - #8	x 3/4	10M
30654	1/4” Hex Driltip - #8	x 1	8M
30656	1/4” Hex Driltip - #8	x 1-1/4	5M
30658	1/4” Hex Driltip - #8	x 1-1/2	5M
30660	1/4” Hex Driltip - #8	x 2	3M
30662	5/16” Hex Driltip - #10	x 1/2	8M
30664	5/16” Hex Driltip - #10	x 3/4	7M
30666	5/16” Hex Driltip - #10	x 1	5M
30668	5/16” Hex Driltip - #10	x 1-1/4	4M
30670	5/16” Hex Driltip - #10	x 1-1/2	3.5M
30672	5/16” Hex Driltip - #10	x 2	1.5M
30674	5/16” Hex Driltip - #12	x 3/4	6M
30676	5/16” Hex Driltip - #12	x 1	4M
30678	5/16” Hex Driltip - #12	x 1-1/4	3M
30680	5/16” Hex Driltip - #12	x 1-1/2	3M
30682	5/16” Hex Driltip - #12	x 2	2M
30684	5/16” Hex Driltip - #12	x 2-1/2	1.5M
30686	5/16” Hex Driltip - #12	x 3	1M
30688	3/8” Hex Driltip - #14	x 3/4	4M
30690	3/8” Hex Driltip - #14	x 1	3M
30692	3/8” Hex Driltip - #14	x 1-1/2	2M
30694	3/8” Hex Driltip - #14	x 2	1.5M
30696	3/8” Hex Driltip - #14	x 2-1/2	1M
30698	3/8” Hex Driltip - #14	x 3	1M
40012	Plastic 3-1/2 Gal Pail w/ Screw Top	Lid	1

"Jiffy" Screws

1/4" - SLOTTED HEX HEAD

- Indented slotted hex head
- Type A Tapping
- Hardened
- Zinc plated
- Perfect for use with bonded sealing washers

Bar Code Number	Item Description	Size	Package Quantity
11104	Jiffy Screw - #8 x 1/4 -	147-E	1000 PI Box
11100	Jiffy Screw - #8 x 1/4 -	147	6.25M Box
11107	Jiffy Screw - #8 x 3 -	149-R	25 HP
11108	Jiffy Screw - #8 x 3 -	149-1	100 Box

5/16" - Slotted Hex Head

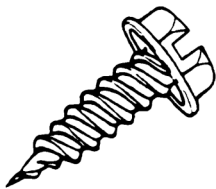

11114	Jiffy Screw - #12 x 1 -	134-1	100 Box
11120	Jiffy Screw - #12 x 1-1/4 -	135-1	100 Box
11126	Jiffy Screw - #12 x 1-1/2 -	136-1	100 Box
11132	Jiffy Screw - #12 x 2 -	137-1	100 Box
11134	Jiffy Screw - #12 x 2 -	137-5	500 Box

3/8" - Slotted Hex Head

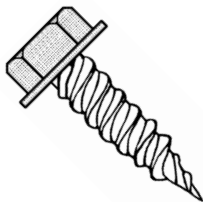

11150	Jiffy Screw - #14 x 1-1/4 -	139-1	100 Box
11156	Jiffy Screw - #14 x 1-1/2 -	140-1	100 Box
11162	Jiffy Screw - #14 x 2 -	140-1	100 Box
11160	Jiffy Screw - #14 x 2 -	140	1.5M Bulk

Stainless Steel Screws

1/4" - Indented Hex Washer Head, Slotted Self- Piercing Sheet Metal Screw



Bar Code Number	Item Description	Size	Package Quantity
11505	Stainless Steel Screw—# 6 x 3/8		100 box
11507	Stainless Steel Screw—# 6 x 3/8		1M PI Box
10911	7 x 1/2 Stainless Steel Speed Screw— White		100 Bag
11511	Stainless Steel Screw - #8 x 1/2 –	802-1	100 Box
11513	Stainless Steel Screw - #8 x 1/2 –	802-E	1M PI Box
11514	Stainless Steel Screw - #8 x 3/4 –	803-1	100 Box
11519	Stainless Steel Screw - #10 x 1-1/2		25 HP
11520	Stainless Steel Screw - #10 x 1-1/2-	804-1	100 Box

Stainless Steel Driltip Screws— Unslotted

11523	Stainless Steel Driltip Screw - #8 x 1/2 -	805-1	100 Box
11529	Stainless Steel Driltip Screw - #8 x 3/4		100 Box
11525	Stainless Steel Driltip Screw - #10 x 3/4-	808-1	100 Box
11526	Stainless Steel Driltip Screw - #10 x 3/4-	808-5	500 PI Box
11530	Stainless Steel Driltip Screw - #14 x 1-1/4		100 Box

E-mail: shookmfg@earthlink.net

Combo Phillips/Slotted Pan Head Screws

-Type A – Tapping
-Hardened
-Zinc Plated

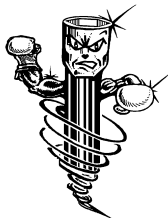

Bar Code Number	Item Description	Size	Pkg. Qty.
11602	Combo Head - #8 x 1/2		100 Box
11606	Combo Head - #8 x 1		100 Box
11610	Combo Head - #8 x 1-1/2		100 Box
11612	Combo Head - #8 x 2		100 Box
11620	Combo Head - #10 x 1		100 Box
11624	Combo Head - #10 x 1-1/4		100 Box
11628	Combo Head - #10 x 1-1/2		100 Box
11632	Combo Head - #10 x 2		100 Box
11644	Combo Head - #12 x 1		100 Box
11648	Combo Head - #12 x 1-1/4		100 Box
11652	Combo Head - #12 x 1-1/2		100 Box
11656	Combo Head - #12 x 2		100 Box
11672	Combo Head - #14 x 1-1/4		100 Box
11676	Combo Head - #14 x 1-1/2		100 Box
11680	Combo Head - #14 x 2		100 Box
11625	Combo Head-# 14 x 3		100Box

-Perfect when color matching is a must!
-Ideal for use with colored gutters and
downspouts!

Painted Speed Screws

Self-Piercing – 1/4" Hex Head Slotted

Bar Code Number	Item Description	Size	Color	Package Quantity
10814	Painted Speed Screw - #6 x 3/8 - Almond			100 Box
10840	Painted Speed Screw - #6 x 3/8 - Almond			1000 PL Box
10866	Painted Speed Screw - #7 x 1/2- Almond			100 Box
10892	Painted Speed Screw - #7 x 1/2- Almond			1000 PL Box
10808	Painted Speed Screw - #6 x 3/8" Antique Ivory			100 Box
10834	Painted Speed Screw - #6 x 3/8" Antique Ivory			1000 PL Box
10801	Painted Speed Screw - #6 x 3/8" Black			100 Box
10803	Painted Speed Screw - #6 x 3/8" Black			1000 PL Box
32040	Painted Speed Screw - #7 x 1/2" Black			100 Box
	Painted Speed Screw - #6 x 3/8" Bronze			See Terratone
10816	Painted Speed Screw - #6 x 3/8 - Brown / Royal Brown			100 Box
10842	Painted Speed Screw - #6 x 3/8 - Brown / Royal Brown			1000 PL Box
10868	Painted Speed Screw - #7 x 1/2 - Brown / Royal Brown			100 Box
10894	Painted Speed Screw - #7 x 1/2 - Brown / Royal Brown			1000 PI Box
10819	Painted Speed Screw - #8 x 1/2- Brown / Royal Brown			100 Box
10914	Painted Speed Screw - #8 x 1/2 - Brown / Royal Brown			1000 PL Box
10843	Painted Speed Screw - #8 x 3/4 - Brown / Royal Brown			100 Box
10867	Painted Speed Screw - #8 x 3/4 - Brown / Royal Brown			1000 PL Box
10835	Painted Speed Screw - #8 x 1 - Brown / Royal Brown			100 Box
10879	Painted Speed Screw - #8 x 1 - Brown / Royal Brown			500 PL Box
10824	Painted Speed Screw - #6 x 3/8 - Clay			100 Box
10850	Painted Speed Screw - #6 x 3/8 - Clay			1000 PL Box
10876	Painted Speed Screw - #7 x 1/2 - Clay			100 Box
10902	Painted Speed Screw - #7 x 1/2 - Clay			1000 PL Box
10825	Painted Speed Screw - #6 x 3/8 Cranberry			100 Box
10827	Painted Speed Screw - #6 x 3/8 Cranberry			1000 PI Box
32042	Painted Speed Screw - #7 x 1/2 Cranberry			100 Box
32050	Painted Speed Screw - #6 x 3/8 Cream			100 Box
10877	Painted Speed Screw - #7 x 1/2 Dark Bronze			100 Box
10997	Painted Speed Screw - #7 x 1/2 Desert Sand			100 Box
10992	Painted Speed Screw - #7 x 1/2 Desert Sand			1000 PL Box
10828	Painted Speed Screw - #6 x 3/8—Gray			100 Box
10854	Painted Speed Screw - #6 x 3/8—Gray			1000 PL Box
10853	Painted Speed Screw - #7 x 1/2—Gray			100 Box
10865	Painted Speed Screw - #7 x 1/2—Gray			1000 PL Box
10829	Painted Speed Screw - #6 x 3/8—Grecian Green			100 Box
10831	Painted Speed Screw - #6 x 3/8—Grecian Green			1000 PI Box
32044	Painted Speed Screw - #7 x 1/2—Grecian Green			100 Box
10813	Painted Speed Screw - #6 x 3/8- Herringbone			100 Box
10815	Painted Speed Screw - #6 x 3/8—Herringbone			1000 PL Box
10810	Painted Speed Screw - #6 x 3/8- Musket Brown			100 Box
10839	Painted Speed Screw - #6 x 3/8- Musket Brown			1000 PL Box
10855	Painted Speed Screw - #7 x 1/2- Musket Brown			100 Box
10888	Painted Speed Screw - #7 x 1/2- Musket Brown			1000 PL Box
10841	Painted Speed Screw - #8 x 3/4- Musket Brown			100 Box

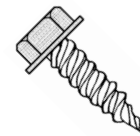
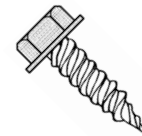
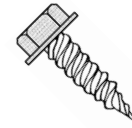

Other sizes available. Call for pricing.

Worried about color match? No problem!
Call Shook and request samples
for color matching. If our stock
colors don't match, custom
painting is available.

Painted Speed Screws...Continued



Bar Code Number	Item Description	Size	Color	Package Quantity
10822	Painted Speed Screw - #6 x 3/8—Terratone / Bronze			100 Box
10859	Painted Speed Screw - #6 x 3/8—Terratone / Bronze			1000 Box
10873	Painted Speed Screw - #7 x 1/2—Terratone / Bronze			100 Box
10875	Painted Speed Screw - #7 x 1/2—Terratone / Bronze			1000 PL Box
10832	Painted Speed Screw - #6 x 3/8 - White			100 Box
10858	Painted Speed Screw - #6 x 3/8 - White			1000 PL Box
10817	Painted Speed Screw - #6 x 3/8- White			20 M Bulk
10883	Painted Speed Screw - #6 x 3/8- White			20 M Jiffy Pail
10884	Painted Speed Screw - #7 x 1/2 - White			100 Box
10910	Painted Speed Screw - #7 x 1/2 - White			1000 PI Box
10885	Painted Speed Screw - #7 x 1/2 - White			15M Jiffy Pail
10857	Painted Speed Screw - #7 x 1/2 - White			15M Bulk
10911	Painted Stainless Steel Speed Screw - #7 x 1/2 - White			100 bag
10826	Painted Speed Screw - #6 x 3/8—Wicker			100 Box
10852	Painted Speed Screw - #6 x 3/8—Wicker			1000 PL Box
10878	Painted Speed Screw - #7 x 1/2—Wicker			100 Box
10877	Painted Speed Screw - #7 x 1/2—Wicker			1000 PL Box
10851	Painted Speed Screw - #8 x 3/4—Wicker			100 Box
10849	Painted Speed Screw - #8 x 3/4—Wicker			1000 PL Box
10938	Painted Speed Screw - #8 x 1/2—White			100 Box
10912	Painted Speed Screw - #8 x 1/2 - White			1000 PL Box
10940	Painted Speed Screw - #8 x 3/4 - White			100 Box
10821	Painted Speed Screw - #8 x 3/4—White			1000 PL Box
10942	Painted Speed Screw - #8 x 1 - White			100 Box
10823	Painted Speed Screw - #8 x 1 - White			500 Box

Zinc Plated

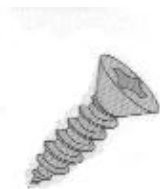

Phillips Flat Head Wood Screws

Bar Code Number	Item Description	Size	Package Quantity
11748	Wood Screw- # 10 x 1-1/2		100 Box
11728	Wood Screw - #12 x 1-1/2		25 HP
11726	Wood Screw - #12 x 1-1/2		100 Box
11730	Wood Screw - #12 x 2		100 Box
11734	Wood Screw - #12 x 2-1/2		100 Box
11738	Wood Screw - #12 x 3		100 Box
11744	Wood Screw - #14 x 2		100 Box
11746	Wood Screw - #14 x 2-1/2		100 Box

Framing Screws

Phillips Pan Head - Sharp Point

USED IN CONSTRUCTION AND METAL BUILDING TRADES

Bar Code Number	Item Description	Size	Package Qty.
11824	Framing Screw - # 6 x 7/16		100 Box
11826	Framing Screw - # 6 x 7/16		500 Box

Phillips Head - Driltip

11832	Framing Screw - # 7 x 7/16		500 Box
-------	----------------------------	--	---------



Drywall/Construction Screws

Phillips Bugle Head - Coarse Thread - Black

Sharp points-Fast insertion



Bar Code Number	Size	Pkg. Qty.	Square Drive Bugle Head - Coarse Thread - Black																																			
11914	#6 x 1"	100 Box	Bar Code	Size	Pkg Qty																																	
11886	#6 x 1"	500 Box	11956	#6 x 1-5/8"	5M Bulk																																	
11916	#6 x 1-1/8"	100 Box	11958	#6 x 2"	4M Bulk																																	
11888	#6 x 1-1/8"	500 Box	<h3>Phillips Bugle Head - Fine Thread - Black</h3> <table border="1"> <thead> <tr> <th>Bar Code</th> <th>Size</th> <th>Pkg Qty</th> </tr> </thead> <tbody> <tr> <td>11902</td> <td>#6 x 1"</td> <td>100 Box</td> </tr> <tr> <td>11904</td> <td>#6 x 1-1/8"</td> <td>100 Box</td> </tr> <tr> <td>11906</td> <td>#6 x 1-1/4"</td> <td>100 Box</td> </tr> <tr> <td>11908</td> <td>#6 x 1-5/8"</td> <td>100 Box</td> </tr> <tr> <td>11842</td> <td>#6 x 1-5/8"</td> <td>5M Bulk</td> </tr> <tr> <td>11910</td> <td>#6 x 2"</td> <td>100 Box</td> </tr> <tr> <td>11844</td> <td>#6 x 2"</td> <td>3.5M Bulk</td> </tr> <tr> <td>11912</td> <td>#6 x 2-1/4"</td> <td>100 Box</td> </tr> <tr> <td>11882</td> <td>#8 x 2-1/2"</td> <td>100 Box</td> </tr> <tr> <td>11884</td> <td>#8 x 3"</td> <td>100 Box</td> </tr> </tbody> </table>			Bar Code	Size	Pkg Qty	11902	#6 x 1"	100 Box	11904	#6 x 1-1/8"	100 Box	11906	#6 x 1-1/4"	100 Box	11908	#6 x 1-5/8"	100 Box	11842	#6 x 1-5/8"	5M Bulk	11910	#6 x 2"	100 Box	11844	#6 x 2"	3.5M Bulk	11912	#6 x 2-1/4"	100 Box	11882	#8 x 2-1/2"	100 Box	11884	#8 x 3"	100 Box
Bar Code	Size	Pkg Qty																																				
11902	#6 x 1"	100 Box																																				
11904	#6 x 1-1/8"	100 Box																																				
11906	#6 x 1-1/4"	100 Box																																				
11908	#6 x 1-5/8"	100 Box																																				
11842	#6 x 1-5/8"	5M Bulk																																				
11910	#6 x 2"	100 Box																																				
11844	#6 x 2"	3.5M Bulk																																				
11912	#6 x 2-1/4"	100 Box																																				
11882	#8 x 2-1/2"	100 Box																																				
11884	#8 x 3"	100 Box																																				
11919	#6 x 1-1/4"	25 HP																																				
11918	#6 x 1-1/4"	100 Box																																				
11890	#6 x 1-1/4"	500 Box																																				
11920	#6 x 1-5/8"	100 Box																																				
11892	#6 x 1-5/8"	500 Box																																				
11858	#6 x 1-5/8"	5M Bulk																																				
11923	#6 x 2"	25 HP																																				
11922	#6 x 2"	100 Box																																				
11895	#6 x 2"	250 Box																																				
11924	#6 x 2-1/4"	100 Box																																				
11896	#6 x 2-1/4"	250 Box																																				
11899	#8 x 2-1/2"	25 HP																																				
11898	#8 x 2-1/2"	100 Box																																				
11891	#8 x 2-1/2"	250 Box																																				
11893	#8 x 2-1/2"	500 Box																																				
11900	#8 x 3"	100 Box																																				
11894	#8 x 3"	500 Box																																				



Deck Screws

Phillips Bugle Head - Coarse Thread - Dacrotized for Rust Resistance

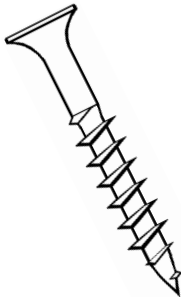
Bar Code Number	Item Description	Size	Package Quantity	<ul style="list-style-type: none"> -Coarse thread -Sharp points -Fast insertion -Holds tight 
01516	Deck Screw - Dacrotized - #6 x 1-1/4		100 Box	
01519	Deck Screw - Dacrotized - #6 x 1-5/8		25 HP	
01518	Deck Screw - Dacrotized - #6 x 1-5/8		100 Box	
01528	Deck Screw - Dacrotized - #6 x 1-5/8		500 Box	
01521	Deck Screw - Dacrotized - #6 x 2		25 HP	
01520	Deck Screw - Dacrotized - #6 x 2		100 Box	
01530	Deck Screw - Dacrotized - #6 x 2		500 Box	
01523	Deck Screw - Dacrotized - #8 x 2-1/2		25 HP	
01522	Deck Screw - Dacrotized - #8 x 2-1/2		100 Box	
01532	Deck Screw - Dacrotized - #8 x 2-1/2		500 Box	
01525	Deck Screw - Dacrotized - #8 x 3		25 HP	
01524	Deck Screw - Dacrotized - #8 x 3		100 Box	
01534	Deck Screw - Dacrotized - #8 x 3		500 Box	

Concrete Screws

- No anchor required
- Rust resistant blue finish
- Also available in kits
- All 100 pc boxes include masonry bit

Hex Washer Head

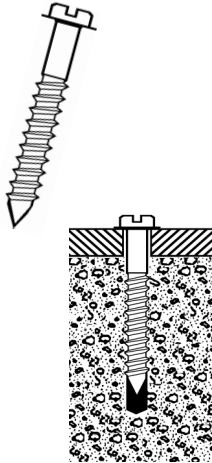

Bar Code Number	Item Description	Size	Reqd. Masonry Drill Bit Size	Drill Bit Included	Package Quantity
14700	Concrete Screw - 3/16" dia x 1-1/4" Long		5/32"	X	100 Box
14702	Concrete Screw - 3/16" dia x 1-3/4" Long		5/32"	X	100 Box
14705	Concrete Screw - 3/16" dia x 2-1/4" Long		5/32"		50 Box
14704	Concrete Screw - 3/16" dia x 2-1/4" Long		5/32"	X	100 Box
14709	Concrete Screw - 1/4" dia x 1-1/4" Long		3/16"		50 Box
14708	Concrete Screw - 1/4" dia x 1-1/4" Long		3/16"	X	100 Box
14711	Concrete Screw - 1/4" dia x 1-3/4" Long		3/16"		50 Box
14710	Concrete Screw - 1/4" dia x 1-3/4" Long		3/16"	X	100 Box
14713	Concrete Screw - 1/4" dia x 2-1/4" Long		3/16"		50 Box
14712	Concrete Screw - 1/4" dia x 2-1/4" Long		3/16"	X	100 Box
14715	Concrete Screw - 1/4" dia x 2-3/4" Long		3/16"		50 Box
14714	Concrete Screw - 1/4" dia x 2-3/4" Long		3/16"	X	100 Box
14716	Concrete Screw - 1/4" dia x 3-1/4" Long		3/16"	X	100 Box

Phillips Flat Head Concrete Screws



Bar Code Number	Item Description	Size	Reqd. Masonry Drill Bit Size	Drill Bit Included	Pkg. Qty.
14730	Concrete Screw - 3/16" dia x 1-1/4" Long		5/32"	X	100 Box
14732	Concrete Screw - 3/16" dia x 1-3/4" Long		5/32"	X	100 Box
14734	Concrete Screw - 3/16" dia x 2-1/4" Long		5/32"	X	100 Box
14736	Concrete Screw - 3/16" dia x 2-3/4" Long		5/32"	X	100 Box
14741	Concrete Screw - 1/4" dia. x 1-3/4" Long		3/16"		50 Box
14740	Concrete Screw - 1/4" dia. x 1-3/4" Long		3/16"	X	100 Box
14743	Concrete Screw - 1/4" dia. x 2-1/4" Long		3/16"		50 Box

Concrete Screw Drill Bits



Bar Code Number	Item Description	Size	Package Quantity
14762	Concrete Screw Drill Bit	5/32 x 3-1/2	1 Bulk
14763	Concrete Screw Drill Bit	5/32 x 3-1/2	1 POS
14764	Concrete Screw Drill Bit	5/32 x 4-1/2	1 Bulk
14765	Concrete Screw Drill Bit	5/32 x 4-1/2	1 POS
14766	Concrete Screw Drill Bit	3/16 x 3-1/2	1 Bulk
14767	Concrete Screw Drill Bit	3/16 x 3-1/2	1 POS
14768	Concrete Screw Drill Bit	3/16 x 4-1/2	1 Bulk
14769	Concrete Screw Drill Bit	3/16 x 4-1/2	1 POS
14770	Concrete Screw Drill Bit	3/16 x 5-1/2	1 Bulk
14771	Concrete Screw Drill Bit	3/16 x 5-1/2	1 POS

Concrete Anchor Installation Kit



Bar Code Number	Item Description	Size	Package Quantity
14772	Concrete Anchor Kit -Complete Kit		1
Accessories Included:			
14774	1/4" Magnetic Driver		1
14776	5/16" Magnetic Driver		1
14778	Phillips Bit Adapter		1
14780	Masonry Bit Holder		1
14782	Sleeve		1
14784	1/8 Hex Key		1
14786	#2 Phillips Bit		1
14788	#3 Phillips Bit		1
14790	Carrying Case		1
14768	3/16 x 4-1/2 Masonry Bit		1

Anchors

SLEEVE ANCHORS

Includes nuts & washers

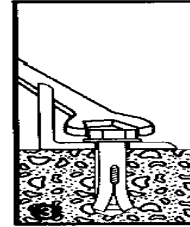
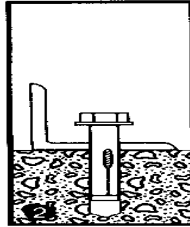
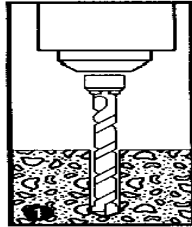

Zinc Plated

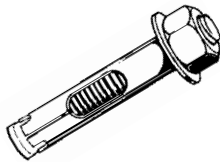

DROP-IN ANCHORS

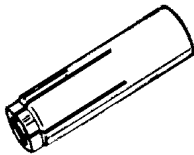

SETTING TOOL

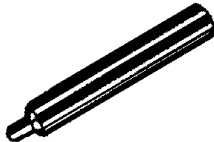

ROD HANGER



Bar Code Number	Item Description	Anchor Size	Drill Bit Size	Package Quantity
26104	Sleeve Anchor - 3/8" x 1-7/8"		3/8"	100 Box
26106	Sleeve Anchor - 3/8" x 3"		3/8"	100 Box
26110	Sleeve Anchor - 1/2" x 2-1/4"		1/2"	50 Box

Meets or exceeds GSA Specification FF-S-325, Group VII, Type 1

ZINC PLATED

Bar Code Number	Item Description	Size	Drill Bit Req'd.	Package Quantity
26150	Drop-in Anchor - 1/4" - 20		3/8"	100 Box
26152	Drop-in Anchor - 3/8" - 16		1/2"	50 Box
26153	Drop-in Anchor - 3/8" - 16		1/2"	100 Box
26154	Drop-in Anchor - 1/2" - 13		5/8"	50 Box
26156	Drop-in Anchor - 5/8" - 11		7/8"	25 Box
26158	Drop-in Anchor - 3/4" - 10		1"	25 Box

Shook setting tool must be used to insure proper and safe installation

26160	Setting Tool - 1/4" - 20			1 POS
26162	Setting Tool - 3/8" - 16			1 POS
26164	Setting Tool - 1/2" - 13			1 POS

Bar Code Number	Item Description	Size	Rod Size	Package Quantity
26134	Rod Hanger - 3/8" x 1-7/8"		3/8" Rod	100 Box

FAST Order Line: 1-800-354-9792 FAX: 1-800-733-3882

WEDGE ANCHORS-Includes NUTS & WASHERS

Dome on top of Anchor to protect threads during installation.
Full thread or longer threads on each side for rebar, machinery and other installations.

Bar Code Number	Item Description	Size	Package Quantity
26006	Wedge Anchor - 3/8 x 2-1/4"		100 Box
26008	Wedge Anchor - 3/8 x 2-3/4"		100 Box
26010	Wedge Anchor - 3/8 x 3"		100 Box
26012	Wedge Anchor - 3/8 x 3-3/4"		100 Box
26018	Wedge Anchor - 1/2 x 2-3/4"		50 Box
26038	Wedge Anchor - 5/8 x 5"		25 Box

HAMMER DRIVES- ZINC

Meets or exceeds GSA specification FF-S-325
Group VIII, Type 2, Class 3

Bar Code Number	Item Description	Size	Package Quantity
26172	Hammer Drive- 1/4" x 3/4"		100 Box
26174	Hammer Drive- 1/4" x 1"		100 Box
26176	Hammer Drive- 1/4" x 1-1/4"		100 Box
26178	Hammer Drive- 1/4" x 1-1/2"		100 Box
26180	Hammer Drive- 1/4" x 2"		100 Box

Lag Shields

Rustproof industrial quality
Meets or exceeds GSA Spec. FF-S-325, Group II, Type 1, Class 1 & 2

Bar Code Number	Item Description	Size	Package Quantity
26280	Lag Shield- 3/8 long		50 Box

Machine Screw Anchors

Rustproof industrial quality
Meets or exceeds GSA Spec. FF-S-325, Group II, Type 1, Class 1

Bar Code Number	Item Description	Size	Package Quantity
26306	1/4-20 x 15/16"		100
26310	3/8-16 x 1-3/8"		50
26312	1/2-13 x 1-9/16"		50

Lead Anchor Kit

26299	Lead Anchor Kit Contains:		
	10 x 1" Lead Anchors		100
	8 x 1" Combo Pan Head Tapping Screw		100
	5/16" x 4" Masonry Drill Bit		1
	#2 Phillips Insert Bit		1

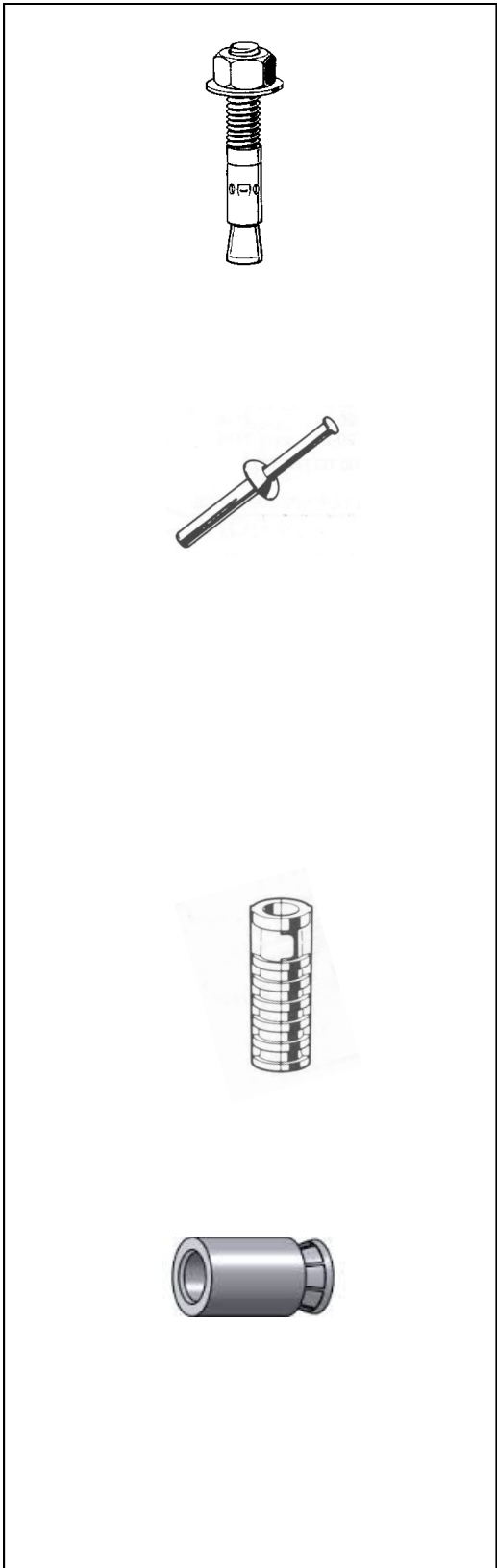

Round Head Stove Bolts with Hex Nuts

Zinc plated
Combo head

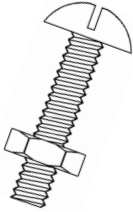

Bar Code Number	Item Description	Size	Package Quantity
12000	Stove Bolt with Hex Nut -	3/16 x 1/2 - 225-1	100 Box
12002	Stove Bolt with Hex Nut -	3/16 x 3/4 - 226-1	100 Box
12004	Stove Bolt with Hex Nut -	3/16 x 1 - 227-1	100 Box
12006	Stove Bolt with Hex Nut -	3/16 x 1-1/4 - 228-1	100 Box
12008	Stove Bolt with Hex Nut -	3/16 x 1-1/2 - 229-1	100 Box
12010	Stove Bolt with Hex Nut -	3/16 x 2 - 231-1	100 Box
12012	Stove Bolt with Hex Nut -	1/4 x 1/2 - 234-1	100 Box
12014	Stove Bolt with Hex Nut -	1/4 x 3/4 - 235-1	100 Box
12016	Stove Bolt with Hex Nut -	1/4 x 1 - 236-1	100 Box
12018	Stove Bolt with Hex Nut -	1/4 x 1-1/4 - 237-1	100 Box
12020	Stove Bolt with Hex Nut -	1/4 x 1-1/2 - 238-1	100 Box
12022	Stove Bolt with Hex Nut -	1/4 x 2 - 240-1	100 Box

Flat Washers

USS – Alloy Flat Washer

Bolt Size	O.D. A	I.D. B	Thick C
3/16"	9/16	1/4	3/64
1/4"	3/4	5/16	1/16
5/16"	7/8	3/8	5/64
3/8"	1.00	7/16	5/64
1/2"	1-3/8	9/16	7/64
5/8"	1-3/4	11/16	9/64
3/4"	2.00	13/16	5/32

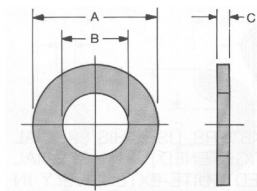

-Alloy steel, hardened to RC 45-53
-Zinc plated
-Meets or exceeds ASME/ANSI B818.22.1

Bar Code Number	Item Description	Size	Package Quantity
12468	USS Flat Washer -	3/16"	100 Box
12471	USS Flat Washer -	1/4"	25 HP
12470	USS Flat Washer -	1/4"	100 Box
12472	USS Flat Washer -	5/16"	100 Box
12475	USS Flat Washer -	3/8"	25 HP
12474	USS Flat Washer -	3/8"	100 Box
12476	USS Flat Washer -	1/2"	100 Box
12478	USS Flat Washer -	5/8"	100 Box
12480	USS Flat Washer -	3/4"	100 Box

SAE – Alloy Flat Washer

-Alloy steel, hardened to RC 45-53
-Zinc plated
-Meets or exceeds ASME/ANSI B818.22.1

Bolt Size	O.D. A	I.D. B	Thick C
#6	3/8	1/64	3/64
#8	7/16	3/16	3/64
#10	1/2	7/32	3/64
1/4"	5/8	9/32	1/16
5/16"	11/16	11/32	1/16
3/8"	13/16	13/32	1/16
1/2"	1-1/16	17/32	3/32
5/8"	1-5/16	21/32	3/32

12432	SAE Flat Washer - #8 - (3/16") ID x 7/16" OD x 3/64" Thk.	100 Box
12434	SAE Flat Washer - #10 - (7/32") ID x 1/2" OD x 3/64" Thk.	100 Box
12436	SAE Flat Washer - 1/4" - (9/32") ID x 5/8" OD x 1/16" Thk.	100 Box
12438	SAE Flat Washer - 5/16" - (11/32") ID x 11/16" OD x 1/16"	100 Box
12440	SAE Flat Washer - 3/8" - (13/32") ID x 13/16" OD x 1/16"	100 Box
12442	SAE Flat Washer - 1/2" - (17/32") ID x 1-1/16" OD x 3/32"	100 Box

Machine Screw Hex Nuts

Zinc plated

Bar Code Number	Item Description	Size	Package Quantity
12406	Hex Nut, Machine Screw	#10-32	100 Box

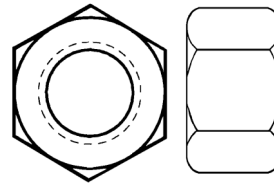

Finished Hex Nuts

Zinc plated

Bar Code Number	Item Description	Size	Package Quantity
12409	Hex Nut, Finished	1/4-20	25 HP
12408	Hex Nut, Finished	1/4-20	100 Box
12433	Hex Nut, Finished	1/4-20	500
12410	Hex Nut, Finished	5/16-18	100 Box
12413	Hex Nut, Finished	3/8-16	25 HP
12412	Hex Nut, Finished	3/8-16	100 Box
12420	Hex Nut, Finished	3/8-16	250
12421	Hex Nut, Finished	3/8-16	1000
12414	Hex Nut, Finished	1/2-13	50 Box
12416	Hex Nut, Finished	5/8-11	25 Box
12418	Hex Nut, Finished	3/4-10	20 Box

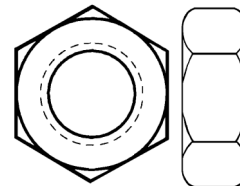

Wing Nuts

Stamped Wing Nuts

Bar Code Number	Item Description	Size	Package Quantity
12422	Stamped Wing Nut	1/4 - 20	100 Box
12424	Stamped Wing Nut	5/16 - 18	100 Box



Nylon Insert Lock Nuts

Bar Code Number	Item Description	Size	Package Quantity
12927	Nylon Insert Locknut	3/8-16	100



Heavy Hex Nuts

Bar Code Number	Item Description	Size	Package Quantity
12933	Heavy Hex Nut	3/8-16	100
12939	Heavy Hex Nut	1/2-13	100

Grade 2 steel

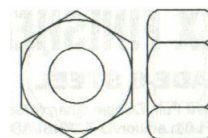

Grade 5 Hex Nuts

Bar Code Number	Item Description	Size	Package Quantity
12941	Grade 5 Hex Nut	1/4-20	100
12943	Grade 5 Hex Nut	5/16-18	100
12945	Grade 5 Hex Nut	3/8-16	100
12947	Grade 5 Hex Nut	1/2-13	100

Grade 5 steel
Zinc plated

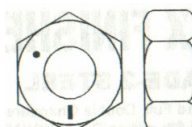

Fender Washers

Bar Code Number	Item Description	Size	Package Quantity
12485	Fender Washer - 3/16" I.D. - 1-1/4" O.D.		100 Box
12487	Fender Washer - 1/4" I.D. - 1" O.D.		25 HP
12486	Fender Washer - 1/4" I.D. - 1" O.D.		100 Box
12488	Fender Washer - 1/4" I.D. - 1-1/4" O.D.		100 Box
12490	Fender Washer - 1/4" I.D. - 1-1/2" O.D.		100 Box
12495	Fender Washer - 3/8" I.D. - 1-1/4" O.D.		25 HP
12493	Fender Washer - 3/8" I.D. - 1-1/4" O.D.		100 Box
12497	Fender Washer - 3/8" I.D. - 1-1/2" O.D.		25 HP
12494	Fender Washer - 3/8" I.D. - 1-1/2" O.D.		100 Box
12496	Fender Washer - 1/2" I.D. - 2" O.D.		100 Box

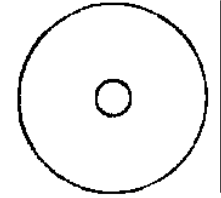

Lock Washers

Bar Code Number	Item Description	Size	Package Quantity
12455	Lock Washer - 1/4" I.D.		25 HP
12454	Lock Washer - 1/4" I.D.		100 Box
12456	Lock Washer - 5/16" I.D.		100 Box
12459	Lock Washer - 3/8" I.D.		25 HP
12458	Lock Washer - 3/8" I.D.		100 Box
12460	Lock Washer - 1/2" I.D.		100 Box
12463	Lock Washer - 5/8" I.D.		25 Box

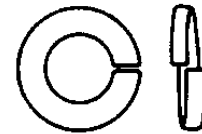

"Jiffy" Rivets

Steel Rivet - Steel Mandrel

1/8" Rivet Diameter

Bar Code Number	Grip Range	Marson Part #	Package Quantity
13214	1/32" to 1/16"	SB4-1-5	500 Box
13102	1/16" to 1/8"	SB4-2-1	100 Box
13104	1/16" to 1/8"	SB4-2-5	500 Box
13106	1/16" to 1/8"	SB4-2-E	1000 Box
13100	1/16" to 1/8"	SB4-2	10M Bulk
13110	1/8" to 3/16"	SB4-3-1	100 Box
13114	1/8" to 3/16"	SB4-3-E	1000 Box
13118	3/16" to 1/4"	SB4-4-1	100 Box
13120	3/16" to 1/4"	SB4-4-5	500 Box
13122	3/16" to 1/4"	SB4-4-E	1000 Box
13116	3/16" to 1/4"	SB4-4	10M Bulk
13136	5/16" to 3/8"	SB4-6-5	500 Box
13138	5/16" to 3/8"	SB4-6-E	1000 Box
13144	7/16" to 1/2"	SB4-8-5	500 Box

3/16" Rivet Diameter

13158	3/16" to 1/4"	SB6-4	5M Bulk
-------	---------------	-------	---------

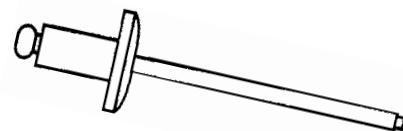
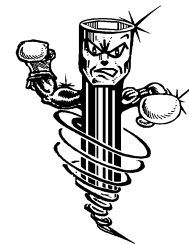

“Jiffy” Rivets...continued

Aluminum Rivet - Aluminum Mandrel

1/8" Rivet Diameter

Bar Code Number	Grip Range	Marson Part#	Package Quantity
13304	1/16" to 1/8"	AB4-2A-5	500 Box
13306	1/16" to 1/8"	AB4-2A-E	1000 Box
13300	1/16" to 1/8"	AB4-2A	10M Bulk
13456	1/8" to 3/16"	AB4-3A-5	500 Box
13458	1/8" to 3/16"	AB4-3A-E	1000 Box
13452	1/8" to 3/16"	AB4-3A	10M Bulk
13312	3/16" to 1/4"	AB4-4A-5	500 Box
13314	3/16" to 1/4"	AB4-4A-E	1000 Box
13330	5/16" to 3/8"	AB4-6A-5	500 Box
13334	7/16" to 1/2"	AB4-8A	10M Bulk
13358	3/16" to 1/4"	AB5-4A	5M Bulk

5/32" Rivet Diameter

Copper Rivet - Steel Mandrel

Bar Code Number	Grip Range	Marson Part#	Package Quantity
13704	1/16" to 1/8"	CB 4-2C-5	500 Box
13700	1/16" to 1/8"	CB 4-2C	10M Bulk
13702	1/16" to 1/8"	CB 4-2C-1	100 Box
13706	1/16" to 1/8"	CB 4-2C-E	1000 Box
13712	3/16" to 1/4"	CB 4-4C-5	500 Box
13714	3/16" to 1/4"	CB 4-4C-E	1000 Box
13708	3/16" to 1/4"	CB 4-4C	10M Bulk

Stainless Steel Rivet - 1/8" Rivet Diameter Stainless Steel Mandrel

Bar Code Number	Grip Range	Marson Part#	Package Quantity
13658	1/16" to 1/8"	SSB4-2S-1	100 Box
13660	1/16" to 1/8"	SSB4-2S-5	500 Box
13662	1/16" to 1/8"	SSB4-2S-E	1000 Box
13666	1/8" to 3/16"	SSB4-3S-1	100 Box
13668	1/8" to 3/16"	SSB4-3S-5	500 Box
13670	1/8" to 3/16"	SSB4-2S-E	1000 Box
13674	3/16" to 1/4"	SSB4-4S-1	100 Box
13676	3/16" to 1/4"	SSB4-4S-5	500 Box
13678	3/16" to 1/4"	SSB4-4S-E	1000 Box
13684	5/16" to 3/8"	SSB4-6S-5	500 Box

Painted Rivets

1/8" Rivet Diameter

Aluminum Rivet - Aluminum Mandrel

13460	White	AB4-2A	1/16 to 1/8	10M Bulk
13464	White	AB4-2A-5	1/16 to 1/8	500 Box
13488	Brown	AB4-2A-5	1/16 to 1/8	500 Box

Hand Rivet Tools

Bar Code Number	Item Description	Package Quantity
13000	Heavy Duty Hand Riveter	1 Bulk

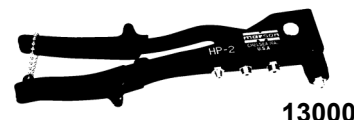
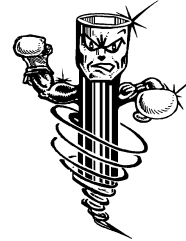

13000

Threaded Rod

Sold in full bundles only

Zinc Plated

Bar Code Number	Item Description	Size	Package Quantity
21004	Threaded Rod - 3/8-16	x 3'	20 pcs./bundle
21006	Threaded Rod - 3/8-16	x 6'	20 pcs./bundle
21008	Threaded Rod - 1/2-13	x 3'	20 pcs./bundle
21010	Threaded Rod - 1/2-13	x 6'	20 pcs./bundle



NOTE: DUE TO THE HIGH COST OF SHIPPING, THREADED ROD MAY NOT BE ELIGIBLE FOR FREIGHT ALLOWED ORDERS.

Coupling Nuts

Bar Code Number	Item Description	Size	Pkg. Qty.
21020	Coupling Nuts - 1/4"-20	x 7/8"	100
21023	Coupling Nuts - 5/16"-18	x 1-1/8"	50
21022	Coupling Nuts - 3/8"-16	x 1-1/8"	50
21025	Coupling Nut Reducer - 3/8"	to 5/16"	50

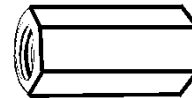

"Jiffy" Threaded Rod Cutter

- Precision clean cut design protects threads
- No cleaning threads- Just screw on nuts
- Easy to replace blade

Bar Code Number	Item Description	Size	Pkg. Qty.
15359	Threaded Rod Cutter-	3/8"	1
15361	Dies for Threaded Rod Cutter		1
15365	Dual Threaded Rod Cutter-	3/8" & 1/2"	1
15363	Ratcheting Threaded Rod Cutter-	3/8"	1

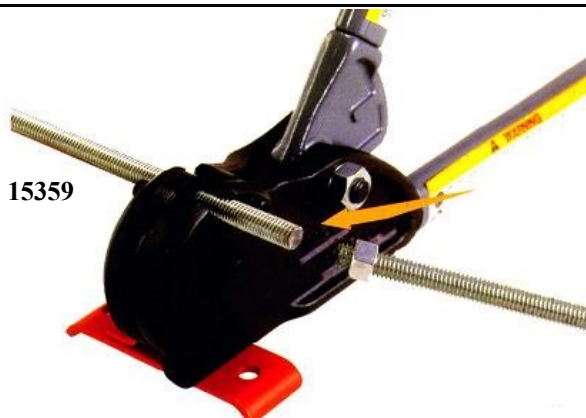

15359



15365



15363

Round Head Toggle Bolt Anchors with Wings

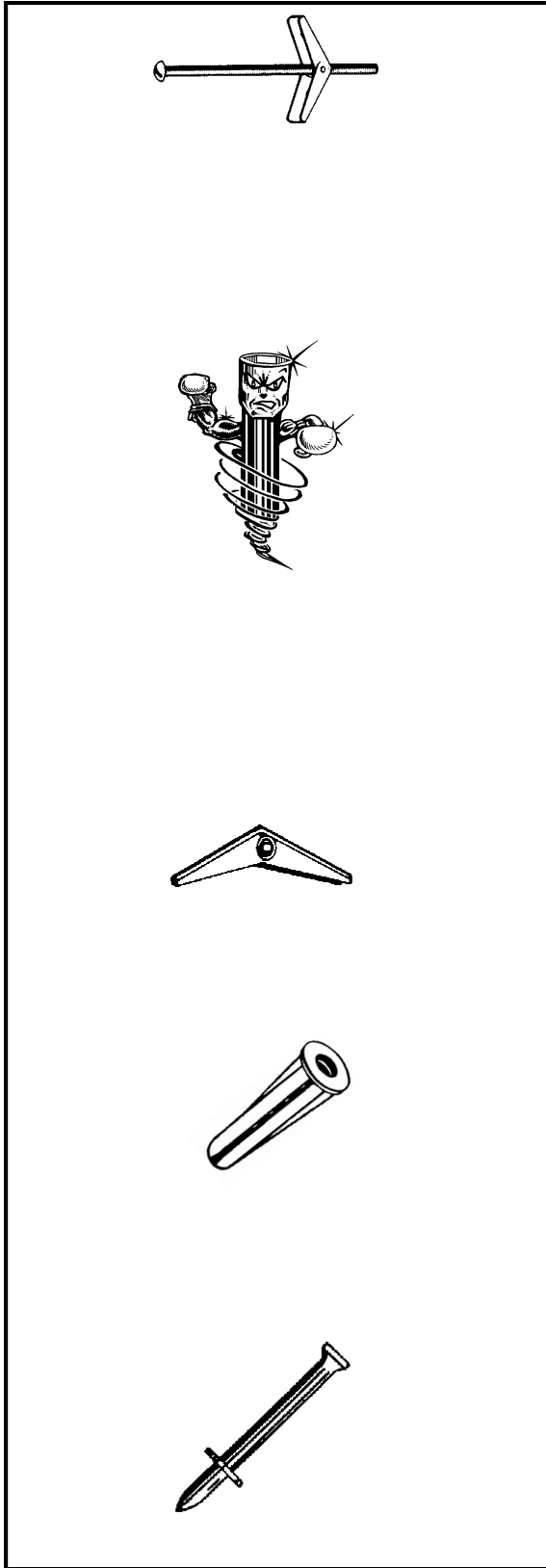

1/8" Dia.

12200	Bolt w/ Wings—1/8 x 2	3/8	100 Box
12202	Bolt w/ Wings— 1/8 x 3	3/8	100 Box
12204	Bolt w/ Wings—1/8 x 4	3/8	100 Box

3/16" Dia.

12206	Bolt w/ Wings—3/16 x 2	9/16	100 Box
12208	Bolt w/ Wings - 3/16 x 3	9/16	100 Box
12209	Bolt w/ Wings—3/16 x 3	9/16	25 POS
12210	Bolt w/ Wings - 3/16 x 4	9/16	50 Box
12211	Bolt w/ Wings—3/16 x 4	9/16	10 POS

1/4", 5/16", 3/8" Dia.

Bar Code Number	Item Description	Bolt Size	Drill Bit Dia.	Pkg. Qty.
12216	Bolt w/ Wings - 1/4 x 3		3/4"	50 Box
12218	Bolt w/ Wings - 1/4 x 4		3/4"	50 Box
12222	Bolt w/ Wings - 1/4 x 6		3/4"	50 Box
12224	Bolt w/ Wings—5/16 x 3		7/8"	25 Box
12232	Bolt w/ Wings—3/8 x 3		1"	25 Box
12234	Bolt w/ Wings - 3/8 x 4		1"	25 Box
12238	Bolt w/ Wings - 3/8 x 6		1"	25 Box

ZINC PLATED

Toggle Wings

Bar Code Number	Item Description	Size	Drill Bit Dia.	Pkg. Qty.
12334	Wings Only	3/16"	9/16"	50 Box
12338	Wings Only	1/4"	3/4"	100 Box
12346	Wings On;y	3/8"	1"	50 Box

Conical Plastic Wall Anchors

12276	Conical Wall Anchor - #8 - 10 x 7/8	460-1	3/16"	100 Box
12278	Conical Wall Anchor - #8 - 10 x 7/8"	460-E	3/16"	1000 Box
12280	Conical Wall Anchor - #10 - 12 x 1"	461-1	1/4"	100 Box
12282	Conical Wall Anchor - #10 - 12 x 1"	461-5	1/4"	500 Box
12284	Conical Wall Anchor - #14 - 16 x 1-1/2"	462-1	5/16"	100 Box

Drive Pins

Bar Code Number	Item Description	Size	Package Quantity
12302	Drive Pin - 7/8" Shank Length		100 HP
12308	Drive Pin - 1" Shank Length		50 HP
12306	Drive Pin - 1" Shank Length		100 HP
12310	Drive Pin - 1-1/4" Shank Length		100 HP
12312	Drive Pin - 1-1/2" Shank Length		100 Box
12314	Drive Pin - 2" Shank Length		100 Box
12320	Drive Pin Setting Tool		1

Anchor Kits

CONICAL PLASTIC ANCHORS

- Combo phillips/slotted pan head or combo hex washer head sheet metal screws
- Masonry drill bit included in selected kits
- Packaged in 2 compartment plastic box or plastic jar with screw top lid



Bar Code Number	Item Description	Size		Screw Size	Screw (Type)	Drill Bit Dia.	Pkg. Qty.
12500	Anchor Kit	3/16 x 3/4	464	6 x 3/4	Pan Combo	3/16"	100 Box
12502	Anchor Kit	3/16 x 7/8	465	8 x 1	Pan Combo	3/16"	100 Box
12503	Anchor Kit	3/16 x 7/8	465-J	8 x 1	Pan Combo	3/16"	100 Jar
12504	Anchor Kit	1/4 x 1	466-1	10 x 1	Pan Combo	1/4"	100 Box
12506	Anchor Kit	1/4 x 1	466	10 x 1-1/4	Pan Combo	1/4"	100 Box
12509	Anchor Kit	1/4 x 1	466-J	10 x 1-1/4	Pan Combo	1/4"	100 PL Jar
12514	Anchor Kit	1/4 x 1	466-2	10 x 1-1/4	Pan Combo	1/4"	200 PL Box
12512	Anchor Kit	1/4 x 1	466-12	10 x 1-1/4	Pan Combo	1/4"	200 PL Box
12510	Anchor Kit	5/16 x 1-1/4		12 x 1-1/4	Pan Combo	5/16"	50 Box
12508	Anchor Kit	5/16 x 1-3/8	467	14 x 1-1/2	Pan Combo	5/16"	50 Box
12513	Anchor Kit	5/16 x 1-3/8	467-J	14 x 1-1/2	Pan Combo	5/16"	50 PL Jar
12524	Anchor Kit	3/16 x 7/8	470	8 x 1	Combo Hex Washer Head	3/16"	100 Box
12526	Anchor Kit	1/4 x 1	471-1	10 x 1 (1/4)	Combo Hex Washer Head	1/4"	100 Box
12529	Anchor Kit	1/4 x 1		10 x 1 (5/16)	Combo Hex Washer Head	1/4"	100 Box
12527	Anchor Kit	1/4 x 1		10 x 1 (5/16)	Combo Hex Washer Head	1/4"	100 Jar
12528	Anchor Kit	1/4 x 1	471-S1	10 x 1 (5/16)	Combo Hex Washer Head	1/4"	100 Box
12533	Anchor Kit	1/4 x 1		10 x 1 (5/16)	Combo Hex Washer Head	1/4"	100 Jar
12530	Anchor Kit	1/4 x 1	471	10 x 1-1/4 (1/4)	Combo Hex Washer Head	1/4"	100 Box
12532	Anchor Kit	1/4 x 1	471-S	10 x 1-1/4 (5/16)	Combo Hex Washer Head	1/4"	100 Box
12534	Anchor Kit	1/4 x 1	471-2	10 x 1-1/2	Combo Hex Washer Head	1/4"	100 Box
12536	Anchor Kit	5/16 x 1-3/8	472	14 x 1-1/2	Hex Washer Head	5/16"	50 Box
12690	Anchor Kit Assortment- Contains 6 Each Of 8 Popular Anchor Kits- 12500, 12502, 12504, 12506, 12526, 12530, 12570, 12572 (12570, 12572- See Page 49)						

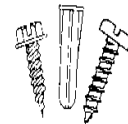

SEE PAGE 82 FOR ANCHOR KIT PLANOGRAM INFORMATION

NOTE: ITEMS IN BOLD DENOTE OUR MOST POPULAR SIZES.

“Jiffy” EZ Anchor Kits

DRYWALL ANCHOR KITS

-ALL KITS PACKAGED IN PLASTIC BOX OR JAR
-INCLUDES # 2 PHILLIPS BIT



Metal or nylon drywall anchors - Pan head combo phillips/slotted screws - No masonry bit needed

Bar Code Number	Item Description	Anchor Material	Screw Size	Screw (Type)	Package Quantity
12352	Jiffy EZ Drywall Anchor	PLASTIC	8 x 1-1/4	Pan Combo	50 Box
12356	Jiffy EZ Drywall Anchor	METAL	8 x 1-1/4	Pan Combo	50 Box
12570	Jiffy EZ Drywall Anchor	PLASTIC	8 x 1	Pan Combo	25 Box
12572	Jiffy EZ Drywall Anchor	METAL	8 x 1	Pan Combo	25 Box
12574	Jiffy EZ Drywall Anchor	PLASTIC	8 x 1	Pan Combo	50 Box
12576	Jiffy EZ Drywall Anchor	METAL	8 x 1	Pan Combo	50 Box
12578	Jiffy EZ Drywall Anchor	PLASTIC	ANCHORS ONLY		100 Box
12580	Jiffy EZ Drywall Anchor	METAL	ANCHORS ONLY		100 Box

NOTE: ITEMS IN BOLD DENOTE OUR MOST POPULAR SIZES

RIBBED ANCHOR KITS

-Combo phillips/slotted pan head or hex washer head sheet metal screws
-Masonry drill bit included in selected kits

Bar Code Number	Item Description	Size	Screw Size	Screw (Type)	Drill Bit Dia.	Pkg. Qty.
14502	Ribbed Plastic Anchor	3/16 x 7/8	8 x 1	Pan Combo	3/16"	100 Box
14548	Ribbed Plastic Anchor	1/4 x 1	10 x 1	Pan Combo	1/4"	100 Box
14506	Ribbed Plastic Anchor	1/4 x 1	10 x 1-1/4	Pan Combo	1/4"	100 Box

VINYL TUBE ANCHOR KITS

-Combo phillips/slotted pan head or hex washer head sheet metal screws
-Masonry drill bit included in kits

Bar Code Number	Item Description	Color	Vinyl Tube Anchor	Screw Size	Screw (Type)	Drill Dia.	Pkg. Qty.
12552	Vinyl Tube Anchor	Green	1/4 x 1	10 x 1	Pan Combo	1/4"	100 Box
12554	Vinyl Tube Anchor	Green	1/4 x 1	10 x 1-1/4	Pan Combo	1/4"	100 Box
12555	Vinyl Tube Anchor	Green	1/4 x 1-1/4	10 x 1-1/4	Pan Combo	1/4"	100 Jar

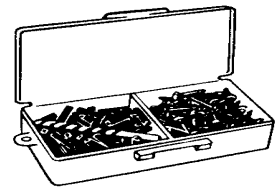
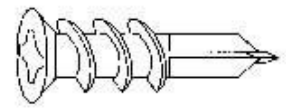

Assortments

JIFFY FASTENER ASSORTMENTS

IN REUSABLE PARTITIONED BOXES

Bar Code Number	Contains:	Size	Pieces/Box
12588	8 x 1/2 Jiffy Point Screws	#475	100
	8 x 3/4 Jiffy Point Screws		80
	8 x 1 Jiffy Point Screws		30
	8 x 2 Jiffy Point Screws		25
	8 x 3/4 Drilltip Screws		60
	1/4 x 1-3/4 Jiffy Chuck		1
	12606	7 x 1/2 Jiffy Point Screws	#477
8 x 1/2 Jiffy Point Screws			100
8 x 3/4 Jiffy Point Screws			100
10 x 1/2 (1/4) Head Jiffy Point Screws			100
10 x 3/4 (1/4) Head Jiffy Point Screws			100
12608		7 x 1/2 Jiffy Point Screws	#479
	8 x 1/2 Jiffy Point Screws		100
	8 x 3/4 Jiffy Point Screws		70
	10 x 1 (1/4 Head) Jiffy Point Screws		50
	10 x 1-1/2 (1/4 Head) Jiffy Point Screws		25
	1/4 x 1-3/4 Jiffy Chuck		1

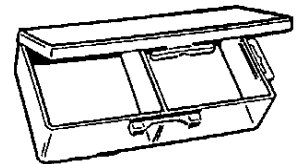

MACHINE SCREW, NUT and LOCK WASHER ASSORTMENT

12600	Round Head Machine Screw	6-32 x 1	15
	Round Head Machine Screw	6-32 x 1-1/2	15
	Round Head Machine Screw	6-32 x 2	15
	Round Head Machine Screw	8-32 x 1	15
	Round Head Machine Screw	8-32 x 1-1/2	15
	Round Head Machine Screw	8-32 x 2	15
	Round Head Machine Screw	10-32 x 1	15
	Round Head Machine Screw	10-32 x 1-1/2	15
	Round Head Machine Screw	10-32 x 2	15
	Hex Nuts	6-32, 8-32, 10-32	50
	Lock Washers	#6, #8, #10	50

BLUE MASONRY SCREW ASSORTMENT

Most Popular Hex Masonry or Phillips Flat Head Screws—Magnetic Chuck or Phillips Power Bit Included—Masonry Drill Bit Included

Bar Code Number	Item Description	Package Quantity
Bar Code	Items Included	Pcs. Ea.
12601	Hex Masonry Screw Assortment #481 1/4 x 1-3/4", 2-1/4", 2-3/4"	20
#481		
12605	Hex Masonry Screw 1/4 x 1-3/4	10
	Hex Masonry Screw 1/4 x 2-1/4	10
	Hex Masonry Screw 1/4 x 2-3/4	10
	Masonry Drill Bit 3/16 x 4	1
	Jiffy Chuck 5/16 x 1-3/4	1

SOCKET SET SCREW ASSORTMENT

29698	Socket Set Screw Assortment	Socket Set Screw	10
	1/4-28 x 1/4, 3/8, 1/2, 5/16-18 x 1/4, 3/8, 1/2	(Contains 10 of ea. Size)	10

Assortments

"JIFFY" FASTENER ASSORTMENTS IN REUSABLE PARTITIONED BOXES

Bar Code Number	Contains:	Size	Pieces/Box
12648	HEX NUT ASSORTMENT		
	6-32		100
	8-32		100
	10-32		100
	1/4-20		50
	5/16-18		30
	3/8-16		20
12660	FLAT WASHER ASSORTMENT		
	#6		100
	#8		100
	#10		100
	1/4		75
	5/16		50
	3/8		35
	1/2		25
12622	SELF DRILL SMS ASSORTMENT		
	8X1/2 DRILTIP SCR		50
	8X3/4 DRILTIP SCR		50
	10X3/4 DRILTIP SCR		50
	10X1 DRILTIP SCR		50
	1/4 SHORT JIFFY CHUCK		1
	5/16 SHORT JIFFY CHUCK		

Drill Bits



DOUBLE END DRILL BITS			
Bar Code Number	Item Description	Size	Package Quantity
12700	Double End Drill Bit	- 7/64" x 2"	12
12702	Double End Drill Bit	- 1/8" x 2"	12
12703	Double End Drill Bit	- 1/8" x 2"	144
12704	Double End Drill Bit	- 9/64" x 2"	12
12706	Double End Drill Bit	- 5/32" x 2-1/16"	12
12708	Double End Drill Bit	- 3/16" x 2-3/16"	12
12712	Double End Drill Bit	- 1/4 x 2-1/2"	12
12714	Double End Drill Bit	- #30 x 2"	12
12715	Double End Drill Bit	- #30 x 2"	144

HIGH SPEED JOBBER SHEET METAL DRILL BITS 135° SPLIT

Bar Code Number	Item Description	Size	Package Quantity
12726	High Speed Jobber Drill Bit	- 1/16"	12
12727	High Speed Jobber Drill Bit	- 1/16"	3
12728	High Speed Jobber Drill Bit	- 5/64"	12
12730	High Speed Jobber Drill Bit	- 3/32"	12
12732	High Speed Jobber Drill Bit	- 7/64"	12
12733	High Speed Jobber Drill Bit	- 7/64"	3
12734	High Speed Jobber Drill Bit	- 1/8"	12
12735	High Speed Jobber Drill Bit	- 1/8"	3
12737	High Speed Jobber Drill Bit	- 9/64"	3
12739	High Speed Jobber Drill Bit	- 5/32"	2
12741	High Speed Jobber Drill Bit	- 11/64"	2
12742	High Speed Jobber Drill Bit	- 3/16"	12
12743	High Speed Jobber Drill Bit	- 3/16"	2
12745	High Speed Jobber Drill Bit	- 13/64"	1
12747	High Speed Jobber Drill Bit	- 7/32"	1

HIGH SPEED JOBBER SHEET METAL DRILL BITS 135° SPLIT POINT



12750	High Speed Jobber Drill Bit - 1/4"	6
12751	High Speed Jobber Drill Bit - 1/4"	1
12753	High Speed Jobber Drill Bit - 17/64"	1
12755	High Speed Jobber Drill Bit - 9/32"	1
12758	High Speed Jobber Drill Bit - 5/16"	6
12759	High Speed Jobber Drill Bit - 5/16"	1
12763	High Speed Jobber Drill Bit - 11/32"	1
12765	High Speed Jobber Drill Bit - 23/64"	1
12766	High Speed Jobber Drill Bit - 3/8"	6
12767	High Speed Jobber Drill Bit - 3/8"	1
12770	High Speed Jobber Drill Bit - 13/32"	1
12776	High Speed Jobber Drill Bit - 29/64"	1

HIGH SPEED STEEL DRILL BITS with 1/4" SHANK

Bar Code Number	Item Description	Size	Package Quantity
12790	High Speed Steel Drill Bit - 1/2		1 POS

CARBIDE TIPPED MASONRY DRILL BITS

Rotary / Percussion
Professional Grade

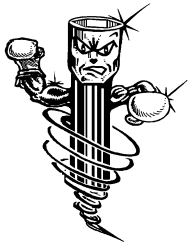

Bar Code Number	Item Description	Size	Package Quantity
14331	Carbide Tipped Masonry Drill Bit - 1/8 x 3	1/8	1 POS
12860	Carbide Tipped Masonry Drill Bit - 3/16 x 4	3/16	Bulk
12862	Carbide Tipped Masonry Drill Bit - 3/16 x 4	3/16	1 POS
12864	Carbide Tipped Masonry Drill Bit - 1/4 x 4	1/4	Bulk
12866	Carbide Tipped Masonry Drill Bit - 1/4 x 4	1/4	1 POS
12868	Carbide Tipped Masonry Drill Bit - 5/16 x 4	1/4	Bulk
12870	Carbide Tipped Masonry Drill Bit - 5/16 x 4	1/4	1 POS
12872	Carbide Tipped Masonry Drill Bit - 3/8 x 4	1/4	Bulk
12874	Carbide Tipped Masonry Drill Bit - 3/8 x 4	1/4	1 POS
12876	Carbide Tipped Masonry Drill Bit - 1/2 x 4	1/4	Bulk
12878	Carbide Tipped Masonry Drill Bit - 1/2 x 4	1/4	1 POS
12882	Carbide Tipped Masonry Drill Bit - 1/4 x 6	1/4	Bulk
14337	Carbide Tipped Masonry Drill Bit - 1/4 x 6	1/4	1 POS
14339	Carbide Tipped Masonry Drill Bit - 3/8 x 6	1/4	1 POS
14346	Carbide Tipped Masonry Drill Bit - 1/2 x 6	1/4	1 POS
14350	Carbide Tipped Masonry Drill Bit - 9/16 x 6	3/8	1 POS
12890	Carbide Tipped Masonry Drill Bit - 5/8 x 6	3/8	Bulk
14354	Carbide Tipped Masonry Drill Bit - 3/4 x 6	1/2	1 POS
14356	Carbide Tipped Masonry Drill Bit - 1 x 6	1/2	1 POS
14358	Carbide Tipped Masonry Drill Bit - 1/4 x 12	1/4	1 POS
14362	Carbide Tipped Masonry Drill Bit - 3/8 x 12	3/8	1 POS
14384	Carbide Tipped Masonry Drill Bit - 3/8 x 18	3/8	1 POS
14388	Carbide Tipped Masonry Drill Bit - 1/2 x 18	3/8	1 POS



“Jiffy” Quick Change 1/4” Hex Power Shank Carbide Tipped Masonry Drill Bits

Bar Code Number	Item Description	Size	Package Quantity
40570	Hex Shank Carbide Tip Masonry Drill Bit	1/4" x 5"	1 POS

“Jiffy” Multi-Step Drills

Self-Starting, Multiple Hole Sizes



Bar Code Number	Item Description	Size	Unibit #	No. of Holes	Hole Sizes	Increments	Package Quantity
16050	Jiffy Step Drill	1/4" Shank	1	13	1/8" to 1/2"	1/32"	1
16052	Jiffy Step Drill	1/4" Shank	2	6	3/16" to 1/2"	1/16"	1
16054	Jiffy Step Drill	3/8" Shank	3	9	1/4" to 3/4"	1/16"	1
16056	Jiffy Step Drill	3/8" Shank	4	12	3/16" to 7/8"	1/16"	1
16057	Jiffy Step Drill	1/2" Shank	5	10	1/4" to 1-3/8"	1/16"	1
16058	Jiffy Step Drill	1/4" Shank	10	N/A	1/2"		1
16060	Jiffy Step Drill	1/4" Shank	11	N/A	7/8"		1

“Jiffy” Quick Change Multi-Step Drills

1/4" Hex Power Shank

Bar Code	Description	Unibit #	# of Steps	Size Range	Pkg Qty
16062	Jiffy Quick Step Drill	1	13	1/8" to 1/2"	1
16064	Jiffy Quick Step Drill	2	6	3/16" to 1/2"	1

Spade Wood Bits

1/4" Shank

Bar Code Number	Item Description	Size	Package Quantity
14307	Spade Wood Drill Bit	- 1/2" x 6"	1 POS
14311	Spade Wood Drill Bit	- 5/8" x 6"	1 POS
14314	Spade Wood Drill Bit	- 3/4" x 6"	1 Bulk
14316	Spade Wood Drill Bit	- 7/8" x 6"	1 Bulk
14317	Spade Wood Drill Bit	- 7/8" x 6"	1 POS
14319	Spade Wood Drill Bit	- 15/16" x 6"	1 POS
14322	Spade Wood Drill Bit	- 1-1/8" x 6"	1 Bulk
14323	Spade Wood Drill Bit	- 1-1/8" x 6"	1 POS
14325	Spade Wood Drill Bit	- 1-1/4" x 6"	1 POS
14326	Spade Wood Drill Bit	- 1-3/8" x 6"	1 Bulk
14328	Spade Wood Drill Bit	- 1-1/2" x 6"	1 Bulk
14329	Spade Wood Drill Bit	- 1-1/2" x 6"	1 POS

“Jiffy” Quick Change 1/4” Hex Drive Shank Spade Bits x 6” Long

14617	Spade Wood Bit Hex Shank	- 3/4" x 6"	1 POS
14621	Spade Wood Bit Hex Shank	- 7/8" x 6"	1 POS
14624	Spade Wood Bit Hex Shank	- 1" x 6"	1 Bulk
14625	Spade Wood Bit Hex Shank	- 1" x 6"	1 POS
14627	Spade Wood Bit Hex Shank	- 1-1/8" x 6"	1 POS
14628	Spade Wood Bit Hex Shank	- 1-1/4" x 6"	1 Bulk
14629	Spade Wood Bit Hex Shank	- 1-1/4" x 6"	1 POS
14630	Spade Wood Bit Hex Shank	- 1-3/8" x 6"	1 Bulk
14631	Spade Wood Bit Hex Shank	- 1-3/8" x 6"	1 POS
14632	Spade Wood Bit Hex Shank	- 1-1/2" x 6"	1 Bulk
14633	Spade Wood Bit Hex Shank	- 1-1/2" x 6"	1 POS

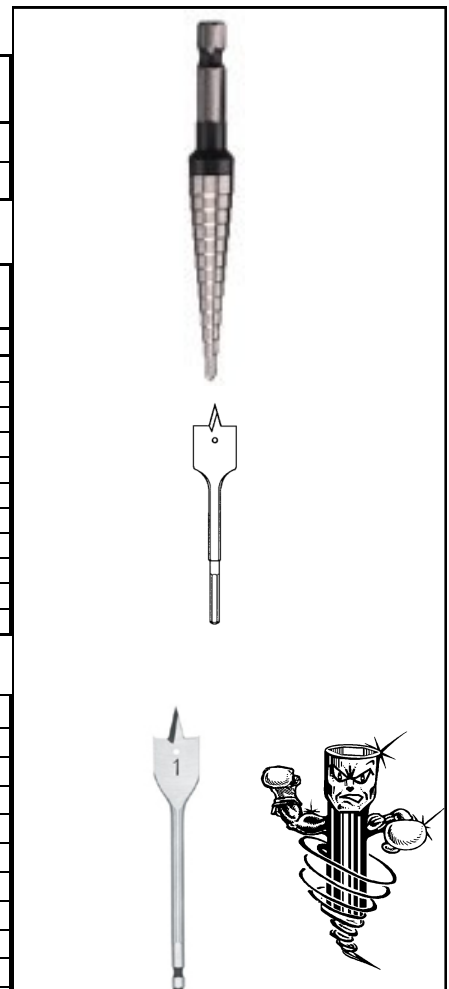

Bell Hanger Bits— For Thermostat Wire Installation

Stiff Shaft for Wood



40628	Bell Hanger Bit— 1/4" x 12"	1
40630	Bell Hanger Bit— 1/4" x 18"	1
40632	Bell Hanger Bit— 1/4" x 24"	1
40634	Bell Hanger Bit— 1/4" x 36"	1

Stiff Shaft for Masonry



40794	Bell Hanger Bit— Stiff Shaft for Masonry—	1/4" x 18"	1
40798	Bell Hanger Bit— Stiff Shaft for Masonry—	3/8" x 18"	1

“Jiffy” Quick Change 1/4” Hex Power Shank High Speed Drill Bits

- 1/4” Hex Shank— No Slipping
- Titanium-Nitride Coated
- Use With Jiffy Quick Change Adapter

Bar Code Number	Item Description	Length	Package Quantity
40416	1/8” Hex Shank Drill Bit	2-3/4”	1 Bulk
40417	9/64” Hex Shank Drill Bit	2-7/8”	1 Bulk
40428	3/16” Hex Shank Drill Bit	3-1/8”	1 Bulk
40440	1/4” Hex Shank Drill Bit	3-5/8”	1 Bulk



“Jiffy” Quick Change Drill Router

- 1/4” Hex Power Shank— No Slipping
- Use with Wood, Plastic, Metal

Bar Code Number	Item Description	Length	Package Quantity
10597	Jiffy Quick Change Drill Router		1 Bulk

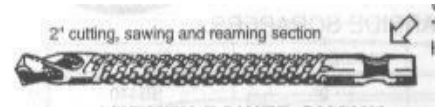

SDS Hammer Drill Bits

- ROTARY PERCUSSION
- PROFESSIONAL GRADE

- For drilling in concrete, brick, stone, and other masonry materials
- Double spiral flute clears dust quickly & reduces friction
- Made to ANSI standards.

Bar Code Number	Item Description	Size	Length	Package Quantity
14403	SDS Hammer Drill Bit	3/16”	4”	Pkg.
14407	SDS Hammer Drill Bit	3/16”	8”	Pkg.
14415	SDS Hammer Drill Bit	1/4”	4”	Pkg.
14448	SDS Hammer Drill Bit	1/2”	10”	Bulk

Please call for price on any sizes not listed.

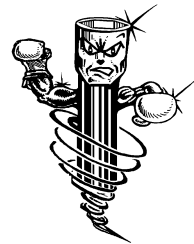

- Zinc Plated
- Low Carbon Steel
- Proof Load: 55,000 PSI
- Minimum Tensile Strength: 74,000 PSI
- Meets or exceeds ANSI/ASME B18.2.1, SAE J429, SAE J1061, and ASTM 788 Standards
- Use with finished hex nut

Grade 2

Bar Code Number	Size	Pkg. Qty.
22234	3/8-16 x 1"	100
22240	3/8-16 x 1-1/4"	100
22246	3/8-16 x 1-1/2"	100
22396	1/2-13 x 1-1/2"	50
22480	5/8-11 x 1"	25
22482	5/8-11 x 1-1/4"	25
22484	5/8-11 x 1-1/2"	25
22488	5/8-11 x 2"	25
22526	3/4-10 x 1-1/2"	20
22528	3/4-10 x 2"	20

CARRIAGE BOLTS

Bar Code Number	Size	Pkg. Qty.
23236	3/8-16 x 1"	1000 Jiffy Pail
23238	3/8-16 x 1"	500 Box
23240	3/8-16 x 1"	250 PL Bucket
23242	3/8-16 x 1"	100 Box

HEX TAP BOLTS

Coarse Thread
Zinc Plated
Grade 2

Bar Code Number	Size	Pkg. Qty.
22570	1/4-20 x 1"	100 Box
22571	Circulator Pack- 4- 3/8" x 2" w/ Nuts	8 Hang Pack

J-Bolts

Zinc Plated

21525	3/8" x 3-1/4" w/ Nut	10 Box
-------	----------------------	--------

Lag Screws

-Zinc Plated
-Low Carbon Steel
-Hex Head

1/4" Diameter

Use 7/16" Jiffy Chuck
for Easy Installation

Bar Code Number	Size	Pkg. Qty.
24046	1/4-10 x 2"	100 Box
24070	1/4-10 x 3"	100 Box

Hex Cap Screws

E Cap Screw Diameter (In.)	F Width(In.) of Hex Head	H Height (In.)	LT Thread Length (In.)
1/4	7/16	5/32	0.750
5/16	1/2	13.64	0.875
3/8	9/16	15/64	1.000
7/16	5/8	9/32	1.125
1/2	3/4	5/16	1.250
9/16	13/16	23/64	1.375
5/8	15/16	25/64	1.500
3/4	1-1/8	15/32	1.750

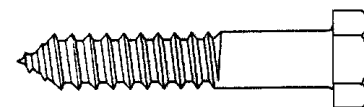
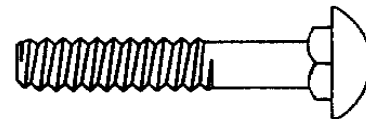
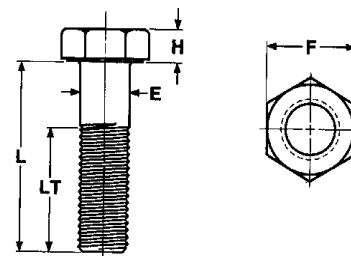

Call for Availability and Pricing of Hex
Cap Screws, Cap Bolts, Carriage Bolts
& Lag Screws Not Listed

Vertigo

Rod Hanger Fastening System

Vertigo Fasteners sold in full box qty. only.
Call for complete engineering data

Bar Code	Vertigo Part No.	Cross Ref Part No.	Rod Size	Screw Shank Size & Length	Qty/Box
STEEL VERTICAL HANGER					
47155	7155	DSTR100	1/4"	1/4-20x1"	100
47157	7157	DSTR1	3/8"	1/4-20X2"	100
47158	7158	DSTR1	3/8"	1/4-20x1" W/NUTS	100
47159	7159	DST15	3/8"	1/4-20X1-1/2"	100
47160	7160		3/8"	1/4-20X1-1/2" W/NUTS	100
47152	7152		1/4"	12-24X1-1/2"	100
47154	7154		3/8"	12-24X1-1/2" W/NUTS	100
47161	7161	TEK50	1/2"	12-24X1-1/2" W/NUTS	100
WOOD VERTICAL HANGER					
47163	7163	GST100	1/4"	1/4"X1"	100
47203	7203	GST10	3/8"	1/4"X1"	100
47165	7165	GST20	3/8"	1/4"X2"	100
47167	7167	GST30	3/8"	1/4"X3"	100
47169	7169	GST40	3/8"	1/4"X4"	100
47162	7162		3/8"	3/8"X2-1/2"	100
47164	7164		1/2"	3/8"X2-1/2"	100
CONCRETE VERTICAL HANGER					
47171	7171	CST200	1/4"	1/4"X1-1/4"	100
47173	7173	CST20	3/8"	1/4"X1-1/2"	100
47175	7175	CST2	1/2"	3/8"X2-3/4"	50
STEEL SIDE HANGER					
47183	7183	JRC1-1/2	1/4"	1/4-20X1"	100
47100	7200		1/4"	12-24X1-1/2"	100
47101	7201		3/8"	12-24X1-1/2" W/NUTS	100
47184	7184	SWD10	3/8"	1/4-20X1" W/NUTS	100
47186	7186		3/8"	1/4-20X1-1/2" W/NUTS	100
47188	7188	SWDR1	3/8"	1/4-20X2" W/NUTS	100
WOOD SIDE HANGER					
47185	7185	SWG200	1/4"	1/4"X1"	100
47170	7170	SWG20	3/8"	1/4"X2"	100
47156	7156		3/8"	1/4"X2-1/2"	100
47105	7205	SWG10	3/8"	1/4"X1"	100
ACCESSORIES					
47195	7195			1/4" CONCRETE SOCKET	1
47197	7197			3/8" CONCRETE SOCKET	1
47198	7198			1/2" CONCRETE SOCKET	1
80038				3/8" to 1/2" Threaded Rod Adapter	25
47187		JIFFY UNIVERSAL DRIVER			1

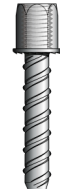
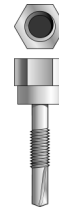

ROD HANGER CROSS REFERENCE

Bar Code	Description	Rod Size	Vertigo No.	Hangermate No.	Sammy No.
STEEL VERTICAL HANGER					
47155	1/4-20x1"	1/4"	7155	EZG160	DST100
47157	1/4-20x2"	3/8"	7157	EZG450	
47158	1/4-20x1" W/NUTS	3/8"	7158	EZG471	
47159	1/4-20x1-1/2"	3/8"	7159	EZG490	
47160	1/4-20x1-1/2" W/NUTS	3/8"	7160	EZG491	
47152	12-20x1-1/2"	1/4"	7152		
47154	12-20x1-1/2" W/NUTS	3/8"	7154		
47161	12-20x1-1/2" W/NUTS	1/2"	7161		
WOOD VERTICAL HANGER					
47163	1/4"x2"	1/4"	7163		
47203	1/4"x1"	3/8"	7203		
47165	1/4"x2"	3/8"	7165		
47167	1/4"x3"	3/8"	7167	EZG670	
47169	1/4"x4"	3/8"	7169		
47162	3/8"x2-1/2"	3/8"	7162		
47164	3/8"x2-1/2"	1/2"	7164		
CONCRETE VERTICAL HANGER					
47171	1/4"x1-1/4"	1/4"	7171		
47173	1/4"x1-1/2"	3/8"	7173		
47175	3/8"x2-3/4"	1/2"	7175		
STEEL SIDE HANGER					
47183	1/4"x20-1"	1/4"	7183	EZH155	SWDR100
47100	12-20x1-1/2"	1/4"	7200		
47101	12-20x1-1/2" W/NUTS	3/8"	7201		
47184	1/4-20x1" W/NUTS	3/8"	7184	EZH476	
47186	1/4-20x1-1/2" W/NUTS	3/8"	7186	EZH496	
47188	1/4-20x2" W/NUTS	3/8"	7188		
WOOD SIDE HANGER					
47185	1/4"x1"	1/4"	7185		
47170	1/4"x2"	3/8"	7170		
47156	1/4"x2-1/2"	3/8"	7156		
47105	1/4"x1"	3/8"	7205		
ACCESSORIES					
47195	1/4" CONCRETE SOCKET		7195		
47197	3/8" CONCRETE SOCKET		7197		
47198	1/2" CONCRETE SOCKET		7198		
80038	3/8 THREADED ROD ADAPTER				
47187	JIFFY UNIVERSAL DRIVER				

HangerMate®

THREADED ROD ANCHORING SYSTEM

Bar Code	Stock No.	Item Description	Rod Size	Steel Thick.	Qty/Box
Steel Applications— Vertical Mount—End Drilled Head					
80000	EZG160	1/4-20 x 1 #3 Point	1/4-20	.060-.250	25
80001	EZG450	1/4-20 x 1 # 2 Point	3/8-16	.060-.125	25
80002	EZG470	1/4-20 x 1 #3 Point	3/8-16	.060-.250	25
80003	EZG471	1/4-20 x 1 #3 Point w/ Nuts	3/8-16	.060-.250	25
80004	EZG490	1/4-20 x 1-1/2 #3 Point	3/8-16	.060-.250	25
80005	EZG491	1/4-20 x 1-1/2 #3 Point w/ nuts	3/8-16	.060-.250	25
80006	EZG510	1/4-20 x 1-1/2 #5 Point	3/8-16	.187-.500	25
80007	EZG511	1/4-20 x 1-1/2 #5 Point w/nuts	3/8-16	.060-.500	25
80008	EZG530	1/4-20 x 2 #3 Point	3/8-16	.060-.250	25
80009	EZG540	1/4-20 x 3 #3 Point	3/8-16	.060-.250	25
80010	EZG550	Discontinued— Use EZG 470			25
Horizontal Mount—Cross Drilled Head					
80011	EZH155	1/4-20 x 1 # 3 Point	1/4-20	.060-.250	25
80012	EZH455	1/4-20 x 1 #2 Point	3/8-16	.060-.125	25
80013	EZH475	1/4-20 x 1 #3 Point	3/8-16	.060-.250	25
80014	EZH476	1/4-20 x 1 #3 Point w/ Nuts	3/8-16	.060-.250	25
80015	EZH495	1/4-20 x 1-1/2 #3 Point	3/8-16	.060-.250	25
80016	EZH496	1/4-20 x 1-1/2 #3 Point w/ nuts	3/8-16	.060-.250	25
80017	EZH515	1/4-20 x 1-1/2 #5 Point	3/8-16	.187-.500	25
80018	EZH516	1/4-20 x 1-1/2 #5 Point w/ nuts	3/8-16	.060-.500	25
80019	EZH535	1/4-20 x 2 #3 Point	3/8-16	.060-.250	25
Wood Applications— Vertical Mount - End Drilled Head					
80020	EZG315	5/16 x 2-1/4	1/4-20		25
80021	EZG650	5/16 x 2-1/4	3/8-16		25
80022	EZG670	5/16 x 3	3/8-16		25
Horizontal Mount—Cross Drilled Head					
80023	EZH320	5/16 x 2-1/4	1/4-20		25
80024	EZH665	5-16 x 2-1/4	3/8-16		25

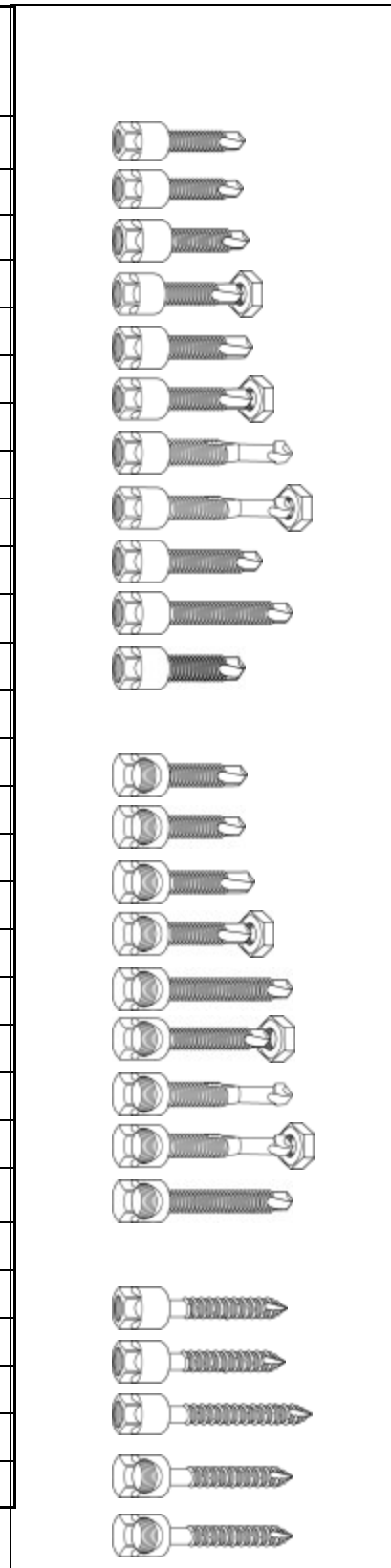

NOTE: ITEMS IN BOLD ARE STOCK.
OTHERS MAY REQUIRE MINIMUM ORDER

HangerMate®

THREADED ROD ANCHORING SYSTEM (Continued.....)

Bar Code Number	Stock No.	Item Description	Rod Size	Steel Thick.	Qty/Box	
Concrete Applications- Vertical Mount—End Drilled Head						
80025	EZG365	5-16 x 2-1/4	1/4-20		25	
80026	EZG730	5/16 x 2-1/4	3/8-16		25	
Horizontal Mount—Cross Drilled Head						
80027	EZH370	5/16 x 2-1/4	1/4-20		25	
80028	EZH735	5/16 x 2-1/4	3/8-16		25	
New! Universal Anchors for Wood, Metal, Or Concrete						
80037	EZG910	1/4 X 2 End Drilled	1/4-20		25	
80035	EZG 930	1/4 X 2 End Drilled	3/8-16		25	
80036	EZH935	1/4 X 2 Cross Drilled	3/8-16		25	
Accessories						
80038		3/8" to 1/2" Threaded Rod Adapter			25	
Installation Tools						
80030	EZE220	Drive Sleeve			1	
80031	EZE240	Drill Bit Adaptor Kit			1	
80032	EZE340	ANSI 1/4" Tanged Drill Bit for Hammer Drills			1	
80033	EZE350	ANSI 1/4" SDS Drill Bit for Rotary Hammer Drills			1	
80029		JIFFY UNIVERSAL DRIVER			1	

NOTE: ITEMS IN BOLD ARE STOCK.
OTHER ITEMS MAY REQUIRE MINIMUM ORDER.

Section 3

HVACR HARDWARE AND ACCESSORIES

- Warm Air Dampers
- Hammer On Damper Hardware
- Regulator Sets & Accessories
- Damper Regulator Dials
- Blued Panning Nails
- Aircraft Fiberglass Duct Tools
- “Jiffy” HVACR Specialty Tools

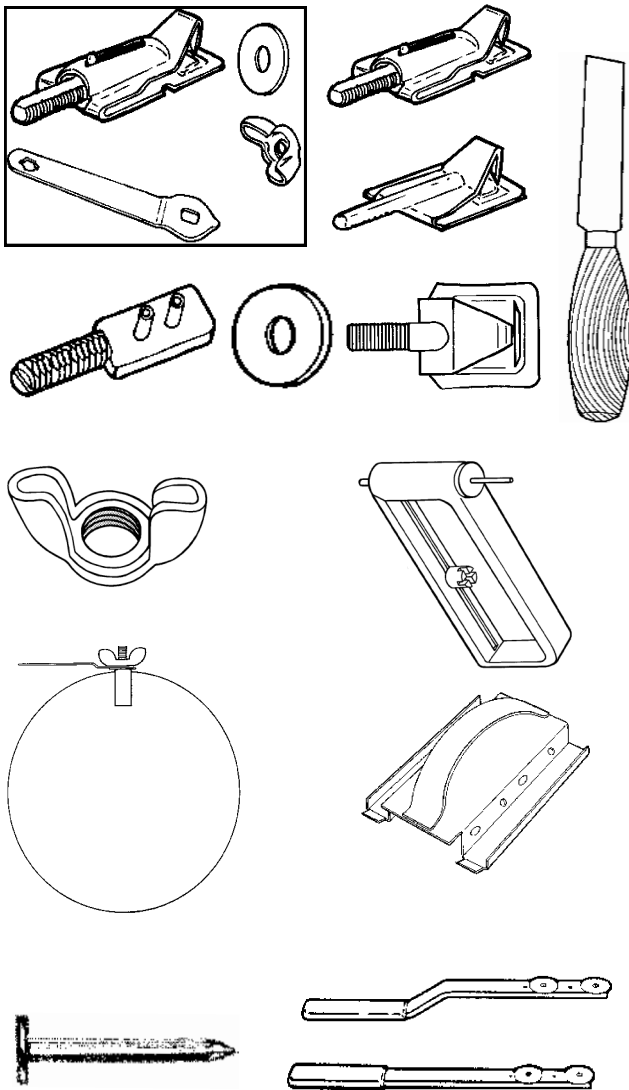

Shook carries a full line of items to meet your HVAC&R needs.

We also stock many special tools to help make your job easier and more productive. When it comes to tools, think SHOOK as your supply source.

Shook provides its own line of quality tools that you just don't find every day. **Shook "Jiffy" Tools** provide quality at outstanding prices.

“Jiffy Quick” Hammer-on Damper Hardware

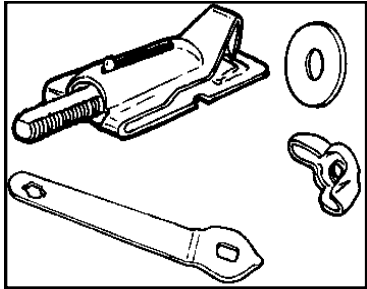

Bar Code Number	Item Description	Packaging Quantity
00004	Single Regulator Set	12 Sets / Box
Includes:	50010 5/16" Spring Bearing	
	50011 Washer	
	50012 Handle	
	50013 Wing Nut	
00005	Double Regulator Set	12 Sets / Box
Includes:	50010 5/16" Spring Bearing	
	50011 Washer	
	50012 Handle	
	50013 Wing Nut	

Damper Accessories

00010	5/16" Spring Loaded Damper Bearing	1000
00014	Plain Damper Tip	1000

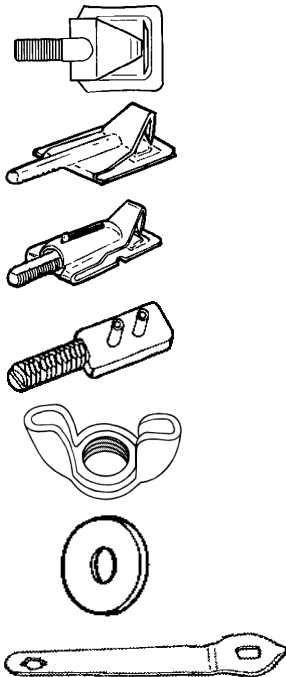

Bar Code Number	Item Description	Packaging Quantity
00054	Damper Handle	100
12436	1/4" ID Washer	100
12438	5/16" ID Washer	100
12422	1/4" Stamped Wing Nut	100
12424	5/16" Stamped Wing Nut	100
12491	5/16" Stamped Wing Nut	1000

"Jiffy Quick" Warm Air Dampers

1/4" Bearing

-Heavy Galvanized Steel
-Adjust with Screwdriver or Attached Handle

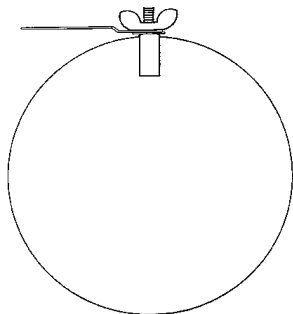

SINGLE



DOUBLE

Bar Code Number	Item Description	Packaging Quantity
00020	4" Damper Single Bearing with Attached Handle	100
00024	5" Damper Single Bearing with Attached Handle	100
00026	5" Damper Single Bearing with Wing Nut	100
00028	6" Damper - Single Bearing with Attached Handle	100
00030	6" Damper Single Bearing with Wing Nut	100
00032	6" Damper - Double Bearing with Attached Handle	100
00034	6" Damper - Double Bearing with Wing Nut	100
00314	6" Damper - Double Bearing with Attached Handle	12
00036	7" Damper Single Bearing with Attached Handle	100
00038	7" Damper - Double Bearing with Attached Handle	100
00040	7" Damper - Double Bearing with Wing Nut	100
00042	8" Damper - Single Bearing with Attached Handle	100
00044	8" Damper - Double Bearing with Attached Handle	100
00046	8" Damper - Double Bearing with Wing Nut	100
00334	8" Damper - Double Bearing with Attached Handle	12
00049	10" Damper - Double Bearing with Attached Handle	50
00360	10" Damper - Double Bearing with Attached Handle	12
00051	12" Damper - Double Bearing with Attached Handle	50
00364	12" Damper - Double Bearing with Attached Handle	12
00053	14" Damper - Double Bearing with Attached Handle	50

5/16" Spring Loaded Bearing

-Heavy Galvanized Steel
-Adjust with Screwdriver or Attached Handle

Bar Code Number	Item Description	Packaging Quantity
00458	7" Damper - Double Bearing with Attached Handle	100
00464	8" Damper - Double Bearing with Attached Handle	100
00470	9" Damper - Double Bearing with Attached Handle	50
00476	10" Damper - Double Bearing with Attached Handle	50
00482	12" Damper - Double Bearing with Attached Handle	50
00490	14" Damper - Double Bearing with Attached Handle	1
00494	16" Damper - Double Bearing with Attached Handle	1
00498	18" Damper - Double Bearing with Attached Handle	1

Note: Bold Bar Coded Items compare to other manufacturers' stock items

AMCRAFT INC. *Fiberglass Duct Tools*

Bar Code Number	Item Description	Amcraft No.	Packaging Quantity
40060	Round Hole Cutter- 3-20"	5001	1
40062	4" Duct Knife	8000	1
40066	90 V or Miter Cut Tool – Red	1100	1
40072	4-in-1 End Cut Tool - Blue	1102	1

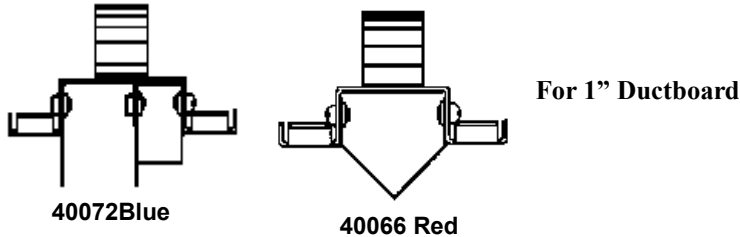
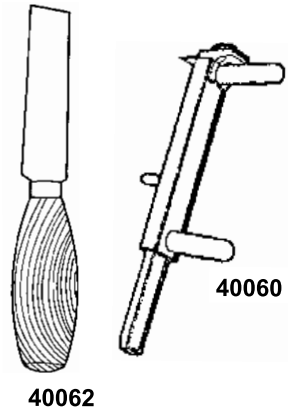

“Jiffy” HVACR Specialty Tools

Fiberglass Duct Tools

Bar Code Number	Item Description	Qty & Pkg
40081	Bostitch Model PC-4000 OC2 Out Clinch Stapler	1
40082	1/2" Staples	4M Box
40083	9/16" Staples	4M Box



Sheet Metal Hole Cutter

40014	Sheet Metal Hole Cutter – 12" Dia. Capacity	1
40000	Cutter Bit for Hole Cutter	1
40015	Pivot Pin for Hole Cutter	1

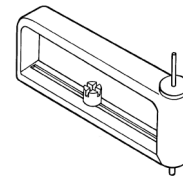

Sheet Metal Folding Tools

- Make 1" Flanges for fitting plenums, joist panning, register boots and trunk line end caps.
- Use the 3/8" depth to create folds for C-drives
- Steel seam halves are permanently joined
- Folds 24 gauge galvanized sheet metal easily

13824	8" Folding Tool - 3/8" and 1/2" Seams No. 650	1 POS
13826	12" Folding Tool - 3/8" and 1/2" Seams No. 652	1 POS
40040	12" Folding Tool - 3/8" and 1" Seams	1 POS
40042	18" Folding Tool - 3/8" and 1" Seams	1 POS
40043	24" Folding Tool - 3/8" and 1" Seams	1 POS

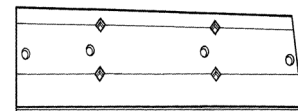

“Jiffy” HVACR Specialty Tools ... Continued

Duct Stretchers

Bar Code Number	Item Description	Packaging Quantity
40008	Duct Stretcher – Straight	1
40010	Duct Stretcher – Offset	1

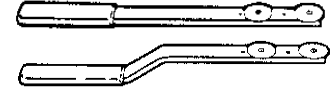

Blued Panning Nails

Bar Code Number	Item Description	Prod. No.	Packaging Quantity
00077	Panning Nails	BPN2	2 lb Box
00076	Panning Nails	BPN3	3 lb Box
00078	Panning Nails	BPN5	5 lb Box
00075	Panning Nails	BPN	50 lb Box



Awls

13839	4" Awl– Wood Handle	No. TZ8410	1 Bulk
13836	5-1/2" Awl - Cellulose acetate plastic handle	No. 902	1 Bulk
13838	5-1/2" Awl - Cellulose acetate plastic handle	No. 902C	Carded
13840	6-1/2" Awl - Professional quality -Bulk	No. 904	1 Bulk
13842	6-1/2" Awl - Professional quality	No. 904C	Carded

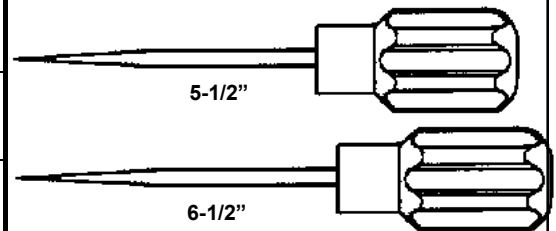

Section 44

Take the **Shook Advantage**
when purchasing Tools!



SHOOK "Jiffy" TOOLS

Shook carries a full line of...

Fairmont Metal Tongs

Kett Power Tools

Saw Blades & Hole Saws

Shook "**Jiffy**" Tools

FAIRMONT TONGS

We also stock many other hand tools to help make your job easier and more productive. When it comes to tools, think SHOOK as your supply source.

Shook provides its own line of quality tools that you just don't find every day. **Shook Jiffy Tools** provide quality and durability



SHOOK "JIFFY" TOOLS

Utility Knives & Blades

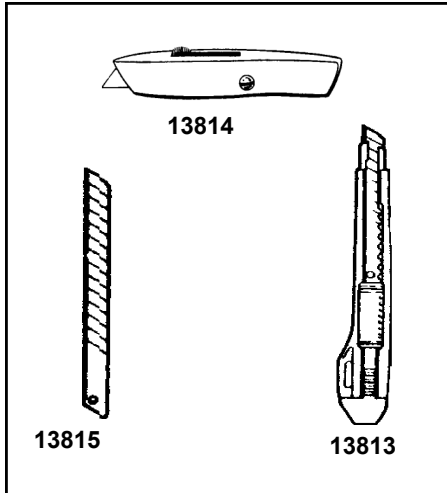

13814	3" Utility Knife No. 627	1 Bulk
13813	13 Point Snap Blade Knife	1 POS
13815	10 PK Blades for 13 Point Snap Blade Knife	1 POS
13817	7 Point Snap Blade Knife	1 POS
13818	100 PK Blades for 6" Utility Knife	1
13819	10 PK Blades for 8 Point Snap Blade Knife	1 POS
12820	5 PK Blades for 6" Utility Knife	1

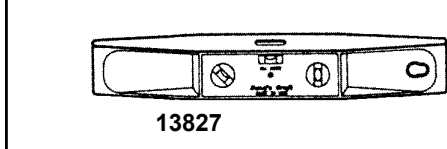

Levels			
Bar Code Number	Item Description		Qty. Pkg.
13830	9" Magnetic Torpedo Level	No. 711	1 POS



TR16F Fiberglass Handle



TR12 Hickory Handle



21 oz Steel Handle

21 oz Hickory Handle

"Jiffy" Tinner's Hammers

- Striking tool heads are forged from American-made, high carbon steel
- Tool heads are heat-treated and precision machined
- Polished steel finish
- Octagon Head-Flat striking face- Rounded Cross Pein

19300	Tinner's Riveting Hammer 168-10	TR16F	16 oz.	12-1/2"
19301	"Jiffy" Tinner's Riveting Hammer Fiberglass Handle	21FG	21 oz.	14-1/4"
19302	Tinner's Riveting Hammer 168-15	TR12	12 oz.	12-1/2"
19303	"Jiffy" Tinner's Riveting Hammer Hickory Handle	21HWD	21 oz.	14-1/4"
19305	"Jiffy" Tinner's Riveting Hammer Steel Handle		21 oz.	14-1/4"



“Jiffy” Aviation Snips

Superb Tradesman Quality at Competitive Prices

All product sleeved for hanging and display

- 13960** Left Cut, Red Handle
- 13964** Right Cut, Green Handle
- 13968** Straight Cut, Yellow Handle
- 13961** Offset, Left Cut, Right Hand, Red Handle
- 13963** Offset, Right Cut, Left Hand, Green Handle
- 13965** Long Cut
- 13967** Bulldog
- 13958** Offset Left Vertical
- 13959** Offset Right Vertical

- Meets ANSI & DIN standards
- Comfortable cushion grip
- High tensile strength pivot fastener
- Exclusive 2-tone, soft to the touch, slip resistant grips
- Drop forged chrome Molybdenum alloy steel blades hardened to 60-62 Rc

**SEE PAGE 83 FOR ASSORTMENTS



Left Cut—#13960



Straight—#13968



Right Cut—#13964



Long Cut—#13965



Offset Left Cut—#13961



Bulldog—#13967



Offset Left Vertical—#13958



Offset Right Cut—#13963

CROSS-REF.

SHOOK JIFFY SNIP	MALCO AV	MIDWEST	KLENK	WISS / COOPER
13960	AV1 53029	P6716-L	KJS1 MA7000	M1R
13964	AV2 53030	P6716-R	KJS2 MA70010	M2R
13968	AV3 53031	P6716-S	KJS3 MA70020	M3R
13961	AV6 53032	P6510-L	KOS1 MA75200	M6R
13963	AV7 53033	P6510-R	KOS2 MA75210	M7R
13967	N/A	P6716-B	KBD M5R NA	M5R
13958				
13959				



Offset Right Vertical—#13959

See page 83 for planogram info.

Sheet Metal Tools

JIFFY SHEET METAL HAND TOOLS

Bar Code	Item Description	Pkg. Qty.
13974	Offset 5 Blade Sheet Metal Crimper	1
13994	Hand Seamer, 3" Capacity	1



13974



13994

Fairmont Sheet Metal Tongs

SHEET METAL TONGS

Bar Code	Item Description	Fairmont Part #	Qty. Pkg.
43000	Fairmont Tong	MT14000	1
43002	Offset Fairmont Tong	MT14010	1
43004	Fairmont Tong with Cushion Grip	MT14020	1
43006	Offset Fairmont Tong with Cushion Grip	MT14030	1

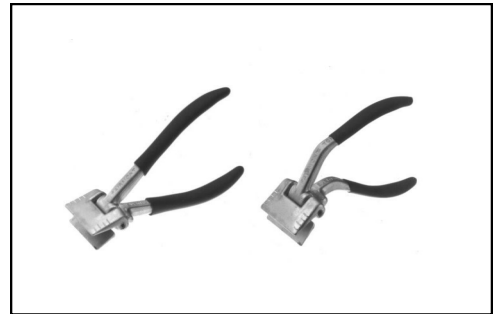

***See Page 67, 83 for Jiffy Aviation Snips

Shook "Jiffy" Swivel Head Shear

Swivel Head Sheet Metal Shear
 4.0 Amp- Variable Speed- 0-2500 RPM
 Aluminum Cutting Head Swivels 360 degrees

High Speed Steel Cutting Blades
 Capacity to 14 Gauge Sheet Metal, 16 GA Stainless Steel
 1 Year Warranty

Bar Code	Description
13903	Swivel Head Sheet Metal Shear & Case
13905	Right Blade
13907	Left Blade
13909	Center Blade
13911	Blade Kit- Includes Right, Left & Center



POWER SHEARS

Bar Code	Description	Kett #	Head	Length
13900	Electric 18 GA. Portable Power Shears, Variable Speed	KD-400	60-20	13-1/2"
13902	KD-400, Variable Speed with Steel Carrying Case	Kit#100	60-20	13-1/2"
13929	KD-400, Variable Speed with Plastic Carrying Case		60-20	13-1/2"
13956	KD-400, Variable Speed, Nibbler Attachment and Steel Case	Kit#210	60-20	13-1/2"
13936	Electric 14 GA. Power Shears	KD-440	40-20	14"
13938	KE-440 with Steel Carrying Case	Kit#340	40-20	14"
33912	Electric Variable Speed 16GA Shear	KD-442		
33926	Heavy Duty Electric 14 GA. Scissor Shears	KD-441		
13954	Nibbler Attachment for above Kett Shears	1020		
33944	Steel Carrying Case	251-4		



KD-400



KIT 100



NIBBLER

SHEAR BLADES

13912	Center Blade for KD-200	1
13914*	Left Side Knife for all 14, 16, 18 GA Shears	1
13916*	Right Side Knife for all 14, 16, 18 GA Shears	1

SHEAR BLADE KITS

Bar Code	Description	Kett Part #
13904	Heavy User Blade Kit for KD-400	Kit #101
13906	Intermediate Blade Kit for KD-400	Kit #102

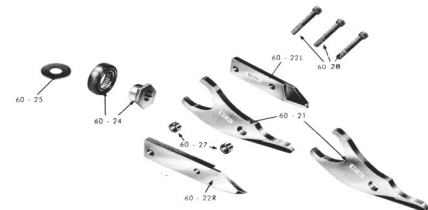

"Jiffy" Tools - Hex Key Sets

Metal Hex Key Fold-Up Sets - Standard Sets

Heat Treated, 8650 Chrome Nickel Alloy Steel
 Meet ANSI B18-3 and Fed. Spec. GGG-K-275D as applicable
 Hex steel tolerance of plus 0.000/minus 0.001

Bar Code	Description	Component Keys	Pkg. Qty.
16204	Medium Set - 9 Sizes, .050", 1/16", 5/64", 3/32", 7/64", 1/8", 9/64", 5/32", 3/16"		1 POS

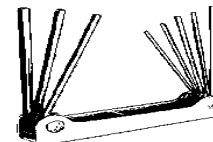

Reciprocating Saw Blades

- Matrix II Cutting Edge
- Tooth Hardness RC 65-67
- 8% Cobalt
- Vacuum Heat Treated with Special Temper Process
- Shock Resistant Teeth that Resist Stripping for Long

- Accepts More Feed Pressure for Faster Cutting and Less Distortion
- 3/4" Width .035" and .050" Thickness
- (Thicker and Wider than Some Competitors' Blades.- Greater Rigidity)

Bi-Metal Rough-In Wood and Nail - 1/2" Shank Blades

- 6 teeth per inch rough-in blades are perfect for:
- Wood cutting
 - Composition materials
 - Cutting through embedded nails in wood

- 10/14 teeth per inch rough-in blades are perfect for:
- Wood cutting
 - Composition materials
 - Plastics
 - Thin metals

Bar Code Number	Item Description Part Number	No. Teeth Per Inch	Blade Size (Length X Width X Thickness)	Pkg. Qty.
18000	Wood and Nail - RB606STT05	6	6" x 3/4" x .035"	5 Per Tube
18008	Wood and Nail - RB65006T05	6	6" x 3/4" x .050"	5 Per Tube
18010	Wood and Nail - RB95006T05	6	9" x 3/4" x .050"	5 Per Tube
18012	Wood and Nail - RB125006T05	6	12" x 3/4" x .050"	5 Per Tube
18044	Wood and Nail - RB610T05	10	6" x 3/4" x .035"	5/Tube
18050	Wood and Nail - RB6501014T05	10/14	6" x 3/4" x .050"	5/Tube
18052	Wood and Nail - RB81014T05	10/14	8" x 3/4" x .050"	5/Tube
18078	Wood and Nail - RB12501014T05	10/14	12" x 3/4" x .050"	5/Tube

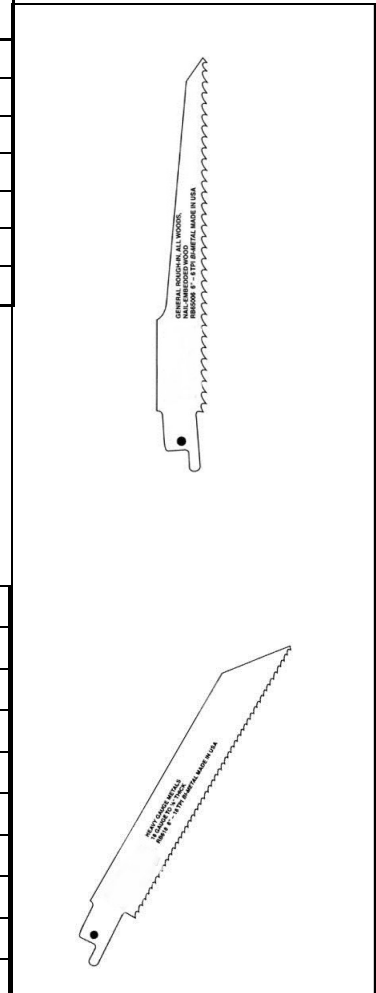

Bi-Metal Metal Cutting - 1/2" Shank Blades

- 14 - 24 Teeth Per Inch Blades are Perfect For...
- Heavy Gauge Metals 1/8" Thick and up
 - Cutting Bar Stock and Angle Iron
 - Cutting Thick Conduit, Pipe and Tubing
 - Cutting Channel Iron

18086	Heavy Duty Metal - RB614T05	14	6" x 3/4" x .035"	5 Per Tube
18088	Heavy Duty Metal - RB1214T05	14	12" x 3/4" x .035"	5 Per Tube
18090	Heavy Duty Metal - RB814T05	14	8" x 3/4" x .035"	5/Tube
18092	Heavy Duty Metal - RB418T05	18	4" x 3/4" x .035"	5/Tube
18094	Heavy Duty Metal - RB618T05	18	6" x 3/4" x .035"	5 Per Tube
18096	Heavy Duty Metal - RB1218T05	18	12" x 3/4" x .035"	5 Per Tube
18098	Heavy Duty Metal - RB818T05	18	8" x 3/4" x .035"	5 Per Tube
18100	Heavy Duty Metal - RB424T05	24	4" x 3/4" x .035"	5/Tube
18102	Heavy Duty Metal - RB624T05	24	6" x 3/4" x .035"	5 Per Tube
18284	Heavy Duty Metal—RB65018T05	18	6" x .050"	5/Tube

"JIFFY" HEX MAGNETIC CHUCK ASSORTMENTS



BARCODE #	DESCRIPTION	QTY.	PRICE EACH	EXTENDED
10016	1/4x1-3/4	24	\$1.55	\$37.20
10022	5/16x1-3/4	24	\$1.67	\$40.08
10046	1/4x2-9/16	6	\$1.92	\$11.52
10050	5/16x2-9/16	6	\$2.07	\$12.42
10064	1/4x4	6	\$3.26	\$19.56
10072	5/16x4	6	\$4.60	\$27.60
10068	1/4x6	6	\$4.35	\$26.10
10076	5/16x6	6	\$4.75	\$28.50
10575	Quick Change Adapter	6	\$2.59	\$15.54
10114	DC10 Chuck Assortment	6	\$19.75	\$118.50
10110	COMPLETE PLANOGRAM A - 96 PIECES			\$337.02

BARCODE #	DESCRIPTION	QTY.	PRICE EACH	EXTENDED
10016	1/4x1-3/4	12	\$1.55	\$18.60
10022	5/16x1-3/4	12	\$1.67	\$20.04
10046	1/4x2-9/16	6	\$1.92	\$11.52
10050	5/16x2-9/16	6	\$2.07	\$12.42
10064	1/4x4	6	\$3.26	\$19.56
10072	5/16x4	6	\$4.60	\$27.60
10068	1/4x6	6	\$4.35	\$26.10
10076	5/16x6	6	\$4.75	\$28.50
10114	DC10 Chuck Assortment	6	\$19.75	\$118.50
10112	COMPLETE PLANOGRAM B - 66 PIECES			\$282.84

****10114**—each kit includes 1 each: 1/4x1-3/4, 1/4x2-9/16, 1/4x4, 5/16x1-3/4, 5/16x2-9/16, 5/16x4, 5/16x6, 3/8x1-3/4, & quick change adapter.

BARCODE #	DESCRIPTION	QTY.	PRICE EACH	EXTENDED
10016	1/4x1-3/4	12	\$1.55	\$18.60
10022	5/16x1-3/4	12	\$1.67	\$20.04
10046	1/4x2-9/16	6	\$1.92	\$11.52
10050	5/16x2-9/16	6	\$2.07	\$12.42
10064	1/4x4	6	\$3.26	\$19.56
10072	5/16x4	6	\$4.60	\$27.60
10068	1/4x6	6	\$4.35	\$26.10
10076	5/16x6	6	\$4.75	\$28.50
10115	COMPLETE PLANOGRAM C - 60 PIECES			\$164.34

\$10.00—display pegboard & hooks (a \$25.00 value).

Section 5

ELECTRICAL COMPONENTS & ACCESSORIES

Take the ***Shook Advantage*** when purchasing Electric Components and Accessories!

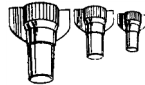
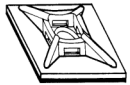
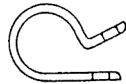
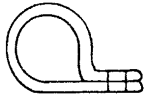

Shook carries a full line of...

Solderless Terminals & Wire Connectors

Nylon Cable Ties

Cable Clamps & Accessories

We also stock many hand tools to help make your job easier and more productive. When it comes to tools, think SHOOK as your supply source.

Shook provides its own line of quality tools that you just don't find every day. ***Shook Tools*** provide quality and serviceability at outstanding prices.



"Jiffy Nuts" Wire Connectors

COLOR CODED
FLAME RETARDANT
SPRING INSERT

RIBBED WIRE CONNECTORS

BAR CODE NUMBER	DESCRIPTION	RANGE	COLOR	PKG QTY
27000	RIBBED WIRE CONNECTOR	Min 2 #22 Max 2 #16	Gray	100 POS
27006	RIBBED WIRE CONNECTOR	Min 2 #22 Max 2 #16	Gray	500 PL BOX
27010	RIBBED WIRE CONNECTOR	Min 2 #22 Max 3 #16	Blue	100 POS
27012	RIBBED WIRE CONNECTOR	Min 2 #22 Max 3 #16	Blue	100 PL HANG PK
27016	RIBBED WIRE CONNECTOR	Min 2 #22, Max 3 #16	Blue	500 PL BOX
27020	RIBBED WIRE CONNECTOR	Min 1 #18, 1-#20, Max 4 #16 & 1 #20	Orange	100 POS
27022	RIBBED WIRE CONNECTOR	Min 1 #18, 1-#20, Max 4 #16 & 1 #20	Orange	100 PL HANG PK
27024	RIBBED WIRE CONNECTOR	Min 1 #18, 1-#20, Max 4 #16 & 1 #20	Orange	20 POS
27026	RIBBED WIRE CONNECTOR	Min 1 #18, 1-#20, Max 4 #16 & 1 #20	Orange	500 PL BOX
27032	RIBBED WIRE CONNECTOR	Min 3 # 20, Max 2 #10 & 1 # 12	Yellow	100 POS
27034	RIBBED WIRE CONNECTOR	Min 1 #14 & 2 #18, Max 1 #10 & 2 # 14	Yellow	100 PL HANG PK
27036	RIBBED WIRE CONNECTOR	Min 1 #14 & 2 #18, Max 1 #10 & 2 # 14	Yellow	20 POS
27044	RIBBED WIRE CONNECTOR	Min 3 #18, Max 3 #10	Red	100 POS
27046	RIBBED WIRE CONNECTOR	Min 3 #18, Max 3 #10	Red	100 PL HANG PK
27047	RIBBED WIRE CONNECTOR	Min 3 #18, Max 3 #10	Red	25 POS
27048	RIBBED WIRE CONNECTOR	Min 3 #18, Max 3 #10	Red	10 POS

DOUBLE WING WIRE CONNECTOR

27074	RIBBED WIRE CONNECTOR	Min 2- # 18, Max 3- #12	Yellow	50 PL HANG PK
-------	-----------------------	-------------------------	--------	---------------

Bar Code Number	Stud Size	Description	AWG	Color	Pkg. Qty.
27520	.250"	Full Vinyl Disconnect	22-18	Red	100 Bag
27522	.250"	Full Vinyl Disconnect	22-18	Red	100 PI Box
27524	.250"	Full Vinyl Disconnect	22-18	Red	20 POS
27540	.250"	Full Vinyl Disconnect	16-14	Blue	20 POS
27542	.250"	Full Vinyl Disconnect	16-14	Blue	500 PI Box

VINYL INSULATED FEMALE DISCONNECTS

Bar Code Number	Stud Size	Description	AWG	Color	Pkg. Qty.
27568	.187"	Vinyl Insulated Disconnect	22-18	Red	100 Bag
27584	.250"	Vinyl Insulated Disconnect	22-18	Red	100 Bag
27586	.250"	Vinyl Insulated Disconnect	22-18	Red	100 PI Box
27600	.187"	Vinyl Insulated Disconnect	16-14	Blue	100 Bag
27616	.250"	Vinyl Insulated Disconnect	16-14	Blue	100 Bag
27618	.250"	Vinyl Insulated Disconnect	16-14	Blue	100 PI Box
27624	.250"	Vinyl Insulated Disconnect	12-10	Yellow	100 Bag
27626	.250"	Vinyl Insulated Disconnect	12-10	Yellow	100 PI Box

VINYL INSULATED BUTT CONNECTORS BUTTED SEAM

Bar Code	Item Description	AWG	Color	Pkg. Qty.
27982	Vinyl Insulated Butt Connector	22-18	Red	100 Bag
27990	Vinyl Insulated Butt Connector	16-14	Blue	100 Bag
27998	Vinyl Insulated Butt Connector	12-10	Yellow	100 Bag

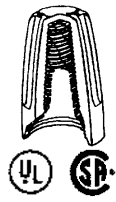
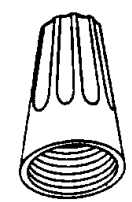

Disconnects

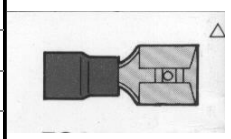
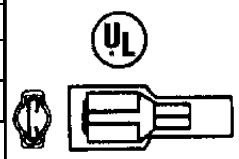

“Jiffy” Cable Accessories

NYLON CABLE TIES

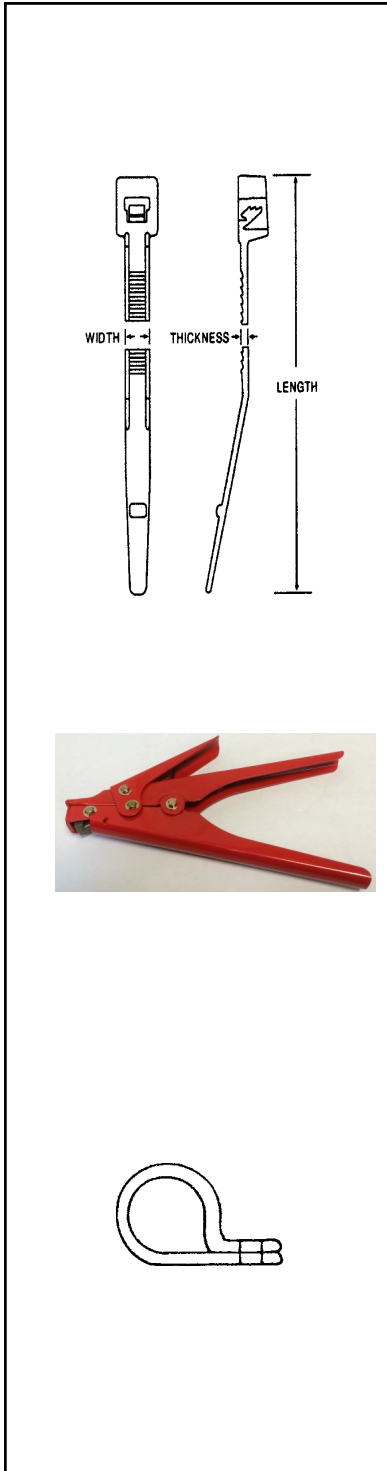

Bar Code #	Item Description	Color	Length Inch	Width	Thick	Tensile lbs.	Pkg. Qty.
14900	Nylon Wire Tie	Natural	4"	.094"	.042"	18	1000 PL Bag
14902	Nylon Wire Tie	Natural	6"	.094"	.042"	18	100 PI Bag
14104	Nylon Wire Tie	Natural	7"	.178"	.053"	50	100 PI Bag
14930	Nylon Wire Tie	Natural	7"	.178"	.053"	50	1000 PI Bag
14108	Nylon Wire Tie	Natural	11"	.178"	.053"	50	100 PI Bag
14110	Nylon Wire Tie	Natural	14"	.178"	.053"	50	100 PI Bag
14940	Nylon Wire Tie	Black UV	6"	.094"	.042"	18	100 PI Bag
14942	Nylon Wire Tie	Black UV	6"	.094"	.042"	18	1000 PI Bag
14944	Nylon Wire Tie	Black UV	8"	.094"	.042"	18	100 PI Bag
14112	Nylon Wire Tie	Black UV	7"	.178"	.053"	50	100 PI Bag
14116	Nylon Wire Tie	Black UV	11"	.178"	.053"	50	100 PI Bag
14970	Nylon Wire Tie	Black UV	14"	.178"	.053"	50	500 PI Bag
14120	Nylon Wire Tie	Natural	15"	.300"	.075"	120	100 PI Bag
14124	Nylon Wire Tie	Black UV	15"	.300"	.075"	120	100 PI Bag
14128	Nylon Wire Tie	Natural	24"	.339"	.084"	120	50 PI Bag

40036	Jiffy Cable Tie Tensioner w/ Cutoff	1 Ea
-------	-------------------------------------	------

“Jiffy” Cable Accessories

NYLON CABLE CLAMPS

Bar Code Number	Item Description	Size	Pkg. Qty.
27136	Nylon Cable Clamp	1/4"	100 Bag/Box
27138	Nylon Cable Clamp	1/4"	100 PI Box
27140	Nylon Cable Clamp	1/4 "	20 POS
27152	Nylon Cable Clamp	3/8"	100 Bag/Box
27160	Nylon Cable Clamp	1/2"	100 Bag/Box
27164	Nylon Cable Clamp	1/2"	20 POS
27184	Nylon Cable Clamp	3/4"	100 Bag/Box

Section 66

PLUMBING ACCESSORIES & MISC. PRODUCTS

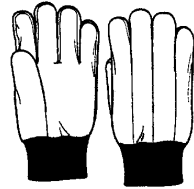
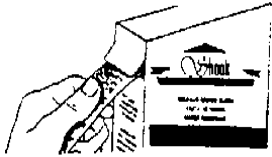

-Abrasive Cloth

-Abrasive Mesh

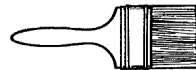
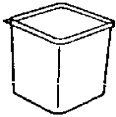

-REMS Pipeworking Equip.

-Gloves

-Tool Boxes & Totes

-Packaging Containers



-Lubricants

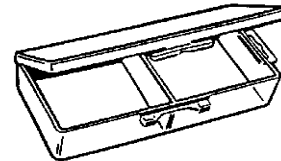

Product Packaging Key

POS - Individually packaged for POS (boxed, bagged or carded) for hanging display

CB - Counter Bowl (Plastic)

D - Multiple Display Card

HP - Hang Pack - (Clear Plastic Hang Box or Bag)

PL - Plastic Box or Plastic Tub

PB - Plastic Bucket with Handle

C - Chipboard Box

B - Bulk Packaged - (Loose - Bagged - Boxed)

JP - Jiffy Pail, Handle, & Lid

All Bulk Packaging includes quantity, product description and barcode number

Custom Packaging and labeling available. Ask for our information sheets for details.

“Jiffy” Tools - Plumber’s Supplies

Plumber’s Abrasive Roll

Aluminum Oxide Cloth – Closed Coat, 120 grit, Brown Cloth

-Aluminum oxide, high quality 120 grit, abrasive cloth to thoroughly clean copper and steel tubing

-Works wet or dry

-Exceeds industry standards for abrasive cloth

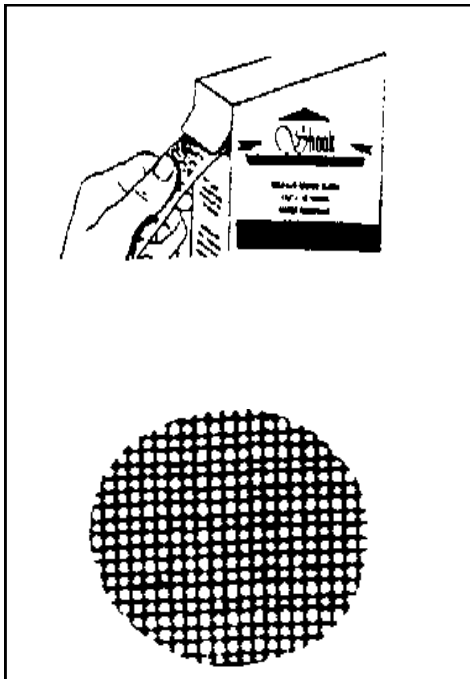

Bar Code Number	Item Description	Quantity
13800	Abrasive Cloth – 1-1/2” x 10 YD	1 Each
13802	Abrasive Cloth – 1-1/2” x 25 YD	1 Each

Open Mesh Sand Screen Cloth – 180 Grit – 100% Waterproof

-Aluminum oxide grain resin bonded to synthetic nylon cloth

-100% waterproof, but can also be used for dry sanding by hand or with portable tools

-Most effective where clogging is a problem, such as soft materials

13806	Abrasive Cloth – 1-1/2” x 10 YD	1 Each
-------	---------------------------------	--------

“Jiffy” Threaded Rod Cutter

-Precision clean cut design protects threads

-No cleaning threads– Just screw on nuts— Easy to replace blade

15359	Threaded Rod Cutter– 3/8”	1
15361	Dies for Threaded Rod Cutter	1
15365	Dual Threaded Rod Cutter– 3/8” & 1/2”	1
15363	Ratcheting Threaded Rod Cutter– 3/8”	1

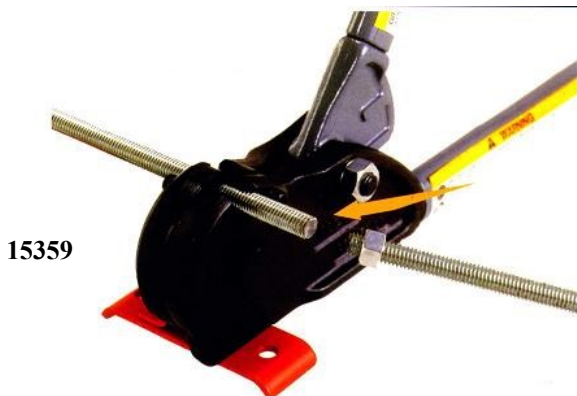

15359



15365

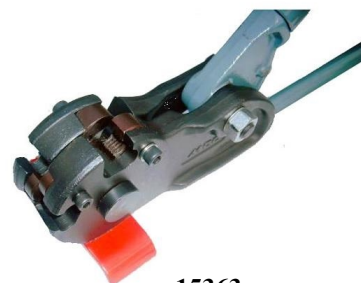

15363

REMS**MACHINES AND TOOLS FOR PIPEWORKING**

DUE TO FLUCTUATION OF THE EURO, PLEASE CALL FOR NET PRICING

Bar Code	Model	Description	REMS P/N	Sizes/Capacity	Pkg Qty
00650	Swing	Hand Tube Bender Set For soft copper	153021	3-8", 1/2", 5/8", 3/4", 7/8"	1
00729	Amigo 2 Set	Electric Die Stock for Pipe Threading	540021	1/2", 3/4", 1", 1-1/4", 1-1/2", 2"	1
00730	Amigo Set	Electric Die Stock for Pipe Threading	540024	1/2"-1"	1
00731	Amigo 2 Compact	Electric Die Stock for Pipe Threading	540026	1/2", 3/4", 1", 1-1/4"	1
00859	Amigo 2 Compact	Electric Die Stock for Pipe Threading	540027		
00735	Panther ANC VE	Universal Electric Reciprocating Saw 1 Blade Included	560026	Cuts Steel Pipe to 6"	1
00864	Akku-Press A	Cordless Press including tongs thru 2"	571013		1
00770	Power Press SE	Universal Corded Press for all Common Pressfitting Systems. Pressing Tongs Sold Separately	572111		1
00863	Akku-Press ACC	Universal Corded Press including tongs thru 2"	571014		1
00776	Curvo Set	Electric Pipe Bender	580024	3/8" - 7/8"	1
00164	Spezial	Water base Thread Cutting Oil	140105	20.3 oz. Spray	1
00644	Spezial	Water base Thread Cutting Oil	140100	1.32 Gal.	1

**Amigo 2****Swing Bender****Akku-Press****Curvo Electric Bender****Hot Dog 2****Spezial Cutting Oil**

Please ask for a REMS catalog for full details on these and other products.

Jiffy Copper Tubing Bender Kit

- Bend 3/8" to 7/8" Soft Copper Tubing
- Also Bends Multi-Layer Composite Tubes 10 mm thru 22mm
- Includes Case, Tubing Cutter and Reamer

**00902 Jiffy Tubing Bender****1 Ea.**

www.shookmfg.com

Packaging Containers

Plastic Containers

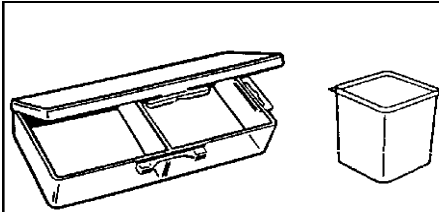

Bar Code Number	Item Description	Quantity Packaging
40001	Plastic Container – 1 Pint	36
40003	Plastic Container – 1-1/2 Pint	30
40005	Plastic Container – 1 Quart	24
40007	Plastic Container – 2 Compartment	1
40009	Plastic Container – 6 Compartment	1

“Jiffy” Lubricants

“BLASTER”

PRODUCTS

Bar Code Number	Item Description	B'laster Part No.	Pkg. Qty
09002	PB Penetrating Catalyst - 11 oz.	1-PB-16	12

“Jiffy” Safety Apparel

GLOVES

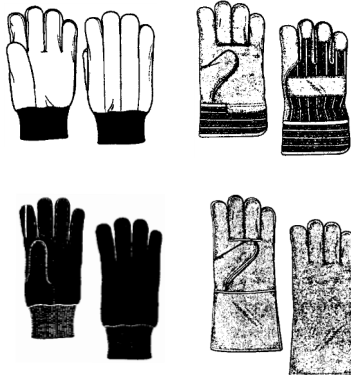

Bar Code Number	Item Description	Stock No.	Pkg. Qty.
20007	String Knit PVC Dots Both Sides	7460	1
20080	Gloves - Blue Latex Coating String Knit	708SLC	1
20009	Brown Jersey-100% Cotton	7500	1
20019	100% Kevlar Knit Double Dot	19800	1
20031	Split Leather Palm Knit	3000	1
20060	Heavy Foam Insulated PVC Orange Safety Cuff	9111	1

OTHER STYLES AVAILABLE IN CASE QUANTITIES. REQUEST SEPARATE FLYER

ADHESIVE AND PAINT BRUSHES

Pure white natural bristles
Unfinished, sanded wood handle

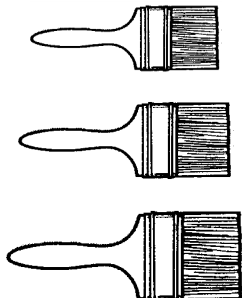

Bar Code Number	Item Description	Pkg. Qty.
14222	1" brush - wood handle 36/Box	1 Box
14226	2" brush - wood handle 24/Box	1 Box
14230	3" brush - wood handle 12/Box	1 Box



REMS SPEZIAL

Here is your chance to try a recognized German product accepted worldwide.

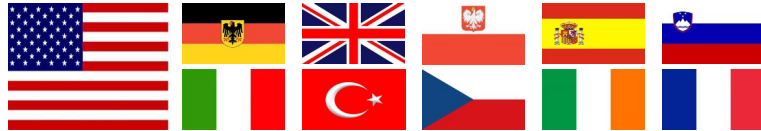

Suitable for all threading and sawing applications

- Steel, stainless, non-ferrous metals, and plastic
- High alloyed
- Mineral based
- CFC & ozone friendly
- Water clean-up
- Large 21.2 ounce spray can

SEE PAGE 77 FOR INFORMATION ON OTHER REMS PRODUCTS.

“Jiffy” Copper Tubing Bender Kit



Bends 3/8" to 7/8" Soft Copper Tubing

Also Bends Multi-Layer Composite Tubes 10 mm thru 22mm

Includes Case, Tubing Cutter and Reamer

00902

“Jiffy” Tubing Bender

1 Ea.

SHOOK MANUFACTURED PRODUCTS, INC.

PRIVATE LABEL BRAND PROGRAMS

- Low inventory requirements - program minimums as low as 50 units per size and style
- No additional charge for artwork development
- Your company logo or brand identification and part number
- No charge for bar coding

PROGRAM BASICS:

- Establish items to be private labeled, place a blanket order for the agreed upon units per size and style.
- Shook will build and release product against the distributor's incoming orders. When the amount released reaches 50% of the blanket order, Shook will automatically rebuild to the agreed upon stocking amount.
- The distributor is obligated to provide Shook with an agreement to take any private label stock not released over a six month period.
- Shook will notify the distributor's stocking status at six month intervals, thus providing an opportunity for the distributor to rebalance requirements.

ANCHOR KIT ASSORTMENT



BAR CODE	ANCHOR	SCREW	TYPE	BIT DIA	PCS / KIT	# KITS
12690	ASSORTMENT					48
CONTAINS:						
12500	3/16 X 3/4	6 X 3/4	PAN HEAD	3/16	100	6
12502	3/16 X 7/8	8 X 1	PAN HEAD	3/16	100	6
12504	1/4 X 1	10 X 1	PAN HEAD	1/4	100	6
12506	1/4 X 1	10 X 1-1/4	PAN HEAD	1/4	100	6
12526	1/4 X 1	10 X 1	1/4 HEX HD	1/4	100	6
12530	1/4 X 1	10 X 1-1/4	1/4 HEX HD	1/4	100	6
12570	PLASTIC EZ-ANCHOR	8 X 1	PAN HEAD	N/A	25	6
12572	METAL EZ-ANCHOR	8 X 1	PAN HEAD	N/A	25	6

"JIFFY" Aviation Snip Assortments



All Items Sleeved for Hanging



13957 38 Piece Assortment

Contains:

13960	Left Cut, Red Handle	6
13964	Right Cut, Green Handle	6
13968	Straight Cut, Yellow Handle	2
13961	Offset, Left Cut, Red Handle	6
13963	Offset, Right Cut, Green Handle	6
13959	Offset Right Vertical	2
13958	Offset Left Vertical	2
13967	Bulldog	2
13965	Long Cut	2
13974	Offset 5 Blade Crimper	2
13994	3" Straight Hand Seamer	2



13953 30 Piece Assortment

Contains:

13960	Left Cut, Red Handle	6
13964	Right Cut, Green Handle	6
13968	Straight Cut, Yellow Handle	2
13961	Offset, Left Cut, Red Handle	6
13963	Offset, Right Cut, Green Handle	6
13974	Offset 5 Blade Crimper	2
13994	3" Straight Hand Seamer	2



SEE PAGE 67 FOR MORE PRODUCT DETAILS

**FREE FREIGHT ON
COMPLETE ASSORTMENTS**

LIMITED LIFETIME WARRANTY

www.shookmfg.com

REFRIGERATION SERVICE TOOL PLANOGRAM



BAR CODE	DESCRIPTION	QTY.
10510	COMPLETE PLANOGRAM	48 PC.
CONTAINS:		
10557	4 PIECE SERVICE TOOL KIT- INCLUDES 10554, 10556, 10550, 10551	6
10567	2 PIECE SERVICE TOOL KIT- INCLUDES 10556, 10550	6
10556	COMBO RATCHET TOOL- 5-7/32" LONG SQ DRIVE 3/8 & 5/16, AND 1/4 & 3/16	6
10554	COMBO RATCHET TOOL- 7" LONG SQ DRIVE 1/4 & 3/16, AND SQ DRIVE 9/16 & 1/2	6
10555	OFFSET COMBO RATCHET TOOL -5-7/32: LONG SQ DRIVE 3/8 & 5/16, AND 1/4 & 3/16	6
10550	3/16 REFRIGERATION HEX INSERT BIT	12
10551	5/16 REFRIGERATION HEX INSERT BIT	6

Index	Page		
		Drywall Screws	38
		Duct Knives	63
		Duct Stretchers	64
		Ductboard Tools	63
		Electric Accessories	73-74
		Electrical Terminals	73
		Expansion Shield Anchors	41
		EZ Anchors	49
		Fairmont Tongs	68
		Fender Washers	44
		Flat Washers	42, 44
		Folding Tools	63
		Framing Screws	37
		Gloves	78
		Hammer Drill Bits	54
		Hammers	66
		Hand Tools	65-70
		Hanger Bolt Driver	6
		Hangermate Rod Hangers	58-59
		Hex Cap Screws	55
		Hex Chucks	2-4, 6-7
		Hex Drivers / Extensions	6
		Hex Key Sets	69
		Hex Nuts	43
		Hex Power / Insert Bits	10-15
		Hex Power Bit Adaptor	6
		High Hat Screws ***NEW***	25, INSIDE BACK COVER
		Hole Cutters	63
		Insert Bits	10-13
		Impact Chucks	5
		J-Bolts	55
		Jiffy Chucks	2-7
		Jiffy Chuck Assortments & Displays	7, 17, 71
		Jiffy Grip Chucks	5
		Jiffy Nuts Wire Connectors	73
		Jiffy Pails	25, 33
		Jiffy Point Screws	19-28
		SEE NEXT PAGE	
Abrasive Cloth, Plumber's Roll	76		
Abrasive Mesh	76		
Adhesive Brushes	78		
Anchor Kits	48-49, 82		
Anchors	40-41, 47-49		
Assortments	50 -51, 82-84		
Aviation Snips	67		
Awls	64		
Bell Hanger Drill Bits	54		
Bi-Metal Saw Blades	70		
Bit Holders	9		
Bit Kits	12		
B'laster Penetrants	78		
Blued Panning Nails	64		
Bonded Sealing Washers	33		
Bulldog Snips	67		
Butt Connectors	73		
Cable Clamps - Nylon	74		
Cable Ties	74		
Carriage Bolts	55		
Chemicals & Lubricants	77-78		
Clutch Bits	14		
Combo Pan Head Sheet Metal Screws	35		
Concrete Screw Installation Kit	40		
Concrete Screw Drill Bits	39		
Concrete Screws	39		
Conical Plastic Anchors	47		
Coupling Nuts	46		
Crimpers	68		
Dampers, Damper Hardware	61-62		
Deck Screws	38		
Digi-Cool	16		
Disconnects	73		
Double End Drill Bits	51		
Drill Bits	51-54		
Drill Bits w Hex Power Shank	53-54		
Drilltip (Bit Tip) Screws	29-34		
Drilltip (Bit Tip) Screws - Hex Slotted	32		
Drive Extensions	6		
Drive Pins	47		
Drive Pin Setting Tool	47		
Drop-In Anchors	40		

Index

INDEX	PAGE		
Jiffy Quick Change Extension	6	Saw Blades	70
Jiffy Tapping Screws	34	Screw Assortments	50-51
Jiffy Power Shears	69	SDS Hammer Drill Bits	54
Jiffy Aviation Snips	67, 83	Sealing Washers	33
Jiffy Point High Hat Screws (Inside Back Cover)		Seamers	68
		Self Drilling Screws (Drilltip)	29-34
		Self Piercing Screws	34-37
Kett Power Tools	69	Setting Tools	40
Knives, Ductboard	63	Sheet Metal Tools	63-64, 68
		Sleeve Anchors	40
Lead Anchors	41	Spade Wood Bits	53
Lock Nuts	43	Stainless Steel Screws	34
Lock Washers	44	Staplers	63
Lubricants	71, 77-78	Staples, Ductboard	63
		Step Drills	53
Magnetic Nut Drivers	2-7	Stove Bolts	42
Masonry Drill Bits	52	Super Jiffy Point Screws	27
Masonry Drill Bits w Hex Power Shank	53		
		Tap Bolts	55
Nutsetters- Jiffy Chucks	2-7	Tapping Screws (Combo Pan Head)	35
Nylon Wire Ties	74	Terminals, Electrical	78-79
		Thread Cutting Oil	77, 79
Packaging Containers	78	Threaded Rod & Cutter	46
Painted Speed Screws	36-37	Tinner's Hammers	66
Planogram Displays	82-84	Tin Snips, Aviation	67, 69, 83
Plumber's Abrasive Roll	76	Toggle Bolts	47
Power Bits	13-14	Toggle Wings	47
Power Shears	69	Torpedo Levels	66
Private Label Program	81 ***NEW	Tubing Bender	77, 80
Quick Change Adapters	6-7	Vertigo Rod Hangers & Kits	56-57
Quick Change Power Extensions	6		
		Warm Air Dampers	62
Reciprocating Saw Blades	70	Washers	33, 42, 44
Refrigeration Analyzer	16	Wedge Anchors	41
Refrigeration Bits	15	Wing Nuts	43
Refrigeration Service Tools & Kits	15, 16, 84	Wire Nuts	73
Refrigeration Wrenches	15	Wood Screws	37
Register Screws	28	Wrenches, Refrigeration	15, 84
REMS Pipeworking Tools	77		
Rivet Tools	45		
Rivets	44-45		
Rod Hangers	40		
Rod Hanger Cross Reference	57		

JIFFY POINT & DRILTIP HIGH HAT HEAD SCREWS

-SHARP DRILL POINT
-NO WALKING
-EASIER PENETRATION.
-FOR USE ON UP TO 3/16"
THICK STEEL.

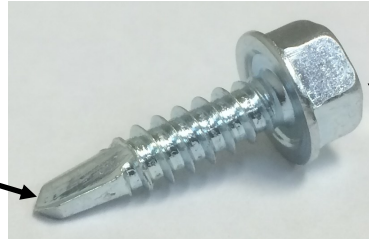

-HEX HEAD UP TO 35%
HIGHER THAN STANDARD
-MORE SECURE DRIVING
OF SCREW

ZINC PLATED

BAR CODE	DESCRIPTION	HEX HEAD	PKG. QTY
30731	10 X 3/4 HIGH HAT DRILTIP SCREW	5/16"	100 BOX
30733	10 X 3/4 HIGH HAT DRILTIP SCREW	5/16"	500 PL BOX
30737	10 X 3/4 HIGH HAT DRILTIP SCREW	5/16"	500 PL JAR W/ CHUCK
30739	10 X 3/4 HIGH HAT DRILTIP SCREW	5/16"	1M BOX
11285	10 X 3/4 HIGH HAT DRILTIP SCREW	5/16"	6M BULK
11291	10 X 3/4 HIGH HAT DRILTIP SCREW	5/16"	6M JIFFY PAIL

-SHARP HARDENED POINT
FOR EASY PENETRATION
-THREAD DESIGNED TO HOLD
TIGHT

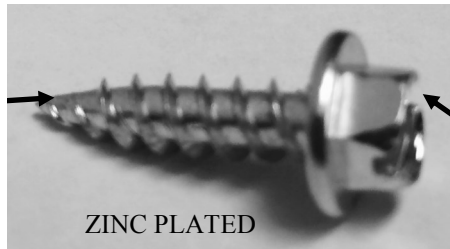

-SLOTTED HEX HEAD UP TO 35%
HIGHER THAN STANDARD
-MORE SECURE DRIVING OF
SCREW.

1/4" HEX HEAD W/ 5/16" WASHER

ZINC PLATED

BAR CODE	DESCRIPTION	HEX HEAD	PKG. QTY
10709	10 X 1/2 HIGH HAT JIFFY POINT SCREW	1/4"	100 BOX
10711	10 X 1/2 HIGH HAT JIFFY POINT SCREW	1/4"	500 PL BOX
10713	10 X 1/2 HIGH HAT JIFFY POINT SCREW	1/4"	5M JIFFY PAIL
10715	10 X 1/2 HIGH HAT JIFFY POINT SCREW	1/4"	10M BULK
10735	10 X 3/4 HIGH HAT JIFFY POINT SCREW	1/4"	25 HP
10737	10 X 3/4 HIGH HAT JIFFY POINT SCREW	1/4"	100 BOX
10739	10 X 3/4 HIGH HAT JIFFY POINT SCREW	1/4"	100 HP
10755	10 X 3/4 HIGH HAT JIFFY POINT SCREW	1/4"	500 PL BOX
10759	10 X 3/4 HIGH HAT JIFFY POINT SCREW	1/4"	1M PL BOX
10767	10 X 3/4 HIGH HAT JIFFY POINT SCREW	1/4"	1M PL BOX W/ CHUCK
10731	10 X 3/4 HIGH HAT JIFFY POINT SCREW	1/4"	9M JIFFY PAIL
10733	10 X 3/4 HIGH HAT JIFFY POINT SCREW	1/4"	9M BULK
10701	10 X 1 HIGH HAT JIFFY POINT SCREW	1/4"	6M BULK
30687	10 X 1-1/2 HIGH HAT JIFFY POINT SCREW	1/4"	100 BOX
30681	10 X 1-1/2 HIGH HAT JIFFY POINT SCREW	1/4"	500 PL BOX
10717	10 X 2 HIGH HAT JIFFY POINT SCREW	1/4"	100 BOX
10719	10 X 2 HIGH HAT JIFFY POINT SCREW	1/4"	500 PL JAR
10707	10 X 2 HIGH HAT JIFFY POINT SCREW	1/4"	2M BULK

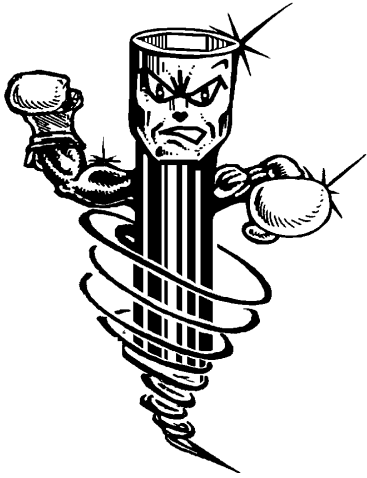

Manufactured Products, Inc.
P.O. Box 15058
1017 Kenmore Blvd.
Akron, OH 44314

