

## QUADRIVE CONCRETE SCREW ANCHORS

**"STOP THE SNAPPING"**  
*It's a Screw and an Anchor*

Large fillet under head to fit 3/16" and 1/4" holes provides greater driving strength

Fluted, interrupted threads aid tapping into masonry products

Hilt threads for faster application

Silver color to match conduit, strap and concrete

We will be glad to send a sample bag of 10 pieces to our Distributors for their customer trials.  
**Please specify size!**

A coating is applied after heat-treating to provide anti-corrosion protection. The coating is a RoHs compliant mechanical zinc coating that offers 2000 hours to 15% red rust corrosion in salt spray testing performed to ASTM B117 specifications.

Metallics offers our Distributor/Contractor users an alternative to the blue color of standard concrete screws. Silver color is cosmetically appealing when used with zinc plated or stainless steel brackets, electrical fixtures or conduit.

### The QuaDrive

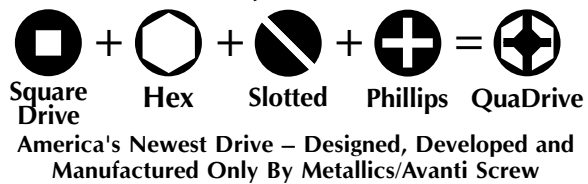





Made by  
Avanti Screw, Inc.,  
A Metallics Affiliate



# Metallics

An **AMERICAN** Source For Premier  
and Innovative Fasteners and Anchors

# ANCHORING DEVICES

-  Hex
-  Slotted
-  Phillips
-  Square Drive

Four drives  
in one head



## QUADRIVE CONCRETE SCREW KITS

MADE IN USA



Made by  
Avanti Screw, Inc.,  
A Metallics Affiliate

STEEL MECHANICAL ZINC /CORROSION RESISTANT

PART#	UPC#	SIZE/ITEM	WT. PER PKG.	QTY.	STD. PKG./ MSTR. SLEEVE	SUGGESTED TRADE LIST PRICE PER
QCSHK1 3/16" Kit	39200	3/16 X 1 1/4	1.33	50	1/25	48.79/ea kit
		3/16 X 1 3/4		35		
		3/16 X 2 1/4		25		
		5/32 X 3 1/2 Masonry Drill		1		
		1/4 Drill Chuck		1		
QCSHK2 1/4" Kit	39204	1/4 X 1 1/4	2.11	50	1/25	61.79/ea kit
		1/4 X 1 3/4		35		
		1/4 X 2 1/4		25		
		3/16 X 3 1/2 Masonry Drill		1		
		5/16 Drill Chuck		1		

OTHER SIZES AND QUANTITIES AVAILABLE BY REQUEST

Metallics/Avanti Screw is Manufacturing

## QUADRIVE CONCRETE SCREWS

STEEL MECHANICAL ZINC /  
CORROSION RESISTANT

**FOUR DRIVES IN ONE HEAD**

Hex, Slotted, Phillips & Square Drives

One Masonry Drill Packaged with Every Jar.

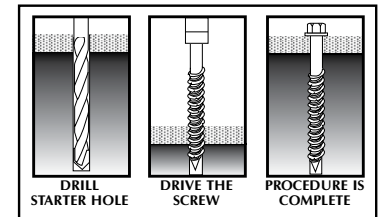

Cuts threads in structural concrete, hollow block, brick and mortar. A unique double lead and cutting thread speeds installation.



The Gold Standard  
of Concrete Screws



MADE IN USA



Made by  
Avanti Screw, Inc.,  
A Metallics Affiliate

PART#	UPC#	DIAMETER	LENGTH	DRILL STOCK NO.	WT. PER PKG.	STD. PKG./ MSTR. SLEEVE	SUGGESTED TRADE LIST PRICE PER
<b>1/4" QUADRIVE SOCKET DRIVER</b>							
QCSH1	39145	3/16	1 1/4	CD1	.79	100/500	32.45/c
QCSH2	39146	3/16	1 3/4	CD1	1.12	100/500	32.66/c
QCSH3	39147	3/16	2 1/4	CD2	1.39	100	46.69/c
<b>5/16" QUADRIVE SOCKET DRIVER</b>							
QCSH10	39148	1/4	1 1/4	CD5	1.43	100/500	39.31/c
QCSH20	39149	1/4	1 3/4	CD5	1.86	100	43.66/c
QCSH30	39150	1/4	2 1/4	CD6	2.29	100	49.49/c
QCSH40	39151	1/4	2 3/4	CD6	2.77	100	58.88/c

ONE MASONRY DRILL AND INSERT BIT PACKAGED WITH EVERY JAR.

### 1000 BULK PACK IN CARTON – CONCRETE SCREWS ONLY

PART#	UPC#	DIAMETER	LENGTH	WT. PER PKG.	STD. PKG.	SUGGESTED TRADE LIST PRICE PER
QCSH1B	39152	3/16	1 1/4	8.30	1000	275.88/m
QCSH2B	39153	3/16	1 3/4	15.10	1000	277.28/m
QCSH3B	39154	3/16	2 1/4	18.00	1000	396.66/m
QCSH10B	39155	1/4	1 1/4	10.35	1000	333.69/m
QCSH20B	39156	1/4	1 3/4	17.80	1000	371.28/m
QCSH30B	39157	1/4	2 1/4	22.47	1000	420.14/m
QCSH40B	39158	1/4	2 3/4	34.50	1000	500.60/m

MASONRY  
DRILLS  
NOT  
INCLUDED  
IN 1000  
PACK

OTHER SIZES AND QUANTITIES AVAILABLE BY REQUEST

www.metallics.us

# ANCHORING DEVICES



**□ Square Drive**

## FLAT HEAD SQUARE DRIVE CONCRETE SCREWS

STEEL MECHANICAL ZINC /CORROSION RESISTANT



Made by Avanti Screw, Inc., A Metallics Affiliate

PART#	UPC#	DIAMETER	LENGTH	WT. PER PKG.	STD. PKG./MSTR. SLEEVE	SUGGESTED TRADE LIST PRICE PER
FSCS1	39651	3/16	1 1/4	.65	100	34.72/c
FSCS2	39652	3/16	1 3/4	.85	100	36.38/c
FSCS3	39653	3/16	2 1/4	2.25	100	37.44/c
FSCS10	39660	1/4	1 1/4	1.30	100	37.93/c
FSCS20	39665	1/4	1 3/4	.95	100	39.49/c
FSCS30	39670	1/4	2 1/4	2.35	100	42.38/c
FSCS40	39675	1/4	2 3/4	2.80	100	46.19/c



## QUADRIVE CONCRETE SCREW ANCHOR DISPLAY



Made by Avanti Screw, Inc., A Metallics Affiliate

### CDQCSH10 Contains:

- 27 jars of the most common size Concrete Screw 1/4 x 1 1/4" QuaDrive.
- 100 pieces per jar.
- Free counter display and free shipping.



- Large fillet under head.
- Fluted interrupted threads.
- Hilo threads.
- Silver color to match conduit, strap and concrete

## QUADRIVE SOCKET DRIVER

QUADRIVE SOCKET DRIVERS - FOR QUADRIVE CONCRETE SCREWS



PART#	UPC#	HEAD SIZE	LENGTH	WT. PER PKG.	STD. PKG.	SUGGESTED TRADE LIST PRICE PER
1591910	39091	1/4	2 5/8	.26	1	11.29/ea
1513910	39092	5/16	2 5/8	.53	1	12.07/ea

OTHER SIZES AND QUANTITIES AVAILABLE BY REQUEST. SAFETY GLASSES SHOULD BE WORN FOR ANY DRIVING APPLICATIONS.

## MASONRY DRILL BITS FOR CONCRETE SCREWS

Can be used with our QuaDrive and Blue Concrete Screws



PART#	UPC#	DIAMETER	LENGTH	SCREW DIA.	WT. PER PKG.	STD. PKG.	SUGGESTED TRADE LIST PRICE PER
CD1	31250	5/32	3 1/2	3/16	.02	1	4.12/ea
CD2	31255	5/32	4 1/2	3/16	.02	1	4.86/ea
CD3	31260	5/32	5 1/2	3/16	.02	1	5.53/ea
CD5	31265	3/16	3 1/2	1/4	.02	1	4.21/ea
CD6	31270	3/16	4 1/2	1/4	.02	1	4.98/ea
CD7	31275	3/16	5 1/2	1/4	.03	1	7.06/ea
CD8	31280	3/16	6 1/2	1/4	.05	1	9.07/ea

OTHER SIZES AND QUANTITIES AVAILABLE BY REQUEST

# ANCHORING DEVICES



## HEX INDENTED SLOTTED WASHER HEAD BLUE CONCRETE SCREW KITS

STEEL MECHANICAL ZINC /CORROSION RESISTANT

PART#	UPC#	SIZE/ITEM	WT. PER PKG.	QTY.	STD. PKG./ MSTR. SLEEVE	SUGGESTED TRADE LIST PRICE PER
CSH316RF	87370	3/16 X 1 1/4	1.29	50	1/25	44.15/ea kit
		3/16 X 1 3/4		35		
		3/16 X 2 1/4		25		
		3 1/2 X 5/32 masonry drill		1		
		MT208 1/4 chuck		1		
CSH14RF	87365	1/4 X 1 1/4	2.00	50	1/25	48.92/ea kit
		1/4 X 1 3/4		35		
		1/4 X 2 1/4		25		
		3 1/2 X 3/16 masonry drill		1		
		MT210 5/16 chuck		1		

OTHER SIZES AND QUANTITIES AVAILABLE BY REQUEST

## BLUE CONCRETE SCREWS IT'S A TAPPING SCREW ANCHORING SYSTEM

STEEL MECHANICAL ZINC /CORROSION RESISTANT

One Masonry Drill Packaged with Every Jar.

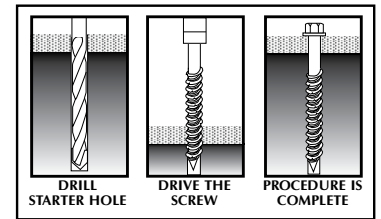

Cuts threads in structural concrete, hollow block, brick and mortar. A unique double lead and cutting thread speeds installation.

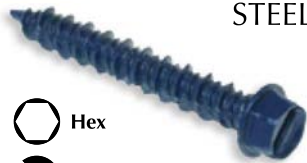

## INDENTED HEX SLOTTED WASHER HEAD



PART#	UPC#	DIAMETER	LENGTH	DRILL STOCK NO.	WT. PER PKG.	STD. PKG./ MSTR. SLEEVE	SUGGESTED TRADE LIST PRICE PER
<b>1/4" HEX DRIVER</b>							
CSH1F	87101	3/16	1 1/4	CD1	.80	100/500	23.41/c
CSH2F	87102	3/16	1 3/4	CD1	1.03	100/500	23.69/c
CSH3F	87103	3/16	2 1/4	CD2	1.32	100	29.14/c
CSH4F	87104	3/16	2 3/4	CD2	1.62	100	31.50/c
CSH5F	87105	3/16	3 1/4	CD3	1.88	100	34.15/c
CSH6F	87106	3/16	4	CD3	2.35	100	37.39/c
<b>5/16" HEX DRIVER</b>							
CSH10F	87110	1/4	1 1/4	CD5	1.28	100	25.76/c
CSH10FM	77510	1/4	1 1/4	CD5	12.15	1000	288.25/m
CSH20F	87120	1/4	1 3/4	CD5	1.71	100	28.83/c
CSH20FM	87121	1/4	1 3/4	CD5	16.23	1000	254.10/m
CSH30F	87130	1/4	2 1/4	CD6	2.14	100	31.21/c
CSH30FM	87131	1/4	2 1/4	CD6	20.23	1000	274.55/m
CSH40F	87140	1/4	2 3/4	CD6	2.57	100	35.32/c
CSH50F	87150	1/4	3 1/4	CD7	3.11	100	43.55/c
CSH60F	87160	1/4	4	CD7	3.62	100	77.88/c
CSH70F	87170	1/4	5	CD7	4.46	100	113.39/c
<b>410 STAINLESS – 5/16" HEX DRIVER</b>							
CSH10SS	90260	1/4	1 1/4	CD5	1.38	100	120.38/c
CSH20SS	90270	1/4	1 3/4	CD5	1.67	100	212.69/c
CSH80SS	90265	1/4	6	CD7	6.48	100	689.11/c

OTHER SIZES AND QUANTITIES AVAILABLE BY REQUEST

# ANCHORING DEVICES



## FLAT HEAD PHILLIPS BLUE CONCRETE SCREWS

STEEL MECHANICAL ZINC /CORROSION RESISTANT

One Masonry Drill Packaged with every jar.

PART#	UPC#	DIAMETER	LENGTH	DRILL STOCK NO.	WT. PER PKG.	STD. PKG./MSTR. SLEEVE	SUGGESTED TRADE LIST PRICE PER
<b>#2 PHILLIPS BIT</b>							
CSF1F	87201	3/16	1 1/4	CD1	.78	100/500	21.20/c
CSF2F	87202	3/16	1 3/4	CD1	1.05	100/500	23.71/c
CSF3F	87203	3/16	2 1/4	CD2	1.35	100	26.05/c
CSF4F	87204	3/16	2 3/4	CD2	1.52	100	29.14/c
CSF5F	87205	3/16	3 1/4	CD3	1.80	100	32.24/c
CSF6F	87206	3/16	4	CD3	2.02	100	36.35/c
<b>#3 PHILLIPS BIT</b>							
CSF10F	87210	1/4	1 1/4	CD5	1.25	100	25.62/c
CSF20F	87220	1/4	1 3/4	CD5	1.75	100	27.66/c
CSF30F	87230	1/4	2 1/4	CD6	2.11	100	37.09/c
CSF40F	87240	1/4	2 3/4	CD6	2.15	100	41.42/c
CSF50F	87250	1/4	3 1/4	CD7	2.88	100	52.10/c
CSF60F	87260	1/4	4	CD7	3.70	100	113.74/c
CSF70F	87270	1/4	5	CD7	4.50	100	153.72/c
<b>410 STAINLESS – #2 PHILLIPS BIT</b>							
CSF2SS	96602	3/16	1 3/4	CD1	1.05	100/500	112.08/c
CSF4SS	96604	3/16	2 3/4	CD2	1.50	100	148.45/c

OTHER SIZES AND QUANTITIES AVAILABLE BY REQUEST



## CONCRETE SCREW INSTALLATION KIT

8 PIECE KIT

### KIT INCLUDES:

- 1 - Drill Driver
- 1 - Drill Adapter
- 2 - Hex Drivers
- 1 - Phillips Bit Holder
- 2 - Phillips Bits
- 1 - Allen Hex Key

DOES NOT INCLUDE DRILL BIT

PART#	UPC#	SIZE	ITEM	WT. PER PKG.	STD. PKG.	SUGGESTED TRADE LIST PRICE PER
IT1000	31200	-	Installation Tool (complete kit)	.95	1	61.50/ea kit
<b>REPLACEMENT COMPONENTS FOR KIT — SOLD SEPARATELY —</b>						
MHD14	31205	1/4	Magnetic Hex Driver	.04	1	34.22/ea
MHD56	31210	5/16	Magnetic Hex Driver	.05	1	34.22/ea
PBH	31215	#2 & #3	Phillips Bit Holder	.01	1	42.15/ea
ITSLEVE	31203	-	Drill/Driver Adapter	.28	1	50.14/ea
PB2	31220	#2	Phillips Bit	.01	1	1.92/ea
PB3	31225	#3	Phillips Bit	.01	1	1.92/ea
HK1	31230	1/8	Allen Hex Key	.01	1	1.66/ea

OTHER SIZES AND QUANTITIES AVAILABLE BY REQUEST

## HEX LARGE DIAMETER CONCRETE SCREW ANCHORS

STEEL ZINC • 410 STAINLESS

High strength screw anchor for concrete and masonry. Designed for optimum performance in both cracked concrete and uncracked concrete under both static and seismic load conditions.



### Fast Installation

- Just drill with standard ANSI bit to proper depth
- Installs with 50% less torque

### Finished hex washer head

- Length identification on head
- Serrated washer

### Close edge/spacing distance

- Less spacing and edge distance required.

### Saves Time

- Installs in less than half the time of wedge or adhesive anchors.

### PRODUCT SPECIFICATIONS

**Diameter:** 3/8" and 1/2"

**Thread Form:** Serrated teeth on the tip reduces installation torque

**Material:** Carbon steel with zinc plate and stainless steel

**Head Style:** Finished hex serrated washer head

### Selection Chart

Carbon Steel with Zinc Plating and Stainless Steel

PART#	UPC#	ANCHOR DIAMETER	SOCKET SIZE	DRILL BIT DIAMETER	EFFECTIVE LENGTH	WT. PER PKG.	STD. PKG/ MSTR SLEEVE	SUGGESTED TRADE LIST PRICE PER
<b>STEEL ZINC</b>								
LCS3816	14470	3/8	9/16	3/8	1 3/4	4.14	50	139.96/c
LCS3824	14471	3/8	9/16	3/8	2 1/2	4.20	50	194.84/c
LCS3830	14472	3/8	9/16	3/8	3	4.83	50	214.36/c
LCS3840	14473	3/8	9/16	3/8	4	7.83	50	229.98/c
LCS3850	14474	3/8	9/16	3/8	5	9.34	40	270.90/c
LCS1230	14480	1/2	3/4	1/2	3	5.95	25	343.12/c
LCS1240	14481	1/2	3/4	1/2	4	7.50	25	374.20/c
LCS1250	14482	1/2	3/4	1/2	5	8.91	25	405.40/c
LCS1260	14483	1/2	3/4	1/2	6	3.78	20	577.60/c
<b>410 STAINLESS</b>								
LCS3816SS	14468	3/8	9/16	3/8	1 3/4	3.70	50	392.50/c
LCS1240SS	92936	1/2	3/4	1/2	4	5.98	25	862.50/c



## HEX LARGE DIAMETER CONCRETE SCREW ANCHORS

STEEL MECHANICALLY GALVANIZED

High strength screw anchor for concrete and masonry. Designed for optimum performance in both cracked concrete and uncracked concrete under both static and seismic conditions.

### FAST INSTALLATION

- Just drill with standard ANSI bit to proper depth
- Installs with 50% less torque

### Finished hex washer head

- Length identification on head
- Serrated washer

### Close edge/spacing distance

Less spacing and edge distance required.

### Saves Time

Installs in less than half the time of wedge or adhesive anchors.

### PRODUCT SPECIFICATIONS

**Diameter:** 3/8" and 1/2"

**Thread Form:** Serrated teeth on the tip reduces installation torque

**Material:** Carbon steel with zinc plate

**Head Style:** Finished hex washer head with mechanically galvanized coating

City of Los Angeles #RR25741 #RR25560 (CMU)  
Florida FL11506.7  
Factory Mutual 3017082

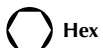

PART#	UPC#	ANCHOR DIAMETER	SOCKET SIZE	DRILL BIT DIAMETER	EFFECTIVE LENGTH	MAX. THICKNESS OF MATERIAL TO BE FASTENED	WT. PER PKG.	STD. PKG/ MSTR SLEEVE	SUGGESTED TRADE LIST PRICE PER
LCSX3850	14492	3/8	9/16	3/8	5	3 1/2	7.61	40	497.58/c
LCSX1240	14497	1/2	3/4	1/2	4	2	6.38	25	768.68/c
LCSX1250	14498	1/2	3/4	1/2	5	2 1/2	9.00	25	778.12/c

# ANCHORING DEVICES

## 6 ULTIMATE ANCHOR KITS

Choose the right kit that's right for you! The right anchors for any job. Same price regardless of the kit you choose.

**1 Kit For Any Job!**



UAK1



UAK2

PART#	UPC#	QTY.	SIZE	ITEM	WT. PER PKG.	STD. PKG.	SUGGESTED TRADE LIST PRICE PER
UAK1	33241	40	1/4	Plastic Red Anchors	3.23	1	49.75/ea kit
		40	#10 x 1	Pan Head Tapping Screws			
		1	1/4 x 4	Masonry Drill Bit			
		30	#6-8	Plastic Self-Drilling Wall Anchors			
		30	#8 x 1 1/4	Pan Head Tapping Screws			
		30	#8	Zinc Alloy Self-Drilling Wall Anchors			
		30	#8 x 1 1/4	Pan Head Tapping Screws			
		40	1/4	Plastic Blue Anchors			
		40	#10 x 1	Pan Head Tapping Screws			
		40	1/4 x 1 1/4	Blue Concrete Screw Anchors - Hex			
		1	5/32 x 3 1/2	Drill Bit			
		20	3/16	Spring Wing Toggle Heads			
		20	3/16 x 3	Mushroom Head Screws			
UAK2	33242	40	1/4	Plastic Red Anchors	3.21	1	49.75/ea kit
		40	#10 x 1	Pan Head Tapping Screws			
		1	1/4 x 4	Masonry Drill Bit			
		30	#6-8	Plastic Self-Drilling Wall Anchors			
		30	#8 x 1 1/4	Pan Head Tapping Screws			
		30	#8	Zinc Alloy Self-Drilling Wall Anchors			
		30	#8 x 1 1/4	Pan Head Tapping Screws			
		40	1/4	Plastic Yellow Anchors			
		40	#10 x 1	Pan Head Tapping Screws			
		40	1/4 x 1 1/4	Blue Concrete Screw Anchors - Hex			
		1	5/32 x 3 1/2	Drill Bit			
		20	3/16	Spring Wing Toggle Heads			
		20	3/16 x 3	Mushroom Head Screws			

OTHER SIZES, MATERIALS AND QUANTITIES AVAILABLE BY REQUEST

**METALLICS IS THE LARGEST ANCHOR KIT SOURCE IN AMERICA  
SELLING ONLY THROUGH AUTHORIZED DISTRIBUTORS**

# ANCHORING DEVICES

## 6 ULTIMATE ANCHOR KITS

**1 Kit For Any Job!**



UAK3



UAK4

PART#	UPC#	QTY.	SIZE	ITEM	WT. PER PKG.	STD. PKG.	SUGGESTED TRADE LIST PRICE PER
UAK3	33243	40	1/4	Plastic Red Anchors	3.23	1	49.75/ea kit
		40	#10 x 1	Pan Head Tapping Screws			
		1	1/4 x 4	Masonry Drill Bit			
		30	#6-8	Plastic Self-Drilling Wall Anchors			
		30	#8 x 1 1/4	Pan Head Tapping Screws			
		30	#8	Zinc Alloy Self-Drilling Wall Anchors			
		30	#8 x 1 1/4	Pan Head Tapping Screws			
		40	1/4	Plastic Yellow Anchors			
		40	#10 x 1	Pan Head Tapping Screws			
		40	1/4 x 1 1/4	Quadrine Concrete Silver Screw Anchors			
		1	5/32 x 3 1/2	Drill Bit			
		20	3/16	Spring Wing Toggle Heads			
20	3/16 x 3	Mushroom Head Screws					
UAK4	33244	40	1/4	Plastic Red Anchors	3.18	1	49.75/ea kit
		40	#10 x 1	Pan Head Tapping Screws			
		1	1/4 x 4	Masonry Drill Bit			
		30	#6-8	Plastic Self-Drilling Wall Anchors			
		30	#8 x 1 1/4	Pan Head Tapping Screws			
		30	#8	Zinc Alloy Self-Drilling Wall Anchors			
		30	#8 x 1 1/4	Pan Head Tapping Screws			
		40	1/4	Plastic Yellow Anchors			
		40	#10 x 1	#10 X 1 Panhead Tapping Screws			
		40	1/4 x 1 1/4	Blue Concrete Screw Anchors - Hex			
		1	5/32 x 3 1/2	Drill Bit			
		30	1/4 x 1	Metal Hammer Drive Nail in Anchors			

OTHER SIZES, MATERIALS AND QUANTITIES AVAILABLE BY REQUEST

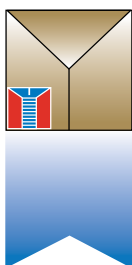

## METALLICS

**AMERICA'S SOURCE FOR PREMIER AND INNOVATIVE FASTENERS & ANCHORS**



# ANCHORING DEVICES

## 6 ULTIMATE ANCHOR KITS

**1 Kit For Any Job!**



UAK5



UAK6

PART#	UPC#	QTY.	SIZE	ITEM	WT. PER PKG.	STD. PKG.	SUGGESTED TRADE LIST PRICE PER
UAK5	33245	40	1/4	Plastic Red Anchors	3.31	1	49.75/ea kit
		40	#10 x 1	Pan Head Tapping Screws			
		1	1/4 x 4	Masonry Drill Bit			
		30	#6-8	Plastic Self-Drilling Wall Anchors			
		30	#8 x 1 1/4	Pan Head Tapping Screws			
		30	#8	Zinc Alloy Self-Drilling Wall Anchors			
		30	#8 x 1 1/4	Pan Head Tapping Screws			
		40	1/4	Plastic Yellow Anchors			
		40	#10 x 1	Pan Head Tapping Screws			
		20	10-24 x 3	Truss Head Machine Screws			
		20	3/16	Spring Wing Toggle Heads			
		25	1/4 x 2	Metal Hammer Drive Nail in Anchors			
UAK6	33246	40	1/4	Plastic Red Anchors	3.68	1	49.75/ea kit
		40	#10 x 1	Pan Head Tapping Screws			
		1	1/4 x 4	Masonry Drill Bit			
		30	#6-8	Plastic Self-Drilling Wall Anchors			
		30	#8 x 1 1/4	Pan Head Tapping Screws			
		40	1/4	Plastic Blue Anchors			
		40	#10 x 1	Pan Head Tapping Screws			
		30	#6-8	Zinc Alloy Self-Drilling Wall Anchors			
		30	#8 x 1 1/4	Pan Head Tapping Screws			
		1	1/4 x 4	Masonry Drill Bit			
		1	3/16 x 3 1/2	Masonry Drill Bit			
		16	1/4 x 4	Truss Head Machine Screws			
16	1/4-20	Spring Wing Toggle Heads					

OTHER SIZES, MATERIALS AND QUANTITIES AVAILABLE BY REQUEST

Helpful Hints From Metallics: **GOT FASTENERS?**  
*Did You forget to ask?*

# ANCHORING DEVICES

## EXTREME WALL ANCHOR KIT

The Last Anchor Kit You Will Ever Need!



**Kit Contains:**

See Page

- **ZSA1** (40 pcs) Zinc Wall Anchor #8 Screw ..... 182
- **ZSAL2** (50 pcs) Zinc Wall Anchor #6 Screw ..... 183
- **MWCA** (25 pcs) WallClaw Anchor #8 Screw ..... 168
- **PSA1** (25 pcs) Nylon Wall Anchor #8 Screw..... 183
- **ASP1** (25 pcs) Snapsku #8 Screw..... 156
- **ASPM1** (50 pcs) Snapsku #6 Screw ..... 156

PART#	UPC#	WT. PER PKG	STD. PKG.	SUGGESTED TRADE LIST PRICE PER
EWAK1	32990	2.97	1	95.00/ea kit

INCLUDES 1 #2 PHILLIPS DRIVE BIT

## 4 HEAVY DUTY ULTIMATE ANCHOR KITS

### UAKHD1



Drop-In Anchor



Double Expansion Anchor

### UAKHD2



Machine Screw Anchor



Wedge Anchor

### UAKHD3



Lag Screw Short & Long Anchor



Double Expansion Anchor

### UAKHD4



Drop-In Anchor



Sleeve Type Anchor

PART#	UPC#	QTY.	SIZE	ITEM	WT. PER PKG.	STD. PKG.	SUGGESTED TRADE LIST PRICE PER
UAKHD1	33281	20	1/4-20	Drop-In Anchors	5.26	1	47.50/ea kit
		15	3/8-16	Drop-In Anchors			
		10	1/2-13	Drop-In Anchors			
		20	1/4-20	Double Expansion Anchors			
		15	5/16-18	Double Expansion Anchors			
		10	3/8-16	Double Expansion Anchors			
UAKHD2	33282	20	1/4-20	Machine Screw Anchors	5.26	1	50.10/ea kit
		15	5/16-18	Machine Screw Anchors			
		10	3/8-16	Machine Screw Anchors			
		20	1/4 x 1 1/4	Wedge Anchors			
		15	1/4 x 2 1/4	Wedge Anchors			
		10	3/8 x 2 1/4	Wedge Anchors			
UAKHD3	33283	10	1/4	Lag Screw Short & Long Anchors	4.52	1	61.95/ea kit
		10	5/16	Lag Screw Short & Long Anchors			
		6	3/8	Lag Screw Short & Long Anchors			
		20	1/4	Double Expansion Anchors			
		15	5/16	Double Expansion Anchors			
		10	3/8	Double Expansion Anchors			
UAKHD4	33284	20	1/4-20	Steel Drop-In Anchors	4.71	1	31.30/ea kit
		15	3/8-16	Steel Drop-In Anchors			
		10	1/2-13	Steel Drop-In Anchors			
		20	1/4 x 1 3/8	Sleeve Type Anchors			
		15	5/16 x 1 1/2	Sleeve Type Anchors			
		10	3/8 x 1 7/8	Sleeve Type Anchors			

OTHER SIZES AND QUANTITIES AVAILABLE BY REQUEST

**1 Kit For Any Job!**

# ANCHORING DEVICES

## WALL DOG™ ANCHORS

Universal Light Duty Anchors

All steel, one-piece screw anchors, features high-profile threads for easy fastening into wallboard and other masonry base materials

- Installs in a variety of base materials
- Installs directly through fixtures into wallboard – no second step is required
- When removed the Wall Dog leaves a much smaller hole than toggles or other systems
- Thread design prevents spinning and stripping
- Heat treated point penetrates metal and wood studs
- Two finished heads, oval and pan
- Two colors, chrome & white head
- No pilot hole required for wallboard
- Can be easily backed out of hole
- No hole spotting required



E



Four Heads in One!



## COMBO HEX WASHER HEAD LIGHT DUTY WALL DOG™ ANCHORS

STEEL ZINC

PART#	UPC#	ANCHOR LENGTH	WT. PER PKG.	STD. PKG./MSTR. SLEEVE	SUGGESTED TRADE LIST PRICE PER
MWDH114J	28014	1¼	.91	100	15.38/ea
MWDH114K	28015	1¼	.91	100	15.38/ea
MWDH1141M	28016	1¼	9.10	1000	146.25/m



## WAFER PHILLIPS HEAD LIGHT DUTY WALL DOG™ ANCHORS

STEEL ZINC



PART#	UPC#	ANCHOR LENGTH	DRILL BIT SIZE	WT. PER PKG.	STD. PKG./MSTR. SLEEVE	SUGGESTED TRADE LIST PRICE PER
MWDWW112J	28017	1½	3/16	.89	100	22.88/ea
MWDWW112K	28018	1½	3/16	.89	100	22.88/ea
MWDWW1121M	28019	1½	3/16	8.90	1000	161.13/m
MWDWW2J	28020	2	3/16	1.15	100	24.75/ea
MWDWW2K	28021	2	3/16	1.15	100	24.75/ea
MWDWW21M	28022	2	3/16	11.50	1000	235.13/m
MWDWW214J	28023	2¼	3/16	1.25	100	30.25/ea
MWDWW214K	28024	2¼	3/16	1.25	100	30.25/ea
MWDWW2141M	28025	2¼	3/16	12.50	1000	287.50/m
MWDWW212J	28026	2½	3/16	1.35	100	37.63/ea
MWDWW212K	28027	2½	3/16	1.35	100	37.63/ea
MWDWW2121M	28028	2½	3/16	13.50	1000	357.45/m

# ANCHORING DEVICES



## SQUARE HEAD LIGHT DUTY ROBERTSON WALL DOG™ ANCHORS

STEEL ZINC

PART#	UPC#	ANCHOR LENGTH	DRILL BIT SIZE	WT. PER PKG.	STD. PKG./MSTR. SLEEVE	SUGGESTED TRADE LIST PRICE PER
MWDS114J	28030	1¼	3/16	.89	100	18.00/ea
MWDS114K	28029	1¼	3/16	.89	100	18.00/ea
MWDS1141M	28031	1¼	3/16	8.90	1000	171.25/m



## OVAL/PHILLIPS HEAD LIGHT DUTY WALL DOG™ ANCHORS

STEEL ZINC

PART#	UPC#	ANCHOR LENGTH	COLOR	DRILL BIT SIZE	WT. PER PKG.	STD. PKG./MSTR. SLEEVE	SUGGESTED TRADE LIST PRICE PER
MWDOZ114J	28032	1¼	Zinc	3/16	.80	100	15.38/ea
MWDOZ114K	28033	1¼	Zinc	3/16	.80	100	15.38/ea
MWDOZ1141M	28034	1¼	Zinc	3/16	8.00	1000	146.25/m
MWDOW114J	28035	1¼	White	3/16	.90	100	17.75/ea
MWDOW114K	28036	1¼	White	3/16	.90	100	17.75/ea
MWDOW1141M	28037	1¼	White	3/16	9.00	1000	168.75/m
MWDOBLK114J	28038	1¼	Black	3/16	.80	100	15.75/ea
MWDOBLK114K	28039	1¼	Black	3/16	.80	100	15.75/ea
MWDOBLK1141M	28040	1¼	Black	3/16	8.00	1000	149.63/m
MWDOBR114J	28041	1¼	Brass	3/16	.82	100	14.95/ea
MWDOBR114K	28042	1¼	Brass	3/16	.82	100	14.95/ea
MWDOBR1141M	28043	1¼	Brass	3/16	8.20	1000	142.50/m



## PAN/PHILLIPS HEAD LIGHT DUTY WALL DOG™ ANCHORS

STEEL ZINC

PART#	UPC#	ANCHOR LENGTH	COLOR/TYPE	DRILL BIT SIZE	WT. PER PKG.	STD. PKG./MSTR. SLEEVE	SUGGESTED TRADE LIST PRICE PER
MWDPZ114J	28044	1¼	Zinc	3/16	.79	100	12.75/ea
MWDPZ114K	28045	1¼	Zinc	3/16	.79	100	12.75/ea
MWDPZ1141M	28046	1¼	Zinc	3/16	7.90	1000	117.75/m
MWDPW114J	28047	1¼	White	3/16	.79	100	14.13/ea
MWDPW114K	28048	1¼	White	3/16	.79	100	14.13/ea
MWDPW1141M	28049	1¼	White	3/16	7.90	1000	135.00/m
MWDPBLK114J	28059	1¼	Black	3/16	.79	100	14.18/ea
MWDPBLK114K	28060	1¼	Black	3/16	.79	100	14.18/ea
MWDPBLK1141M	28061	1¼	Black	3/16	7.90	1000	135.00/m
MWDPBR114J	28063	1¼	Brass	3/16	.91	100	31.50/ea
MWDPBR114K	28062	1¼	Brass	3/16	.91	100	31.50/ea
MWDPBR1141M	28064	1¼	Brass	3/16	9.10	1000	300.00/m
MWDPW112J	28050	1½	White	3/16	.89	100	25.75/ea
MWDPW112K	28051	1½	White	3/16	.89	100	25.75/ea
MWDPW1121M	28052	1½	White	3/16	8.90	1000	244.63/m
MWDPBZ112J	28053	1½	Bronze	3/16	.91	100	16.50/ea
MWDPBZ112K	28054	1½	Bronze	3/16	.91	100	16.50/ea
MWDPBZ1121M	28055	1½	Bronze	3/16	9.10	1000	157.50/m
MWDPBLKP112J	28056	1½	Black	3/16	.89	100	22.43/ea
MWDPBLKP112K	28057	1½	Black	3/16	.89	100	22.43/ea
MWDPBLKP1121M	28058	1½	Black	3/16	8.90	1000	215.00/m

# ANCHORING DEVICES



## SPRING WING TOGGLE BOLTS

STEEL ZINC • 18-8 STAINLESS  
Bolts and Wings in One Package  
ROUND • FLAT • TRUSS

PART#	JAR UPC#	DIAMETER	LENGTH	DRILL SIZE	WT. PER PKG.	STD. PKG./ MSTR. SLEEVE	SUGGESTED TRADE LIST PRICE PER
<b>STEEL ZINC</b>							
<b>ROUND HEAD</b>							
J1501 (Slot/Phil)	80809	1/8	2	1/8 WING USE 7/16 DRILL	.72	50	30.28/c
J1502 (Slot/Phil)	80810	1/8	3		.80	50	34.86/c
J1503 (Slot/Phil)	81203	1/8	4		1.09	50	37.30/c
J1504 (Slot)	81204	1/8	6		2.60	50	59.94/c
J1505 (Slot/Phil)	80811	3/16	2	3/16 WING USE 9/16 DRILL	1.40	50	36.56/c
J1506 (Slot/Phil)	80812	3/16	3		1.71	50	40.58/c
1506M (Slot/Phil)	74806	3/16	3		33.20	1000	313.32/m
15065M (Slot/Phil)	75208	3/16	3		166.04	5000	295.12/m
J1507 (Slot/Phil)	81207	3/16	4		1.95	50	42.42/c
1507B (Slot/Phil)	62100	3/16	4		39.39	1000	363.72/m
J1508 (Slot)	81208	3/16	5		2.35	50	45.60/c
J1509 (Slot)	81209	3/16	6		2.60	50	52.56/c
J1511 (Slot/Phil)	80813	1/4	3		1/4 WING USE 3/4 DRILL	2.93	50
J1511XXV (Slot/Phil)	28740	1/4	3	1.48		25	40.60/c
J1512 (Slot/Phil)	10396	1/4	4	3.53		50	51.20/c
1512CB (Slot/Phil)	21847	1/4	4	17.25		250	329.04/m
1512V (Slot/Phil)	60712	1/4	4	36.60		500	482.84/m
1512B (Slot/Phil)	62104	1/4	4	73.22		1000	436.80/m
J1513 (Slot)	81213	1/4	5	3.93		50	59.84/c
J1514 (Slot)	81214	1/4	6	4.47		50	68.26/c
J1515 (Slot)	10406	5/16	3	5/16 WING USE 7/8 DRILL		2.62	25
J1516 (Slot)	10407	5/16	4		3.05	25	109.76/c
J1517 (Slot)	81217	5/16	5		3.55	25	155.64/c
J1518 (Slot)	81218	5/16	6		4.03	25	174.24/c
J1519 (Slot/Phil)	81219	3/8	3	3/8 WING USE 1" DRILL	3.72	25	121.96/c
J1520 (Slot/Phil)	81220	3/8	4		4.28	25	136.52/c
J1521 (Slot)	81221	3/8	5		5.06	25	166.64/c
J1522 (Slot/Phil)	81222	3/8	6		5.60	25	181.80/c
J1523 (Slot)	81223	1/2	4	1/2 WING USE 1 1/4 DRILL	3.95	10	246.30/c
J1524 (Slot)	81224	1/2	5		4.25	10	398.40/c
J1525 (Slot)	81225	1/2	6		4.85	10	361.10/c
<b>18-8 STAINLESS</b>							
<b>ROUND HEAD</b>							
J1507SS (Slot)	96907	3/16	4	3/16 WING USE 9/16 DRILL	2.11	50	170.14/c
J1512SS (Slot)	96912	1/4	4	1/4 WING USE 3/4 DRILL	3.37	50	505.02/m
J1516SS (Slot)	96916	5/16	4	5/16 WING USE 7/8 DRILL	3.05	25	215.96/c
J1520SS (Slot)	96920	3/8	4	3/8 WING USE 1" DRILL	4.36	25	398.48/c

OTHER SIZES AND QUANTITIES AVAILABLE BY REQUEST

CONTINUED ON NEXT PAGE  
[www.metallics.us](http://www.metallics.us)

# ANCHORING DEVICES



## CONTINUED SPRING WING TOGGLE BOLTS

STEEL ZINC • 18-8 STAINLESS  
Bolts and Wings in One Package  
ROUND • FLAT • TRUSS

PART#	JAR UPC#	DIAMETER	LENGTH	DRILL SIZE	WT. PER PKG.	STD. PKG./ MSTR. SLEEVE	SUGGESTED TRADE LIST PRICE PER
<b>STEEL ZINC</b>							
<b>FLAT HEAD</b>							
J1528 (Slot)	81228	1/8	2	1/8 WING USE 7/16 DRILL	.69	50	40.41/c
J1529 (Slot)	80814	1/8	3		.87	50	42.18/c
J1530 (Slot)	81230	1/8	4		.97	50	35.64/c
J1531 (Slot)	81231	3/16	2	3/16 WING USE 9/16 DRILL	1.48	50	45.97/c
J1532 (Slot)	81232	3/16	3		1.68	50	48.52/c
J1533 (Slot)	81233	3/16	4		2.10	50	65.92/c
J1534 (Slot)	81234	3/16	5		2.24	50	75.80/c
J1535 (Slot)	81235	3/16	6		2.62	50	78.87/c
J1536 (Slot)	81236	1/4	3	1/4 WING USE 3/4 DRILL	2.82	50	111.89/c
J1537 (Slot)	81237	1/4	4		3.31	50	44.62/c
J1538 (Slot)	81238	1/4	5		3.96	50	79.05/c
J1539 (Slot)	81239	1/4	6		4.46	50	78.24/c
J1540 (Slot)	81240	5/16	3	5/16 WING USE 7/8 DRILL	2.55	25	115.14/c
J1541 (Slot)	81241	5/16	4		2.88	25	121.86/c
J1542 (Slot)	81242	5/16	5		3.22	25	155.64/c
J1543 (Slot)	81243	5/16	6		3.79	25	174.23/c
J1544 (Slot)	81244	3/8	3	3/8 WING USE 1" DRILL	3.49	25	135.52/c
J1545 (Slot)	81245	3/8	4		4.22	25	151.74/c
J1546 (Slot)	81246	3/8	5		4.90	25	180.68/c
J1547 (Slot)	81247	3/8	6		5.75	25	185.20/c
<b>TRUSS HEAD</b>							
J1548 (Slot)	80815	1/8	2	1/8 WING USE 7/16 DRILL	.75	50	30.28/c
J1549 (Slot/Phil)	80816	1/8	3		.82	50	34.86/c
J1550 (Slot/Phil)	80817	1/8	4		1.01	50	37.30/c
J1551 (Slot/Phil)	80818	3/16	3	3/16 WING USE 9/16 DRILL	1.70	50	40.58/c
J1552 (Slot/Phil)	10397	3/16	4		2.04	50	42.42/c
J1553 (Slot/Phil)	10399	1/4	3	1/4 WING USE 3/4 DRILL	3.05	50	47.66/c
J1554 (Slot/Phil)	10398	1/4	4		3.50	50	51.20/c
<b>TRUSS HEAD</b>							
J1560 (Square)	80819	1/8	2	1/8 WING USE 7/16 DRILL	.84	50	60.68/c
J1561 (Square)	80820	1/8	3		.95	50	34.86/c
J1562 (Square)	80821	1/8	4		1.10	50	37.28/c
J1563 (Square)	80822	3/16	2	3/16 WING USE 9/16 DRILL	1.58	50	36.56/c
J1564 (Square)	80823	3/16	3		1.85	50	40.58/c
J1565 (Square)	81265	3/16	4		2.08	50	42.42/c
J1566 (Square)	81266	1/4	3	1/4 WING USE 3/4 DRILL	3.03	50	47.66/c
J1567 (Square)	81267	1/4	4		3.55	50	45.30/c

OTHER SIZES AND QUANTITIES AVAILABLE BY REQUEST

# ANCHORING DEVICES



## TIE WIRE ACOUSTICAL TOGGLE BOLTS

STEEL ZINC

**Includes:** (1) Tie Wire 1/4-20 toggle bolt  
 (1) 1/4-20 nut  
 (1) 1/4 washer  
 (1) 1/4 toggle wing

PART#	UPC#	SIZE	WT. PER PKG.	STD. PKG./MSTR. SLEEVE	SUGGESTED TRADE LIST PRICE PER
JTWA144	81402	1/4 x 4	2.47	25	190.68/c
JTWA145	81404	1/4 x 5	2.89	25	205.36/c

**HOLE SIZE 5/8" • EYE SIZE 1/4"**

OTHER SIZES AND QUANTITIES AVAILABLE BY REQUEST



## SPRING WING TOGGLE HEADS

STEEL ZINC • 18-8 STAINLESS

PART#	JAR UPC#	THREAD DIAMETER	DRILL SIZE	WT. PER PKG.	STD. PKG./MSTR. SLEEVE	SUGGESTED TRADE LIST PRICE PER	
<b>STEEL ZINC</b>							
J1590	80824	6-32	FOR APPROPRIATE DRILL SIZE SEE CHART ON PAGE 150	.71	100/500	18.89/c	
J1591	80864	8-32		1.04	100	35.39/c	
J1592	80825	10-24		1.38	100	22.61/c	
J1593	80826	1/4-20		2.25	100	25.60/c	
J1594	80827	5/16-18		4.20	100	47.91/c	
J1595	80828	3/8-16		1.47	25	69.72/c	
J1596	80829	1/2-13		4.42	25	161.64/c	
<b>18-8 STAINLESS</b>							
J1592SS	96992	3/16		.74	50	297.58/c	
J1593SS	96993	1/4-20		.94	50	264.50/c	
J1595SS	13294	3/8-16	1.54	25	999.00/c		

OTHER SIZES AND QUANTITIES AVAILABLE BY REQUEST

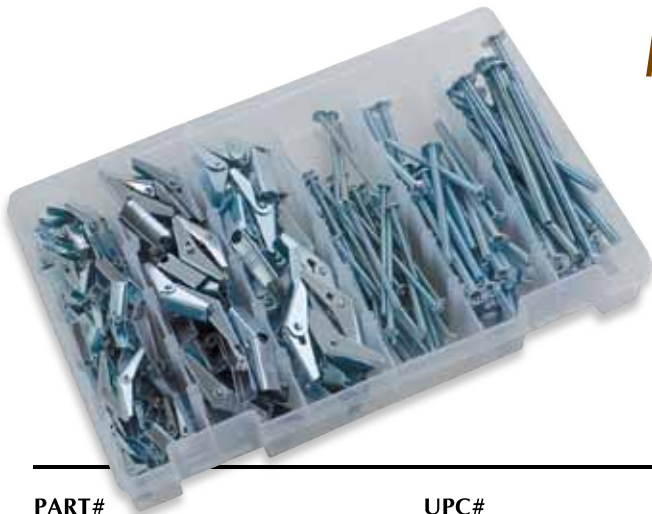

## MUSHROOM HEAD TOGGLE BOLT KIT

STEEL ZINC

**Kit Includes The Following:**

- 1/8" x 3" Mushroom Head Combo Drive Bolt (50 Pieces)
- 1/8" Spring Wing Toggle (50 Pieces)
- 3/16" x 3" Mushroom Head Combo Drive Bolt (34 Pieces)
- 3/16" Spring Wing Toggle (34 Pieces)
- 1/4" x 4" Mushroom Head Combo Drive Bolt (20 Pieces)
- 1/4" Spring Wing Toggle (20 Pieces)

PART#	UPC#	WT. PER PKG.	STD. PKG.	SUGGESTED TRADE LIST PRICE PER
TBMK1	70060	3.73	1	46.28/ea kit

OTHER SIZES AND QUANTITIES AVAILABLE BY REQUEST

# ANCHORING DEVICES



## MASTER ANCHOR™ THE WORLD'S STRONGEST FASTENER™



### MASTER ANCHOR™:

- **Never loosens!**
- Installs in all hollow walls - in just minutes!
- **Rated up to 300 lbs. in drywall.**
- Handles vector forces 360°.
- Objects can be easily removed or replaced.



### Carbide Tipped Apache 200™ Drill Bit:

- Industrial Carbide Rated at 200 Holes in Ceramic Wall Tile.
- Designed for Ceramic, Marble and Plaster.
- **Guaranteed to NEVER Walk.**
- Fits standard and cordless drills.

### Install Instructions:

Surface Preparation - Determine where to install - Drill 3/4" hole using the APACHE200. The standard MASTER Anchor is used in wall substrates up to 1.3" thick.

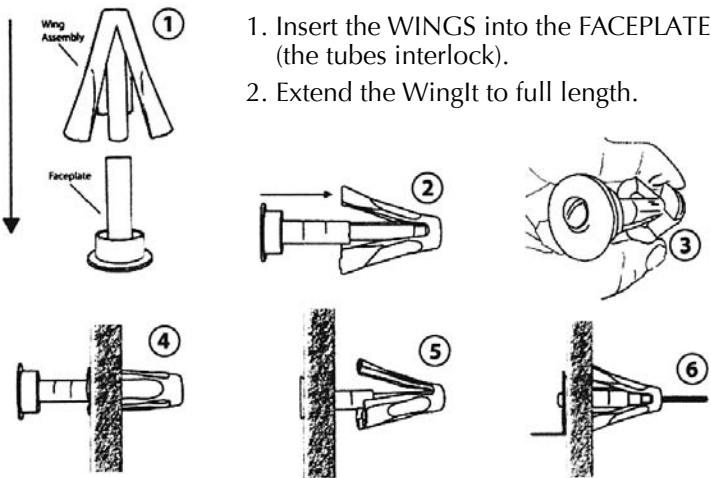

3. Compress and insert the WINGS into the holes.
4. WINGS should be FLUSH with the wall surface.
5. Pop WingIt through the hole by pushing on the Faceplate.
6. Using the enclosed 3.5" Stainless Steel Screw, attach the object to the WingIt.

Note: For individual mounting points where the object will be subject to considerable torque (rotational forces) - use at least TWO MASTER Anchors.

NOTE: Strength and stability are greatly affected by projection off the wall surface. WingIts are designed to be used in vertical walls only - **DO NOT USE IN CEILING!**

### DRILL IT. INSTALL IT. MOUNT IT.

Fire Retardant, Structural Plastic & S/S Construction

PART#	UPC#	ITEM	WT. PER PKG.	STD. PKG./MSTR. SLEEVE	SUGGESTED TRADE LIST PRICE PER
MAW35SD	39696	Master Anchor with #10 x 3-1/2 SS Screw	.11	2	9.88/ea kit
MAWD34	39685	3/4 Carbide Tipped Apache Drill	.14	1	41.60/ea



### PACKED WITH PRIDE

As a part of our Quality Program, each shipment and each single carton leaving our facilities has a label affixed to it, indicating the person who packed the order.

### HARD BODY PACKING

When you, the distributor, compare price and performance to other fastener suppliers, please compare our Hard Body Packing to the way they ship products.

We do it the right way—the quality way—the Metallics way.



# ANCHORING DEVICES

## COBRA TRIPLEGRIP™ MULTI-PURPOSE ANCHORS & KITS

### MAXIMUM LOAD CAPACITY



Anchor	Drill Bit	Drywall 5/8"		Concrete 3000 psi	
		PULL	SHEAR	PULL	SHEAR
6	1/4	60 lbs.	91 lbs.	240 lbs.	400 lbs.
8	1/4	64 lbs.	102 lbs.	275 lbs.	500 lbs.
10	5/16	88 lbs.	154 lbs.	400 lbs.	800 lbs.
12	3/8	132 lbs.	204 lbs.	500 lbs.	900 lbs.

Requires: Drill and #2 Phillips



- Two claws hold the anchor stationary while inserting the screw.
- Two powerful locking wings deploy as you screw, for strength and unparallel vibration resistance.
- The tip of the core expands for additional holding power.
- Works in 3/8", 1/2" and 5/8" Drywall; Brick; Concrete and Plaster.

E

PART#	UPC#	DIAMETER	LENGTH	ITEM	WT. PER PKG.	STD. PKG./MSTR. SLEEVE	SUGGESTED TRADE LIST PRICE PER
TGA6	72655	6	-	Triple Grip Anchors	.14	100	14.60/c
TGA8	72657	8	-	Triple Grip Anchors	.11	100	14.93/c
TGA10	72659	10	-	Triple Grip Anchors	.20	100	16.88/c
TGA12	72661	12	-	Triple Grip Anchors	.30	100	31.78/c
TGA6K	72665	6	-	Triple Grip Anchors	.65	100	20.45/c
		6	1 1/4	Pan Head Sheet Metal Screws			
		1/4	4	(1) Masonry Drill			
TGA8K	72667	8	-	Triple Grip Anchors	.81	100	20.85/c
		8	1 1/4	Pan Head Sheet Metal Screws			
		1/4	4	(1) Masonry Drill			
TGA10K	72669	10	-	Triple Grip Anchors	1.33	100	24.73/c
		10	1 1/2	Pan Head Sheet Metal Screws			
		5/16	4	(1) 5/16 x 4" Masonry Drill			
TGA12K	72671	12	-	Triple Grip Anchors	1.20	50	26.63/c
		12	1 1/2	Pan Head Sheet Metal Screws			
		3/8	4	(1) Masonry Drill			
TGA6J	72675	6	-	Triple Grip Anchors	.66	100	20.45/c
		6	1 1/4	Pan Head Sheet Metal Screws			
		1/4	4	(1) 1/4 x 4" Masonry Drill			
TGA8J	72677	8	-	Triple Grip Anchors	.83	100	20.45/c
		8	1 1/4	Pan Head Sheet Metal Screws			
		1/4	4	(1) Masonry Drill			
TGA10J	72679	10	-	Triple Grip Anchors	1.31	100	24.73/c
		10	1 1/2	Pan Head Sheet Metal Screws			
		5/16	4	(1) 5/16 x 4" Masonry Drill			
TGA12J	72681	12	-	Triple Grip Anchors	1.01	50	26.63/c
		12	1 1/2	Pan Head Sheet Metal Screws			
		3/8	4	(1) Masonry Drill			

OTHER SIZES AND QUANTITIES AVAILABLE BY REQUEST

Note: Part numbers with a "K" are packaged in plastic boxes. Part numbers with a "J" are packaged in plastic jars.

# ANCHORING DEVICES



## TOGGLER ALLIGATOR<sup>®</sup> SOLID WALL ANCHORS

Alligator solid-wall anchors are designed to support heavy loads.  
(even under vibration)

Alligator solid-wall anchors can be used in almost any material, including:  
Concrete, Wood, Plaster, Aerated Concrete, Brick, Masonry, Stone,  
Flakeboard, Cinder Block, Ceramic Tile, Stucco and Drywall.

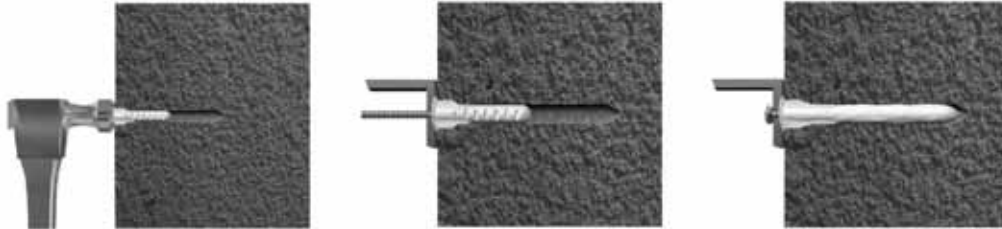

PART#	UPC#	SIZE	WT. PER PKG.	STD. PKG./MSTR. SLEEVE	SUGGESTED TRADE LIST PRICE PER
MAF5	73905	3/16	.10	50	35.58/c
MAF6	73906	1/4	.13	50	50.52/c
MAF8	73908	5/16	.22	50	67.38/c
MA6	73936	1/4	.13	50	50.52/c

OTHER SIZES AND QUANTITIES AVAILABLE BY REQUEST

### ULTIMATE TENSILE PULL-OUT VALUES [lb]

PART#	ANCHOR DIAMETER	DRILL DIAMETER	SCREW SIZE	1/2" DRYWALL	3500 PSI CONCRETE	SCREW SIZE	4000 PSI CONCRETE
MAF5	3/16	3/16	#8 SMS	57	544	#10 SMS	2316
MA6/MAF6	1/4	1/4	#10 SMS	69	675	#14 SMS	2633
MAF8	5/16	5/16	#12 SMS	85	1025	5/16 LAG	3083

### ULTIMATE SHEAR [lb]

PART#	ANCHOR DIAMETER	DRILL DIAMETER	SCREW SIZE	1/2" DRYWALL
MAF5	3/16	3/16	#8 SMS	125
MA6/MAF6	1/4	1/4	#10 SMS	153
MAF8	5/16	5/16	#12 SMS	171



## SUPER WALL PLATE SCREW KIT

Each kit contains:

- 50 Wall plate screws in white, ivory, and almond.
- 100 Screws to secure electrical device to electrical box.
- 50 Quick Fix GB spacers to shim electrical device so wall plate is flush to wall.

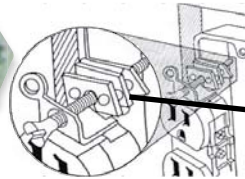

PART#	UPC#	DIAMETER	LENGTH	SCREW TYPE/ITEM	STD. PKG./MSTR. SLEEVE	WT. PER PKG.	SUGGESTED TRADE LIST PRICE PER
SWPK1	20360	6-32	1/2	Slotted Oval Head White Painted Screw	50	.98	31.51/ea kit
		6-32	1/2	Slotted Oval Head Ivory Painted Screw	50		
		6-32	1/2	Slotted Oval Head Almond Painted Screw	50		
		6-32	3/4	Slotted Flat Head Machine Screw	50		
		6-32	1	Slotted Flat Head Machine Screw	50		
		-	-	Quick Fix GB Stackable Spacers	50		

OTHER SIZES AND QUANTITIES AVAILABLE BY REQUEST

# ANCHORING DEVICES

## TOGGLER SNAPSKRU® KIT OR BULK SELF-DRILLING DRYWALL ANCHORS

**INSTALLATION INSTRUCTIONS:** Tools Needed Screw gun with #2 Phillips bit (or #2 Phillips screwdriver, or electric drill with clutch mechanism & #2 bit)



Press tip of Snapskru anchor into drywall using #2 Phillips screwdriver or screw gun. Drive anchor clockwise into drywall until anchor stops flush with the outer wall surface.

*TIP: To keep anchor in precise position during installation (critical for aligning several anchors), push tip of screwdriver into drywall to mark insertion point.*

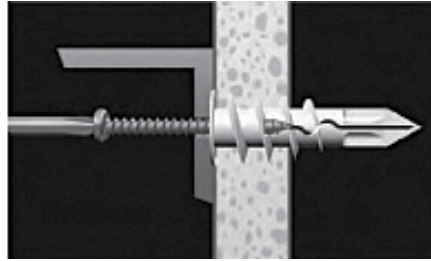

Screw for MINI anchor:  
#6 through #8 (#6 preferred).  
[3.5-4.5mm, 3.5mm preferred]

Screw for Regular anchor:  
#6 through #10 (#8 preferred).  
[3.5-4.5mm, 4mm preferred]

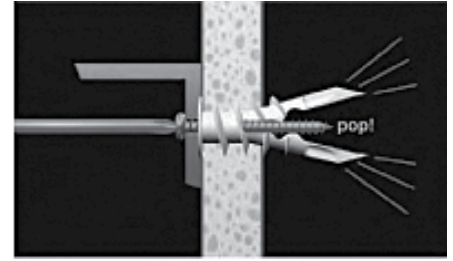

Tighten screw flush with item.

The screw pops open the anchor, looking it on the wall and holding the gypsum board in compression. This reinforces the wall, increasing its holding power significantly.

**Screw Length = Thickness of item being installed plus 1 1/4".**

PART#	UPC#	QTY	DIAMETER	LENGTH	ITEM	WT. PER PKG.	SUGGESTED TRADE LIST PRICE PER
ASP	73920	50	-	-	Toggler Snapskru Reg. Anchor	.34	61.48/c
ASPM	73921	50	-	-	Toggler Snapskru Mini Anchor	.18	48.04/c
ASP1K	78446	50	-	-	Toggler Snapskru Reg.	.80	31.42/ea kit
		50	8	1 1/2	Pan Hd Combo SMS		
		1	2	2	Phillips Power Bit		
ASP1J	78445	50	-	-	Toggler Snapskru Reg.	.73	31.42/ea kit
		50	8	1 1/2	Pan Hd Combo SMS		
		1	2	2	Phillips Power Bit		
ASP1M	78447	1000	-	-	Toggler Snapskru Regular	.73	309.68/m
ASPM1K	78461	50	-	-	Toggler Snapskru Mini	.50	25.57/ea kit
		50	6	1 1/2	Pan Hd Combo SMS		
		1	2	2	Phillips Power Bit		
ASPM1J	78460	50	-	-	Toggler Snapskru Mini	.50	25.57/ea kit
		50	6	1 1/2	Pan Hd Combo SMS		
		1	2	2	Phillips Power Bit		
ASPM1M	78462	1000	-	-	Toggler Snapskru Mini	3.60	240.24/m

OTHER SIZES, MATERIALS AND QUANTITIES AVAILABLE BY REQUEST

ANCHOR	MINI	REGULAR	MINI	REGULAR
<b>Tested In</b>	<b>ULTIMATE TENSILE [lb]</b>		<b>ULTIMATE SHEAR [lb]</b>	
3/8 Drywall	57	57	105	108
1/2 Drywall	65	79	131	149
5/8 Drywall	95	135	175	178
<b>Screw Tested</b>	#6 x 1 1/4	#8 x 1 1/2	#6 x 1 1/4	#8 x 1 1/2
	ASPM	ASP	ASPM	ASP

# ANCHORING DEVICES

## TOGGLER ALLIGATOR® SOLID WALL ANCHOR KITS



- Alligator® solid-wall anchors can be used in most any material, including: Concrete, Wood, Plaster, Aerated Concrete, Block, Masonry, Stone, Flakeboard, Cinder Block, Ceramic Tile, Stucco, and Drywall.
- Alligator® solid-wall anchors are designed to support heavy loads (Even under vibration!)

**The Alligator anchor is the only anchor that extrudes the entire length of the screw.** The screw extrudes and compresses all the plastic into the wall of the hole under tremendous pressure. The plastic molds and conforms exactly to the surface of the hole (including all the hole's imperfections). All forces supported by the screw are transmitted around the anchor to the wall of the hole. This provides greater holding power by distributing the force over the maximum area possible.

PART#	UPC#	QTY.	DIAMETER	LENGTH	ITEM	WT. PER PKG.	SUGGESTED TRADE LIST PRICE PER
MAF5KJ	73985	50	8	1	Pan Head Combo Sheet Metal Screws	.40	24.53/ea kit
		50	3/16	-	Alligator Solid Wall Anchors with Flange		
		1	3/16	4	Carbide Tipped Masonry Drill Bit		
MAF6KJ	73986	50	10	1	Pan Head Combo Sheet Metal Screws	.55	30.30/ea kit
		50	1/4	-	Alligator Solid Wall Anchors with Flange		
		1	1/4	4	Carbide Tipped Masonry Drill Bit		
MA6KJ	73996	50	10	1	Pan Head Combo Sheet Metal Screws	.54	30.30/ea kit
		50	1/4	-	Alligator Solid Wall Anchors		
		1	1/4	4	Carbide Tipped Masonry Drill Bit		
MAF8KJ	79388	50	12	1 1/4	Pan Head Combo Sheet Metal Screws	.85	42.22/ea kit
		50	5/16	-	Alligator Solid Wall Anchors with Flange		
		1	5/16	4	Carbide Tipped Masonry Drill Bit		

OTHER SIZES AND QUANTITIES AVAILABLE BY REQUEST



An American Made Alternative To the Blue Concrete Screw – See Page 138.

### QUADRIVE CONCRETE SCREW ANCHORS



- Large fillet under head to fit 3/16" and 1/4" holes provides greater driving strength
- Fluted, interrupted threads aid tapping into masonry products
- Hilt threads for faster application
- Silver color to match conduit, strap and concrete

#### STOP THE SNAPPING

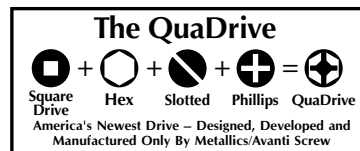

MADE IN USA



Made by Avanti Screw, Inc., A Metallics Affiliate

We will be glad to send a sample bag of 10 pieces to our Distributors for their customer trials. **Please specify size!**

Metallics Inc. • 800-243-8272 • sales@metallics.us

# ANCHORING DEVICES

## TOGGLER® HOLLOW WALL ANCHORS

All Toggler hollow-wall anchors install in a small 5/16" (8mm) diameter hole. With reasonable care you can even use your screwdriver to make the hole in drywall.

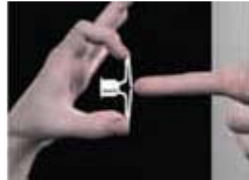

Drywall 5/16" (8mm) hole. Fold anchor in middle.



Insert anchor in hole and tap flush with wall.



Insert key to pop anchor open behind hollow wall (not necessary for thick or solid walls). Do not force or hammer key.

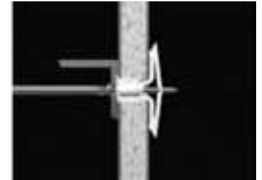

Place item over anchor and tighten until screw is flush with fixture. Then, stop.

PART#	UPC#	SIZE	WT. PER PKG.	STD. PKG./MSTR. SLEEVE	SUGGESTED TRADE LIST PRICE PER
MTB	73962	3/8-1/2	.22	50 Anchors	23.96/ea
MTC	73963	5/8-3/4	.25	50 Anchors	27.58/ea

OTHER SIZES AND QUANTITIES AVAILABLE BY REQUEST TOGGLER® IS A REGISTERED TRADEMARK

### ULTIMATE TENSILE PULL-OUT VALUES [lb]

PART#	GRIP RANGE	DRILL DIA.	SCREW SIZE	3/8" DRYWALL	1/2" DRYWALL	5/8" DRYWALL
MTB	3/8 - 1/2	5/16	#8	97	142	102 <sup>3</sup>
MTC	5/8 - 3/4	5/16	#8	-	-	159

### ULTIMATE SHEAR [lb]

PART#	GRIP RANGE	DRILL DIA.	SCREW SIZE	3/8" DRYWALL	1/2" DRYWALL	5/8" DRYWALL
MTB	3/8 - 1/2	5/16	#8	126	167	214 <sup>3</sup>
MTC	5/8 - 3/4	5/16	#8	-	-	237



## PLASTIC TOGGLES

Stays in place if screw is removed. Ideal product for sheetrock.

PART#	UPC#	SIZE & WALL DIA.	DRILL PER PKG.	SCREW PKG.	WT. PER PKG.	STD. PKG./MSTR. SLEEVE	SUGGESTED TRADE LIST PRICE PER
JCPT1	80970	3/8	5/16	#8	.55	100	29.41/c
JCPT2	80971	1/2	5/16	#8	.57	100	32.89/c
JCPT3	80972	5/8	5/16	#8	.59	100	34.06/c

ORDER SCREWS SEPARATELY - #8 DIAMETER - SEE SECTION A - SCREWS

OTHER SIZES AND QUANTITIES AVAILABLE BY REQUEST



## PLASTIC TOGGLE ANCHOR KITS

Plastic Toggles • Pan Head "Combo" Sheet Metal Screws

PART#	UPC NO.	SIZE/WALL THICKNESS	DRILL SIZE	QTY.	SIZE	ITEM	WT. PER PKG.	STD. PKG./MSTR. SLEEVE	SUGGESTED TRADE LIST PRICE PER
PTK1	20480	3/8	5/16	50	3/8	Plastic Toggles	.67	1	15.18/ea kit
				50	8 x 1 1/2	Pan Combo Screws			
PTK2	20485	1/2	5/16	50	1/2	Plastic Toggles	.67	1	16.87/ea kit
				50	8 x 1 1/2	Pan Combo Screws			
PTK3	20490	5/8	5/16	50	5/8	Plastic Toggles	.65	1	17.36/ea kit
				50	8 x 1 1/2	Pan Combo Screws			

OTHER SIZES AND QUANTITIES AVAILABLE BY REQUEST

# ANCHORING DEVICES

## HOLLOW BLOCK T-ANCHORS

STEEL ZINC



PART#	UPC#	DIAMETER	LENGTH	THREAD LENGTH	DRILL SIZE	WT. PER PKG.	STD. PKG./MSTR SLEEVE	SUGGESTED TRADE LIST PRICE PER
JTA14134	80830	1/4	1 3/4	1	5/16	.93	25	295.05/c
JTA14212	80831	1/4	2 1/2	1 3/4	5/16	1.12	25	309.70/c
JTA14314	80832	1/4	3 1/4	2 5/8	5/16	.89	25	319.60/c
JTA516212	80833	5/16	2 1/2	1 5/8	5/16	1.60	25	322.16/c
JTA516314	80834	5/16	3 1/4	2 3/8	5/16	2.03	25	334.52/c
JTA516334	80835	5/16	3 3/4	2 7/8	5/16	2.31	25	351.59/c
JTA38314	80836	3/8	3 1/4	2 1/4	3/8	2.88	25	383.71/c
JTA38334	81143	3/8	3 3/4	2 3/4	3/8	3.05	25	393.48/c
JTA38412	81146	3/8	4 1/2	3 1/2	3/8	3.59	25	430.35/c

OTHER SIZES AND QUANTITIES AVAILABLE BY REQUEST

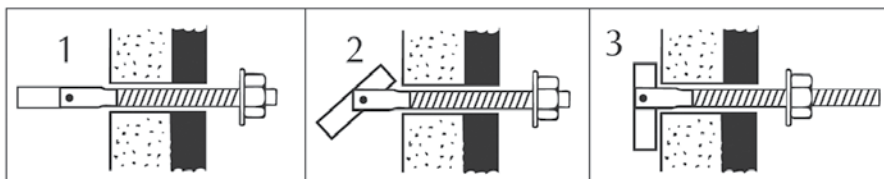

1. Drill hole using proper diameter and insert T-Anchor with washer and hex nut attached through item to be fastened.
2. Give it a quarter turn; retaining bar drops into place.
3. Tighten nut until a firm resistance is attained.

## HOLLOW WALL SCREW ANCHORS DRIVE POINT

STEEL ZINC

Includes Combo Head Machine Screw



⊕ Phillips

PART#	UPC#	SIZE & WALL THICKNESS	GRIP RANGE	DRILL SIZE	WT. PER PKG.	STD. PKG./MSTR SLEEVE	SUGGESTED TRADE LIST PRICE PER
J6721	80837	1/8 Short	1/8 - 1/2	5/16	1.37	100/500	46.48/c
J6726	80838	1/8 Long	1/8 - 13/16	5/16	1.84	100	47.73/c

OTHER SIZES AND QUANTITIES AVAILABLE BY REQUEST

## HOLLOW WALL SCREW ANCHORS

STEEL ZINC

Includes Combo Head Machine Screw



⊖ Slotted

⊕ Phillips

PART#	UPC#	SIZE & WALL THICKNESS	GRIP RANGE	DRILL SIZE	WT. PER PKG.	STD. PKG./MSTR SLEEVE	SUGGESTED TRADE LIST PRICE PER
J1001	80839	1/8 X-Short	1/16 - 1/4	5/16	.91	100	40.57/c
J1002	80840	1/8 Short	1/8 - 1/2	5/16	1.36	100	41.38/c
J1003	80841	1/8 Long	5/8 - 7/8	5/16	1.81	100	44.53/c
J1004	80842	3/16 Short	1/8 - 5/8	7/16	3.45	100	81.74/c
J1005	80843	3/16 Long	5/8 - 1 3/16	7/16	2.15	50	100.04/c
1008	18635	3/16 X-Long	1 1/4 - 1 3/4	7/16	4.85	100	163.55/c
J1006	80844	1/4 Short	1/8 - 5/8	1/2	2.81	50	118.79/c
J1007	80845	1/4 Long	5/8 - 1 3/16	1/2	3.65	50	134.89/c

OTHER SIZES AND QUANTITIES AVAILABLE BY REQUEST

# ANCHORING DEVICES



## MACHINE SCREW LEAD ANCHORS

One Setting Tool Included in Each Jar of Anchors

PART#	UPC#	SIZE	HOLE SIZE	ANCHOR LENGTH	WT. PER PKG.	STD. PKG./MSTR. SLEEVE	SUGGESTED TRADE LIST PRICE PER
J1401	83155	6-32	5/16	17/32	.81	100	48.78/c
J1402	80846	8-32	5/16	17/32	.91	100	49.08/c
J1403	80847	10-24	3/8	11/16	1.78	100	49.73/c
J1404	80848	10-32	3/8	1/2	1.88	100	49.73/c
J1405	80849	12-24	1/2	5/8	3.82	100	70.25/c
J1406	80850	1/4-20	1/2	7/8	3.80	100	56.00/c
1406M	11122	1/4-20	1/2	7/8	36.07	1000	450.59/m
J1407	80851	5/16-18	5/8	1 1/16	6.69	100	141.02/c
J1408	80852	3/8-16	3/4	1 5/16	5.14	50	142.24/c
1408M	11124	3/8-16	3/4	1 5/16	103.13	1000	1332.72/m
J1409	80853	1/2-13	7/8	1 9/16	8.97	50	173.20/c
1409V	11127	1/2-13	7/8	1 9/16	44.50	500	2055.78/m
1409M	11125	1/2-13	7/8	1 9/16	89.00	1000	2055.78/m
1411	17847	3/4-10	1-1 1/4	1 3/4	12.82	25	640.40/c

OTHER SIZES AND QUANTITIES AVAILABLE BY REQUEST

Not recommended for cement ceiling applications. Please note that machine screw anchors have a lead outer gripping shell. In applications where lead is considered dangerous, we do not recommend their use.

## MACHINE SCREW LEAD ANCHOR SETTING TOOLS

STEEL ZINC

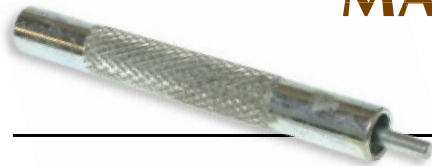

PART#	UPC#	SIZE	WT. PER PKG.	STD. PKG.	SUGGESTED TRADE LIST PRICE PER
1401ST	17900	6-32	.04	1	6.01/ea
1402ST	17905	8-32	.07	1	5.13/ea
1403ST	17910	10-24	.08	1	6.14/ea
1404ST	17915	10-32	.14	1	6.14/ea
1405ST	17920	12-24	.16	1	8.88/ea
1406ST	17925	1/4-20	.17	1	6.81/ea
1407ST	17930	5/16-18	.27	1	7.27/ea
1408ST	17935	3/8-16	.38	1	7.66/ea
1409ST	17940	1/2-13	.58	1	14.81/ea

OTHER SIZES AND QUANTITIES AVAILABLE BY REQUEST

## RAPID-SET® TOOLS

The fastest, easiest and most reliable way to install machine screw lead (caulk-in) anchors



- For machine screw lead (caulk-in) anchor sizes 1/4" and 3/8".
- Designed for use with power tools.
- Automatically sets anchor just below the surface.
- Maximizes expansion of bottom portion of lead sleeve.

PART#	UPC#	SIZE	WT. PER PKG.	STD. PKG.	SUGGESTED TRADE LIST PRICE PER
MRST1420	25110	1/4-20	.14	1	112.39/ea
MRST3816	25112	3/8-16	.26	1	159.80/ea

\*Note: Rapid-Set Tools draw the anchor's internal insert up into the anchor's outer sleeve; this installation process eliminates the need to maintain a back bearing surface (required by hammer setting tools).

# ANCHORING DEVICES

## MULTI-PURPOSE ANCHORS

STEEL ZINC



- Light-Duty Hammer-Drive Concrete and Masonry Anchors
- Specified for anchorage into concrete, block and brick
- As simple as using a nail – drive into predrilled holes in concrete

PART#	DRILL BIT SIZE	TOTAL LENGTH	MIN. EMBEDMENT	CLEARANCE HOLE SIZE
RD4158	1/4	1 1/2	1 1/4	5/16
RD4200	1/4	2	1 1/4	5/16
RD4212	1/4	2 1/2	1 1/4	5/16
RD4300	1/4	3	1 1/4	5/16

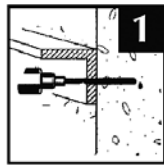

1  
Drill a proper-sized diameter hole 1/2" deeper than the required embedment.

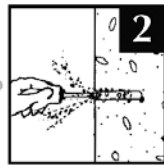

2  
Clean hole.

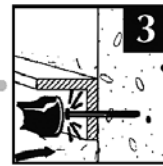

3  
Insert anchor through material to be fastened and drive with hammer until head is flush with surface.

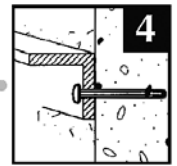

4  
Multi-Purpose Anchor is now set.

PART#	UPC#	SIZE	WT. PER PKG.	STD. PKG./MSTR. SLEEVE	SUGGESTED TRADE LIST PRICE PER
RD4158	74488	1 1/2	2.43	100	36.32/c
RD4200	74490	2	2.83	100	44.39/c
RD4212	74492	2 1/2	3.24	100	53.98/c
RD4300	74494	3"	3.64	100	60.70/c

OTHER SIZES AND QUANTITIES AVAILABLE BY REQUEST

## MULTI-PURPOSE ANCHORS

STEEL ZINC



**Tie Wire Anchors** - For acoustical ceilings and suspended electrical fixtures.

**Pipe Hanging Anchors** - For sprinkler, water lines, steam/gas and electrical conduits. Available in 1/4-20 and 3/8-16 internal thread.

**Forming Anchors** - For wood attachments to concrete.

### Selection Guide

PART#	DRILL BIT SIZE	MIN. EMBEDMENT	HOLE SIZE I.D.
TD4112	1/4	1 1/8	9/32

PART#	INT. THREAD	DRILL BIT SIZE	MIN. EMBEDMENT
PD4112	1/4-20	3/16	1 1/4
PD8134	3/8-16	1/4	1 1/2

PART#	FIXTURE HOLE SIZE	DRILL BIT SIZE	MIN. EMBEDMENT
FD8234	5/16	1/4	1 1/4

PART#	UPC#	SIZE	ITEM	WT. PER PKG.	STD. PKG./MSTR. SLEEVE	SUGGESTED TRADE LIST PRICE PER
TD4112	73918	-	Multi-Purpose Tie Wire Anchor	3.21	100	146.62/c
PD4112	73924	1/4-20	Multi-Purpose Pipe Hanging Anchor Int Thread	2.56	100	136.90/c
PD8134	73925	3/8-16	Multi-Purpose Pipe Hanging Anchor Int Thread	5.84	100	165.44/c
FD8234	73915	2 3/4	Multi-Purpose Duplex Anchor	3.64	100	141.74/c

OTHER SIZES AND QUANTITIES AVAILABLE BY REQUEST



# ANCHORING DEVICES



## LAG SCREW SHIELDS

ALLOY ZINC DIE CAST  
Medium-Duty Application

A secure die cast expansion anchor of zinc rustproof alloy. Most effective for holding in brittle or soft masonry. The ideal product for mortar joints.

PART#	UPC#	LAG SCREW DIAMETER	HOLE SIZE	ANCHOR LENGTH	WT. PER PKG.	STD. PKG./MSTR. SLEEVE	SUGGESTED TRADE LIST PRICE PER
<b>SHORT</b>							
J1201	80854	1/4	1/2	1	1.06	50	56.94/c
J1202	80855	5/16	1/2	1 1/4	1.21	50	52.12/c
J1203	80856	3/8	5/8	1 3/4	2.19	50	84.00/c
J1204	80857	1/2	3/4	2	1.46	25	136.01/c
J1205	80858	5/8	7/8	2	2.74	25	208.77/c
J1206	83081	3/4	1	2	3.98	25	241.77/c
<b>LONG</b>							
J1207	80859	1/4	1/2	1 1/2	1.48	50	60.19/c
J1208	80860	5/16	1/2	1 3/4	1.45	50	61.35/c
J1209	80861	3/8	5/8	2	3.38	50	113.34/c
J1210	80862	1/2	3/4	3	2.98	25	173.11/c
J1211	80863	5/8	7/8	3 1/2	5.37	25	330.85/c
J1212	83086	3/4	1	3 1/2	3.32	25	445.92/c

OTHER SIZES AND QUANTITIES AVAILABLE BY REQUEST

## SNAKE+™ INTERNAL THREAD SELF-TAPPING ANCHORS

STEEL ZINC

No Hammer Required!



PART#	UPC#	THREAD SIZE	SIZE MIN. HOLE DEPTH	DRILL SIZE INTERNAL THREAD DEPTH	WT. PER PKG.	STD. PKG./MSTR. SLEEVE	SUGGESTED TRADE LIST PRICE PER
M6401SD	24187	3/8-16	1 5/8"	1 1/16"	2.70	50	57.32/ea
M6403SD	24188	1/2-13	2 1/2"	2 9/32"	8.20	50	226.63/ea
M6407SD	24192		3/8" Setting Tool		.41	1	14.75/ea
M6404SD	24189		1/2" Setting Tool		.42	1	23.25/ea



## DROP-IN ANCHORS

DOMESTIC • STEEL ZINC • 18-8 STAINLESS • 316 STAINLESS • MINI

One Setting Tool Furnished in Each Jar of Anchors

PART#	UPC#	SIZE	HOLE SIZE	ANCHOR LENGTH	WT. PER PKG.	STD. PKG./MSTR. SLEEVE	SUGGESTED TRADE LIST PRICE PER
<b>DOMESTIC STEEL ZINC</b>							
JDIA14D	77173	1/4-20	3/8	1	3.01	100	141.18/c
JDIA38D	77177	3/8-16	1/2	1 9/16	3.54	50	234.66/c
JDIA12D	50064	1/2-13	5/8	2	6.41	50	392.50/c
<b>STEEL ZINC</b>							
JDIA14	81870	1/4-20	3/8	1	2.29	100	64.20/c
DIA14CB	21860	1/4-20	3/8	1	5.83	250	268.80/m
DIA14M	17869	1/4-20	3/8	1	22.91	1000	173.14/m
JDIA38	81875	3/8-16	1/2	1 9/16	3.26	50	88.20/c
DIA38CB	21862	3/8-16	1/2	1 9/16	16.30	250	402.52/m
DIA38M	17879	3/8-16	1/2	1 9/16	58.00	1000	494.75/m
JDIA38L (Lipped)	28743	3/8-16	1/2	1 9/16	3.18	50	60.50/m

OTHER SIZES AND QUANTITIES AVAILABLE BY REQUEST

CONTINUED ON NEXT PAGE  
[www.metallics.us](http://www.metallics.us)

# ANCHORING DEVICES

CONTINUED

## DROP-IN ANCHORS

DOMESTIC • STEEL ZINC • MINI • 18-8 STAINLESS • 316 STAINLESS

One Setting Tool Furnished in Each Jar of Anchors



PART#	UPC#	SIZE	HOLE SIZE	ANCHOR LENGTH	WT. PER PKG.	STD. PKG./MSTR. SLEEVE	SUGGESTED TRADE LIST PRICE PER
<b>STEEL ZINC</b>							
JDIA12	81880	1/2-13	5/8	2	6.41	50	145.70/c
DIA12M	17884	1/2-13	5/8	2	115.80	1000	544.08/m
JDIA12L (Lipped)	28741	1/2-13	5/8	2	6.05	50	100.00/c
JDIA58	81881	5/8-11	7/8	2 1/2	8.91	25	296.60/c
JDIA34	81873	3/4-10	1	3 3/16	13.58	25	736.20/c
<b>MINI STEEL WITH LIP W/TOOL</b>							
JDIA14MINI	77185	1/4-20	3/8	5/8	1.71	100	42.50/c
JDIA38MINI	81877	3/8-16	1/2	3/4	3.33	100	88.20/c
JDIA12MINI	77184	1/2-13	5/8	1	6.67	100	120.00/c
<b>MINI STEEL W/NO TOOL</b>							
M6335	24196	1/4-20	3/8	5/8	6.26	100	55.00/c
M6322	24191	3/8-16	1/2	3/4	3.03	50	75.00/c
<b>18-8 STAINLESS</b>							
JDIA14SS	81872	1/4-20	3/8	1	2.54	100	385.54/c
JDIA38SS	81876	3/8-16	1/2	1 9/16	3.50	50	521.41/c
JDIA12SS	81883	1/2-13	5/8	2	6.25	50	917.13/c
JDIA58SS	81882	5/8-11	7/8	2 1/2	8.36	25	1778.50/c
<b>316 STAINLESS</b>							
JDIA141SS	90345	1/4-20	3/8	1	2.50	100	633.13/c
JDIA381SS	90349	3/8-16	1/2	1 9/16	3.50	100	770.16/c
JDIA121SS	90353	1/2-13	5/8	2	6.03	50	1724.43/c

OTHER SIZES AND QUANTITIES AVAILABLE BY REQUEST

## DROP-IN ANCHOR SETTING TOOLS

STEEL ZINC

For Setting Drop-In Anchors



PART#	UPC#	SIZE	WT. PER PKG.	STD. PKG.	SUGGESTED TRADE LIST PRICE PER
DIA14T	12181	1/4-20	.18	1	4.07/ea
DIA38T	12182	3/8-16	.24	1	6.10/ea
DIA12T	12183	1/2-13	.41	1	7.54/ea
DIA58T	12184	5/8-11	.51	1	14.07/ea
DIA34T	17890	3/4-10	1.03	1	13.04/ea

OTHER SIZES AND QUANTITIES AVAILABLE BY REQUEST

## SINGLE EXPANSION ANCHORS

ZINC ALLOY



PART#	UPC#	THREAD DIAMETER	HOLE SIZE	ANCHOR BODY LENGTH	WT. PER PKG.	STD. PKG./MSTR. SLEEVE	SUGGESTED TRADE LIST PRICE PER
JSEA14	81195	1/4	1/2	1	2.57	100	68.81/c
JSEA516	81196	5/16	5/8	1 1/4	2.44	50	105.68/c
JSEA38	81197	3/8	3/4	1 1/2	2.32	50	111.58/c
JSEA12	81198	1/2	7/8	2	3.04	25	237.84/c
JSEA58	81200	5/8	1	2 5/8	5.06	25	442.12/c

OTHER SIZES AND QUANTITIES AVAILABLE BY REQUEST

# ANCHORING DEVICES

## DOUBLE EXPANSION ANCHORS ZINC ALLOY



PART#	UPC#	THREAD DIAMETER	HOLE SIZE	ANCHOR BODY LENGTH	WT. PER PKG.	STD. PKG./MSTR. SLEEVE	SUGGESTED TRADE LIST PRICE PER
JDEA14	80872	1/4	1/2	1	2.94	100	137.59/c
JDEA516	80873	5/16	5/8	1 1/4	2.82	50	189.18/c
JDEA38	80874	3/8	3/4	1 1/2	4.48	50	250.16/c
DEA38M	90491	3/8	3/4	1 1/2	84.00	1000	958.13/m
JDEA12	80875	1/2	7/8	2	3.70	25	394.36/c
JDEA58	82397	5/8	1	2 1/4	5.15	25	481.92/c
DEA34	17802	3/4	1 1/4	2 7/8	9.97	20	708.50/c

OTHER SIZES AND QUANTITIES AVAILABLE BY REQUEST



## WOOD AND TAPPING SCREW LEAD ANCHORS

PART#	UPC#	SIZE	LENGTH	HOLE SIZE	WT. PER PKG.	STD. PKG./MSTR. SLEEVE	SUGGESTED TRADE LIST PRICE PER
J1301	80876	6-8	3/4	1/4	1.12	100/500	22.46/c
J1302	80877	6-8	1	1/4	1.47	100/500	26.25/c
J1303	80878	6-8	1 1/2	1/4	1.98	100/500	28.91/c
J1304	71907	10-14	3/4	5/16	1.43	100/500	35.56/c
J1305	80879	10-14	1	5/16	2.06	100/500	33.35/c
J1306	80880	10-14	1 1/2	5/16	2.97	100	45.88/c
J1307	80881	16-18	1	3/8	2.75	100	45.88/c
J1308	80882	16-18	1 1/2	3/8	3.59	100	62.35/c

OTHER SIZES AND QUANTITIES AVAILABLE BY REQUEST

Please note that wood and tapping screw lead anchors have a lead outer gripping shell. In applications where lead is considered dangerous, we do not recommend their use. Until U.S. Govt. Safety Regulations take a firm stand on their use, Metallics will continue to offer this product, As do many other fastener competitors.



## ROD COUPLING SLEEVE ANCHORS

Anchors Threaded Rod To Concrete Ceilings

PART#	UPC#	BOLT AND HOLE DIA.	BOLT LENGTH	WT. PER PKG.	STD. PKG./MSTR. SLEEVE	SUGGESTED TRADE LIST PRICE PER
JRCA381	81585	3/8	1 7/8	9.24	100	245.66/c
JRCA38	81586	3/8	2 1/8	4.97	50	204.67/c
RCA1212	81590	1/2	2 1/2	8.88	50	352.46/c
RCA12	32758	1/2	2 3/4	10.56	50	331.82/c

OTHER SIZES AND QUANTITIES AVAILABLE BY REQUEST

## FLAT HEAD SPLIT DRIVE ANCHORS



- Can be used in concrete, hard masonry and stone
- Load can be applied immediately
- High grade steel with a memory
- One piece, pre-expanded anchor
- Exact hole depth not required to set anchor
- Fast, permanent installation

PART#	UPC#	JAR UPC#	SIZE	MASONRY DRILL SIZE	WT. PER PKG.	STD. PKG./MSTR. SLEEVE	SUGGESTED TRADE LIST PRICE PER
JFSD141	81594	81594	1/4 x 1 1/2	1/4 x 4	1.22	50/250	68.43/c
JFSD142	81596	81596	1/4 x 2	1/4 x 4	1.58	50/250	77.91/c
JFSD1421	81598	81598	1/4 x 2 1/2	1/4 x 4	1.87	50/250	85.55/c
JFSD143	81600	81600	1/4 x 3	1/4 x 4	2.27	50	93.16/c
JFSD1431	81602	81602	1/4 x 3 1/2	1/4 x 6	1.35	25	102.59/c
JFSD144	81604	81604	1/4 x 4	1/4 x 6	1.50	25	112.13/c

OTHER SIZES AND QUANTITIES AVAILABLE BY REQUEST

# ANCHORING DEVICES

## SLEEVE ANCHORS

STEEL ZINC • 18-8 STAINLESS



\* = acorn nuts

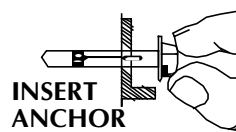
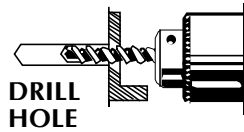

PART#	UPC#	DIAMETER	LENGTH	BOLT DIAMETER	FASTENS MATERIAL UP TO	DEPTH IN LENGTH	WT. PER PKG.	STD. PKG./MSTR. SLEEVE	SUGGESTED TRADE LIST PRICE PER
<b>STEEL ZINC – HEX (*ACORN)</b>									
J2505	77405	1/4	5/8	3/16	1/4	1	1.57	100/500	51.74/c
J2513*	80883	1/4	1 3/8	3/16	3/8	1	2.50	100	52.12/c
J2522*	80884	1/4	2 1/4	3/16	1 1/4	1	3.14	100	73.98/c
J2546	77446	1/4	4 3/4	3/16	3	1	6.30	100	112.11/c
J3114	80885	5/16	1 1/2	1/4	1/2	1	3.54	100	86.64/c
J3124	80886	5/16	2 1/2	1/4	1 1/2	1	5.29	100	113.52/c
J3717	80887	3/8	1 7/8	5/16	5/8	1 1/4	3.58	50	115.85/c
J3730	80888	3/8	3	5/16	1 3/4	1 1/4	5.15	50	149.52/c
J3732	77310	3/8	4	5/16	1 3/4	1 1/4	6.71	50	149.52/c
J5022	80889	1/2	2 1/4	3/8	3/4	1 1/2	3.24	25	163.97/c
J5026	80890	1/2	3	3/8	1 1/4	1 1/2	4.07	25	216.65/c
J5040	81131	1/2	4	3/8	2 1/2	1 1/2	5.02	25	357.50/c
J5060	81135	1/2	6	3/8	4 1/2	1 1/2	7.15	25	503.51/c
J6222	80891	5/8	2 1/4	1/2	1/4	2	6.00	25	314.83/c
J6242	81345	5/8	4 1/4	1/2	2 1/4	2	4.14	10	443.74/c
6242L	17131	5/8	4 1/4	1/2	1/2	2	20.70	50	299.90/c
J6256	81350	5/8	6	1/2	3 3/4	2	5.30	10	597.07/c
J7524	80892	3/4	2 1/2	5/8	1/2	2	4.07	10	472.86/c
J7542	81360	3/4	4 1/4	5/8	1 3/4	2 1/2	3.23	5	730.02/c
7542L	17133	3/4	4 1/4	5/8	1 3/4	2 1/2	32.30	50	693.52/c
J7562	81365	3/4	6 1/4	5/8	3 3/4	2 1/2	4.75	5	876.29/c
<b>STEEL ZINC – FLAT HEAD</b>									
J2513F	77213	1/4	1 3/8	3/16	3/8	1	2.31	100	80.14/c
J2520F	77220	1/4	2	3/16	1	1	2.28	100	122.16/c
J2530F	77225	1/4	3	3/16	2	1	3.40	100	127.76/c
J2552F	77252	1/4	5 1/4	3/16	4	1 1/4	5.90	100	183.99/c
3726F	77271	3/8	2 3/4	5/16	1	1 1/2	8.80	100	302.50/c
<b>STEEL ZINC – ROUND HEAD</b>									
J2512R	81089	1/4	1 1/4	3/16	1/4	1	1.89	100	80.14/c
J2520R	82620	1/4	2	3/16	1	1	2.52	100	77.63/c
J2526R	82626	1/4	2 3/4	3/16	1	1	3.27	100	101.29/c
<b>18-8 STAINLESS – HEX &amp; (*ACORN)</b>									
J2513SS*	82106	1/4	1 3/8	3/16	3/8	1	2.14	100	167.61/c
J2522SS*	82107	1/4	2 1/4	3/16	1 1/4	1	3.30	100	178.08/c
J3114SS	82108	5/16	1 1/2	1/4	1/2	1	4.50	100	136.02/c
J3124SS	82109	5/16	2 1/2	1/4	1 1/2	1	6.30	100	195.04/c
J3717SS	82111	3/8	1 7/8	5/16	5/8	1 1/4	3.62	50	296.03/c
J3730SS	82112	3/8	3	5/16	1 3/4	1 1/4	4.87	50	296.03/c
J5022SS	82113	1/2	2 1/4	3/8	3/4	1 1/2	3.12	25	384.70/c
J5026SS	82114	1/2	2 3/4	3/8	1 1/4	1 1/2	3.88	25	618.65/c
J5030SS	82116	1/2	3	3/8	1 1/2	2	4.02	25	476.65/c
J5040SS	82117	1/2	4	3/8	2 1/2	1 1/2	4.78	25	617.23/c
J6230SS	82118	5/8	3	1/2	1/4	2	6.60	25	784.69/c
J6242SS	82119	5/8	4 1/4	1/2	2 1/4	2	4.00	10	1,096.40/c
J7524SS	82121	3/4	2 1/2	5/8	1/2	2	5.00	10	1,183.35/c
J7542SS	82123	3/4	4 1/4	5/8	1 3/4	2 1/2	3.50	5	1,670.26/c
J7554SS	82124	3/4	5 1/2	5/8	3 3/4	2 1/2	4.70	5	1,975.24/c

OTHER SIZES AND QUANTITIES AVAILABLE BY REQUEST

[www.metallics.us](http://www.metallics.us)



# ANCHORING DEVICES

## Sleeve Anchors hold more because:

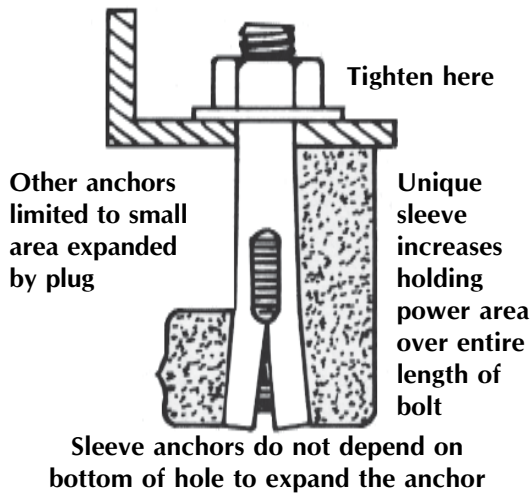

Sleeve anchors work under a true expansion principle, whereby the tightening of the nut forces the expansion of an outer sleeve over a tapered portion of the bolt. The sleeve also becomes a factor in a shear load application providing increased strength in addition to the anchor's bolt.

### SELECTING THE PROPER LENGTH SLEEVE ANCHOR

The selection of the proper length of sleeve anchor depends upon the thickness of the material to be fastened and the minimum depth of anchor required in masonry for maximum holding power. Add the thickness of the material (A) and the recommended depth for the anchor diameter (B) to determine the correct length of anchor to be used. (B) to determine the correct length of anchor to be used.

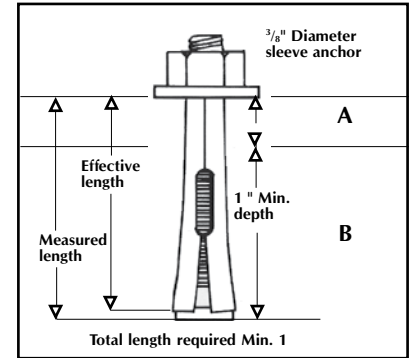

## WEDGE ANCHORS

STEEL ZINC • 18-8 STAINLESS • 316 STAINLESS • GALVANIZED

PART#	UPC#	DRILL DIAMETER	BODY LENGTH	THREAD LENGTH	MIN. DEPTH IN LENGTH	WT. PER PKG.	STD. PKG./ MSTR. SLEEVE	SUGGESTED TRADE LIST PRICE PER
<b>STEEL ZINC</b>								
JTS1134	80893	1/4	1 3/4	3/4	1 1/8	3.12	100	81.61/c
JTS1214	80894	1/4	2 1/4	3/4	1 1/8	3.68	100	92.05/c
JTS103	80895	1/4	3 1/4	3/4	1 1/8	4.57	100	104.56/c
TS5234	32037	5/16	2 3/4	1 1/8	1 1/2	4.69	100	330.34/c
TS516312	32029	5/16	3 1/2	1 1/8	1 1/2	7.56	100	336.75/c
JTS3218	80896	3/8	2 1/4	7/8	1 1/2	8.05	100	133.03/c
JTS3234	81165	3/8	2 3/4	1 1/8	1 1/2	9.30	100	140.15/c
JTS303	80898	3/8	3	1 1/8	1 1/2	9.92	100	143.84/c
TS3312	32007	3/8	3 1/2	1 1/8	1 1/2	12.81	100	170.30/c
JTS312	80899	3/8	3 3/4	1 1/8	1 1/2	5.85	50	164.08/c
TS312CCL	27176	3/8	3 3/4	1 1/8	1 1/2	29.03	250	525.00/m
JTS385	81614	3/8	5	1 1/8	1 1/2	7.45	50	188.85/c
JTS3612	81615	3/8	6 1/2	1 1/4	1 5/8	9.85	50	256.93/c
JTS4234	81166	1/2	2 3/4	1 1/4	2 1/4	9.10	50	225.37/c
TS4234M	39236	1/2	2 3/4	1 1/4	2 1/4	182.00	1000	585.98/m
JTS4334	81770	1/2	3 3/4	1 1/4	2 1/4	11.00	50	251.98/c
TS4334C	27177	1/2	3 3/4	1 1/4	2 1/4	22.36	100	244.42/c
JTS4414	81622	1/2	4 1/4	1 1/4	2 1/4	6.12	25	261.72/c
TS4414C	27178	1/2	4 1/4	1 1/4	2 1/4	24.30	100	253.87/c
JTS4512	81623	1/2	5 1/2	1 1/4	2 1/4	7.28	25	324.76/c
TS407	32033	1/2	7	1 1/4	2 1/4	9.55	25	395.18/c
TS4812	32050	1/2	8 1/2	1 1/4	2 1/4	20.82	25	487.08/c
JTS5312	81630	5/8	3 1/2	2	2 3/4	9.22	25	419.33/c
JTS5412	81631	5/8	4 1/2	2	2 3/4	10.48	25	460.72/c
JTS505	81632	5/8	5	2	2 3/4	11.60	25	482.45/c
JTS506	81633	5/8	6	2	2 3/4	19.00	25	471.44/c
TS508	32035	5/8	8 1/2	2	2 3/4	7.88	10	1046.60/c

OTHER SIZES AND QUANTITIES AVAILABLE BY REQUEST

CONTINUED ON NEXT PAGE  
www.metallics.us

# ANCHORING DEVICES

CONTINUED

## WEDGE ANCHORS

STEEL ZINC • 18-8 STAINLESS • 316 STAINLESS • GALVANIZED



PART#	UPC#	DRILL DIAMETER	BODY LENGTH	THREAD LENGTH	MIN. DEPTH IN LENGTH	WT. PER PKG.	STD. PKG./MSTR. SLEEVE	SUGGESTED TRADE LIST PRICE PER
<b>STEEL ZINC</b>								
JTS6414	81640	3/4	4 1/4	2	3 1/4	12.09	20	600.67/c
TS6434	32041	3/4	4 3/4	2	3 1/4	14.00	20	661.11/c
TS6512	32042	3/4	5 1/2	2	3 1/4	14.70	20	661.35/c
JTS6614	81643	3/4	6 1/4	2	3 1/4	8.25	10	820.74/c
TS6701	32045	1	9	2 1/4	3 1/4	2.45	5	2067.60/c
<b>18-8 STAINLESS</b>								
JTS1134SS	80900	1/4	1 3/4	3/4	1 1/8	1.55	50	217.10/c
JTS1214SS	80901	1/4	2 1/4	3/4	1 1/8	1.85	50	248.70/c
JTS103SS	80902	1/4	3 1/4	3/4	1 1/8	2.50	50	284.07/c
JTS144SS	71751	1/4	4	3/4	1 1/8	3.13	50	976.93/c
JTS3218SS	80903	3/8	2 1/4	7/8	1 1/2	4.02	50	402.11/c
JTS303SS	80904	3/8	3	1 1/8	1 1/2	5.07	50	474.72/c
JTS312SS	80905	3/8	3 3/4	1 1/8	1 1/2	5.96	50	683.93/c
JTS385SS	95250	3/8	5	1 1/8	1 1/2	7.38	50	692.00/c
JTS3612SS	95255	3/8	6 1/2	1 1/4	1 5/8	5.19	25	1221.53/c
JTS4234SS	82126	1/2	2 3/4	1 1/4	2 1/4	4.11	25	783.56/c
JTS4334SS	82127	1/2	3 3/4	1 1/4	2 1/4	5.77	25	908.04/c
TS4414SS	32028	1/2	4 1/4	1 1/4	2 1/4	6.21	25	1706.72/c
JTS4512SS	95260	1/2	5 1/2	1 1/4	2 1/4	14.99	25	1700.30/c
JTS407SS	82125	1/2	7	1 1/4	2 1/4	9.98	25	603.93/c
JTS6414SS	90324	3/4	4 1/4	2	3 1/4	9.44	10	972.27/c
TS6614SS	32048	3/4	6 1/4	2	3 1/4	14.80	10	1299.96/c
JTS607SS	90308	3/4	7	2	3 1/4	15.02	10	2497.50/c
<b>316 STAINLESS</b>								
JTS1024SS	90292	1/4	2 1/4	3/4	1 1/8	3.70	100	150.77/c
JTS1034SS	90298	1/4	3 1/4	3/4	1 1/8	5.54	100	500.94/c
JTS3033SS	90305	3/8	3	1 1/8	1 1/2	5.30	50	1760.26/c
JTS4414316SS	95261	1/2	4 1/4	1 1/4	2 1/4	6.55	25	5290.00/c
<b>GALVANIZED</b>								
JTS380G	81192	3/8	2 1/4	7/8	1 1/2	4.60	50	264.51/c
JTS383G	81193	3/8	3	1 1/8	1 1/2	5.08	50	229.94/c
JTS5312G	81194	5/8	3 1/2	2	2 3/4	9.44	25	732.52/c

OTHER SIZES AND QUANTITIES AVAILABLE BY REQUEST

## TIE WIRE WEDGE ANCHORS

ZINC WITH STAINLESS STEEL CLIP

For various overhead suspension applications



PART#	UPC#	DIAMETER	LENGTH	MIN. LENGTH IN DEPTH	WT. PER PKG.	STD. PKG./MSTR. SLEEVE	SUGGESTED TRADE LIST PRICE PER
JTWA214	80906	1/4	2 3/16	1 3/8	2.63	100	132.57/c
JTWA57	81409	5/16	1 1/2	1	2.51	100	134.04/c

OTHER SIZES AND QUANTITIES AVAILABLE BY REQUEST

# ANCHORING DEVICES

## HAMMER DRIVE WEDGE ANCHORS

STEEL ZINC



*A superior alternative to traditional wedge anchors*

- Installs six times faster than an ordinary wedge-type anchor.
- Easily installs through pre-drilled holes in plates and footings – no need for templates.
- No special tools required.
- Tensions during setting process.
- Deforms the concrete to set, eliminating creep and loss of pre-load.
- Faster, easier and more consistent installation.

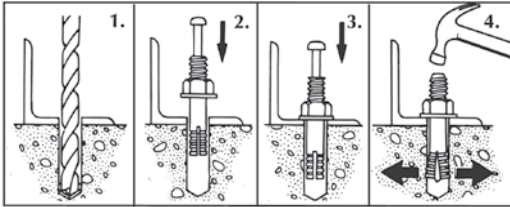

### INSTALLATION:

1. Drill hole.
2. Preset nut and washer for desired embedment.
3. Hammer center pin until it is aligned with top of the bolt.
4. Anchor is set.

PART#	UPC#	DRILL DIAMETER	BODY LENGTH	THREAD LENGTH	DRILL SIZE	WT. PER PKG.	STD. PKG./MSTR. SLEEVE	SUGGESTED TRADE LIST PRICE PER
<b>ZINC CHROMATE</b>								
JHW14134	80907	1/4	1 3/4	5/8	1/4	1.72	50	137.29/c
JHW14238	80908	1/4	2 3/8	3/4	1/4	2.05	50	145.51/c
JHW5162	80909	5/16	2	3/4	5/16	2.70	50	178.24/c
JHW516234	80910	5/16	2 3/4	1	5/16	3.51	50	207.04/c
JHW38238	80911	3/8	2 3/8	1	3/8	4.35	50	225.37/c
JHW38312	80912	3/8	3 1/2	1 1/8	3/8	6.05	50	313.51/c
JHW38434	82630	3/8	4 3/4	1 1/8	3/8	8.30	50	454.92/c
JHW12234	82635	1/2	2 3/4	1/2	1/2	4.80	25	372.60/c
JHW12312	82640	1/2	3 1/2	1/2	1/2	5.92	25	391.78/c
JHW12434	82645	1/2	4 3/4	2	1/2	7.46	25	573.80/c
JHW126	82650	1/2	6	2	1/2	9.07	25	858.93/c
JHW584	82655	5/8	4	1 5/8	5/8	10.76	25	596.38/c
JHW58434	82660	5/8	4 3/4	1 5/8	5/8	12.22	25	825.89/c
JHW586	82665	5/8	6	2	5/8	6.03	10	1,018.75/c
JHW345	82670	3/4	5	2	3/4	7.36	10	1,104.54/c
JHW346	82675	3/4	6	2	3/4	8.39	10	1,618.74/c
JHW34712	82680	3/4	7 1/2	2	3/4	9.21	10	1,988.27/c

OTHER SIZES AND QUANTITIES AVAILABLE BY REQUEST

## WALLCLAW HAMMER-IN DRYWALL ANCHORS

NYLON

MADE IN USA



INSTALLATION

REMOVAL



- No drilling required.
- Installs in seconds.
- Industrial strength.
- Works in 1/2" and 5/8" Sheet Rock
- Easy to remove.
- Leaves only small slit.

PART#	UPC#	WT. PER PKG.	STD. PKG./MSTR. SLEEVE	SUGGESTED TRADE LIST PRICE PER
MWCA25	83721	.28	25	21.53/ea
MWCA50	83723	.52	50	26.60/ea
MWCA100	83727	.99	100	37.52/ea
MWCA500	83728	4.95	500	112.76/ea

OTHER SIZES, MATERIALS AND QUANTITIES AVAILABLE BY REQUEST

WALLCLAW ANCHORS IS A TRADEMARK OF WALLCLAW ANCHORS, LLC

## WEDGE ANCHORS STRONG-BOLT™

STEEL ZINC

For Cracked and Uncracked Concrete



### INSTALLATION STEPS

1. Drill hole with carbide tipped masonry drill in base material the same size as the nominal diameter of the anchor.
2. Drill hole to proper embedment depth and blow clean.
3. Assemble anchor with nut and washer flush with top of anchor.
4. Place the anchor in fixture and drive into the hole until washer and nut are tight against fixture.
5. Tighten to the required installation torque. **DO NOT USE AN IMPACT WRENCH TO SET OR TIGHTEN.**

### FEATURES:

- Tri-Segmented clip is able to adjust independently increasing follow-up expansion should the hole increase in size as a result of a crack.
- 316 stainless clip with superior corrosion resistance.
- Head is stamped with Simpson Strong-Tie® “=” sign and size ID.
- Carbon-steel zinc plated stud with 316 stainless-steel clip.

### Selection Guide

PART#	THREAD LENGTH	(THREADS) PER INCH	DRILL SIZE	OVERALL LENGTH
SWA3830	1¼	16	¾	3
SWA3836	2¾	16	¾	3¾
SWA3850	3⅝	16	¾	5
SWA1236	2⅛	13	½	3¾
SWA1244	2⅞	13	½	4¼
SWA1254	3⅞	13	½	5½
SWA1270	5⅜	13	½	7
SWA5850	3⅜	11	⅝	5
SWA5860	4⅜	11	⅝	6
SWA5870	5⅜	11	⅝	7
SWA5884	5¾	11	⅝	8½

### TEST CRITERIA:

Strong-Bolt™ Wedge anchor has been tested in accordance with ICC-ES's *Acceptance Criteria for Mechanical Anchors in Concrete Elements (AC193)* and *ACI 355.2* for the following in cracked and uncracked concrete:

- Static tension and shear loading in cracked and uncracked concrete
- Seismic and wind loading in cracked and uncracked concrete
- Performance in cracked concrete
- Performance in lightweight concrete over metal deck

**CODES:** ICC-ES ESR-1771; City of L.A. RR25705; Florida FL 11506.6

PART#	UPC#	DIAMETER	LENGTH	WT. PER PKG.	STD. PKG./ MSTR. SLEEVE	SUGGESTED TRADE LIST PRICE PER
SWA3830	14978	¾	3	4.94	50	140.50/ea
SWA3836	14981	¾	3¾	5.92	50	177.67/ea
SWA3850	14986	¾	5	7.36	50	205.24/ea
SWA1236	15451	½	3¾	5.77	25	124.94/ea
SWA1244	15454	½	4¼	6.00	25	129.17/ea
SWA1254	15458	½	5½	7.53	25	141.77/ea
SWA1270	15463	½	7	9.32	25	157.45/ea
SWA5850	16236	⅝	5	4.69	10	82.60/ea
SWA5860	16239	⅝	6	5.37	10	91.48/ea
SWA5870	16243	⅝	7	7.60	10	97.66/ea
SWA5884	16247	⅝	8½	8.40	10	108.23/ea



# ANCHORING DEVICES



## HAND DRIVE PINS

STEEL ZINC

PART#	UPC#	HEAD SIZE	LENGTH	WT. PER PKG.	STD. PKG. MSTR/SLEEVE	SUGGESTED TRADE LIST PRICE PER
JDPL1	81606	1/4	1/2	.12	50/250	18.86/c
JDP1	80916	1/4	1/2	.46	100/500	15.04/c
JDP2	80917	1/4	3/4	.56	100/500	16.05/c
JDP3	80918	1/4	1	.72	100/500	17.00/c
JDP4	80919	1/4	1 1/4	.80	100/500	19.44/c
JDP5	80920	1/4	1 1/2	.87	100/500	19.69/c
JDP6	80921	1/4	2	1.18	100/500	25.79/c
JDP7	80922	1/4	2 1/2	1.28	100/500	27.87/c
JDP8	81595	1/4	3	1.32	100/500	38.06/c

OTHER SIZES AND QUANTITIES AVAILABLE BY REQUEST

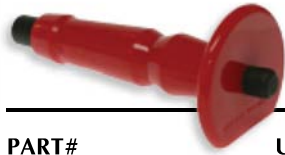

## HAND DRIVE TOOL

For Hand Drive Pins

PART#	UPC#	WT. PER PKG.	STD. PKG. MSTR/SLEEVE	SUGGESTED TRADE LIST PRICE PER
HDT2	18720	.51	1	33.60/ea

E

## HEAT TEMPERED FLUTED MASONRY NAILS

STEEL ZINC

For greater bearing surface use with sae or fender washer. We recommend for attaching wire screening over Styrofoam and block before stucco.



PART#	UPC#	SIZE	WT. PER PKG.	APPROX COUNT	STD. PKG. MSTR/SLEEVE	SUGGESTED TRADE LIST PRICE PER
MN1TM	21242	1	2.60	435	1 Jar	12.98/ea
MN112TM	21243	1 1/2	2.55	225	1 Jar	12.98/ea
MN2TM	21244	2	2.64	180	1 Jar	13.10/ea
MN212TM	21245	2 1/2	2.63	190	1 Jar	13.14/ea
MN3TM	21246	3	2.62	135	1 Jar	13.71/ea

OTHER SIZES AND QUANTITIES AVAILABLE BY REQUEST

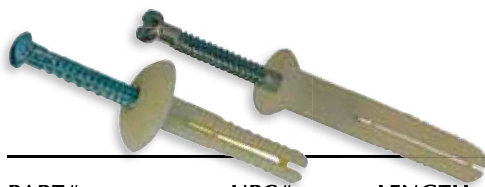

## HAMMER DRIVE NAIL-IN WHITE ANCHORS

STEEL ZINC/NYLON

PART#	UPC#	LENGTH	HOLE SIZE	WT. PER PKG.	STD. PKG./MSTR. SLEEVE	SUGGESTED TRADE LIST PRICE PER
<b>ROUND HEAD</b>						
J3161R	80956	1	3/16	.53	100/500	24.65/c
J141R	80957	1	1/4	.60	100/500	30.80/c
J1415R	80958	1 1/2	1/4	.89	100	32.66/c
J142R	80959	2	1/4	1.09	100	40.07/c
<b>FLAT HEAD</b>						
J3161F	80960	1	3/16	.50	100/500	24.65/c
J1434F	80961	3/4	1/4	.41	100/500	29.85/c
J141F	80962	1	1/4	.62	100/500	30.86/c
J1415F	80963	1 1/2	1/4	.87	100	32.66/c
J142F	80964	2	1/4	1.09	100	40.07/c
<b>TRUSS - MUSHROOM HEAD</b>						
J3161T	80965	1	3/16	.55	100/500	24.65/c
J1434T	80966	3/4	1/4	.50	100/500	29.85/c
J141T	80967	1	1/4	.63	100/500	30.86/c
J1415T	80968	1 1/2	1/4	.87	100	32.66/c
J142T	80969	2	1/4	1.21	100	40.07/c

OTHER SIZES AND QUANTITIES AVAILABLE BY REQUEST

# ANCHORING DEVICES



## HAMMER DRIVE NAIL-IN ANCHORS

STEEL ZINC • 18-8 STAINLESS

PART#	UPC#	DIAMETER	LENGTH	HOLE SIZE	WT. PER PKG	STD. PKG./MSTR. SLEEVE	SUGGESTED TRADE LIST PRICE PER
<b>STEEL ZINC</b>							
JNA316	80923	3/16	7/8	3/16	.98	100/500	27.83/c
JNA140	80924	1/4	3/4	1/4	1.59	100/500	39.29/c
NA140M	19485	1/4	3/4	1/4	15.90	1000	272.88/m
JNA141	80925	1/4	1	1/4	1.95	100/500	40.07/c
NA141M	90322	1/4	1	1/4	19.50	1000	214.63/m
NA1415M	75044	1/4	1	1/4	97.50	5000	225.74/m
NA14110M	74476	1/4	1	1/4	195.00	10000	215.91/m
JNA1414	80926	1/4	1 1/4	1/4	2.11	100	44.23/c
NA1414V	19462	1/4	1 1/4	1/4	10.55	500	36.09/c
JNA1415	80927	1/4	1 1/2	1/4	2.37	100	49.36/c
JNA142	80928	1/4	2	1/4	2.98	100	64.13/c
JNA143	80867	1/4	3	1/4	4.08	100	75.32/c
<b>18-8 STAINLESS</b>							
JNA141SS	90387	1/4	1	1/4	1.94	100	100.14/c
JNA1414SS	81987	1/4	1 1/4	1/4	2.25	100	100.15/c
JNA142SS	91381	1/4	2	1/4	3.33	100	215.44/c

OTHER SIZES AND QUANTITIES AVAILABLE BY REQUEST



## SLEDGE HAMMER

3-Lb. – Wooden Handle

PART#	UPC#	HEAD WEIGHT	WT. PER PKG	STD. PKG.	SUGGESTED TRADE LIST PRICE PER
HAM3	18700	3	3.53	1	49.29/ea

Slotted

Phillips



## ARROW ANCHOR KIT

For Hollow Wall

- Easy Installation And Removal
- Leaves Only A Small Slit Not A Large Hole
- Sheetrock Or Wallboard
- Use With #6 Or #8 X 1" Sheetmetal Screw

### AAK68 Kit Contains

PART#	UPC#	QTY.	SIZE	ITEM	WT. PER PKG.	SUGGESTED TRADE LIST PRICE PER
AAK68	18649	75	-	Hollow Wall Anchor	1.06	37.36/ea kit
		75	6/8 x 1	Phillips Combo T/S		
		1	#2 x 2	Phillips Power Bit		

OTHER SIZES AND QUANTITIES AVAILABLE BY REQUEST

### JAA68 Anchors Only

PART#	UPC#	SIZE	DESCRIPTION OF CONTENTS	WT. PER PKG.	SUGGESTED TRADE LIST PRICE PER
JAA68	18643	1/8 x 1/2 x 1 7/16	Hollow Wall Anchors	.77	40.79/ea kit

OTHER SIZES AND QUANTITIES AVAILABLE BY REQUEST

# ANCHORING DEVICES

## ASSORTED PLASTIC ANCHORS

### "Big Red" Conical Plastic Anchor

PART#	UPC#	LENGTH	SCREW SIZE	HOLE SIZE	WT. PER PKG.	STD. PKG. MSTR. SLEEVE	SUGGESTED TRADE LIST PRICE PER
JRA1	80929	3/4	6-8	3/16	.10	100/500	4.23/c
JRA15	80930	7/8	8-10	3/16	.10	100/500	4.39/c
JRA2	80931	1	10-12	1/4	.18	100/500	5.05/c
RA22M	50086	1	10-12	1/4	2.53	2000	37.50/m
JRA3	80932	1 1/2	12-14	5/16	.31	100/500	9.53/c

OTHER SIZES AND QUANTITIES AVAILABLE BY REQUEST

### "Denver Blue" Conical Plastic Anchor

PART#	UPC#	LENGTH	SCREW SIZE	HOLE SIZE	WT. PER PKG.	STD. PKG. MSTR. SLEEVE	SUGGESTED TRADE LIST PRICE PER
JBA1	80933	3/4	6-8	3/16	.10	100/500	4.23/c
JBA15	80934	7/8	8-10	3/16	.09	100/500	4.39/c
JBA2	80935	1	10-12	1/4	.17	100/500	5.05/c
BA2M	19814	1	10-12	1/4	1.42	1000	39.20/m
JBA3	80936	1 1/2	12-14	5/16	.28	100/500	9.53/c

OTHER SIZES AND QUANTITIES AVAILABLE BY REQUEST

### "Super Yellow" Plastic Wall Anchor

PART#	UPC#	LENGTH	SCREW SIZE	HOLE SIZE	WT. PER PKG.	STD. PKG. MSTR. SLEEVE	SUGGESTED TRADE LIST PRICE PER
JSYA316	80940	1	6-8	3/16	.13	100/500	4.39/c
JSYA14	80941	1 1/4	8-10	1/4	.18	100/500	5.05/c
SYA14B	90205	1 1/4	8-10	1/4	13.21	10000	43.50/m
JSYA516	80942	1 5/8	12-14	5/16	.27	100/500	10.12/c

OTHER SIZES AND QUANTITIES AVAILABLE BY REQUEST

### "Gray Ribbed" Plastic Anchor

PART#	UPC#	LENGTH	SCREW SIZE	HOLE SIZE	WT. PER PKG.	STD. PKG. MSTR. SLEEVE	SUGGESTED TRADE LIST PRICE PER
JGA1	80953	7/8	6-8	3/16	.13	100/500	4.48/c
JGA2	80954	1	10-12	1/4	.18	100/500	5.05/c
JGA3	80955	1 1/4	14-16	5/16	.24	100/500	10.12/c

OTHER SIZES AND QUANTITIES AVAILABLE BY REQUEST

### "Collarless Vinyl" Wall Anchor

PART#	UPC#	LENGTH	SCREW SIZE	HOLE SIZE	WT. PER PKG.	STD. PKG. MSTR. SLEEVE	SUGGESTED TRADE LIST PRICE PER
J1105	71902	Red 1 1/2	8-10	15/64	.30	100/500	10.56/c
J1106	80945	Green 1	10-12	1/4	.25	100/500	5.26/c
J1107	80946	Green 1 1/4	10-12	1/4	.27	100/500	9.69/c
J1108	80947	Green 1 1/2	10-12	1/4	.35	100/500	14.81/c
J1110	80948	Blue 1	14	5/16	.31	100/500	7.37/c
J1111	80949	Blue 1 1/2	14	5/16	.41	100/500	9.44/c
J1112	71904	Blue 2	14	5/16	.51	100	19.80/c
J1114	80950	Orange 1 1/2	16-5/16	3/8	.39	50/250	12.16/c
J1115	80951	Orange 2	16-5/16	3/8	.50	50	15.30/c
J1116	80952	Orange 2 1/2	16-5/16	3/8	.67	50	17.38/c
J1119	71905	Gray 3	7/16	3/8	.47	50	54.80/c
J1120	71906	Black 2 1/2	9/16	1/2	.59	50	82.26/c

OTHER SIZES AND QUANTITIES AVAILABLE BY REQUEST

### "Expandet Nylon" Anchor

PART#	UPC#	LENGTH	SCREW SIZE	HOLE SIZE	WT. PER PKG.	STD. PKG. MSTR. SLEEVE	SUGGESTED TRADE LIST PRICE PER
JELR2	80943	Red 1 1/2	8	1/4	.26	100/500	19.13/c
JELR3	80944	Blue 1 3/4	12	5/16	.48	100/500	32.42/c

OTHER SIZES AND QUANTITIES AVAILABLE BY REQUEST



E

# ANCHORING DEVICES

**3 Anchors in 1 Kit!**

## ASSORTED PLASTIC ANCHOR KIT WAKTRIO

Three Of The Most Popular Style Anchors – Screws Included  
All In An E-Z To Store Plastic Case



**WAKTRIO Kit Contains**

PART#	UPC#	QTY.	SIZE	ITEM	WT. PER PKG.	SUGGESTED TRADE LIST PRICE PER
WAKTRIO	38990	25	6 x 1	Pan Combo Screw	.64	9.92/ea kit
		25	3/16	Red Plastic Anchors		
		25	10 x 1	Pan Combo Screw		
		25	1/4	Yellow Super Anchors		
		25	10 x 1	Pan Combo Screw		
		25	1/4	Red Plastic Anchors		

OTHER SIZES AND QUANTITIES AVAILABLE BY REQUEST



## RACEWAY ANCHOR KIT

NEED TO ANCHOR YOUR RACEWAY?

This kit contains screws and anchors for mounting plastic or metal raceway to sheetrock, wood, metal or masonry walls.



PART#	UPC#	DESCRIPTION	WT. PER PKG.	SUGGESTED TRADE LIST PRICE PER
RWAK1	20350	(40) 3/16 Plastic Anchors	.74	17.60/ea kit
		(20) 1/4 Plastic Anchors		
		(15) Self Drilling Plastic Anchors		
		(40) #6 x 1 Flat Head Phillips Sheet Metal Screws		
		(20) #8 x 1 1/2 Flat Head Phillips Sheet Metal Screws		
		(20) #10 x 1 Flat Head Phillips Sheet Metal Screws		
		(1) 3/16 x 4 Masonry Drill		
		(1) 1/4 x 4 Masonry Drill		



## 1/4" WALL ANCHOR KIT

**Kit Contains:**

- 500 pcs. – #10 x 1" Pan Head Combo Tapping Screws
- 500 pcs. – 1/4" Red Anchors
- 5 – 1/4" x 4" Masonry Drill Bits

PART#	UPC#	ITEM	DIAMETER	LENGTH	WT. PER PKG	STD. PKG/ MSTR SLEEVE	SUGGESTED TRADE LIST PRICE PER
WAK14V	20218	Red Anchors	1/4	1	4.35	500	59.75/ea kit
		Pan Hd Combo Screws	#10	1		500	
		Masonry Drill	1/4	4		5	

**METALLICS IS THE LARGEST ANCHOR KIT SOURCE IN AMERICA**

# ANCHORING DEVICES

# ATTENTION

ON LARGE ORDERS OF ANCHOR KITS — OUR PRICE CAN BE EVEN LOWER!

Please Call Us  
for  
Co-Labeling  
on Kits!

JAR DISPLAY CENTER  
Holds 18 Jars



**QUANTITY  
DISCOUNTS:**

10% DISCOUNT ON  
50-99 LIKE KITS

**OR**

15% DISCOUNT ON  
100+ LIKE KITS



# ANCHORING DEVICES



## "BIG RED" CONICAL PLASTIC WALL ANCHOR KITS

NOW WITH QUADRIVE OPTION!



**MASTER  
CARTONS  
CONTAIN:  
25 KITS  
18 JARS**

PART#	UPC#	SIZE	QTY	SIZE	ITEM	WT. PER PKG.	SUGGESTED TRADE LIST PRICE PER
WAK13 WAKJ13	20200/kit 20570/jar	3/16	100	3/16	Red Plastic Anchors		14.40/ea kit
			100	6 x 1	Pan Combo Screws		
			1	3/16	Masonry Drill		
WAK2	20245	3/16	100	3/16	Red Plastic Anchors		17.68/ea kit
			100	8 x 3/4	Pan Combo Screws		
			1	3/16	Masonry Drill		
WAK16 WAKJ16	20280/kit 20281/jar	3/16	100	3/16	Red Plastic Anchors		14.40/ea kit
			100	8 x 1	Pan Combo Screws		
			1	3/16	Masonry Drill		
WAK16T WAKJ16T	20284/kit 20285/jar	3/16	100	3/16	Red Plastic Anchors		14.40/ea kit
			100	8 x 1	<b>Pan Tri-Drive</b> 		
			1	3/16	Masonry Drill		
WAK16H WAKJ16H	20288/kit 20289/jar	3/16	100	3/16	Red Plastic Anchors		18.31/ea kit
			100	8 x 1	Hex Slotted Screws 1/4 Head		
			1	1/4	Hex Drive		
			1	3/16	Masonry Drill		
WAK16R WAKJ16R	20292/kit 20293/jar	3/16	100	3/16	Red Plastic Anchors		14.40/ea kit
			100	8 x 1	Pan Square Drive Screws		
			1	3/16	Masonry Drill		
WAK14D WAKJ14D	20208/kit 20760/jar	1/4	100	1/4	Red Plastic Anchors		20.30/ea kit
			100	10 x 1	Hex Slotted Screws 5/16 Head		
			1	1/4	Masonry Drill		
			1	5/16	Driver		
WAKJ14QD145	39174	1/4	100	1/4	Red Plastic Anchors		18.25/ea kit
			100	10 x 1 1/4	<b>QuaDrive</b> 5/16 		
			1	1/4	Masonry Drill		
WAK14 WAKJ14	20205/kit 20575/jar	1/4	100	1/4	Red Plastic Anchors		14.40/ea kit
			100	10 x 1	Pan Combo Screws		
			1	1/4	Masonry Drill		
WAK14T WAKJ14T	20446/kit 20447/jar	1/4	100	1/4	Red Plastic Anchors		14.40/ea kit
			100	10 x 1	<b>Pan Tri-Drive</b> 		
			1	1/4	Masonry Drill, 000R2B Bit		
WAK14H WAKJ14H	20207/kit 20580/jar	1/4	100	1/4	Red Plastic Anchors		16.46/ea kit
			100	10 x 1	Hex Slotted Screws 5/16 Head		
			1	1/4	Masonry Drill		
WAK14Q WAKJ14Q	20206/kit 20583/jar	1/4	100	1/4	Red Plastic Anchors		16.46/ea kit
			100	10 x 1	Hex Slotted Screws 1/4 Head		
			1	1/4	Masonry Drill		

OTHER SIZES AND QUANTITIES AVAILABLE BY REQUEST

CONTINUED ON NEXT PAGE  
[www.metallics.us](http://www.metallics.us)

# ANCHORING DEVICES



CONTINUED  
**"BIG RED"**  
**CONICAL PLASTIC  
 WALL ANCHOR KITS**



**MASTER  
 CARTONS  
 CONTAIN:  
 25 KITS  
 18 JARS**

E

PART#	UPC#	SIZE	QTY.	SIZE	ITEM	WT. PER PKG.	SUGGESTED TRADE LIST PRICE PER	
WAK14R WAKJ14R	20445/kit 20590/jar	1/4	100	1/4	Red Plastic Anchors		.95 .93	15.51/ea kit
			100	10 x 1	Pan Combo Screws			
			1	1/4	Masonry Drill			
WAK141 WAKJ141	23841/kit 20584/jar	1/4	100	1/4	Red Plastic Anchors		1.00 1.00	15.24/ea kit
			100	10 x 1 1/4	Pan Combo Screws			
			1	1/4	Masonry Drill			
WAK141H	20588/kit	1/4	100	1/4	Red Plastic Anchors		1.02	16.46/ea kit
			100	10 x 1 1/4	Hex Washer Head Screws			
			1	1/4	Masonry Drill			
WAK14SS WAKJ14SS	99414/kit 99420/jar	1/4	100	1/4	Red Plastic Anchors		.96 .94	37.23/ea kit
			100	10 x 1	Pan Slotted Screws S.S.			
			1	1/4	Masonry Drill			
WAK14HSS WAKJ14HSS	99415/kit 99419/jar	1/4	100	1/4	Red Plastic Anchors		1.04 1.02	40.11/ea kit
			100	10 x 1	5/16 Hex Slotted Screws S.S.			
			1	1/4	Masonry Drill			
WAK14SSPH WAKJ14SSPH	99418/kit 99417/jar	5/16	100	1/4	Red Plastic Anchors		.96 .96	37.23/ea kit
			100	10 x 1	Pan Phillips Screws S.S.			
			1	1/4	Masonry Drill			
WAK15 WAKJ15	20210/kit 20605/jar	5/16	50	5/16	Red Plastic Anchors		1.05 .80	15.57/ea kit
			50	1/4 x 1 1/2	Pan Combo Screws			
			1	5/16	Masonry Drill			
WAK15R WAKJ15R	20450/kit 20615/jar	5/16	50	5/16	Red Plastic Anchors		1.00 .74	16.11/ea kit
			50	12 x 1 1/4	Pan Square Drive Screws			
			1	5/16	Masonry Drill			
WAK1415H	20497/kit	5/16	50	5/16	Red Plastic Anchors		1.02	17.78/ea kit
			50	14 x 1 1/2	Hex Washer Head Screws			
			1	5/16	Masonry Drill			
WAK15S WAKJ15S	39162/kit 39163/jar	1/4	50	1/4	Red Plastic Anchors		.88 .81	12.86/ea kit
			50	12 x 1 1/4	Ind. Hex Slotted Screw			
			1	1/4	Masonry Drill			
WAK16QD WAKJ16QD	38980/kit 38981/jar	3/16	100	3/16	Red Plastic Anchors		.79 .70	15.24/ea kit MADE IN USA Anchors & Screws ONLY METALLICS/Avanti Screw
			100	8 x 1	QuaDrive 1/4 			
			1	3/16	Masonry Drill			
WAK14QD WAKJ14QD	39160/kit 39161/jar	1/4	100	1/4	Red Plastic Anchors		1.07 1.03	15.24/ea kit MADE IN USA Anchors & Screws ONLY METALLICS/Avanti Screw
			100	10 x 1	QuaDrive 5/16 			
			1	1/4	Masonry Drill			
WAK15QD WAKJ15QD	39164/kit 39165/jar	1/4	100	1/4	Red Plastic Anchors		.83 .77	15.24/ea kit MADE IN USA Anchors & Screws ONLY METALLICS/Avanti Screw
			100	12 x 1 1/4	QuaDrive 5/16 			
			1	1/4	Masonry Drill			

OTHER SIZES AND QUANTITIES AVAILABLE BY REQUEST

# ANCHORING DEVICES



## “DENVER BLUE” CONICAL PLASTIC WALL ANCHOR KITS

MASTER  
CARTONS  
CONTAIN:  
25 KITS  
18 JARS

NOW WITH QUADRIVE OPTION!

*In some areas of the country, tradesmen prefer blue to red. Same Product - Different Color*

PART#	UPC#	SIZE	QTY.	SIZE	ITEM	WT. PER PKG.	SUGGESTED TRADE LIST PRICE PER	
<b>WAK13B</b>	20201/kit	3/16	100	3/16	Blue Plastic Anchors		.53	
<b>WAKJ13B</b>	20571/jar		100	6 x 1	Pan Square Drive Screws		.54	14.40/ea kit
			1	3/16	Masonry Drill			
<b>WAK13BV</b>	20371/kit	3/16	500	3/16	Blue Plastic Anchors		2.21	
			500	6 x 1	Pan Combo Screws			59.75/ea kit
			1	3/16	Masonry Drill			
<b>WAK14B</b>	20209/kit	1/4	100	1/4	Blue Plastic Anchors		.89	
<b>WAKJ14B</b>	20576/jar		100	10 x 1	Pan Combo Screws		.92	14.40/ea kit
			1	1/4	Masonry Drill			
<b>WAK14TB</b>	20204/kit	1/4	100	1/4	Blue Plastic Anchors		1.01	
<b>WAKJ14TB</b>	20577/jar		100	10 x 1	<b>Pan Tri-Drive</b> 		.95	14.40/ea kit
			1	1/4	Masonry Drill, 000R2B Bit			MADE IN USA Anchors & Screws ONLY METALLICS/Avanti Screw
<b>WAK14HB</b>	20213/kit	1/4	100	1/4	Blue Plastic Anchors		1.01	
<b>WAKJ14HB</b>	20578/jar		100	10 x 1	5/16 Hex Slotted Screws		.93	16.46/ea kit
			1	1/4	Masonry Drill			
<b>WAK14QB</b>	20216/kit	1/4	100	1/4	Blue Plastic Anchors		.88	
<b>WAKJ14QB</b>	20581/jar		100	10 x 1	1/4 Hex Slotted Screws		.80	16.46/ea kit
			1	1/4	Masonry Drill			
<b>WAK14HBSS</b>	20814/kit	1/4	100	1/4	Blue Plastic Anchors		1.00	
<b>WAKJ14HBSS</b>	99416/jar		100	10 x 1	1/4 Hex Slotted Screws S.S.		1.00	40.11/ea kit
			1	1/4	Masonry Drill			
<b>WAK14RB</b>	20217/kit	1/4	100	1/4	Blue Plastic Anchors		1.03	
<b>WAKJ14RB</b>	20582/jar		100	10 x 1	Pan Square Drive Screws		.80	15.57/ea kit
			1	1/4	Masonry Drill			
<b>WAK141B</b>	20585/kit	1/4	100	1/4	Blue Plastic Anchors		1.00	
<b>WAKJ141B</b>	20586/jar		100	10 x 1 1/4	Pan Square Drive Screws		1.00	15.24/ea kit
			1	1/4	Masonry Drill			
<b>WAK14DB</b>	20214/kit	1/4	100	1/4	Blue Plastic Anchors		1.06	
<b>WAKJ14DB</b>	20579/jar		100	10 x 1 5/16	Hex Head Slotted Screws		1.06	20.30/ea kit
			1	1/4	Masonry Drill			
			1	5/16	Driver			
<b>WAK141QDB</b>	39188/kit	1/4	100	1/4	Blue Plastic Anchor		1.13	
<b>WAKJ141QDB</b>	39189/jar		100	10 x 1 1/4	<b>QuaDrive</b> 5/16 		1.14	15.24/ea kit
			1	1/4	Masonry Drill			MADE IN USA Anchors & Screws ONLY METALLICS/Avanti Screw
<b>WAK15B</b>	20211/kit	5/16	50	5/16	Blue Plastic Anchors		.84	
<b>WAKJ15B</b>	20606/jar		50	1/4 x 1 1/2	Pan Combo Screws		.80	15.57/ea kit
			1	5/16	Masonry Drill			
<b>WAK15RB</b>	20212/kit	5/16	50	5/16	Blue Plastic Anchors		1.00	
<b>WAKJ15RB</b>	20607/jar		50	12 x 1 1/4	Pan Square Drive Screws		.80	16.11/ea kit
			1	5/16	Masonry Drill			
<b>WAK15SB</b>	20417/kit	1/4	50	1/4	Blue Plastic Anchors		.85	
<b>WAKJ15SB</b>	39169/jar		50	12 x 1 1/4	Hex Slotted Screw		.85	12.86/ea kit
			1	1/4	Masonry Drill			
<b>WAK14QDB</b>	39166/kit	1/4	100	1/4	Blue Plastic Anchors		1.07	
<b>WAKJ14QDB</b>	39167/jar		100	10 x 1	<b>QuaDrive</b> 5/16 		1.03	15.24/ea kit
			1	1/4	Masonry Drill			MADE IN USA Anchors & Screws ONLY METALLICS/Avanti Screw
<b>WAK15QDB</b>	39170/kit	1/4	100	1/4	Blue Plastic Anchors		.83	
<b>WAKJ15QDB</b>	39171/jar		100	12 x 1 1/4	<b>QuaDrive</b> 5/16 		.80	15.24/ea kit
			1	1/4	Masonry Drill			MADE IN USA Anchors & Screws ONLY METALLICS/Avanti Screw

OTHER SIZES AND QUANTITIES AVAILABLE BY REQUEST



# ANCHORING DEVICES



## "SUPER YELLOW" PLASTIC WALL ANCHOR KITS

MASTER  
CARTONS  
CONTAIN:  
25 KITS  
18 JARS

PART#	UPC#	SIZE	QTY.	SIZE	ITEM	WT. PER PKG.	SUGGESTED TRADE LIST PRICE PER
WAK18 WAKJ18	20255/kit 20645/jar	3/16	100	3/16	Super Yellow Plastic Anchors		.58
			100	6 x 1	Pan Square Drive Screws		
			1	3/16	Masonry Drill		
WAK18T WAKJ18T	20256/kit 20640/jar	3/16	100	3/16	Super Yellow Plastic Anchors		.75
			100	6 x 1	Pan Combo Screws		
			1	3/16	Masonry Drill		
WAK19 WAKJ19	20260/kit 20650/jar	1/4	100	1/4	Super Yellow Plastic Anchors		.93
			100	10 x 1	Pan Combo Screws		
			1	1/4	Masonry Drill, 000R2B Bit		
WAK19T WAKJ19T	20261/kit 20651/jar	1/4	100	1/4	Super Yellow Plastic Anchors		.97
			100	10 x 1	<b>Pan Tri-Drive</b>		
			1	1/4	Masonry Drill		
WAK19H WAKJ19H	21575/kit 20655/jar	1/4	100	1/4	Super Yellow Plastic Anchors		1.06
			100	10 x 1	Hex Slotted Screws 5/16 Head		
			1	1/4	Masonry Drill		
WAK19S WAKJ19S	20262/kit 20670/jar	1/4	100	1/4	Super Yellow Plastic Anchors		1.11
			100	10 x 1 1/4	Hex Slotted Screws 5/16 Head		
			1	1/4	Masonry Drill		
WAK19SS WAKJ19SS	20263/kit 99470/jar	1/4	100	1/4	Super Yellow Plastic Anchors		1.10
			100	10 x 1 1/2	Pan Phillips Screws S.S.		
			1	1/4	Masonry Drill		
WAK20 WAKJ20	20265/kit 20680/jar	5/16	50	5/16	Super Yellow Plastic Anchors		.86
			50	12 x 1 1/4	Pan Combo Screws		
			1	5/16	Masonry Drill		
WAK191S WAKJ191S	32192/kit 20673/jar	5/16	100	5/16	Super Yellow Plastic Anchors		1.01
			100	12 x 1 1/2	Hex Slotted Screws 5/16 Head		
			1	5/16	Masonry Drill		

MADE IN USA  
Anchors & Screws  
ONLY METALLICS/Avanti Screw

### SUPER YELLOW QUADRIVE

WAK19QD WAKJ19QD	39176/kit 39177/jar	1/4	100	1/4	Super Yellow Plastic Anchors		1.07
			100	10 x 1	<b>QuaDrive</b> 5/16		
			1	1/4	Masonry Drill		
WAKJ1925QD	20594/jar	1/4	100	1/4	Super Yellow Plastic Anchors		1.07
			100	10 x 1 1/4	<b>QuaDrive</b> 5/16		
			1	1/4	Masonry Drill		

OTHER SIZES AND QUANTITIES AVAILABLE BY REQUEST



## "WHITE" PLASTIC WALL ANCHOR KITS

MASTER  
CARTONS  
CONTAIN:  
25 KITS  
18 JARS

PART#	UPC#	SIZE	QTY.	SIZE	ITEM	WT. PER PKG.	SUGGESTED TRADE LIST PRICE PER
WAK7 WAKJ7	20230/kit 20500/jar	3/16	100	3/16	Vinyl Anchors		.75
			100	6 x 1	Pan Combo Screws		
			1	3/16	Masonry Drill		







OTHER SIZES AND QUANTITIES AVAILABLE BY REQUEST

# ANCHORING DEVICES



## EXPANDET LIGHT ROSETT NYLON WALL ANCHOR KITS

MASTER  
CARTONS  
CONTAIN:  
25 KITS  
18 JARS





PART#	UPC#	SIZE	QTY.	SIZE	ITEM	WT. PER PKG.	SUGGESTED TRADE LIST PRICE PER	
WAK33	20270/kit	1/4	50	1/4	Expandet Nylon Anchors		14.09/ea kit	
WAKJ33	22229/jar		50	8 x 2	Pan Combo Screws		.70	
			1	1/4	Masonry Drill		.66	
WAK33R	20272/kit	1/4	50	1/4	Expandet Nylon Anchors		14.09/ea kit	
WAKJ33R	20761/jar		50	8 x 2	Square Drive Screws		.80	
			1	1/4	Masonry Drill		.65	
WAK34	20271/kit	5/16	25	5/16	Expandet Nylon Anchors		14.09/ea kit	
WAKJ34	22240/jar		25	12 x 2	Pan Combo Screws		.65	
			1	5/16	Masonry Drill, 000R2B Bit		1.00	

OTHER SIZES AND QUANTITIES AVAILABLE BY REQUEST



## COLLARLESS VINYL WALL ANCHOR KITS

MASTER  
CARTONS  
CONTAIN:  
25 KITS  
18 JARS

PART#	UPC#	SIZE	QTY.	SIZE	ITEM	WT. PER PKG.	SUGGESTED TRADE LIST PRICE PER	
WAK8	20235/kit	1/4	100	1/4	Green Collarless Vinyl Anchor		12.81/ea kit	
WAKJ8	20505/jar		100	10 x 1	Pan Combo Screws		1.01	
			1	1/4	Masonry Drill		.97	
WAK8T	20402/kit	1/4	100	1/4	Green Collarless Vinyl Anchor		13.51/ea kit	
WAKJ8T	20640/jar		100	10 x 1	<b>Pan Tri-Drive</b> 		1.07	MADE IN USA Anchors & Screws ONLY METALLICS/Avanti Screw
			1	1/4	Masonry Drill, 000R2B Bit		.80	
WAK8QD	39180/kit	1/4	100	1/4	Green Collarless Vinyl Anchor		13.51/ea kit	
WAKJ8QD	39181/jar		100	10 x 1	<b>QuaDrive</b> 5/16 		1.00	MADE IN USA Anchors & Screws ONLY METALLICS/Avanti Screw
			1	1/4	Masonry Drill		1.00	
WAK30	20435/kit	1/4	50	1/4	Green Collarless Vinyl Anchor		9.05/ea kit	
			50	10 x 1	Pan Combo Screws		.59	
			1	1/4 x 4	Masonry Drill			
WAK9	20240/kit	5/16	50	5/16	Blue Collarless Vinyl Anchor		14.09/ea kit	
WAKJ9	20510/jar		50	12 x 1 1/4	Pan Combo Screws		.86	
			1	5/16	Masonry Drill		.78	

OTHER SIZES AND QUANTITIES AVAILABLE BY REQUEST

**The QuaDrive**







Square Drive + Hex + Slotted + Phillips = QuaDrive

America's Newest Drive - Designed, Developed and Manufactured by Metallics/Avanti Screw

Screws

**MADE IN USA**



ONLY METALLICS/Avanti Screw

**ONLY METALLICS**

America's newest Drive designed, developed and manufactured by Metallics/Avanti Screw

THE QUADRIVE

# ANCHORING DEVICES



## GRAY CONICAL PLASTIC WALL ANCHOR KITS

NOW WITH QUADRIVE OPTION!

MASTER CARTONS CONTAIN:  
25 KITS  
18 JARS

PART#	UPC#	SIZE	QTY.	SIZE	ITEM	WT. PER PKG.	SUGGESTED TRADE LIST PRICE PER
WAK22	10500/kit	3/16	100	3/16	Gray Ribbed Anchors		11.91/ea kit
WAKJ22	20730/jar		100	6 x 1	Pan Combo Screws		
			1	3/16	Masonry Drill		
WAK25	20410/kit	3/16	100	3/16	Gray Ribbed Anchors		12.25/ea kit
WAKJ25	20751/jar		100	8 x 1	Pan Combo Screws		
			1	3/16	Masonry Drill		
WAK23	20400/kit	1/4	100	1/4	Gray Ribbed Anchors		14.44/ea kit
WAKJ23	20740/jar		100	10 x 1	Pan Combo Screws		
			1	1/4	Masonry Drill, 000R2B Bit		

### ANCHOR KIT DESIGNED FOR RACEWAY

WAK23F	39182/kit	1/4	100	1/4	Gray Ribbed Anchors		14.44/ea kit
WAKJ23F	20745/jar		100	10 x 1	Flat Head Phillips Screws		
			1	1/4	Masonry Drill		
WAK23T	20401/kit	1/4	100	1/4	Gray Ribbed Anchors		15.24/ea kit <small>MADE IN USA Anchors &amp; Screws ONLY METALLICS/Avanti Screw</small>
WAKJ23T	20767/jar		100	10 x 1	<b>Pan Tri-Drive</b>		
			1	1/4	Masonry Drill		
WAK24	20405/kit	5/16	50	5/16	Gray Ribbed Anchors		16.87/ea kit
WAKJ24	20750/jar		50	12 x 1 1/4	Pan Combo Screws		
			1	5/16	Masonry Drill		
WAK23QD	39184/kit	1/4	100	1/4	Gray Ribbed Anchors		15.24/ea kit <small>MADE IN USA Anchors &amp; Screws ONLY METALLICS/Avanti Screw</small>
WAKJ23QD	39185/jar		100	10 x 1	<b>QuaDrive</b> 5/16		
			1	1/4	Masonry Drill		

OTHER SIZES AND QUANTITIES AVAILABLE BY REQUEST

**The QuaDrive**

+ + + =

Square Drive   Hex   Slotted   Phillips   QuaDrive

America's Newest Drive - Designed, Developed and Manufactured by Metallics/Avanti Screw

**MADE IN USA**

ONLY METALLICS/Avanti Screw

**ONLY METALLICS**

America's newest Drive designed, developed and manufactured by Metallics/Avanti Screw

**THE QUADRIVE**



# Metallics

An **AMERICAN** Source For Premier and Innovative Fasteners and Anchors

We believe Metallics has the largest ratio of American made to foreign produced product of any other American fastener company

# ANCHORING DEVICES

4 Anchors in 1 Kit!

## QUAD PLASTIC ANCHOR KIT



- Four Different Style Anchors
- Drill Bits Included
- Screws And Driver Bit Included
- One Four Compartment Plastic Case

PART#	UPC#	SIZE	ITEM	WT. PER PKG.	STD. PKG./MSTR. SLEEVE	SUGGESTED TRADE LIST PRICE PER
WAKQUAD	38995	3/16	Super Yellow Plastic Anchors	1.08	20	31.15/ea kit
		8 x 1	Pan Head Combo Sheet Metal Screw		20	
		3/16 x 4	High Speed Drill Bit		1	
		1/4	Big Red Plastic Anchors		20	
		10 x 1	Pan Head Combo Sheet Metal Screw		20	
		1/4 x 4	High Speed Drill Bit		1	
		1/4	Super Yellow Plastic Anchor		20	
		10 x 1	Pan Head Combo Sheet Metal Screw		20	
		1/4 x 4	High Speed Drill Bit		1	
		5/16	Denver Blue Plastic Anchors		20	
		12 x 1 1/4	Pan Head Combo Sheet Metal Screw		20	
		5/16 x 4-1/2	High Speed Drill Bit		1	
2	#2 Phillips Power Bit	1				

OTHER SIZES AND QUANTITIES AVAILABLE BY REQUEST



## TOGGLER ALLIGATOR® SOLID WALL ANCHOR KIT

- Alligator® solid-wall anchors can be used in most any material, including: Concrete, Wood, Plaster, Aerated Concrete, Block, Masonry, Stone, Flakeboard, Cinder Block, Ceramic Tile, Stucco, and Drywall.
- Alligator® solid-wall anchors are designed to support heavy loads. (Even under vibration!)



PART#	UPC#	SIZE	ITEM	WT. PER PKG.	STD. PKG./MSTR. SLEEVE	SUGGESTED TRADE LIST PRICE PER
TSWAK	73998	3/16	Alligator Solid-Wall Anchor with Flange	.99	20	51.22/ea kit
		8 x 1	Pan Head Combo Sheet Metal Screw		20	
		3/16 x 4	Masonry Drill Bit		1	
		1/4	Alligator Solid-Wall Anchor with Flange		20	
		10 x 1	Pan Head Combo Sheet Metal Screw		20	
		1/4 x 4	Masonry Drill Bit		1	
		1/4	Alligator Solid-Wall Anchor No Flange		20	
		10 x 1	Pan Head Combo Sheet Metal Screw		20	
		1/4 x 4	Masonry Drill Bit		1	
		5/16	Alligator Solid-Wall Anchor with Flange		15	
		12 x 1 1/4	Pan Head Combo Sheet Metal Screw		15	
		5/16 x 4	Masonry Drill Bit		1	
2	#2 Phillips Power Bit	1				

OTHER SIZES AND QUANTITIES AVAILABLE BY REQUEST

# ANCHORING DEVICES



## SELF-DRILLING WALL ANCHORS

**MASTER  
CARTONS  
CONTAIN:  
25 KITS  
18 JARS**

*NOTE: Due to possible differences in specifications, applications and interpretation of results, purchasers must make their own evaluation of the product to determine the suitability of anchor.*

ANCHOR TYPE	Pullout <i>(ultimate average lbs)</i> Gypsum Thickness			Shear <i>(ultimate average lbs)</i> Gypsum Thickness		
	3/8	1/2	5/8	3/8	1/2	5/8
#6	40	45	-	92	103	-
#8	45	50	75	100	110	105

OTHER SIZES AND QUANTITIES AVAILABLE BY REQUEST



## SELF-DRILLING WALL ANCHORS ZINC

*Works great in Double Drywall and Studs  
Combo Drive #3 Phillips*

PART#	UPC#	DIAMETER	LENGTH	WT. PER PKG.	STD. PKG./ MSTR. SLEEVE	SUGGESTED TRADE LIST PRICE PER
ZSTU1J/jar	81315	8	1 1/4	1.15	50	32.63/ea kit
ZSTU1K/kit	81319	8	1 1/4	1.22	50	32.63/ea kit
ZSTU1M/box	81323	8	1 1/4	15.06	1000	300.44/m

OTHER SIZES AND QUANTITIES AVAILABLE BY REQUEST



## SELF-DRILLING WALL ANCHORS ZINC

*Works great in Drywall • Combo Drive #3 Phillips*



PART#	UPC#	SCREW SIZE	WT. EACH	STD. PKG./ MSTR. SLEEVE	SUGGESTED TRADE LIST PRICE PER
JZSA1/jar	80973	#8	1.59	100	51.24/c
ZSA1M/box	33261	#8	13.15	1000	409.82/m
ZSA1B/box	62157	#8	19.63	1500	357.13/m

OTHER SIZES AND QUANTITIES AVAILABLE BY REQUEST



PART#	UPC#	QTY.	SIZE	ITEM	WT. PER PKG.	SUGGESTED TRADE LIST PRICE PER
ZSA1K/box	33265	50	#8	Zinc Screw Anchors	1.11	31.74/ea kit
ZSA1J/jar	20710	50	8 x 1 1/4	Pan Head Combo Screws	1.12	
ZSA1TK/box	33266	50	#8	Zinc Screw Anchors	1.08	31.74/ea kit
ZSA1Tj/jar	20269	50	8 x 1 1/4	Pan Head TriDrive Screws	1.07	
		1	-	100P2B Bit		

OTHER SIZES AND QUANTITIES AVAILABLE BY REQUEST



## SELF-DRILLING WALL ANCHORS ZINC-LITE

Works great in Drywall • Combo Drive #2 Phillips  
Uses #6-8 sheet metal **or** #6-8 drywall screws

PART#	JAR UPC#	QTY.	SIZE	ITEM	WT. PER PKG.	STD. PKG./MSTR. SLEEVE	SUGGESTED TRADE LIST PRICE PER
JZSAL2	80974	100	#6 or #8	Zinc Alloy Anchor Lite	.85	100	36.47/c

OTHER SIZES AND QUANTITIES AVAILABLE BY REQUEST



100P1B

### ANCHOR KITS IN BOX AND JAR

PART#	JAR UPC#	QTY.	SIZE	ITEM	WT. PER PKG.	STD. PKG./MSTR. SLEEVE	SUGGESTED TRADE LIST PRICE PER
ZSAL2K/box	33267	50	#6	Zinc Alloy Anchor Lite	.66	1	22.15/ea kit
ZSAL2J/jar	33268	50	6 x 1	Pan Head Combo Screws	.64		

OTHER SIZES AND QUANTITIES AVAILABLE BY REQUEST

## SELF-DRILLING WALL ANCHORS NYLON

Works great in Drywall • Combo Drive #3 Phillips



PART#	UPC#	QTY.	SIZE	ITEM	WT. PER PKG.	STD. PKG./MSTR. SLEEVE	SUGGESTED TRADE LIST PRICE PER
JPSA1/jar	80975	100	#6, #8	Plastic Anchors	.51	100	51.24/c
PSA1M/box	19824	1000	#6, #8	Plastic Anchors	3.29	1000	327.84/m

OTHER SIZES AND QUANTITIES AVAILABLE BY REQUEST



100P2B

### ANCHOR KITS IN BOX AND JAR

PART#	UPC#	QTY.	SIZE	ITEM	WT. PER PKG.	STD. PKG./MSTR. SLEEVE	SUGGESTED TRADE LIST PRICE PER
PSA1K/box	29495	50	#6, #8	Plastic Anchors	.57	1	31.74/ea kit
PSA1J/jar	20705	50	8x1¼	Pan Head Combo Screws	.60		

OTHER SIZES AND QUANTITIES AVAILABLE BY REQUEST

## SELF-DRILLING WALL ANCHORS NYLON-LITE

Works great in Drywall • Combo Drive #2 Phillips



PART#	JAR UPC#	QTY.	SIZE	ITEM	WT. PER PKG.	STD. PKG./MSTR. SLEEVE	SUGGESTED TRADE LIST PRICE PER
JPSAL2	80976	100	6	Plastic Anchor Lite	.23	100	36.47/c

OTHER SIZES AND QUANTITIES AVAILABLE BY REQUEST



100P1B

### ANCHOR KITS IN BOX AND JAR

PART#	JAR UPC#	QTY.	SIZE	ITEM	WT. PER PKG.	STD. PKG./MSTR. SLEEVE	SUGGESTED TRADE LIST PRICE PER
PSAL2K/box	19827	50	#6	Plastic Anchor Lite	.35	1	22.15/ea kit
PSAL2J/jar	20700	50	6 x 1	Pan Head Combo Screws	.33		

OTHER SIZES AND QUANTITIES AVAILABLE BY REQUEST

# ANCHORING DEVICES

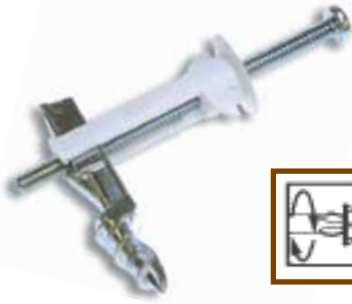

## DRILL TYPE TOGGLE ANCHORS



PART#	UPC#	QTY.	DIAMETER	LENGTH	ITEM	WT. PER PKG.	STD. PKG./MSTR. SLEEVE	SUGGESTED TRADE LIST PRICE PER
JEZT1	80977	50	#10	-	Toggles	2.01	1	84.45/ea kit
		50	10-24	2	Pan Head Combo Machine Screws Zinc Plated			

OTHER SIZES AND QUANTITIES AVAILABLE BY REQUEST



### ANCHOR KITS IN BOX AND JAR

PART#	UPC#	QTY.	DIAMETER	LENGTH	ITEM	WT. PER PKG.	STD. PKG./MSTR. SLEEVE	SUGGESTED TRADE LIST PRICE PER
EZT1K/box	33275	25	#10	-	Plastic Anchors	1.11	1	44.25/ea kit
EZT1J/jar	20715	25	10-24	2	Pan Head Combo Machine Screws Zinc Plated	1.24		

OTHER SIZES AND QUANTITIES AVAILABLE BY REQUEST

## STRAP-TOGGLE ANCHORS

### ANCHOR STEEL ZINC

Designed for use in plaster, wallboard, concrete block or hollow tile



Packaged in Poly Bag

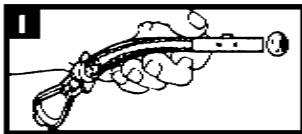

1 Drill appropriate sized hole. Hold metal channel flat alongside plastic straps and slide channel through hole.

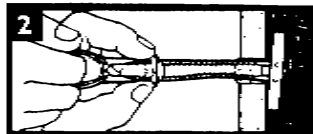

2 Pull on ring so metal channel rests flush behind wall, as you slide plastic cap along straps with other hand, until flange of cap is flush with wall.

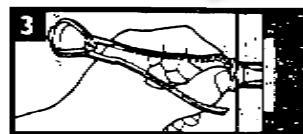

3 Place thumb between plastic straps. Push to side, snapping off straps flush with wall.

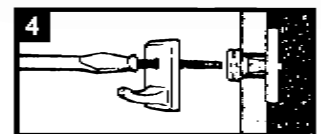

4 Insert bolt through item to be attached and tighten until flush with fixture. Minimum clearance behind wall is 1 7/8".

PART#	UPC#	SCREW SIZE	ANCHOR SIZE	DRILL SIZE	QTY	ANCHOR SIZE	ITEM	WT. PER PKG.	STD. PKG.	SUGGESTED TRADE LIST PRICE PER
NT316	18501	10-24	3/16 x 4	1/2	50	3/16 x 4	Strap-Toggle Anchors	1.38	50	66.75/ea
NT14	18502	1/4-20	1/4 x 4	1/2	50	1/4 x 4	Strap-Toggle Anchors	1.41	50	66.75/ea
NT38	18510	3/8-4	3/8 x 4	1/2	100	3/8 x 4	Strap-Toggle Anchors	5.86	100	214.31/ea

OTHER SIZES AND QUANTITIES AVAILABLE BY REQUEST

Because a wide variety of screws work with this Toggle Anchor, Metallics has chosen not to offer them in a kit, but rather to allow the user to choose the screw that works best for each particular application.

Please see Screw/Section A for a full listing of our machine screws.

## SNAPTOGGLE® ANCHORS

STEEL ZINC

Secure Installations in Seconds – Not Minutes – Grip Range 3/8"–2 1/2" (9mm–64mm)

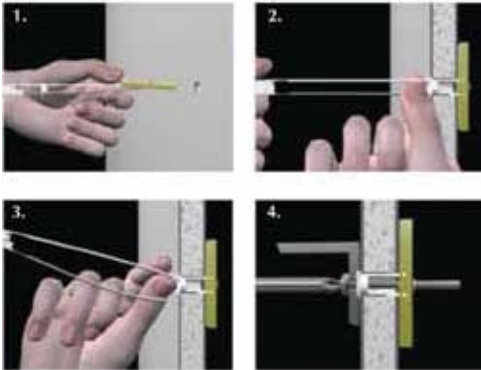

1. Drill 1/2" hole. Hold metal channel flat alongside plastic straps, slide channel through hole.
2. With one hand, pull ring so metal channel rests flush behind wall. Slide plastic cap along straps with other hand until flange of cap is flush with wall.
3. Place thumb between plastic straps. Push side to side snapping off straps flush with wall.
4. Insert bolt through item to be attached and tighten until flush with fixture. Minimum clearance behind wall: 1 7/8" (48mm)

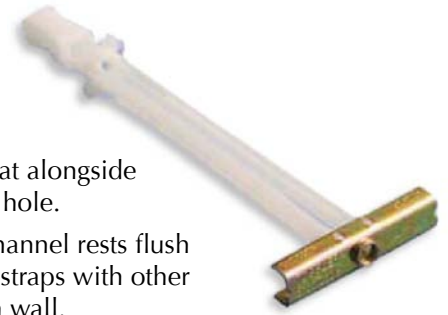

PART#	UPC#	SIZE	WT. PER PKG.	STD. PKG.	SUGGESTED TRADE LIST PRICE PER
MBA25	73944	10-24	.85	25	46.42/ea
MBA50	73971	10-24	1.70	50	84.93/ea
MBA100	73975	10-24	3.37	100	161.28/ea
MBB25	73945	1/4-20	.85	25	46.42/ea
MBB50	73972	1/4-20	1.68	50	84.93/ea
MBB38	73948	3/8-16	1.54	25	49.63/ea
MBB12	73942	1/2-13	1.53	25	49.75/ea
<b>KIT</b> – Contains 100 1/4-20 x 3 Round Head Combo Machine Screws and 100 Snapoggles.					
MBB100K1	73977	1/4-20	7.10	1	123.73/ea kit

OTHER SIZES AND QUANTITIES AVAILABLE BY REQUEST

An American Made Alternative To the Blue Concrete Screw – See Page 138.

## QUADRIVE CONCRETE SCREW ANCHORS



Large fillet under head to fit 3/16" and 1/4" holes provides greater driving strength

Fluted, interrupted threads aid tapping into masonry products

Hilo threads for faster application

Silver color to match conduit, strap and concrete

### STOP THE SNAPPING

A coating is applied after heat-treating to provide anti-corrosion protection. The coating is a RoHS compliant mechanical zinc coating that offers 2000 hours to 15% red rust corrosion in salt spray testing performed to ASTM B117 specifications.

Metallics offers our Distributor/Contractor users an alternative to the blue color of standard concrete screws. Silver color is cosmetically appealing when used with zinc plated or stainless steel brackets, electrical fixtures or conduit.

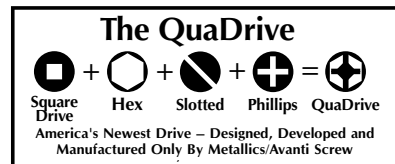

MADE IN USA



Made by Avanti Screw, Inc., A Metallics Affiliate

We will be glad to send a sample bag of 10 pieces to our Distributors for their customer trials. **Please specify size!**

Metallics Inc. • 800-243-8272 • sales@metallics.us