



Wal-Rich's new home in Port Washington, NY

TABLE OF CONTENTS

Dresser Piping Specialties	1-11
Gas Meter Specialties	12-20
Continental Risers & Fittings	21-27
Yellow Polypipe	28
Innerlynx Mechanical Seals	32
Gauges & Thermometers	34-39
Heating Accessories	40-44
Conbraco Products	45-48
Gas/Oil Burner Specialties	49-52
Circulator Products	53
Water Heater Accessories	54
Globe Fire Sprinklers	57
Pipe Hangers	58-64
Sammy Screws	65-66
Fasteners	67-68
Stud Guards	70
Brass Fittings	71-76
FlexiFlow SS Connectors	77-79
Sink Specialties	80-97
Hoses & Hose Specialties	98-110
Strainers & Drains	112-120
Tubular Brass/PVC	121-129
Shower Pan Liner	133-134
Tub & Shower Specialties	135-148
Toilet Specialties	150-170
Sloan Flushometers/Parts	171-178
Sloan Flushmate Products	179
Delany Flushometers/Parts	180-182
Faucet Repair Parts	183-199
Delta OEM Parts	200-201
Gerber OEM Parts	202-203
American Standard OEM Parts	204
Basin Buddy Wrenches	208
Channellock Wrenches	209
Tools	210-232
Chemicals	233-241

WHO'S WHO AT WAL-RICH



Jerome Rich, President



Daniel Rich, Sales

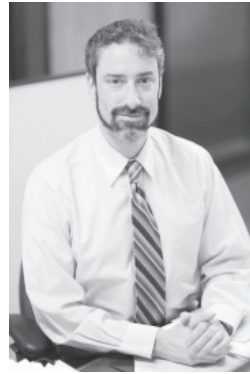

Andrew Rich, Marketing



Vinny Scala, Purchasing



Geoff Portoles, Sales



Rose Baichoo, Sales



Randy Rich, Sales



Steven Lemmey, Sales



Danice Raines, Controller



Virginia Hermidas, A/R



Jelena Konstantin, A/A



Sandy Rich, Sales



Packaging & Assembly Dept.



Shipping & Receiving Department



A

Abrasive Cloth 216
 Abrasive Pads 216
 Access Panels 110
 Actuators, Am Std 156
 ADA Trap Covers 123
 Adapters, Aerator 94-95
 Adapters, Compression 71-73
 Adapters, CPVC 74
 Adapters, Drain Pan 129
 Adapters, Fire Hydrant .. 103
 Adapters, Gas Range ... 107
 Adapters, Hose 101
 Adapters, Max-A-Valve .. 83
 Adapters, Snap 95
 Adapters, Sweat x IPS.. 74
 Adapters, Trap 126
 Add-A-Showers 137
 Aerator Adapters 94-95
 Aerators 93-95
 Air Admittance Valves .. 92
 Air Cocks 46
 Air Gaps 92
 Air Vents 41
 Aluminum Tubing 49
Am Std Genuine Parts . 204
 Anchors 64
Apollo Ball Valves 48
 Augers 221

B

Backflow Preventer 102
 Ballcock Repair 159
 Ballcock, Fillpro 158
 Ballcock, **Fluidmaster** . 160
 Ballcock, to fit Rialto 188
 Ballcocks 158-160
 Ballcocks, **Korky** 150
 Balls, Inflatable Test 132
 Band Iron 63
 Bars, Shower 141
Basin Buddy 208
 Basin Cocks 89
 Basin Rosettes 81
 Bath Shoes 144
 Bath Wastes 146
 Bathcocks 136
 Batteries 230
 Bead Chain 143
 Bibb Screws 199
 Bending Springs 212

C

Bibblocks 103
 Bibbs 89
 Bigfoot Toilet Plate 168
 Bits, **Irwin** Speedbor 212
 Bits, Masonary 68
 Bits, Paddle 212
 Black & White Metal Fix 233
 Block Flaring Tools 215
 Boca Plates 70
 Boca Vent 92
 Boiler Tube Plugs 43
 Bolts, 150# Flange 207
 Bolts, Close-Couple 164
 Bolts, Closet Flange 166
 Bolts, Flange 166
 Bolts, Johnny 166
 Bolts, Nylon Toilet Seat 165
 Bolts, Tank-to-Bowl 164
 Boxes, Ice Maker 110
 Boxes, WM Valve 110
 Brackets, Riser 30
 Brackets, Support 64
 Brushes, Chip 216
 Brushes, Copper Tube .. 215
 Brushes, Flux 216
 Brushes, Pipe Dope 216
 Bubbler Heads 90
 Buckets, Organizer 219
 Bulbs 230
 Bungee Cords 229
 Bushings, Duplex Tank . 51
 Cable Ties 56, 229
 Candles, Plumber's 217
 Caps, Blank 126
 Caps, Closet Carrier 166
 Caps, Dirt Pocket 43
 Caps, Hose 101
 Caps, PVC 131
 Caps, Rubber Test 131
 Caps, Stop & Waste 103
 Caps, Tapped 42
 Cartridge Pullers 223
 Caulk Guns 229
 Caulk, Firestop 237
 Caulk, Tub & Tile 238
 Caulking Irons 217
 Caution Tape 232
 Ceiling Support Rods 142
 Cesspool Plates 120
 Chamfer Tools 23
Channellock Wrenches 209

Chrome Fittings 75-76
 Chrome Nipples 75
 Circulator Couplings 53
 Circulator Flanges 53
 Circulator Gaskets 53
 Circulator Oil 238
Clam Flange 167
 Clamps, "C" 58
 Clamps, Grounding 55
 Clamps, Hinged 12
 Clamps, Jr. Beam 58
 Clamps, Pipe 12
 Clamps, Riser 60
 Clamps, SS Hose 100
 Clamps, Strut 64
 Clamps, Tubing 62-63
 Closet Carrier Caps 166
 Closet Flange Extender 168
 Closet Flanges 165
 Closet Spuds 169
 Cloth, Emery 216
 Cloth, Grit 216
 Cocks, Air 46
 Cold Solder 233
 Compression Fittings 71-73
Conbraco Products 45-48
Continental Products .. 21-30
 Copper Tube Brushes ... 215
 Couplings, Bathcock 136
 Couplings, Circulator 53
 Couplings, No Hub 12
 Couplings, Pipe 13
 Couplings, Rod 67
 Couplings, Rubber 15
 Couplings, Water Meter 14
 Covers, ADA Trap 123
 Covers, Cleanout 130
 Covers, Cock Hole 88
 Covers, Tank 168
 Crown-Rinse Products .. 96
 Cutters, Copper Tube 213
 Cutters, Glass Tubing ... 43
 Cutters, Inside PVC 214
 Cutters, PEX 213
 Cutters, PVC 213

D

D-Bar Loop 142
Delany Flushometers ... 181
Delany Genuine Parts .. 181
Delta Genuine Parts 200-201
 Dental Picks 222
 Desanco Fittings 126

Dirt Pocket Caps 43
 Discs, Snap/Screw 156
 Dishwasher Tailpieces ... 124
 Disposal Parts 92
 Disposal Connection 99
 Diverter Elbow 135
 Douglas Valves 155
 Drain Augers 220-222
 Drain Cleaning Tools 220-222
Drain King Products 220
 Drains, Flip-It 147
 Drains, Tip Toe 147
 Drains, Shower 118-120
 Drains, Tub 144-147
Dresser Products 1-11
 Drop Ear Elbow 140
 Drop Lights 230
 Dryer Vent Kits 108
 Dust Masks 231

E

Elbows, Drop Ear 140
 Elbows, Tubular 125
 Electrical Boxes 55
 Elements, Water Htr 54
 Escutcheons 85-86
 Escutcheons, Shower ... 140
 Escutcheons, Sprinkler . 57
 Expansion Joints 16
 Expansion Shields 64
 Extension Cords 230
 Eye Guards 231

F

F & C Plates, Plastic 86
 F & C Plates, Steel 87
 Faucet Repair Parts 183-197
 Faucet Washers 205-206
 Faucets 88-90
 Faucets, Bubbler 90
 Faucets, Cup Filler 90
 Faucets, Water Cooler .. 90
 Faucets, Water Filter 90
 Fill Boxes 52
 Filters, Oil 51
 Filters, Water 110
 Fire Hydrant Adapters ... 103
 Fire Sprinkler Heads 57
 Fitt'n Saver Reamer 214
 Fittings, Barbed 73

Fittings, Compression ... 71-73
 Fittings, CP Brass 75-76
 Fittings, Desanco 126
 Fittings, Flare 73
 Fittings, Gas Appliance . 33
 Fittings, PE Gas 21-31
 Fittings, PVC Tubular 128-129
 Fittings, Quick-Connect 33
 Fittings, Trap 126
 Fittings, Tubular Brass .. 125-127
 Fittings, Water Service.. 13
 Flame Shields 218
 Flange Repair 167
 Flanged Cover Tube 125
 Flanges, Circulator 53
 Flanges, Closet 165
 Flanges, Jumbo 142
 Flanges, Railing 51
 Flanges, Shower Rod 142
 Flanges, Toilet 165
 Flanges, Urinal 169
 Flanges, Water Meter ... 14
 Flappers 151-154
 Flappers, **Korky** 150
 Flare Fittings 73
 Flaring Tools 215
 Flexidrains 129
FlexiFlow Connectors . 77-79
 Flints 217
 Float Balls 159
 Floodstoppers 120
 Floor & Ceiling Plates ... 86-87
 Floor Drain Covers 120
 Flow Restrictors 140
Fluidmaster Products .. 160
Flushmate Parts 179
Flushmate Tanks 179
 Flushvalve, Urinal 169
 Flushvalves, Douglas 155
 Flushvalves, Fit Am Std . 156
 Flushvalves, Mansfield .. 157
 Flux 236
Frajon AAV 92
 Fresh Air Plate 131
 Frost Free Sillcocks 102
 Funnels, Sink 124

G

Garden Hoses 104
 Gas Cocks, Lockwing ... 19
 Gas Fittings 21-31
 Gas Meter Products 17-18
 Gas Pipe 28

Gas Proving Pump 132
 Gas Range Connectors . 107
 Gas Risers 21, 31
 Gas Test Kits 36-37
 Gasket Sheets 219
 Gaskets, Circulator 53
 Gaskets, Close Couple . 164
 Gaskets, Closet Flange 167
 Gaskets, Companion 207
 Gaskets, Full-Face 207
 Gaskets, Ring 207
 Gaskets, Spiral Wound . 207
 Gaskets, Tank-to-Bowl .. 164
 Gaskets, Urinal Flange . 169
 Gaskets, Wax 167
 Gauge Glass 42
 Gauge Glass Cutters 43
 Gauges 34-37
Gel-Gloss Cleaners 237
Gerber Genuine Parts .. 202-203
 Glass Tubing Cutters 43
 Glaze, Porcelain 241
 Gloves 219
 Goggles 231
 Goof Plates 147
 Grab Bars 146
 Graphite Packing 234
 Grid Drains 115
 Grids, Bath Shoe 144
 Grids, Shower 118,120
 Ground Jt. Connection .. 126
 Grounding Clamp Kits ... 55
 Guide Arms 155

H

Hair Snare 143
 Hand Pads 216
 Handheld Shower 136
 Handle Pullers 223
 Handles, Faucet 183-197
 Handles, Radiator 40
 Handles, Shower Door .. 148
 Handles, Valve 103
 Handy Hands 222
 Hangers, Malleable 58-59
 Hangers, Pipe 58-64
 Hangers, Sink 91
 Heads, Pullout Faucet .. 97
Honeywell Pilots 49
 Hooks, WM 99
 Hose & Sprays 96
 Hose Adapters 101
 Hose Caps 101

Hose Clamps 100
 Hose Nipples 101
 Hose Nozzles 104
 Hose Vacuum Breaker .. 102
 Hose, Dryer Vent 108
 Hoses, Discharge 99
 Hoses, Garden 104
 Hoses, Generator 33
 Hoses, Outdoor Gas 33
 Hoses, Pullout Spray 97
 Hoses, WM Inlet 98

I

Ice Maker Kits 109
 Inflatable Test Balls 132
Innerlynx 32
 Inserts, Vinyl Tubing 100
 Insulation Shields 60
Irwin Speedbor Bits 212

J

Joint Runners 217
 Johnny Bolts 166

K

Ke, 4 Way Sillcock 103
 Key, B-Tank 218
 Knife, Utility 211
 Knife, Putty 240
Korky Flappers 150

L

Ladles 217
 Lag Screws 67
 Laundry Tray Blocks 96
 Lavatory Legs 91
Leak-Lock Sealants 236
Lenox Blades 210
 Levels 228
 Lift Wires 154
 Link seals 32
 Lint Snares 99
 Lint Trap Kits 108
Liquid Wrench 237

Locknuts, Spud 169
 Lockwing Gas Cocks 19
 Lubricated Plug Valves .. 19
 Lumber Crayons 229

M

Marq II Test Plugs 131
 Marvel Fittings, Brass ... 126
 Mason Twine 231
 Mastic 32
 Match Extenders 50, 230
 Max-A-Valve Adapters ... 83
Mepco Steam Traps 44
Metacaulk Firestop 237
 Meter Bars 17
 Meter Valves 19
 Mini-Snake 220
 Mirrors, Inspection 50, 230
MSP Wrap Tape 234

N

Needle Valves 109
 Nipple Trays 220
 Nipples, CP Brass 75
 Nipples, Hose 101
 Nipples, Running Thrd .. 118
 No Hub Couplings 12
Nokorode Flux 236
Nordstrom Valves 19
 Nozzles, Hose 104
 Nutdrivers 69
 Nutsetters 68
 Nuts, Ballcock 81
 Nuts, Basin 81
 Nuts, Closet Carrier 166
 Nuts, Gauge Glass 42
 Nuts, Pilot 50
 Nuts, Rod 67
 Nuts, Slip 127
 Nylon Cable Ties 229

O

Oil Fill Boxes 52
 Oil Filters 51
 Oil Tank Specialties 51-52
 O-ring Puller 222
 O-rings 198

P

Packing 219
 Packing, Stem 234
 Pads, **Scotch Brite** 216
 Pan Liner Cement 133, 238
 Pan Liner 133
 Peck Vents 18
Permatex Products 235
 Personal Shower 136
 Pigtails 37
 Pilot Nuts 50
 Pilot Tubing Kits 50
 Pipe Clamps 12
 Pipe Hangers 58-64
 Pipe Straps 61
 Pipe Taps 211
 Pipe Wrap Tape 32
 Pipe, Yellow PE Gas 28
 Plate, Fresh Air 131
 Plates, F & C 86-87
 Plates, "Goof" 147
 Plates, Pipe Repair 12
 Plates, S.S. Extension . 130
 Plates, Shower Trim 143-144
 Plugs, Bar Sink 114
 Plugs, Boiler 43
 Plugs, Brass Cleanout .. 130
 Plugs, C.I. Wingnut 132
 Plugs, CO 115
 Plugs, Countersunk 130
 Plugs, Inflatable Test 132
 Plugs, Lead Fitall 130
 Plugs, Marq II 131
 Plugs, PO 116
 Plugs, Pneumatic Test .. 132
 Plugs, Rubber Test 131
 Plugs, Trap 132
 Plumber's Candles 217
Plumberex 123
 Plungers 221-222
 Pop-up Stoppers 117
 Pop-Up Wastes 115
Porc-a-fix 241
 Porcelain Glaze 241
 Pre-Rinse Parts 111
 Provents 92
 Pullout Sprays 97
 Pumps, Bike 132
 Pumps, Gas Proving 132
 Putty Knife 240
 Putty 238
 PVC Tubular Products .. 127-129

Q

Quickblade Cutter 210
Quick-Connects f/Gas ... 33

R

Radiator Valve Handles . 40
Radiator Valves 40
Rags 231
Rainbow Packing 219
Reamers, PVC Socket .. 214
Reamers, Seat 226
Refill Tubes 159
RetroValves 83-84
Rings, Sweat 126
Riser Brackets 30
Risers, Anodeless 21
Risers, Compression 31
Risers, **Con-Stab** 21
Risers, Flexible 26
Risers, Water Supply 77-80
Rod, Ballcock 159
Rod, Shower 141
Roof Flashings 70
Rosettes 81
Royston Mastic 32
Rubber Sheeting 219
Rubber Tie Downs 229

S

Saddle Tees 12
Saddle Valves 109
Sammy Screws 65-66
Saws, Mini Hacksaw 211
Saws, PVC Cable 214
Saws, Quickdraw 214
Scotch-Brite Pads 216
Screw & Anchor Kits 68
Screw Extractors 211
Screwdrivers 69
Screws, Bibb 199
Screws, Lag 67
Screws, **Sammy** 65-66
Screws, **Tapcon** 66
Screws, Trip Plate 144
Screws, Zip 68
Seat Gauge 199

Seats, Faucet 183-197, 199
Self-Tapping Valve 109
Sewage Ejector Valves .. 106
Sheet Packing 219
Shims 165
Shop Towels 231
Shower Arms 140
Shower Bars 141
Shower Curtain Pins 143
Shower Door Handles ... 148
Shower Door Parts 148-149
Shower Heads 138-139
Shower Liner Cement ... 238
Shower Pan Liner 133
Shower Rebuild Kits..... 195-197
Shower Rod Flanges 142
Shower Rods 141
Siamese Connection 102
Sight Glass 42
Sillcock Keys 103
Sillcocks 102-103
Silver King Products ... 239
Sink Bibbs 89
Sink Clips 91
Sink Collar 124
Sink Funnels 124
Sink Hangers 91
Slip Elbows 125
Slipnuts 127
Sloan Flushometers 174
Sloan Genuine Parts ... 171-178
Snakes 221
Soap Dispensers 96
Solder Ladle 217
Solder Pot 217
Span-It Flange 167
Spark Lighters 217-218
Spectacles 231
Speedies 77-80
Splash Guards 143
Split Escutcheons 86
Spouts 135-136
Spray Paint 232
Spud Buddy Wrench ... 178
Spuds 169
SS Braided Connectors 77-79
SS Corrugated Hoses ... 55
SS Duo Strainers 112-113
SS Hose Clamps 100
Stack and Seal Flanges 168
Stakes 232
Steam Traps 44
Steel Wool 216
Stem Grease 234
Stem Packing 234
Stems, Faucet 183-197

Stop & Waste Caps 103
Stoppers, Pop-up 117
Stoppers, Rubber 143
Stops, Compression 82-83
Stops, Quarter Turn 82-83
Strainers, Basket 112-113
Strainers, Crumb Cup 116
Strainers, Duo 112-113
Strainers, Fuel Pump 51
Strainers, Ketchall 116
Strainers, Perforated 116-117
Strainers, Shower 118-120
Strainers, Sink 112-114
Strainers, Urinal 118
Straps, Pipe 61-62
Strikers 217
Stud Guards 70
Strut Clamps 64
Sump Pump Kits 107
Supply Tubes 77-80
Syphons, Pigtails 37-

T

Tailpieces, Dishwasher .. 124
Tailpieces, PVC Flex 129
Tailpieces, Trap Primer .. 122
Tailpieces, Tubular 122-124
Tank Balls 151-154
Tank Covers 168
Tank Levers 161-163
Tank-to-Bowl Gaskets ... 164
Tank-to-Bowl Kits 164
Tapcon Screws 66
Tape Measure 228
Tape, Caution 232
Tape, Direct Burial 30, 232
Tape, Duct 218
Tape, Electrical 218
Tape, Foil 218
Tape, Pipe Wrap 32
Tape, Teflon 240
Tees, Tubular 125-126
Tees, Washing Machine 124
Teflon Tape 240
Termination Screens 131
Thermocouples 50
Thermometers 38-39
Thermostat Guards 56
Thermostats 54
Thermowells 39
Threaded Rod 67
Tie Wire 64
Tin Snips 228
Toggle Plates-Oil/Gas ... 55

Toilet Flanges 165
 Toilet Levers 161-163
 Toilet Paper Roller 168
 Toilet Partition Parts 170
 Tools, Chamfer 23
 Towel Bars 149
 Tracer Wire 30, 232
 Trap Guards 123
 Trap Primers, Tubular 115
 Traps, Condensate 129
 Traps, LA-Pattern 121
 Traps, NY Regulation 121
 Traps, PVC Tubular 127-128
 Traps, Steam 44
 Traps, Tubular Brass 121-122
 Trays, Nipple 220
 Tricocks 46
 Tridicators 39
 Trip Plates 143
 Trip Waste Assemblies . 146-147
 Trowels 229
 Tub Spouts 135-136
 Tubing Clamps 62-63
 Tubing, Aluminum 49
 Tubing, Clear Vinyl 100
 Tubular Brass 121-126
 Twin Mix Connection 99
 Twine, Mason 231

U

Urinal Flanges 169
 Urinal Flush Valve 169
Utility Flux 236

V

Vacuum Breakers 47
 Valves, Air Admittance .. 92
 Valves, **Apollo** 45-48
 Valves, Ball 48
 Valves, Ball-Cone 47
 Valves, Coin-Key 41
 Valves, **Conbraco** 45-48
 Valves, Gas Ball 50, 107
 Valves, Lockwing 19
 Valves, Lubricated Plug . 19
 Valves, Main Control 47
 Valves, Needle 109
 Valves, **Nordstrom** 19
 Valves, Radiator 40
 Valves, Relief 45-46

Valves, Self-Closing 139
 Valves, Self-tapping 109
 Valves, Sewage Ejector 106
 Valves, Shower Diverter . 139
 Valves, Tailpiece Check 117
 Vent Caps 52
Vent Line Protector 20
 Vents, Air 41
 Vents, Peck 18
 Vinyl Tubing 100

W

Washers, Ballcock 81
 Washers, Basin 81
 Washers, Bath Shoe 144
 Washers, Faucet 205-206
 Washers, Flushvalve 155-159
 Washers, Gauge Glass 42
 Washers, Hose 102
 Washers, Mack 116
 Washers, Neo Mold 206
 Washers, Rod 67
 Washers, Slip Joint 206
 Washers, Spud 169
 Washers, W & O 144
 Washing Machine Hose 98
 Waste & Overflow 146
 Waste Bends 122
 Water Filters 110
 Water Gauge Sets 42, 46
 Water Hammer Arrester 105
 Water Heater Elements 54
 Water Service Fittings... 13-14
 Wax Gaskets 167
 Wells, Aquastat 39
WD40 237
 Wicking 218
 Wire Nuts 56
 Wire, Copper 56
 Wire, Thermostat 56
 Wire, Tracer 30, 232
 WM Inlet Hose 98
 Wrench, Element 227
 Wrench, Internal Spud ... 224
 Wrench, Radiator Spud . 227
 Wrench, Shower Socket 225
 Wrench, Strap 226
 Wrench, Toilet Seat 226
 Wrenches, Basin 227
 Wrenches, Channellock 209
 Wrenches, Hex 69, 226
 Wrenches, Internal 212
 Wrenches, Locknut 224

Wrenches, No Hub 69, 228
 Wrenches, PO Plug 224
 Wrenches, Seat 225
 Wrenches, Spanner 224
 Wrenches, Spud Buddy 178
 Wrenches, Strainer 224
 Wrenches, Tub Drain 224
 Wrenches, Yellow Grip .. 209

X

X-pando 235

Y

Yellow Grip Wrenches 209
 Y Hose Mixer 98

Z

Zip Screws 68

**DRESSER™
PIPELINE SOLUTIONS**

**For Water
Service**

STYLE 38 COUPLINGS FOR STEEL PIPE

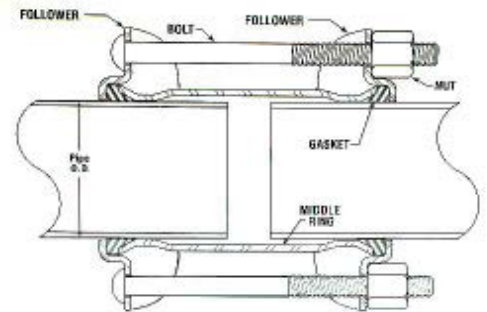

Anatomy of a Style 38 Dresser Coupling

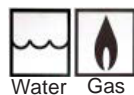

Water Gas



Water



Water Steam

Size	[OD]	Armored	Plain	Low Pressure Steam
1/2" IPS	[.84]	2801002	2801302	-
3/4" IPS	[1.05]	2801004	2801304	-
1" IPS	[1.32]	2801006	2801306	-
1 1/4" IPS	[1.66]	2801008	2801308	-
1 1/2" IPS	[1.90]	2801010	2801310	-
2" IPS	[2.38]	2801012	2801312	2801498
2 1/2" IPS	[2.88]	2801014	2801314	2801500
3" IPS	[3.50]	2801016	2801316	2801502
3 1/2" IPS	[4.00]	2801018	2801318	2801503
4" IPS	[4.50]	2801020	2801320	2801504
5" IPS	[5.563]	2801022	2801322	2801506
6" IPS	[6.63]	2801024	2801324	2801508
8" IPS	[8.63]	2801026	2801326	2801510
10" IPS	[10.75]	2801028	2801328	2801512
12" IPS	[12.75]	2801030	2801330	2801514

- All **Style 38's** feature a Fusion-Bonded Epoxy Coating to prevent corrosion, except for Steam Couplings (Red Shop Coat)
- All **Style 38's** have corrosion-resistant alloy bolts and nuts (5/8" x 8 1/4")
- **Wal-Rich** stocks all Style 38's with **5"** long **middle rings** (the body of the coupling)
- For special sizes or configurations, call our Dresser Specialists at 800-221-1157

**DRESSER™
PIPELINE SOLUTIONS**

**For Water
Service**

**STYLE 65 GALVANIZED
COMPRESSION FITTINGS
FOR STEEL PIPE**



Armored Gaskets

Water

W-R#	Diameter
2804202	1/2" Short #65 Coupling
2804204	3/4" Short #65 Coupling
2804206	1" Short #65 Coupling
2804208	1 1/4" Short #65 Coupling
2804210	1 1/2" Short #65 Coupling
2804212	2" Short #65 Coupling

W-R#	Diameter
2804002	1/2" Long #65 Coupling
2804004	3/4" Long #65 Coupling
2804006	1" Long #65 Coupling
2804008	1 1/4" Long #65 Coupling
2804010	1 1/2" Long #65 Coupling
2804012	2" Long #65 Coupling

W-R#	Diameter
2804402	1/2" #65 90° Elbow
2804404	3/4" #65 90° Elbow
2804406	1" #65 90° Elbow
2804408	1 1/4" #65 90° Elbow
2804410	1 1/2" #65 90° Elbow
2804412	2" #65 90° Elbow

W-R#	Diameter
2804301	1/2" #65 Male Adapter
2804302	3/4" #65 Male Adapter
2804304	1" #65 Male Adapter
2804306	1 1/4" #65 Male Adapter
2804308	1 1/2" #65 Male Adapter
2804310	2" #65 Male Adapter

- For Water Service. Rated to 150 PSI,
at temperatures up to 150 degrees

**DRESSER™
PIPELINE SOLUTIONS**

**For Water
Service**

**STYLE 90 COMPRESSION
FITTINGS FOR STEEL PIPE
(SEAL-ONLY)**



W-R# Description

2806004	¾"	Style 90 Coupling
2806006	1"	Style 90 Coupling
2806008	1¼"	Style 90 Coupling
2806010	1½"	Style 90 Coupling
2806012	2"	Style 90 Coupling

W-R# Description

2814602	¾"	Style 90 Elbow
2814604	1"	Style 90 Elbow
2814606	1¼"	Style 90 Elbow
2814608	1½"	Style 90 Elbow
2814610	2"	Style 90 Elbow

W-R# Description

2806502	¾"	Style 90 Male Adptr
2806504	1"	Style 90 Male Adptr
2806506	1¼"	Style 90 Male Adptr
2806508	1½"	Style 90 Male Adptr
2806510	2"	Style 90 Male Adptr

- Max Temp: 212°
- Standard "Seal-Only" Style 90 Fittings can be used for water and gas service where allowed by local codes.

**DRESSER™
PIPELINE SOLUTIONS**

**For Water
Service**

STYLE 118 HANDIBAND® CLAMPS

3" ONE BOLT CLAMPS



W-R#	Diameter x Length	
2817002	1/2" x 3"	Single Bolt
2817006	3/4" x 3"	Single Bolt
2817010	1" x 3"	Single Bolt
2817014	1 1/4" x 3"	Single Bolt
2817018	1 1/2" x 3"	Single Bolt
2817022	2" x 3"	Single Bolt
2817026	2 1/2" x 3"	Single Bolt
2817030	3" x 3"	Single Bolt
2817034	4" x 3"	Single Bolt
2817039	5" x 3"	Single Bolt
2817038	6" x 3"	Single Bolt
2817043	8" x 3"	Single Bolt

6" TWO BOLT CLAMPS

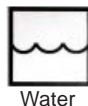

W-R#	Diameter x Length	
2817004	1/2" x 6"	Double Bolt
2817008	3/4" x 6"	Double Bolt
2817012	1" x 6"	Double Bolt
2817016	1 1/4" x 6"	Double Bolt
2817020	1 1/2" x 6"	Double Bolt
2817024	2" x 6"	Double Bolt
2817028	2 1/2" x 6"	Double Bolt
2817032	3" x 6"	Double Bolt
2817036	4" x 6"	Double Bolt
2817040	6" x 6"	Double Bolt
2817044	8" x 6"	Double Bolt

12" TWO BOLT CLAMPS

W-R#	Diameter x Length	
2817025	2" x 12"	Double Bolt
2817033	3" x 12"	Double Bolt
2817037	4" x 12"	Double Bolt
2817042	6" x 12"	Double Bolt
2817046	8" x 12"	Double Bolt

- Max Temp: 150°F

Lugs: Ductile Iron
Band: Stainless Steel
Bolts: Brass-Plated Alloy Steel
Gasket: Grade 304 material can be used with water, air, oils, aromatic & aliphatic hydrocarbons, gasoline, & natural gas.

**DRESSER™
PIPELINE SOLUTIONS**

**For Water
Service**

**STYLE 360 “ALL-AROUND”
REPAIR CLAMPS**

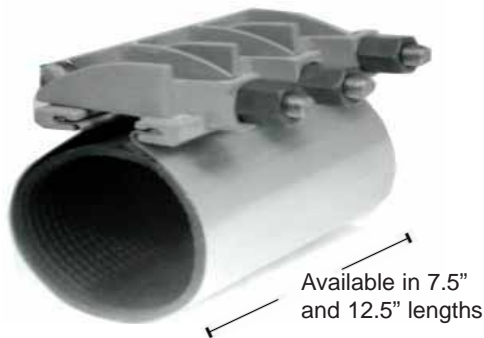

Lugs: Ductile Iron
Band: Stainless Steel
Bolts: Brass-Plated Alloy Steel
Gasket: Grade 304 material can be used with water, air, oils, aromatic & aliphatic hydrocarbons, gasoline, & natural gas.

- Max Temp: 150°F

for STEEL/PVC [OD]

For COPPER [OD]

For CAST/DUCTILE [OD]

7.5” LONG CLAMPS

2822500 2” [2.375]	2822602 2 1/2” CTS [2.63]	2822702 3” DIP [3.73-4.00]
2822502 3” [3.50]	2822604 3” CTS [3.13]	2822704 4” DIP [4.74-5.14]
2822504 4” [4.50]	2822606 4” CTS [4.13]	2822706 6” DIP [6.84-7.24]
2822506 6” [6.63]		2822708 8” DIP [8.99-9.39]
2822508 8” [8.63]		2822710 10” DIP [11.04-11.44]
2822510 10” [10.75]		2822712 12” DIP [13.10-13.50]
2822512 12” [12.75]		

12.5” LONG CLAMPS

2822000 2” [2.375]	2822102 2 1/2” CTS [2.63]	2822202 3” DIP [3.73-4.00]
2822002 3” [3.50]	2822104 3” CTS [3.13]	2822204 4” DIP [4.74-5.14]
2822004 4” [4.50]	2822106 4” CTS [4.13]	2822206 6” DIP [6.84-7.24]
2822006 6” [6.63]		2822208 8” DIP [8.99-9.39]
2822008 8” [8.63]		2822210 10” DIP [11.04-11.44]
2822010 10” [10.75]		2822212 12” DIP [13.10-13.50]
2822012 12” [12.75]		

**DRESSER™
PIPELINE SOLUTIONS**

**For Gas
Service**

**STYLE 39 COUPLING FOR STEEL--INSULATED,
FOR GAS APPLICATIONS**



Insulating Sleeve



Insulating Sleeve,
Gasket, & Spacer



W-R#	Description	Insulating Sleeve	
2803000	2"	IPS	One-End
2803002	2½"	IPS	One-End
2803004	3"	IPS	One-End
2803006	4"	IPS	One-End
2803008	6"	IPS	One-End
2803010	8"	IPS	One-End

- Features rubber insulating sleeve and anode for conductivity
- Fusion-bonded epoxy coat.
- Style 39 couplings are "Seal-Only"--for aboveground use (meter set)

**STYLE 711 BOLTED COUPLINGS
WITH "RESTRAINING SEAL"
FOR STEEL PIPE**

Pullout Prevention Products

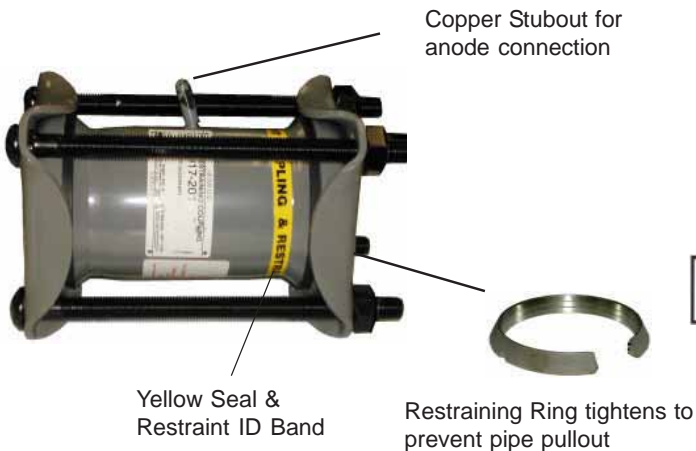

W-R#	Description		
2833002	2"	IPS	- Steel Pipe
2833006	3"	IPS	- Steel Pipe
2833008	4"	IPS	- Steel Pipe

W-R#	Description		
2834002	2"	IPS	- *PE* SDR-11
2834006	3"	IPS	- *PE* SDR-11
2834006	3"	IPS	- *PE* SDR-11.5
2834008	4"	IPS	- *PE* SDR-11

- furnished with 2 heavy steel stiffeners

**DRESSER™
PIPELINE SOLUTIONS**

**For Gas
Service**

**STYLE 90 "SEAL ONLY" FITTING FOR STEEL PIPE,
INSULATED FOR GAS**



1/8" tap



W-R# Description

2815802	3/4"	Insulated Coupling
2815804	1"	Insulated Coupling
2815806	1 1/4"	Insulated Coupling
2815808	1 1/2"	Insulated Coupling
2815810	2"	Insulated Coupling

- Insulating sleeve and spacer to conform to local codes.
- Seal Only--no restraint.

W-R# Description

2820002	3/4"	Insulated Cplg w/ Tap
2820004	1"	Insulated Cplg w/ Tap
2820006	1 1/4"	Insulated Cplg w/ Tap
2820008	1 1/2"	Insulated Cplg w/ Tap
2820010	2"	Insulated Cplg w/ Tap

- Insulated coupling with 1/8" tapping to meet Con Ed specs.
- Heavy-duty machined-steel body.
- Seal Only--no restraint.

W-R# Description

2816002	3/4"	Insulated Elbow
2816004	1"	Insulated Elbow
2816006	1 1/4"	Insulated Elbow
2816008	1 1/2"	Insulated Elbow
2816010	2"	Insulated Elbow

- Seal Only--no restraint.

**DRESSER™
PIPELINE SOLUTIONS**

**For Gas
Service**

**“UNIVERSAL” STYLE 90 COUPLINGS
WITH “RESTRAINING SEAL”**



FOR STEEL

Pullout Prevention Products

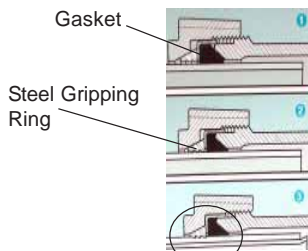

Upon tightening nut, gasket compresses to create seal and steel rings grip pipe to prevent pullout.



Steel Gripping Ring



W-R#	Description
2816602	3/4" "Universal" Coupling
2816604	1" "Universal" Coupling
2816606	1 1/4" "Universal" Coupling
2816608	1 1/2" "Universal" Coupling
2816610	2" "Universal" Coupling

- Seal & Restraint coupling

FOR POLYETHYLENE



W-R#	Description	SDR
2817702	3/4" "Universal"	11
2817704	1" "Universal"	11
2817706	1 1/4" "Universal"	10
2817708	1 1/2" "Universal"	11
2817710	2" "Universal"	11

- Seal & Restraint coupling

**DRESSER™
PIPELINE SOLUTIONS**

**For Hi-Temp
Applications**

STYLE 38 HI-TEMP COUPLINGS



Max Temp: 1200°



Carded Glass
Gasket



Steam

W-R#	Description	OD
2801489	½" IPS	[.84]
2801490	¾" IPS	[1.05]
2801492	1" IPS	[1.32]
2801494	1¼" IPS	[1.66]
2801496	1½" IPS	[1.90]
2801498	2" IPS	[2.38]
2801500	2½" IPS	[2.88]
2801502	3" IPS	[3.50]
2801503	3½" IPS	[4.00]
2801504	4" IPS	[4.50]
2801506	5" IPS	[5.563]
2801508	6" IPS	[6.63]
2801510	8" IPS	[8.63]
2801512	10" IPS	[10.75]
2801514	12" IPS	[12.75]

- Carded Fiberglass. Withstands temperatures to 1200°. Please note: the non-resilient characteristic of carded fiberglass gaskets can result in a non-leakproof seal.

STYLE 90 HI-TEMP COUPLINGS



Max Temp: 1200°



Carded Glass
Gasket



Steam

W-R#	Description
2814402	½" Style 90 - Hi Temp
2814404	¾" Style 90 - Hi Temp
2814406	1" Style 90 - Hi Temp
2814408	1¼" Style 90 - Hi Temp
2814410	1½" Style 90 - Hi Temp
2814412	2" Style 90 - Hi Temp

- Carded Fiberglass. Withstands temperatures to 1200°. Please note: the non-resilient characteristic of carded fiberglass gaskets can result in a non-leakproof seal.

**DRESSER™
PIPELINE SOLUTIONS**

STYLE 175 GTO/CURB VALVES



W-R# Description

2817112	3/4"	#175 GTO Valve
2817114	1"	#175 GTO Valve
2817116	1 1/4"	#175 GTO Valve
2817118	1 1/2"	#175 GTO Valve
2817120	2"	#175 GTO Valve

- FIP x FIP
- Tamper-proof design
- 1/4 Turn

STYLE 275 LOCK WING METER VALVES



W-R# Description

2817150	3/4"	#275 Lockwing
2817152	1"	#275 Lockwing
2817154	1 1/4"	#275 Lockwing

- FIP x FIP
- Tamper-proof design

STYLE 91 SERVICE SADDLES

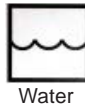

W-R# Description

2807001	2" X 1"	Double-Stirrup
2807002	2" X 1 1/4"	Double-Stirrup
2807004	2" X 1 1/2"	Double-Stirrup

- Max Temp 212°

**DRESSER™
PIPELINE SOLUTIONS**

**Parts for
Style 38
Couplings**



**WATER
SERVICE**

Plain Grade 27
Buna-S gasket

W-R#	Description
2817602	1/2"
2817604	3/4"
2817606	1"
2817608	1 1/4"
2817610	1 1/2"
2817612	2"
2817614	2 1/2"
2817616	3"
2817618	3 1/2"
2817620	4"
2817622	5"
2817624	6"
2817626	8"
2817628	10"
2817630	12"



**GAS
SERVICE**

Armored Grade 27
Buna-S gasket.
Brass coil provides
additional conductivity.

W-R#	Description
2817502	1/2"
2817504	3/4"
2817506	1"
2817508	1 1/4"
2817510	1 1/2"
2817512	2"
2817514	2 1/2"
2817516	3"
2817518	3 1/2"
2817520	4"
2817522	5"
2817524	6"
2817526	8"
2817528	10"
2817530	12"



**OIL
SERVICE**

Grade 42 BUNA-N
Gaskets for fuel oil &
gasoline.

W-R#	Description
2801462	2"
2801464	2 1/2"
2801466	3"
2801467	3 1/2"
2801468	4"
2801470	5"
2801472	6"
2801474	8"
2801476	10"
2801478	12"



**HI-TEMP
CARDED GLASS**

For steam & air
applications up to 1200°.
Please note: the non-
resilient characteristic of
carded fiberglass gaskets
can result in a non-leakproof
seal.

W-R#	Description
2817276	1/2"
2817278	3/4"
2817280	1"
2817282	1 1/4"
2817284	1 1/2"
2817286	2"
2817288	2 1/2"
2817302	3"
2817303	3 1/2"
2817304	4"



NUTS & BOLTS

Dresserloy® Carbon Steel Epoxy-
coated bolts & nuts

W-R#	Description
2818312	5/8" x 8 1/4" Nut & Bolt
2818314	5/8" x 10 3/4" Nut & Bolt

- Also available in 304 Stainless Steel
and 316 Stainless Steel

**PIPE CONNECTIONS
& REPAIR**



**WAL-RICH HINGED
STEEL PIPE CLAMP**

W-R#	Description	Min	Box
2206002	1/2"	1	5
2206006	3/4"	1	5
2206010	1"	1	5
2206014	1 1/4"	1	5
2206018	1 1/2"	1	5
2206022	2"	1	1
2206026	2 1/2"	1	1
2206030	3"	1	1



STEEL REPAIR PLATES

W-R#	Description	Min	Box
2204002	2"	1	6
2204004	3"	1	6
2204006	4"	1	6
2204008	5"	1	6



**STAINLESS STEEL
WRAP-AROUND REPAIR
CLAMPS**

SHORT (3" ONE-BOLT)		LONG (6" TWO-BOLT)	
2206102	3/8"	2206202	3/8"
2206104	1/2"	2206204	1/2"
2206106	3/4"	2206206	3/4"
2206108	1"	2206208	1"
2206110	1 1/4"	2206210	1 1/4"
2206112	1 1/2"	2206212	1 1/2"
2206114	2"	2206214	2"



**CAST IRON TAPPED
SADDLE TEE**

W-R#	Description	Min	Box
0422010	4" x 2"	1	12



NO-HUB COUPLINGS

W-R#	Description	Min	Box
2540002	1 1/2" X 1 1/2"	1	20
2540004	2" X 2"	1	20
2540006	2" X 1 1/2"	1	20
2540008	3"	1	20
2540010	4"	1	20



- Imported
- All-stainless clamps

**PIPE CONNECTIONS
& BRASS WATER
SERVICE FITTINGS**



**W-R GALVANIZED
MALLEABLE IRON
COMPRESSION
COUPLING**

DIA.	SHORT (LENGTH)	LONG (LENGTH)
1/2"	2560002 2 3/4"	2561002 4 1/4"
3/4"	2560004 3"	2561004 4 1/4"
1"	2560006 3 1/4"	2561006 4 1/2"
1 1/4"	2560008 3 1/4"	2561008 4 3/4"
1 1/2"	2560010 3 1/4"	2561010 5"
2"	2560012 3 1/2"	2561012 5 1/4"
2 1/2"	2560014 4"	2561014 5 3/4"
3"	2560016 4 1/2"	2561016 7"

- 125 psi at 120°
- Imported



**W-R BRASS
COMPRESSION
COUPLINGS
- LEAD FREE -**



SHORT (3")	LONG (5")	IPS	COPPER
4531000	4532000	3/8"	1/2"
4531002	4532002	1/2"	3/4"
4531004	4532004	3/4"	1"
4531006	4532006	1"	
4531008	4532008	1 1/4"	
4531010	4532010	1 1/2"	
4531012	4532012	2"	

- Copper tube size equivalents of these couplings are listed in the above table. Sizes over 3/4" IPS do not have reliable copper tube size equivalents.
- 125 psi at 180°
- Imported



**AA LEAD X MIPS
PACK-JOINT ADAPTER
- LEAD FREE -**



W-R#	Description
4819002	5/8" AA x 3/4" MIPS
4819004	3/4" AA x 3/4" MIPS
4819006	1" AA x 1" MIPS
4819008	1 1/4" AA x 1 1/4" MIPS
4819010	1 1/2" AA x 1 1/2" MIPS
4819012	2" AA x 2" MIPS

BRASS WATER SERVICE FITTINGS



**COPPER X MIPS
PACK-JOINT ADAPTER
- LEAD FREE -**

LEAD-FREE

W-R#	Description
4819204	3/4" Cop x 3/4" MIPS
4819206	1" Cop x 1" MIPS
4819208	1 1/4" Cop x 1 1/4" MIPS
4819210	1 1/2" Cop x 1 1/2" MIPS
4819212	2" Cop x 2" MIPS

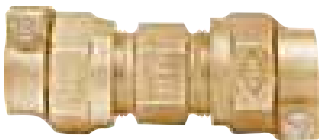

**COPPER X COPPER
PACK-JOINT ADAPTER
- LEAD FREE -**

LEAD-FREE

W-R#	Description
4819104	3/4" Cop x 3/4" Cop
4819106	1" Cop x 1" Cop
4819108	1 1/4" Cop x 1 1/4" Cop
4819110	1 1/2" Cop x 1 1/2" Cop
4819112	2" Cop x 2" Cop



**WATER METER
COUPLINGS WITH
WASHER
- LEAD FREE -**

LEAD-FREE

W-R#	Description	Min.	Box
4429002	5/8"	1 pr.	20
4429004	3/4"	1 pr.	20
4429005	1"	1 pr.	10

- Pairs with washers



**WATER METER
COUPLING WASHERS**

W-R#	Description	Min.	Box
2725004	1/2"	12	12
2725006	3/4"	12	12

- Rubber



**BRASS WATER METER
FLANGE SET
- LEAD FREE -**

LEAD-FREE

W-R#	Description	Min.	Box
4429502	1 1/2"	1	-
4429504	2"	1	-

- Boxed with 2 flanges, nuts, bolts, & gaskets

**PIPE CONNECTIONS
& REPAIR**



**RUBBER TRANSITION
COUPLINGS**

W-R#	Description	Min	Box
2533001	1¼" x 1¼"	1	40
2533002	1½" x 1¼"	1	40
2533004	1½" x 1½"	1	40
2533006	2" x 1½"	1	20
2533008	2" x 2"	1	20
2533012	3" x 2"	1	20
2533014	3" x 3"	1	20
2533015	4" x 2"	1	20
2533016	4" x 3"	1	20
2533018	4" x 4"	1	10
2533020	6" x 4"	1	10
2533022	6" x 6"	1	4

- Sizes listed are for Schedule 40 Steel, Cast Iron, and PVC



**RUBBER TRANSITION
DONUTS**

W-R#	Description	Min	Box
2533500	2" x 1½"	1	20
2533502	2" x 2"	1	20
2533506	3" x 2"	1	20
2534000	3" x 3"	1	10
2535000	4" x 3"	1	10
2536000	4" x 4"	1	10



**RUBBER DRAIN AND
TRAP CONNECTION**

W-R#	Description
1662002	1½" Sch 40 x 1 1/2" tubular
1662004	2" Sch 40 x 1½" tubular
1662006	1½" tubular x 1½" tubular

- Drain and trap connections are 12 per box, with a one piece minimum.



**RUBBER WASHING
MACHINE HOSE GRIPS**

W-R#	Description	Min	Box
2533000	1½"	1	12

• Fits 2" or 1½" standpipe x 1" to 1 7/16" washing machine discharge hose.

**PIPE CONNECTIONS
& REPAIR**



**SKINNER®
EMERGENCY PIPE
CLAMPS**

W-R#	Description	Min	Box
2641002	1/2"	1	5
2641004	3/4"	1	5
2641006	1"	1	5
2641008	1 1/4"	1	5
2641010	1 1/2"	1	5
2641012	2"	1	1
2641014	2 1/2"	1	1
2641016	3"	1	1
2641018	3 1/2"	1	1
2641020	4"	1	1
2641022	5"	1	1
2641024	6"	1	1

- Temperature rating: up to 250°F
- Pressure Rating: up to 600 psi
- Buna N gasket can be used on water, gas, & oil.



**KRAUSZ® "HYMAX"
WIDE-RANGE
TRANSITION
COUPLINGS**

W-R#	Nom	Low Range	High Range
2630002	2"	(2.10-2.60)	(2.56-3.03)
2630004	3"	(3.46-3.90)	(3.86-4.33)
2630006	4"	(4.25-5.00)	(4.92-5.63)
2630007	5"	(5.12-5.75)	(5.71-6.38)
2630008	6"	(6.42-7.05)	(7.01-7.68)
2630010	8"	(8.54-9.17)	(9.13-9.84)
2630012	10"	(10.70-11.37)	(11.33-12.00)
2630014	12"	(12.40-13.03)	(12.99-13.66)

- Wide range allows for transitions between cast iron, steel, PVC, & HDPE pipe.
- For water service only
- Temperature range: -20°F - 220°F
- Pressure rating: up to 260 psi



Patented 2-layer gasket pulls away to enable hi-range.

GAS METER SPECIALTIES



**SIDE-IN / TOP-OUT
METER BARS**

BLACK

W-R#	Length	Inlet	Outlet	Swivel	Finish
0418002	6"	1"	1"	1"	Black
0418004	6 1/2"	1"	1"	1"	Black
0418006	7"	1 1/4"	1 1/4"	1 1/4"	Black

- Keyspan/National Grid pattern



**SIDE-IN / SIDE-OUT
METER BARS**

BLACK

W-R#	Length	Inlet	Outlet	Swivel	Finish
0419002	6"	1"	1"	1"	Black
0419004	8 1/4"	1"	1 1/4"	1 1/4"	Black

- ConEd pattern



**BALL VALVE
METER BARS**

BLACK

W-R#	Length	Inlet	Outlet	Swivel	Finish
0423002	6"	1"	1"	1"	Black

- ConEd pattern



**MALLEABLE IRON
INSULATED UNIONS**



W-R#	Size (NPT)	Finish
0417702	3/4"	Black
0417704	1"	Black
0417706	1 1/4"	Black

- Flat Insulating Washer



METER BAR ADAPTER



W-R#	Size (NPT)	Min	Box
0423702	1 1/4" x 1"	1	-

GAS METER SPECIALTIES



OFFSET SWIVELS FOR GAS METERS

W-R#	Size (NPT)	LT.	Finish
0416602	3/4"	10	Black
0416604	1"	20	Black
0416606	1 1/4"	30	Black



NUTS FOR GAS METERS

W-R#	Size (NPT)	LT.	Finish
0416802	3/4"	10	Black
0416804	1"	20	Black
0416806	1 1/4"	30	Black



STRAIGHT SWIVELS FOR GAS METERS

W-R#	Size (NPT)	LT.	Finish
0416902	3/4"	10	Black
0416904	1"	20	Black
0416906	1 1/4"	30	Black



METER PLUGS WITH TAP

W-R#	Size (NPT)	LT.	Tap Size
0418802	1"	20	1/8"
0418804	1 1/4"	30	1/4"



RUBBER WASHER FOR METER BAR



W-R#	Size (NPT)	LT.
0417602	3/4"	10
0417604	1"	20
0417606	1 1/4"	30



GAS REGULATOR VENTS ("PECK" VENTS)



W-R#	Description
1754002	3/4" With Screen
1754004	1" With Screen
1754006	1 1/4" With Screen
1754008	1 1/2" With Screen
1754010	2" With Screen

GAS METER SPECIALTIES



**AY MCDONALD®
LOCKWING GAS COCK**

BLACK

W-R#	Description	PSI	Min	Box
0416002	3/4"	175	1	25
0416004	1"	175	1	15
0416006	1 1/4"	175	1	10
0416008	1 1/2"	175	1	5
0416010	2"	175	1	5

- FIP x FIP
- Tamper-proof design



**DRESSER STYLE 275®
LOCKWING GAS METER
VALVES**



BLACK

W-R#	Description
2817150	3/4" #275 Lockwing
2817152	1" #275 Lockwing
2817154	1 1/4" #275 Lockwing

- FIP x FIP
- Tamper-proof design



**FLOWSERVE®
LUBRICATED PLUG
VALVES**

W-R#	Description
0424116	3" #142 Plug Valve
0424120	4" #142 Plug Valve

- FIP x FIP
- Iron Body Lubricated Plug Valve
- Short Pattern
- 200 psi CWP (Cold Working Pressure)

W-R#	Description
0425002	3" #142T Tamperproof
0425004	4" #142T Tamperproof

- FIP x FIP
- Iron Body Lubricated Plug Valve
- Short Pattern
- 200 psi CWP (Cold Working Pressure)
- ConEd pattern

EXPANSION JOINTS



**SINGLE-SPHERE 150#
EXPANSION JOINT**

NEW!



W-R#	Size	A	B	C	D
2790002	2"	0.50	0.375	0.50	20°
2790004	2 1/2"	0.50	0.375	0.50	17°
2790006	3"	0.50	0.375	0.50	14°
2790008	4"	0.75	0.50	0.50	14°
2790012	6"	0.75	0.50	0.50	9°

- Pressure Rating:	225 PSI	Axial Compression:	A
- Vacuum Rating:	26 in/Hg	Axial Extension:	B
- Max Temp:	230° F	Lateral Deflection:	C
- Material:	Neoprene	Angular Movement:	D



CTS COMPENSATORS

NEW!



W-R#	Size	A	B	C
2796002	3/4"	2"	0.50"	11"
2796004	1"	2"	0.50"	11 1/4"
2796006	1 1/4"	2"	0.50"	12 1/2"
2796008	1 1/2"	2"	0.50"	12 7/8"
2796010	2"	2"	0.50"	13"

- Pressure Rating:	150 PSI	Axial Compression:	A
- Test Pressure:	225 PSI	Axial Extension:	B
- Max Temp:	500° F	Overall Length :	C



**MAGNESIUM ANODE
BAGS**

NEW!

W-R#	Description
2761002	3 lb. bag
2761004	17 lb. bag
2761006	32 lb. bag



**DRIVE-IN
MAGNESIUM
SPIKE ANODES**

NEW!

W-R#	Description
2762002	3# w/lead wire & clamp



Con-Stab ID Seal® Fittings have been sold in the gas, plumbing, and propane markets since 1990. **Con-Stab®** fittings are IAPMO, CSA, & ICC approved.



for: **Pool Heaters**



for: **Gas Grills**



for: **Patio Hearths & Lighting**



for: **Emergency Generators**

CON-STAB® ANODELESS METER RISERS

- Fusion-bonded epoxy coating
- Anodeless and corrosion resistant
- **Patented "ID-Seal" fitting** (inside chamfer)

Always Match Pipe Size & SDR



W-R	Size	Wall (CTS) or SDR
2886036	1/2" CTS	.090
2886004	3/4" IPS	SDR-11
2886008	1" IPS	SDR-11
2886040	1" CTS	.099/.101
2886012	1 1/4" IPS	SDR-10
2886013	1 1/4" IPS	SDR-11
2886016	1 1/2" IPS	SDR-11
2886020	2" IPS	SDR-11

IMPORTANT
CHAMFER THE ID OF PIPE



You must use a **Continental Chamfer Tool** on a **Continental Fitting!**



POLY-END ANODELESS METER RISERS

- Fusion-bonded epoxy coating
- Anodeless and corrosion resistant
- Plain PE end can be used with compression & "stab" fittings
- 3" must be used with Dresser Style 711 couplings. See page 6.

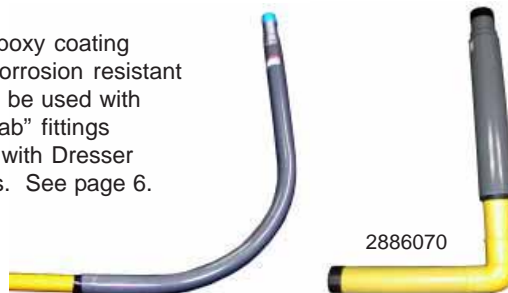

2886070

W-R	Size	Wall (CTS) or SDR
2886002	3/4" IPS	SDR-11
2886006	1" IPS	SDR-11
2886030	1" CTS	.099/.101
2886010	1 1/4" IPS	SDR-10
2886011	1 1/4" IPS	SDR-11
2886014	1 1/2" IPS	SDR-11
2886018	2" IPS	SDR-11
2886070	3" IPS	SDR-11.5



Con-Stab ID Seal® Fittings have been sold in the gas, plumbing, and propane markets since 1990. **Con-Stab®** fittings are IAPMO, CSA, & ICC approved.

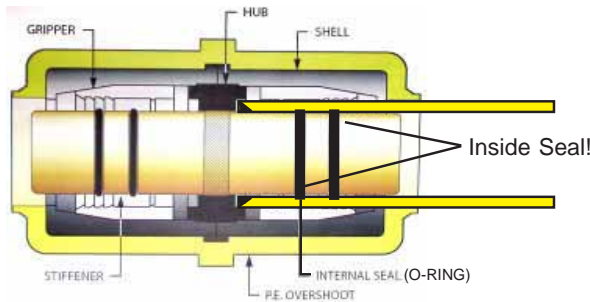

Con-Stab®'s patented "ID-Seal" is formed on the **INSIDE** of the pipe--where the surface is the smoothest. Therefore you must chamfer the **INSIDE** of your pipe with a Continental® Chamfer tool.

From NFPA 54 Section 3.3.5
 "An **anodeless riser** is an assembly of steel-cased plastic pipe used to make the transition between plastic piping underground and metal piping aboveground."



Plastic Pipe runs inside the riser.

Corrosion-resistant fusion-bonded epoxy coating



CON-STAB® COUPLINGS

Always Match Pipe Size & SDR



W-R	Size	Wall (CTS) or SDR
2881000	1/2" CTS	.090
2881002	3/4" IPS	SDR-11
2881004	1" IPS	SDR-11
2881020	1" CTS	.099/.101
2881006	1 1/4" IPS	SDR-10
2881007	1 1/4" IPS	SDR-11
2881008	1 1/2" IPS	SDR-11
2881010	2" IPS	SDR-11



CON-STAB® ELBOWS

Always Match Pipe Size & SDR



W-R	Size	Wall (CTS) or SDR
2882000	1/2" CTS	.090
2882002	3/4" IPS	SDR-11
2882004	1" IPS	SDR-11
2882020	1" CTS	.099/.101
2882006	1 1/4" IPS	SDR-10
2882007	1 1/4" IPS	SDR-11
2882008	1 1/2" IPS	SDR-11
2882010	2" IPS	SDR-11



CON-STAB® TEES

Always Match Pipe Size & SDR



W-R	Size	Wall (CTS) or SDR
2883000	1/2" CTS	.090
2883002	3/4" IPS	SDR-11
2883004	1" IPS	SDR-11
2883020	1" CTS	.099/.101
2883006	1 1/4" IPS	SDR-10
2883007	1 1/4" IPS	SDR-11
2883008	1 1/2" IPS	SDR-11
2883010	2" IPS	SDR-11



Con-Stab ID Seal® Fittings have been sold in the gas, plumbing, and propane markets since 1990. **Con-Stab®** fittings are IAPMO, CSA, & ICC approved.

CON-STAB® MALE ADAPTERS



Always Match Pipe Size & SDR



W-R	Size	Wall (CTS) or SDR
2885000	1/2"	CTS .090
2885002	3/4"	IPS SDR-11
2885004	1"	IPS SDR-11
2885020	1"	CTS .099/.101
2885006	1 1/4"	IPS SDR-10
2885007	1 1/4"	IPS SDR-11
2885008	1 1/2"	IPS SDR-11
2885010	2"	IPS SDR-11

- Standard sizes with 4" long steel MIP stub.

POLY PLAIN-END MALE ADAPTERS



Always Match Pipe Size & SDR



W-R	Size	Wall (CTS) or SDR
2885050	3/4"	IPS SDR-11
2885052	1"	IPS SDR-11
2885070	1"	CTS .099/.101
2885054	1 1/4"	IPS SDR-10
2885055	1 1/4"	IPS SDR-11
2885056	1 1/2"	IPS SDR-11
2885058	2"	IPS SDR-11

- Standard sizes with 4" long steel MIP stub.
- Plain End can be used with stab couplings, compression couplings, and fusion fittings.



CON-STAB® CHAMFER TOOL

Always Match Pipe Size & SDR

LOOK FOR THE "C"
You must use a **Continental** Chamfer Tool on a **Continental** Fitting!

W-R	Size	Wall (CTS) or SDR
2888020	1/2"	CTS .090
2888014	3/4"	IPS SDR-11
2888016	1"	IPS SDR-11
2888022	1"	CTS .099/.101
2888006	1 1/4"	IPS SDR-10
2888007	1 1/4"	IPS SDR-11
2888008	1 1/2"	IPS SDR-11
2888010	2"	IPS SDR-11

- **Follow the Arrow!** Turn the tool in the direction of the arrow printed on the tool for a clean, even chamfer (bevel) on the inside of the pipe.



Con-Stab ID Seal® Fittings have been sold in the gas, plumbing, and propane markets since 1990. **Con-Stab®** fittings are IAPMO, CSA, & ICC approved.



CON-STAB® x COPPER TRANSITION FITTING

Always Match Pipe Size & SDR



W-R	Con-Stab®	Copper Tube
2884002	3/4" SDR 11	1/2" Flare

- Con-Stab® x Flare connection for copper tubing



CON-STAB® REDUCING COUPLINGS

IPS X IPS

Always Match Pipe Size & SDR



W-R	IPS X IPS REDUCERS	
2891030	1" SDR11	x 3/4" SDR11

2891049	1 1/4" SDR10	x 3/4" SDR11
2891021	1 1/4" SDR10	x 1" SDR11

2891050	1 1/4" SDR11	x 3/4" SDR11
2891022	1 1/4" SDR11	x 1" SDR11

2891010	1 1/2" SDR11	x 3/4" SDR11
2891012	1 1/2" SDR11	x 1" SDR11
2891013	1 1/2" SDR11	x 1 1/4" SDR10
2891014	1 1/2" SDR11	x 1 1/4" SDR11

2891002	2" SDR11	x 3/4" SDR11
2891004	2" SDR11	x 1" SDR11
2891005	2" SDR11	x 1 1/4" SDR10
2891006	2" SDR11	x 1 1/4" SDR11
2891008	2" SDR11	x 1 1/2" SDR11

W-R	CTS X IPS REDUCERS	
2890040	1/2" CTS	x 3/4" SDR11
2890042	1/2" CTS	x 1" SDR11

2890002	1" CTS	x 3/4" SDR11
2890004	1" CTS	x 1" SDR11



CON-STAB® 1 1/4" SDR-10 x SDR-11 ADAPTER

"THE MIRACLE FITTING"

SDR-11

SDR-10

W-R	Con-Stab® A	Con-Stab® B
2890008	1 1/4" IPS x SDR-10	1 1/4" IPS SDR-11



Con-Stab ID Seal® Fittings have been sold in the gas, plumbing, and propane markets since 1990. Con-Stab® fittings are IAPMO, CSA, & ICC approved.

CON-STAB® REDUCING TEES



Always Match Pipe Size & SDR



W-R	RUN	BRANCH
2883070	1" SDR11 x 3/4"	SDR11

2883061	1 1/4" SDR10 x 3/4"	SDR11
2883063	1 1/4" SDR10 x 1"	SDR11

2883062	1 1/4" SDR11 x 3/4"	SDR11
2883064	1 1/4" SDR11 x 1"	SDR11

2883080	1 1/2" SDR11 x 3/4"	SDR11
2883082	1 1/2" SDR11 x 1"	SDR11
2883083	1 1/2" SDR11 x 1 1/4"	SDR10
2883084	1 1/2" SDR11 x 1 1/4"	SDR11

2883050	2" SDR11 x 3/4"	SDR11
2883052	2" SDR11 x 1"	SDR11
2883053	2" SDR11 x 1 1/4"	SDR10
2883054	2" SDR11 x 1 1/4"	SDR11
2883056	2" SDR11 x 1 1/2"	SDR11

CON-STAB® SADDLE PUNCH TEES



Always Match Pipe Size & SDR



W-R	MAIN	OUTLET
2893090	1 1/4"	3/4" SDR-11
2893092	1 1/4"	1" SDR-11

2896002	1 1/2"	3/4" SDR-11
2896006	1 1/2"	1" SDR-11

2894002	2"	3/4" SDR-11
2894004	2"	1" SDR-11
2894006	2"	1 1/4" SDR-11

2894502	3"	3/4" SDR-11
2894504	3"	1" SDR-11
2894506	3"	1 1/4" SDR-11
2894508	3"	2" SDR-11



Con-Stab ID Seal® Fittings have been sold in the gas, plumbing, and propane markets since 1990. **Con-Stab®** fittings are IAPMO, CSA, & ICC approved.



CON-STAB® END CAPS

Always Match Pipe Size & SDR



W-R	Size	Wall (CTS) or SDR
2892000	1/2" CTS	.090
2892002	3/4" IPS	SDR-11
2892004	1" IPS	SDR-11
2892020	1" CTS	.099/.101
2892006	1 1/4" IPS	SDR-10
2892007	1 1/4" IPS	SDR-11
2892008	1 1/2" IPS	SDR-11
2892010	2" IPS	SDR-11

CONFLEX® FLEX RISERS FOR PROPANE



Continental "Con-Flex®" risers are **flexible** casings that protect **yellow polyethylene pipe** aboveground. **Con-flex®** risers consist of corrugated stainless steel flex hose, with a durable UV & weather-resistant outer sleeve. Conforms to NFPA 54 & 58 for LPG systems.

W-R	Description	Length
2887002	1/2" COP x 1/2" MIP	36"
2887004	1/2" COP x 1/2" MIP	84"
2887020	3/4" IPS x 3/4" MIP	36"
2887030	1" IPS x 1" MIP	36"



Instructions:

1. Disassemble the **adapter coupling** (B).
2. Feed the polyethylene pipe through the sleeve from the **moisture seal** (A) to the **adapter coupling** (B)
3. Assemble the **adapter coupling** by sliding the gasket over the tubing, and then pushing the tubing onto the insert. Tighten the compression nut until it bottoms out.



POLYETHYLENE GAS BALL VALVES

Always Match Pipe Size & SDR



W-R	Size	Wall (CTS) or SDR
2893102	3/4"	IPS SDR-11
2893104	1"	IPS SDR-11
2893106	1 1/4"	IPS SDR-11
2893108	1 1/2"	IPS SDR-11
2893110	2"	IPS SDR-11

Step 1: Match Pipe & SDR

BE SURE TO MATCH PIPE SIZE & SDR*

Pipe, Fittings, and Chamfer Tool must be the same!

*"SDR" stands for "Standard Dimension Ratio". It is a designation of a pipe's pressure rating. SDR is the ratio of Pipe Diameter to Wall Thickness.

Step 2: Chamfer Inside of Pipe

BEFORE
SQUARE-CUT

AFTER
CHAMFERED

CHAMFER INSIDE

Follow the arrows printed on the label. Only 3-5 turns necessary for a good chamfer!

The "coupon" is the piece of yellow poly that is shaved off during the act of chamfering.

Test your chamfer by pushing the pipe over the test gauge. If the pipe is chamfered properly, it should fit over the test gauge with minimum effort.

Test Gauge

Step 3: Mark Stab Depth

MARK THE STAB DEPTH!

1. Line up the end of the yellow pipe with the hub of the fitting.

2. Mark a line on the pipe to approximate the end of the fitting.

3. **Goal:** The reason to mark the stab depth is to ensure that the pipe is sealed by **both** o-rings!

"Hub"

Step 4: Stab & Check

STAB PIPE INTO FITTING

1/8"

Stab the pipe completely into the fitting, so that the "stab marker" is within 1/8" from the entrance of the fitting.

Once the pipe has been stabbed, it **cannot** be removed.

LOOK FOR THE "C"

You must use a **Continental Chamfer Tool** on a **Continental Fitting!**



YELLOW PLASTIC GAS PIPE

YELLOW "MEDIUM DENSITY" (PE2406) PE GAS PIPE



For several years, the gas utility and distribution market has used plastic gas pipe for its **ease-of-use, corrosion resistance, and cost effectiveness**. *NFPA 54* provides for the use of plastic piping within it's code for **outdoor, underground use only** at a **minimum burial depth of 18"**, using **yellow 14g tracer wire** for location purposes.



Call us today for:

- Free promotional materials
- One-on-One sales training
- Sizing/Technical assistance

W-R	Size	Wall (CTS) or SDR	Length
2880004	1/2" CTS	.090	500'
2880011	3/4" IPS	SDR-11	50'
2880012	3/4" IPS	SDR-11	150'
2880016	3/4" IPS	SDR-11	500'
2880020	1" CTS	.099/.101	150'
2880021	1" CTS	.099/.101	500'
2880025	1" IPS	SDR-11	50'
2880022	1" IPS	SDR-11	150'
2880026	1" IPS	SDR-11	500'
2880029	1 1/4" IPS	SDR-10	50'
2880030	1 1/4" IPS	SDR-10	150'
2880031	1 1/4" IPS	SDR-11	50'
2880032	1 1/4" IPS	SDR-11	150'
2880036	1 1/4" IPS	SDR-11	500' (*)
2880041	1 1/2" IPS	SDR-11	50'
2880042	1 1/2" IPS	SDR-11	150'
2880046	1 1/2" IPS	SDR-11	500' (*)
2880051	2" IPS	SDR-11	50'
2880052	2" IPS	SDR-11	100'
2880056	2" IPS	SDR-11	500' (*)
2880062	3" IPS	SDR-11.5	100' (*)

(*) Call for availability

LOW PRESSURE < 2PSI

HIGH PRESSURE = 2PSI

Pressure Drop: .5 in w.c. Spec. Gravity: .60						
Length (feet)	1/2 IPS SDR-9.3	3/4 IPS SDR-11	1 IPS SDR-11	1 1/4 IPS SDR-10	1 1/2 IPS SDR-11	2 IPS SDR-11
10	201	403	726	1260	1900	3410
20	138	277	499	865	1310	2350
30	111	222	401	695	1050	1880
40	95	190	343	594	898	1610
50	84	169	304	527	796	1430
60	76	153	276	477	721	1300
70	70	140	254	439	663	1190
80	65	131	236	409	617	1110
90	61	123	221	383	579	1040
100	58	116	209	362	547	983
125	51	103	185	321	485	871
150	46	93	168	291	439	789
175	43	86	154	268	404	726
200	40	80	144	249	376	675
250	35	71	127	221	333	598
300	32	64	115	200	302	542
350	29	59	106	184	278	499
400	27	55	99	171	258	464
450	26	51	93	160	242	435
500	24	48	88	152	229	411

Pressure Drop: 1.0 in w.c. Spec. Gravity: .60						
Length (feet)	1/2 IPS SDR-9.3	3/4 IPS SDR-11	1 IPS SDR-11	1 1/4 IPS SDR-10	1 1/2 IPS SDR-11	2 IPS SDR-11
10	1860	3720	6710	11600	17600	31600
20	1280	2560	4610	7990	12100	21700
30	1030	2050	3710	6420	9690	17400
40	878	1760	3170	5490	8300	14900
50	778	1560	2810	4870	7350	13200
60	705	1410	2550	4410	6660	12000
70	649	1300	2340	4060	6130	11000
80	603	1210	2180	3780	5700	10200
90	566	1130	2050	3540	5350	9610
100	535	1070	1930	3350	5050	9080
125	474	949	1710	2970	4480	8050
150	429	860	1550	2690	4060	7290
175	395	791	1430	2470	3730	6710
200	368	736	1330	2300	3470	6240
250	326	652	1180	2040	3080	5530
300	295	591	1070	1850	2790	5010
350	272	544	981	1700	2570	4610
400	253	506	913	1580	2390	4290
450	237	475	856	1480	2240	4020
500	224	448	809	1400	2120	3800

NATURAL GAS

LOW PRESSURE: 11 IN. W.C.

HIGH PRESSURE = 2PSI

Pressure Drop: .5 in w.c. Spec. Gravity: 1.50						
Length (feet)	1/2 IPS SDR-9.3	3/4 IPS SDR-11	1 IPS SDR-11	1 1/4 IPS SDR-10	1 1/2 IPS SDR-11	2 IPS SDR-11
10	340	680	1230	2130	3210	5770
20	233	468	844	1460	2210	3970
30	187	375	677	1170	1770	3180
40	160	321	580	1000	1520	2730
50	142	285	514	890	1340	2420
60	129	258	466	807	1220	2190
70	119	237	428	742	1120	2010
80	110	221	398	690	1040	1870
90	103	207	374	648	978	1760
100	98	196	353	612	924	1660
125	87	173	313	542	819	1470
150	78	157	284	491	742	1330
175	72	145	261	452	683	1230
200	67	135	243	420	635	1140
250	60	119	215	373	563	1010
300	54	108	195	338	510	916
350	50	99	179	311	469	843
400	46	92	167	289	436	784
450	43	87	157	271	409	736
500	41	82	148	256	387	695

Pressure Drop: 1.0 in w.c. Spec. Gravity: 1.50						
Length (feet)	1/2 IPS SDR-9.3	3/4 IPS SDR-11	1 IPS SDR-11	1 1/4 IPS SDR-10	1 1/2 IPS SDR-11	2 IPS SDR-11
10	3130	6260	11300	19600	29500	53100
20	2150	4300	7760	13400	20300	36500
30	1730	3450	6230	10800	16300	29300
40	1480	2960	5330	9240	14000	25100
50	1310	2620	4730	8190	12400	22200
60	1190	2370	4280	7420	11200	20100
70	1090	2180	3940	6830	10300	18500
80	1010	2030	3670	6350	9590	17200
90	952	1910	3440	5960	9000	16200
100	899	1800	3250	5630	8500	15300
125	797	1600	2880	4990	7530	13500
150	722	1450	2610	4520	6830	12300
175	664	1330	2400	4160	6280	11300
200	618	1240	2230	3870	5840	10500
250	548	1100	1980	3430	5180	9300
300	496	994	1790	3110	4690	8430
350	457	914	1650	2860	4320	7760
400	425	851	1530	2660	4020	7220
450	399	798	1440	2500	3770	6770
500	377	754	1360	2360	3560	6390

PROPANE

* Values listed are in cubic feet/meter (cfm). To calculate BTU, multiply by 1000.
 ** Source: NFPA 54-2012 Table 6.2 (s)

* Values listed are in cubic feet/meter (cfm). To calculate BTU, multiply by 1000.
 ** Source: NFPA 54-2012 Table 6.2 (s)

*Reproduced with permission from NFPA 54, National Fuel Gas Code, Copyright 2012. This reprinted material is not the complete and official position of the NFPA on the referenced subject, which is represented only by the standard in its entirety. Please consult your NFPA 54/ICC Fuel Gas codebook and appliance's technical literature for more detailed sizing and installation instructions.

FIRST-STAGE TO SECOND STAGE

Length (feet)	Pressure Drop: 1.0 in w.c.			Spec. Gravity: 1.50		
	1/2 IPS SDR-9.3	3/4 IPS SDR-11	1 IPS SDR-11	1 1/4 IPS SDR-10	1 1/2 IPS SDR-11	2 IPS SDR-11
30	2143	4292	7744	13416	20260	36402
40	1835	3673	6628	11482	17340	31155
50	1626	3256	5874	10176	15368	27612
60	1473	2950	5322	9220	13924	25019
70	1355	2714	4896	8483	12810	23017
80	1261	2525	4555	7891	11918	21413
90	1183	2369	4274	7404	11182	20091
100	1117	2238	4037	6994	10562	18978
125	990	1983	3578	6199	9361	16820
150	897	1797	3242	5616	8482	15240
175	826	1653	2983	5167	7803	14020
200	778	1539	2775	4807	7259	13043
250	681	1363	2459	4260	6434	11560
300	617	1235	2228	3860	5830	10474
350	567	1136	2050	3551	5363	9636
400	528	1057	1907	3304	4989	8965
450	495	992	1789	3100	4681	8411
500	468	937	1690	2928	4422	7945

PROPANE

* Capacities listed are based on a pressure of 10 psig first stage setting and 1 psi pressure drop.

* Values listed are in cubic feet/meter (cfm). To calculate BTU, multiply by 1000.

** Source: NFPA 58-2012 Table 15.1 (s)

*Reproduced with permission from NFPA 54, *National Fuel Gas Code*, Copyright 2012. This reprinted material is not the complete and official position of the NFPA on the referenced subject, which is represented only by the standard in its entirety. Please consult your NFPA 54/ICC Fuel Gas codebook and appliance's technical literature for more detailed sizing and installation instructions.



YELLOW TRACER WIRE

W-R#	Description
------	-------------

- 1842500** 500' Yellow Tracer Wire-14g
- 1842502** 500' Yellow Tracer Wire-18g

- Use tracer wire in the trench along yellow polypipe for an effective, code-compliant installation.



YELLOW BURIAL TAPE

W-R#	Description
------	-------------

- 2426050** 3" x 1000' Non-Detectable
- 2426052** 3" x 1000' *Detectable*

- Burial Tape is used 6 -8" above the pipe and tracer wire in the trench.



UNIVERSAL BRACKET FOR ANODELESS RISERS

W-R#	Description
------	-------------

- 2867050** 3/4" to 2" Riser Bracket

- Fits 3/4" - 2" anodeless risers
- Adjustable from 6" - 10" from wall

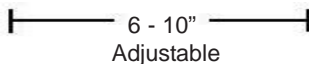

COMPRESSION SERVICE FITTINGS

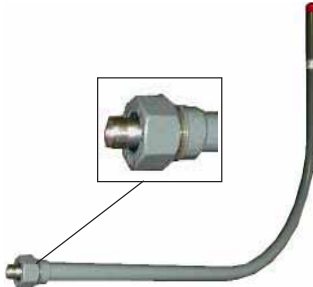

STEEL COMPRESSION RISERS

Know the Code:
Coated Steel Products
May Require Additional
Cathodic Protection!

W-R	Description	SDR
-----	-------------	-----

2930002	3/4" IPS	SDR-11
2930004	1" IPS	SDR-11
2930006	1 1/4" IPS	SDR-10
2930008	1 1/2" IPS	SDR-11
2930010	2" IPS	SDR-11

- Powder coat finish
- Steel compression end
- Requires anode bag (not included)



STEEL COMPRESSION COUPLINGS

Know the Code:
Coated Steel Products
May Require Additional
Cathodic Protection!

W-R	Description	SDR
-----	-------------	-----

2931002	3/4" IPS	SDR-11
2931004	1" IPS	SDR-11
2931006	1 1/4" IPS	SDR-10
2931008	1 1/2" IPS	SDR-11
2931010	2" IPS	SDR-11

- Powder coat finish
- Steel compression end
- Requires anode bag (not included)



STEEL COMPRESSION MALE ADAPTERS

Know the Code:
Coated Steel Products
May Require Additional
Cathodic Protection!

W-R	Description	SDR
-----	-------------	-----

2935002	3/4" IPS	SDR-11
2935004	1" IPS	SDR-11
2935006	1 1/4" IPS	SDR-10
2935008	1 1/2" IPS	SDR-11
2935010	2" IPS	SDR-11

- Powder coat finish
- Steel compression end
- Requires anode bag (not included)



EXTRA-LONG MALE ADAPTERS

W-R	Description	SDR
-----	-------------	-----

2935102	3/4" IPS	SDR-11
2935104	1" IPS	SDR-11



STEEL COMPRESSION TEES

Know the Code:
Coated Steel Products
May Require Additional
Cathodic Protection!

W-R	Description	SDR
-----	-------------	-----

2933002	3/4" IPS	SDR-11
2933004	1" IPS	SDR-11
2933006	1 1/4" IPS	SDR-10

- Powder coat finish
- Steel compression end
- Requires anode bag (not included)



**INNERLYNX®
MECHANICAL SEALS**

Innerlynx® mechanical seals are made of EPDM rubber, and are suitable for aboveground and direct burial applications. **Innerlynx®** form a strong hydrostatic seal, and electrically isolate the carrier pipe from the wall sleeve. Made in USA.

**INNERLYNX® MECHANICAL SEALS
FOR WALL PENETRATIONS**

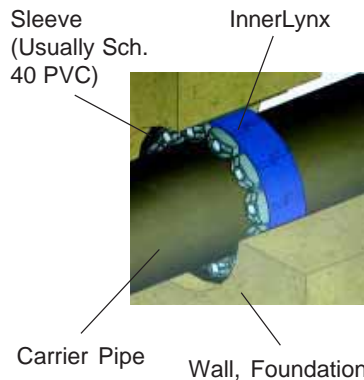

- Specifications
- Type: Standard "Model C"
 - EPDM Gaskets
 - Temp. Range: 40-250° F
 - Carbon Steel Bolts & Nuts

W-R#	Description	SKU
A000860	IL-200	priced per link
A000862	IL-275	priced per link
A000864	IL-300	priced per link
A000866	IL-315	priced per link
A000870	IL-340	priced per link
A000874	IL-400	priced per link

- Innerlynx® mechanical seals are ordered in belts of 10.



**ROYSTON LABS
"THICK 'N QUICK"®
MASTIC**

W-R#	Description	Min
1004002	"Thick 'N Quick"	1 gallon

- For protection of steel pipe in direct burial applications.



**ROYSTON LABS
TAPECOAT® H-35**



W-R#	Description	Min
1004004	2" x 75'	1 roll

- 35 mil cold applied, UV resistant tape coating with an 8 mil multipolymer alloy film (MAF) backing and 27 mils of adhesive with integrated primer, for ambient temperature below and above grade application.



**UPC-APPROVED
PIPE WRAP TAPE**



W-R#	Description	Thickness	Min
1003002	2" X 100'	10 mil	1
1003004	2" X 100'	20 mil	1

- For protection of steel pipe in direct burial applications. Self-adhesive. UPC approved.



GAS APPLIANCE CONNECTORS



for: Generators



for: Gas Grills



3/8" QUICK-CONNECT HOSES

W-R#	Size
2862002	10 foot
2862004	12 foot

- 3/8" Female Flare x 3/8" Male Quick-Connect



3/4" GENERATOR HOSES

Size	Grey UV Coated	Black Rubber
12"	2866002	2866003
24"	2866006	2866007
36"	2866008	2866009

- 3/4" Male (Swivel) x 3/4" Male (Swivel)



QUICK-CONNECT SHUTOFF VALVES

W-R#	Type	Inlet	Quick Connect
2861002	Straight	3/8" FIP	3/8" F
2861004	Angle	1/2" FIP	3/8" F

Female Quick Connect

QUICK-CONNECT FITTINGS

W-R#	FIP Size	Quick-Connection
2864002	3/8" FIP	3/8" QC Female
2864020	1/2" FIP	1/2" QC Female
2864022	3/4" FIP	3/4" QC Female
2864024	1" FIP	1" QC Female

FEMALE
NEW!



Male Quick Connect

W-R#	FIP Size	Quick-Connection
2864004	3/8" FIP	3/8" QC Male
2864040	1/2" FIP	1/2" QC Male
2864042	3/4" FIP	3/4" QC Male
2864044	1" FIP	1" QC Male

MALE
NEW!



2864006

ADAPTERS

W-R#	FIP Size	Quick-Connection
2864006	1/2" M Flare	3/8" QC Male
2864008	1/2" FIP	3/8" QC Male



GAS OUTLET CONVENIENCE BOXES

W-R#	Color
2863002	White

- 1/2" FIP Angle x 3/8" Female Quick-Connect

GAUGES & INSTRUMENTATION

W-R STANDARD PRESSURE GAUGES



- 1/4" NPT brass lower connection
- Black steel case
- For water, oil, & gas
- Not for use on oxygen

W-R#	Size	PSI	Increments
1712002	2"	15 psi	1/2 lb.
1712004	2"	30 psi	1/2 lb.
1712006	2"	60 psi	1 lb.
1712008	2"	100 psi	2 lb.
1712010	2"	160 psi	5 lb.
1712012	2"	200 psi	4 lb.
1712014	2"	300 psi	5 lb.
1712016	2"	400 psi	8 lb.

1712502	2 1/2"	15 psi	1/2 lb.
1712504	2 1/2"	30 psi	1/2 lb.
1712506	2 1/2"	60 psi	1 lb.
1712508	2 1/2"	100 psi	2 lb.
1712510	2 1/2"	160 psi	5 lb.
1712512	2 1/2"	200 psi	4 lb.
1712514	2 1/2"	300 psi	5 lb.
1712516	2 1/2"	400 psi	8 lb.

1712802	3 1/2"	15 psi	1/2 lb.
1712804	3 1/2"	30 psi	1/2 lb.
1712806	3 1/2"	60 psi	1 lb.
1712808	3 1/2"	100 psi	2 lb.
1712810	3 1/2"	160 psi	5 lb.
1712812	3 1/2"	200 psi	4 lb.
1712814	3 1/2"	300 psi	5 lb.
1712816	3 1/2"	400 psi	8 lb.
1712818	3 1/2"	600 psi	10 lb.

1713002	4 1/2"	15 psi	1/2 lb.
1713004	4 1/2"	30 psi	1/2 lb.
1713006	4 1/2"	60 psi	1 lb.
1713008	4 1/2"	100 psi	2 lb.
1713010	4 1/2"	160 psi	5 lb.
1713012	4 1/2"	200 psi	4 lb.
1713014	4 1/2"	300 psi	5 lb.
1713016	4 1/2"	400 psi	8 lb.
1713018	4 1/2"	600 psi	10 lb.



W-R STANDARD PRESSURE GAUGES WITH 1/8" LOWER NPT

W-R#	Size	PSI	Increments
1717002	2 1/2"	30 psi	1/2 lb.
1717004	2 1/2"	100 psi	2 lb.

**GAUGES &
INSTRUMENTATION**



VACUUM GAUGE

W-R#	Description	PSI
1720002	2" Vacuum	-30 psi
1720004	2½" Vacuum	-30 psi
1720006	3½" Vacuum	-30 psi

- ¼" NPT Lower Connection



COMPOUND GAUGE

W-R#	Description	PSI
1719002	2" Compound	30-0-30
1719004	2½" Compound	30-0-30
1719006	3½" Compound	30-0-30

- ¼" NPT Bottom Outlet



**1/4" NPT
BACK OUTLET
PRESSURE GAUGE**

W-R#	Description	PSI
1714002	2½" C.B.O.	30 psi
1714004	2½" C.B.O.	100 psi
1714202	3½" C.B.O.	30 psi



**WATER TEST GAUGE
WITH 3/4" FHT**

W-R#	Description	PSI
1721002	2½"	200 psi

- ¾" Female Garden Hose thread
- 2 psi increments



**2 1/2" SILICON
LIQUID-FILLED GAUGE**

Stainless Steel Case
1/4" NPT Lower Connection

W-R#	Description	PSI
1712601	2 1/2"	30 psi
1712602	2 1/2"	60 psi
1712604	2 1/2"	100 psi
1712606	2 1/2"	200 psi
1712608	2 1/2"	300 psi

1720000 - 30 psi **Vacuum**

GAUGES & INSTRUMENTATION



**5 PSI & 10 PSI
DIAPHRAGM GAUGE
FOR GAS TEST**



W-R#	Description	PSI
1715500	2 1/2" Diaphragm	5 psi
1715502	2 1/2" Diaphragm	10 psi

- 1/4" NPT
- 1/10 Increments
- Accuracy: 1.5% of full scale range

Please note: This gauge is extremely sensitive. Overpressurizing this gauge will cause the measuring element to fail and render the gauge inoperable. Wal-Rich will not accept returns of gauges that are improperly used.



**GAS TEST MANIFOLD
& AIR VALVE**

W-R#	Description	Min	Box
A000334	Manifold	1	-
1838102	1/8" Air Valve	12	12
1838100	Manifold & Valve	1	-



**STANDARD GAS TEST
ASSEMBLY**

W-R#	Description	Increments
1838103	2" 15# gauge	1/2 lb.
1838104	2" 30# gauge	1/2 lb.
1838106	2" 60# gauge	1 lb.
1838108	2" 100# gauge	2 lb.

- 3/4" FIP brass-plated manifold
- Individually bagged
- 1/8" air valve included



**5 PSI & 10 PSI
LOW-PRESSURE GAS
TEST ASSEMBLY**

W-R#	Description	Min	Box
1838110	5 psi Low Pressure Test Kit		
1838112	10 psi Low Pressure Test Kit		

- Furnished as shown with hexagonal test block, 1/8" tank valve, & 1/8" Male X Female Air Cock.
- Uses 2 1/2" 1/4" NPT Diaphragm Gauge
- **Increments: 1/10 psi**
- Accuracy: 1.5% of full-scale range

Please note: This gauge is extremely sensitive. Overpressurizing this gauge will cause the measuring element to fail and render the gauge inoperable. Wal-Rich will not accept returns of gauges that are improperly used.

The key to the W-R Low Pressure Gas Test Kit is the diaphragm actuated gauge. Standard Pressure gauges are not capable of measuring minute variations because they use a bourdon tube. This type of measuring element, which is effective for higher pressures, will not detect the minute variations in pressure when a leak exists.

Be advised AIR COMPRESSORS should not be used to get a reading, and that most BICYCLE and HAND PUMPS can deliver upwards of 60 psi. per thrust.

GAUGES & INSTRUMENTATION

**5 PSI & 10 PSI
GAS TEST KIT WITH RUBBER BULB**



W-R#	Description
GT-5	5 PSI Kit
GT-10	10 PSI Kit
1838200	Bulb & Tubing Only

- Furnished as shown with hexagonal test block, 1/8" tank valve, & 1/8" Male X Female Air Cock.

- **Increments: 1/10 psi**
- Accuracy: 1.5% of full-scale range

Please note: This gauge is extremely sensitive. Overpressurizing this gauge will cause the measuring element to fail and render the gauge inoperable. Wal-Rich will not accept returns of gauges that are improperly used.

**5 PSI & 10 PSI
GAS TEST KIT WITH DOUBLE-TAPPED
MANIFOLD**

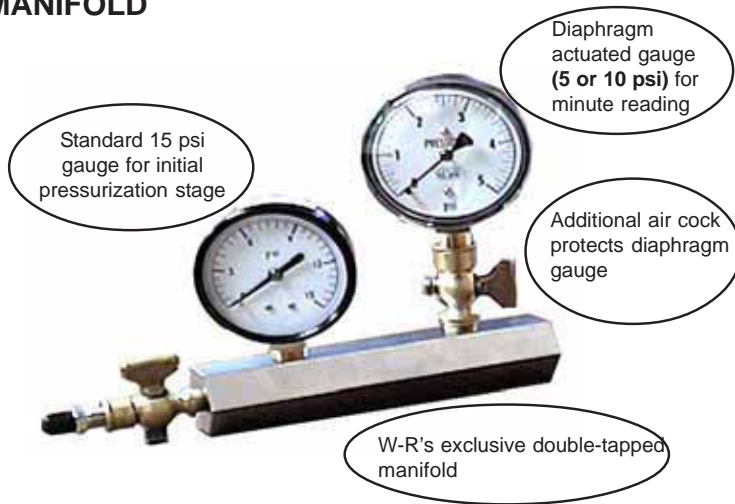

W-R#	Description
BDGT-5	5 PSI "NYC" Kit
BDGT-10	10 PSI "NYC" Kit

Contains:
- Steel Double-tapped hexagonal test block
- 1/4" Male x Female Air Cock
- 1/8" Male x Female Air Cock
- 2 1/2" 15 psi Standard Pressure Gauge
- **Uses 2 1/2" 1/4" NPT 5# or 10# Diaphragm Gauge**
(Increments: 1/10 psi for minute readings)
- Accuracy: 1.5% of full-scale range

Please note: This gauge is extremely sensitive. Overpressurizing this gauge will cause the measuring element to fail and render the gauge inoperable. Wal-Rich will not accept returns of gauges that are improperly used.



PRESSURE SNUBBERS

W-R#	Description	Box
1726004	Brass Snubber	6

- For regulation of sudden pressure changes



**PIGTAIL STEAM
SYPHONS**

1/4"MNPT x 1/4"MNPT

W-R#	Description	Box
1706002	Straight (180°) - Steel	6
1706006	Straight (180°) - Brass	6
1706004	Angle (90°) - Steel	6
1706008	Angle (90°) - Brass	6

GAUGES & INSTRUMENTATION

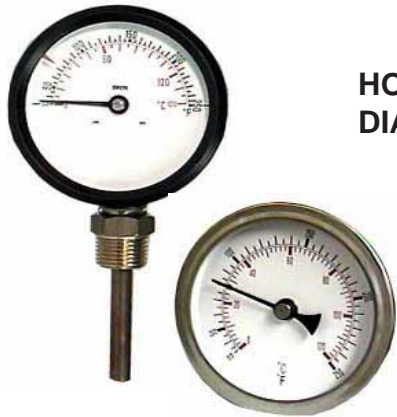

HOT WATER DIAL THERMOMETER

W-R# Description

- 1722011** Angle (Back Outlet)
- 1722013** Straight (Bottom Outlet)

SIZE: 3½" Face, ½" NPT
CASE: Steel
WINDOW: Glass
SOCKET: Brass
RANGE: 30° TO 248°F
TEMPERATURE ELEMENT: Helical bi-metallic element enclosed in a brass bulb



"SNAP-WELL" THERMOMETERS

W-R# Description

- 1722014** 2" w/Brass Probe
- 1722015** 2" w/Aluminum Probe
- 1722016** 2" w/¾" Sweat Well

1722060 3 1/4" w/Brass Probe

- ½" NPT connection
- Graduation from 40° to 240°
- Snaps out of its brass well for easy replacement or calibration.



W-R BRASS WELL THERMOMETER

W-R# Description

- 1722000** Straight (Bottom Mount)
- 1722001** Angle (Back Mount)

- 6" Non-corrosive Valox® case
- ½" NPT connection
- Graduation from 40° to 280°

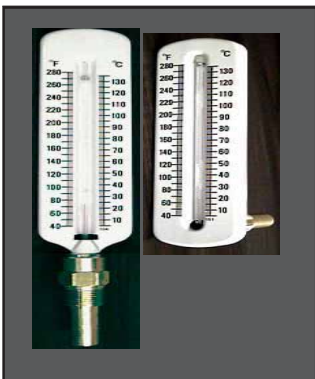

ECONOMY HOT WATER THERMOMETERS

W-R# Description

- 1722002** Steel Well - Straight
- 1722004** Steel Well - Angle

- 1722006** Brass Well - Straight
- 1722008** Brass Well - Brass

- 6" steel case case with white lacquer finish
- ½" NPT connection
- Graduation from 40° to 280°

**GAUGES &
INSTRUMENTATION**



**7" ADJUSTABLE ANGLE
THERMOMETER**

W-R#	Description
1722020	7" Hot Water Thermometer
	- Adjustable radius of 180 Degrees
	- 1/2" Brass Connection
	- 40-240° F



**POCKET
THERMOMETERS**

W-R#	Description
1802214	0 - 220°F



**DIGITAL POCKET
THERMOMETER**

W-R#	Description	Min.	Box
1802216	-40° - 300°F	1	6
	- Battery included		



W-R TRIDICATORS



W-R#	Face	Shank	NPT	Outlet
1711016	2 1/2"	(1")	1/4"	Angle
1711018	2 1/2"	(2 1/4")	1/4"	Angle
	- 60° - 320°F			
	- 0 - 75 psi			
W-R#	Face	NPT	Outlet	
1711015	3 1/4"	1/4"	Straight	
1711011	3 1/4"	1/2"	Angle	
1711009	3 1/4"	1/2"	Straight	
	- 70° - 250°F			
	- 0 - 55 psi			



**MARSHALLTOWN®
TRIDICATOR
SQUARE FACE**



W-R#	Face	NPT	Outlet
1711010	3 1/2"	1/2"	Angle
1711012	3 1/2"	1/2"	Straight
	- Made in USA		
	- 60°-260°F		
	- 0 - 60 psi		



**THERMOWELLS FOR
AQUASTATS**

W-R#	Diameter	Length
1751032	1/2"	3"
1751034	3/4"	3"
1751038	3/4"	6"
	- Brass immersion well	
	- Fits Honeywell, White Rodgers	

STEAM SPECIALTIES



**ANGLE
STEAM RADIATOR
VALVES**

W-R#	Description	Min	Box
0408102	1/2"	1	10
0408104	3/4"	1	6
0408002	1"	1	4
0408004	1 1/4"	1	2
0408006	1 1/2"	1	2

- Brass
- Imported



**STRAIGHT
STEAM RADIATOR
GATE VALVES**

W-R#	Description	Min	Box
0409002	1"	1	4
0409004	1 1/4"	1	2

- Brass
- Imported



**THREE-LUG
RADIATOR HANDLE**

W-R#	Description	Min	Box
1705002	3 Lug	1	12

- Furnished with three lugs to fit practically all size radiator valves.
- Individually bagged



**THREE-SCREW
RADIATOR HANDLE**

W-R#	Description	Min	Box
1705004	3 Screw	1	12

- Three set screws hold spud securely to stem.
- Individually bagged



**4-IN-1
RADIATOR HANDLE**

W-R#	Description	Min	Box
1705006	Fitall Plate	1	12

- One plate fits four sizes of stems.
- Individually bagged

STEAM SPECIALTIES



**AUTOMATIC
HOT WATER - AIR VENT**

W-R#	Description	Min	Box
1700200	1/8"	1	12

- 30 psi
- 225° Fahrenheit



**COMBINATION
COIN / KEY AIR VALVE**

W-R#	Description	Min	Box
1701202	1/8"	25	25

• Nickel Plated



STUBBY AIR VALVE

W-R#	Description	Min	Box
1701204	1/8"	24	24

• Nickel Plated



AIR VALVE KEYS

W-R#	Description	Min	Box
1701208		25	25

• Nickel Plated



**CHROME-PLATED
CROWN "QUICK-VENT"**

W-R#	Description	Fig#	Orifice	Box
1700302	1/8" Angle	4AV	1.50mm	12
1700304	1/8" Angle	5AV	2.45mm	12
1700306	1/8" Angle	6AV	3.15mm	12
1700308	1/8" Angle	CAV	3.66mm	12
1700310	1/8" Angle	DAV	5.35mm	12

Features:
- Chrome-plated finish
- Brass valve stem assembly
- Imported



**CHROME-PLATED
RADIATOR AIR VENTS**

W-R#	Description	Box
1700102	1/8" Angle	12
1700108	1/8" Angle- Adjustable	12
1700104	1/8" Straight	12
1700106	1/4" Straight	12

STEAM SPECIALTIES



3 IN 1 RADIATOR REPAIR TOOL

W-R#	Description	Min	Box
1822002		1	12

- Extracts broken air valves, retaps radiator, rethreads air valves.



TAPPED CAPS

W-R#	Description	Min	Box
1743002	1 1/4" x 1/8"	1	12



W-R WATER GAUGE SET

W-R#	Description	Min	Box
1723002	1/2"	1	12

- 125 psi
- 5/8" x 12" standard gauge glass



NUT FOR WATER GAUGE SET

W-R#	Description	Min	Box
1723200		12	12

- Brass



FRICITION RING FOR GAUGE GLASS

W-R#	Description	Min	Box
2712006	13/16" x 11/16" x 3/8"	25	100

- Brass



GAUGE GLASS WASHERS

W-R#	Description	Min	Box
2715004	5/8" Standard	50	50
2715002	5/8" Redline	1	-

- EPDM gaskets



GAUGE GLASS



"RED-LINE" HIGH PRESSURE GAUGE GLASS

W-R#	Description	Min
1724002	5/8" x 8"	1 dz.
1724004	5/8" x 10"	1 dz.
1724006	5/8" x 12"	1 dz.
1724008	5/8" x 14"	1 dz.
1724012	5/8" x 18"	1 dz.
1724018	5/8" x 24"	1 dz.
1724022	5/8" x 36"	1 dz.

1724000	5/8" x 12" Redline	1pc.
---------	--------------------	------

STEAM SPECIALTIES

	GAUGE GLASS CUTTERS	W-R# 1801000	Description Tong-Type	Min 1	Box 12
	GAUGE GLASS CUTTER WHEEL AND PIN	W-R# 1801004	Description Replacement - Wheel & Pin		Box 6
	QUARTER-TURN GAUGE GLASS CUTTERS	W-R# 1801006	Description Cutter	Min 1	Box 12
		- Domestic			
	CHAIN-TYPE GAUGE GLASS CUTTERS	W-R# 1801008	Description Cutter	Min 1	Box 12
		- Domestic			
	E-Z FIX BOILER PLUGS	W-R# 1709002	Description 1 3/4" (12/card)	Min 1 cd.	Box 20 cds.
		W-R# 1709004	Description 1 3/4" (Bulk)	Min 12	Box 144
- Toggle-style plug fits into hole in boiler jacket, then creates seal when tightened.					
	CAST IRON BOILER TUBE REPAIR PLUGS	W-R# 1708002	Description 1 1/2"	Min 1	Box 25
		W-R# 1708004	Description 2"	Min 1	Box 25
		W-R# 1708006	Description 2 1/2"	Min 1	Box 18
		W-R# 1708008	Description 3"	Min 1	Box 18
	DIRT POCKET CAPS FOR LOW-WATER CUTOFFS	W-R# 1751012	Description 3/4" Cap	Min 1	Box 12
		- Cast iron - With gasket & mounting bolts			
		W-R# 1751011	Description Gasket Only		Box 12

STEAM TRAPS & SPECIALTIES



MEPCO™ ANGLE STEAM TRAPS

W-R#	Size	MEPCO#	Style
2750002	1/2"	1E-AP	Angle
2750004	3/4"	2E-AP	Angle



MEPCO™ STRAIGHT STEAM TRAPS

W-R#	Size	MEPCO#	Style
2755002	1/2"	1E-SW	Straight
2755004	3/4"	2E-SW	Straight



MEPCO™ THERMOSTATIC DISCS

W-R#	Size	MEPCO#	Style
2830102	1/2"	C5940	1E
2830104	3/4"	C5941	2E

Low pressure radiator trap--good for 25" vacuum to 25 psi



BARNES & JONES™ ANGLE STEAM TRAPS

W-R#	Size	B/J#	Style
2751002	1/2"	122-A	Angle
2751004	3/4"	134-A	Angle



BARNES & JONES™ STRAIGHT STEAM TRAPS

W-R#	Size	B/J#	Style
2756002	1/2"	122-S	Straight
2756004	3/4"	134-S	Straight



**APOLLO®
HEATING SPECIALTIES**



**15 PSI RELIEF VALVE
FOR STEAM BOILERS
-STANDARD-**

W-R#	Size	Conbraco#	PSI	LBS/HR
1727001	¾"	13-511-B15	15	407
1727000	¾"	13-211-B15	15	475
1727002	1"	13-202-B15	15	643
1727004	1¼"	13-213-B15	15	1200
1727006	1½"	13-214-B15	15	1900
1727008	2"	12-205-08	15	2500
1727010	2½"	12-206-08	15	3529
1727012	3"	12-208-08	15	4100

"Apollo" Valves

**15 PSI RELIEF VALVE
FOR STEAM BOILERS
-HI-CAPACITY-**

W-R#	Size	Conbraco#	PSI	LBS/HR
1727606	2"	14-205-08	15	3150
1727608	2½"	14-206-08	15	4676
1727610	3"	14-207-08	15	6843



**RELIEF VALVE FOR
HOT WATER BOILERS**

W-R#	Size	Conbraco#	PSI
1725008	¾" F x F	10-408-05	30
1725006	¾" M x F	10-407-05	30
1725009	¾" M x F	10-407-09	45

"Apollo" Valves



**RELIEF VALVE FOR
WATER HEATERS**

W-R#	Size	Conbraco#	PSI
1725504	¾" M x F	18C-402-30	150

- 3" Element
- 105,000 BTU

"Apollo" Valves



**RELIEF VALVE FOR
TANKLESS WATER
HEATERS**

W-R#	Size	Conbraco#	PSI
1725602	¾" M x F	17-402-04	150

- Pressure only
- 200,000 BTU

"Apollo" Valves

**APOLLO®
HEATING SPECIALTIES**



**DOUBLE FEMALE
AIRCOCK**

W-R#	Size	Conbraco#	Min	Box
1702002	1/8"	41-370-01	1	25
1702004	1/4"	41-380-01	1	25



MALE PETCOCK

W-R#	Size	Conbraco#	Min	Box
1703002	1/8"	41-060-01	1	25
1703004	1/4"	41-070-01	1	25



**MALE X FEMALE
AIRCOCK**

W-R#	Size	Conbraco#	Min	Box
1704002	1/8"	41-400-01	1	25
1704004	1/4"	41-410-01	1	25
1704005	3/8"	41-420-01	1	25

"Apollo" Valves



**STANDARD
ROUGH BRONZE
WATER GAUGE SETS**

W-R#	Size	Conbraco#
1723006	1/2"	20-104-00

- Service Rating: 125 psi @ 300°F, -300 psi @ 100°F
- Furnished with 5/8" x 10 standard glass
- Aluminum Wheel
- Features 1/4" Needle drain valve in lower arm.

"Apollo" Valves



**COMPRESSION GAUGE
COCK**

(TRICOCK)

W-R#	Size	Conbraco#
1704204	1/2"	26-104-01

- 125 psi
- Aluminum Wheel

"Apollo" Valves



**PRESSURE
RELIEF VALVE**

W-R#	Size	Conbraco#	PSI
1725002	1/2" M x F	16-202-04	125

- Relieves excess pressure in water supply lines.

"Apollo" Valves

**APOLLO®
HEATING SPECIALTIES**



"Apollo" Valves

**ANTI-SIPHON
VACUUM BREAKERS
- LEAD FREE -**



W-R#	Size	Finish	Conbraco#
4413002	1/2"	RB	38-LF-203-01
4413004	3/4"	RB	38-LF-204-01
4413006	1"	RB	38-LF-105-01

4413001	3/8"	Satin CP	38-LF-102-03
4413003	1/2"	Satin CP	38-LF-203-03
4413005	3/4"	Satin CP	38-LF-204-03



"Apollo" Valves

**MAIN BURNER
CONTROL VALVES**

W-R#	Size	Conbraco#
0413500	1/2"	50-203-02
0413502	3/4"	50-303-02
0413504	1"	50-403-02
0413506	1 1/4"	50-503-02
0413508	1 1/2"	50-603-02
0413510	2"	50-703-02

- Temperature range: 32°F-125°F
- Meets ANS Z 21.15 requirements of 1/2" psi
- Furnished with 1/8" pilot tapping



"Apollo" Valves

**BRONZE BALL-CONE
CHECK VALVES**

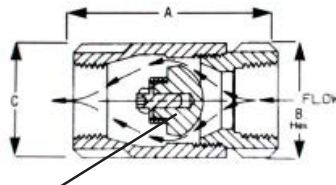

Patented design offers exceptional resistance to chemicals & corrosion.

W-R#	Size	Conbraco#
0412902	1/4"	61-101-01
0412904	3/8"	61-102-01
0412906	1/2"	61-103-01
0412908	3/4"	61-104-01
0412910	1"	61-105-01
0412912	1 1/4"	61-106-01
0412914	1 1/2"	61-107-01
0412916	2"	61-108-01

- For Non-Potable use only
- Open pressure: 1/2 psi
- 125 psig steam rating
- Not recommended for use on reciprocating pumps or other applications that induce repetitious vibrations.

**APOLLO®
HEATING SPECIALTIES**

**“APOLLO” 70-SERIES
BALL VALVES**



“Apollo” Valves



Made in USA

W-R#	IPS Size	Conbraco#
0412002	1/2” IPS	70-103-01
0412004	3/4” IPS	70-104-01
0412006	1” IPS	70-105-01
0412008	1 1/4” IPS	70-106-01
0412010	1 1/2” IPS	70-107-01
0412012	2” IPS	70-108-01

W-R#	COPPER Size	Conbraco#
0411500	1/2” CTS	70-203-01
0411503	3/4” CTS	70-204-01
0411504	1” CTS	70-205-01

**“APOLLO” 70-SERIES
BALL VALVES
- LEAD FREE-**



“Apollo” Valves



Made in USA

W-R#	IPS Size	Conbraco#
4412002	1/2” IPS	70-103-01
4412004	3/4” IPS	70-104-01
4412006	1” IPS	70-105-01
4412008	1 1/4” IPS	70-106-01
4412010	1 1/2” IPS	70-107-01
4412012	2” IPS	70-108-01

W-R#	COPPER Size	Conbraco#
4411500	1/2” CTS	70-203-01
4411503	3/4” CTS	70-204-01
4411504	1” CTS	70-205-01



BOILER & OIL BURNER SPECIALTIES



HONEYWELL® PILOT BURNER ASSEMBLY

W-R#	Honeywell#	Type	Min
1739002	Q314A-4586	Front	1
1739004	Q314A-6094	Left	1
1739006	Q314A-6102	Right	1

- for Natural Gas & LP (orifice included)



HONEYWELL® PILOT BURNER ASSEMBLY

W-R#	Honeywell#	Type	Min
1739010	Q327A-1626	Batwing	1

- for Natural Gas & LP (orifice included)

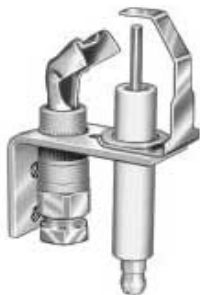

HONEYWELL® IGNITER-BURNER

W-R#	Honeywell#	Type	Min
1739202	Q345A-1305	FRONT	1
1739204	Q345A-1313	LEFT	1
1739206	Q345A-1321	RIGHT	1

- for Natural Gas



HONEYWELL® THERMOPILE GENERATORS

W-R#	Honeywell#	Type	Min
1739302	Q313A-1139	750 mV	1

- for Natural Gas



ALUMINUM TUBING

W-R#	Description	Min	Box
0817002	1/8" X 50'1	1	
0817004	1/4" X 50'1	1	

-Soft aluminum tubing for pilot lines, etc.
- 50 foot coil

BOILER & OIL BURNER SPECIALTIES



PILOT TUBING KITS



W-R#	Description	Min	Box
0817502	1/8" x 36"	1	12
0817506	1/4" x 36"	1	12
0817508	1/8 x 1/4" x 36"	1	12
0817504	1/4" x 60"	1	12

- Includes tubing & 2 brass pilot fittings



BRASS PILOT NUTS



W-R#	Description	Min	Box
2130002	1/8"	12	12
2130004	1/4"	12	12
2130006	1/4" X 1/8"	12	12



COPPER THERMOCOUPPLERS

W-R#	Description	Min	Box
1743200	18"	1	10
1743202	24"	1	10
1743204	30"	1	10
1743206	36"	1	10
1743208	48"	1	10



CSA GAS BALL VALVES



W-R#	Description	Min	Box
0400120	1/2"	12	12
0400122	3/4"	12	12



TERMINATION VENT WITH 304SS SCREEN



W-R#	Description	Min	Box
2202050	2"	1	10
2202052	3"	1	10
2202054	4"	1	10
2202056	6"	1	10
2202060	1"	1	10



Patent# D715,409

- Prevent pests, debris, & leaves from entering vent piping
- Push into hub for easy flush installation.
- Patented condensate channel prevents buildup & freezing

OIL TANK SPECIALTIES



OIL FILTERS



W-R#	Description	Min	Box
1751014	Filter to Fit IA-25A		6

- UL rated: 15 GPH at 50 psi
- Aluminum alloy top with 3/8" connections
- Contains element



OIL FILTER ELEMENTS



W-R#	Description	Fits Models	Box
1751016	Felt	IA-25A	12
1751022	Micro-Flo	IA-25A	12
1751018	Felt	2A-700A	12

- Includes Gaskets & Washers
- 12 per bag



FUEL PUMP STRAINERS



W-R#	Description	Min	Box
1751050	"A" Strainer	1	12
1751052	"J/H" Strainer	1	12



DUPLEX TANK BUSHING WITH FITTINGS

SOLID PATTERN

DUPLEX TANK BUSHING BODY ONLY

SOLID PATTERN



TANK FITTINGS

W-R#	Description	Box
1744002	2" x 3/8" with fittings	12
1744004	2" x 1/2" with fittings	12

- 2" extra heavy cast iron hexagon bushing with brass connectors. For slipping tubing through into oil tank. Furnished with 3/8" or 1/2" compression fittings.

1744006	2" x 3/8" Body only	12
1744008	2" x 1/2" Body only	12

2019502	3/8" x 3/8" fitting only	12
2019504	1/2" x 1/2" fitting only	12



MALLEABLE IRON RAILING FLANGES

BLACK	GALVANIZED	SIZE	Box
2511008	2523006	1/2"	25
2511010	2523008	3/4"	25
2511012	2523010	1"	25
2511014	2523012	1 1/4"	12
2511016	2523014	1 1/2"	12
2511018	2523016	2"	12

OIL TANK SPECIALTIES



**GALVANIZED STAMPED
STEEL SLIP-ON VENT
CAPS**

W-R#	Description	Min	Box
1741010	1 1/4"	1	12
1741012	2"	1	12

- Furnished with screw & screen



**GALVANIZED
MALLEABLE IRON
VENT CAPS**

W-R#	Description	Min	Box
1741002	1 1/4" I.P.S.	1	12
1741004	2" I.P.S.	1	12

- Furnished with screen



**OIL FILL CAP TO
FIT SCULLY**

W-R#	Description	Min	Box
1742020	2"	1	12



**OIL ADAPTER TO
FIT SCULLY
- FEMALE -**

W-R#	Description	Min	Box
1742030	2" Female	1	12



**ANGLE OIL ADAPTER
TO FIT SCULLY
- FEMALE -**

W-R#	Description	Min	Box
1742032	2" Fem Angle	1	12



**HEAVY PATTERN
OIL FILL BOX**

W-R#	Description	Min	Box
1742002	2" I.P.S.	1	12
1742004	3" I.P.S.	1	12

- Galvanized Iron with Brass Plug

1742003	2" Brass plug only		
1742005	3" Brass plug only		

CIRCULATOR PUMP SPECIALTIES



CIRCULATOR FLANGE GASKETS



W-R#	Description	Min	Box
1751002	Pair/bag	1 pr.	50 pr.
A000337	Bulk	100	100

- 1 1/2" ID center, 1/2" ID screw holes
- 1/8" Red SBR rubber
- Fits B&G, Taco, and most other circulators



CIRCULATOR FLANGE REPAIR KIT



W-R#	Description	Box
1751004	Gasket/Nuts/Bolt Kit	6

- Package contains:
 - (4) 7/16" 14T bolts
 - (4) 7/16" hex nuts
 - (2) A000337 gaskets
- Fits B&G, Taco, and most popular circulators.
- Bagged



CIRCULATOR FLANGE NUTS AND BOLTS



W-R#	Description	Box
1751006	Nut/Bolt Kit	6

- Package contains:
 - (4) 7/16" 14T bolts
 - (4) 7/16" hex nuts
 - (2) A000337 gaskets



MALLEABLE IRON CIRCULATOR FLANGE KITS

W-R#	Description	Min	Box
1752002	3/4"	1 pr.	12
1752004	1"	1 pr.	12
1752006	1 1/4"	1 pr.	12

- Kit includes 2 flanges, 4 bolts and nuts
- Green color to match Taco



CIRCULATOR COUPLING FOR B&G

W-R#	Description	Ref#	Box
1751010	Coupling (PZ4291)		12

- Cast Iron
- Shaft Diameters 1/2" x 1/2"



BRASS SPRING COUPLER FOR B & G

W-R#	Description	Min	Box
1751030	Fits B&G 100 booster pumps	1	12

- Shaft Diameters 1/2" x 1/2"

WATER HEATER ELEMENTS & THERMOSTATS



SCREW-IN WATER HEATER ELEMENTS



W-R#	Length	Volts	Watts
1940002	7"	120V	1500W
1940004	7 1/4"	240V	2000W
1940006	10 1/8"	240V	3000W
1940007	12"	240V	3500W
1940005	12"	240V	3800W
1940008	12 7/8"	240V	4500W
1940010	12 7/8"	240V	5500W



THERMOSTAT CONTROLS FOR WATER HEATER ELEMENTS



W-R#	Description	Min	Box
A. 1950002	Lower Control Capacity: 30A 120-250 VAC 25A 120-277 VAC 12.5A 120-480 VAC	1	12
B. 1950006	Upper Control with HLC Capacity: 40A 120-277 VAC 25A 120-480 VAC	1	12



UNIVERSAL ADAPTER KITS WATER HEATER ELEMENTS

W-R#	Description	Min	Box
1951002		1	12

- Contains thermostat bracket, 4-bolt gasket, round gasket, and threaded Universal adapter.



WATER HEATER DRAIN VALVES



W-R#	Description	Min
1945004	2" Brass	1
1946004	2" Plastic	1



HEAT TRAP NIPPLES



W-R#	Description	Min	Box
0226020	Per Pair	1	12



FLARED PEX DIP TUBE



W-R#	Description	Min	Box
1963002		12	12

WATER HEATER & ELECTRICAL ACCESSORIES

CORRUGATED STAINLESS STEEL WATER CONNECTORS



W-R#	Description	Length
1960002	3/4" FIP x 3/4" FIP	12"
1960006	3/4" FIP x 3/4" FIP	18"
1960008	3/4" FIP x 3/4" FIP	24"

- For Residential Water Heaters, Tankless Heaters, Boilers, & Softeners

Specifications

- T-304 Stainless Steel
- CP Brass Nuts
- EPDM Gaskets
- Temperature Range: 40 - 240° F
- Working Pressure: 300 psi
- Burst Pressure: 1850 psi



GROUNDING CLAMPS FOR WATER PIPE

W-R#	Description	Min	Box
2201002	1/2"-1" Clamp	1	12

- Bronze alloy



GROUNDING KIT FOR WATER HEATERS

W-R#	Description
2201050	Kit w/ 12" 6g wire
2201052	Kit w/ 24" 6g wire



1876080 1876082



1876070 1876072

TOGGLE PLATES FOR OIL AND GAS

W-R#	Description	Min	Box
1876080	1 7/8" For Gas	1	12
1876082	1 7/8" For Oil	1	12
1876070	4" For Gas	1	12
1876072	4" For Oil	1	12



1876004 1876022

ELECTRICAL BOXES

W-R#	Description	Min	Box
1876022	1 7/8"	1	12
1876004	4"	1	12



ELECTRICAL ACCESSORIES



WIRE NUTS



W-R#	Description	Min	Box
2401202	Orange	100	100
2401204	Yellow	100	100



NYLON CABLE TIES



- Natural color
 - Tensile Strength: Standard: 50 psi
 Heavy Duty: 175 psi

W-R#	Description	Min
1847004	4" Standard	100
1847007	7" Standard	100
1847011	11" Standard	100
1847017	17" Heavy Duty	100
1847024	24" Heavy Duty	100
1847036	36" Heavy Duty	100



STRANDED COPPER WIRE - 500 FT



W-R#	Color	Gauge	Type
1842702	Red	18g	TFFN
1842704	Black	18g	TFFN
1842706	White	18g	TFFN
1842708	Green	18g	TFFN



W-R#	Color	Gauge	Type
1842802	Red	14g	THHN
1842804	Black	14g	THHN
1842806	White	14g	THHN
1842808	Green	14g	THHN



THERMOSTAT WIRE

W-R#	Feet	Ends	Gauge
1842002	500'	2	18
1842003	500'	3	18
1842004	250'	4	18



PLASTIC THERMOSTAT GUARDS

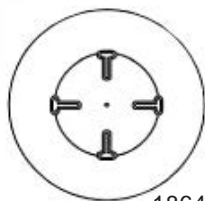

1864020



W-R#	Description	H	W	D
1864001	Small	3 7/8"	3 1/2"	2 1/2"
1864002	Medium	5 1/4"	4 3/8"	3"
1864004	Large	8 1/4"	5 3/8"	3 1/2"

- Medium & Large plastic guards are furnished with Ring base & Solid base.

1864020 Backup Ring Only for Round Thermostats (fits T-87)



FIRE SPRINKLER SPECIALTIES

Globe Fire Sprinkler Heads are made in the USA and are listed by Underwriters Laboratories for wet sprinkler systems conforming to NFPA 13, 13D, & 13R



GLOBE® PENDENT HEADS - 155°

W-R#	Finish	Bulb	Globe#
2870002	CP	5 mm	GL5651
2870004	RB	5 mm	GL5651



GLOBE® UPRIGHT HEADS - 155°

W-R#	Finish	Bulb	Globe#
2870006	CP	5 mm	GL5661
2870008	RB	5 mm	GL5661



GLOBE® CONCEALED HEADS - 155°

W-R#	Finish	Bulb	Globe#
2870012	White	2.5 mm	GL4906



Quick Response



GLOBE® SIDEWALL HEADS - 155°

W-R#	Finish	Bulb	Globe#
2870010	Chrome	5 mm	GL5670



GLOBE® 2-PART ESCUTCHEONS

W-R#	Finish	Globe#
2872002	Chrome	325422
2872004	White	325426W



C.P. SHALLOW ESCUTCHEONS

W-R#	Size	Min	Box
1610000	7/8" ID	25	25



GLOBE® FIRE SPRINKLER WRENCHES

W-R#	Description	Globe#
2871002	Standard	325390

MALLEABLE PIPE HANGERS



JR. TOP BEAM CLAMPS

W-R#	Size	Finish	Min.	Box
2410000	3/8"	Black	1	100
2410002	1/2"	Black	1	50
2410006	3/8"	Galv.	1	100

"WIDE-JAW" TOP BEAM CLAMPS

W-R#	Size	Finish	Min.	Box
2410010	3/8"	Black	1	100
2410014	3/8"	Galv.	1	100



SIDE BEAM CONNECTORS

W-R#	Size	Finish	Min.	Box
2410502	3/8"	Black	1	100
2410506	3/8"	Galv.	1	100



THREE-HOLE CEILING PLATES

W-R#	Size	Finish	Min.	Box
2412002	3/8"	Black	1	100
2412004	1/2"	Black	1	50
2412008	3/8"	Galv.	1	100
2412010	1/2"	Galv.	1	50
2412012	3/8"	Copper	1	100



KNEE BRACKETS



W-R#	Size	Finish	Min.	Box
2430500	3/8"	Black	1	25



"C" CLAMP

W-R#	Size	Finish	Min.	Box
2432002	3/8"	Black	1	25

MALLEABLE PIPE HANGERS



**SPLIT-RING HANGER
(SCREW TYPE)**

W-R#	Size	Finish	Min.	Box
2413004	1/2"	Black	1	100
2413006	3/4"	Black	1	100
2413008	1"	Black	1	50
2413010	1 1/4"	Black	1	50
2413012	1 1/2"	Black	1	50
2413014	2"	Black	1	50

W-R#	Size	Finish	Min.	Box
2414004	1/2"	Galv	1	100
2414006	3/4"	Galv	1	100
2414008	1"	Galv	1	50
2414010	1 1/4"	Galv	1	50
2414012	1 1/2"	Galv	1	50
2414014	2"	Galv	1	50

W-R#	Size	Finish	Min.	Box
2415004	1/2"	Copper	1	100
2415006	3/4"	Copper	1	100
2415008	1"	Copper	1	50
2415010	1 1/4"	Copper	1	50
2415012	1 1/2"	Copper	1	50
2415014	2"	Copper	1	50



**SPLIT-RING HANGER
(HINGE-TYPE)**

Hinge design makes installation easier and saves time

W-R#	Size	Finish	Min.	Box
2413022	1/2"	Black	1	100
2413024	3/4"	Black	1	100
2413026	1"	Black	1	50
2413028	1 1/4"	Black	1	50
2413030	1 1/2"	Black	1	50
2413032	2"	Black	1	50

W-R#	Size	Finish	Min.	Box
2414022	1/2"	Galv	1	100
2414024	3/4"	Galv	1	100
2414026	1"	Galv	1	50
2414028	1 1/4"	Galv	1	50
2414030	1 1/2"	Galv	1	50
2414032	2"	Galv	1	50

W-R#	Size	Finish	Min.	Box
2415022	1/2"	Copper	1	100
2415024	3/4"	Copper	1	100
2415026	1"	Copper	1	50
2415028	1 1/4"	Copper	1	50
2415030	1 1/2"	Copper	1	50
2415032	2"	Copper	1	50

PIPE HANGERS



**LIGHT DUTY
STEEL
CLEVIS HANGERS**



W-R#	Size	Min.	Box
2431002	1/2"	1	25
2431004	3/4"	1	25
2431006	1"	1	25
2431008	1 1/4"	1	25
2431010	1 1/2"	1	25
2431012	2"	1	25
2431014	2 1/2"	1	25
2431016	3"	1	25
2431018	4"	1	25

HEAVY DUTY 2431020 6" 1 10



**LIGHT DUTY
-COPPERIZED-
CLEVIS HANGERS**



W-R#	Size	Min.	Box
2431500	1/2"	1	25
2431502	3/4"	1	25
2431504	1"	1	25
2431506	1 1/4"	1	25
2431508	1 1/2"	1	25
2431510	2"	1	25
2431512	2 1/2"	1	25
2431514	3"	1	25
2431516	4"	1	25



**18 GAUGE
GALVANIZED
INSULATION SHIELDS**



W-R#	Size	Min.	Box
2438002	1 1/2"	1	25
2438004	2"	1	25
2438006	3"	1	25
2438008	4"	1	25
2438010	6"	1	10



**BLACK STEEL RISER
CLAMPS**



W-R#	Size	Min.	Box
2434012	2"	1	25
2434014	3"	1	25
2434016	4"	1	25
2434018	6"	1	10

PIPE HANGERS



**PVC-COATED
DWV HANGERS**



W-R#	Size	Min.	Box
2392002	1 1/2"	1	100
2392004	2"	1	50
2392006	3"	1	25
2392008	4"	1	25
2392010	6"	1	25



**COPPERIZED
BELL HANGERS**

W-R#	Size	Min.	Box
2419002	1/2"	25	25
2419004	3/4"	25	25
2419006	1"	25	25



**COPPERIZED
MILFORD HANGERS**

W-R#	Size	Length	Min.	Box
2419502	1/2"	6"	25	25
2419504	3/4"	6"	25	25
2419506	1"	6"	25	25
2419602	1/2"	12"	25	25
2419604	3/4"	12"	25	25
2419606	1"	12"	25	25



**GALVANIZED
TWO-HOLE
PIPE STRAPS**



W-R#	Size	Min.	Box
2405004	1/2"	100	100
2405006	3/4"	100	100
2405008	1"	50	50
2405010	1 1/4"	50	50
2405012	1 1/2"	50	50
2405014	2"	25	25
2405016	2 1/2"	25	25
2405018	3"	25	25
2405020	4"	25	25



**COPPER-CLAD
TWO-HOLE
PIPE STRAPS**



W-R#	Size	Min.	Box
2422002	3/8"	100	100
2422004	1/2"	100	100
2422005	3/4"	100	100
2422006	1"	50	50
2422008	1 1/4"	50	50
2422010	1 1/2"	25	25
2422012	2"	25	25

PIPE HANGERS

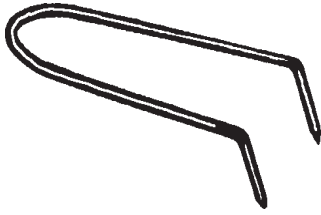

**COPPER CLAD
PIPE HOOKS**



W-R#	Size	Length	Min.	Box
2416004	1/2"	6"	50	50
2417004	3/4"	6"	50	50
2418004	1"	6"	50	50



WHITE ABS J-HOOKS



W-R#	Size	Length	Min.	Box
2390002	1 1/2"	8"	10	10
2390004	2"	8"	10	10
2390006	3"	8"	10	10
2390008	4"	8"	10	10

- Furnished with nail



PVC TUBE NAILER



W-R#	Size	Min.	Box
2330002	1/2"	50	50
2330004	3/4"	50	50

- Plastic half clamp preloaded with nail. For copper, PEX, CPVC and polybutylene tubing.



**PVC "ALL-AROUND"
NAILER**



W-R#	Size	Min.	Box
2340002	1/2"	50	50
2340004	3/4"	50	50

- Plastic half clamp preloaded with nail. For copper, PEX, and polybutylene tubing.
- Isolates tubing from wood to prevent vibration noise



**PVC SUSPENSION
CLAMP**



W-R#	Size	Min.	Box
2350002	1/2"	50	50
2350004	3/4"	50	50
2350006	1"	50	50

- For copper, PEX, and polybutylene tubing.
- Plastic insulating suspension clamp reduces noise from tubing expansion & contraction.

PIPE HANGERS



PVC TWO-HOLE PIPE STRAPS



W-R#	Size	Min.	Box
2360002	1/2"	50	50
2360004	3/4"	50	50
2360006	1"	50	50

- For copper, PEX, and polybutylene tubing
 - Plastic two hole pipe clamp reduces noise from tubing expansion & contraction.



PVC PIPE INSULATORS



W-R#	Size	Min.	Box
2380002	1/2"	50	50
2380004	3/4"	50	50
2380006	1"	25	25

- For copper, PEX, and polybutylene tubing



PVC METAL STUD INSULATORS



W-R#	Size	Min.	Box
2391002	1/2" - 3/4"	50	50
2391004	1"	50	50

- For copper, PEX, and polybutylene tubing
 - For use in metal studs and galvanized pipe support brackets.



PERFORATED GALVANIZED DUCT HANGING IRON



W-R#	Gauge	Pattern	Min.	Box
2406000	24g	Standard	1	50
2406001	28g	Light	1	50

- 3/4" x 10 foot
 - With alternating nail/screw holes (1/4" and 9/64")

PERFORATED STANDARD HANGING IRON



W-R#	Gauge	Pattern	Min.	Box
2407002	18g	Heavy	1	50
2406002	24g	Standard	1	50

- 3/4" x 10 foot
 - With nail holes (1/4")

PERFORATED COPPERIZED HANGING IRON

W-R#	Gauge	Pattern	Min.	Box
2408002	24g	Standard	1	50

- 3/4" x 10 foot
 - With nail holes (1/4")



PERFORATED PVC HANGING TAPE



W-R#	Width	Length	Min. ..
2409002	3/4"	100'	1 12

- Gray plastic .05 thick

PIPE HANGERS & FASTENERS



1/2" COPPER PIPE SUPPORT BRACKET

W-R#	Length	Gauge	Min.	Box
2436002	20"	16	1	50

- Copper-plated



1/2"-3/4"-1" SUPPORT BRACKET

W-R#	Length	Gauge	Min.	Box
2436004	20"	16	1	50

- Copper-plated

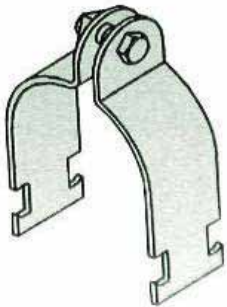

STRUT CLAMPS - I.P.S.

W-R#	Size	Min.	Box
2393002	1/2" IPS	1	50
2393004	3/4" IPS	1	50
2393006	1" IPS	1	50
2393008	1 1/4" IPS	1	25
2393010	1 1/2" IPS	1	25
2393012	2" IPS	1	25

STRUT CLAMPS - C.T.S.

W-R#	Size	Min.	Box
2394002	1/2" CTS	1	50
2394004	3/4" CTS	1	50
2394006	1" CTS	1	50
2394008	1 1/4" CTS	1	25
2394010	1 1/2" CTS	1	25
2394012	2" CTS	1	25



GENERAL PURPOSE TIE WIRE

W-R#	Length	Gauge	Min.	Box
2427002	65'	18g	1	24



DOUBLE EXPANSION SHIELDS

W-R#	Size	Min.	Box
2402102	3/8"	25	25
2402104	1/2"	25	25



DROP-IN ANCHORS

W-R#	Size	Min.	Box
2402202	3/8"	25	25
2402204	1/2"	25	25



DROP-IN ANCHOR SETTING TOOL

W-R#	Min.	Box
1808302	3/8" Tool	1 6
1808304	1/2" Tool	1 6



Genuine **Sammy®** products have been the professional's choice for over 15 years. **Sammy®** screws save the contractor time and materials costs in pipe-hanging applications.

FOR WOOD



Straight Screws
For 3/8" All-thrd rod
Min. 1/4" Steel
Min 1-1/2" Wood

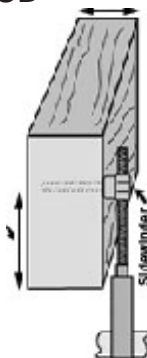

Sidewinders Screws
For 3/8" All-thrd rod
Designated by "SW"

FOR STEEL

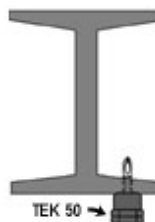

TEK 50 Self-drills & Self-taps into steel up to 1/2" thick. SWDR & DST self-drills & self-taps through 3/16" steel and accepts retainer nut.

FOR CONCRETE



Use 20 ft/lbs torque on nut. For CST use 1/4" bit & drill 2" deep in concrete.



"SAMMY" SCREWS® FOR WOOD

Fits 3/8" threaded rod

W-R#	Pattern	Length	Sammy#	Box
2440001	Straight	1"	GST-10	25
2440002	Straight	2"	GST-20	25
2440015	Straight	3"	GST-30	25
2440003	Sidewinder	1"	SWG-10	25
2440004	Sidewinder	2 1/2"	SWG-25-380	25
2440016	Sidewinder	3"	SWG-30	25



"SAMMY" SCREWS® FOR STEEL

Fits 3/8" threaded rod

"*" items are furnished with retaining nut

W-R#	Pattern	Length	Sammy#	Box
2440006	Straight	1"	DST-10	25
* 2440020	Straight	1"	DSTR-1	25
* 2440022	Straight	1 1/4"	DSTR516	25
2440010	Straight	1 1/2"	TEK-50	25
2440018	Straight	2"	DST-20	25
* 2440008	Sidewinder	1 1/4"	SWDR516	25



"SAMMY" SCREWS® FOR CONCRETE

Fits 3/8" threaded rod

W-R#	Pattern	Length	Sammy#	Box
2440012	Straight	1 1/2"	CST-20	25
2440014	Sidewinder	1 1/2"	SWC-20	25



Genuine **Sammy®** products have been the professional's choice for over 15 years. **Sammy®** screws save the contractor time and materials costs in pipe-hanging applications.



"SAMMY X-PRESS®" SCREWS FOR STEEL DECK



Sammy XPress #2440030

W-R#	Sammy#
2440030	Sammy XPress XP-20

- Sammy XPress® is a patented, unique solution for hanging rod where access to the back of the fastener is restricted (Metal Roof Deck, Tubular Steel, Etc.)
- No retaining nut required
- Must be used with installation tool #2440110.



"SAMMY" SCREWS® TOGGLE BOLT



W-R#	Pattern	Length	Sammy#	Box
2440050	Straight	3"	SST-30	25

- Can be used in lath & plaster, and double 5/8" wallboard.



"SAMMY" SCREWS® - SETTING TOOL -



W-R#	Sammy#
2440102	Sammy Driver 8113910
2440104	Sidewinder Driver 8114910
2440110	Sammy Xpress Tool 8194910

ALL "SAMMY" SCREWS ARE FOR 3/8" THREADED ROD

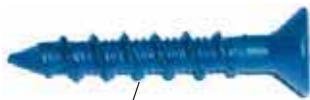

TAPCON® CONCRETE ANCHORS



HiLo® Thread pattern

W-R#	Size	Box
1333002	1/4" x 1 1/4"	100
1333004	1/4" x 1 3/4"	100
1333006	1/4" x 2 3/4"	100

- Phillips head drive
- Blue Climaseal® coating
- Original HiLo® threading

PIPE HANGERS & FASTENERS



HANGER SCREWS

W-R#	Dia.	Length	Min.	Box
2432500	3/8"	3 1/2"	1	25
2432502	3/8"	6"	1	25

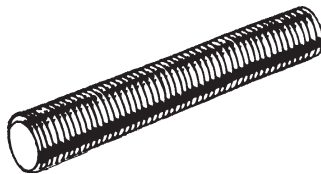

THREADED STEEL RODS - BLACK

W-R#	Dia.	Length	TPI	Min.	Box
2409006	3/8"	6'	16	35	35
2409008	1/2"	6'	13	20	20



STEEL THREADED ROD COUPLING

W-R#	Dia.	TPI	Min.	Box
2402006	3/8"	16	25	25
2402008	1/2"	13	25	25



STEEL HEX NUT FOR THREADED ROD

W-R#	Dia.	TPI	Min.	Box
2403002	1/4"	20	100	100
2403006	3/8"	16	100	100
2403008	1/2"	13	100	100



STEEL WASHER FOR THREADED ROD

W-R#	Dia.	OD	Min.	Box
2404002	1/4"	3/4"	100	100
2404006	3/8"	1"	100	100
2404102	3/8"	1 1/2"	100	50
2404008	1/2"	1 3/8"	100	100



STOVE BOLTS

W-R#	Dia.	Length	TPI	Min.	Box
2401002	1/4"	1"	20	100	100

- Round Head
- Slotted
- Zinc-plated

FASTENERS



SELF-PIERCING SHEET METAL "ZIP" SCREWS

W-R#	Dia.	Length	Box
1334010	#8	1/2"	100
1334050	#8	1/2"	1000
1334012	#8	3/4"	100
1334014	#8	1"	100

- Hard zinc plated
- Slotted hex head



SELF-DRILLING "TEK" SCREWS

W-R#	Dia.	Length	Box
1334004	#8	1/2"	100
1334006	#8	3/4"	100
1334008	#8	1"	100

- Hard zinc plated
- Slotted hex head



TOGGLE BOLTS

W-R#	Dia.	Length	Box
2402302	1/4"	4"	25

- Zinc Plated
- Furnished with wing



MAGNETIC NUT SETTERS

W-R#	Hex Size	Length	Box
1808320	1/4"	1 3/4"	12
1808322	5/16"	1 3/4"	12



W-R SCREW & ANCHOR KITS



W-R#	Dia.	Length	Box
2401500	3/16" (#8)	1"	25
2401502	1/4" (#10)	1"	25
2401506	5/16" (#12)	1 1/2"	25

- Each kit contains:
 - 100 hex head--phillips screws
 - 100 plastic anchors
 - 1 carbide masonry drill bit



MASONRY DRILL BIT

W-R#	Dia.	Length	Box
1812600	3/16"	4"	6
1812602	1/4"	4"	6
1812604	5/16"	4"	6
1812606	3/8"	4"	6
1812608	1/2"	4"	6

**FASTENERS
& TOOLS**



4-1 SCREW DRIVER

6-1 SCREW DRIVER

W-R#		Box
1808402	4-1 Screwdriver	12
1808403	6 -1 Screwdriver	12

- Rubberized grip
- Individually display carded



NUT DRIVERS

W-R#		Min	Box
1808452	5/16"	1	12



NO-HUB TORQUE WRENCH

W-R#	Description	Min	Box
1818500	No-Hub Wrench	1	6

- 5/16" socket



Reversible Clutch

CROWN DELUXE NO-HUB TORQUE WRENCH

W-R#	Description	Min	Box
1818560	60 psi Wrench	1	1

- 5/16" socket



FOLDING HEX KEY SET

W-R#		Min	Box
1818135		1	6



T-HANDLE HEX KEY SET

W-R#	Size	Min	Box
1818137	9"	1	6

- 8 piece set
- 3/32", 7/64", 1/8", 9/64", 5/32", 3/16", 7/32", 1/4"



8 PIECE ALLEN WRENCH SET ON RING

W-R#		Min	Box
1818140	1/16" to 1/4"	1	6

**STUD GUARDS,
PLATES & FLASHINGS**

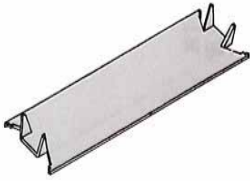

**16 GAUGE
-TRI-POINT-
STUD GUARDS**

W-R#	Length	Width	Min	Box
2432610	3"	1 1/2"	250	250
2432612	6"	1 1/2"	100	100

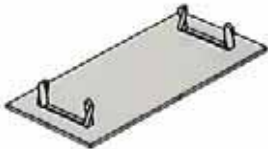

**19 GAUGE
'TWIST-POINT'
STUD GUARDS**

W-R#	Length	Width	Min	Box
2432602	3"	1 1/2"	250	250
2432600	6"	1 1/2"	100	100



**16 GAUGE
8-HOLE FHA STRAPS**

W-R#	Length	Width	Min	Box
2432710	12"	1 1/2"	1	50



**16 GAUGE
5" X 8"
BOCA PLATES**

W-R#	Description	Min	Box
2432802	6-hole regular	50	50
2432806	Self-Nailing	50	50



**GALVANIZED
ROOF FLASHINGS**

W-R#	Description	Min	Box
2534002	1 1/2"	12	12
2534004	2"	12	12
2534006	3"	12	12
2534008	4"	12	12



**ALUMINUM
ROOF FLASHINGS**

W-R#	Description	Min	Box
2534202	1 1/2"	12	12
2534204	2"	12	12
2534206	3"	12	12
2534208	4"	12	12

BRASS COMPRESSION & FLARE FITTINGS

60 COMPRESSION FERRULES



W-R#	Description	Min.	Box
2014002	3/16"	-	100
2014004	1/4"	-	100
2014008	3/8"	-	100
2014010	1/2"	-	100
2014012	5/8"	-	100

POLY COMPRESSION FERRULES



W-R#	Description	Min.	Box
2013600	3/8"	-	100
A000120	1/4"	-	100

61 COMPRESSION NUTS



W-R#	Description	Min.	Box
2015004	1/4" RB	-	25
2015006	3/8" RB	-	25
0224002	3/8" Chrome	-	25
2015008	1/2" RB	-	25
2015010	5/8" RB	-	25

61S-LF COMPRESSION CAPS



LEAD-FREE

W-R#	Description	Min.	Box
4022000	3/8"	-	25
4021990	1/4"	-	25

62-LF COMPRESSION UNIONS



LEAD-FREE

W-R#	Description	Min.	Box
4021004	1/4"	-	12
4021008	3/8"	-	12
4021010	1/2"	-	12
4021012	5/8"	-	12
4021014	7/8"	-	12
4021016	3/8" x 1/4"	-	12
4021018	1/2" x 3/8"	-	12
4021020	5/8" x 3/8"	-	12

64-LF COMPRESSION TEES



LEAD-FREE

W-R#	Description	Min.	Box
4016002	1/4"	-	12
4016004	3/8"	-	12
4016006	1/2"	-	12
4016008	5/8"	-	12
4016014	3/8" x 1/4"	-	12

BRASS COMPRESSION & FLARE FITTINGS

65-LF COMPRESSION ELBOW



LEAD-FREE

W-R#	Description	Min.	Box
4017004	3/8"	-	12
4017006	1/2"	-	12
4017008	5/8"	-	12

68-LF COMPRESSION x MALE



LEAD-FREE

W-R#	Description	Min.	Box
4019004	1/4" x 1/8" RB	-	12
4019006	1/4" x 1/4" RB	-	12
4019008	1/4" x 3/8" RB	-	12
4019010	1/4" x 1/2" RB	-	12
4019018	3/8" x 1/4" RB	-	12
4019020	3/8" x 3/8" RB	-	12
4225010	3/8" x 3/8" Chrome-	-	12
4019022	3/8" x 1/2" RB	-	12
4225014	3/8" x 1/2" Chrome-	-	12
4019026	1/2" x 3/8" RB	-	12
4019028	1/2" x 1/2" RB	-	12
4019030	5/8" x 3/8" RB	-	12
4019032	5/8" x 1/2" RB	-	12
4019034	7/8" x 3/4" RB	-	12

66-LF COMPRESSION x FEMALE



LEAD-FREE

W-R#	Description	Min.	Box
4018010	3/8" x 3/8" RB	-	12
4225012	3/8" x 3/8" Chrome-	-	12
4018012	3/8" x 1/2" RB	-	12
4225016	3/8" x 1/2" Chrome-	-	12
4018016	1/2" x 3/8" RB	-	12
4018018	1/2" x 1/2" RB	-	12
4018020	5/8" x 1/2" RB	-	12

69-LF COMPRESSION x MALE ELBOW



LEAD-FREE

W-R#	Description	Min.	Box
4020002	1/4" x 1/8"	-	12
4020004	1/4" x 1/4"	-	12
4020016	3/8" x 1/4"	-	12
4020018	3/8" x 3/8"	-	12
4020020	3/8" x 1/2"	-	12
4020024	1/2" x 3/8"	-	12
4020026	1/2" x 1/2"	-	12

68T TANK COMPRESSION FTG



W-R#	Description	Min.	Box
2019502	3/8" x 3/8"	-	12
2019504	1/2" x 1/2"	-	12

- For use in duplex tank bushings
 - For non-potable use only

BRASS COMPRESSION & FLARE FITTINGS

668-LF COMPRESSION X SWEAT



LEAD-FREE

W-R#	Description	Min.	Box
4225004	3/8" RB	-	25
4225002	3/8" Chrome	-	25

70-LF COMPRESSION X FEMALE ELBOW



LEAD-FREE

W-R#	Description	Min.	Box
4023008	3/8" x 1/2"	-	12

41S SHORT FLARE NUT



W-R#	Description	Min.	Box
2001002	1/4"	-	25
2001006	3/8"	-	25
2001008	1/2"	-	25
2001010	5/8"	-	25

42 FLARE UNION



W-R#	Description	Min.	Box
2002006	3/8"	-	12
2002008	1/2"	-	12
2002012	1/2" x 3/8"	-	12

48 FLARE X MALE ADAPTER



W-R#	Description	Min.	Box
2003006	1/4" x 1/4"	-	12
2003016	3/8" x 1/4"	-	12
2003018	3/8" x 3/8"	-	12
2003020	3/8" x 1/2"	-	12
2003024	1/2" x 3/8"	-	12
2003026	1/2" x 1/2"	-	12

49 FLARE X MALE ELBOW



W-R#	Description	Min.	Box
2006010	3/8" x 3/8"	-	12
2006008	3/8" x 1/4"	-	12
2006014	1/2" x 1/4"	-	12

125-LF HOSE BARB X MALE



LEAD-FREE

W-R#	Description	Min.	Box
4031002	1/8" x 1/8"	-	12
4031004	1/4" x 1/8"	-	12
4031006	1/4" x 1/4"	-	12
4031008	1/4" x 3/8"	-	12
4031010	3/8" x 1/4"	-	12
4031012	3/8" x 3/8"	-	12
4031014	3/8" x 1/2"	-	12

BRASS COMPRESSION & FLARE FITTINGS

138HM-LF HOSE BARB MENDER



LEAD-FREE

W-R#	Description	Min.	Box
4030002	1/4" x 1/4"	-	12
4030004	3/8" x 3/8"	-	12
4030006	1/2" x 1/2"	-	12

MALE IPS X SWEAT ADAPTER



LEAD-FREE

W-R#	Description	Min.	Box
4109006	1/2" x 1/2"	1	12
4109008	3/4" x 3/4"	1	12

• Used to solder brass pipe to copper tubing.

110FB FACE BUSHING



W-R#	Description	Min.	Box
2527002	1/2" x 3/8"	-	12
2527004	3/4" x 1/2"	-	12

CPVC x MIP ADAPTER



LEAD-FREE

W-R#	Description	Box
4104004	1/2" CPVC x 1/2" MIP	12
4105004	3/4" CPVC x 3/4" MIP	12

BRASS VENT FITTING



W-R#	Description	Min.	Box
2112000	1/2" x 1/8"	-	12
2112002	1/2" x 1/4"	-	12

CPVC x FIP ADAPTER



LEAD-FREE

W-R#	Description	Box
4104002	1/2" CPVC x 1/2" FIP	12
4105002	3/4" CPVC x 3/4" FIP	12

**CHROME-PLATED
NIPPLES & FITTINGS**

**CHROME-PLATED
NIPPLES
- LEAD FREE -**



LEAD-FREE

3/8"IPS	1/2"IPS	LENGTH
0302502	0302544	Close (*)
0302504	0302546	Shoulder (1 1/2")
0302506	0302548	2"
0302508	0302550	2 1/2"
0302510	0302552	3"
0302512	0302554	3 1/2"
0302514	0302556	4"
0302516	0302558	4 1/2"
0302518	0302560	5"
0302520	0302562	5 1/2"
0302522	0302564	6"
0302524	-	7"
0302526	-	8"
0302534	-	12"

- Close overall length varies by diameter.
3/8" x Close = 1" OAL
1/2" x Close = 1 1/8" OAL



**CHROME-PLATED
COUPLINGS
- LEAD FREE -**

LEAD-FREE

W-R#	Description	Min.	Box
0341402	3/8"	1	-
0341404	1/2"	1	-



**CHROME-PLATED
90° ELBOWS
- LEAD FREE -**

LEAD-FREE

W-R#	Description	Min.	Box
0341002	3/8"	1	-
0341004	1/2"	1	-



**CHROME-PLATED
45° ELBOW
- LEAD FREE -**

LEAD-FREE

W-R#	Description	Min.	Box
0341102	3/8"	1	-
0341104	1/2"	1	-

**CHROME-PLATED
NIPPLES & FITTINGS**



**CHROME-PLATED
TEE**
- LEAD FREE -



W-R#	Description	Min.	Box
0341502	3/8"	1	-
0341504	1/2"	1	-



**CHROME-PLATED
90° STREET ELBOW**
- LEAD FREE -



W-R#	Description	Min.	Box
0341602	3/8"	1	-
0341606	1/2"	1	-



**CHROME-PLATED
45° STREET ELBOW**
- LEAD FREE -



W-R#	Description	Min.	Box
0341608	1/2"	1	-



**CHROME-PLATED
UNION**
- LEAD FREE -



W-R#	Description	Min.	Box
0341904	1/2"	1	-



**CHROME-PLATED
CAP**
- LEAD FREE -



W-R#	Description	Min.	Box
0349014	1/2"	1	-



THE ONE SOURCE FOR

STAINLESS STEEL

BRAIDED

FLEXIBLE WATER

SUPPLY TUBES

**FLEXI
FLOW**®

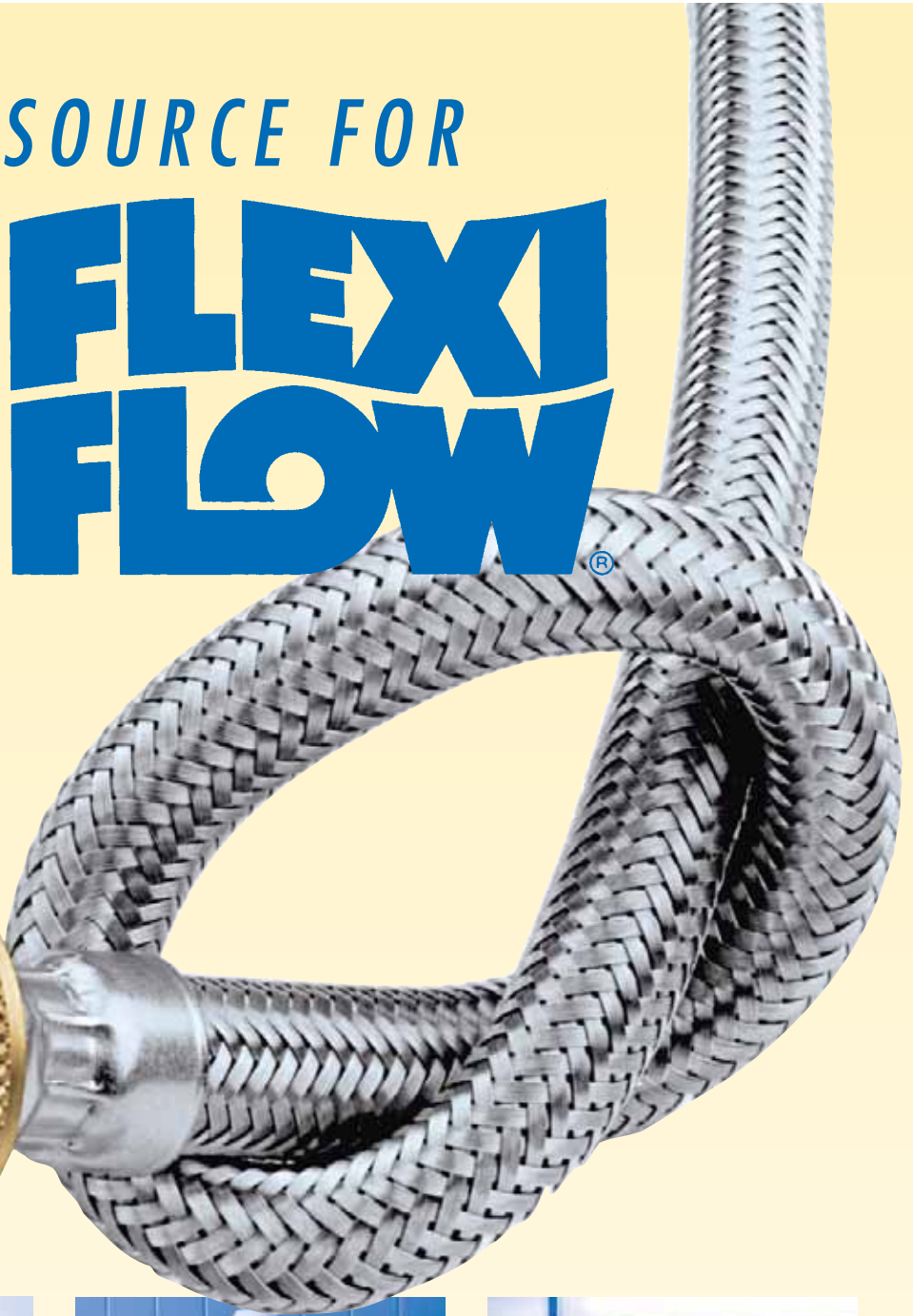
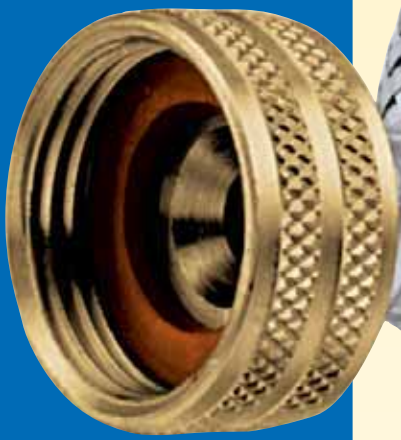

TOILET CONNECTORS



BASIN CONNECTORS



WASHING MACHINE & DISHWASHER CONNECTORS

**FLEXI
FLOW**

STAINLESS STEEL BRAIDED
FLEXIBLE WATER SUPPLY
TUBES

**FLEXIFLOW®
LEAD-FREE
STAINLESS STEEL
BRAIDED CONNECTORS**

NEW!

- Lead Free
- Nylon Reinforced
Core for greater
strength & flexibility!



**FAUCET
CONNECTORS**

**FLEXI
FLOW**



LEAD-FREE

Meets NSF-61G & AB1953 Standards

W-R#	Description	Box	Ctn
B89	3/8"OD X 1/2"FIP X 9"	25	100
B812	3/8"OD X 1/2"FIP X 12"	25	100
B816	3/8"OD X 1/2"FIP X 16"	25	100
B820	3/8"OD X 1/2"FIP X 20"	25	100
B830	3/8"OD X 1/2"FIP X 30"	25	100
B836	3/8"OD X 1/2"FIP X 36"	25	100
B212	1/2"OD X 1/2"FIP X 12"	25	100
B220	1/2"OD X 1/2"FIP X 20"	25	100
BIP12	1/2"FIP X 1/2"FIP X 12"	25	100
BIP20	1/2"FIP X 1/2"FIP X 20"	25	100



**DELTA FAUCET
CONNECTORS**

**FLEXI
FLOW**



LEAD-FREE

Meets NSF-61G & AB1953 Standards



W-R#	Description	Box	Ctn
C12	3/8"OD X 3/8"Delta X 12"	25	100
C20	3/8"OD X 3/8"Delta X 20"	25	100

3/8" Delta connection slips
over copper tubing



**TOILET CONNECTORS
with METAL NUT**

**FLEXI
FLOW**



Meets NSF-61G & AB1953 Standards

W-R#	Description	Box	Ctn
TM89	3/8"OD X 7/8"Tank X 9"	25	100
TM812	3/8"OD X 7/8"Tank X 12"	25	100
TM820	3/8"OD X 7/8"Tank X 20"	25	100



**WIDESPREAD FAUCET
CONNECTORS**

**FLEXI
FLOW**



LEAD-FREE

Meets NSF-61G & AB1953 Standards

W-R#	Description	Box	Ctn
8812	3/8"OD X 3/8"OD X 12"	25	100
8820	3/8"OD X 3/8"OD X 20"	25	100

All Flexiflow® Connectors are labelled with Installation guidelines and warranty information.
For more information, [please click here.](#)

FLEXI FLOW

STAINLESS STEEL BRAIDED FLEXIBLE WATER SUPPLY TUBES



Meets NSF-61G & AB1953 Standards

FLEXIFLOW® LEAD-FREE STAINLESS STEEL BRAIDED CONNECTORS

NEW!

- Lead Free
- Nylon Reinforced Core for greater strength & flexibility!



ICE-MAKER CONNECTOR KITS W/SADDLE VALVE

LEAD-FREE

ICE-MAKER HOSE ONLY

LEAD-FREE

W-R#	Description	Box
4816504	1/4"OD X 1/4"OD X 6'	10
4816500	1/4"OD X 1/4"OD X 10'	10
4816502	1/4"OD X 1/4"OD X 20'	10

- Furnished with 1/4" saddle valve

W-R#	Description	Box
IM-6	1/4"OD X 1/4"OD X 6'	10
IM-10	1/4"OD X 1/4"OD X 10'	10
IM-20	1/4"OD X 1/4"OD X 20'	10



FLEXI FLOW



Meets NSF-61G & AB1953 Standards

DISHWASHER CONNECTORS

W-R#	Description	Box
DW848	3/8"OD X 3/8"OD X 48"	10
DW860	3/8"OD X 3/8"OD X 60"	10
DW872	3/8"OD X 3/8"OD X 72"	10

- Dishwasher connectors are furnished with brass elbow



FLEXI FLOW



NEW-STYLE DISHWASHER CONNECTORS WITH FEMALE HOSE ELBOW



NEW!

W-R#	Description	Box
DW948	3/8"OD X 3/8"OD X 48"	10
DW960	3/8"OD X 3/8"OD X 60"	10
DW972	3/8"OD X 3/8"OD X 72"	10

- Furnished with 3/4" FH Elbow to fit new dishwashers



FLEXI FLOW



WASHING MACHINE CONNECTORS

W-R#	Description	Box
WM-4	3/4"FH X 3/4"FH X 4'	10
WM-5	3/4"FH X 3/4"FH X 5'	10
WM-6	3/4"FH X 3/4"FH X 6'	10

- Individually bagged with washers

All Flexiflow® Connectors are labelled with Installation guidelines and warranty information. For more information, [please click here.](#)

SINK SPECIALTIES



FLEXIBLE BASIN SUPPLY TUBES

W-R#	Size (OD)	Finish	Min	Box
0209008	3/8" x 12"	CP	1	100
0209012	3/8" x 20"	CP	1	100
0209014	3/8" x 30"	CP	1	50
0209016	3/8" x 36"	CP	1	50
<hr/>				
0209020	1/2" x 20"	CP	1	50



FLEXIBLE TANK SUPPLY TUBES

W-R#	Size (OD)	Finish	Min	Box
0210002	3/8" x 12"	CP	1	100
0210006	3/8" x 20"	CP	1	100



COMPRESSION "DELTA" STYLE SUPPLY TUBE

W-R#	Size (OD)	Finish	Min	Box
0215006	3/8" x 12"	CP	1	100
0215008	3/8" x 20"	CP	1	100

- Furnished with 3/8" compression nut

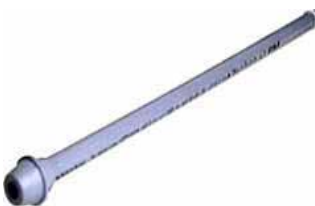

PEX SUPPLY TUBES

W-R#	Size (OD)	Type	Min	Box
0207002	3/8" x 12"	Basin	1	100
0207006	3/8" x 20"	Basin	1	100
0207008	3/8" x 30"	Basin	1	50
0207010	3/8" x 36"	Basin	1	50

W-R#	Size (OD)	Type	Min	Box
0208002	3/8" x 12"	Tank	1	100
0208006	3/8" x 20"	Tank	1	100

**SINK
SPECIALTIES**



**BASIN COCK
LOCKNUTS**

W-R#	Description	Min.	Box
0906004	Brass	12	12
0906002	Die Cast	12	12
0906006	Plastic	12	12

- Fits 1/2" x 14T basin cock shanks



**STEEL
BASIN ROSETTES**

W-R#	Description	Min.	Box
1646002	Flat	25	25
1646004	Deep	25	25

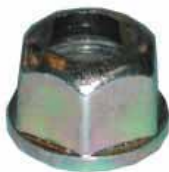

**BASIN COCK COUPLING
NUT**

W-R#	Description	Min	Box
0912002	Brass	25	25
0912004	Brass-Plated	25	25
0912006	Plastic	25	25

- 1/2" x 14T with 1/2" supply hole



BRASS FRICTION RINGS

W-R#	Description
2712002	Basin 3/8" x 21/32" x 25/64"
2712004	Toilet 3/8" x 13/16" x 25/64"

- 100 per bag



**BEVELED RUBBER
BASIN SUPPLY
WASHER**

W-R#	Description	Box
2711008	3/8" x 23/32" x 3/8"	100



**BEVELED RUBBER
TANK SUPPLY WASHER**

W-R#	Description	Box
2711007	3/8" x 5/16" x 27/32"	100



3/8" COMPRESSION NUT

W-R#	Finish	Min.	Box
2015006	Rough Brass	25	100
0224002	Chrome	25	100

SINK SPECIALTIES



ANGLE COMPRESSION STOPS
- LEAD FREE -



W-R#	Size	Box
4220002	3/8"OD x 3/8" IPS	10
4220004	3/8"OD x 1/2" IPS	10
4220010	3/8"OD x 1/2" SWT	10
4220014	3/8"OD x 5/8"OD	10
4220016	3/8"OD x 1/2" PEX	10



STRAIGHT COMPRESSION STOPS
- LEAD FREE -



W-R#	Size	Box
4220024	3/8"OD x 3/8" IPS	10
4220026	3/8"OD x 1/2" IPS	10
4220032	3/8"OD x 1/2" SWT	10
4220036	3/8"OD x 5/8"OD	10
4220038	3/8"OD x 1/2" PEX	10



3/8" OD x 1/2" SWT 5" EXTENSION STOP
- LEAD FREE -



W-R#	Pattern	Min	Box
4222002	Angle	1	10
4222004	Straight	1	10

Q.T.



ANGLE QUARTER-TURN COMPRESSION STOPS
- LEAD FREE -



W-R#	Size	Box
4220001	3/8"OD x 3/8" IPS	10
4220003	3/8"OD x 1/2" IPS	10
4220005	3/8"OD x 1/2" SWT	10
4220007	3/8"OD x 5/8"OD	10
4220009	3/8"OD x 1/2" PEX	10

Q.T.



STRAIGHT QUARTER-TURN COMPRESSION STOPS
- LEAD FRE -



W-R#	Size	Box
4220013	3/8"OD x 1/2 IPS	10
4220015	3/8"OD x 1/2 SWT	10
4220017	3/8"OD x 5/8 OD	10
4220019	3/8"OD x 1/2" PEX	10

Q.T.



3/8" OD x 1/2" SWT QUARTER-TURN 5" EXTENSION STOP
- LEAD FREE -



W-R#	Size	Box
4222020	Angle	10

SINK SPECIALTIES



THREE WAY STOP
- LEAD FREE -



W-R#	Inlet	Outlets
4221002	5/8"OD	3/8"OD x 3/8"OD
4221008	5/8"OD	3/8"OD x 1/4"OD
4221010	1/2" IPS	3/8"OD x 3/8"OD
4221012	1/2" IPS	3/8"OD x 1/4"OD



DUAL SHUTOFF STOP
- LEAD FREE -



W-R#	Inlet	Outlets
4220602	5/8"OD	3/8"OD x 3/8"OD
4220604	5/8"OD	3/8"OD x 1/4"OD
4220702	1/2"IPS	3/8"OD x 3/8"OD
4220704	1/2"IPS	3/8"OD x 1/4"OD
4220802	1/2"SWT	3/8"OD x 3/8"OD
4220804	1/2"SWT	3/8"OD x 1/4"OD



LOOSE-KEY ANGLE STOP
- LEAD FREE -



W-R#	Inlet	Outlet
4220502	1/2" IPS	3/8"OD *LF*
4220504	1/2" SWT	3/8"OD *LF*
4220506	5/8"OD	3/8"OD *LF*



"MAX" ADAPTER
- LEAD FREE -



W-R#	Size	Min	Box
4225030	3/8" X 3/8" X 3/8"	6	24
4225032	3/8" X 1/4" X 3/8"	6	24

- For add-on installation of water filters and ice makers. Takes an ordinary stop valve and makes it a three-way valve.



STRAIGHT "MAX" ADAPTER
- LEAD FREE -



W-R#	Size	Min	Box
4225050	3/8" X 1/4"	6	24



STRAIGHT "MAX" SHUTOFF VALVE
- LEAD FREE -



W-R#	Size
4220025	3/8" Fem. Comp. x 3/8" OD



**PREMIUM
"MINI-BALL" VALVES**



3/8F x 3/8 OD Comp

**DAHL MINI-BALL®
ANGLE STOPS
- LEAD FREE -**



W-R#	Size	Box
MB202LF	3/8"OD x 3/8" IPS	10
MB206LF	3/8"OD x 1/2" IPS	10
MB002LF	3/8"OD x 1/2" SWT	10
MB102LF	3/8"OD x 5/8" OD	10
MB402LF	3/8"OD x 1/2" PEX	10



3/8F x 3/8 OD Comp

**DAHL MINI-BALL®
STRAIGHT STOPS
- LEAD FREE -**



W-R#	Size	Box
MB204LF	3/8"OD x 3/8" IPS	10
MB208LF	3/8"OD x 1/2" IPS	10
MB004LF	3/8"OD x 1/2" SWT	10
MB104LF	3/8"OD x 5/8" OD	10
MB404LF	3/8"OD x 1/2" PEX	10

RetroValve™

RetroValve retrofit valves and adapters offer the professional a high-quality, convenient solution to the problem of frozen valves and appliance expansion. **RetroValves** are made in Canada, and are the finest 1/4 turn valves on the market.



**STRAIGHT
RETROVALVE™
- LEAD FREE -**



W-R#	Size
RV100LF	3/8" Fem. Comp. x 3/8" OD
RV104LF	1/2" Fem. Comp. x 3/8" OD



**RETROTEE™
- LEAD FREE -**



W-R#	Size
RV500LF	3/8 Fem Comp x 3/8"OD x 3/8"OD
RV502LF	3/8 Fem Comp x 1/4"OD x 3/8"OD

- Allows for addition of appliances such as ice makers, dishwashers, & humidifiers--with convenient shutoff.



**CHROME-PLATED
RETRODAPTER™
- LEAD FREE -**



W-R#	Min	Box
RV700LF	3/8 Fem Comp x 3/8"OD	x 3/8"OD
RV702LF	3/8 Fem Comp x 1/4"OD	x 3/8"OD

The RV700LF C. P. RetroDapter series provides a convenient, economical solution for the sharing of existing valves, without the need for a shutoff.

**SINK
SPECIALTIES**



**CHROME-PLATED
STEEL
FLAT ESCUTCHEON**

W-R#	Size - IPS	OD	Min	Box
1610002	3/8"	2 1/2"	25	500
1610004	1/2"	2 1/2"	25	500
1610006	3/4"	2 1/2"	25	250
1610008	1"	2 7/8"	25	250
1610010	1 1/4"	2 7/8"	25	200
1610012	1 1/2"	3"	25	200
1610014	2"	3"	25	100

W-R#	Size - Copper	OD	Min	Box
1611004	5/8"OD	2 1/2"	25	500
1611006	7/8"OD	2 1/2"	25	250
1611008	1 1/8"OD	2 7/8"	25	250
* 1611009	1 1/4"OD	2 7/8"	25	200
* 1611010	1 1/2"OD	3"	25	200
* 1611012	2"OD	3"	25	100

* Denotes tubular size

Nom.	1/2"	3/4"	1"	1 1/4"	1 1/2"	2"
IPS	.84	1.05	1.32	1.66	1.90	2.38
Copper	5/8"(.63)	7/8"(.88)	1 1/8" (1.13)	1 3/8" (1.38)	1 5/8" (1.63)	2 1/8" (2.13)
Tubular				1 1/4	1 1/2	2



**WHITE PLASTIC
SURE GRIP FLAT
ESCUTCHEON**

W-R#	Size (Copper)	Min	Box
1615020	5/8"OD	25	25
1615022	7/8"OD	25	25

SINK SPECIALTIES



**CHROME-PLATED
STEEL
BELL ESCUTCHEON**

W-R#	Size - IPS	OD	Min	Box
1612002	3/8"	2 3/8"	25	25
1612004	1/2"	2 3/8"	25	25

W-R#	Size - Copper	OD	Min	Box
1613006	5/8"OD	2 3/8"	25	25
* 1613009	1 1/4"OD	3"	1	25
* 1613010	1 1/2"OD	3"	1	25

* Denotes tubular size



**CHROME-PLATED
STEEL
BOX ESCUTCHEON**

W-R#	Size - IPS	OD	Min	Box
1614002	1 1/4"	3"	5	25
1614004	1 1/2"	3"	5	25

W-R#	Size - Copper	OD	Min	Box
1614012	1 3/8"OD	3"	5	25
* 1614006	1 1/4"OD	3"	5	25
* 1614008	1 1/2"OD	3"	5	25

* Denotes tubular size



**PLASTIC
SPLIT ESCUTCHEONS**

W-R#	Size (IPS)	Finish	Min
1731500	3/8" IP	Chrome	12
1731502	1/2" IP	Chrome	12
1731504	3/4" IP	Chrome	12
1731506	1" IP	Chrome	12
1731508	1 1/4" IP	Chrome	12
1731510	1 1/2" IP	Chrome	12
1731512	2" IP	Chrome	12
1731514	2 1/2" IP	Chrome	12
1731516	3" IP	Chrome	12
1731518	4" IP	Chrome	12
1731522	6" IP	Chrome	1

Nom.	1/2"	3/4"	1"	1 1/4"	1 1/2"	2"
IPS	.84	1.05	1.32	1.66	1.90	2.38
Copper	5/8"(.63)	7/8"(.88)	1 1/8"(1.13)	1 3/8"(1.38)	1 5/8"(1.63)	2 1/8"(2.13)
Tubular				1 1/4	1 1/2	2

W-R#	Size (Copper)	Finish	Min
1731602	5/8"OD	Chrome	12
1731802	5/8"OD	White	12
1731604	7/8"OD	Chrome	12
1731606	1 1/8"OD	Chrome	12
1731608	1 3/8"OD	Chrome	12
1731610	1 5/8"OD	Chrome	12
1731612	2 1/8"OD	Chrome	12

SINK SPECIALTIES



**STEEL
FLOOR AND CEILING
PLATES, LESS SPRING**

W-R#	Size - IPS	OD	Min	Box
1728000	3/8"	2 1/2"	12	144
1728002	1/2"	2 3/4"	12	144
1728004	3/4"	2 3/4"	12	144
1728006	1"	3 1/2"	12	144
1728008	1 1/4"	3 1/2"	12	144
1728010	1 1/2"	3 1/2"	12	144
1728012	2"	4 1/4"	12	120

W-R#	Size - Copper	OD	Min	Box
1730002	5/8"OD	2 3/4"	12	144
1730004	7/8"OD	2 3/4"	12	144
1730006	1 1/8"OD	2 3/4"	12	144
1730008	1 3/8"OD	3 1/2"	12	144
1730010	1 5/8"OD	3 1/2"	12	144



**HEAVY-DUTY STEEL
FLOOR AND CEILING
PLATES, WITH SPRING**

W-R#	Size - IPS	OD	Min	Box
1729000	3/8"	2 1/4"	12	144
1729002	1/2"	2 1/2"	12	144
1729004	3/4"	2 3/4"	12	144
1729006	1"	3 1/4"	12	144
1729008	1 1/4"	3 1/2"	12	144
1729010	1 1/2"	3 7/8"	12	144
1729012	2"	4 1/2"	12	120
1729014	2 1/2"	5 3/8"	12	120
1729016	3"	5 7/8"	1	12
1729018	3 1/2"	6 5/8"	1	12
1729020	4"	7 1/8"	1	12
1729022	5"	9"	1	12
1729024	6"	10"	1	12

Nom.	1/2"	3/4"	1"	1 1/4"	1 1/2"	2"
IPS	.84	1.05	1.32	1.66	1.90	2.38
Copper	5/8"(.63)	7/8"(.88)	1 1/8" (1.13)	1 3/8" (1.38)	1 5/8" (1.63)	2 1/8" (2.13)
Tubular				1 1/4	1 1/2	2

W-R#	Size - Copper	OD	Min	Box
1731002	3/8"OD	2 3/8"	12	144
1731004	5/8"OD	2 3/8"	12	144
1731006	7/8"OD	2 3/4"	12	144
1731008	1 1/8"OD	3"	12	144
1731010	1 3/8"OD	3 1/4"	12	144
1731012	1 5/8"OD	3 5/8"	12	144
1731014	2 1/8"OD	4"	12	120
1731016	2 5/8"OD	4 7/8"	1	48
1731018	3 1/8"OD	5 1/8"	1	48

SINK SPECIALTIES



**CHROME-PLATED
STEEL COCKHOLE
COVERS**

W-R#	Description	Min.	Box
1641002	1 3/4"	1	25
1641004	2"	1	25
1641006	3"	1	12



**CHROME-PLATED
STEEL "SNAP-IN"
COCKHOLE COVER**

W-R#	Description	Min.	Box
1642002	1 3/8"	25	25
1642004	1 1/2"	25	25



**COCKHOLE COVER
WITH CHAIN RING**

W-R#	Description	Min.	Box
1643002	1 3/4"	1	25

- Chrome-plated steel



**ABS
COCKHOLE COVERS**

W-R#	Description	Min.	Box
1642502	1 3/4" White	6	6



**COMBINATION
WALL MOUNT
SINK FAUCET
- LEAD FREE -**

W-R#	Description	Min.	Box
4702002	8"	1	-

• Furnished w. soap dish & 6" spout

LEAD-FREE

SINK SPECIALTIES



**CHROME-PLATED
BRASS BASIN COCK
- LEAD FREE -**



W-R#	Description	Min.	Box
4706002	Hot/Cold	1	6

- Basin cock sold individually
- Contains:
 - Hot and Cold Index Buttons
 - Plastic Locknut
 - Rubber Friction Washer
 - Brass Coupling Nut



**CHROME-PLATED
SELF-CLOSING
BASIN COCK
- LEAD FREE -**



W-R#	Description	Min.	Box
4706004	Cold	1	-
4706005	Hot	1	-



Male

**BRASS PLAIN END
BIBBS
- LEAD FREE -**



W-R#	Size	Connection	Finish	Box
4710002	½" IPS	Male	RB	10
4710006	½" IPS	Male	CP	10
4710010	½" IPS	Female	CP	10



Female



Adjustable
Flange Male

W-R#	Size	Connection	Finish	Box
4711002	½" MIPS Adjustable	CP		10



Male

**BRASS HOSE END
BIBBS
- LEAD FREE -**



W-R#	Size	Connection	Finish	Box
4709002	½" IPS	Male	RB	10
4709008	½" IPS	Male	CP	10
4709009	½" IPS	Female	CP	10



Female



Adjustable
Flange Male

W-R#	Size	Connection	Finish	Box
4711004	½" MIPS Adjustable	CP		10

SINK SPECIALTIES



**CP BRASS
BUBBLER HEAD
- LEAD FREE -**



W-R#	Description	Min.	Box
4708004	3/8" Connection	1	10

- Features adjustment screw to regulate flow



**CP BRASS
BUBBLER HEAD
WITH REMOVABLE
CARTRIDGE
- LEAD FREE -**



W-R#	Description	Min.	Box
4708006	3/8" Connection	1	10

- Comparable to OEM#0362

W-R#	Description	Min.	Box
0708010	Cartridge Only	1	12

- Comparable to OEM#K361



**"LONG REACH"
WATER FILTER FAUCET
- LEAD FREE -**



W-R#	Description	Min.	Box
4708052	1/4" Connection	1	10

- Angled spout for longer span



**6" WATER FILTER
FAUCET
- LEAD FREE -**



W-R#	Description	Min.	Box
4708050	1/4" Connection	1	10

- 6" Height

SINK SPECIALTIES



7" STEEL CHINA LAVATORY HANGER

W-R#	Description	Min.	Box
1648002	7"	1	12

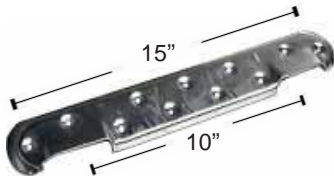

10" STEEL SINK HANGER

W-R#	Description	Min.	Box
1650002	10"	1	12



STEEL CHINA BASIN HANGER

W-R#	Description	Min.	Box
1647002	Hanger	1	12



CHROME-PLATED HEX STEEL LAVATORY LEGS

W-R#	Description	Length	Min.	Box
1602002	China	27"	1	25
1602004	China	31"	1	25
1602006	China	33"	1	25
1602010	China/IE	27"	1	25

SINK CLIP SETS

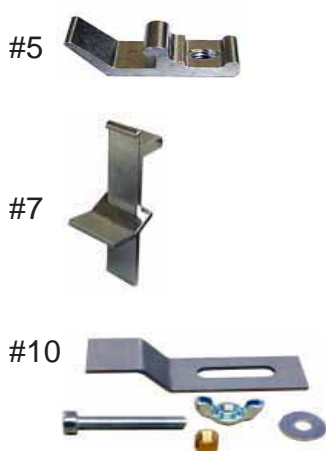
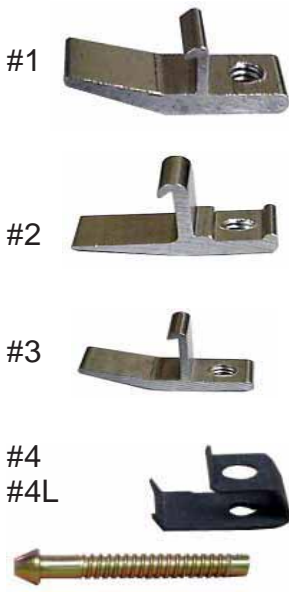

W-R#	Pattern	Width	Reference
0713002	#1	7/16"	Huddee
0713004	#2	7/16"	
0713006	#3	3/8"	
0713008	#4	9/16"	Elkay-1 1/2"
0713020	#4L	9/16"	Elkay-2 1/8"
0713010	#5	9/16"	Kinkead
0713014	#7	9/16"	Adjustable
* 0713030	#10	11/16"	Undermount

- All sink clips are 6 per bag
 * Undermount sink clips are 4 per bag, with brass anchors
 - Furnished with 1 7/16" screws

SINK SPECIALTIES



SPLASH GUARD TO FIT IN-SINKERATOR

W-R#	Description	Min.	Box
1679004	Splash Guard	1	6



HUSH-CUSHION TO FIT IN-SINKERATOR

W-R#	Description	Min.	Box
1679006	Hush Cushion	6	6

- Gasket to fit In-sinkerator garbage disposals. Reduces vibration during disposal activity.



MOLDED ELBOW TO FIT IN-SINKERATOR

W-R#	Description	Min.	Box
1679008	Elbow	1	6



DISPOSAL STOPPER TO FIT IN-SINKERATOR

W-R#	Description	Min.	Box
1679012	Stopper	1	6



AIR GAPS

W-R#	Description	Min.	Box
2428002	Air Gap	1	12



AIR ADMITTANCE VALVE

W-R#	Description	Min.	Box
2430002	1 1/2" Provent	12	50

**(PROVENT)
(BOCA VENT)**

• Fits 1 1/2" female waste line adapter. Eliminates secondary stack for tubs, sinks, basins, showers and washing machines.



FRAJON® ASSE-APPROVED AIR ADMITTANCE VALVE

W-R#	Description	Min.	Box
2421002	Frajon® AAV	1	12

NEW!



- ASSE approved Frajon® valves may be used in commercial, residential, and industrial buildings for individual, common, branch, and circuit vents.

- Rated up to 160 DFU's

- Designed for horizontal branch and vertical stack applications.

SINK SPECIALTIES



**W-R AERATOR
COUNTER DISPLAYS
- LEAD FREE -**



W-R#	Description	GPM	Count
4301001	M x F	2.2	144
4301003	Slotted M x F	2.2	144
4301020	Slotted Bubblestream®	2.0	120

- All dual-thread aerators are 15/16M x 55/64F



**SPRING-FLO® 38D
COUNTER DEALS
- LEAD FREE -**



W-R#	Description	GPM	Count
4307002	38D Display	2.2	144



**AERATOR TUBES
- LEAD FREE -**



W-R#	Description	GPM	Count
4301005	M x F	2.2	6
4301007	Slotted M x F	2.2	6
4301009	M x F Bubblestream®	2.0	6
4301030	Lo-Flo M x F	0.5	6
4301032	Lo-Flo M x F	1.0	6
4301034	Lo-Flo M x F	1.5	6

- All dual-thread aerators are 15/16M x 55/64F



**DUAL-THREAD
AERATORS
- LEAD FREE -**



W-R#	Description	GPM	Box
4305004	Standard CP	2.2	25
4305204	Slotted CP	2.2	25
4309500	Lo-Flo CP	0.5	25
4309400	Lo-Flo CP	1.0	25
4309000	Lo-Flo CP	1.5	25

**MADE IN USA
DUAL-THREAD
AERATORS
- LEAD FREE-**



W-R#	Description	GPM	Box
4305002	Standard CP	2.0	25

- All dual-thread aerators are 15/16M x 55/64F

SINK SPECIALTIES



FEMALE AERATORS
- LEAD FREE -

W-R#	Size	GPM	Box
4301002	55/64" Female	2.0	25
4304002	13/16" Female	2.0	25



MALE AERATORS
- LEAD FREE -

W-R#	Size	GPM	Box
4302002	15/16" Male	2.0	25
4303002	13/16" Male	2.0	25



CP SWIVEL AERATORS
- LEAD FREE -

W-R#	Description	GPM	Box
4306002	M x F Swivel	2.5	12



- All dual-thread aerators are 15/16M x 55/64F
- 2.0 GPM



CP SWIVEL/SPRAY AERATOR
- LEAD FREE -

W-R#	Description	Box
4301004	M x F Swivel/Spray	12



- Pull-down swivel & spray
- All dual-thread aerators are 15/16M x 55/64F



SNAP COUPLING WITH AERATOR
- LEAD FREE -

W-R#	Description	Box
4311002	Small Pattern	12
4311004	Large Pattern	12



- Snap aerator and Snap hose coupling combine to provide water source for portable washing machines & dishwashers.



CHROME-PLATED DISHWASHER AERATOR
- LEAD FREE -

W-R#	Description
------	-------------

4310002 M x F Snap Aerator
- For use with portable dishwasher and washing machines, or as an aerator. Fits G.E., Kitchen Aid, Westinghouse.



4310004 M x F Large Snap Aerator
-Large diameter nipple fits Frigidaire, Hotpoint, KitchenAid, Maytag, Sears, Speed Queen, Wards, Waste King, Westinghouse.



SNAP COUPLINGS

W-R#	Description	Box
2324002	Small Coupler	12
2324004	Large Coupler	12

- Brass hose snap coupler with 3/4" male hose thread.

SINK SPECIALTIES



**CP COMBINATION
SNAP NIPPLE**
- LEAD FREE -



W-R#	Description	Box
4318002	M x F Snap Nipple	12

• For use with portable dishwasher. Small diameter, fits snap coupler #2324002. Non-aerating.



**CP WATER FILTER
DIVERTER AERATORS**
- LEAD FREE -



W-R#	Description	Box
4609004	1/4" Single barb	12
4609006	3/8" Single barb	12

- Water filter aerators are 55/64F



2313003



2313002



2323002



2312002



2313005



2326002

AERATOR ADAPTERS
- LEAD FREE -

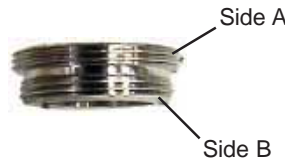

W-R#	Side A	Side B	Box
4313003	3/4" F	15/16" M	12
4313002	15/16" M	55/64" M	12
4323002	3/4" FH	15/16" M	12
2312002	55/64" F	3/4" MH	12 *
4313005	15/16" M 55/64" F	3/4" MH	12
2326002	15/16" M	3/4" MH	12 *

* For non-potable use only

SINK SPECIALTIES



**“CROWN-RINSE”
SPRAY HEADS**

W-R#	Description	Min	Box
1654000	Black	1	12
1654001	White	1	12
1654005	Chrome	1	12

- All “Crown-rinse” products are individually boxed



**“CROWN-RINSE”
HOSE & SPRAY
ASSEMBLIES**

W-R#	Description	Min	Box
1656000	Black	1	12
1656007	Black - Delta	1	12
1656001	White	1	12
1656005	Chrome	1	12

- All “Crown-rinse” products are individually boxed
 - Standard Hose/Spray is furnished with 1/8” F x 1/4”F adapter
 - Delta H/S furnished with 1/2” Female Swivel



**“CROWN-RINSE”
REPLACEMENT HOSES**

W-R#	Description	Min	Box
1655000	48” Hose Only	1	12



**“CROWN-RINSE”
HOSE GUIDES**

W-R#	Description	Min	Box
1658002	Black Guide	1	12
1658004	White Guide	1	12



**LIQUID SOAP
DISPENSER**

W-R#	Description	Min	Box
1645500	Dispenser	1	12
1645504	Head Only	1	1
1645506	Bottle Only	1	1



**LAUNDRY TRAY FAUCET
MOUNTING BLOCKS**

W-R#	Description	Min	Box
1619004	Block	1	12

- Furnished with washers & screws

SINK SPECIALTIES

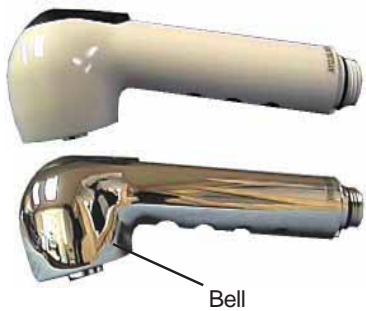

REPLACEMENT PULL-OUT FAUCET SPRAY HEADS

W-R#	Description	Finish	Min	Box
1652006	Bell	White	1	6
1652008	Bell	Chrome	1	6

- OEM ref# 89-081, 051022-002, 75167
- Individually boxed



AERATOR FOR PULLOUT SPRAY

W-R#	Description	Min	Box
1652010	Aerator for Pullout Spray	1	1



REPLACEMENT PULLOUT SPRAY HOSE

W-R#	Description	Min	Box
1652012	59" Replacement Pullout Hose	1	1



WEIGHT FOR PULLOUT SPRAY HOSE

W-R#	Description	Min	Box
1652014	Weight for Pullout Hose	1	1



CERAMIC CARTRIDGE FOR PULLOUT FAUCET



W-R#	Description	Min	Box
1652020	35mm Ceramic Cartridge	1	1

- Fits 92-298



CP LOOP HANDLE FOR PULLOUT FAUCET

W-R#	Description	Min	Box
1652030	CP Loop Handle	1	1

WASHING MACHINE HOSES



**3/8" ID
DOUBLE FEMALE
WASHING MACHINE
HOSE - BAGGED**

BAGGED#	SIZE	Min	Box
0802002	3/4" FHT x 4'	1	25
0802004	3/4" FHT x 5'	1	25
0802006	3/4" FHT x 6'	1	25
0802008	3/4" FHT x 8'	1	25
0802010	3/4" FHT x 10'	1	25
0802012	3/4" FHT x 12'	1	25

- Individually bagged hoses are furnished with washers

- Bagged hoses conform to the following:
 - 200 psi working pressure
 - 800 psi bursting
 - Up to 200°F



**1/2" ID HIGH-CAPACITY
WASHING MACHINE
HOSE - BAGGED**

BAGGED#	SIZE	Min	Box
0802504	3/4" FHT x 4'	1	25
0802505	3/4" FHT x 5'	1	25
0802506	3/4" FHT x 6'	1	25
0802508	3/4" FHT x 8'	1	25
0802512	3/4" FHT x 12'	1	25

- Individually bagged hoses are furnished with washers
- Premium *GOODYEAR* Horizon™ Nylon-reinforced hose
- 200 psi working pressure - 200°F rating



"Y" HOSE MIXER

W-R#	SIZE	Min	Box
0805003	Bagged	1	25

- Inlet branches are FHT, outlet is MHT
- Bagged "Y"-mixer contains washers



**STAINLESS STEEL
WASHING MACHINE
CONNECTORS**

W-R#	Description	Box
WM-4	3/4" FH X 3/4" FH X 4'	10
WM-5	3/4" FH X 3/4" FH X 5'	10
WM-6	3/4" FH X 3/4" FH X 6'	10

- Individually bagged with washers



WASHING MACHINE HOSES



WASHING MACHINE DISCHARGE HOSE - STANDARD -

Regular	SIZE	Min
0807002	5/8" ID x 50'	1 coil
0807006	7/8" ID x 50'	1 coil
0807008	1" ID x 50'	1 coil



WASHING MACHINE DISCHARGE HOSE - REINFORCED -

Reinforced	SIZE	Min
0808002	5/8" ID x 50'	1 coil
0808006	7/8" ID x 50'	1 coil
0808008	1" ID x 50'	1 coil



ALUMINUM HOOK FOR WASHING MACHINE DISCHARGE HOSE

W-R#	SIZE	Min	Box
0806004	1" Hook	1	12



HOOK HOSE FOR WASHING MACHINE DISCHARGE

W-R#	SIZE	Min	Box
0807010	5' Hose	1	12

- Gray corrugated tubing
- Molded Adapter for Washing Machine connection. Step down 3/4", 7/8" & 1"



DISHWASHER DISPOSAL CONNECTION

W-R#	SIZE	Min	Box
1677002	Connection	1	50

- Improved connector with 2 stainless steel worm gear hose clamps



TWIN MIX CONNECTION

W-R#	SIZE	Min	Box
0818002		1	12

- For installation of portable washing machines



ALUMINUM LINT SNARE

W-R#	SIZE	Min	Box
0527600	Fits 1" ID	1	12

- Furnished with nylon tie.
- Roll over the end of discharge hose to prevent drain blockage from lint discharge.

HOSES & HOSE SPECIALTIES



CLEAR VINYL TUBING

W-R#	I.D.	O.D.	Length
0809000	1/8"	3/16"	100'
0809001	1/8"	1/4"	100'
0809002	1/4"	3/8"	100'
0809004	5/16"	7/16"	100'
0809006	3/8"	1/2"	100'
0809008	1/2"	5/8"	100'
0809010	5/8"	7/8"	100'
0809012	3/4"	1"	50'
0809014	1"	1 1/4"	50'

ICE-MAKER TUBING

W-R#	I.D.	O.D.	Length
0809020	1/8"	1/4"	100'

- Bulk ice-maker tubing



**BRASS INSERT STIFFENER
- LEAD FREE -**



W-R#	SIZE	Min	Box
4A00119	1/4" Insert	25	25
4022002	3/8" Insert	25	25
4022004	1/2" Insert	25	25



HOSE CLAMPS



CARBON	STAINLESS	SAE	Min.	Max.
2208004	2209004	#4	1/4"	5/8"
2208006	2209006	#6	3/8"	7/8"
2208008	2209008	#8	7/16"	1"
2208010	2209010	#10	1/2"	1 1/16"
2208012	2209012	#12	1/2"	1 1/4"
2208016	2209016	#16	3/4"	1 1/2"
2208020	2209020	#20	3/4"	1 3/4"
2208024	2209024	#24	1"	2"
2208028	2209028	#28	1 5/16"	2 1/4"
2208032	2209032	#32	1 9/16"	2 1/2"
2208036	2209036	#36	7/8"	2 3/4"
2208040	2209040	#40	1 1/8"	3"
2208052	-	#52	1 7/8"	3 3/4"
2208072	-	#72	3 1/8"	5"
2208088	-	#88	5 1/8"	6"

- 10 per box

HOSES & HOSE SPECIALTIES



3/4" FHT HOSE CAP

W-R#		Min	Box
2607002	Brass	12	12
4607002	Lead-Free Brass	12	12
2606002	Brass Plated	12	12
2605002	Plastic	12	12

- Brass hose caps furnished with washer



3/4" FHT HOSE CAP WITH CHAIN

W-R#		Min	Box
2607004	Brass	1	12
4607004	Lead-Free Brass	1	12

- Furnished with washer and 6" chain



HOSE NIPPLES

SIZE	Lead Free#	Non-potable#
3/4" MH x 3/4" MIP	4610002	2610002
3/4" MH x 1/2" MIP	4610004	2610004
3/4" MH x 3/4" MH	4610006	2610006
3/4" MH x 1/2" MIP x 1/2" SWT	4610008	2610008
3/4" MH x 3/4" MIP x 1/2" FIP	4610010	2610010



SIZE	Lead Free#	Non-potable#
3/4" MH x 3/4" FIP	4610012	2610012
3/4" MH x 1/2" FIP	4610014	2610014



Call 800-221-1157 to check availability for "261-" series brass hose nipples for non-potable use only.

SIZE	Lead Free#	Non-potable#
3/4" FH x 3/4" FIP	4610016	2610016
3/4" FH x 1/2" FIP	4610018	2610018
3/4" FH x 3/4" FH	4610020	2610020



SIZE	Lead Free#	Non-potable#
3/4" FH x 1/2" MIP	4610028	2610028
3/4" FH x 3/4" MIP	4610030	2610030
3/4" FH x 1/2" MIP x 1/2" SWT	4610032	2610032

SWIVEL HOSE NIPPLES

SIZE	Lead Free#	Non-potable#
3/4" FH x 3/4" FIP	4610022	2610022
3/4" FH x 1/2" FIP	4610024	2610024
3/4" FH x 3/4" FH	4610026	2610026



- All hose nipples are 12 per bag

HOSES & HOSE SPECIALTIES



RUBBER HOSE WASHERS

W-R#		Min	Box
2724002	Bulk	100	100
2724004	10 to clip	36 clips/box	



INLET HOSE FILTER SCREEN

W-R#		Min	Box
0533002		25	25



SIAMESE 3/4" HOSE CONNECTION WITH SHUT OFF

W-R#		Min	Box
2601002	Die Cast	1	12
2603003	All Brass	1	12

- For outdoor watering use



3/4" SIAMESE CONNECTION

W-R#		Min	Box
2602002	Die Cast	1	12
2603002	Brass	1	12

- For outdoor watering use



FROST PROOF SILLCOCK

W-R#		Min	Box
0407502	6"	1	12
0407504	8"	1	12
0407506	12"	1	12

- For outdoor watering use



HOSE BIBB MOUNTING PLATE



W-R#		Min	Box
0623602	Mounting Plate	1	12

- Zinc-plated steel plate to cover annular space around hose bibbs and sillcocks.
- Mounting hardware included



3/4" HOSE VACUUM BREAKER - LEAD FREE-



W-R#		Min	Box
4418000	3/4"	1	12

- With break-off set screw
- FH x MH connection

HOSES & HOSE SPECIALTIES



**VANDAL-PROOF
QUARTER-TURN
SILLCOCKS**

W-R#		Min	Box
0404002	1/2" IPS	1	12
0404006	1/2" SWT	1	12

- For outdoor watering use



**"HOSE-MATE"
SILLCOCK RETROFIT
VALVE -LEAD FREE -**



W-R#		Box
RV900LF	3/4 FH Swivel x MH	6

The RV900 "Hose-Mate" is a rugged, machined-brass solution for frozen sillcocks or other hose connections.



**DIE CAST
VALVE HANDLE**

W-R#		Min	Box
0420002	Square	1	12
0420004	Round	1	12

- 12 pt



SILLCOCK KEY

W-R#		Min	Box
0421002	5/16"	1	12
0421000	1/4"	1	12



4-WAY SILLCOCK KEY

W-R#		Min	Box
0421004		1	12

- Fits stems 1/4", 9/32", 5/16" and 11/32"



**STOP AND WASTE
CAPS**

With washer

W-R#		Min	Box
0419006	5/16"	10	10
0419008	3/8"	10	10



**FIRE HYDRANT TO
3/4"MH ADAPTER**

W-R#		Min	Box
2604002	2 1/2" Hydrant	1	-



**"BIBBLOCK" HOSE
BIBB LOCKOUT**

W-R#		Min	Box
2607500	"Bibblock"	1	-

- Eliminates unauthorized use of water!
- Vandal-proof design!
- Lock sold separately.

HOSES & HOSE SPECIALTIES



5/8" GARDEN HOSES



W-R#		Min	Box
1803000	50' Tire Cord	1	5
1803002	50' Rubber/Vinyl	1	5
1803006	50' Premium	1	5
1803008	25' Premium	1	5

- Premium Rubber Hoses 1803006 & 8 rated for temperatures up to 180°



9-SPRAY PISTOL GRIP HOSE NOZZLE

W-R#	
2609502	7" 9-Pattern Spray

- Durable Metal Construction
- Insulated Handle Grip for hot & cold applications
- Soft Cushioned Grip



INSULATED PISTOL GRIP HOSE NOZZLE

W-R#	
2609702	Heavy-Duty Insulated

- Solid Metal Body
- Insulated Handle Grip for hot & cold applications
- Nylon Handle



BRASS TWIST HOSE NOZZLE

W-R#	
2609602	7" Brass Twist Nozzle

- Durable Metal Construction
- Insulated Handle Grip for hot & cold applications
- Soft Cushioned Grip



C.P. ECONOMY PISTOL GRIP HOSE NOZZLE

W-R#	Min	Box
2609002	1	12



4" BRASS HOSE NOZZLE

W-R#	Min	Box
2608002	1	12

HOSES & HOSE SPECIALTIES



WATER HAMMER ARRESTERS
- LEAD FREE -



W-R#		Min	Box
4320002	1/2" MIP	1	12
4320004	1/2" Sweat	1	12

- rated to 200 psi



WATER HAMMER ARRESTER TEES
- LEAD FREE -



W-R#	Description	Min
4320010	1/4" OD X 1/4" OD	1
4320012	3/8" OD X 3/8" OD	1
4320014	5/8" OD X 5/8" OD	1

W-R#	Description	Min
4320016	1/2" PEX x 1/2" PEX	1

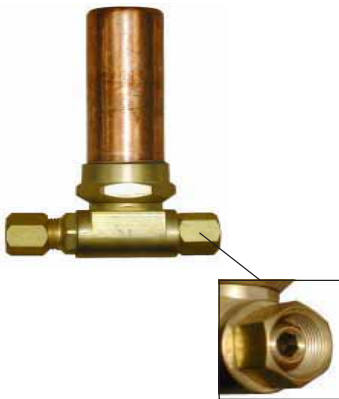

WATER HAMMER COMPRESSION *RETROFIT* TEES
- LEAD FREE -



W-R#	Description	Min
4320020	3/8" OD X 3/8" Female Compression	1

3/8" OD Female connection to fit existing stops



WATER HAMMER ARRESTER FOR WASHING MACHINE
- LEAD FREE -



W-R#	Description	Min
4320030	3/4" FH X 3/4" MH	1

3/4" MH

HOSES & HOSE SPECIALTIES

SEWAGE EJECTOR CHECK VALVE



W-R#		Min	Box
0414204	1½" I.P.S.	1	24
0414206	2" I.P.S.	1	24
0414208	1 1/2" x 1 1/4"	1	24
0414210	3" w/Cast Iron Body	1	24



COMPRESSION SEWAGE EJECTOR CHECK VALVE

W-R#		Min
0414606	2" Compression	1



"SILENT-CHECK" SEWAGE EJECTOR CHECK VALVE

W-R#		Min
0414302	1 1/2" Silent Check	1
0414304	2" Silent Check	1



NEW!

W-R#		Min
0414706	2" Silent Check -Compression-	1



W-R#		Min
0414806	2" Silent Check -True Union-	1

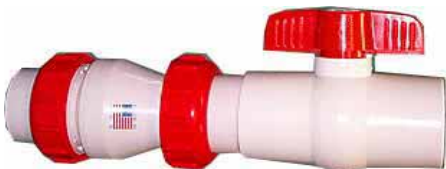

W-R#		Min
0414812	2" Silent Check -True Union- with Ball Valve	1

HOSES & HOSE SPECIALTIES



SUMP PUMP DRAIN HOSE KIT



W-R#		Min	Box
0810002	1 1/4" X 24'	1	8
0810004	1 1/2" X 24'	1	6
0810010	1 1/2" MIP X 1 1/4" Adapter	1	12

• Included in kit are 24' corrugated plastic hose. 1 1/4" plastic male adapter and stainless clamp, individually packaged.



GAS RANGE CONNECTOR ADAPTER



W-R#		Min	Box
0814102	5/8" Flare x 1/2" FIP		25
0814104	5/8" Flare x 3/4" FIP		25
0814106	5/8" Flare x 1/2" MIP		25
0814108	5/8" Flare x 3/4" MIP		25



STAINLESS STEEL GAS RANGE CONNECTOR

Yellow Epoxy Coated



W-R#		Min	Box
0813004	1/2" x 24"	1	12
0813008	1/2" x 36"	1	12
0813012	1/2" x 48"	1	12
0813014	1/2" x 60"	1	12
0813016	1/2" x 72"	1	12



CSA GAS BALL VALVES



W-R#	Description	Min	Box
0400120	1/2"	12	12
0400122	3/4"	12	12

HOSES & HOSE SPECIALTIES



4" x 8 FOOT DRYER VENT KITS



W-R#	Hose	Hood	Ctn
0811106	Lamaflex®	Plastic	8
0811102	Lamaflex®	Metal	8
0811104	Aluminum	Plastic	8
0811108	Aluminum	Metal	8

Hose Types:
 "Lamaflex" = Laminated aluminum ducting
 "Aluminum" = corrugated flexible aluminum



DRYER VENT HOSE



W-R#	Size	Hose	Ctn
0812001	4" x 8'	Lamaflex®	10
0812007	4" x 20'	Lamaflex®	6
0812005	4" x 50'	Lamaflex®	1
0812003	4" x 8'	Aluminum	10



REPLACEMENT HOOD ONLY



W-R#	Size	Ctn
0811005	4" White Plastic	6
0812010	4" Metal	6



4" VENT HOSE COUPLING



W-R#	Size	Ctn
0812020	4"	6



DRYER VENT CLAMP



W-R#	Size	Ctn
0812008	4"	12



LINT TRAP INDOOR DRYER VENT KIT



W-R#	Size	Ctn
0811012	Lamaflex® Hose	12

- 4" x 5' hose
 - For use on electric dryers only

HOSES & HOSE SPECIALTIES



PLASTIC ICE MAKER KITS
- LEAD FREE-



W-R#		Min	Box
4816002	Deluxe	1	24

- Contains valve, compression elbow, and extra fittings.

W-R#		Min	Box
4816004	Economy	1	24

- Valve with 3/8" O.D. coupling.



COPPER ICE MAKER KITS
-LEAD FREE-



W-R#		Min	Box
4816006	15 Foot	1	36
4816008	25 Foot	1	36

- Contains compression elbow, and extra fittings to cover every installation contingency.



STAINLESS STEEL ICE MAKER KITS
-LEAD FREE -



W-R#		Min	Box
4816504	6 Foot	1	36
4816500	10 Foot	1	36
4816502	20 Foot	1	36

- Contains self tapping saddle valve.



ADAPTER KIT FOR NEW STYLE ICE MAKER
- LEAD FREE -



W-R#		Box
4816010	1/4"OD x 3/4 FHT	6



SELF-TAPPING SADDLE VALVES
- LEAD FREE -



W-R#	Description	Min	Box
4415004	Hollow Needle	1	50
4415002	Solid Needle	1	50

- Connects 1/4" ice makers & water filters to copper tubing from 3/8" to 1 3/8".

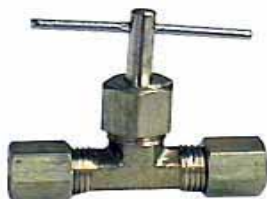

NEEDLE VALVES
- LEAD FREE -



W-R#	Description	Min	Box
4415006	1/4" OD X 1/4" OD	1	12
4415008	3/8" OD X 3/8" OD	1	12

HOSES & HOSE SPECIALTIES



WATER FILTRATION PRODUCTS

W-R#	Description	Box
0590002	10" Nylon-Wound	12
0590004	10" Poly-Groove	12

- 5 Micron filters
- Protects against rust, sediment, silt & rust



SINGLE-LEVER WASHING MACHINE VALVE BOXES



W-R#	Description	Min	Box
0431006	Single Lever	1	10

- Sweat Connection



1/4 TURN BALL VALVE WASHING MACHINE BOX



W-R#	Description	Min	Box
0431008	1/4 Turn Valves	1	10

- PVC Box with nailing brackets
- 1/4 Turn Brass Ball Valves
- IPS x SWT Connections



1/4 TURN STOP ICE-MAKER BOX - LEAD FREE -



W-R#	Description	Min	Box
4430006	1/4 Turn Stop	1	10

- PVC Box with nailing brackets
- 1/4 Turn Compression Stop
- IPS x SWT Connection



SNAP-IN PLASTIC ACCESS PANELS

W-R#	Description	Min	Box
2213002	6" X 9"	1	12
2213004	8" X 8"	1	12
2213006	14" x 14"	1	12

**CROWN "JEWEL" PRERINSE
FAUCET PARTS**

**SPRAY VALVE
ASSEMBLY**



W-R#	Description	Min.	Box
CJ001	Spray Valve	1	1
<ul style="list-style-type: none"> - Heavy pattern - Chrome-plated brass body - Plastic handle - Individually boxed - Comparable to OEM# B-107 			

**REPLACEMENT
BONNET ASSEMBLY
FOR PRE-RINSE**



W-R#	Description	Min.	Box
CJ003	Bonnet	1	1
<ul style="list-style-type: none"> - Heavy pattern CP brass - Comparable to OEM#2856-40 - Individually bagged 			

**REPLACEMENT HOSE
FOR PRE-RINSE**



W-R#	Description	Min.	Box
CJ101	44" Hose	1	1
<ul style="list-style-type: none"> - Flexible Stainless Steel Hose - Heavy duty black plastic handle - Comparable to OEM# B-0044-H 			

**REPLACEMENT
HANDLES FOR
PRE-RINSE**



W-R#	Description	Min.	Box
CJ302	fits Eterna	1 pr.	1
<ul style="list-style-type: none"> - Furnished with index buttons - Comparable to OEM# 1636-45 & 1637-45 			

**REPLACEMENT STEM
& BARREL FOR
PRE-RINSE
- LEAD FREE -**



W-R#	Description	Min.	Box
CJ401HLF	Hot	1	1
- Comparable to OEM# 788-20/811-25			
CJ401CLF	Cold	1	1
- Comparable to OEM# 789-20/812-25			

**REPLACEMENT
SPINDLE ASSEMBLY
FOR PRE-RINSE
- LEAD FREE -**



W-R#	Description	Min.	Box
CJ500HLF	Hot	1	1
- Comparable to OEM# 2714-40			
CJ500CLF	Cold	1	1
- Comparable to OEM# 2713-40			

STRAINERS & DRAINS



**HEAVY DUTY CP
CAST BRASS
DUO STRAINER**

W-R#	Description	Min.	Box
0515004	CP Brass Duo	1	50

- Extra heavy cast brass construction with a mirror finish chrome plate. This is a top quality strainer, utilizing a machined, chrome plated brass seat, for a superior seal.
- Similar to KOHLER strainer.



**ECONOMY BRASS
DUO STRAINER**



W-R#	Description	Min.	Box
0515020	Economy Brass	1	50

- 4½" dia. to fit 3½" drilling. Regular pattern.
- Zinc die cast locknut.



**STAINLESS STEEL
DUO STRAINER**

W-R#	Description	Min.	Box
0515002	S.S. Duo	1	50

- 4½" dia. to fit 3½" drilling. Regular pattern.
- Zinc die cast locknut.



**DEEP-CUP STAINLESS
STEEL DUO STRAINER**

W-R#	Description	Min.	Box
0515006	Deep Cup Duo	1	50

- Die cast nuts
- Regular "plug&pin" stopper

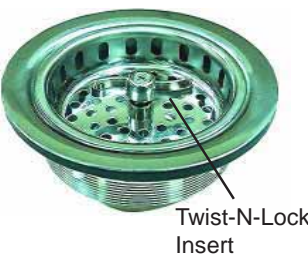

**"TWIST-AND-LOCK"
STAINLESS STEEL
DUO STRAINER**

W-R#	Description	Min.	Box
0515008	Twist-N-Lock	1	50

- 4½" dia. to fit 3½" drilling.
- Basket threads into base of strainer to create a more positive seal

STRAINERS & DRAINS



REPLACEMENT BASKET STRAINER WITH CP BRASS STOPPER

W-R#	Description	Min.	Box
0518500	Fits Am. Std.	1	50



REPLACEMENT BASKET STRAINER WITH SINGLE-PRONG

W-R#	Description	Min.	Box
0519002	Single-prong	1	50



REPLACEMENT BASKET STRAINER WITH RUBBER STOPPER

W-R#	Description	Min.	Box
0517002	Plastic Pin	1	50



DUO STRAINER WASHER

W-R#	Description	Min.	Box
2713002	Rubber	25	25
2713004	Metal	12	12

- 4 3/8" x 3 3/8"



DUO STRAINER LOCKNUT

W-R#	Description	Min.	Box
0907002	Die Cast Nut	1	12



CHROME-PLATED LARGE FLAT SINK PLUG

W-R#	Description	Min.	Box
0513002	Sink Plug	1	50

- 4 1/2" diameter
- fits 1 7/8" drilling



DUPLEX SINK STRAINER WITH GRID

W-R#	Description	Min.	Box
0508002	CP Brass	1	12
0509002	Stainless Steel	1	12

DUPLEX WASH TRAY PLUG WITH STOPPER

W-R#	Description	Min.	Box
0511002	CP Brass	1	12
0512002	Stainless Steel	1	12

- 2 7/8" dia. to fit 1 7/8" drilling.

STRAINERS & DRAINS



STAINLESS STEEL JUNIOR DUO STRAINER

W-R#	Description	Min.	Box
0505002	Jr. Duo	1	12
• 2 ⁷ / ₈ " dia. to fit 1 ⁷ / ₈ " drilling			



DEEP BASKET JUNIOR DUO STRAINER

W-R#	Description	Min.	Box
0505004	Deep Jr. Duo	1	12



REPLACEMENT BASKET FOR JUNIOR DUO

W-R#	Description	Min.	Box
0506002	Jr. Duo Basket	1	12
0505003	Deep Jr. Duo Basket (2")	1	12



3" LONG SHANK BRASS SINK PLUG

W-R#	Description	Min.	Box
0506500	3" Brass Plug	1	5
• 3"OD x 1 ¹ / ₂ "ID x 3" long			
• Ideal for old cast iron installations			
• Furnished with locknut & rubber washer			



1" BRASS BAR PLUG

W-R#	Description	Min.	Box
0504002	1 1/2"	1	6
0504006	1 1/2" w/tail	1	6
0504004	3"	1	6
0504008	3" w/tail	1	6



1"OD TAIL FOR BAR PLUG

W-R#	Description	Min.	Box
0504102	1"OD x 2"	1	6



CAST IRON SINK COLLARS

W-R#	Description	Min.	Box
0509500	2"ID	1	12
- 3 1/2" between centers			

STRAINERS & DRAINS



**BRASS
POP-UP WASTE
ASSEMBLY**

W-R#	Description	Min.	Box
1405002	Chrome	1	25
1405003	Polished Brass	1	25



**CHROME-PLATED
CAST BRASS
GRID DRAIN**

W-R#	Description	Min.	Box
0512500	1 1/4" Grid Drain	1	25

- 1 1/4" X 4", 20 gauge tailpiece



**CHROME-PLATED
CAST BRASS
OFFSET
1 1/4" GRID DRAIN**

W-R#	Description	Min.	Box
0512508	Offset	1	25

- Cast Brass strainer & elbow
- 17 gauge offset tubular brass tailpiece



**CHROME-PLATED
TUBULAR
TRAP PRIMER
TAILPIECES**

W-R#	Description	Box
0117202	1 1/4" X 8" Fine Thread	25
0117204	1 1/2" X 8" Direct Connect	25

- 17 gauge tubular brass
- One piece construction
- Meets Dade County building code



**CHROME-PLATED CAST
BRASS P.O. PLUG**

W-R#	Description	Min.	Box
0503000	1 1/4" PO Plug	1	12

- 4" 20 gauge tailpiece
- P.O. plugs have overflow holes

STRAINERS & DRAINS



One-piece



Two-piece

**CHROME-PLATED
TUBULAR BRASS
P.O. PLUG**

Size	One-Piece	Two-Piece
1 1/4"x12"	0501006	0502006

- Chrome-plated tubular brass
- P.O. plugs have overflow holes



**CHROME-PLATED
TUBULAR BRASS
C.O. PLUG**

W-R#	Description	Min.	Box
0503002	1 1/4" CO Plug	1	12

- Chrome-plated tubular brass
- C.O. plugs do not have overflow holes



MACK WASHER

W-R#	Description	Min.	Box
2719002	1 1/4" Basin	12	12
2719004	1 1/2" Bath	12	12



**NICKEL-PLATED STEEL
KETCHALL STRAINER**

W-R#	Description	Size	Min.
0528002	Sink	1 7/8"	10
0528004	Basin	1 1/4"	10
0528006	Wash Tray	1 1/2"	10



**KETCHALL SINK
STRAINER WITH POST**

W-R#	Description	Size	Min.
0528008	Sink w/post	1 7/8"	10



**STAINLESS STEEL
MESH STRAINER**

W-R#	Size	Min.	Box
0529502	4 1/2"	10	10
0529504	2 3/4"	10	10
0529506	2 1/2"	10	10



DRAIN PROTECTOR

W-R#	Size	Min.	Box
0532002	3" Perforated Steel Strainer	12	12

STRAINERS & DRAINS



**CHROME-PLATED STEEL
FLAT STRAINERS**

W-R#	Size (OD)	Min.	Box
0525004	1 1/2"	10	10
0525006	1 5/8"	10	10
0525010	2"	10	10
0525012	2 3/4"	10	10



**CHROME-PLATED STEEL
THREE-PRONG
STRAINERS**

W-R#	Description	Min.	Box
0526002	1 5/8"	12	12
0526004	1 7/8"	12	12



**CHROME-PLATED STEEL
SHOULDER STRAINER**

W-R#	Description	Min.	Box
0527004	2 3/4" x 1/4"	12	12



**YELLOW PVC TAILPIECE
CHECKVALVE**

W-R#	Description	Min.	Box
0414502	PVC Checkvalve	1	24

- Fits 1 1/2" Tailpiece
- Used to prevent backflow into sink from dishwashers, etc.

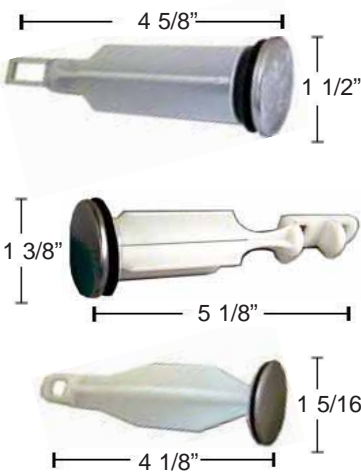

**LAVATORY POP-UP
STOPPERS**

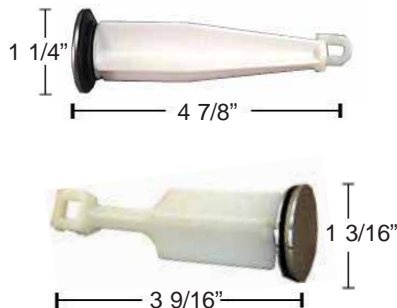

W-R#	Description	Top	Length
1304718	American Standard	1 1/2"	4 5/8"
1673006	Delta	1 3/8"	5 1/8"
1304716	Gerber	1 5/16"	4 1/8"
1304714	Moen	1 1/4"	4 7/8"
1304720	Pr.-Pfister	1 3/16"	3 9/16"

STRAINERS & DRAINS



**CHROME-PLATED
SHOWER STALL
STRAINER**

W-R#	Description	Min.	Box
0522002	1 1/2" Die Cast	1	12
0522004	1 1/2" Brass	1	12
0522006	2" Die Cast	1	12
0522008	2" Brass	1	12



**GALVANIZED RUNNING
THREAD NIPPLES**

W-R#	Description	Min.	Box
0623000	2" x 6"	1	12
0910002	2" Wide Flange Brass Locknut	1	12



**CHROME-PLATED
BRASS URINAL
STRAINER**

W-R#	Description	Min.	Box
0521002	2" IPS	1	24
0521004	2" DWV	1	24



**EXTRA-LONG BRASS
URINAL/SHOWER
STRAINER**

W-R#	Description	Min.	Box
0521020	2" IPS	1	24

- For use on extra-thick mud/tile jobs
- Overall spud length of 2 1/2"



**CHROME-PLATED
SHOWER STALL GRID**

W-R#	Description	Min.	Box
0530002	3 1/2" OD	12	12

- fits urinal strainers
- 2 3/4" between holes



**NO-CAULK SHOWER
DRAINS WITH
STAINLESS-STEEL GRID**

W-R#	Description	Min.	Box
0523004	2" Brass	1	24
0523005	2" PVC	1	24

- Includes jiffy joint, locking ring, & wrench



Includes locking ring & wrench

STRAINERS & DRAINS



2" PVC SHOWER DRAINS

W-R#	Connection	Grid	Min.	Box
0523002	Jiffy Joint	PVC	1	24
0523030	Jiffy Joint	S.S.	1	24
0523031	Solvent	S.S.	1	24



PVC TWO-PIECE SHOWER STALL DRAINS

W-R#	Description	Min.	Box
0523040	2" Sch.40	1	12

- Connection: 2"
- Grid Diameter: 4 1/4"
- Height: 3"



PVC GENERAL PURPOSE DRAINS

W-R#	Description	Min.	Box
0523050	2" Sch. 40	1	12
0523052	3" Sch. 40	1	12

0523050: 4 1/4"OD x 2" H
0523052: 5 3/16"OD x 2 1/4" H



SHOWER PAN LINER DRAIN WITH HEAVY CHROME-PLATED BRASS STRAINER

W-R#	Description	Min.	Box
0523014	2" Solvent	1	12



SHOWER PAN LINER DRAIN WITH STAINLESS STEEL STRAINER - STANDARD -

W-R#	Description	Min.	Box
0523000	2" Solvent	1	12



SHOWER PAN LINER DRAIN WITH STAINLESS STEEL STRAINER - LOW PROFILE -

W-R#	Description	Min.	Box
0523007	2" Solvent	1	12
0523006	2" Jiffy Joint	1	12

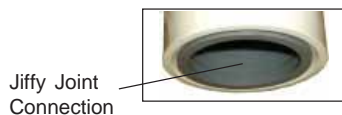

Jiffy Joint Connection

STRAINERS & DRAINS



HEAVY CHROME-PLATED BRASS SHOWER STRAINER GRID

W-R#	Description	Min.	Box
0523022	CP Brass	1	12
- Fits 0523012 & 0523014			



REPLACEMENT SNAP-IN GRID FOR SHOWER DRAINS

W-R#	Description	Min.	Box
0523032	Stainless Steel	1	12
- 4" OD			



JIFFY JOINT FOR SHOWER DRAINS

W-R#	Description	Min.	Box
0523010	2" IPS	1	12



STAINLESS STEEL FLOOR DRAIN COVERS

W-R#	Description	Min.	Box
0541002	2" Floor Drain	1	12
0541004	3" Floor Drain	1	12
0541006	4" Floor Drain	1	12



GALVANIZED STEEL CESSPOOL PLATES

W-R#	Description	Min.	Box
2210006	6" x 6"	1	10
2210008	8" x 8"	1	10
2210010	10" x 10"	1	10
2210012	12" x 12"	1	10



GALVANIZED FLOODSTOPPER

W-R#	Description	Min.	Box
2535004	3" Floor Drain	1	12
2535006	4" Floor Drain	1	12



WASTES & DRAINS



**BRASS
SWIVEL TRAPS
L.A. PATTERN**

W-R#	Size	Finish	Cleanout?
1212002	1 1/2" x 1 1/4"	RB	Less C/O
1212004	1 1/2" x 1 1/4"	RB	With C/O
1212010	2" x 1 1/2"	RB	With C/O
1212000	1 1/2"	RB Sweat	Less C/O
1212006	1 1/2" x 1 1/4"	CP	Less C/O
1212008	1 1/2" x 1 1/4"	CP	With C/O



**N.Y. REGULATION
TRAP**

W-R#	Size	Finish	Cleanout?
1214004	1 1/2"	CP	With C/O
1214006	2 x 1 1/2"	RB	With C/O



SWING TEE TRAP

W-R#	Size	Finish	Cleanout?
1216002	2" x 1 1/2"	RB	With C/O



**CAST LOW-SEAL BATH
TRAP**

W-R#	Size	Finish
1215002	1 1/2" IPS	Galvanized
1215004	2" IPS	Galvanized



**BRASS TRAP
CLEANOUT PLUG**

W-R#	Size	Finish	Min	Box
1217006	1 1/4"	CP	1	12

- Fits most cast brass LA & NY regulation traps



**BRASS TUBULAR
"P" TRAPS**

W-R#	Size	Finish	Cleanout?
1205006	1 1/4"	CP	Less C/O
1205008	1 1/2"	RB	Less C/O
1205012	1 1/2"	CP	Less C/O
1206008	1 1/2"	CP	With C/O
1205013	1 1/2" 17g	CP	Less C/O

Traps less cleanout: 22 ga
Traps with cleanout: 20 ga

WASTES & DRAINS



**BRASS TUBULAR
"J" BENDS**

W-R#	Size	Finish	Min	Box
1210010	1 1/2"	CP	1	12

- 22 gauge



**BRASS TUBULAR
"S" TRAP**

W-R#	Size	Finish	Cleanout?
1203002	1 1/4"	CP	Less C/O
1203010	1 1/2"	CP	Less C/O

- 22 gauge



**MILWAUKEE UTILITY
TRAP**

W-R#	Size	Finish	Cleanout?
1201004	1 1/2"	CP	Less C/O

- 20 gauge



**"CROWN" RUBBER
TRAP PLUG**



Carded#	Bulk#	Description	Size
1218002	--	Assorted	
1218004	1218010	Small	3/4"
1218006	1218012	Large	7/8"
1218008	1218014	Jumbo	1 1/16"



**WASTE BENDS
-SLIP JOINT-
22 GAUGE**

W-R#	Size	Finish	Min	Box
0101002	1 1/2" x 6"	RB	1	25
0101004	1 1/2" x 8"	RB	1	25
0101008	1 1/2" x 12"	RB	1	25
0101048	1 1/2" x 12"	CP	1	25
0101012	1 1/2" x 18"	RB	1	25
0101016	1 1/2" x 24"	RB	1	25



**WASTE BENDS
-DIRECT CONNECTION-
22 GAUGE**

W-R#	Size	Finish	Min	Box
0102008	1 1/2" x 12"	RB	1	25
0102016	1 1/2" x 24"	RB	1	25



**FLANGED TAILPIECE
22 GAUGE**

W-R#	Size	Finish	Min	Box
0104004	1 1/2" x 6"	RB	1	25
0104006	1 1/2" x 8"	RB	1	25
0104030	1 1/2" x 8"	CP	1	25
0104010	1 1/2" x 12"	RB	1	25
0104034	1 1/2" x 12"	CP	1	25
0104012	1 1/2" x 18"	RB	1	25

WASTES & DRAINS



**SLIP-JOINT
EXTENSION TUBE
22 GAUGE**

W-R#	Size	Finish	Min	Box
0108018	1 1/4" x 6"	CP	1	25
0108020	1 1/4" x 8"	CP	1	25
0108024	1 1/4" x 12"	CP	1	25
0108032	1 1/2" x 12"	CP	1	25
0108016	1 1/2" x 12"	RB	1	25



**EXTENSION TUBE
22 GAUGE**

W-R#	Size	Finish	Min	Box
0107016	1 1/2" x 12"	RB	1	25
0107040	1 1/4" x 12"	CP	1	25



**THREADED TUBES
(T.B.E.'S)**

W-R#	Size	Finish	Gauge
0109030	1 1/4" x 8"	CP	20
0109008	1 1/4" x 12"	RB	20
0109034	1 1/4" x 12"	CP	20
0109054	1 1/4" x 12"	CP	17
0109044	1 3/8" x 12"	CP	20
0109016	1 1/2" x 12"	RB	20
0109042	1 1/2" x 12"	CP	20



**8" REDUCING
TAILPIECE**

W-R#	Size	Finish	Gauge
0106002	1 1/2" Fine x 1 1/4"	CP	17



**PLUMBEREX®
ADA-APPROVED
UNDERSINK
PROTECTIVE COVERS**



Easy to install Velcro closure

W-R#	Description	Min	Box
1863002	White Trap Gear	1	6

- "Trap Gear" set includes covers for trap, 2 stops, and 2 risers.
- Vinyl cover insulates P-trap & risers to make existing installation ADA compliant.

WASTES & DRAINS



**LONG-SWEEP
DISHWASHER
TAILPIECE**

W-R#	Size	Finish	Min	Box
0117020	1½" x 6"	RB	1	25
0117022	1½" x 8"	RB	1	25
0117024	1½" x 10"	RB	1	25
0117026	1½" x 12"	RB	1	25

- 22 gauge



**CAST BRASS WASHING
MACHINE TEE
- SLIP JT. -**

W-R#	Side Outlet	Min	Box
1512002	3/4" MIP x 1/2" FIP	1	10
1512004	3/4" MH x 1/2" SWT	1	10



**CAST BRASS WASHING
MACHINE TEE
- THREADED -**

W-R#	Size	Finish	Min	Box
1511002	3/4" MIP x 1/2" FIP		1	10
1511004	3/4" MH x 1/2" SWT		1	10



DOUBLE OFFSET

W-R#	Size	Finish	Min	Box
0115002	1 1/4"	RB	1	25
0115006	1 1/4"	CP	1	25
0115004	1 1/2"	RB	1	25
0115008	1 1/2"	CP	1	25

- 22 gauge



SINK FUNNEL

W-R#	Size	Finish	Min	Box
0110004	1½" x 8"	RB	1	25



**CAST IRON
SINK COLLARS**

W-R#	Description	Min.	Box
0509500	2"ID	1	12

- 3 1/2" between centers

WASTES & DRAINS



**CHROME-PLATED
SLIP-JOINT ELBOW**

W-R#	Size	Finish	Min	Box
0112024	1 1/4" x 6"	CP	1	12
0112026	1 1/4" x 8"	CP	1	12
0112030	1 1/4" x 12"	CP	1	12

- 22 gauge



TANK ELBOW

W-R#	Size (A-B-C)	Finish	Min	Box
0113002	2" x 4" x 6"	CP	1	6
0113004	2" x 5" x 7"	CP	1	6
0113006	2" x 6" x 8"	CP	1	6

- 22 gauge



**FLANGED
COVER TUBE**

W-R#	Size	Finish	Min	Box
0116002	2"OD x 6"	CP	1	25

- Fit over 1 1/2" IPS Pipe for use as a bell escutcheon
- 22 gauge



**DOUBLE SLIP
COUPLING**

W-R#	Size	Finish	Min	Box
1501002	1 1/4"	CP	1	6
1501004	1 1/2"	CP	1	6



**DOUBLE SLIP
90° ELBOW**

W-R#	Size	Finish	Min	Box
1502002	1 1/4"	CP	1	6
1502004	1 1/2"	CP	1	6
1502008	1 1/2"	RB	1	6



**DOUBLE SLIP
45° ELBOW**

W-R#	Size	Finish	Min	Box
1506002	1 1/4"	CP	1	6
1506004	1 1/2"	CP	1	6



SLIP TEE

W-R#	Size	Finish	Min	Box
1504004	1 1/2"	CP	1	6
1504008	1 1/2"	RB	1	6

WASTES & DRAINS



TEE AND TAILPIECE

W-R#	Size	Finish	Min	Box
1508002	1½"	RB	1	6



TWIN ELBOW

W-R#	Size	Finish	Min	Box
1509002	1½"	RB	1	6



**GROUND JOINT CONNECTIONS
(DESANCO FITTINGS)**

W-R#	Size	Box
1510004	1 1/4"OD x 1 1/4" Male	25
1510006	1 1/4"OD x 1 1/2" Male	25
1510002	1 1/2"OD x 1 1/2" Male	25
1510000	1 1/2"OD x 1 1/2" Male x Swt	25

- Furnished with nylon slip joint washers

1510008	1 1/4"OD x 1 1/4" Female	25
1510009	1 1/4"OD x 1 1/2" Female	25
1510010	1 1/2"OD x 1 1/2" Female	25



COPPER x MALE TRAP ADAPTER

W-R#	Size	Box
2104006	1½" Sweat x 1½" MIP	25

- For 1 1/2" Copper Pipe



TUBULAR SWEAT RINGS

W-R#	Size	Finish	Min	Box
2110004	1½" Tubular x 1¼" Male			25
2110006	1½" Tubular x 1½" Male			25



BLANK CAPS

W-R#	Size	Finish	Min	Box
0914002	1½"	CP	10	10

WASTES & DRAINS



Zinc Die-Cast

DIE-CAST SLIPNUTS

Size	Brass-plated	Chrome-plated	Box
1 1/4" x 1 1/4"	0901002	0902002	25
1 1/2" x 1 1/2"	0901004	0902004	25
1 1/2" x 1 1/4"	0901006	0902006	25
1 1/2" x 1 3/8"	0901008	0902008	25
2" x 2"	0901010	0902010	10
2" x 1 1/2"	-	0902012	10



Solid Brass

SOLID-BRASS SLIPNUTS

Size	Rough Brass	Chrome-plated	Box
1 1/4" x 1 1/4"	0903002	0904002	25
1 1/2" x 1 1/2"	0903004	0904004	25
1 1/2" Heavy	0903007	-	25
1 1/2" x 1 1/4"	0903006	0904006	25
1 1/2" x 1 3/8"	0903010	0904010	10
2" x 2"	0903008	0904008	10



1 1/2" PVC SLIPNUT

W-R#	Size	Min	Box
1109508	1 1/2" PVC	25	25



TWO-PIECE PVC SLIPNUTS

W-R#	Size	Min	Box
0905002	1 1/4"	1	1
0905004	1 1/2"	1	1

- Replace broken slipnuts quickly and easily.



1 1/2" PVC P-TRAP WITH ADAPTER

W-R#	Size	Min	Box
1101002	1 1/2" P-Trap	1	25



PVC P-TRAPS LESS ADAPTER

W-R#	Size	Min	Box
1101004	1 1/4" P-Trap	1	25
1101003	1 1/2" P-Trap	1	25

WASTES & DRAINS



PVC S-TRAPS

W-R#	Size	Min	Box
1104004	1 1/4" S-Trap	1	12
1104002	1 1/2" S-trap	1	12



**1 1/2" X 16" PVC
END-OUTLET WASTES**

W-R#	Size	Min	Box
1105002	Slip Joint	1	12



**1 1/2" X 16" PVC
CENTER-OUTLET
WASTES**

W-R#	Size	Min	Box
1105006	Slip Joint	1	12



**1 1/2" X 15"
PVC WASTE ARMS**

W-R#	Size	Min	Box
1108005	Slip Joint	1	25
1108006	Direct Connect	1	25



1 1/2" PVC OFFSET

W-R#	Size	Min	Box
1108202	Offset	1	25



**1 1/2" PVC SLIP
ELBOWS**

W-R#	Size	Min	Box
1109002	90° Elbow	1	25
1109004	45° Elbow	1	25



**1 1/2" PVC SLIP
COUPLING**

W-R#	Size	Min	Box
1109006	Coupling	1	25

WASTES & DRAINS



1 1/2" PVC SLIP TEE

W-R#	Size	Min	Box
1109008	Tee	1	25



1 1/2" PVC FLANGED TAILPIECE

W-R#	Size	Min	Box
1110010	1 1/2" X 12"	1	25



1 1/2" PVC SLIP EXTENSION TUBE

W-R#	Size	Min	Box
1114006	1 1/2" X 12"	1	25



1 1/2" X 8" PVC BRANCH TAILPIECES

W-R#	Size	Outlet	Min	Box
1116004	Slip Joint		1/2	25
1116006	Direct Connect		1/2	25

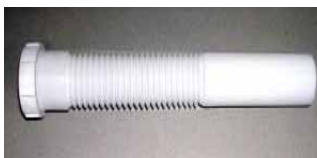

FLEXIBLE TAILPIECES

W-R#	Size	Min	Box
1661002	1/4" Slip	1	25
1661000	1/2" Slip	1	25
1661004	1/2" Direct Connect	1	25

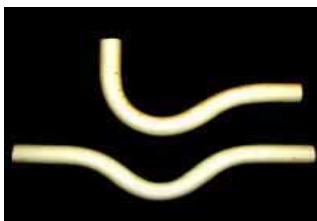

3/4" PVC CONDENSATE TRAPS

W-R#	Size	Min	Box
1207002	P-Trap	1	12
1207004	Running Trap	1	12



3/4" PVC CONDENSATE DRAIN PAN ADAPTERS

W-R#	Size	Nut
1207502	3/4" Hose Barb	Nylon
1207504	3/4" FIP	Nylon
1207506	3/4" MIP	Nylon
1207508	3/4" Compression	Nylon
1207510	3/4" Compression	Metal



- Packed 6 per bag

WASTES & DRAINS



LEAD FITALL PLUG

W-R#	Size	Min	Box
2424002	2"	1	24
2424004	2½"	1	24
2424006	3"	1	24
2424008	3½"	1	24
2424010	4"	1	24
2424012	4½"	1	24
2424014	5"	1	24
2424016	5½"	1	24
2424018	6"	1	24



**RAISED-HEAD BRASS PLUGS
-SOUTHERN CODE-**

W-R#	Size	Min	Box
2424200	1 1/2"	1	12
2424202	2"	1	12
2424204	2½"	1	12
2424206	3"	1	12
2424208	3½"	1	12
2424210	4"	1	12
2424214	6"	1	12



**COUNTERSUNK HEAD BRASS PLUGS
-SOUTHERN CODE-**

W-R#	Size	Min	Box
2424300	1 1/2"	1	12
2424302	2"	1	12
2424304	2½"	1	12
2424306	3"	1	12
2424308	3½"	1	12
2424310	4"	1	12
2424314	6"	1	12



STAINLESS STEEL EXTENSION COVER PLATES

4" EXTENSION COVER SCREW

W-R#	Size	Min	Box
2424404	4"	1	12
2424406	5"	1	12
2424408	6"	1	12
2424410	8"	1	1
2424502	4" Screw	12	12



CHROME-PLATED BRASS TRAP COVERS

W-R#	Size	Min	Box
2211004	5¾" Raised	1	12
2211002	5¾" Flat	1	12

WASTES & DRAINS



PVC TERMINATION SCREEN

W-R#	Description	Min.	Box
2202010	2" Screen	1	12
2202012	3" Screen	1	12



FRESH AIR PLATE

W-R#	Description	Min.	Box
2202002	7" Diameter	6	6

- Galvanized Steel

CLAMP FOR FRESH AIR PLATE



W-R#	Description	Min.	Box
2203004	Spring clamp	1	6



PVC KNOCK-OUT TEST CAPS

W-R#	Size	Min	Box
1836002	1 1/2"	10	10
1836004	2"	10	10
1836006	3"	10	10
1836008	4"	10	10



MARQ-2 TEST PLUG



Unique flanged design

W-R#	Size	Min	Box
1837200	1 1/2"	1	25
1837202	2"	1	25
1837204	3"	1	25
1837206	4"	1	25



MARQ-2 TEST CAP



W-R#	Size	Min	Box
1837400	1 1/2"	1	25
1837402	2"	1	25
1837404	3"	1	25
1837406	4"	1	25



ECONO-PLUGS

W-R#	Size	Min	Box
1837220	1 1/2"	1	25
1837222	2"	1	25
1837224	3"	1	25
1837226	4"	1	25
1837228	6"	1	25



ECONO-CAPS

W-R#	Size	Min	Box
1837502	1 1/2"	1	25
1837504	2"	1	25
1837506	3"	1	25
1837508	4"	1	25

WASTES & DRAINS



“CROWN” RUBBER TRAP PLUG



Carded#	Bulk#	Description	Size
1218002	--	Assorted	
1218004	1218010	Small	3/4"
1218006	1218012	Large	7/8"
1218008	1218014	Jumbo	1 1/16"



CAST IRON WING NUT TEST PLUG

W-R#	Size	Min	Box
1837002	2"	1	10
1837004	3"	1	10
1837006	4"	1	6
1837008	5"	1	4
1837010	6"	1	2



INFLATABLE TEST BALLS

W-R#	Size	Min	Box
1833004	2"	1	6
1833006	3"	1	4
1833008	4"	1	2

Max. Air Pressure: 13 psi
 Max. Water Pressure: 30 ft



PNEUMATIC TEST PLUGS

W-R#	Size	Water Head	Min	Box
1832002	2"	30 Feet	1	6
1832004	3"	30 Feet	1	4
1832006	4"	30 Feet	1	2

- Pneumatic Plug threads into test tee to prevent spillage or loss of plug.



GAS PROVING PUMP

W-R#	Size	Min	Box
1838002	60 psi	1	12



PUMP EXTENSION HOSES

W-R#	Size	Min	Box
1838502	2 ft	1	6
1838504	3 ft	1	6



WAL-RICH SHOWER PAN LINER

Wal-Rich Shower Pan Liner is a blue **40-mil PVC sheet membrane** used in concealed waterproofing applications.

Its primary use is in tile shower installation, and may also be used to waterproof decks, steam rooms, gang showers, reflecting pools, and fountains. Its flexibility and ease of use makes it a great alternative to sheet lead and copper.

Wal-Rich Shower Pan Liner exceeds the standards established in **ASTM D4551-01** for Vinyl Pan Liners and is IAPMO-approved.

Available in 4', 5', and 6' widths, and 40 foot and 100 foot lengths.

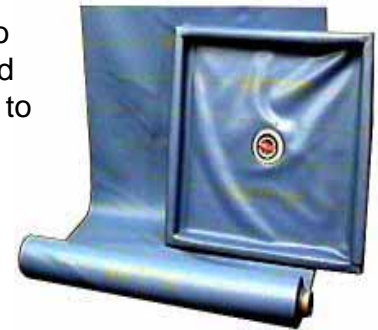

40 MIL SHOWER PAN LINER



W-R#	Size	Sq.Ft.	Weight
1920008	4' x 40'	160	45 lbs.
1920010	5' x 40'	200	60 lbs.
1920012	6' x 40'	240	70 lbs.
1920014	4' x 100'	400	128 lbs.
1920016	5' x 100'	500	155 lbs.
1920018	6' x 100'	600	175 lbs.



PREFAB PAN-LINER CORNERS

W-R#	Description	Min
1920050	Inside Corner	1



WAL-RICH SHOWER PAN LINER CEMENT

W-R#	Size	Min	Box
1013012	1 pt.	1	12

- Medium bodied cement used exclusively on PVC-based shower pan liners.

**WAL-RICH SHOWER PAN LINER
INSTALLATION GUIDELINES**

PREPARATION

The structural subfloor must be clean, reasonably smooth, and free of holes, cracks and sharp projections. Nail heads should be driven flush or recessed.

Blocking between studs is recommended to support the upturned shower pan liner.

Subfloor or substrate should be sloped per code requirements, towards the drain, and must contain no depressions where water will accumulate. On smaller areas, pitching may not be a code requirement. We recommend a pitched subfloor whenever possible.

Drains must be suitably designed for use with a flexible membrane. They must incorporate a clamping device and weep holes.

MATERIALS

W-R Shower Pan Liner.

W-R Shower Pan Liner Cement. Alternatively, certain other medium bodied PVC shower pan liner cements may be used, such as IPS Weld-On. Regular PVC pipe cement cannot be used with our liner, nor can products designed for CPE based material such as Noble companies Chloraloy®.

Wide head nails for tacking upturn of liner.

INSTALLATION

Line the area with W-R Shower Pan Liner. Allow for 3" upturn when cutting the liner.

Turn the liner up on all sides, fold and glue the corners.

Secure the liner to side walls using nails or staples ½" from the top. Lay excess material over the dam, if any, and fasten on the outside face.

The drain is fitted by pressing firmly on the liner to show the outline of the drain body opening. Cut opening, taking care not to cut beyond the perimeter of the clamping ring of the drain. Notch material to expose the tappings in the drain body, or punch out bolt holes by placing the round end of a ball pean hammer over the holes and tapping until the bolt hole has been cut.

Caulk sealant may optionally be used to improve the seal between the clamping ring and the liner. Be sure not to block weep holes with any sealants.

Fit and tighten clamping ring firmly to create a watertight seal.

Where large areas are to be protected, (steam rooms, gang showers, etc.), sheets may be joined. W-R Shower Pan Liner Cement provides a watertight, permanent seam. Allow for a 3" lap seam, and 6" when using a cap seam. Roughen both surfaces with a clean wire brush, working 3 feet at a time. Allow to cure for 24 hours before stressing.

Test installation by filling shower pan with water. If leaking is detected, first retighten the drain clamping ring. Inspect the ring to be certain that it is not warped and that it mates properly with drain body. In some cases it is possible to create a glue seal by gluing a second layer of W-R Shower Pan Liner around the drain body and reassembling the drain.

LIMITATIONS

W-R Shower Pan Liner is intended for installation with a full mortar bed. Thin bed tile installations may require a different installation.

Our installation guidelines are general descriptions and are based on information which we believe to be reliable. Because specific use, installation and material cannot be controlled by Wal-Rich Corporation, our warranty is limited to the replacement of defective product.

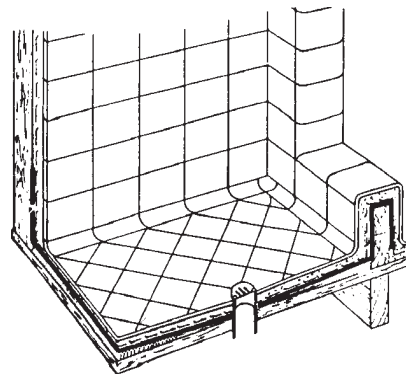
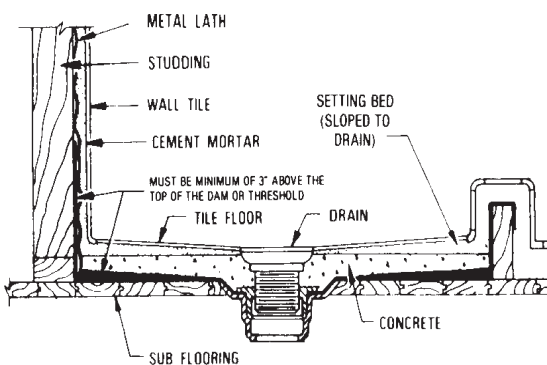

TUB & SHOWER SPECIALTIES



**CHROME-PLATED
OVERRIM SPOUT**

W-R#	Size	Length	Min	Box
0620002	1/2" FIP	5"	1	25
0620007	1/2" FIP	7"	1	25

- Zinc Die Cast



**CHROME-PLATED
DIVERTER SPOUT**

W-R#	Size	Material	Min	Box
0620004	1/2-3/4"	Die Cast	1	25
0620005	1/2-3/4"	Hvy Brass	1	25

- Furnished with 1/2"-3/4" face bushing (back mount)



**CHROME-PLATED
FRONT CONNECTION
DIVERTER SPOUT**

W-R#	Size	Length	Min	Box
0620008	1/2"	5"	1	25
0620009	1/2"	7"	1	25



**CHROME-PLATED
SLIP-ON SPOUT**

W-R#	Size	Type	Min	Box
0620001	Overrim		1	25
0620003	Diverter		1	25

- Slip on spout fits 1/2" copper with set screw and O-Ring seal



**BRASS TWIN ELBOW
FOR DIVERTER SPOUT**

W-R#	Description	Min	Box
0621002	3/4" FIP x 1/2" FIP	1	12



**CHROME-PLATED
SPOUTS FOR
PERSONAL SHOWERS**

W-R#	Description	Min	Box
0604012	1/2" MIP Side Connection	1	12

TUB & SHOWER SPECIALTIES



PERSONAL SHOWER

W-R#	Description	Min	Box
0615002	Personal Shower	1	10

- Contains:
 - Hand-held unit with shutoff lever
 - 59" hose
 - Plastic wall bracket



CHROME-PLATED HOSE FOR PERSONAL SHOWER

W-R#	Size	Min	Box
0615004	59"	1	10

- Corrugated metal hose.



HAND HELD MASSAGE SHOWER UNIT

W-R#	Description	Min	Box
0608030	Handheld Unit	1	10

- Furnished with hose and wall bracket

0608031	Washer only	25	25
----------------	-------------	----	----



CHROME-PLATED #0 BATHCOCK

W-R#	Description	Min	Box
0705002	#0 Bathcock	1	10

- 3 3/8" Center
- 3/4" Shanks



CP BRASS HEAVY-DUTY BATHCOCK FOR "ADD-A-SHOWER"

W-R#	Description	Min	Box
0614005	Bathcock	1	24
A000217	Replacement Handles & Stems	1	12

- Heavy-duty brass construction
- 3 3/8" center-to-center
- Chrome-plated die-cast metal spout



CHROME-PLATED BATHCOCK COUPLING

W-R#	Description	Min	Box
0625002	Coupling	1pr.	6 pr.

- 1/2" MIP x 3/4" FIP Swivel



SPOUTS FOR "ADD-A-SHOWERS"

W-R#	Description	Min	Box
0614010	3/8" Top Outlet	1	12

TUB & SHOWER SPECIALTIES



**W-R STANDARD
"ADD-A-SHOWERS"**

W-R#	Type	Aluminum Ring
0614004	With Bathcock	24" x 42"

Components:

- 0614005 Heavy CP Brass Bathcock
- 0614020 CP 57" Riser
- 0608014 Plastic shower head
- A000182 3/4" x 24" x 42" **aluminum** ring
- A000176 CP ring/riser bracket
- 0605013 3/4" Loop & flange kit
- 0605012 Standard loop & flange kit
- 0605002 6" support rod
- 0605006 24" support rod



**W-R STANDARD
"ADD-A-SHOWERS"
- LESS RING -**

W-R#	Type	No Ring
0614002	With Heavy Duty Bathcock	
0614008	With Diverter Spout	

0614002



**PREMIUM
"ADD-A-SHOWERS"
WITH CP BRASS
RINGS**

W-R#	Type	CP Brass Ring
0613002	With Bathcock	4 1/2' D
0613004	With Bathcock	5' D
0613008	With Bathcock	24" x 42"

0613002
0613004

- Heavy-duty chrome-plated brass tubing
- D-shaped rod features jumbo flanges
- Support rods are 36" universal-fit.



0613008

TUB & SHOWER SPECIALTIES



**CHROME-PLATED
SOLID BRASS DELUXE
SHOWER HEAD**



W-R#	Size	GPM	Min	Box
0608018	1 3/4"	2.5	1	10
0608020	2 1/4"	2.5	1	10
0608021	3"	2.5	1	6

W-R#	Size	GPM	
0608118	1 3/4"	Low Flow	1.5
0608120	2 1/4"	Low Flow	1.5



**CHROME-PLATED
MASSAGE SHOWER
HEAD**

W-R#	Description	Min	Box
0608028	Massage Head	1	12

- 1/2" connection
- 2.5 GPM



**CHROME-PLATED
HAND HELD MASSAGE
SHOWER UNIT**

W-R#	Description	Min	Box
0608030	Handheld Unit	1	10

- Furnished with hose and wall bracket

0608031	Washer only	25	25
---------	-------------	----	----



**CHROME-PLATED
DIE CAST ADJUSTABLE
SHOWER HEAD**

W-R#	Description	Min	Box
0608010	2" Adjustable	1	12



**CHROME-PLATED
DIE CAST "STAR"
SHOWER HEAD**

W-R#	Description	Min	Box
0608016	2" Star	1	25

- 2.5 GPM
- White plastic removable face



**CP PLASTIC
"STREAM-LINER"
SHOWER HEAD**

W-R#	Description	GPM	Min	Box
0608014	2"	2.5	1	25

- White plastic removable face



W-R#	Description	GPM	Min	Box
0608214	2" Low Flow	1.5	1	25
0608114	2" Low Flow	1.0	1	25

TUB & SHOWER SPECIALTIES



CHROME-PLATED BRASS "MINI" SHOWER HEADS

W-R#	Size	Min	Box
0608026	1" Mini	1	12
0608032	1" with Shutoff	1	12

- 1/2" connection
- 2 GPM head with internal restrictor



CHROME-PLATED 6" "RAIN" HEAD

W-R#	Size	Min	Box
0608007	6" Rain	1	12

- Chrome-plated Die Cast Body
- Black Plastic Face



SHOWER CONTROL VALVE

W-R#	Size	Min	Box
0609002	1/2" I.P.S.	1	12

- Chrome-plated brass
- Positive shutoff



DIVERTER VALVE FOR PERSONAL SHOWER

W-R#	Size	Min	Box
0611002	1/2"M x 1/2"F	1	6

- Chrome-plated brass



SELF-CLOSING SHOWER VALVE WITH CHAIN

W-R#	Size	Min	Box
0610002	1/2" I.P.S.	1	6

- Chrome-plated brass

TUB & SHOWER SPECIALTIES



FLOW RESTRICTORS

W-R#	Finish	Box
2311502	2.5 GPM Rubber	25
2311500	2.5 GPM Plastic	25



SHOWER ARM ESCUTCHEONS - WITH SET SCREW

W-R#	Finish	Min	Box
0619002	Chrome - O/S	10	50
0619004	Chrome - N/S	10	50

- 1/2" X 2 1/2"OD
 - O/S: Old Style
 - N/S: New Style



BRASS SHOWER ARMS

W-R#	Length	Finish	Angle
0618002	1/2" x 6"	Chrome	45°
0618004	1/2" x 8"	Chrome	45°
0618006	1/2" x 10"	Chrome	45°
0618008	1/2" x 12"	Chrome	45°

0618010	1/2" x 10"	Chrome	90°
0618012	1/2" x 12"	Chrome	90°

W-R#	Length	Finish	Angle
0618030	1/2" x 6"	PVD Brass	45°
0618040	1/2" x 6"	Satin Nickel	45°



10" 'S' LOW TO HIGH SHOWER ARM

W-R#	Description	Finish
0618022	'S' shower arm	Chrome

- Adds 10" to the height of the shower head



ADJUSTABLE ANGLE SHOWER ARM

W-R#	Description	Finish
0618020	10" adjustable	Chrome

- Allows complete adjustment of shower arm to raise or lower shower head by up to 10"



1/2" DROP-EAR ELBOW

W-R#	Description	Box
0623002	1/2" CTS x FIP	12

TUB & SHOWER SPECIALTIES



STRAIGHT ALUMINUM SHOWER RODS

W-R#	Size	Flanges	Min	Box
0601008	5'	- None -	12	50
0601002	5'	Stamped Steel	12	50
0601012	6'	- None -	12	50
0601006	6'	Stamped Steel	12	50



STRAIGHT CP BRASS SHOWER RODS

W-R#	Size	Finish	Min	Box
0601050	5'	Chrome	1	12
0601052	6'	Chrome	1	12

- All Brass Shower Rods are furnished with wrought flanges



"L" - SHAPED ALUMINUM SHOWER RODS



W-R#	Size	Assembly	Min	Bundle
0602002	5'	1-piece	6	12
0602021	5'	Sectional*	1	-
0602004	5½'	1-piece	6	12
0602022	5½'	Sectional*	1	-
0602006	6'	1-piece	6	12
0602024	6'	Sectional*	1	-

* In order to ship via UPS, "L" rods must be shipped in Sectional format.

- All "L" rods are furnished with stamped flanges and support hardware



"U" - SHAPED ALUMINUM SHOWER RODS



W-R#	Size	Assembly	Min	Bundle
0602506	5'	1-piece	6	12
0602505	5'	Sectional*	1	-

* In order to ship via UPS, "U" rods must be shipped in Sectional format.

- All "U" rods are furnished with stamped flanges and support hardware



"D" - SHAPED ALUMINUM SHOWER RODS



W-R#	Size	Assembly	Min	Bundle
0602706	5'	1-piece	6	12
0602705	5'	Sectional*	1	-

* In order to ship via UPS, "D" rods must be shipped in Sectional format.

- All "D" rods are furnished with stamped flanges and support hardware

TUB & SHOWER SPECIALTIES



**CHROME-PLATED
"D" BAR LOOP**

W-R#	Description	Min	Box
0606002	D-Loop	1	12

- for 1" OD shower rod tubing



**STAMPED STEEL
SHOWER BAR FLANGE**

W-R#	Size	Min	Box
0603002	1"	1 pr.	50

- Chrome plated
- Furnished with screws



**CHROME-PLATED
ADJUSTABLE JIFFY
FLANGE**

W-R#	Description	Min	Box
0603004	Metal	1 pr.	50
0603006	Plastic	1 pr.	50

- For installing shower bars without screws. Friction caps secure holders to wall - eliminate drilling.



**CHROME-PLATED
JUMBO SHOWER BAR
FLANGE**

W-R#	Description	Min	Box
0603008	Jumbo	1 pr.	50



**CEILING SUPPORT
RODS & KITS**

Size	Complete Kit	Universal Kit
6"	0604002	-
18"	0604004	0604500
24"	0604006	0604502
30"	0604008	0604504
36"	0604010	0604506

- Complete Support Kits include 1" loop & flange and 1/8" nickel-plated steel TBE rod

- Universal Support Kits include 1" loop & flange and 1/8" nickel-plated steel TOE rod. 1" Loop has a set screw to allow the cutting of rod to desired length.



**CHROME-PLATED
LOOP AND FLANGE
FOR CEILING SUPPORT**

W-R#	Description	Min	Box
0605012	For 1" OD	1	25
0605013	For 3/4" OD	1	25
0605014	Universal, for 1" OD	1	25

TUB & SHOWER SPECIALTIES



SHOWER CURTAIN PINS

W-R#	Description	Min	Box
0607002	Curtain Pins	100	100

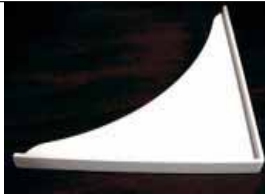

SHOWER SPLASH GUARDS

W-R#	Description	Min	Box
1691002	7" x 7"	1	12

- Pair to a bag
- Self-adhesive



CHROME-PLATED RISER TO RING BRACKET

W-R#	Description	Min	Box
0606502	3/8" to 1"	1	12



- for attaching Add-A-Shower risers to 1" shower rod



TRIP LEVER FACE PLATE ASSEMBLY

W-R#	Description	Min	Box
0626002	Chrome	1	24
0626012	Satin Nickel	1	12

- Furnished less screws (except for Satin Nickel)



W-R#	Description	Min	Box
0626020	Chrome with Screws	1	24



CHROME-PLATED BLANK FACE PLATE FOR TRIP WASTE

W-R#	Description	Min	Box
0626006	2 Hole	1	100
0531002	1 Hole	1	100

- Furnished less screws



CHROME-PLATED WASTE & OVERFLOW STRAINER PLATES

W-R#	Description	Min	Box
0531000	Round	1	10

- 3 1/8" OD

TUB & SHOWER SPECIALTIES



WASTE & OVERFLOW WASHER

W-R#	Description	Min	Box
2716002	Rubber	1	25
2716001	Sponge Rubber	1	25



TUB TRIM CONVERSION KITS

W-R#	Description	Min	Box
0626020	Polished Brass	1	1
0626030	Satin Nickel	1	1

Includes

- Trip Plate Assembly
- Bath Shoe Grid
- 2 Trip Plate Screws
- 1 Bath Shoe Bolt



FACE PLATE SCREWS

W-R#	Description	Min	Box
0627002	Chrome	6	6
0627006	Pol. Brass	6	6
0627004	CP with ring	6	6

- 1 1/2" Long, 1/4" x 20T

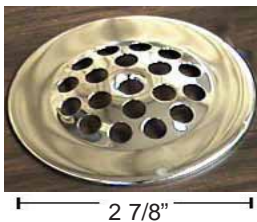

BATH SHOE STRAINER GRID

W-R#	Description	Min	Box
1407010	Stainless Steel	1	12
1407014	C.P. Brass	1	12
1407016	Polished Brass	1	6
1407018	Satin Nickel	1	6



BOLT FOR BATH SHOE GRIDS

W-R#	Description	Min	Box
1407020	Chrome	12	12
1407022	Polished Brass	6	6

- 1/8" x 1 3/4"



BATH SHOE FOR WASTE & OVERFLOW

W-R#	Description	Min	Box
1407002	1 3/8" OD x 6"	1	6
1407004	1 1/2" OD x 6"	1	6
1407008	1 1/2" OD x 18"	1	-

- Furnished with grid and screw



SCREW IN BATH SHOE STRAINER

W-R#	Description	Min	Box
1407006	Strainer	1	6

- Stainless steel
- 1 1/2" Diameter x 1" height



FLAT BATH SHOE WASHER

W-R#	Description	Min	Box
2716000	Black Rubber	25	25

TUB & SHOWER SPECIALTIES



FITALL SINK & TUB STOPPERS

W-R#	Description	Min	Box
1678020	1" - 1 3/8"	12	12
1678022	1 1/2" - 2"	12	12

- White molded rubber



WHITE VINYL HOLLOW STOPPER WITH RING

W-R#	Description	Min	Box
1678002	1"	12	12
1678004	1 1/8"	12	12
1678006	1 1/4"	12	12
1678010	1 1/2"	12	12
1678012	1 5/8"	12	12
1678014	1 3/4"	12	12



5" WHITE VINYL FLAT STOPPER

W-R#	Description	Min	Box
1678030	5" stopper	1	6



HAIR SNARE

W-R#	Description	Min	Box
0527500	Hair Snare	6	6

- Fits most sink, wash tray, and tub drains. Keeps hair and other objects from clogging drains



NICKEL-PLATED STOPPER RINGS

W-R#	Description	Min	Box
1680002	Stopper Rings	25	100

Type B



COUPLING FOR #10 (3/16") BEAD CHAIN

W-R#	Description	Min	Box
1617002	Type A	100	100
1617004	Type B	100	100



Type A



#10 NICKEL-PLATED BRASS BEADED CHAIN

W-R#	Description	Min	Box
1616004	15" Piece	10	10
1616006	100' Roll	1	-

TUB & SHOWER SPECIALTIES

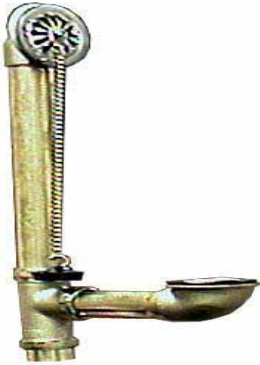

CONNECTED WASTE AND OVERFLOW FOR CLAWFOOT TUB

W-R#	Size	Tubular Finish	Trim
1401002	1 3/8"	RB	Chrome
1401006	1 3/8"	Chrome	Chrome

- Fits Essex-style tubs



BRASS TRIP WASTE ASSEMBLY



W-R#	Description	Min	Box
1404002	17 Gauge	1	12
1404010	20 Gauge	1	12

- Chrome-plated trip-plate
- Chrome-plated bath shoe grid



GERBER-STYLE SCHEDULE 40 PVC TRIP WASTE ASSEMBLY

W-R#	Description	Min	Box
1404502	1 1/2" PVC	1	12

- Chrome-plated two-hole plate
- Chrome-plated tip-toe drain



- Concealed Flanges

SATIN-FINISH STAINLESS STEEL GRAB BARS

Size	1 1/4"	1 1/2"	Min	Box
18"	1370002	1371002	1	12
24"	1370004	1371004	1	12
30"	1370006	1371006	1	8
36"	1370008	1371008	1	8
42"	1370010	1371010	1	4
48"	1370012	1371012	1	4

- 18-gauge, T-304 stainless steel

TUB & SHOWER SPECIALTIES



TRIP-WASTE ROD & SPRING ASSEMBLY

- Fits Gerber & Price Pfister Trip Wastes

W-R#	Description	Min	Box
1402002	Trip Rod & Spring Only	1	12
1402100	Complete Kit w/Trip Plate & Screws		



GENUINE FLIP IT® CHROME-PLATED TUB DRAIN

Shown in bath shoe strainer.
(Not Included)

W-R#	Description	Min	Box
1407620	For Tub	1	-

• Fits all makes of tub drains by selecting the proper O-Rings to completely seal the bath shoe.



CHROME-PLATED TIP TOE DRAIN

TIP-TOE CARTRIDGE

W-R#	Description	Min	Box
1407608	1 1/2"	1	12

- Fits Gerber bath shoes (coarse thread)

1407610	5/16" Cartridge	1	12
1407612	3/8" Cartridge	1	12



CHROME-PLATED "LIFT AND LOCK" DRAIN

W-R#	Description	Box
1407602	1 1/4" Fine Thread	12

- Fits Wal-Rich bath shoes

1407604	1 1/2" Coarse Thread	12
---------	----------------------	----

- Fits Gerber bath shoes



0623502



0623504



0623506



0623508

ACRYLIC TRIM PLATES ("GOOF" PLATES)

W-R#	Description	Dimension
0623502	Single Lever	8" x 14"
0623504	Two Handle	6" x 14"
0623506	Three Handle	6" x 14"
0623508	Tub Spout	3 1/2" OD

- Single Lever ID: 5"
- All other ID's: 1 3/4"

**SHOWER DOOR
HANDLE SETS**

Note: Shower door handle measurements are center-to-center of screw holes.



**STANDARD
SHOWER DOOR
HANDLE SET**

W-R#	Size	Finish
SH200	2"	Chrome
SH300	2 1/4"	Chrome

- Contains:
 - 1 Female inside handle (standard)
 - 1 Male outside handle (standard)
 - 2 screws



**SINGLE-TOWEL BAR
SHOWER DOOR
HANDLE SET**

W-R#	Size	Finish
SH201	2"	Chrome
SH301	2 1/4"	Chrome

- Contains:
 - 1 Female inside handle (standard)
 - 1 Male outside handle (single-bar)
 - 2 screws



**DOUBLE-TOWEL BAR
SHOWER DOOR
HANDLE SET**

W-R#	Size	Finish
SH202	2"	Chrome
SH302	2 1/4"	Chrome

- Contains:
 - 1 Female inside handle (standard)
 - 1 Male outside handle (double bar)
 - 2 screws



**NYLON SHOWER
DOOR ROLLERS**

W-R#	Size	Type	Min	Box
SDP08	3/4"	Flat	1 pr.	10
SDP12	3/4"	Round	1 pr.	10
SDP16	7/8"	Round	1 pr.	10



**UNIVERSAL SHOWER
DOOR BRACKET &
ROLLER**

W-R#	Size	Type	Min	Box
0607102	Bracket		1	10

- 4 holes allow universal height adjustment

TUB & SHOWER SPECIALTIES



VINYL SHOWER DOOR SEAL

W-R#	Description	Min	Box
SDP04	1 1/2" x 36"	1	6



SHOWER DOOR LATCH

W-R#	Description	Min	Box
SDP28	1" Centers	1	6

- Stainless steel housing
- Nylon tip
- Used for hinged shower doors



NYLON SHOWER DOOR GUIDE

W-R#	Description	Min	Box
SDP32	5/8" Guide	6	6

- 5/8" Overall width, 1/8" channels
- Fits top and bottom of shower doors



NYLON BOTTOM SHOWER DOOR GUIDE

W-R#	Description	Min	Box
SDP36	1 5/8" Guide	1	6

- 1 5/8" Overall width, 1/2" channels
- Fits in bottom track of shower door



SHOWER DOOR BUMPER

W-R#	Description	Min	Box
SDP24	3/4" Bumper	4	12

- Anti-slam protective bumpers prevent damage to doors
- Includes screws



PLASTIC "REPLACE-A-BAR" TOWEL BARS

W-R#	Description	Min	Box
1645002	24" Clear	12	12

- Fits all standard brackets - Can be cut to size.



TOILET SPECIALTIES



KORKY® FLAPPER BALLS

W-R#	Description	Lavelle#	Min
1330500	Korky®	54BP	12
1330502	Korky®Plus	2001BP	12
1330503	Korky®1.6	16BP	12
1330506	Korky®Adjustable	2004BP	12
1330510	Korky® Classic	50BP	12
1330512	Korky® Classic	2000BP	12
1330530	Korky® 3" Universal	3060BP	1



1330500 New Design



1330503



1330502 New Design



1330506



1330530



1330510



1330512

KORKY® QUIETFILL BALLCOCK

W-R#	Description	Lavelle#	Min
1330552	Korky®Quietfill	528	1

- Universal, adjustable fit
- Easy to install
- Chlorine resistant
- Quietest fill



Adjusts from 7" - 11"



W-R#	Description	Lavelle#	Min
1330560	Replacement Cap	818BP	1

- Universal, adjustable fit
- Easy to install
- Chlorine resistant
- Quietest fill



TOILET SPECIALTIES



**TRIPLE-SEAL®
TANK BALLS**

W-R#	Description	Gunk#	Min
1330000	Triple Seal	B-251	1 dz.
1329500	3" Triple Seal	B-252	1 dz.



**SEALMASTER®
FLAPPERS**

W-R#	Description	Gunk#	Min
1330604	Sealmaster®	B-264V	1 dz.



**BLUE FLAPPER
TO FIT
AMERICAN STANDARD**

W-R#	Description	Min	Box
1331030	Blue Flapper	1	25

- Made from UHMW PE to be the most abrasion-resistant, chemically inert flapper on the market.
- Furnished with 9" stainless steel chain
- Fits OEM#47146-007



**FLAPPER WITH FLOAT
TO FIT AMERICAN
STANDARD**

W-R#	Description	Min	Box
1331016	With Float	1	25

- Black Rubber
- Fits OEM#738159-0070A



**FLAPPER TO FIT
AMERICAN STANDARD &
COAST 1.6**

W-R#	Description	Min	Box
1331014	With float	1	12

- Fits OEM#s: Am. Std.: 738071-0070A
Coast: 53356
Kohler: 81217



**3" FLAPPER TO FIT
AMERICAN STANDARD
CADET**



W-R#	Description	Min	Box
1331018	3" with chain	1	12

- Fits OEM#s: Am. Std.: 738920-0070A



FLAPPER TO FIT CRANE

W-R#	Description	Min	Box
1331010	With Slot	1	12

- Fits Drexel, Oxford, Neuday, & Criterion Tanks

TOILET SPECIALTIES



**FLAPPER TO FIT
ELJER "LOW-BOY"**

W-R#	Description	Min	Box
1331011	"Low Boy"	1	12

- Fits Eljer Patrician, Windsor, and Canterbury Aqualine low-boy toilets
- White plastic with styrofoam ball



**3" FLAPPERS TO FIT
KOHLER**



W-R#	Description	Min	Box
1331054	Fits Cimmaron	1	12
1331056	Fits Class-5	1	12



**FLAPPER TO FIT
KOHLER**

W-R#	Description	Min	Box
1331004	Black Rubber	1	12

- Fits OEM#49114



Styrofoam float

**FLAPPER TO FIT
KOHLER 1.6 GPF**

W-R#	Description	Min	Box
1331002	1.6 Flapper	1	12

- Black molded rubber with styrofoam ball
- Fits OEM#83064



**NEW-STYLE FLAPPER
TO FIT KOHLER
RIALTO®**

W-R#	Description	Min	Box
1331050	Fits N/S Rialto®	1	12

- Red Chemical resistant rubber
- Furnished with 9" stainless steel chain
- Fits OEM#CSP5170



**NEW-STYLE FLAPPER
TO FIT KOHLER
AQUALINE®**

W-R#	Description	Min	Box
1331052	Fits Aqualine®	1	12

- Red Chemical resistant rubber
- Furnished with 9" stainless steel chain
- Fits OEM#84314



**3" FLAPPER TO FIT
MANSFIELD**



W-R#	Description	Min	Box
1331060	3"	1	12

- Fits OEM#630-0207

TOILET SPECIALTIES



**FLAPPER TO FIT TOTO
"POWER GRAVITY"
TOILETS**

W-R#	Description	Min.	Box
1331070	Blue Flapper	1	12

- Fits OEM#THU140S



**FLAPPER TO FIT TOTO
"G-MAX" TOILETS**

W-R#	Description	Min.	Box
1331072	Red Flapper	1	12

- Fits OEM#THU138S



**FLAPPER TO FIT TOTO
WITH "CLEAR-CONE"**



W-R#	Description	Min.	Box
1331074	Flapper w/ Clear Cone	1	12

- Fits OEM#THU303



**TEAL PREMIUM SILICON
FLAPPER**



W-R#	Description	Min.	Box
1331012	Premium	1	25

- 100% silicone rubber for chlorine and abrasion resistance.



**"CROWN" ORANGE
SILICON FLAPPER**

W-R#	Description	Min.	Box
1331025	Orange Silicon	1	25

- 100% Silicon rubber is resistant to most chemicals and cleansers



**CLEAR VINYL FLAPPER
WITH "TIME-TIPS"**

W-R#	Description	Min.	Box
1331035	"Time Tips"	1	12

- Clear vinyl is chemically resistant
- Furnished with 5 "time-tips" to accommodate a variety of flush rates.

TOILET SPECIALTIES



**WAL-RICH
ECONOMY FLAPPERS**

W-R#	Description	Min.	Box
1331006	Black Vinyl	1	100
1331008	Black Rubber	1	100



**WAL-RICH
NON-JIGGLE TANK
BALLS**

W-R#	Description	Min.	Box
1329002	Non-Jiggle	1 dz	-



**WAL-RICH
FIT-ALL TANK BALLS**

W-R#	Description	Min.	Box
1330002	Fit-all	1 dz	-



**WAL-RICH
ELJER-STYLE TANK
BALLS**

W-R#	Description	Min.	Box
1330004	Fits Eljer	1 dz	-



**WAL-RICH
TRIPLEX TANK BALLS**

W-R#	Description	Min.	Box
1330006	Triplex	1 dz	-
1330008	3" Triplex	1 dz	-



LIFT WIRES

W-R#	Description	Min.	Box
1319002	8" Upper	25	25
1320002	4½" Lower	25	25
1320004	5" Lower	25	25
1320006	5½" Lower	25	25

TOILET SPECIALTIES



FITALL GUIDES

W-R#	Description	Min.	Box
1311002	Fitall Guides	1	12



ELJER GUIDES

W-R#	Description	Min.	Box
1316004	Eljer Guides	1	12



BRASS OVERFLOW TUBES

W-R#	Connection	Length	Gauge
1323002	1" x 1 1/8"	10"	22 ga
1323004	1" x 1 1/8"	10"	17 ga
1323010	1"	10"	22 ga
1323012	1"	10"	17 ga



DOUGLAS FLUSHVALVE

W-R#	Description	Min.	Box
1301004	Brass	1	12
1301008	Plastic with Flapper	1	50



3" FLUSHVALVE

W-R#	Description	Min.	Box
1301020	For 2 pc Toilets	1	12
1301022	For 1 pc. Toilers	1	12



BEVELED FLUSHVALVE WASHER

W-R#	Description	Min.	Box
2718001	Sponge	12	12
2718002	Rubber	12	12

- 3" O.D. x 2 3/8" I.D. x 3/8" High

TOILET SPECIALTIES



#4 FLUSHVALVE FOR AMERICAN STANDARD

W-R#	Description	REF#
1304016	New Style #4	47107-007A
1304018	Old Style #4	47086-007A



#5& #6 FLUSHVALVES FOR AMERICAN STANDARD

W-R#	Description	Min.	Box
1304020	#5	1	-
- Replaces American Standard #47089-07			



#4 ACTUATOR

W-R#	Description	Min.	Box
1304040	#4 Actuator only	1	-
- Replaces American Standard #147086			



#5 ACTUATOR

W-R#	Description	Min.	Box
1304042	#5 Actuator only	1	-
- Replaces American Standard #173380			



#6 ACTUATOR

W-R#	Description	Min.	Box
1304044	#6 Actuator only	1	-
- Replaces American Standard #72880.07			



CHAIN KIT TO FIT AMERICAN STANDARD FLUSHVALVES

W-R#	Description	Min.	Box
1304010	Chain Kit	6	24
- Includes chain, clip & rubber grommet			
- Individually bagged			



REPLACEMENT FOR AMERICAN STANDARD SEAT DISC

W-R#	Description	Min.	Box
1361002	Screw On	1	12
1362004	Snap On	1	12
1362006	Combination Snap/Screw	1	12

TOILET SPECIALTIES



**SEAL TO FIT
AMERICAN STANDARD
"CHAMPION"**

W-R#	Description	Min.	Box
2718010	Fits Champion	1	12
2718012	Fits Champion 3	1	12



**"FEATHER" GASKET
TO FIT
AMERICAN STANDARD**

W-R#	Description	Min.	Box
2718004	Gasket	1	24

- 2 3/8"OD x 1 5/8"ID x 3/8" High



**REPAIR KIT FOR
SERIES N-3055
AMERICAN STANDARD**

W-R#	Description	Min.	Box
1304502	Repair Kit	1	12

• Repair Kit Contains Grommet, Stop, and Seal



**BALLCOCK REPAIR
KITS TO FIT
AMERICAN STANDARD**

W-R#	Description	Min.	Box
1304512	Repair Kit	1	12

- Fits Am. Std. N-3015 & 3025 Ballcocks
- O-Ring Style



**FLUSHVALVE TO FIT
MANSFIELD 210**

W-R#	Description	Min.	Box
1360100	Fits #210	1	12

- For 3.5 Gallon Tanks
- 10 3/4" Length



**FLUSHVALVE TO FIT
MANSFIELD 211**

W-R#	Description	Min.	Box
1360102	Fits #211	1	12

- For 1.6 Gallon Tanks
- 10 3/4" Length

TOILET SPECIALTIES



**SEAL TO FIT
MANSFIELD 209
FLUSHVALVES**

W-R#	Description	Min.	Box
1304524	Seal	6	24
- OEM#208/209			



**SEAL TO FIT
MANSFIELD 210
FLUSHVALVES**

W-R#	Description	Min.	Box
1304525	Seal	6	24
- OEM#210/211			



**PLASTIC ADJUSTABLE
BALLCOCKS**

W-R#	Description	Min.	Box
1304000	Fits Hoover A-62	1	12
- 9 1/2" - 13" Height Adjustment			
- Antisiphon			
- 4 Screw Cap			

1304000



FILLPRO BALLCOCK

W-R#	Description	Min.	Box
1304002	Fillpro	1	25
- Non corrosive, no float or rod needed. Built-in filter screen saves water and replaces old fashioned ballcocks.			



**REPLACEMENT
BALLCOCK TO FIT
KOHLER RIALTO**

W-R#	Description	Min.	Box
1305500	Kit for Rialto	1	6
- Complete kit includes fill valve, floats, refill tubing, and caps.			
- Replaces Kohler OEM# 84499			

TOILET SPECIALTIES



PLASTIC FLOAT

W-R#	Description	Min.	Box
1332002	4" Float	1	100

**BRASS BALLCOCK
RODS**



W-R#	Description	Min.	Box
1321002	8"	1	12
1321006	10"	1	12
1321008	12"	1	12



REFILL TUBES



W-R#	Description	Min.	Box
1322006	9" Plastic w/clip	1	12



**BALLCOCK
SHANK WASHER**

W-R#	Description	Min.	Box
2721002	Shank Washer	1	24



BALLCOCK NUTS



W-R#	Description	Min.	Box
0913002	Brass Coupling	1	25
0913004	Die Cast Cplg	1	25
0913006	PVC Coupling	1	25
0911002	Die Cast Locknut	1	25



1304532



1304536

**BALLCOCK TOP
ASSEMBLIES**

W-R#	Description	Type	Box
1304532	1B1X (Rialto)	3-screw	12
1304536	Hoovr-Line	4-screw	12



**BALLCOCK PLUNGER
REPAIR KITS**

W-R#	Description	Screws	Box
1304506	1B1X (Rialto)	3	12
1304508	Hoovr-Line	4	12

TOILET SPECIALTIES



400A FLUIDMASTER® BALLCOCK

W-R#	Description	Min.	Box
1360004	#400A	1	25



FLUIDMASTER® #555 FLUSHER FIXER KIT

W-R#	Description	Min.	Box
1360006	#555	1	12

- Easy to install. Corrosion free.
- This non-corroding stainless steel seat and captive flapper gives you perfect shutoffs every time.



FLUIDMASTER® #242 KIT

W-R#	Description	Min.	Box
1360008	#242 Kit	1	12
1360009	W-R Kit fits 242	1	25



FLUIDMASTER® 550 DFRK DUO-FLUSH SYSTEM

W-R#	Description
1360020	550DFRK Duo Flush Kit

- No tank removal, snap to fit
- Fits all brands
- Not compatible with Mansfield & 3" flush valves, ballcocks or low-boy toilets



TOILET SPECIALTIES



**CHROME-PLATED
"CROWN" TANK LEVER**

W-R#	Description	Arm	Min.	Box
1318002	Domestic	Flat	1	100
1318004	Imported	Flat	1	100

- 8 1/4" Flat Brass Arm with score line for easy trimming to American Standard size



**CHROME-PLATED
OFFSET "CROWN"
TANK LEVER**

W-R#	Description	Arm	Min.	Box
1318015	Offset	Flat	1	25

- 8 1/4" Offset Flat Brass arm with score lines.
- Metal Spud & Nut



**CHROME-PLATED
INDEX BRASS ARM
TANK LEVER**

W-R#	Description	Arm	Min.	Box
1318000	Domestic	Round	1	100

- 8 1/4" Round Brass Arm
- Metal Spud & Nut
- Individually boxed



**"ACCENT" SINGLE
ACTION TANK LEVER**

W-R#	Description	Arm	Min	Box
1317002	Domestic	Zinc	1	100
1317004	Imported	BP	1	100

- Domestic (1317002) is individually boxed, import is bagged.



**STRAIGHT
TANK LEVERS TO FIT
AMERICAN STANDARD**

W-R#	Size	Arm	Min	Box
1318006	4" CP	ABS	1	25
1318042	6" CP	ABS	1	25
1318019	6" CP	Brass	1	25
1318028	8" CP	ABS	1	25
1318044	8" White	ABS	1	25



**ANGLE
TANK LEVERS TO FIT
AMERICAN STANDARD**

W-R#	Size/Angle/Finish	Arm	Min	Box
1318018	4" CP	Brass	1	25
1318050	6" (45°) CP	ABS	1	25
1318052	6" (28°) CP	ABS	1	25

TOILET SPECIALTIES



**ANGLE
TANK LEVER TO FIT
AMERICAN STANDARD
CADET 3/CHAMPION**



W-R#	Description	Min.	Box
1318060	CP ABS	1	25



**CP PUSH-BUTTON
TANK LEVERS**

W-R#	Description	Min.	Box
1318008	Side Mount	1	12



1318026

**CP SIDE MOUNT
TANK LEVERS FOR
ELJER**

W-R#	Description	Min.	Box
1318026	Fits Eljer	1	25

• Brass Arm, plastic spud & nut



**“TOUCH-FLUSH” KIT TO
FIT ELJER**

W-R#	Description	Min.	Box
1331020	Touch-Flush Kit	1	50

• Includes 4 Piece flush lever, replacement tank ball, and all nessesary mounting hardware



**CAST BRASS TANK
LEVER FOR KOHLER
CHAMPLAIN**

W-R#	Description	Min.	Box
1318032	Offset Lever	1	24

- Fits OEM #51394



**CAST BRASS TANK
LEVER FOR KOHLER
WELLWORTH**

W-R#	Description	Min.	Box
1318034	Cast brass lever	1	24

- Fits OEM #500189



**ABS TANK LEVER FOR
KOHLER
CIMARRON**



W-R#	Description	Min.	Box
1318038	Fits Cimarron	1	25



**CP TANK LEVER
FOR KOHLER
WELLWORTH &
BARRINGTON**

W-R#	Description	Min.	Box
1318030	ABS Lever	1	24

- For side-mount Wellworth models
- Fits OEM#30324

TOILET SPECIALTIES



CP TANK LEVER FOR MANSFIELD #42

W-R#	Description	Min.	Box
1318022	Brass Arm	1	24
1318023	Blue Plastic Arm	1	24



1318070

CP TANK LEVER TO FIT TOTO

W-R#	Description	Min.	Box
1318070	Fits THU-004 "Ultimate"	1	24



1318072

NEW!

1318072	Fits THU-068 "Drake"	1	24
---------	----------------------	---	----



1318074

1318074	Fits THU-061 "Carusoe"	1	24
---------	------------------------	---	----



1318090

TANK LEVERS FOR PRESSURE ASSIST TOILETS

W-R#	Description	Fits REF#
1318090	To Fit Gerber	99-0571-KT
1318092	To Fit Am Std	738473-0020A
1318094	To Fit Am Std	738153-0020A
1318096	To Fit Am Std	738254-0020A

NEW!



1318092



1318094



1318096

TOILET SPECIALTIES



TANK-TO-BOWL GASKETS



W-R#	Description	Dimensions (OD x ID xThk)
2717002	Regular	3 5/16" x 2 3/8" x 3/4"
2717004	Gerber	3 1/4" x 2 1/8" x 1 3/16"
* 2717006	Am. Std.	3 1/2" x 2 1/8" x 1 3/16"
2717007	Eljer (with ears)	
2717008	Eljer	3 1/8" x 2 1/4" x 3/8"
2717010	Kohler	4 3/16" x 2 3/8" x 3/4"
2717011	"U" Gasket	
2717013	Kohler Triangle Gasket	
* 2717014	Gerber	3 3/4" x 2 3/16" x 1 3/16"
2717020	KORKY® Universal 3"	

* Recessed Gasket



**TANK-TO-BOWL BOLTS
PAIR PER BAG**

W-R#	Bolts/Nuts/Washers	Min.	Box
1338000	Brass/Brass/Brass	1 pr.	25
1338006	Brass/Steel/Steel	1 pr.	25
1338008	Steel/Steel/Steel	1 pr.	25

- All tank-to-bowl bolts are furnished with wing nuts, hex nuts, metal washers, and rubber washers



RUBBER WASHER TO FIT TANK-TO-BOWL BOLTS

W-R#	Description	Min.	Box
2714004	7/8"OD x 1/4"ID	25	25

TANK-TO-BOWL KITS



ALL-BRASS KITS (PREMIUM)

W-R#	Description	Min.	Box
1359500	Universal	1	24
1359502	Gerber	1	24
1359504	Am. Std.	1	24
1359508	Mansfield	1	24
1359510	Kohler	1	24



BRASS BOLTS/ STEEL WASHERS (STANDARD)

W-R#	Description	Min.	Box
1359002	Universal	1	24
1359004	Gerber	1	24
1359006	Am. Std.	1	24
1359000	Kohler	1	24
1359007	Eljer	1	24
1359009	A/S Cadet	1	24
1359010	Mansfield	1	24
1359012	Kohler Triangle	1	24
1359014	New Style Gerber	1	24



TOILET SPECIALTIES



1349002

BRASS CLOSET FLANGES



1350002



1351002



1353002



1352002

W-R#	Description	Min.	Box
1349002	Regular	1	50
1350002	Deep	1	50
1351002	For 3" D.W.V. copper	1	25
1352002	4 x 3 Flange for lead	1	25
1353002	Offset for 4" lead	1	25



PVC CLOSET FLANGES



W-R#	Description	Min.	Box
1346002	3" x 4"	1	20
1346004	3" x 4" w/Metal Ring	1	20



PVC "PUSH-2-SET" CLOSET FLANGE

W-R#	Description	Min.	Box
1346090	3"	1	6
1346092	4"	1	6

- Ribbed gasket fits inside Schedule 40 PVC



NYLON TOILET SEAT BOLT, NUT, & WASHER

W-R#	Description	Min.	Box
1365002	5/16"	1 pr.	24



SOFT-PLASTIC SHIMS

W-R#	Description	Bag
1305006	Standard Shims	25
1305008	Soft Rubber Shims	25



FLANGE BOLTS & SCREWS

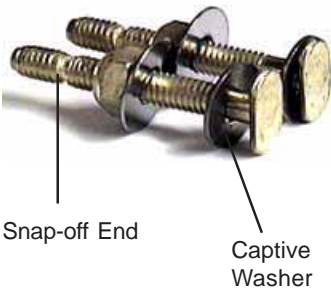

**E-Z FIX
"SNAP-OFF" STYLE
CLOSET FLANGE BOLTS
(PAIR/BAG)**

W-R#	Size	Bolt / Nut
1346504	1/4" x 2 1/4"	Brass/BP
1346500	1/4" x 2 1/4"	All-Brass
1346404	5/16" x 2 1/4"	Brass/BP
1346400	5/16" x 2 1/4"	All-Brass

- Closet Flange bolts are 25 pairs per bag
- Round washers



**CLOSET FLANGE BOLTS
(PAIR/BAG)**

W-R#	Size	Bolt / Nut
1344006	1/4" x 2 1/4"	BP/BP
1344010	1/4" x 3 1/2"	BP/BP
1344012	5/16" x 2 1/4"	BP/BP
1343012	5/16" x 2 1/4"	Brass/BP
1344014	5/16" x 3 1/2"	BP/BP
1343016	5/16" x 3 1/2"	Brass/BP

- Closet Flange bolts are 25 pairs per bag
- Round washers



**CLOSET FLANGE BOLTS
(BULK PACKED)
(100 PER BOX)**

W-R#	Size	Bolt / Nut
1344008	1/4" x 2 1/4"	BP/BP
1336019	1/4" x 3 1/2"	Brass/BP
1336015	5/16" x 2 1/4"	Brass/BP
1336016	5/16" x 3 1/2"	Brass/BP

- Closet Flange Bolts are bulk packed, 100 per box
- Round washers



**WALL-HUNG TOILET
CARRIER CAPS**

W-R#	Description	Min.	Box
2405002	Standard	1 pr.	12
2405003	Extra Long	1 pr.	12

- Each bag contains 4 nuts & 4 washers



TOILET SPECIALTIES



CLOSET FLANGE GASKETS

W-R#	Description	Min.	Box
1357002	Wax Gasket	1	48
1358002	Deep w/Horn	1	24
1358202	Urethane Reinforced with Horn	1	24
1356002	Sponge Rubber (5 3/8" x 3 1/2" x 3/4")	1	24
1358602	Felt-Wax Closet	1	12
1358604	Felt-Wax Urinal	1	12
1358500	2" Wax Urinal	1	12



THE "CLAM FLANGE"

W-R#	Description	Min.	Box
1354500	The Clam	1	12

The "Clam Flange" is a premium repair product preferred by professionals!

Manufactured from **extra-thick, rust-resistant 409 stainless**, the Clam Flange's 2-piece design snaps around **AND UNDER** the existing PVC collar--providing excellent structural support! **Made in USA.**



"CROWN-360" FLANGE REPAIR RING

W-R#	Description	Min.	Box
1354300	"Crown-360"	1	12

- Hinged Flange Repair Ring



TOILET FLANGE REPAIR KIT

W-R#	Description	Min.	Box
1353600	Repair Kit	1	24

- Includes screws & washers
- Repairs flange & mounts to floor



W-R SPAN-IT FLANGE

W-R#	Description	Min.	Box
1354002	Span-it flange	1	24

• Repairs broken closet flanges

TOILET SPECIALTIES

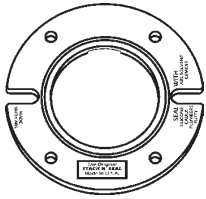

CLOSET FLANGE EXTENSION KIT

W-R#	Description	Min.	Box
1353602	1/4" Kit (3 per)	1	12

- 3 per bag
- Includes 1 pr. 5/16" x 3 1/2" BP Bolts

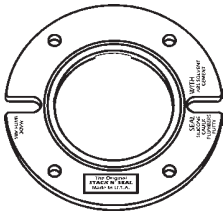

STACKABLE CLOSET FLANGE EXTENDERS

W-R#	Description	Min.	Box
1353604	1/2" thick	1	12
A000352	1/4" thick	1	12

- White ABS



"BIGFOOT" TOILET BASE PLATE

W-R#	Description	Min.	Box
1305004	"Bigfoot"	1	6

- Plastic toilet trim kit, used to cover the "footprint" caused by replacing toilets. One piece construction fits most new toilets.

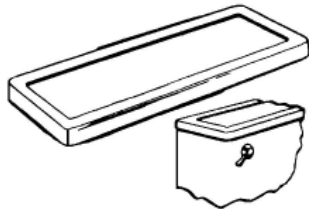

FITALL TANK COVER

W-R#	Description	Min.	Box
1354200	Fitall Cover	1	6

- White high impact plastic.
- 8²¹/₃₂" x 22²⁵/₃₂"

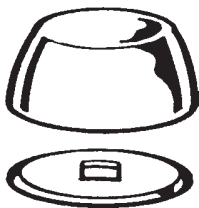

WHITE PLASTIC BOLT CAP

W-R#	Style	Min.	Box
1348002	Molded Prongs	Ea	25
1348003	With Clip	PR	25



PLASTIC TOILET PAPER ROLLER

W-R#	Description	Min.	Box
1363002	White Plastic	25	50

TOILET SPECIALTIES



**BRASS CLOSET SPUD
(WITH WASHER)**

W-R#	Description	Min.	Box
1309016	1" x 3/4"	1	25
1309014	1 1/4" x 3/4"	1	25
1309012	1 1/4" x 1 1/4"	1	25
1309010	1 1/2" x 1 1/4"	1	25
1309008	1 1/2" x 1 1/2"	1	25
1309006	2" x 1 1/4"	1	25
1309004	2" x 1 1/2"	1	25
1309002	2" x 2"	1	25



**CLOSET SPUD
LOCKNUTS**

Size	Die Cast	Brass	Min.	Box
1 1/4"	-	0908008	1	25
1 1/2"	0908004	0908010	1	25
2"	0908006	0908012	1	25

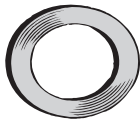

**GALVANIZED
FRICTION RING**

W-R#	Description	Min.	Box
2710502	1 1/2"	12	12
2710504	2"	12	12



**FLANGED
SPUD WASHER**

W-R#	Description	Min.	Box
2710002	1" x 3/4"	12	12
2710004	1 1/4"	12	12
2710006	1 1/2"	12	12
2710008	2"	12	12
2710010	2" x 1 1/4"	12	12
2710012	2" x 1 1/2"	12	12



**CHROME-PLATED
BRASS URINAL FLUSH
VALVE**

W-R#	Description	Min.	Box
1355002	1/2" X 3/4"	1	6

• Self cleaning, spring action



**BRASS URINAL
FLANGE KIT**

W-R#	Description	Fits	Min
1353018	4"	Am Std	1
1353020	4 1/4"	Eljer/Gerber	1
1353022	5 1/2"	Crane	1
1353024	6"	Kohler	1



**PVC URINAL
FLANGE KIT**

W-R#	Description	Min
1353030	PVC--Hub	1
1353032	PVC--Spigot	1

- All Urinal Flange Kits contain bolts, nuts, & sponge gasket



**SPONGE RUBBER
GASKET FOR URINAL
FLANGE**

W-R#	Description	Box
2717012	3 1/4"OD x 2 1/4"ID x 1/2"	25

**TOILET PARTITION
HARDWARE**



**CHROME-PLATED
DIE-CAST
SLIDE LATCHES**

W-R#	Size	Min.	Box
TPP002	2 3/4"	1	12
TPP004	3 1/2"	1	12

- Surface Mounted
- For Plastic & Steel Pilasters



**CHROME-PLATED
DIE-CAST
CONCEALED LATCH**

W-R#	Description	Min.	Box
TPP006	Concealed	1	12

- Furnished without bar
- for 1" thick doors



**CHROME-PLATED
DIE-CAST
BUMPER/KEEPER FOR
CONCEALED LATCH**

W-R#	Description	Min.	Box
TPP016	Bumper/Keeper	1	12

- For use with concealed latch
- Use with 1 1/4" steel pilaster



**C.P. DIE-CAST
TWO-EAR ("T")
WALL BRACKET**

W-R#	Description	Min.	Box
TPP018	1"	1	12
TPP020	1 1/4"	1	12

- Individually bagged
- Screws not included



**C.P. DIE-CAST
URINAL BRACKET**

W-R#	Description	Min.	Box
TPP026	1"	1	12
TPP028	1 1/4"	1	12

- Extended 2-ear design with two screw holes
- For urinal screen partitions
- Screws not included



**C.P. DIE-CAST
RUBBER-TIPPED
COAT HOOK**

W-R#	Description	Min.	Box
TPP034	Rubber-Tipped	1	12

- Individually bagged
- Screws not included



**C.P. TOILET TISSUE
HOLDER**

W-R#	Description	Min.	Box
TPP040	Single-roll	1	12

- Individually boxed
- Screws not included

GENUINE REPAIR PARTS FOR



Consider Wal-Rich as your #1 source for Genuine Sloan Regal Flushvalves and replacement parts.

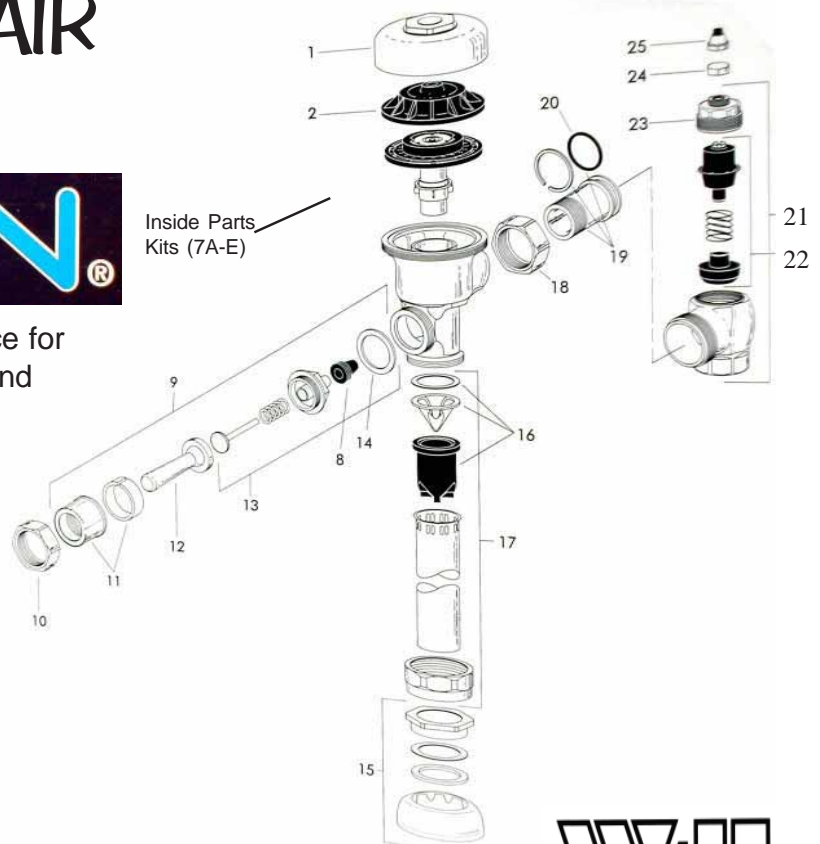
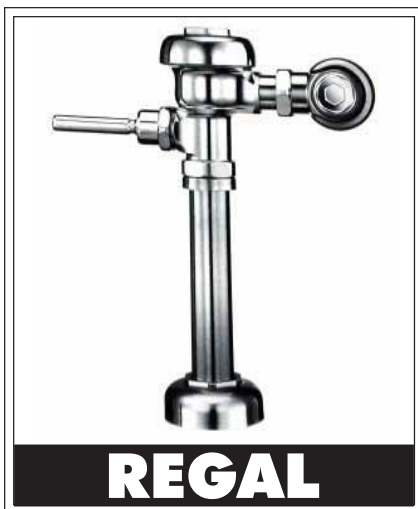

W-R#	Description
1. SR121	CP Cover for Regal (R-10)
2. SR104	Inside Cover (A-71)
3A. SR006	White Relief Valve (A-19-AC)
3B. SR008	Black Relief Valve (A-19-AU)
3C. SR010	Green Relief Valve (A-19-ALC)
4. SR004	Molded Disc (A-15-A)
5. SR102	Sloan Diaphragm (A-156-A)
5A. SR101	Diaphragm w/Copper (A-56-A)
6A. SR110	Guide Assembly (A-163-A)
7A. SR202	Inside Parts Kit - 4.5 C (A-36-A)
7B. SR204	Inside Parts Kit - 1.5 U (A-37-A)
7C. SR206	Inside Parts Kit - 3.5 C (A-38-A)
7D. SR208	Inside Parts Kit - 1.6 C (A-41-A)
7E. SR210	Inside Parts Kit - 1.0 U (A-42-A)
8. SR108	Handle Seal (B-39)
9. SR002	Standard Handle Assy (B-32-A)
9A. SR122	Handicap Handle Assy (B-73)
10. SR118	CP Handle Cplg Nut (A-6)
13. SR106	Handle Repair Kit (B-50-A)
14. SR116	Handle Gasket Only (A-31)

*** **SR700** Sloan Super Wrench (A-50)

W-R#	Description
15A. SR302	3/4" Spud Cplg Assy (F-54-A)
15B. SR308	1 1/4" Spud Cplg Assy (F-55-A)
15C. SR310	1 1/2" Spud Cplg Assy (F-56-A)
16. SR602	Sloan Vacuum Breaker (V-551-A)
17A. SR502	3/4" Vac. Breaker Tail (V-500-AA)
17B. SR504	1 1/4" Vac. Breaker Tail (V-500-AA)
17C. SR506	1 1/2" Vac. Breaker Tail (V-500-AA)
17D. SR129	CP Vacuum Breaker Nut (V-553-A)
18. SR128	Tailpiece Coupling Nut (H-550)
19. SR130	CP Adjustable Tail (H-551-A)
20. SR131	Stop Tailpiece O-Ring (H-553)
21A. SR812	3/4" Control Stop (H-740-A)
21B. SR814	1" Control Stop (H-740-A)
22A. SR138	1" Control Stop Rep Kit (H-541-A)
22B. SR144	3/4" Control Stop Rep Kit (H-543-A)
23A. SR134	1" Control Stop Bonnet (H-639)
23B. SR124	3/4" Control Stop Bonnet (H-538)
24. SR146	Control Stop Bonnet Cap (H-37)

REGAL FLUSHOMETERS

- 1. **SR902** Regal 110XL Flushometer 3.5 C
- 2. **SR903** Regal 111XL Flushometer 1.6 C
- 3. **SR904** Regal 186XL Flushometer 1.5 U

GENUINE REPAIR PARTS FOR



Consider Wal-Rich as your #1 source for Genuine Sloan Royal Flushvalves and replacement parts. All available for immediate delivery.

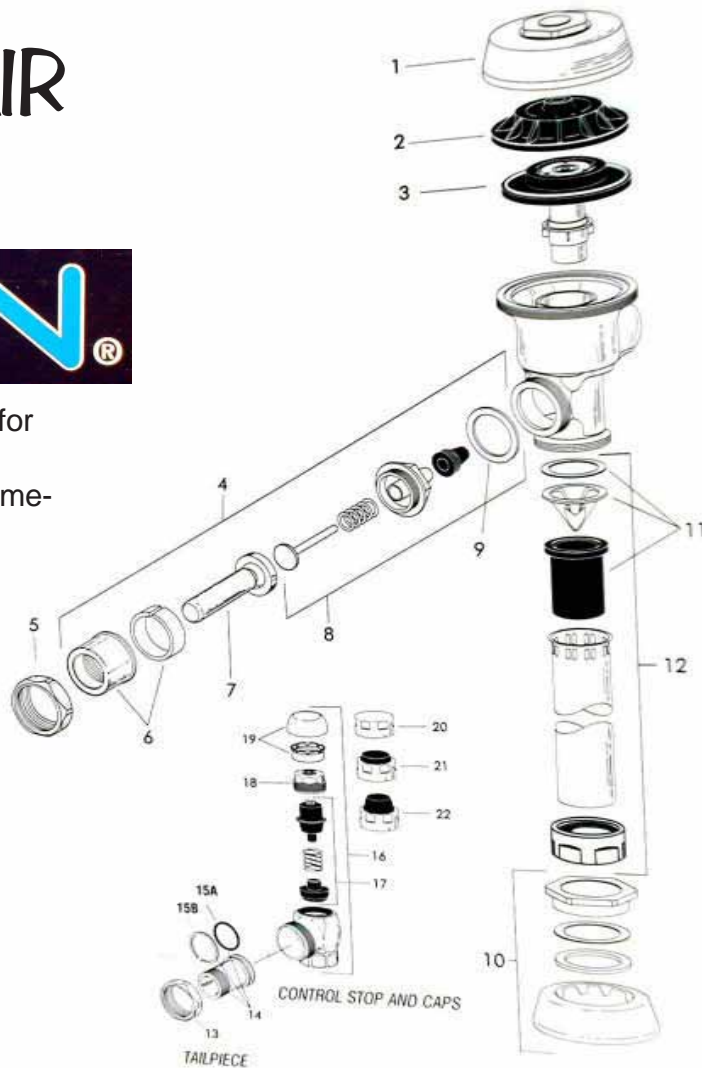
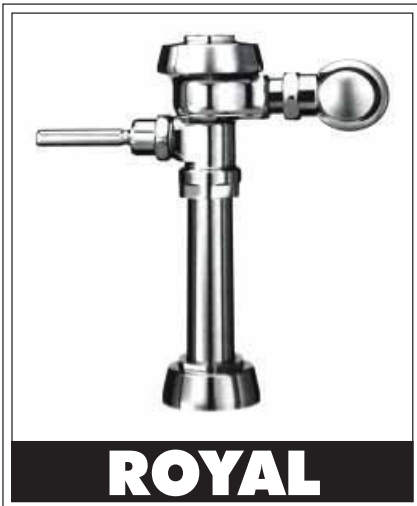

W-R#	Description
1. SR120	CP Cover for Royal (A-72)
2. SR104	Inside Cover (A-71)
3A. SR222	Royal Drop-in Kit 1.5U (A-1037-A)
3B. SR224	Royal Drop-in Kit 3.5C (A-1038-A)
3C. SR226	Royal Drop-in 1.6 C (A-1041-A)
3D. SR228	Royal Drop-in 1.0 U (A-1042-A)
4. SR122	Handicap Handle Assy (B-73-A)
5. SR118	CP Handle Cplg Nut (A-6)
8. SR136	Triple-Seal Handle Rep Kit (B-51-A)
8A. SR108	Handle Seal (B-39)
9. SR116	Handle Gasket Only (A-31)
10A. SR304	3/4" Spud Coupling Assy (F-5-A)
10B. SR306	1 1/4" Spud Coupling Assy (F-5-A)
10C. SR312	1 1/2" Spud Coupling Assy (F-5-A)
11. SR604	Hi-Pressure Vac Breaker (V-651-A)
12A. SR502	3/4" Vac. Breaker Tail (V-500-AA)
12B. SR504	1 1/4" Vac. Breaker Tail (V-500-AA)
12C. SR506	1 1/2" Vac. Breaker Tail (V-500-AA)
12D. SR129	CP Vacuum Breaker Nut (V-553-A)
*** SR700	Sloan Super Wrench (A-50)

W-R#	Description
13. SR128	Tailpiece Coupling Nut (H-550)
14. SR130	CP Adjustable Tail (H-551-A)
15A. SR131	Stop Tailpiece O-Ring (H-553)
17A. SR138	1" Control Stop Rep Kit (H-541-A)
17B. SR144	3/4" Control Stop Rep Kit (H-543-A)
18A. SR126	1" Control Stop Bonnet (H-622)
18B. SR132	3/4" Control Stop Bonnet (H-577)
19A. SR140	1" Vandal-Proof Cap (H-1010-A)
19B. SR142	3/4" Vandal-Proof Cap (H-1009-A)
20A. SR112	1" Control Stop Cap (H-573)
20B. SR114	3/4" Control Stop Cap (H-582)

ROYAL FLUSHOMETERS

- 1. **SR906** Royal 110 Flushometer - Closet
- 2. **SR908** Royal 186 Flushometer - Urinal

The flushometers and repair parts shown on this page refer to the "Dual Filtered" Royal flushometers produced since January of 1998.

GENUINE REPAIR PARTS FOR



Consider Wal-Rich as your #1 source for Genuine Sloan Gem II Flushvalves and replacement parts. All available for immediate delivery.

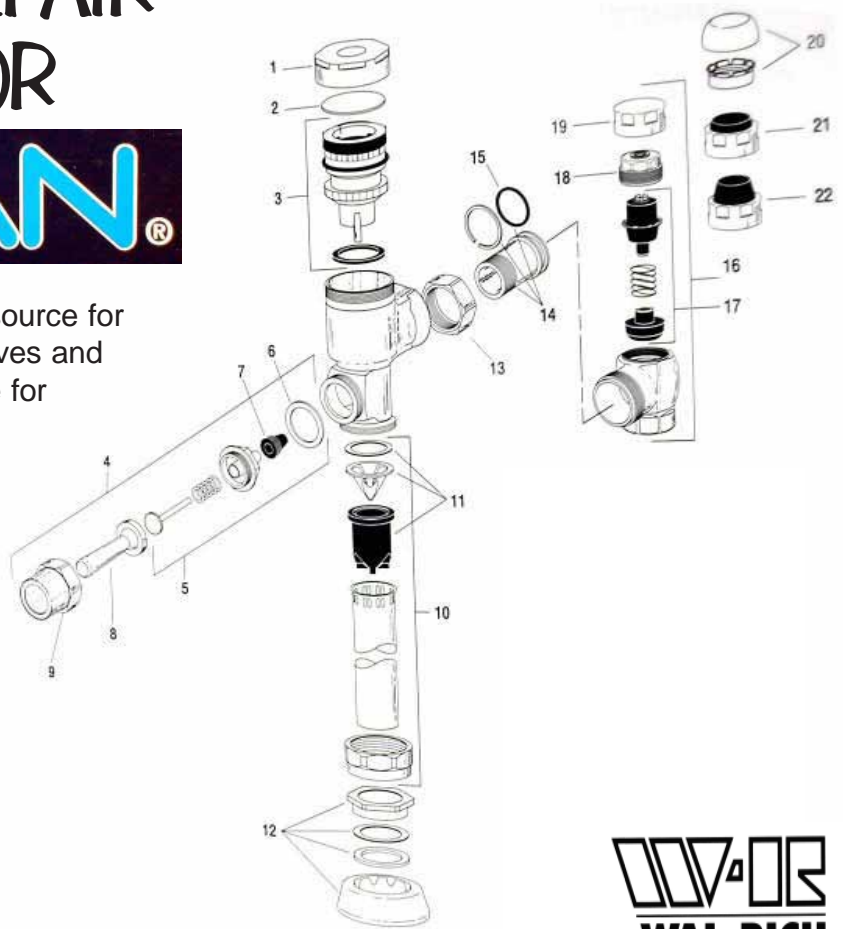

W-R#	Description	W-R#	Description
1. SR408	Gem CP Cover (G-105)	13. SR128	Tailpiece Coupling Nut (H-550)
2. SR406	Gem Slip Disc (G-106)	14. SR130	CP Adjustable Tail (H-551-A)
3A. SR402	Piston for G-75 Urinal (G-1002-A)	15. SR131	Stop Tailpiece O-Ring (H-553)
3B. SR404	Piston for G-75 Closet (G-1003-A)	17A. SR138	1" Control Stop Rep Kit (H-541-A)
3C. SR414	Piston Kit - 3.5 Closet (G-1007-A)	17B. SR144	3/4" Control Stop Rep Kit (H-543-A)
3D. SR416	Piston Kit - 1.6 Closet (G-1016-A)	18A. SR126	1" Control Stop Bonnet (H-622)
3E. SR412	Piston Kit - 1.5 Urinal (G-1009-A)	18B. SR132	3/4" Control Stop Bonnet (H-577)
3F. SR410	Piston Kit - 1.0 Urinal (G-1017-A)	19A. SR112	1" Control Stop Cap (H-573)
4. SR420	Gem Handle Assy (G-36-A)	19B. SR114	3/4" Control Stop Cap (H-582)
5. SR422	Gem Handle Rep Kit (G-50-A)	20A. SR140	1" Vandal-Proof Cap (H-1010-A)
6. SR418	Gem Handle Gasket (G-35)	20B. SR142	3/4" Vandal-Proof Cap (H-1009-A)
7. SR108	Handle Seal (B-39)		
10A. SR502	3/4" Vac. Breaker Tail (V-500-AA)		
10B. SR504	1 1/4" Vac. Breaker Tail (V-500-AA)		
10C. SR506	1 1/2" Vac. Breaker Tail (V-500-AA)		
10D. SR129	CP Vacuum Breaker Nut (V-553-A)		
11. SR602	Sloan Vacuum Breaker (V-551-A)		
12A. SR304	3/4" Spud Coupling Assy (F-5-A)		
12B. SR306	1 1/4" Spud Coupling Assy (F-5-A)		
12C. SR312	1 1/2" Spud Coupling Assy (F-5-A)		
*** SR700	Sloan Super Wrench (A-50)		



Make Wal-Rich your source for Genuine Sloan Flushometers and Repair Parts. All parts are manufactured in the USA by Sloan Valve Company.



**REGAL™
FLUSHOMETERS**

W-R#	Sloan #	Model	GPF
SR902	110XL	Toilet	3.5
SR903	111XL	Toilet	1.6
SR904	186XL	Urinal	1.5

- All Regal™ -XL Flushometers are packaged with control stop and sweat stop conversion kit.



**ROYAL™
FLUSHOMETERS**

W-R#	Sloan #	Model	GPF
SR906	110	Toilet	3.5
SR907	111	Toilet	1.6
SR908	186	Urinal	1.5

- All Royal™ Flushometers are packaged with ADA approved handles and Triple Filter diaphragm.



**CP COVER FOR REGAL
& ROYAL**

W-R#	Description	Sloan#
SR121	Regal CP Cover	R-10
SR120	Royal CP Cover	A-72



INSIDE PLASTIC COVER

W-R#	Description	Sloan#
SR104	Inside Cover	A-71



**MOLDED DISC FOR
REGAL/ROYAL
FLUSHOMETER**

W-R#	Description	Sloan#
SR004	Molded Disc	A-15A



**DIAPHRAGM FOR
REGAL
FLUSHOMETERS**

W-R#	Description	Sloan#
SR102	Diaphragm	A-156-A
SR101	Diaphragm w/Copper Ring	A-56-A
SR199	A-56-A & A-15A	A-56-AA



**RELIEF VALVE FOR
REGAL/ROYAL
FLUSHOMETERS**

W-R#	Description	Sloan#
SR006	White (Toilet)	A-19AC
SR008	Black (Urinal)	A-19AU
SR010	Green (1.6)	A-19ALC

**GENUINE SLOAN®
REPLACEMENT PARTS**



**GUIDE ASSEMBLY FOR
REGAL/ROYAL
FLUSHOMETERS**

W-R#	Description	Sloan#
SR110	Guide Assembly	A-163A



REGAL™ REBUILD KITS



W-R#	Description	Sloan#
SR202	4.5 GPF (Toilet)	A-36A
SR204	1.5 GPF (Urinal)	A-37A
SR206	3.5 GPF (Toilet)	A-38A
SR208	1.6 GPF (Toilet)	A-41A
SR210	1.0 GPF (Urinal)	A-42A
SR212	0.5 GPF (Urinal)	A-43A



**ROYAL™ REBUILD KITS
WITH DUAL-FILTERED
DIAPHRAGM**

W-R#	Description	Sloan#
SR222	1.5 GPF (Urinal)	A-1037A
SR224	3.5 GPF (Toilet)	A-1038A
SR226	1.6 GPF (Toilet)	A-1041A
SR228	1.0 GPF (Urinal)	A-1042A



**OPTIMA-PLUS™ &
OPTIMA™ G2
REBUILD KITS**



W-R#	Description	Sloan#
SR950	Urinal	EBV-1022-A
SR952	Closet	EBV-1020-A
SR954	HET Urinal	EBV-1023-A
SR956	HET Closet	EBV-1024-A



**GEM™ PISTON
ASSEMBLIES**

W-R#	Description	Sloan#
SR402	G-75 (Urinal)	G-1002-A
SR404	G-75 (Closet)	G-1003-A
SR414	3.5 GPF (Closet)	G-1007-A
SR416	1.6 GPF (Closet)	G-1016-A
SR412	1.5 GPF (Urinal)	G-1009-A
SR410	1.0 GPF (Urinal)	G-1017-A



**OLD-STYLE GEM™
PISTON PARTS**



W-R#	Description	Sloan#
SR430	Piston Cover	G-77
SR432	Molded Cup	G-78

**GENUINE SLOAN®
REPLACEMENT PARTS**



**VACUUM BREAKER
INSERT FOR ROYAL/
REGAL™**

W-R#	Description	Sloan#
SR602	Insert	V-551A
SR604	Hi-Pressure Insert	V-651A



**HANDLE ASSEMBLY
FOR ROYAL/REGAL/
GEM™**

W-R#	Description	Sloan#
SR002	Regal	B-32A
SR122	Royal	B-73
SR420	Gem	G-36A



**HANDLE COUPLING
NUT FOR ROYAL/
REGAL™**

W-R#	Description	Sloan#
SR118	CP Nut	A-6



**HANDLE REPAIR KIT
FOR REGAL/ROYAL/
GEM™**

W-R#	Description	Sloan#
SR106	Regal	B-50A
SR136	Royal	B-51A
SR422	Gem	G-50A

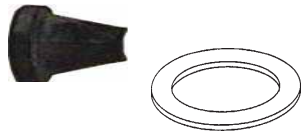

**HANDLE GASKET &
SEAL FOR ROYAL/
REGAL™**

W-R#	Description	Sloan#
SR108	Handle Seal	B-39
SR116	Handle Gasket	A-31
SR418	Gem Handle Gasket	G-35



**VACUUM BREAKER
TAILPIECES**

W-R#	Description	Sloan#
SR502	3/4" x 9"	V-500-AA
SR504	1 1/4" x 9"	V-500-AA
SR508	1 1/4" x 15"	V-500-AA
SR510	1 1/4" x 22"	V-500-AA
SR506	1 1/2" x 9"	V-500-AA
SR512	1 1/2" x 15"	V-500-AA
SR514	1 1/2" x 22"	V-500-AA

**GENUINE SLOAN®
REPLACEMENT PARTS**



**SPUD COUPLING
ASSEMBLIES**

W-R#	Description	Sloan#
SR302	3/4" Regal	F-54-A
SR304	3/4" Royal/Gem	F-5-A
SR306	1 1/4" Royal/Gem	F-5-A
SR308	1 1/4" Regal	F-55-A
SR310	1 1/2" Regal	F-56-A
SR312	1 1/2" Royal/Gem	F-5-A



**CP VACUUM BREAKER
NUT FOR
ROYAL/REGAL/GEM**

W-R#	Description	Sloan#
SR129	CP Nut	V-553-A



**CP ADJUSTABLE TAIL
FOR ROYAL/REGAL/
GEM**



W-R#	Description	Sloan#
SR130	2 1/16" Tail	H-551-A
SR148	3 1/16" Tail	H-551-A
SR150	4 1/16" Tail	H-551-A
SR152	5 1/16" Tail	H-551-A



**CP TAILPIECE COUPLING
NUT FOR
ROYAL/REGAL/GEM**

W-R#	Description	Sloan#
SR128	CP Coupling Nut	H-550



**STOP TAILPIECE
O-RING FOR ROYAL/
REGAL/GEM**

W-R#	Description	Sloan#
SR131	O-Ring	H-553



**CONTROL STOP REPAIR
KIT FOR
ROYAL/REGAL/GEM**

W-R#	Description	Sloan#
SR138	1" Kit	H-541-A
SR144	3/4" Kit	H-543-A



**REGAL™
CONTROL STOPS**

W-R#	Description	Sloan #
SR812	3/4" Control Stop	H-790A-3/4
SR814	1" Control Stop	H-790A-1

**GENUINE SLOAN®
REPLACEMENT PARTS**



**CONTROL STOP
BONNET CAP FOR
REGAL**

W-R#	Description	Sloan#
SR146	Regal Bonnet Cap H-37	



**CP CONTROL STOP
CAP**

W-R#	Description	Sloan#
SR112	1" Cap	H-573
SR114	3/4" Cap	H-582



**CP VANDAL-PROOF
CONTROL STOP CAP**

W-R#	Description	Sloan#
SR140	1" V.P. Cap	H-1010-A
SR142	3/4" V.P. Cap	H-1009-A



**GENUINE SLOAN
"SUPER-WRENCH"®**

W-R#	Description	Sloan #
SR700	Wrench	A-50



**"SPUD BUDDY"
FLUSHOMETER SPUD
WRENCH**

W-R#	Description	Sloan #
1851000	Fits H-551-A	-

**Spud
Buddy®**



Used to adjust or remove flushometer tailpieces during rough-in or replacement.



**FILTER SCREEN FOR
FOR CONTROL STOP
TAILPIECE**

W-R#	Description	Bag
1851050	Filter Screen	12



- Filter screen for CP tailpiece to reduce the amount of debris that enters flushometer body. Helps preserve life of diaphragm.





Consider Wal-Rich your prime source for Genuine Sloan Flushmate parts and accessories. All Flushmate parts are made in the USA and furnished in original packaging.



**GENUINE SLOAN
FLUSHMATE®
REPLACEMENT
CARTRIDGE**

W-R#	Description	Sloan#
FM002	Cartridge	C100500K



FM004

**GENUINE SLOAN
FLUSHMATE® SUPPLY
GROUP**

W-R#	Description	Sloan#
FM004	Supply Group	RK100100



FM006

**GENUINE SLOAN
FLUSHMATE® UPPER
SUPPLY, ONLY**

W-R#	Description	Sloan#
FM006	Upper Supply	BU100505K



**GENUINE SLOAN
FLUSHMATE® 501-B
RETROFIT TANK KIT
(USES 503 TANK)**

W-R#	Description	Sloan#
FM300	Replacement Tank to fit 501-B Series Tanks	M-101526-F3BK

- Replaces the following Flushmate® Tanks:
M-101526-F
M-101526-FA
M-101526-FH
M-101526-FHA



**GENUINE SLOAN
FLUSHMATE® 503
TANK**

W-R#	Description	Sloan#
FM200	503 Tank	M-101526-F31

- 1.6 gpf for all OEMs except Kohler K4404 tank and Gerber 28-385 tank



GENUINE REPAIR PARTS FOR



Consider Wal-Rich as your #1 source for Genuine Delany Rex & Flushboy Flushvalves and replacement parts. All available for immediate delivery.

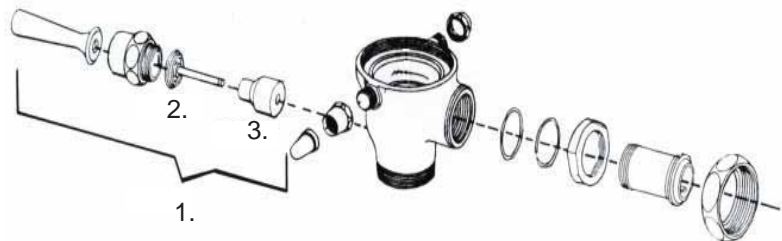
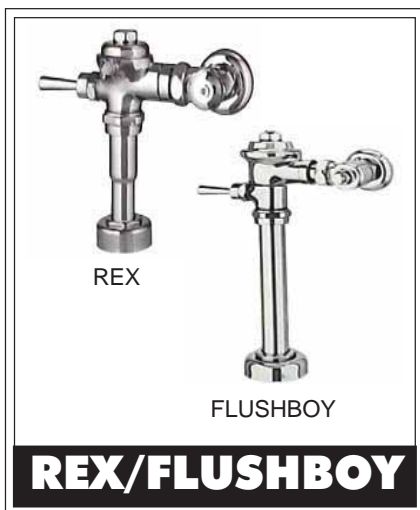
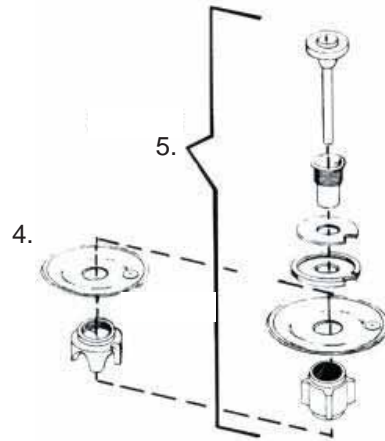

REX FLUSHOMETER PARTS

<u>W-R#</u>	<u>C-D #</u>	<u>Description</u>
1. CD001	R333A	Handle Assembly
2. CD002	R223-2	Brass Operating Stem
3. CD004	R222-3	Rubber Flexor
4. CD201	R107KC	Diaphragm Kit 4.5 Closet
CD202	R107-3KC	Diaphragm Kit 3.5 Closet
CD203	R107-1.6KC	Diaphragm Kit 1.6 Closet
CD204	R107KU	Diaphragm Kit 3.5 Urinal
CD205	R107-1KU	Diaphragm Kit 1.0 Urinal
5. CD101	R107AC	Drop-In Repair Kit 4.5 Closet
CD102	R107-3AC	Drop-In Repair Kit 3.5 Closet
CD103	R107-1.6AC	Drop-In Repair Kit 1.6 Closet
CD104	R107AU	Drop-In Repair Kit 3.5 Urinal

FLUSHBOY FLUSHOMETER PARTS

<u>W-R#</u>	<u>C-D #</u>	<u>Description</u>
1. CD001	R333A	Handle Assembly
2. CD002	R223-2	Brass Operating Stem
3. CD004	R222-3	Rubber Flexor
4. CD301	F141KC	Diaphragm Kit 4.5 Closet
CD302	F141-3KC	Diaphragm Kit 3.5 Closet
CD303	F141-1.6KC	Diaphragm Kit 1.6 Closet
CD304	F141KU	Diaphragm Kit 3.5 Urinal
5. CD401	F141ACQ	Drop-In Repair Kit 4.5 Closet
CD402	F141-3ACQ	Drop-In Repair Kit 3.5 Closet
CD403	F141-1.6ACQ	Drop-In Repair Kit 1.6 Closet
CD404	F141AU	Drop-In Repair Kit 3.5 Urinal



Make Wal-Rich your source for Genuine Delany Flushometers and Repair Parts. All parts are manufactured in the USA by Coyne and Delany Company.



**GENUINE DELANY®
DROP-IN REBUILD KITS
FOR REX**

W-R#	Description	Delany#
CD101	4.5 Closet	R107AC
CD102	3.5 Closet	R107-3AC
CD103	1.6 Closet	R107-1.6AC
CD104	3.5 Urinal	R107AU



**GENUINE DELANY®
REPLACEMENT
DIAPHRAGMS FOR REX**

W-R#	Description	Delany#
CD201	4.5 Closet	R107KC
CD202	3.5 Closet	R107-3KC
CD203	1.6 Closet	R107-1.6KC
CD204	3.5 Urinal	R107KU
CD205	1.0 Urinal	R107-1KU



**GENUINE DELANY®
DROP-IN REBUILD KITS
FOR FLUSHBOY**

W-R#	Description	Delany#
CD401	4.5 Closet	F141ACQ
CD402	3.5 Closet	F141-3ACQ
CD403	1.6 Closet	F141-1.6ACQ
CD404	1.0 Urinal	F141AU



**GENUINE DELANY®
REPLACEMENT
DIAPHRAGMS FOR
FLUSHBOY**

W-R#	Description	Delany#
CD301	4.5 Closet	F141KC
CD302	3.5 Closet	F141-3KC
CD303	1.6 Closet	F141-1.6KC
CD304	1.0 Urinal	F141KU



**GENUINE DELANY®
REX FLUSHOMETERS**

REX™ FLUSHOMETERS

W-R#	Description	Delany#
CD902	1.6 Closet	R401-1
CD904	3.5 Closet	R401-3
CD906	1.0 Urinal	R451-1

- Furnished complete with control stop

**REPLACEMENT PARTS FOR
DELANY FLUSHVALVES**



C.P. HANDLE ASSEMBLY

W-R#	Description	To Fit#
CD001	Handle Assembly	R333A



**VACUUM BREAKER
TO FIT DELANY**

W-R#	Description	To Fit#	Box
CD005	Insert	427A	25



**OPERATING STEM
TO FIT DELANY**



W-R#	Description	To Fit #	Box
CD002	1 15/16"	R223-2	25
CD006	1 29/32"	R33	25



**RUBBER FLEXOR
TO FIT DELANY**

W-R#	Description	To Fit #	Box
CD004	Flexor	R222-3	25



**UNIVERSAL LEATHER
WASHER KIT TO FIT
DELANY**



W-R#	Description	To Fit #	Box
2741002	Leather	Rex	25

- Universal Kit features 3 bypasses to accommodate 1.0, 1.6, & 3.5 GPF.
- Real leather diaphragm



**VACUUM BREAKER
ASSEMBLIES**

W-R#	Description	To Fit #
2743002	1 1/2" x 9"	#50VB
2743004	1 1/4" x 9"	#50VB
2743006	3/4" x 9"	#50VB

REPAIR PARTS TO FIT AMERICAN STANDARD

FITS "HERITAGE"



AS002 Shower (H & C) Pr.
AS003 Diverter Ea.

FITS "HERITAGE"- LARGE



AS018 Shower (H & C) Pr.
AS020 Diverter Ea.

FITS "WRISTBLADE"



AS009 Wristblade Pr.

FITS "AQUASEAL"



AS402HLF Hot Stem Ea.
AS402CLF Cold Stem Ea.
2722002 Washer Only 100

FITS "CADET"



AS409HLF Hot Stem Ea.
AS409CLF Cold Stem Ea.
2722004 Washer Only 24

FITS "AQUASEAL" RETROFIT



AS406HLF Hot Stem Ea.
AS406CLF Cold Stem Ea.

Please Note: For identification purposes only, original manufacturers' names may appear in the description of Wal-Rich replacement parts. These parts should not be confused with the OEM part, unless specified with an original logo.

FITS "AQUASEAL"



AS404LF Bonnet Nut Ea.

FITS "AQUASEAL" DIVERTER

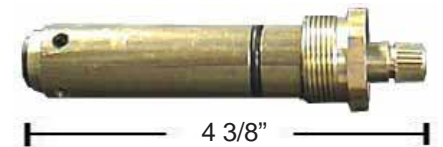

AS412 Diverter Ea.

FITS "HERITAGE"



OD: 3"
ID: 1 3/8"
H: 5/16"

AS101 Escutcheon Ea.

FITS "HERITAGE"



OD: 1 3/8"
ID: 1 1/8"
H: 1 1/8"

AS201 Sleeve Ea.

FITS "AQUASEAL" SEAT



4666022 Seat 25/bag

**REPAIR PARTS TO FIT
CENTRAL BRASS**

FITS CENTRAL BRASS



CB001 Basin (H & C) Pr.

FITS CENTRAL BRASS



CB003 Shower (H & C) Pr.
CB004 Diverter Ea.

FITS CENTRAL BRASS



CB002 Shower (H & C) Pr.
CB005 Diverter Ea.

FITS CENTRAL BRASS



CB006 Wristblade Pr.

FITS CENTRAL BRASS



CB402HLF Hot Basin Stem Ea.
CB402CLF Cold Basin Stem Ea.

FITS CENTRAL BRASS



CB404HLF Hot Basin Stem Ea.
CB404CLF Cold Basin Stem Ea.

FITS CENTRAL BRASS



CB410 Shower (H/C) Ea.

FITS CENTRAL BRASS



CB412 Diverter Ea.

FITS CENTRAL BRASS



CB415 Shower (H/C) Ea.

FITS CENTRAL BRASS



CB417 Diverter Ea.

FITS CENTRAL BRASS

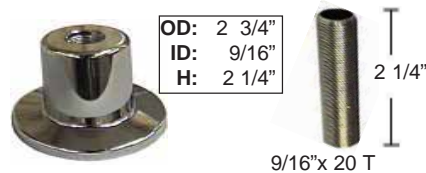

CB202 Escutcheon Ea.
CB502 Escutcheon Nipple Ea.

FITS CENTRAL BRASS



4666008 Seat-1/2" 25/Bag.
4666003 Seat-5/8" 25/Bag

REPAIR PARTS TO FIT CHICAGO

FITS "QUATURN"



2 3/4"



CH002LF Hot Stem Ea.
CH004LF Cold Stem Ea.

REPAIR PARTS TO FIT CRANE

FITS "DIALEZE"



2 1/4"



CR201HLF Hot Stem Ea.
CR201CLF Cold Stem Ea.
1304300 Washer 12
1304302 Adapter 12

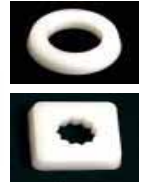

REPAIR PARTS TO FIT DELTA

FITS DELTA



Round Broach Fits #RP2393 

DD002 Single Lever Ea.

FITS DELTA



"D" Broach Fits #H28 

1 3/4"

DD012 Basin (H & C) Pr.

FITS DELTA



"D" Broach Fits #H21 

1 7/8"

DD014 Basin (H & C) Pr.

FITS DELTA



Diamond Broach Fits #RP17449 

DD001 Single Lever Ea.

Please Note: For identification purposes only, original manufacturers' names may appear in the description of Wal-Rich replacement parts. These parts should not be confused with the OEM part, unless specified with an original logo.

FITS DELTA



Round Broach Fits #RP2389 

DD006 Single Lever with Adapter Ea.

FITS DELTA



Offset Diamond Broach Fits #RP2391 

DD004 Shower with Offset Broach Pr.

FITS DELTA



Oval Broach Fits #RP2392 

DD010 Scald-Gard Shower Ea.

FITS DELTA



"D" Broach Fits #H41 

DD008 Two-Handle Shower Pr.

**REPAIR PARTS TO FIT
DELTA (continued)**

FITS DELTA



1674002 Stem Only Ea.
1674012 Stem with S.S. Disc Ea.

FITS DELTA



Fits RP-70



4671002 Brass Ea.
1671006 Stainless Steel Ea.

FITS DELTA



Fits RP-212



4671004 Brass Ea.

FITS DELTA



DD102 3" Extender Ea.

FITS DELTA



1674010 Diverter Ea.

FITS DELTA

Fits RP-19804



Gray

1674020 Fits Monitor Ea.

FITS DELTA



New Style
Short
seats &
springs

1675500 Faucet 25
1676500 Shower 25

FITS DELTA



Old Style
(pre-1972)
Long
seats &
springs

1676002 Faucet 25

FITS DELTA



New-Style
(Short)

Old-Style
(Long)

1674500 New-Style 25
1675002 Old-Style 25

FITS DELTA



1673010 C.P. Cap Assembly Ea.

Please Note: For identification purposes only, original manufacturers' names may appear in the description of Wal-Rich replacement parts. These parts should not be confused with the OEM part, unless specified with an original logo.

FITS DELTA



ID: 1 13/16"
L: 7 1/4"
W: 5 3/8"

1673004 Less Diverter
1673007 With Diverter Hole

REPAIR PARTS TO FIT GERBER

FITS GERBER



GB004 Basin (H & C) Pr.

FITS GERBER



GB005 Basin (H & C) Pr.

FITS GERBER



GB001 Shower (H & C) Pr.
GB002 Diverter Ea.

FITS GERBER



GB003 Shower (H & C) Pr.
GB006 Diverter Ea.

FITS GERBER



GB007 Shower (H & C) Pr.
GB008 Diverter Ea.

FITS GERBER



GB030 Wristblade Pr.

FITS GERBER



GB407HLF Hot Basin Ea.
GB407CLF Cold Basin Ea.

FITS GERBER



GB401 Shower (H/C) Ea.

FITS GERBER

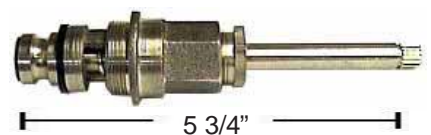

GB412 Diverter Ea.

ORIGINAL GERBER®



GB501 Pressure-balance Shower Cartridge Ea.

FITS GERBER



OD: 2 3/4"
ID: 1 1/8"
H: 3/8"

GB101 Escutcheon Ea.

FITS GERBER



OD: 1 1/8"
L: 3 3/4"

GB201 Shower Sleeve Ea.

REPAIR PARTS TO FIT GERBER (continued)

FITS GERBER



4667002 Seat 25

FITS GERBER



A000148 Shower Washer 25
A000178 Basin Washer 25
1304514 Diverter Washer 25

Please Note: For identification purposes only, original manufacturers' names may appear in the description of Wal-Rich replacement parts. These parts should not be confused with the OEM part, unless specified with an original logo.

FITS GERBER



GB302 Hot Button 10
GB304 Cold Button 10
GB306 Diverter Button 10

REPAIR PARTS TO FIT KOHLER

FITS KOHLER



KK001 Basin (H & C) Pr.
KK002 Shower (H & C) Pr.
KK003 Diverter

FITS KOHLER



KK402HLF Hot Basin Ea.
KK402CLF Cold Basin Ea.

FITS KOHLER



KK410H Hot Shower Ea.
KK410C Cold Shower Ea.

FITS KOHLER



KK412 Diverter Ea.

FITS KOHLER

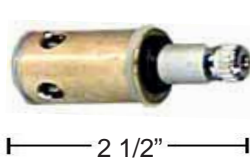

KK404HLF Hot Stem Ea.
KK404CLF Cold Stem Ea.

FITS KOHLER



KK416 Diverter Stem Ea.

REPAIR PARTS TO FIT KOHLER (continued)

FITS KOHLER

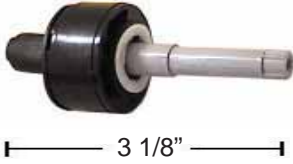

BR101 Single-Lever Ea.

FITS KOHLER



OD: 2 11/16"
ID: 1 1/16"
H: 1/2"

KK102 Escutcheon Ea.

FITS KOHLER



Trend Style
27 TPI



4666024 Seat 25

REPAIR PARTS TO FIT MOEN

FITS MOEN-CHATEAU



MM002 Basin Ea.
MM004 Shower Ea.

FITS MOEN-POSITEMP



MM030 Shower Ea.

FITS MOEN

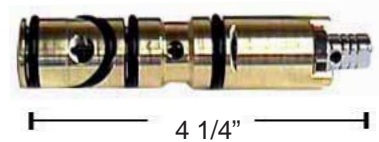

FOR SHOWER ONLY

1304704 Fits 1200B Ea.

FITS MOEN



FOR SHOWER ONLY

1304702 Fits 1225B Ea.

FITS MOEN



1304705 Fits 1222 Positemp Ea.

FITS MOEN



1304712 Fits 1224B Ea.

FITS MOEN



1304604 Clip for #883 Ea.

FITS MOEN



1304610 Spout Seal Kit Ea.

Please Note: For identification purposes only, original manufacturers' names may appear in the description of Wal-Rich replacement parts. These parts should not be confused with the OEM part, unless specified with an original logo.

REPAIR PARTS TO FIT PRICE-PFISTER

FITS PRICE-PFISTER



PP006 Basin (H & C) Pr.
PP004 Shower (H & C) Pr.
PP005 Diverter Pr.

FITS PRICE-PFISTER



PP007 Basin (H & C) Pr.

FITS PRICE-PFISTER



PP022 Fits Avanti Ea.

FITS PRICE-PFISTER



PP402LF Basin (H & C) Pr.

FITS PRICE-PFISTER

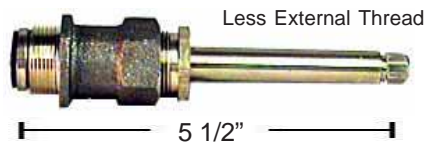

PP410 Shower (H/C) Ea.

FITS PRICE-PFISTER



PP414 Diverter Ea.

FITS PRICE-PFISTER

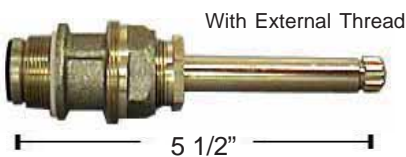

PP412 Shower (H /C) Ea.

FITS PRICE-PFISTER



PP204 Escutcheon Ea.

FITS PRICE-PFISTER



PP102 Sleeve Ea.

FITS PRICE-PFISTER



PP202 Escutcheon Ea.

FITS PRICE-PFISTER



PP502 Plastic Nipple 6

FITS PRICE-PFISTER



4666038 Seat 25

REPAIR PARTS TO FIT SAVOY

FITS SAVOY



SY001 Basin/Shower Pr.

FITS SAVOY



SY002 Basin/Shower Pr.

FITS SAVOY



SV402HLF Hot Basin Ea.
SV402CLF Cold Basin Ea.

FITS SAVOY

New-Style



SV410 Shower (H/C) Ea.

FITS SAVOY

New-Style



SV414 Diverter Ea.

FITS SAVOY

Old-Style



SV411 Shower (H/C) Ea.

FITS SAVOY

Old-Style



SV412 Diverter Ea.

FITS SAVOY

OD: 2 3/4"
ID: 1 1/16"
H: 3/8"



SY103 Escutcheon Ea.

FITS SAVOY

OD: 1"
L: 2 3/4"



SY201 Sleeve Ea.

FITS SAVOY

OD: 2 13/16"
ID: 5/8"
H: 1 11/16"



SY102 Escutcheon Ea.

FITS SAVOY

17/32"



20 TPI

9/16"



4666030 Seat 25

REPAIR PARTS TO FIT SAYCO

FITS SAYCO



SA001 Shower (H & C) Pr.
SA006 Diverter Ea.

FITS SAYCO

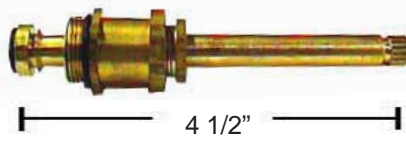

SA401H H/C Shower Ea.

FITS SAYCO

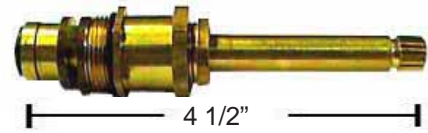

SA412 Diverter Ea.

FITS SAYCO



SA101 Escutcheon Ea.

FITS SAYCO



SA201 Sleeve Ea.

FITS SAYCO



4666032 Seat 25

REPAIR PARTS TO FIT STERLING

FITS STERLING



ST003 Basin (H & C) Ea.

FITS STERLING



ST006 Shower (H & C) Pr.
ST004 Diverter Ea.

FITS STERLING

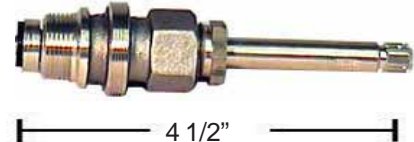

ST410 Shower (H/C) Ea.

FITS STERLING



ST412 Diverter Ea.

FITS STERLING



4666020 Seat 25

FITS STERLING



ST102 Escutcheon Ea.

**REPAIR PARTS TO FIT
STERLING (CONTINUED)**

FITS STERLING



OD: 1 1/4"
ID: 1 1/8"
H: 2 1/2"

ST202 Sleeve Ea.

Please Note: For identification purposes only, original manufacturers' names may appear in the description of Wal-Rich replacement parts. These parts should not be confused with the OEM part, unless specified with an original logo.

**REPAIR PARTS TO FIT
SYMMONS**

FITS SYMMONS



SM001 Shower Ea.

FITS SYMMONS

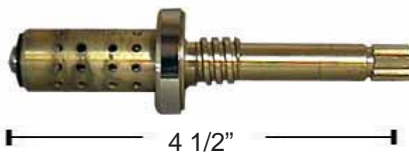

SM401 Fits Temptrol Ea.

FITS SYMMONS



1304200 Seat Kit Ea.
1304202 Repair Kit Ea.

**REPAIR PARTS TO FIT
T & S BRASS**

FITS T & S

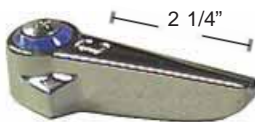

CJ302 Handle (H & C) Pr.

FITS T & S



CJ401HLF Hot Stem Ea.
CJ401CLF Cold Stem Ea.

FITS T & S



CJ500HLF Hot Spindle Assy Ea.
CJ500CLF Cold Spindle Assy Ea.

**REPAIR PARTS FOR
UNIVERSAL FIT**

UNIVERSAL FIT



OD: 5/8"-1/4" X 18T
L: 2 1/2"

0623008 Ea.

UNIVERSAL FIT



OD: 2 7/8"
ID: 3/4"
H: 1 3/4"

0622002 Untapped Ea.

UNIVERSAL FIT



1633302 Crystal Handle Pr.

UNIVERSAL FIT



1632002 Cross Handle Pr.

UNIVERSAL FIT



1633002 Lever Handle Pr.

UNIVERSAL FIT



HH001 Wristblade Pr.

UNIVERSAL FIT



1621002 "Crown" Fitall Pr.

UNIVERSAL FIT

NEW!



1634002 Universal Shower

- Fits Grohe, Danfoss, Gerber, Central, Newport Brass, Altmans, etc.

UNIVERSAL FIT

NEW!



1652020 Universal S/L Faucet

- Fits Gerber & many imported faucet models.

SHOWER REBUILD KITS

Each kit includes the stems, seats, handles, and trim for the most popular 3 valve shower bodies.



FITS AMERICAN STANDARD



ASK01 - Heritage

EACH KIT CONTAINS:		
W-R #	Description	Qty
AS002	Hot/Cold Handle	1 pr.
AS003	Diverter Handle	1
AS402H	Hot Stem	1
AS402C	Cold Stem	1
AS412	Diverter Stem	1
AS404	Stem Bushing	1
AS101	Escutcheon	3
AS201	Sleeve	3
4666022	Seat - (11/32" H - 7/16" x 24T)	2
4666023	Seat - (3/8" H - 35/64" x 18T)	1

FITS CENTRAL BRASS



CBK01 - Old Style Stems

EACH KIT CONTAINS:		
W-R #	Description	Qty
CB003	Hot/Cold Handle	1 pr.
CB004	Diverter Handle	1
CB410	Hot/Cold Stem	2
CB412	Diverter Stem	1
CB202	Sleeve/Escutcheon	3
CB502	Brass Escutcheon Nipple	3
4666003	Seat (21/32" H - 5/8" x 24T)	3



CBK01-P - New Style Stems

EACH KIT CONTAINS:		
W-R #	Description	Qty
CB003	Hot/Cold Handle	1 pr.
CB004	Diverter Handle	1
CB415	N/S Hot/Cold Stem	2
CB417	N/S Diverter Stem	1
CB202	Sleeve/Escutcheon	3
CB502	Brass Escutcheon Nipple	3
4666003	Seat (21/32" H - 5/8" x 24T)	3

SHOWER REBUILD KITS

FITS GERBER



GBK01 - Long Broach

EACH KIT CONTAINS:		
W-R #	Description	Qty
GB003	Hot/Cold Long Broach Handles	1 pr.
GB006	Diverter Long Broach Handle	1
GB401	Hot/Cold Stem	2
GB412	Diverter Stem	1
GB101	Escutcheon	3
GB201	Sleeve	3
4667002	Seat (7/16" H - 5/8" x 20T)	3



GBK02 - Short Broach

EACH KIT CONTAINS:		
W-R #	Description	Qty
GB007	Hot/Cold Short Broach Handles	1 pr.
GB008	Diverter Short Broach Handle	1
GB401	Hot/Cold Stem	2
GB412	Diverter Stem	1
PP202	Escutcheon	3
0623008	Fitall Escutcheon Nipple	3
4667002	Seat (7/16" H - 5/8" x 20T)	3

FITS KOHLER



KKK01 - Trend

EACH KIT CONTAINS:		
W-R #	Description	Qty
KK002	Hot/Cold Handle	1 pr.
KK003	Diverter Handle	1
KK410H	Hot Stem	1
KK410C	Cold Stem	1
KK412	Diverter Stem	1
KK102	Escutcheon	3
4666004	Seat (3/8" H - 1/2" x 27T)	3

FITS PRICE-PFISTER



PPK01 - "Verve"

EACH KIT CONTAINS:		
W-R #	Description	Qty
PP004	Hot/Cold Handles	1 pr.
PP005	Diverter Handle	1
PP410	Hot/Cold Stem - Less Threads	2
PP414	Diverter Stem - Less Threads	1
PP202	Escutcheon	3
PP502	Escutcheon Nipple	3
4666010	Seat (3/8" H - 21/32" x 18T)	3

SHOWER REBUILD KITS

FITS SAYCO



SAK01

EACH KIT CONTAINS:		
W-R #	Description	Qty
SA001	Hot/Cold Handles	1 pr.
SA006	Diverter Handle	1
SA401H	H/C Stem	1
SA412	Diverter Stem	1
SA101	Escutcheon	3
SA201	Sleeve	3
4666032	Seat (5/16" H - 1/2" x 20T)	3

FITS STERLING



STK01

EACH KIT CONTAINS:		
W-R #	Description	Qty
ST006	Hot/Cold Handles	1 pr.
ST004	Diverter Handle	1
ST410	H/C Stem	1
ST412	Diverter Stem	1
ST102	Escutcheon	3
ST202	Sleeve	3
4666020	Seat (3/8" H - 1/2" x 24T)	3

BASIN REBUILD KITS

FITS GERBER



GBF1

EACH KIT CONTAINS:		
W-R #	Description	Qty
GB005	Hot/Cold Basin Handle	1 pr.
GB407HLF	Hot Basin Stem	1
GB407CLF	Cold Basin Stem	1
4667002	Seat (7/16" H - 5/8" x 20T)	2



1670002



1670004



1670006



1670008



1670010



1670012

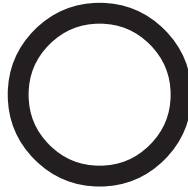

1670014

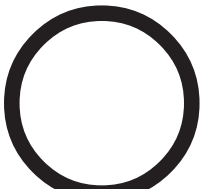

1670016

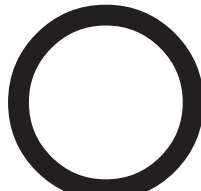

1670018



1670020



1670022



1670024

W-R#	Description	Min.	Box
------	-------------	------	-----

1670002 A 100

¹³/₁₆" O.D. x ⁵/₈" I.D. x ³/₃₂"
Fits Price-Pfister, Arrowhead, Am. Standard

1670004 B 100

⁷/₈" O.D. x ¹¹/₁₆" I.D. x ³/₃₂"
Fits Kohler, Central, Gopher, Republic, Briggs, Mullins, Schaible, Am. Standard, Chase, Milwaukee Faucet.

1670006 C 100

¹⁵/₁₆" O.D. x ³/₄" I.D. x ³/₃₂"
Fits Kohler, Union Brass, Gerber, Indiana Brass, Sayco, Am. Standard.

1670008 D 100

³/₈" O.D. x ¹/₄" I.D. x ¹/₁₆"
Fits Acme Brass.

1670010 E 100

⁷/₁₆" O.D. x ⁵/₁₆" I.D. x ¹/₁₆"
Fits Central Brass, Eljer, Milwaukee Faucet, Chase.

1670012 F 100

⁹/₁₆" O.D. x ³/₈" I.D. x ³/₃₂"
Fits General Brass, Arrowhead, Repcal, Gerber, Milwaukee Faucet, Savoy, Am. Standard, Harcraft.

1670014 G 100

1" O.D. x ³/₄" I.D. x ¹/₈"
Fits Crane, Milwaukee Faucet.

1670016 H 100

¹¹/₁₆" O.D. x ¹³/₁₆" I.D. x ¹/₈"
Fits Eljer, Moen, Chase.

1670018 I 100

¹¹/₈" O.D. x ⁷/₈" I.D. x ¹/₈"
Fits Mullins, Repcal, Harcraft.

1670020 J 100

⁵/₈" O.D. x ⁷/₁₆" I.D. x ³/₃₂"
Fits Central, Chase, Scovill Ballcock, Savoy.

1670022 K 100

¹¹/₁₆" O.D. x ¹/₂" I.D. x ³/₃₂"
Fits Eljer, Moen, Sayco, Dishmaster.

1670024 L 100

³/₄" O.D. x ⁹/₁₆" I.D. x ³/₃₂"
Fits Central, Schaible, Eljer, Price Pfister, Chase, Milwaukee Faucet.

O-RING ASSORTMENT KITS



1668002 150 Piece Assortment

FAUCET & SHOWER SEATS

MINI BRASS SEAT KIT



KOHLER 1/2 x 27 4666004	GERBER 5/8 x 20 4667002		STERLING 1/2 x 24 4666020
	ELJER 1/2 x 27 4666012	AM STD 7/16 x 24 4666022	
AM STD 9/16 x 24 4666002	SAVOY 9/16 x 20 4666010		CENTRAL 1/2 x 24 4666008

W-R#	Description	Min	Box
4663502	Mini Seat Kit	1	12

- 36 of the most popular sizes



NYC FAUCET SEAT KIT

4 KOHLER 1/2 x 27 4666004	6 AM-STD BARNES 1/2 x 20 4666014	16 AMER. STD. 7/16 x 24 4666022	12 GERBER 5/8 x 20 4667002	10 SAVOY 9/16 x 20 4666030	10 CENTRAL 1/2 x 24 4666008
4 SAYCO-YOUNG 1/2 x 20 4666032	6 UNION 33/64 x 18 4666034			10 STERLING 1/2 x 24 4666020	10 PRICE PFISTER 1/2 x 20 4666038
4 AMER. STD. 35/64 x 24 4666002	6 ELJER 1/2 x 27 4666012				

W-R#	Description	Min	Box
4663002	NYC Seat Kit	1	12

- 100 of the 12 most popular sizes in the New York region.



CROWN FAUCET SEAT KIT

4666002 AMERICAN STANDARD	4666004 KOHLER	4666006 BARNES DICK	4666008 CENTRAL STERLING	4666010 BRIGGS REPUBLIC	4666012 ELJER
4666014 AM. STD. BARNES CROSLEY SAYCO Y'NGSTOWN.	4666016 SCHAIBLE	4666018 SPEAKMAN	4666020 STERLING	4666022 AMERICAN STANDARD	4666024 BARNES
4666026 INDIANA MILWAUKEE	46660128 MILWAUKEE	4666030 SAVOY	4666032 SAYCO Y'NGSTOWN	4666034 UNION	4666036 UNIVERSAL RUNDLE

W-R#	Description	Min	Box
4664002	Crown Seat Kit	1	12

- 100 of the 18 most popular size seats



BRASS SEAT GAUGE

W-R#	Description	Min	Box
1850000	Seat Gauge	1	6

- 16 measurements



BRASS BIBB SCREWS



W-R#	Description	Min	Box
1683002	3/8" x 6/32"	100	100
1683004	3/8" x 8/32"	100	100
1683006	3/8" x 10/32"	100	100
1683008	3/8" x 10/24"	100	100
1684002	1/2" x 6/32"	100	100
1684004	1/2" x 8/32"	100	100
1684006	1/2" x 10/32"	100	100
1684008	1/2" x 10/24"	100	100

W-R#	Description	Min	Box
1681002	100 pc Assorted	1	12

GENUINE DELTA® PARTS



**GENUINE DELTA®
HANDLE**

W-R#	Description	Min.
ODP01	RP2393 Handle	1



**GENUINE DELTA®
#70 BALL**

W-R#	Description	Min.
ODP20	RP70 Ball	1



**GENUINE DELTA®
#212 BALL**

W-R#	Description	Min.
ODP22	RP212 Ball	1



**GENUINE DELTA®
SEATS & SPRINGS**

W-R#	Description	Min.
ODP28	RP4993	1



**GENUINE DELTA®
REPAIR KIT**

W-R#	Description	Min.
ODP30	RP3614	1



**GENUINE DELTA®
SPRAY DIVERter**

W-R#	Description	Min.
ODP36	RP320	1



**GENUINE DELTA®
BALANCING SPOOL**



W-R#	Description	Min.
ODP51	RP574	1



**GENUINE DELTA®
CHROME TRIM SLEEVE**



W-R#	Description	Min.
ODP70	RP39407	1

GENUINE DELTA® PARTS



**GENUINE DELTA®
STEM UNIT**

W-R#	Description	Min.
ODP34	RP1740	1



**GENUINE DELTA®
SHOWER CARTRIDGE**

W-R#	Description	Min.
ODP52	RP19804	1



**GENUINE DELTA®
SHOWER CARTRIDGE**

W-R#	Description	Min.
ODP54	RP32104	1



**GENUINE DELTA®
SHOWER CARTRIDGE**

W-R#	Description	Min.
ODP56	RP1991	1



**GENUINE DELTA®
SHOWER CARTRIDGE**

W-R#	Description	Min.
ODP57	RP46463	1



**GENUINE DELTA®
SHOWER CARTRIDGE**

W-R#	Description	Min.
ODP58	RP46074	1



**GENUINE DELTA®
SHOWER CARTRIDGE**

W-R#	Description	Min.
ODP55	RP47201	1



**GENUINE GERBER®
PARTS**

GERBER.

PROFESSIONAL PERFORMANCE



GERBER.

**GENUINE GERBER®
SHOWER CARTRIDGE**

W-R#	Description	For Series
GB501	"Safetemp"	49-400/700
GB502	"Hardwater"	49-600/800



GERBER.

**GENUINE GERBER®
SHOWER CARTRIDGE**

W-R#	Description	For Series
GB503	"Safetemp II" Cartridge & Control for GS-105	95-152 & 4



GB506

5"

**GENUINE GERBER®
SHOWER CARTRIDGE**

W-R#	Description	For Series
GB504	Pressure Balance Cartridge & Control for GH-301	97-231



GB504

5 3/4"

GB506	Pressure Balance Cartridge & Control for GH-305	97-232
-------	-------------------------------------------------------	--------

GERBER.



GERBER.

**GENUINE GERBER®
SHOWER CARTRIDGE**

W-R#	Description	For Series
GB505	Cartridge for GS-305	97-058



GERBER.

**GENUINE GERBER®
SHOWER HANDLE**

W-R#	Description	Gerber#
OGP40	"Safetemp"	97-020
OGP42	"Hardwater"	97-021

- Safetemp Broach is Oval
- Hardwater Broach is Square



GERBER.

**GENUINE GERBER®
CERAMIC CARTRIDGE**

W-R#	Description	Gerber#
OGP01	Ceramaflow®	92-298

- For Single-Lever faucets & showers



**GENUINE GERBER®
TRIM PLATE**

W-R#	Description	Gerber#
OGP20	"Safetemp"	97-018

**GENUINE GERBER®
PARTS**

GERBER.

PROFESSIONAL PERFORMANCE



GERBER.

**GENUINE GERBER®
SINGLE-LEVER
SCREW PACK**

W-R#	Description	Gerber#
OGP45	Screw Assortment	97-016



GERBER.

**GENUINE GERBER®
COMPRESSION BASIN
STEMS**

W-R#	Description	Gerber#
OGP06	Hot Stem	98-688
OGP08	Cold Stem	98-689



GERBER.

**GENUINE GERBER®
COMPRESSION SHOWER
STEMS**

W-R#	Description	Gerber#
OGP10	Hot Stem	98-673



GERBER.

**GENUINE GERBER®
COMPRESSION DIVERTER
STEM**

W-R#	Description	Gerber#
OGP14	Diverter	98-726



GERBER.

**GENUINE GERBER®
CERAMIC SHOWER STEMS**

W-R#	Description	Gerber#
OGP16	Hot Stem	98-705
OGP18	Cold Stem	98-709



GERBER.

**GENUINE GERBER®
TUB/SHOWER FACE PLATES**

W-R#	Description	Gerber#
OGP32	Trip Plate w/Spring	97-130
OGP34	2-Hole Blank Plate	97-305



GERBER.

**GENUINE GERBER®
PLATE & LINKAGE**

W-R#	Description	Gerber#
OGP30	Linkage Assembly	97-171K



GERBER.

**GENUINE GERBER®
BOTTOM ARM & PLUG**

W-R#	Description
OGP36	Plug and Arm Assembly

GENUINE AMERICAN STANDARD® PARTS

American Standard



American Standard

GENUINE AMERICAN STANDARD® SINGLE-LEVER CARTRIDGES

W-R#	Description	AM STD#
AS502	Ceramic Cartridge	023529-0070A
AS504	Ceramic Cartridge	A951470-0070A



AS520
Plastic
Cadet



AS522
with Broach

GENUINE AMERICAN STANDARD® TWO-HANDLE CARTRIDGES

W-R#	Description	AM STD#
AS520	Plastic Cartridge	A954120-0070A
AS522	Ceramic Cartridge	028610-0070A
AS526	Ceramic Cartridge	951764-0070A
AS528	Ceramic Cartridge	994053-0070A



AS526
Ceramic
Cadet



AS528
less Broach

American Standard

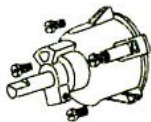

AS510



AS512

American Standard

GENUINE AMERICAN STANDARD® SHOWER CARTRIDGES

W-R#	Description	AM STD#
AS510	Shower Cartridge	051337-0070A
AS512	Shower Cartridge	066269-0070A
AS524	Shower Cartridge	A954440-0070A

American Standard



American Standard

GENUINE AMERICAN STANDARD® PRESSURE BALANCE CONTROL

W-R#	Description	AM STD#
AS514	Pressure Balance	M952100-0070A

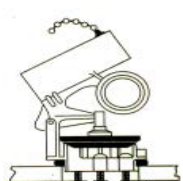

AS630



AS634

GENUINE AMERICAN STANDARD® FLUSHVALVES

W-R#	Description	AM STD#
AS630	1.6 GPF Flushvalve	047107-0070A
AS634	Champion 4 Tower	3174.002-0070A

American Standard

SPECIALTY WASHERS



SEALTITE

**RED SEALTITE®
FAUCET WASHERS**



FLAT#	BEVELLED#	Size	Min
2702500	2702600	Asst'd	1 bx
2702502	2702602	00	1 bx
2702504	2702604	0	1 bx
2702506	2702606	1/4	1 bx
2702508	2702608	1/4 L	1 bx
2702510	2702610	3/8	1 bx
2702514	2702614	3/8 L	1 bx

- 100 washers per box
- 90 Durometer hardness; Temp up to 170°F
- Made in USA



**BLACK
NEOPRENE WASHERS**



FLAT#	BEVELLED#	Size	Min
2702000	2701000	Asst'd	100
2702002	2701002	0	100
2702004	2701004	00	100
2702006	2701006	1/4	100
2702008	2701008	1/4 L	100
2702010	2701010	3/8	100
2702012	2701012	3/8 M	100
2702014	2701014	3/8 L	100
2702016	2701016	1/2	100
2702018	2701018	1/2 L	100

- Packed 100 to a plastic container
- 80 durometer hardness



**"CROWN" PACK
WASHERS & SCREWS**

"HOME-PACK"

W-R#	Description	Min	Ctn
2706002	Beveled	1	12
2706004	Flat	1	12

- Includes 24 plastic boxes of washers and brass screws. Each box contains 20 washers and 4 brass screws.



**NEOPRENE
WASHER KIT**

W-R#	Description	Min	Box
2703002	Beveled	1	10
2703004	Flat	1	10

- Includes 200 neoprene faucet washers and 50 brass screws.



**JUNIOR NEOPRENE
WASHER KIT**

W-R#	Description	Min	Box
2704002	Beveled	1	10
2704004	Flat	1	10

- Includes 100 neoprene faucet washers and 18 brass screws.

SPECIALTY WASHERS



**PREMIUM GERBER
HOMEPACK**

W-R#	Description	Min.	Box
------	-------------	------	-----

2705002 Flat 12 12

4 pcs - 1/4L Flat sealite washers
4 pcs - 3/8 x 10/24 brass bibb screws



**RUBBER SLIP JOINT
WASHER**

W-R#	Description	Min.	Box
------	-------------	------	-----

2707002 1 1/4" 100

2707004 1 1/2" 100

2708004 1 1/2" Heavy Duty 100

2707008 2" 25

2707010 2" x 1 1/2" 25

2707006 1 1/2" x 1 1/4" Flat 100

2708006 1 1/2" x 1 1/4" Bev 100

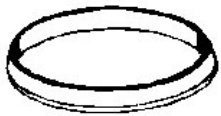

**NYLON SLIP JOINT
WASHER**

W-R#	Description	Min.	Box
------	-------------	------	-----

2708502 1 1/4" 100 100

2708504 1 1/2" 100 100

2708506 1 1/2" x 1 1/4" 100 100

2708508 2" 25 100



**NYLON TAILPIECE
WASHERS**

W-R#	Description	Min.	Box
------	-------------	------	-----

2708602 1 1/2" 100 100



**W-R "PREMIUM" SLIP
JOINT WASHERS**

W-R#	Description	Min
------	-------------	-----

2708802 1 1/4" Slip-Joint 100

2708804 1 1/2" Slip-Joint 100

2708808 1 1/2" x 1 1/4" Slip-Jt 100

2708806 1 1/2" Tailpiece 100

- Premium silicon rubber composite for better seal!



**FITALL SLIP JOINT
WASHER**

W-R#	Description	Min
------	-------------	-----

2709002 Fitall Washer 100

• 1" I.D. x 1 3/8" O.D. x 3/16" wall
• Molded O-Ring stretches to fit 1 1/4", 1 1/2", and 2"



**CLOTH-INSERTED
WASHER**

W-R#	Description	Min
------	-------------	-----

2735102 1 1/2" Cloth-inserted 100



SPECIALTY WASHERS

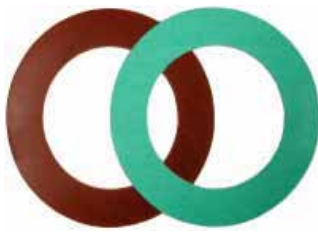

RING GASKET



Fiber	Size	Rubber	OD	ID
2737002	1 1/2"	2737102	3 1/4	1 7/8
2737004	2"	2737104	4	2 1/4
2737006	2 1/2"	2737106	4 3/4	2 3/4
2737008	3"	2737108	5 3/8	3 1/2
2737010	3 1/2"	2737110	6 1/4	3 7/8
2737012	4"	2737112	6 7/8	4 3/8
2737014	5"	2737114	7 3/4	5 1/2
2737016	6"	2737116	8 7/8	6 1/2

- Fiber gaskets are 1/16" thick (150#)
- Fiber gaskets rated to 600° F.
- Rubber gaskets are 1/8" thick (150#)

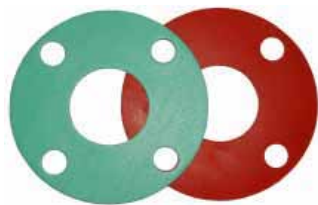

COMPANION FLANGE GASKET



Fiber	Size	Rubber	OD	ID
2739000	1 1/2"	2739100	4 7/8	1 3/4
2739002	2"	2739102	6	2 1/4
2739004	2 1/2"	2739104	7	2 3/4
2739006	3"	2739106	7 1/2	3 3/8
2739008	3 1/2"	2739108	8 1/2	3 7/8
2739010	4"	2739110	9	4 3/8
2739012	5"	2739112	9 7/8	5 1/2
2739014	6"	2739114	11	6 1/2

- Fiber gaskets are 1/16" thick (150#)
- Fiber gaskets rated to 600° F.
- Rubber gaskets are 1/8" thick (150#)

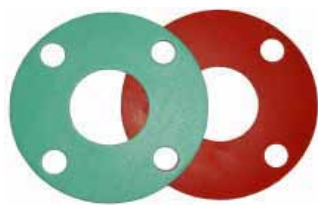

FLANGE UNION GASKET



Fiber	Size	Rubber	OD	ID
2738002	1 1/2"	2738102	4 1/2	1 7/8
2738004	2"	2738104	5	2 1/4
2738006	2 1/2"	2738106	5 7/8	2 3/4
2738008	3"	2738108	6 5/8	3 3/8
2738010	3 1/2"	2738110	7 1/8	3 7/8
2738012	4"	2738112	7 5/8	4 1/2
2738014	5"	2738114	9 7/8	5 1/2
2738016	6"	2738116	10 1/4	6 7/8

- Fiber gaskets are 1/16" thick (150#)
- Fiber gaskets rated to 600° F.
- Rubber gaskets are 1/8" thick (150#)



SPIRAL-WOUND GASKETS (CG TYPE)



Size	150#	300#
2"	2749002	2749502
2 1/2"	2749004	2749504
3"	2749006	2749506
4"	2749010	2749510
6"	2749014	2749514



HEX BOLT & NUT SET



W-R#	Description	Box
2402502	5/8" x 2 3/4" w/nut	12 bolts/nuts
2402504	5/8" x 3" w/nut	12 bolts/nuts
2402506	3/4" x 3" w/nut	12 bolts/nuts
2402508	3/4" x 3 1/4" w/nut	12 bolts/nuts



**Save Time
and Energy!**

NEW!

Basin Buddy[®]

UNIVERSAL Faucet Nut Wrench



Stop fumbling with traditional basin wrenches trying to access hard-to-reach faucet nuts!

**Spend
Less Time
Under The Sink!**



Part #1890002



*Includes
3/8" Ratchet
Adapter*



Metal Locknuts



Coupling Nuts



PVC Locknuts



Metal Ballcock Nuts

One Tool Does It All! Order Yours Today!

Available EXCLUSIVELY from Wal-Rich!



**WAL-RICH
CORPORATION**

**Call 800-221-1157
www.wal-rich.com**

97-36 43rd Avenue, Corona, NY 11368 • Fax: 718-672-0018

MADE IN USA

Patent #6701807

*Ratchet Sold
Separately*

SPECIALTY TOOLS



GENUINE CHANNELLOCK® TONGUE & GROOVE PLIERS

W-R#	Size	Channellock#	Box
CL002	6 1/2"	426	6
CL004	9 1/2"	420	6
CL006	10"	430	6
CL008	12"	440	6
CL010	16"	460	6



SOFT-JAW WATER PUMP PLIERS

W-R#	Description	Min	Box
1818610	10" Soft-Jaw	1	6

- Replaceable plastic jaws do not mar chrome finish!
- Furnished with spare set of jaws



ANGLE NOSE PLIERS -YELLOW GRIPS-



New Sizes!

W-R#	Description	Min	Box
1818620	10"	1	10

- Zinc Dichromate finish resists corrosion
- Angled Pipe Wrench teeth for maximum grip

W-R#	Description	Min	Box
1818624	6 3/4"	1	10
1818626	8"	1	10
1818628	11" Notch Nose	1	10

W-R#	Description	Min	Box
1818632	10" Smooth Jaw	1	10



Features
Grip-Tite Clip!



1818624 6 3/4" 3-settings with shear cutter



1818626 8" 4-settings with shear cutter



1818628 11" 7-settings with notch-nose



1818632 10" 7-settings with smooth jaws

SPECIALTY TOOLS



**LENOX® BI-METAL
RECIPROCATING SAW
BLADES - METAL**

W-R#	Length x TPI	Thick	Lenox#	Box
LX102	4" x 18T	.035	418R	5
LX104	6" x 10T	.035	610R	5
LX106	6" x 14T	.035	614R	5
LX108	6" x 18T	.035	618R	5
LX110	6" x 24T	.035	624R	5

**LENOX® BI-METAL
RECIPROCATING SAW
BLADES - WOOD**

W-R#	Length x TPI	Thick	Lenox#	Box
LX120	6" x 6T	.050	656R	5
LX122	8" x 10T	.050	810R	5
LX124	9" x 6T	.050	956R	5

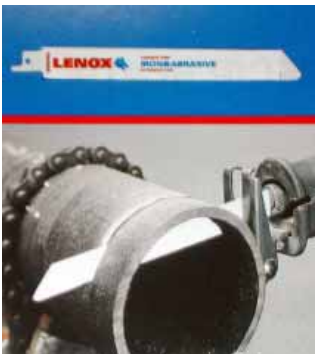

**LENOX® MASTER-GRIT™
RECIPROCATING SAW
BLADES - CAST-IRON**

W-R#	Length x TPI	Thick	Lenox#	Box
LX306	8" x 6T	.040	800RG	2



**QUICKBLADE®
DUAL-BLADE CUTTER**

W-R#	Description	Min	Box
1812700	Quickblade®	1	6

- Reduces fatigue
- Precision cuts against a straight edge
- Ergonomic shape
- Adjustable blade depth
- Non-slip rubber grip
- Replacement blade compartment



Closed Position



Razor Mode



Hook Mode

SPECIALTY TOOLS



“SAFETY-GRIP” UTILITY KNIFE

W-R#	Description	Min	Box
1812108	Safety-Grip	1	6



HEAVY-DUTY BLADES FOR UTILITY KNIFE

W-R#	Description	Min	Box
1812102	Blades	5	100



**MINI HACKSAW
MINI HACKSAW BLADES**

W-R#	Description	Min	Box
1812208	Mini Hacksaw	1	10

W-R#	Description	Min	Box
1812210	Blades	10	100



PIPE TAPS

W-R#	Description	Drill Size	Box
1820002	1/8"	11/32"	5
1820004	1/4"	7/16"	5
1820006	3/8"	9/16"	5
1820008	1/2"	3/4"	1
1820010	3/4"	7/8"	1
1820012	1"	1 1/8"	1
1820014	1 1/4"	1 1/2"	1
1820016	1 1/2"	1 3/4"	1
1820018	2"	2 1/4"	1



SCREW EXTRACTORS

W-R#	Description	Drill Size	Box
1843002	#4 -- 1/8"	1/4"	5
1843004	#5 -- 1/4"	17/64"	5
1843006	#6 -- 3/8"	13/32"	1
1843008	#7 -- 1/2"	17/32"	1
1843010	#8 -- 3/4"	13/16"	1
1843012	#9 -- 1"	1 1/8"	1

SPECIALTY TOOLS



**INTERNAL PIPE
WRENCH**

W-R#	Description	Min	Box
1818122	1/2"	1	6
1818124	3/4"	1	6

- Tool to remove nipples, eccentric action grips inside of pipe.



**IRWIN SPEEDBOR
'2000'® WOOD
BORING BITS**

W-R#	Description	Irwin #	Min	Box
1812514	5/8"	88810	1	6
1812518	3/4"	88812	1	6
1812522	7/8"	88814	1	6
1812526	1"	88816	1	6
1812528	1 1/8"	88818	1	6
1812530	1 1/4"	88820	1	6
1812532	1 3/8"	88822	1	6
1812534	1 1/2"	88824	1	6



**"Lock'n Load"
Quick-Change
System**



W-R#	Description	Irwin #	Box
1812544	6" Lock'n Load	90106	1
1812542	12" Lock'n Load	90112	1



**COPPER TUBE
BENDING SPRINGS**

W-R#	Description	Min	Box
1806004	3/8" O.D.	1	6

• For bending supply lines and copper tubing.

SPECIALTY TOOLS



PROFESSIONAL RATCHETING COPPER TUBING CUTTER

W-R#	Description	Min	Box
1807026	1/4" - 2"	1	6
1807030	Wheel only	1	1

- Spring loaded cutter wheel arm allows slide action size adjustment and quick release
- Aluminum alloy body
- Extra wheel



PROFESSIONAL MINI-TUBING CUTTER

W-R#	Description	Min	Box
1807020	5/8"-1 1/8"	1	6
1807030	Wheel only	1	1

- Aluminum alloy body
- Extra wheel



ECONOMY COPPER TUBE CUTTER

W-R#	Description	Min	Box
1807002	1/8" - 1"	1	6



ECONOMY MIDGET COPPER TUBE CUTTER

W-R#	Description	Min	Box
1807004	1/8" - 7/8"	1	6



PVC PIPE CUTTER

W-R#	Description	Min	Box
1812028	1" Sch 40 Cutter	1	6

- Ratchet action
- Cuts up to 1" Sch. 40 PVC pipe
- Cuts up to 1 1/4" PVC Tubular



PEX TUBING CUTTER

W-R#	Description	Min	Box
1812040	1 1/2" OD	1	6

- Sharp cutting edge for PEX & vinyl tubing

SPECIALTY TOOLS

“QUICK-DRAW” PVC SAW



W-R#	Description	Min	Box
1812302	“Quick Draw”	1	12
1812304	Blade Only	1	1



PVC INSIDE PIPE CUTTER

WITH ABRASIVE CUTTER WHEEL

W-R#	Description	Min	Box
1812030	Abrasive Cutter	1	12
1812032	Set of 3 Wheels	1	1



WITH METAL CUTTER WHEEL

W-R#	Description	Min	Box
1812070	Metal Blade	1	12



PVC CABLE SAW

W-R#	Description	Min	Box
1812212	26” Cable Saw	1	6



“FITT’N SAVER” PVC SOCKET REAMER

- 1. Saw PVC flush with fitting
- 2. Ream remainder out to renew fitting



W-R#	Description	Min	Box
1812060	1 1/2” Fitt’n Saver	1	6
1812062	2” Fitt’n Saver	1	6
1812064	3” Fitt’n Saver	1	6
1812066	4” Fitt’n Saver	1	6

SPECIALTY TOOLS



BLOCK FLARING TOOL

W-R#	Description	Min	Box
1808004	3/16" - 5/8"	1	6
- 3/16", 1/4", 5/16", 3/8", 7/16", 1/2", 5/8"			



COPPER SWEDGE TOOL

W-R#	Description	Min	Box
1808215	3/8" - 7/8"	1	6



**WIRE-HANDLE
COPPER FITTING
BRUSH**

W-R#	Description	Min	Box
1809002	3/8"	10	100
1809004	1/2"	10	100
1809006	3/4"	10	100
1809008	1"	10	100
1809010	1 1/4"	10	100
1809012	1 1/2"	10	100
1809014	2"	10	100



**PLASTIC-HANDLE
COPPER FITTING
BRUSH**

W-R#	Description	Min	Box
1811002	3/8"	10	100
1811004	1/2"	10	100
1811006	3/4"	10	100
1811008	1"	10	100
1811010	1 1/4"	10	100
1811012	1 1/2"	10	100
1811014	2"	10	100



**4-IN-1 COPPER FITTING
BRUSH**

W-R#	Description	Box
1809000	1/2" X 3/4" Brush	1

SPECIALTY TOOLS



BLUE WATERPROOF EMERY CLOTH

W-R#	Description	Min	Box
1835000	5 yard	1	25
1835002	10 yards	1	25
1835004	25 yards	1	25

- 1½" Wide, 120 grit



OPEN-MESH GRIT CLOTH

W-R#	Description	Min	Box
1835006	5 yards	1	25
1835008	10 yards	1	25

- Our open mesh abrasive is a fully waterproof product coated on a synthetic nylon backing.



"CROWN-BRITE" ABRASIVE HAND PADS

W-R#	Description	Min	Box
1847500	6" x 9 1/2" pad	60	60

• A quality substitute for the Scotch Brite® pad.



SCOTCH BRITE® PADS



W-R#	Description	Min	Box
1848000	6" x 9½" pad	20	60
1848001	6" x 9½" pad	60	60



#0 INDUSTRIAL STEEL WOOL PADS

W-R#	Description	Min	Box
2433002	6 sleeves/ctn	1	1

- 16 large pads per sleeve
- "0" size.



DOPE BRUSH

W-R#	Description	Min	Box
1813002	3/8"	36	36



ACID BRUSHES

W-R#	Description	Min	Box
1812002	1/4"	1 gr.	1 gr.



WOOD HANDLE CHIP BRUSHES

W-R#	Description	Min	Box
1814002	1"	10	10
1814006	2"	10	10

SPECIALTY TOOLS



LONG-HANDLE WIRE SCRATCH BRUSH

W-R#	Description	Min	Box
1811102	Scratch Brush	1	10

- 3 x 19 rows
- 13" long

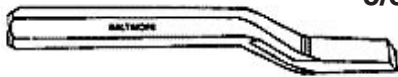

5/8" CAULKING IRONS

W-R#	Description	Min	Box
1872002	Inside - Short	1	6
1872004	Outside - Short	1	6
1872006	Straight - Short	1	6
1872012	Broad-Nose	1	6



STEEL SOLDER LADLE

W-R#	Description	Min	Box
1804006	4"	1	6



CAST IRON SOLDER POT

W-R#	Description	Min	Box
1805006	8"	1	6



NON-ASBESTOS JOINT RUNNER

W-R#	Description	Min	Box
1823002	#1 (2" to 4")	1	6
1823004	#2 (4" to 6")	1	6
1823006	#3 (6" to 10")	1	6
1823008	#4 (10" to 14")	1	6



PLUMBERS CANDLES

W-R#	Description	Min	Box
1840002	Candles	1	120



SPARK LIGHTER

W-R#	Description	Min	Box
1848002	Round File	1	10
1848006	Flat File	1	10

REPLACEMENT FLINTS

1848004	Flint only	10	10
---------	------------	----	----

SPECIALTY TOOLS



**"TRIPLE-HEAD"
STRIKE LIGHTER**



W-R#	Description	Min	Box
1848010	Triple Strikers	1	10
1848012	Triple Flints	5	5



FLAME SHIELD PADS



W-R#	Description	Min	Box
1905000	12" x 12" Pad	1	12

- Fire Proof Non asbestos material protects wood and metal during sodlring and brazing.
- Aluminum backing holds shape
- Working temp: 2500 °F



B-TANK KEYS



W-R#	Description	Min	Box
1701210	B-Tank Key	12	12



KWICK-WICK SPOOLS



W-R#	Description	Min	Box
1906004	Spool	25	400

- Individual spools of single strand wicking for packing in threaded joints.



2 OZ. LAMPWICK BALLS



W-R#	Description	Min	Box
1906018	Fine (5-end)	12	12
1906020	Medium (8-end)	12	12



DUCT TAPE



W-R#	Description	Min	Box
2426002	2" x 60 yds-Gray	1	24
2426003	2" x 60 yds-Black	1	24



FOIL TAPE



W-R#	Description	Min	Box
2426010	2" x 60 Foil	1	12



ELECTRICAL TAPE

W-R#	Description	Min	Box
1841002	3/4" x 60'	1	10

SPECIALTY TOOLS



RED RUBBER SQUARE-PAK



W-R#	Description	Min	Box
1910002	6" x 6"	12	12
1910004	12" x 12"	12	12

- 1/16" thick red SBR rubber.



RED RUBBER PACKING SHEET



W-R#	Description	Min
1909002	1/16"	100 lbs
1909014	1/8"	100 lbs

- Approximate roll dimensions:
 1909002 (1/16") 3' x 60'
 1909014 (1/8") 3' x 27'
 -20 to 170° Farenheit

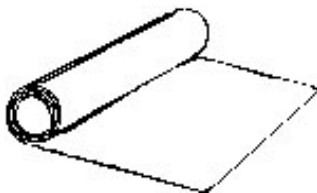

HIGH-TEMPERATURE GASKETING MATERIAL



W-R#	Description	Min
1904002	60" x 60"	1
1904004	30" x 30"	1

- 1/16" Thick
 - Non asbestos pressed fiber
 - Rated at up to 1200°F



BROWN JERSEY WORK GLOVES

W-R#	Description	Min	Box
1839002	Brown Jersey	1 dz	12 dz



"SPLATTER-PALM" WORK GLOVES

W-R#	Description	Min	Box
1839008	Red "Splatter" 10 pr	100 pr	



LATEX GLOVES

W-R#	Description	Min	Box
1839006	Latex Gloves	50 pr	50 pr

- Size: Large



BLUE NITRILE GLOVES

W-R#	Description	Min	Box
1839010	Nitrile Gloves	50 pr	50 pr

- Size: Large

SPECIALTY TOOLS



STUFF-SORTER® ORGANIZER BUCKETS



W-R#	Description	Min	Box
1861000	Bucket with 4 trays	1	8
1861001	Cover	1	1
1861004	Shallow (3") Tray	1	1
1861006	Deep (6") Tray	1	1

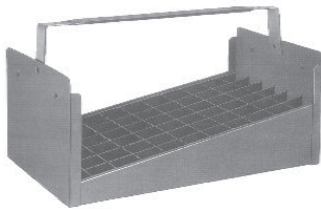

STEEL NIPPLE TRAYS

W-R#	Description	Min	Box
1871002	1/2"		
1871004	3/4"		
1871006	1"		
1871008	1 1/4"		
1871010	1 1/2"		
1871012	2"		
1871500	1/2" x 3/4"		



DRAIN-KING® DRAIN CLEANERS

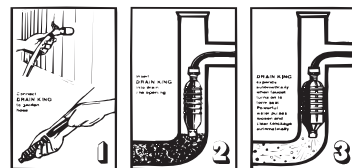

W-R#	Description	Drain King#	Min
1821000	1"-2"	501	1
1821002	1 1/2" - 3"	186	1
1821003	3" - 4"	H34	1
1821004	3" - 6"	750	1



GT WATERS FLEXIBLE MINI-SNAKE

W-R#	Description	Min	Box
1829001	Mini-Snake	1	12

- Round polypropylene shaft won't kink or bend.

SPECIALTY TOOLS



BLOCKAGE BUSTER

W-R#	Description	Min	Box
1830006	25'	1	4



ZOOM AUGER

W-R#	Description	Min	Box
1831504	1/4" x 25'	1	4

- One piece cork screw head. Tough plastic housing.



DRAIN AUGER

W-R#	Description	Min	Box
1831004	1/4" x 15'	1	6
1831006	1/4" x 25'	1	6



"MASTER" FORCE CUP W/STICK

W-R#	Description	Min	Box
1825004	W/ pullout sleeve	1	12

- 18" stick



RUBBER FORCE CUP W/STICK

W-R#	Description	Min	Box
1826002	4" (9" stick)	1	12
1826004	5" (24" stick)	1	12
1826006	6" (24" stick)	1	12



"ULTRA-FORCE" FORCE CUP W/STICK



W-R#	Description	Min	Box
1825030	"Ultra-Force" w/ pullout sleeve	1	12

- 18" stick



"PRO-FORCE" FORCE CUP W/STICK



W-R#	Description	Min	Box
1825020	"Pro-Force" w/ pullout sleeve	1	12

- 18" stick

SPECIALTY TOOLS



**BALL-TYPE FORCE CUP
W/STICK**

W-R#	Description	Min	Box
1825002	With 24" stick	1	4



**HIGH-NECK VENT
PLUNGER W/STICK**

W-R#	Description	Min	Box
1825006	High-Neck	1	12

- Used to clear external house traps
- Popular for use in Michigan & Buffalo, NY



**"HANDY HAND"
PICK-UP TOOL**

W-R#	Description	Min	Box
1824504	24"	1	6



**4-PIECE DENTAL
PICK SET**

W-R#	Description	Min	Box
1845004	4 pc. Set	1	6

- Useful for removing stubborn o-rings, & stem packing



O-RING PULLER

W-R#	Description	Min	Box
1845002	5¼"	1	6

- For easy removal of all size "O" rings and washers.

SPECIALTY TOOLS



STANDARD HANDLE PULLER

W-R#	Description	Min	Box
1824002	Standard	1	6



Sliding Handle provides "hammer" action

HAMMER-ACTION HANDLE PULLER

W-R#	Description	Min	Box
1824004	Deluxe (Hammer)	1	6



W-R "YANK-ALL" HANDLE PULLER

W-R#	Description	Min	Box
1824008	"Yank-All"	1	6

- Wider jaws fit over larger shower handles



W-R "TRI-JAW" HANDLE PULLER

W-R#	Description	Min	Box
1824010	"Tri-Jaw"	1	6

- 3 adjustable jaws to fit the most stubborn handles.



MOEN CARTRIDGE REMOVAL TOOL

W-R#	Description	Min	Box
1849000	Gold-Key	1	1

• The "Gold Key" is for the removal of both metal and plastic Moen faucet cartridges.



MOEN CARTRIDGE REMOVAL TOOL

W-R#	Description	Min	Box
1849001	T-handle	1	1

- An alternative to the gold key pattern for removal of plastic and brass Moen cartridges.

SPECIALTY TOOLS

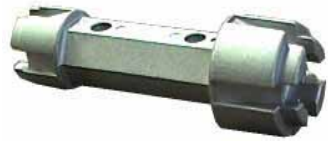

CROWN TUB DRAIN WRENCH

W-R#	Description	Min	Box
1818400		1	6

- Cast Aluminum Body
- Fits most tub drains and spuds



P.O. PLUG WRENCH

W-R#	Description	Min	Box
1818004	Wrench	1	6



4-1 P.O. PLUG WRENCH

W-R#	Description	Min	Box
1818005	4 in 1 Wrench	1	6



INTERNAL SPUD WRENCH

W-R#	Description	Min	Box
1818000	Internal Wrench	1	6

- Non-Mar wrench, made of hardened steel with plastic protected shank, can be used for removal or installation of closet spuds, large and small sink strainers, waste and overflows, etc.



4-IN-1 LOCKNUT WRENCH

W-R#	Description	Min	Box
1818142	Wrench	1	6

- Fits all size closet spuds and duo locknuts.



ADJUSTABLE LOCKNUT WRENCH

W-R#	Description	Min	Box
1818144	Locknut wrench	1	6



DUO STRAINER SPANNER WRENCH

W-R#	Description	Min	Box
1817002	Wrench	1	6

- For tightening locknut of duo strainer and sink plug. Cast Body.

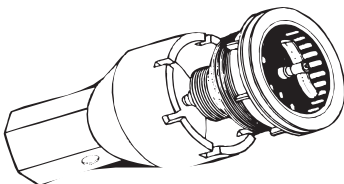

CUP-TYPE DUO STRAINER WRENCH

W-R#	Description	Min	Box
1818146	Cup-Type Wrench	1	6

- High Impact Black Plastic

SPECIALTY TOOLS



SHOWER BODY SOCKET WRENCH SET

W-R#	Description	Min	Box
1818106	7 piece set	1	25

- Consists of 5 two size sockets. For use on shower valves, faucets, bibbs and basin cocks, etc. Total pieces = 7.



INDIVIDUAL SHOWER SOCKETS

W-R#	Description	Min
1818108	21/32" x 27/32"	1
1818110	29/32" x 31/32"	1
1818112	1 1/32" x 13/32"	1



HEAVY-DUTY DOUBLE-END SHOWER SOCKET WRENCH

W-R#	Description	Min
1818008	For Savoy	1
1818010	For Gerber	1
1818012	For Price Pfister	1

- For bonnet and packing bushings and behind the wall concealed bath and shower fixtures.



SEAT WRENCH

W-R#	Description	Min	Box
1818126	Straight	1	12
1818128	Angle	1	12

• A forged steel tool to exact most all sizes of faucet seats. Features smooth, tapered ends.



GERBER SEAT WRENCH

W-R#	Description	Min	Box
1818130	F/ Gerber seats	25	25



"CROWN" RATCHET SEAT WRENCH SET

W-R#	Description	Min	Box
1818134	Ratchet wrench	1	12

• A 4-piece tool that fits most faucet seats. Packed in a pouch. Features smooth, tapered ends.

SPECIALTY TOOLS

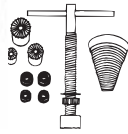

**O'MALLEY
"DRIPSTOPPER"
FAUCET RESEATER**



W-R#	Description	Min	Box
------	-------------	-----	-----

1816010 Drip stopper 1 6
 • Drip stopper set includes four hardened steel cutters, faucet washers, and guide cone for repairing faucets without cap nuts.

1816011 Shower Reamer 1 6
 - Special Design for Shower seats
 - Longer shaft to enter shower body



**BRASS-CONE
BIBB REAMER**

W-R#	Description	Min	Box
------	-------------	-----	-----

1816002 Reamer 1 6
 - Furnished with extra cutting heads.



STRAP WRENCH

W-R#	Description	Min	Box
------	-------------	-----	-----

1817016 7" handle 1 6



**TOILET SEAT
NUT WRENCH**

W-R#	Description	Min	Box
------	-------------	-----	-----

1817004 Nut wrench 1 6
 - Fits all types of nuts used on toilet seat hinges, plastic or metal.



FOLDING HEX KEY SET

W-R#	Min	Box
------	-----	-----

1818135 1 6



**T-HANDLE HEX
KEY SET**

W-R#	Size	Min	Box
------	------	-----	-----

1818137 9" 1 6

- 8 piece set



**8 PIECE ALLEN
WRENCH SET ON RING**

W-R#	Min	Box
------	-----	-----

1818140 1/16" to 1/4" 1 6

SPECIALTY TOOLS



BASIN WRENCH

W-R#	Description	Min	Box
1817006	11"	1	6
1817008	15"	1	6



**HEAVY-DUTY
ADJUSTABLE
BASIN WRENCH**

W-R#	Description	Min	Box
1817010	10" - 16"	1	6

- Display carded
- Similar to Rigid 1017!



**4-WAY
SILCOCK KEY**

W-R#	Description	Min	Box
0421004		1	10

- Fits popular make stop cocks with stems 1/4", 9/32", 5/16" and 11/32". Individually packed.



**WATER HEATER
ELEMENT WRENCH**

W-R#	Description	Min	Box
1817000	Element Wrench 1		6

- 3" length



**INSIDE DUO BASKET
WRENCH**

W-R#	Description	Min	Box
1817003	Inside Wrench	1	6

- 4" length



**RADIATOR
SPUD WRENCH**

W-R#	Description	Min	Box
1818120	Domestic	1	6
1818118	Imported	1	6



**4-1 COUNTERSUNK
PLUG WRENCH**

W-R#	Description	Min	Box
1818148	Wrench	1	6

- 3/4", 7/8", 1", 1 1/4" plugs

SPECIALTY TOOLS



NO-HUB TORQUE WRENCH

W-R#	Description	Min	Box
1818500	No-Hub Wrench 1 - 5/16" socket	1	6



CROWN DELUXE NO-HUB TORQUE WRENCH

W-R#	Description	Min	Box
1818560	60 psi Wrench 1 - 5/16" socket	1	1



NUT DRIVERS

W-R#	Description	Min	Box
1808452	5/16"	1	6



4-1 SCREW DRIVER

W-R#	Description	Min	Box
1808402	4-1 Screwdriver	1	12
1808403	6-1 Screwdriver	1	12

6-1 SCREW DRIVER



MAGNETIC ALUMINUM TORPEDO LEVEL

W-R#	Description	Min	Box
1858400	Johnson® Level	1	12



W-R#	Description	Min	Box
1858401	W-R Level	1	12



AVIATION TIN SNIPS

W-R#	Description	Min	Box
1815002	Center Snip	1	6



TAPE MEASURES

W-R#	Description	Min	Box
1808602	1" x 25'	1	6

SPECIALTY TOOLS



**STEEL-FRAME
CAULKING GUN**

W-R#	Description	Min	Box
1840104	Steel Frame	1	12



**STANDARD
CAULKING GUN**

W-R#	Description	Min	Box
1840102	Barrel Style	1	12



POINTING TROWELS

W-R#	Description	Min	Box
1808899	5" Trowel	1	10

- Philadelphia Pattern

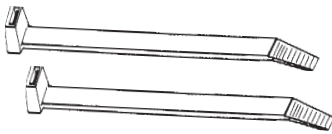

NYLON CABLE TIES



W-R#	Description	Min
1847004	4" Standard	100
1847007	7" Standard	100
1847011	11" Standard	100
1847017	17" Heavy Duty	100
1847024	24" Heavy Duty	100
1847036	36" Heavy Duty	100

- Natural color
 - Tensile Strength: Standard: 50 psi
 Heavy Duty: 175 psi



RUBBER TIE DOWNS



W-R#	Description	Min	Box
1846000	15"	1	20
1846002	21"	1	20
1846004	31"	1	20
1846006	41"	1	20



PAINT CRAYONS



W-R#	Description	Min	Box
1812500	Yellow	1	1

- Sold by the dozen only, no broken dozens

SPECIALTY TOOLS



DROP LIGHTS



W-R#	Description	Min	Box
1802020	16/3 25 ft.	1	6
1802022	16/3 50 ft.	1	6

- Metal Cage
- U.L. Approved
- Orange rubber insulation



ROUGH SERVICE LIGHT BULBS

W-R#	Description	Min	Box
1802100	75 Watt	6	48
1802102	100 Watt	6	48



EXTENSION CORDS



W-R#	Description	Min	Box
1802000	16/3 50 ft.	1	6
1802002	16/3 25 ft.	1	6

1802004	12/3 25 ft.	1	6
1802006	12/3 50 ft.	1	4
1802008	12/3 100 ft.	1	2

- U.L. approved
- Orange rubber insulation



ALKALINE BATTERIES

W-R#	Description	Min	Box
1819002	"D"	12	12
1819004	"C"	12	12
1819006	"AA"	24	24
1819008	"AAA"	24	24



INSPECTION MIRROR

W-R#	Description	Min.	Box
1802210	1 1/4" Round	1	6

- Telescoping arm



MATCH EXTENDER

W-R#	Description	Min.	Box
1802212	26" Extender	1	6

- Telescoping arm

SPECIALTY TOOLS



CLEAR SPECTACLES

W-R#	Description	Min	Box
1839512	Clear	1	12

- 100% Impact resistant
- Absorbs 99% UV light



PROTECTIVE EYE GUARD

W-R#	Description	Min	Box
1839510	Vinyl Goggles	1	12



DISPOSABLE DUST MASKS

W-R#	Description	Min	Box
1839502	5 per bag	5	50
1839503	50 per box	1 bx	12



5 LB. BOX OF RAGS

W-R#	Description	Box
1881002	5 LB Box	1



- General Purpose Wiping Rags
- Fleece Sweathsirt material



SHOP TOWELS

W-R#	Description	Bag
1881004	12 per bag	1



- Size 15" X 15"
- 100% Cotton
Highly Absorbent, Machine Washable, Recyclable.



LATEX GLOVES

W-R#	Description	Min	Box
1839006	Latex Gloves	50 pr	50 pr

- Size: Large



BLUE NITRILE GLOVES

W-R#	Description	Min	Box
1839010	Nitrile Gloves	50 pr	50 pr

- Size: Large



YELLOW MASON TWINE



W-R#	Description	Min	Box
1908002	#18 X 275'	1	12

SPECIALTY TOOLS



3" X 1000' CAUTION TAPE

W-R#	Description	Min	Box
2426006	3" x 1000'	1	12



500' TRACER WIRE



New Colors!

W-R#	Description	APWA Code
1842500	14g--Yellow	Gas/Oil
1842602	14g--Blue	Water/Irrigation
1842902	14g--Green	Sewer
1842904	14g--Purple	Reclaimed



3" X 1000' NON-DETECTABLE BURIAL TAPE



New Colors!

W-R#	Description	APWA Code
2426050	Yellow	Gas/Oil
2426060	Blue	Water/Irrigation
2426070	Green	Sewer
2426080	Purple	Reclaimed



3" X 1000' FOIL-BACKED DETECTABLE BURIAL TAPE



New Colors!

W-R#	Description	APWA Code
2426052	Yellow	Gas/Oil
2426062	Blue	Water/Irrigation
2426072	Green	Sewer
2426082	Purple	Reclaimed



MARKING STAKES



W-R#	Description	Min	Bag
2426102	Yellow	12	12
2426104	Blue	12	12
2426106	Green	12	12
2426108	Purple	12	12



MARKING SPRAY PAINT (UPSIDE-DOWN PAINT)



W-R#	Description	Min	Box
1031002	Orange	1	12
1031004	Pink	1	12
1031006	Yellow	1	12
1031008	White	1	12



MARKING PAINT WAND



W-R#	Description	Min	Box
1032002	Wand	1	2

BLACK & WHITE THE ORIGINAL **METAL FIX**

Repairs: **CRACKED & POROUS SOIL PIPE**
 BOILER & RADIATOR SECTIONS
 SPLIT FITTINGS - STRIPPED THREADS
 APPLICABLE ON ALL DEFECTIVE METALS

Ask a Master Plumber about Black & White Metal Fix.

Since 1917, plumbers have relied on Black & White Metal Fix to fix cracks in all metals. Unlike epoxy, which can take several minutes to apply and hours to cure--this mineral composite repairs cracks in minutes.

Simply heat the object to be repaired with a torch to a few hundred degrees, and press Black & White Metal Fix into the crack. A "wetting transition" occurs--the metal-fix flows into the crack--and creates a seal on the inside AND outside. Try that with epoxy!

**APPLIED ON SOIL PIPE - CAST IRON BOILERS -
 RADIATORS - STEEL - BRASS - COPPER -
 GALVANIZED IRON**

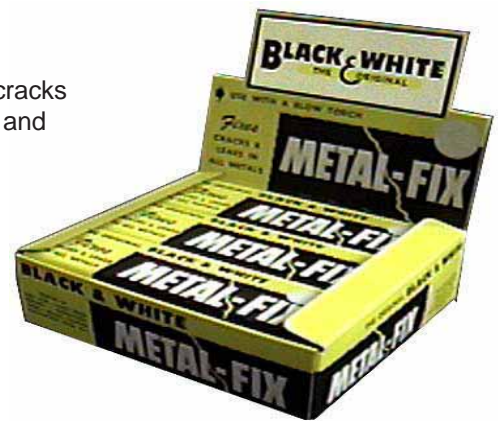

W-R#	Description	Min
1005002	Black & White Metal Fix	1 display



COLD SOLDER PASTE

W-R#	Description	Min.	Box
1007002	1½ lb can	1	12

- Versatile chemical compound used for metal glazing and filling. Applies like putty, and hardens like metal.

SPECIALTY CHEMICALS



**BLACK & WHITE®
GRAPHITE PACKING
SPOOLS**



W-R#	Description	Ft/roll	Min	Box
1900002	1/4"	8 ft	1	12
1900004	1/8"	12ft	1	12

- Non-asbestos
- Reclosable Spool



**E-Z-FIX
PACKING DISPLAY**



W-R#	Description	Min.	Box
1907102	Graphite	1	1
1907104	Teflon	1	1

- 3/32" X 20" Strands
- 24 to a display box.



STEM GREASE



W-R#	Description	Min.	Box
1650000	Stem Grease 1 oz		
1650001	Stem Grease 2 oz		

- Heat resistant



**MSP
INDUSTRIAL WRAP®
SILICONE PIPE REPAIR
TAPE**

W-R#	Description	Min.	Box
1006002	1 1/2" X 10' Roll	1	24

- Adhesive backed tape bonds to itself, forming an airtight & waterproof seal.
- Temperature range: -65°F to 500°F
- Dielectric--insulates 10,000 volts per layer
- Stops pressurized leaks up to 100 psi
- Resists UV, Oil, & other chemicals
- Made in USA





SPECIALTY CHEMICALS



PERMATEX® PIPE JOINT COMPOUND

W-R#	Description	Min.	Box
1011016	51D 1 pt.	12	12

- Seals pipes to 5000 psi.
- Prevents galling and corrosion.
- Outperforms Teflon tape. Won't shred.
- Non hardening.



PERMATEX® THREAD SEALANT WITH TEFLON

W-R#	Description	Min.	Box
1011038	14H ¼ pt.	12	12
1011039	14D 1 pt.	12	12

- Seals pipes to 5000 psi.
- Prevents galling and corrosion.
- Outperforms Teflon tape. Won't shred.
- Non hardening for easy disassembly



PERMATEX® FORM-A-GASKET NO.2®

W-R#	Description	Min.	Box
1011010	2B 3 oz. tube	12	12

- Improves gasket seal on non rigid, vibrating assemblies
- Slow Drying, flexible setting.
- Withstands pressures to 5,000 lbs.



PERMATEX® CLEAR SILICONE RUBBER ADHESIVE/ SEALANT

W-R#	Description	Min.	Box
1011034	66B 3 oz. tube	12	12

- For gasketing, sealing, bonding, and caulking
- Remains flexible
- Works to 500°



X-PANDO® PIPE JOINT COMPOUND

W-R#	Description	Min.	Box
1024002	14oz.	1	12



- For flanged or threaded joints - the compound that expands as it sets! (from .002" to .004" per cubic inch)
- Certified by Underwriters Laboratory Inc.® to NSF/ANSI 61 for drinking water. Also certified to NSF/ANSI 372 (formerly known as Annex G) as to lead content.

SPECIALTY CHEMICALS

**LEAK-LOCK® PIPE
THREAD SEALANT**



W-R#	Description	Min.	Box
<i>Original Blue Leak-Lock</i>			
1014002	1.3 oz Tube	12	12
1014004	4 oz. Bottle	12	12
1014006	16 oz. Bottle	12	12

**NOKORODE®
REGULAR SOLDER
PASTE FLUX**



W-R#	Description	Min.	Box
1008002	2 oz.	1dz	
1008004	1 lb.	1	12

NOKORODE Regular Paste Flux will not freeze or decompose. Odor & lead free. Recommended for use on all solder alloys including 95/5 and all lead free solders.

**NOKORODE®
“AQUA-FLUX”
SOLDER PASTE FLUX**



W-R#	Description	Min.	Box
1008010	1 lb.	1	12

NOKORODE AQUA FLUX For use with 95/5, 60/40, 50/50, 40/60 and other solders. Certified to NSF/ANSI 61 Annex G in compliance with AB 1953. Suitable for use with the silicon family of metal alloy products.

**UTILITY® SOLDER
PASTE FLUX**



W-R#	Description	Min.	Box
1008504	1 lb.	1	12

UTILITY Paste Flux is the original self-cleaning, lead-free flux. Recommended for all soft solder work, including 95/5.

SPECIALTY CHEMICALS

metacaulk
Firestopping Products



**RECTORSEAL®
METACAULK 1000
RED FIRESTOP CAULK**

W-R#	Description	Min.	Box
1020002	10.3 oz	1	24

- Metacaulk 1000® is a water-based fire-rated intumescent sealant used to fill the through penetrations of walls and floors. Conforms to ASTM E814, UL1479 & UL 2079 Fire Test Standards.



**GEL-GLOSS®
FIBERGLASS & MARBLE
CLEANER**

W-R#	Description	Min.	Box
1651002	12oz Aerosol	1	12

1651004	16oz Liquid	1	12
---------	-------------	---	----

- The world's Number 1 selling cleaner and polish for cultured marble and fiberglass! Recommended by major marble, fiberglass, and acrylic manufacturers.



**LIQUID WRENCH®
SUPER PENETRANT**

W-R#	Description	Min.	Box
1016004	11oz. Spray	1	12

- A powerful blend of quick-acting, fast-penetrating solvents that loosens rusted nuts, bolts, and parts in seconds.



**WD-40®
SPRAY LUBRICANT**

W-R#	Description	Min	Ctn
1021002	8 oz	1	12
1021004	11 oz	1	12

SPECIALTY CHEMICALS



BLACK SWAN® WHITE TUB & TILE CAULK

W-R#	Description	Min.	Box
1009002	6 oz	1	24
1009004	10.5 oz	1	12

- A siliconized acrylic latex caulk that permanently seals tubs, showers, tile, sinks, windows, doors, etc. It resists mildew and shrinking, remains flexible and won't crumble, and it can be painted.



BLACK SWAN® STAY-SOFT PUTTY

W-R#	Description	Min.	Box
1018002	14 oz	1	24

- A non-bleeding, plastic and elastic putty made especially for plumbers. It's not sticky and handles like modeling clay. It keeps indefinitely, and it won't shrink, crack or crumble.



WAL-RICH SHOWER PAN LINER CEMENT

W-R#	Description	Min.	Box
1013012	1 Pt.	1	12

- For joining seams of PVC shower pan liners.



PAINT CRAYONS

W-R#	Description	Min	Box
1812500	Yellow	1	1

- Sold by the dozen only, no broken dozens



8 OZ. CIRCULATOR LUBRICATING OIL

W-R#	Description	Min.	Box
1019002	8 OZ.	1	12

A special blend of non-detergent oils for lubricating oil burners, electric motors, pumps, circulators, etc.



SPECIALTY CHEMICALS



**SILVER KING®
“SQUICK”
BOILER CLEANER**



W-R#	Description	Min.	Box
1025002	5 oz.	1	12

- Removes rust, oil and scale, stops steam boiler surge instantly. Removes free oxygen, inhibits corrosion. Non hazardous. Contains no petroleum. Gives fast pure dry steam.

- Use 1 pc. 5oz can for each 150,000 BTU's



**SILVER KING®
BOILER SOLDER**



W-R#	Description	Min.	Box
1025008	16 oz.	1	12

- Stops leaks in steam and hot water boilers. Forms a water insoluble seal in old and new installations. Contains no petroleum. Stopping leaks in boilers & hot water systems for over 60 years.

- Do not use in boilers with submerged coils - use *SAFE Liquid Boiler Stop Leak*



**SILVER KING®
NUMBER 5
HYDRONIC CLEANER**



W-R#	Description	Min.	Box
1025004	1 qt.	1	12

- Inhibits corrosion, removes sludge, frees stuck zone valves, protects and lubricates entire system. Prevents clogging of automatic valves. Safe to use in all boilers. Quiets noisy boilers and circulators. Contains no petroleum. Non-hazardous.

- Use 1 qt. for each 30 gallons of system water



**SILVER KING®
SAFE STOP-LEAK**



W-R#	Description	Min.	Box
1025006	1 qt.	1	12

- Quietly stops leaks in all steel and cast iron boilers. For both steam boilers and entire hot water systems, including baseboards, copper lines and radiant heat systems. Safe to use in all boilers - contains no petroleum - will not surge - will not sludge submerged coils.

- Steam Boilers - Use 1 qt. for each 650' of radiation.

- Hot Water Systems - Use 1 qt. for each 400' of radiation.

SPECIALTY CHEMICALS



WHITE TEFLON TAPE

W-R#	Description	Min.	Box
1001002	1/2" x 260"	1	100
1001004	1/2" x 520"	1	100
1001006	3/4" x 260"	1	100
1001008	3/4" x 520"	1	100

- 3.5 mil thick (Density .4)



YELLOW TEFLON TAPE



W-R#	Description	Min.	Box
1001010	1/2" x 260"	1	100
1001020	1/2" x 520"	1	100
1001022	3/4" x 260"	1	100

- 4 mil thick (Density .9)
- Can be used for Gas applications



**BLUE-SEAL®
PREMIUM TEFLON TAPE**



W-R#	Description	Min.	Box
1001500	1/2" x 1368"	1	100
1001502	3/4" x 1368"	1	100

- 3.5 mil thick (Density .8)
- Temperature Range: -450°F-550°F



PUTTY KNIVES

W-R#	Description	Min.	Box
1818606	2" Putty Knife	1	12



FLUX BRUSHES

W-R#	Description	Min.	Box
1812002	1 Gross	1	6



DOPE BRUSH

W-R#	Description	Min.	Box
1813002	3/4"	1	36



WOOD CHIP BRUSH

W-R#	Description	Min.	Box
1814002	1"	1	12
1814006	2"	1	12

PORC-A-FIX

**PORCELAIN TOUCH-UP PAINT
FOR CHIPPED & DAMAGED FIXTURES**

**SPECIALLY BLENDED TO MATCH ORIGINAL
MANUFACTURER'S COLORS**



for American Standard

- 1010101 PORC-A-FIX WHITE AS-1
- 1010107 PORC-A-FIX BONE AS-07
- 1010111 PORC-A-FIX FAWN BEIGE AS-11
- 1010114 PORC-A-FIX HARVEST GOLD AS-14
- 1010123 PORC-A-FIX DRESDEN BLUE AS-23
- 1010128 PORC-A-FIX SAFFRON YELLOW AS-28
- 1010133 PORC-A-FIX STERLING SLVR AS-33
- 1010169 PORC-A-FIX LINEN AS-69

for Eljer

- 1010301 PORC-A-FIX WHITE, EM-01

for Gerber

- 1010402 PORC-A-FIX WHITE GB-1
- 1010414 PORC-A-FIX ALMOND GB-14

for Kohler

- 1010501 PORC-A-FIX WHITE, KK-01
- 1010514 PORC-A-FIX BLACK KK-14
- 1010528 PORC-A-FIX ALMOND, KK-28
- 1010546 PORC-A-FIX BISCUIT, KK-46

for Toto

- 1010502 PORC-A-FIX COTTON WHITE, TO-1

for Appliances

- 1010601 PORC-A-FIX BASIC WHITE, BS-1



**WHITE PORCELAIN
GLAZE**



W-R#	Description	Min.	Box
------	-------------	------	-----

1010002	1 oz.	12	12
---------	-------	----	----

- White, high-temperature touch-up paint for appliances
- Rated for up to 400°F

Table of Pipe Outside Diameters

	1/2"	3/4"	1"	1 1/4"	1 1/2"	2"	3"	4"	5"	6"	8"	10"	12"
Steel	.84	1.05	1.32	1.66	1.90	2.38	3.50	4.50	5.56	6.63	8.63	10.75	12.75
Copper	.63	.88	1.13	1.38	1.63	2.13	3.13	4.13	5.13	6.13	-	-	-
PVC	.84	1.05	1.32	1.66	1.90	2.38	3.50	4.50	5.56	6.63	8.63	10.75	12.75
DIP A	-	-	-	-	-	2.50	3.80	4.80	-	6.90	9.05	11.10	13.20
DIP B	-	-	-	-	-	-	3.96	5.00	-	7.10	9.05	11.10	13.20
DIP C/D	-	-	-	-	-	-	3.96	5.00	-	7.10	9.30	11.40	13.50
CIP	-	-	-	-	-	2.30	3.30	4.30	5.30	6.30	8.40	10.50	12.50
AA Lead	(5/8)1.10	1.23	1.51	1.78	2.09	2.77	-	-	-	-	-	-	-

Conversion Data:

- Foot 0.3048 meters
- Gallon 3.78 liters
- Inch 0.0278 yards
- Inch 0.083 feet
- Inch 25.40 millimeters
- Kilogram 2.20 pounds
- Liter 0.264 gallons
- Meter 3.28 feet
- Millimeter 0.039 inches
- Ounce 0.0625 pounds
- Pound 16 ounces
- PSI 2.31 feet of water
- PSI 6.89 kPA

- Circumference: π diameter
- Diameter: Circumference/ π
- π : 3.14



PLEASE COMPLETE THIS CREDIT APPLICATION TO ESTABLISH AN ACCOUNT WITH WAL-RICH CORPORATION. YOUR ASSISTANCE IN PROVIDING US WITH COMPLETE INFORMATION WILL ENSURE THAT YOUR ORDER IS SHIPPED PROMPTLY. THE WAL-RICH TEAM THANKS YOU FOR YOUR ORDER!

YOUR COMPANY INFORMATION

COMPANY NAME: _____

SHIPPING ADDRESS: _____

BILLING ADDRESS: _____

CITY: _____ **STATE:** _____ **ZIP:** _____

PHONE: _____ **FAX:** _____

PURCHASING CONTACT: _____ **A/P CONTACT:** _____

TYPE OF BUSINESS: _____

STATE RESALE # _____

TRADE REFERENCES

COMPANY NAME: _____

ADDRESS: _____

CITY: _____ **STATE:** _____ **ZIP:** _____

PHONE: _____ **FAX:** _____

COMPANY NAME: _____

ADDRESS: _____

CITY: _____ **STATE:** _____ **ZIP:** _____

PHONE: _____ **FAX:** _____

COMPANY NAME: _____

ADDRESS: _____

CITY: _____ **STATE:** _____ **ZIP:** _____

PHONE: _____ **FAX:** _____

COMPANY NAME: _____

ADDRESS: _____

CITY: _____ **STATE:** _____ **ZIP:** _____

PHONE: _____ **FAX:** _____

BANK REFERENCE

BANK NAME: _____

ADDRESS: _____

CITY: _____ **STATE:** _____ **ZIP:** _____

PHONE: _____ **FAX:** _____

SHIPPING INSTRUCTIONS

PENDING CREDIT APPROVAL, SHIP THIS ORDER ASAP VIA CREDIT CARD

INSTRUCTIONS: _____

We certify that all the information on this form is correct, and fully understand Wal-Rich's credit terms. We agree to proper payment in consideration of extended credit.

Authorized Signature (required) _____ **Title** _____

Print Name _____ **Date** _____