

## User's Information Manual

CONDENSING GAS BOILER  
220/299/300/399



**WARNING**

If the information in this manual is not followed exactly, a fire or explosion may result, causing property damage, personal injury or loss of life.

Do not store or use gasoline or other flammable vapors and liquids in the vicinity of this or any other appliance.

— WHAT TO DO IF YOU SMELL GAS —

- Do not try to light any appliance.
- Do not touch any electrical switch; do not use any telephone in your building.
- Immediately call your gas supplier from a neighbor's telephone. Follow the gas supplier's instructions.
- If you cannot reach your gas supplier, call the fire department.

Installation & service must be performed by a qualified installer, service technician or the gas supplier.



# Please read this page first

| To . . .                             | Read and use . . .  | Page      |
|--------------------------------------|---|-----------|
| <b>Locate boiler components</b>      | See illustration at right   | <b>2</b>  |
| <b>Learn precautions</b>             | See Hazard Definitions, below   | <b>2</b>  |
| <b>Read before proceeding</b>        | <b>Additional information</b>   | <b>3</b>  |
| <b>Prevent air contamination</b>     | <b>Laundry room or pool</b> — make sure boiler air is piped to boiler per manual. Read list of air contaminants you must avoid. <b>Have boiler air re-piped to another location if you can't avoid.</b> | <b>4</b>  |
| <b>Maintain boiler</b>               | Set up a <b>plan for maintaining the boiler</b> using the schedule included in this manual. Schedule an <b>annual start-up</b> by a qualified service technician before every heating season.           | <b>5</b>  |
| <b>Start — or — Shut down boiler</b> | Follow the <b>Operating instruction</b> sheet details to start or shut down your boiler.  | <b>9</b>  |
| <b>Understand control display</b>    | This page shows display screen modes and menu access information.   | <b>10</b> |
|                                      | This page shows how to access the USER MENU to set date and time and reset faults if the boiler enters LOCKOUT.   | <b>11</b> |

## Evergreen Boiler components

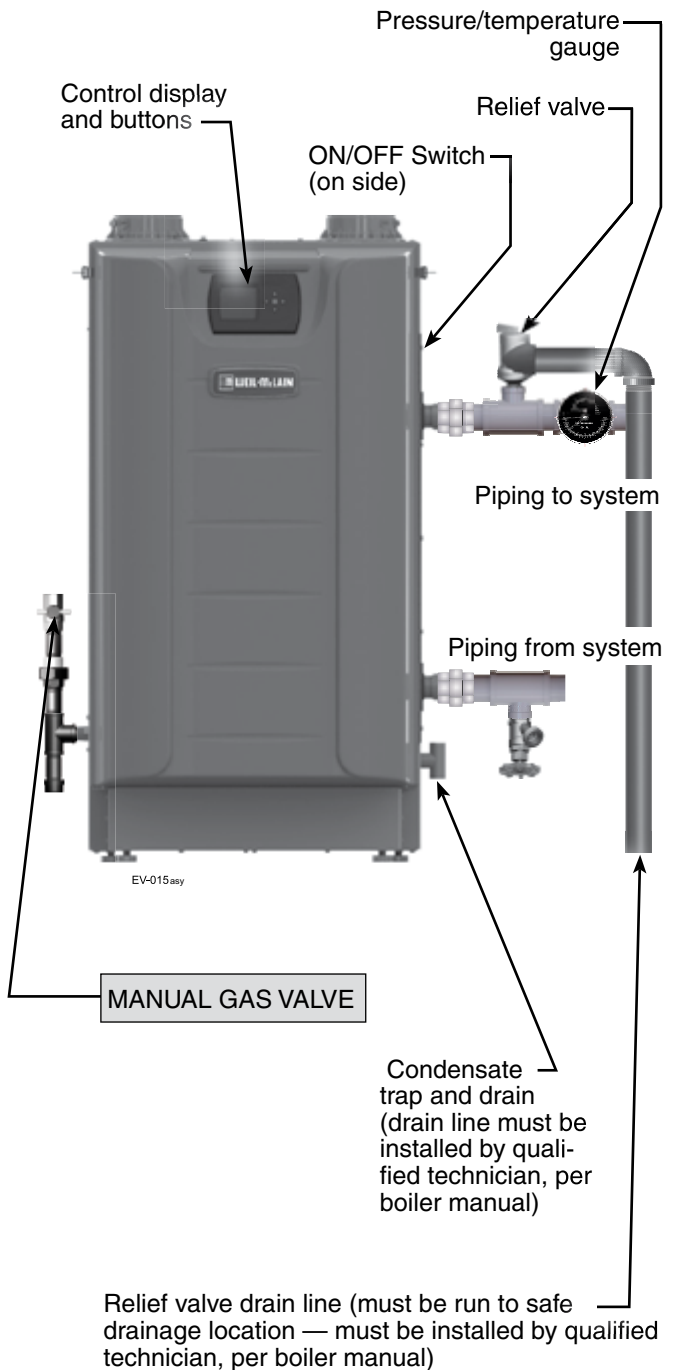

### Hazard definitions

The following defined terms are used throughout this manual to bring attention to the presence of hazards of various risk levels or to important information concerning the life of the product.

**⚠ DANGER** Indicates presence of hazards that will cause severe personal injury, death or substantial property damage.

**⚠ WARNING** Indicates presence of hazards that can cause severe personal injury, death or substantial property damage.

**⚠ CAUTION** Indicates presence of hazards that will or can cause minor personal injury or property damage.

**NOTICE** Indicates special instructions on installation, operation or maintenance that are important but not related to personal injury or property damage.



# STOP!! — Read before proceeding

**⚠ WARNING**

**Have this boiler serviced/inspected by a qualified service technician, at least annually.**

Failure to comply with the above could result in severe personal injury, death or substantial property damage.

**NOTICE**

When calling or writing about the boiler— Please have the boiler model number from the boiler rating label and the CP number from the boiler cabinet.

- **Should overheating of boiler occur or gas supply fail to shut off, DO NOT** turn off or disconnect electrical supply to circulator. Instead, shut off the gas supply at a location external to the appliance.
- **Do not use this boiler if any part has been under water.** Immediately call a qualified service technician to inspect the boiler and to replace any part of the control system and any gas control that has been under water.

**⚠ WARNING**

**Failure to adhere to the guidelines on this page can result in severe personal injury, death or substantial property damage.**

### Boiler service and maintenance —

- To avoid electric shock, **interrupt electrical supply** before performing maintenance.
- To avoid severe burns, **allow boiler to cool** before performing maintenance.
- You must **maintain** the boiler as outlined in the manual and have the boiler **started up and serviced at least annually by a qualified service technician** to ensure boiler/system reliability.

### Boiler operation —

- Do not block flow of combustion or ventilation air to boiler. This boiler is equipped with a control which will automatically shut down the boiler should air or vent be blocked. If vent or air blockage is easily accessible and removable, remove it. The boiler should attempt to restart within an hour. If blockage is not obvious or cannot be removed, have the boiler and system checked by a qualified service technician.

### Combustion air —

- **DO NOT obstruct the combustion air intake or expose the air intake to corrosive chemicals (see next page).**

### Carbon monoxide detector —

- A carbon monoxide detector that is wired on the same electrical circuit as the boiler is strongly recommended.

### Boiler water —

- Do not use petroleum-based cleaning or sealing compounds in boiler system. Gaskets and seals in the system may be damaged. This can result in substantial property damage.
- **Leaks in boiler or piping must be repaired at once to prevent make-up water. Use this boiler ONLY in a closed-loop system.** Continual fresh make-up water will reduce boiler life. Mineral buildup in heat exchangers reduces heat transfer, overheats the materials, and causes failure. Addition of oxygen carried in by make-up water can cause internal corrosion.
- **Do not add cold water to hot boiler.** Thermal shock can cause heat exchanger to crack.

### Freeze protection fluids —

- NEVER use automotive or standard glycol antifreeze. Use only freeze-protection fluids made for hydronic systems. Follow all guidelines given by the antifreeze manufacturer. Thoroughly clean and flush any replacement boiler system that has used glycol before installing the new boiler.



# Prevent combustion air contamination

## Air contamination

Common household and hobby products often contain fluorine or chlorine compounds. When these chemicals pass through the boiler, they can form strong acids in the vent system or boiler. These acids can eat through the vent or boiler wall, causing serious damage and presenting a possible threat of flue gas spillage into the building.

Please read the information on this page.

**⚠ WARNING** If the boiler combustion air inlet is located in any area likely to cause contamination, or if products which would contaminate the air cannot be removed, you must have the combustion air and vent re-piped and terminated to another location.

Contaminated combustion air will damage the boiler, resulting in possible severe personal injury, death or substantial property damage.

## Combustion air contamination:

**⚠ WARNING** Ensure that the combustion air will not contain any of the contaminants in Figure 1.

Combustion air supply openings or intake terminations must NOT be near a swimming pool, for example.

Avoid areas subject to exhaust fumes from laundry facilities. These areas will always contain contaminants.

**Figure 1** Corrosive contaminants and sources

| Products to avoid  |
|--|
| Spray cans containing chloro/fluorocarbons   |
| Permanent wave solutions   |
| Chlorinated waxes/cleaners   |
| Chlorine-based swimming pool chemicals   |
| Calcium chloride used for thawing  |
| Sodium chloride used for water softening   |
| Refrigerant leaks  |
| Paint or varnish removers  |
| Hydrochloric acid/muriatic acid  |
| Cements and glues  |
| Antistatic fabric softeners used in clothes dryers   |
| Chlorine-type bleaches, detergents, and cleaning solvents found in household laundry rooms |
| Adhesives used to fasten building products and other similar products                      |
| Excessive dust and dirt  |
| Areas likely to have contaminants  |
| Dry cleaning/laundry areas and establishments  |
| Swimming pools   |
| Metal fabrication plants   |
| Beauty shops   |
| Refrigeration repair shops   |
| Photo processing plants  |
| Auto body shops  |
| Plastic manufacturing plants   |
| Furniture refinishing areas and establishments   |
| New building construction  |



# Annual startup and general maintenance

Figure 2 Service and maintenance schedules

| <b>OWNER MAINTENANCE</b> (see the following pages for instructions) |  |
|---|--|
| <b>BEGINNING OF SEASON</b>  | <p>Contact your boiler service technician to inspect, service and start up your boiler. <b>You must have an annual start-up performed by a qualified service technician</b> to ensure reliable operation of the boiler and system.</p>                               |
| <b>DAILY</b>  | <ul style="list-style-type: none"> <li>• Check boiler area.</li> <li>• Check air openings.</li> <li>• Check pressure/temperature gauge.</li> <li>• Verify boiler jacket door is securely closed.</li> </ul>  |
| <b>MONTHLY</b>  | <ul style="list-style-type: none"> <li>• Check vent piping.</li> <li>• Check air piping.</li> <li>• Check relief valve.</li> <li>• Check condensate drain system.</li> <li>• Check automatic air vents (if used).</li> <li>• Check display date and time.</li> </ul> |
| <b>EVERY 6 MONTHS</b>   | <ul style="list-style-type: none"> <li>• Check boiler piping (gas and water).</li> <li>• Operate relief valve.</li> </ul>  |



**WARNING** Follow the service and maintenance procedures given throughout this manual and in component literature shipped with the boiler. Failure to perform the service and maintenance could result in damage to the boiler or system. Failure to follow the directions in this manual and component literature could result in severe personal injury, death or substantial property damage.



# User maintenance procedures

**Boiler must be serviced and maintained**



The boiler should be inspected and started annually, at the beginning of the heating season, only by a qualified service technician. In addition, the maintenance and care of the boiler designated on page 5 and explained on the following pages must be performed to assure maximum boiler efficiency and reliability. Failure to service and maintain the boiler and system could result in equipment failure, causing possible severe personal injury, death or substantial property damage.



The following information provides detailed instructions for completing the maintenance items listed in the maintenance schedule, page 5. In addition to this maintenance, the boiler must be serviced and started up at the beginning of each heating season by a qualified service technician.

**DAILY Maintenance**

## Check boiler area



To prevent potential of severe personal injury, death or substantial property damage, eliminate all materials discussed below from the boiler vicinity. If contaminants are found:

Remove products immediately from the area. If they have been there for an extended period, call a qualified service technician to inspect the boiler and vent system for possible damage from acid corrosion.

If products cannot be removed, immediately call a qualified service technician to address the problem.

1. Combustible/flammable materials — Do not store combustible materials, gasoline or any other flammable vapors or liquids near the boiler. Remove immediately if found.
2. Air contaminants — Products containing chlorine or fluorine, if allowed to contaminate the boiler intake air, will cause acidic condensate in the vent and boiler. This will cause significant damage to the vent and/or boiler if allowed to continue.
3. Read the list of potential materials listed on page 4 of this manual. If any of these products are in the room from which the boiler takes its combustion air, they must be removed immediately or the boiler combustion air must be supplied from outside.
4. See WARNING above.

## Check air openings

1. Verify that combustion and ventilation air openings to the boiler room and/or building are open and unobstructed.
2. Verify that boiler vent discharge and air intake are clean and free of obstructions. Remove any debris on the air intake or flue exhaust openings.

## Check boiler pressure/temperature gauge

1. Make sure the pressure reading on the boiler pressure/temperature gauge does not exceed 24 psig, if using a 30 psig relief valve (typical installation). Higher pressure may indicate a problem with the expansion tank.
2. Contact a qualified service technician if problem persists.

## Verify that front door is securely closed

1. Visually inspect front door to be sure it is sealed all around its perimeter. Verify that the two door latches are secure.



The front door must be securely fastened to the boiler to prevent boiler from drawing air from inside the boiler room. Secure latches.

This is particularly important if the boiler is located in the same room as other appliances.

Failure to keep the door securely fastened could result in severe personal injury or death.

Contact your installer or technician immediately if the front door does not close correctly or if the door gaskets are damaged.

# User maintenance procedures *(continued)*

## MONTHLY Maintenance

### Check vent & air piping

1. Visually inspect the flue gas vent piping and air piping for any signs of blockage, leakage or deterioration of the piping. Notify your qualified service technician at once if you find any problem.

**⚠ WARNING** Failure to inspect the vent/air system as noted above and have them repaired by a qualified service technician can result in vent system failure, causing severe personal injury or death.

### Check the relief valve

1. Inspect the boiler relief valve and the relief valve discharge pipe for signs of weeping or leakage.
2. If the relief valve often weeps, the expansion tank may not be working properly. Immediately contact your qualified service technician to inspect the boiler and system.

### Check the condensate drain system

1. While the boiler is running, check the discharge end of the condensate drain tubing and the open top of the condensate tee at the boiler (see Figure 3 for locations). Make sure no flue gas is escaping from the condensate drain tubing or tee by holding your fingers in front of the opening.
2. If you notice flue gas escaping, this indicates a dry condensate drain trap. See step 4 for procedure to fill trap. Call your qualified service technician to inspect the boiler and condensate line and refill the condensate trap if problem persists regularly.

**⚠ WARNING** Under some circumstances, the vent system may not produce enough condensate to keep the condensate trap full of liquid. If the trap is not full, small amounts of flue products can be emitted into the boiler room through the condensate drain line or tee. Follow procedure below to fill trap.

3. Verify that the condensate drain line is unobstructed by slowly pouring water into the top of the PVC tee on the side of the boiler. The water should run out the end of the condensate drain line. If the water does not run out, call your qualified service technician to inspect the boiler and clean or replace the condensate drain line.
4. To fill the condensate trap, if necessary, temporarily plug the end of the condensate drain line. Then slowly pour water into the ½ inch plastic tee on boiler right side. Pour until water fills drain line, then overflows into the boiler trap tubing. When water fills up to top of ½ inch tee, stop filling. Remove temporary plug from end of condensate drain line.

**Figure 3** Boiler condensate trap

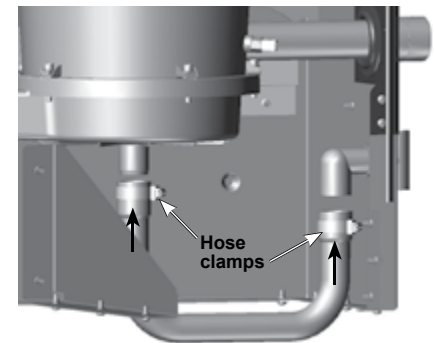

### Check automatic air vents (if used — automatic air vents must be used with diaphragm-type expansion tanks only)

1. See Figure 4.
2. Remove the cap from any automatic air vent in the system and check operation by depressing valve “B” slightly with the tip of a screwdriver.

**⚠ WARNING** **Scald hazard** — Water from air vent may be very hot. Avoid contact to prevent possible severe personal injury.

3. If the air vent valve appears to be working freely and not leaking, replace cap “A”, twisting all the way on.
4. Loosen cap “A” one turn to allow vent to operate.
5. Have vent replaced if it does not operate correctly.

**Figure 4** Automatic air vent

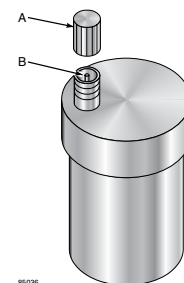

### Check display date and time

1. Observe the date and time shown on page 11 (the Weil-McLain logo on the control display).
2. If the date or time is incorrect, follow the instructions in Figure 8, page 11 to access the USER MENU and change the date and/or time settings.
3. Keeping the date and time current makes sure the control can record problems accurately.



## User maintenance procedures *(continued)*

### EVERY 6 MONTHS Maintenance

#### Check boiler piping

1. Check all gas lines and smell for gas odors. Perform gas leak inspection per steps 1 through 7, Operating Instructions, page 9. If gas odor or leak is detected, immediately shut down boiler following procedures on page 9. Call a qualified service technician.
2. Visually inspect for water leaks around all piping, circulators, relief valves and other fittings.
3. Immediately call a qualified service technician to repair any leaks.

**▲WARNING** Have leaks fixed at once by a qualified service technician. Continual fresh makeup water will reduce boiler life. Minerals can build up in the heat exchanger, reducing heat transfer and causing overheating. Heat exchanger failure can occur.

**▲WARNING** Do not use **petroleum-based cleaning or sealing compounds** in boiler system. Severe damage to boiler and system components can occur, resulting in possible severe personal injury, death or substantial property damage.

#### Operate boiler relief valve

1. Before proceeding, verify that the relief valve outlet has been piped to a safe place of discharge, avoiding any possibility of scalding from hot water.
2. Read the boiler pressure/temperature gauge to make sure the system is pressurized. Record pressure in system to refer to after checking relief valve

3. Lift the relief valve top lever slightly, allowing water to relieve through the valve and discharge piping.
4. If water flows freely, release the lever and allow the valve to seat. Watch the end of the relief valve discharge pipe to ensure that the valve does not weep after the line has had time to drain. If the valve weeps, lift the seat again to attempt to clean the valve seat. If the valve continues to weep afterwards, contact your qualified service technician to inspect the valve and system.
5. If water does not flow from the valve when you lift the lever completely, the valve or discharge line may be blocked. Immediately shut down the boiler, following the lighting instructions on the inside jacket top. Call your qualified service technician to inspect the boiler and system.

**▲WARNING** To avoid water damage or scalding due to valve operation, a metal discharge line must be connected to relief valve outlet and run to a safe place of disposal. This discharge line must be installed by a qualified heating installer or service technician in accordance with the instructions in the **Evergreen™ Boiler Manual**. The discharge line must be terminated so as to eliminate possibility of severe burns should the valve discharge.

6. Verify and compare boiler pressure returns to recorded value before checking the relief valve. If pressure does not return to proper value, call a qualified heating installer or service technician.





# OPERATING INSTRUCTIONS

Figure 5 Operating instructions (see page 2 for location of manual gas valve)

## FOR YOUR SAFETY — READ BEFORE OPERATING



**WARNING** If you do not follow these instructions exactly, a fire or explosion may result causing property damage, personal injury or loss of life.

- A. This appliance does not have a pilot. It is equipped with an ignition device which automatically lights the burner. Do not try to light the burner by hand.
- B. Before OPERATING, smell all around the appliance area for gas. Be sure to smell next to the floor because some gas is heavier than air and will settle on the floor. See below.
- C. Use only your hand to turn the gas control knob. Never use tools. If the knob will not turn by hand, don't try to repair it, call a qualified service technician. Force or attempted repair may result in a fire or explosion.
- D. Do not use this appliance if any part has been under water. Immediately call a qualified service technician to inspect the appliance and to replace any part of the control system and any gas control, which has been under water.

## WHAT TO DO IF YOU SMELL GAS

- Do not try to light any appliance.
- Do not touch any electric switch; do not use any phone in your building.
- Immediately call your gas supplier from a neighbor's phone. Follow the gas supplier's instructions.
- If you cannot reach your gas supplier, call the fire department.

## OPERATING INSTRUCTIONS

1. **STOP!** Read the safety information above on this label. This appliance is equipped with an ignition device which automatically lights the burner. Do not try to light the burner by hand.
2. Set room thermostat(s) to lowest setting.
3. Turn OFF all electrical power to the appliance.
4. Locate boiler manual gas valve (in the gas piping connected to the boiler).
5. Turn boiler manual gas valve knob counterclockwise ↺ to OPEN gas supply.
6. Wait five (5) minutes to clear out any gas. Then smell for gas, including near the floor.
7. If you smell gas, **STOP!** Turn the boiler manual gas valve to OFF. Then follow WHAT TO DO IF YOU SMELL GAS, above. If you don't smell gas, go to step 8, below.
8. Turn ON all electrical power to the appliance.
9. Set thermostat(s) to desired setting.
10. The boiler display will show symbols and/or text describing the status of the boiler as it proceeds through its operating sequence. "Standby" status means the burner is off.
11. If the appliance will not operate when there is a call for heat and piping is not hot, follow the instructions "To Turn Off Gas To Appliance" below and call your service technician or gas supplier.

### Gas valve CLOSED

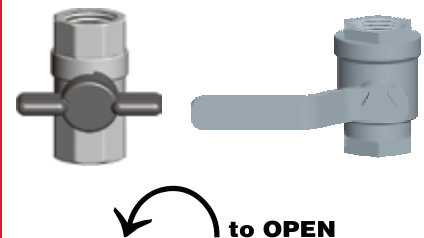

### Gas valve OPEN

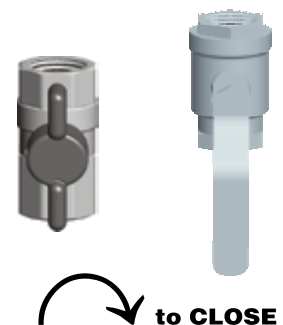

## TO TURN OFF GAS TO THE APPLIANCE

1. Set room thermostats to lowest setting.
2. Turn OFF all electrical power to the appliance.
3. Turn boiler manual gas valve knob clockwise ↻ to close gas supply.

550-101-264 (0614)



# The Evergreen control display

Figure 6 Evergreen™ boiler control display states

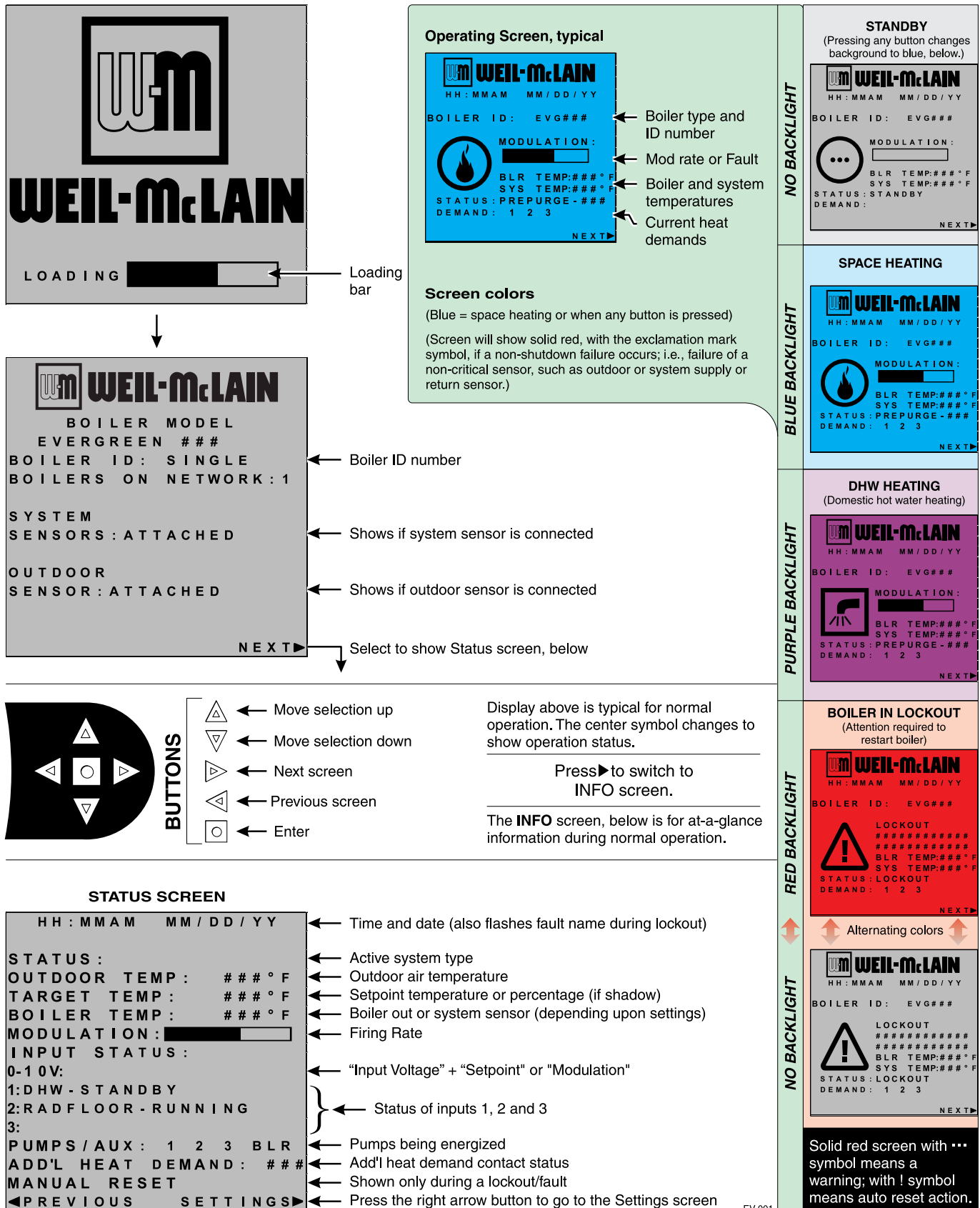

EV-001



# The Evergreen control display *(continued)*

**Figure 7** Evergreen™ boiler control display **USER Menu** — (set date and time, reset faults).

**BOILER STATUS screen**

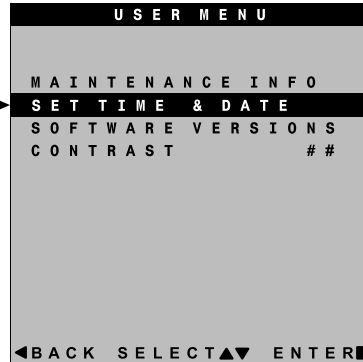
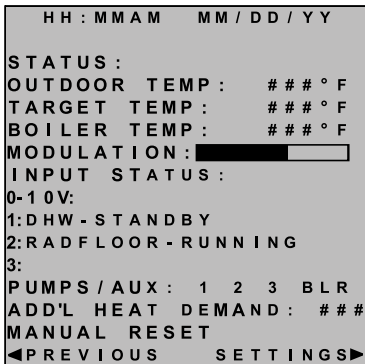

EV-001-bs-1

**Date and time**

1. Set month, date, year, hour and minutes.
2. Keeping the date and time current makes sure the control can record problems accurately.

**Figure 8** Evergreen™ boiler control display **LOCKOUT SCREEN** — screen turns red when boiler locks out — highlight and select **MANUAL RESET** to reset boiler as shown below.

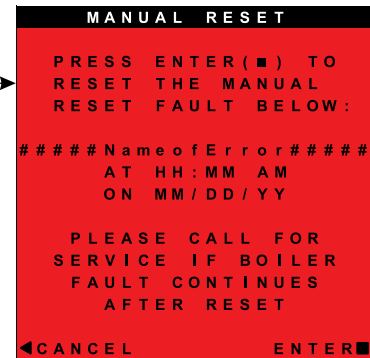
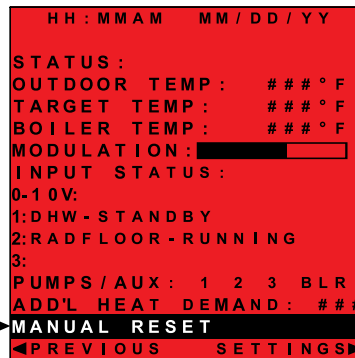
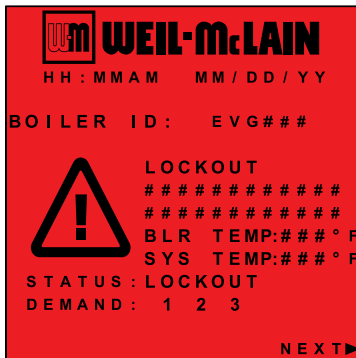

**Resetting faults:**

1. During a fault, the status will change to LOCKOUT and the Time & Date line will alternate with the fault name. The line MANUAL RESET will appear on the Boiler Status screen.
2. Select **MANUAL RESET** to reset fault condition.
3. The **MANUAL RESET** screen will indicate whether the fault was a manual or automatic reset, the fault name, and the time and date it occurred.
4. Call for service if fault continues.

**Figure 9** Evergreen™ boiler control display **Maintenance** notice screens.

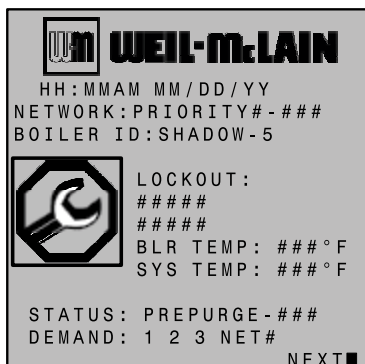

The display flashes blue and shows the "Wrench" symbol to indicate a situation requiring service attention. The screen alternates between the "Wrench" screen and the "Maintenance" screen. This only occurs during standby, not during boiler operation. Press ENTER to go to RESET REMINDER. After resetting, the control will no longer show the "Wrench" screen.



