

APPLICATION

R8239 Fan Center—use for heating, cooling or heating-cooling system.

AT72H,J Plate-mounted Transformer-Relay Receptacle—use when cooling will be added later.

Q633A Plate-mounted Relay Receptacle—use to install R8222 and R8228 Relays on J boxes.

Above devices provide low voltage control of line voltage fan motors and auxiliary circuits in heating, cooling, or heating-cooling systems.

INSTALLATION

WHEN INSTALLING THIS PRODUCT . . .

1. Read these instructions carefully. Failure to follow them could damage the product or cause a hazardous condition.
2. Check the ratings given in the instructions and on the product to make sure the product is suitable for your application.
3. Installer must be a trained, experienced service technician.
4. After installation is complete, check out product operation as provided in these instructions.

CAUTION

Disconnect power supply before beginning installation to prevent electrical shock and equipment damage.

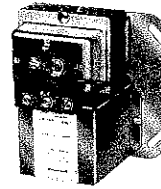

Fig. 1—R8239A-H, Fan Center.

MOUNTING

The R8239, AT72H,J and Q633A1007 mount on a standard 4 inch square junction box. Make wiring connections in the junction box; then fasten the fan center to the box, placing the junction box screws through notches in the fan center mounting plate.

TABLE I — R8239 MODEL DESCRIPTION

FAN CENTER	REPLACEMENT COMPONENTS ^a : RELAY TRANSFORMER AND RECEPTACLE	RELAY HORSE- POWER	SWITCHING	POLE	LEADWIRE COLOR	SEE WIRING DIAGRAM
R8239A	AT72H/ R8222B	3/4	Spdt	—	Black—common Red—N.O. contact Brown—N.C. contact	Fig. 2
R8239B	AT72J/ R8222D	3/4	Dpdt	Pole 1	Black—common Red—N.O. contact Brown—N.C. contact	Fig. 3
				Pole 2	Violet—common Red/Yellow—N.O. contact Yellow—N.C. contact	
R8239C	AT72H/R8222A	3/4	Spst, N.O.	—	Both leadwires black—N.O. contact	Fig. 4
R8239D	AT72J/ R8222U	3/4	Dpst, 1 N.O. power contact 1 N.O. pilot duty contact	Pole 1 (power pole)	Both leadwires black—N.O. contact	Fig. 5,9
				Pole 2 (pilot duty pole)	Both leadwires red—N.O. contact	
R8239E	AT72J/ R8222F	3/4	Dpst 1 N.O. 1 N.C.	Pole 1 Pole 2	Both leadwires black—N.O. contact Both leadwires red—N.C. contact	Fig. 6
R8239F	AT72J/ R8228C	3/4	Dpst Both N.C.	Pole 1 Pole 2	Both leadwires black—N.O. contact Both leadwires red—N.O. contact	Fig. 5
R8239G	AT72H/R8228A	1 ^b	Spst, N.O. contact	—	Both leadwires black—N.O. contact	Fig. 4
R8239H	AT72H/ R8228B	1 ^b	Spdt	—	Black—common Red—N.O. contact Brown—N.C. contact	Fig. 2

^a AT72H,J and appropriate relay can be ordered separately.

^b 1 hp at 120 Vac; 2 hp at 240 Vac.

On Q633A or AT72H,J Receptacles without relays, select and mount the appropriate relay and attach the relay cover. A label identifying the relay used (furnished with TRADELINE models) should be applied to the relay cover.

NOTE: Relay may be mounted in any position. With the terminals pointing down, pickup voltage is increased by 12 percent.

WIRING

All wiring must comply with local codes and ordinances. Refer to information furnished with the system equipment or refer to Figs. 2-6 showing internal schematics and typical hookups for the fan centers. See Fig. 5—R8239F; Fig. 7—Q633A1007; Fig. 9—typical hookup for R8239D in an intermittent Pilot system.

IMPORTANT

When making external connections to the line voltage leadwires of this device, use only Underwriters Laboratories Inc. listed connectors.

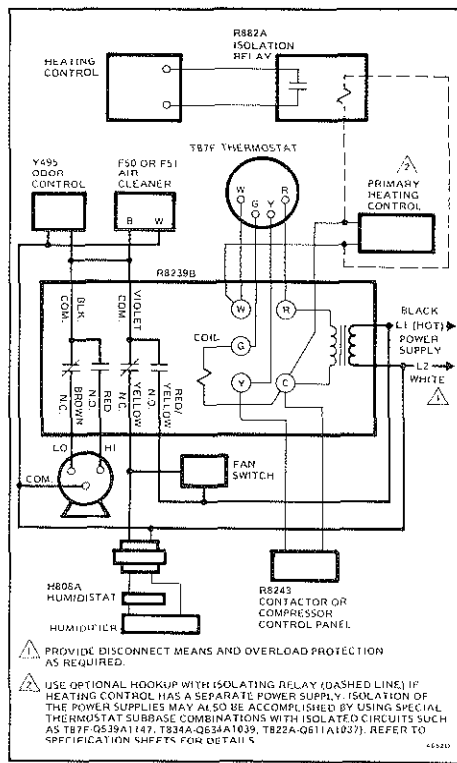

Fig. 3—R8239B typical hookup with 2-speed fan. "Total Comfort" application provided with electronic air cleaner, humidifier and blower motor.

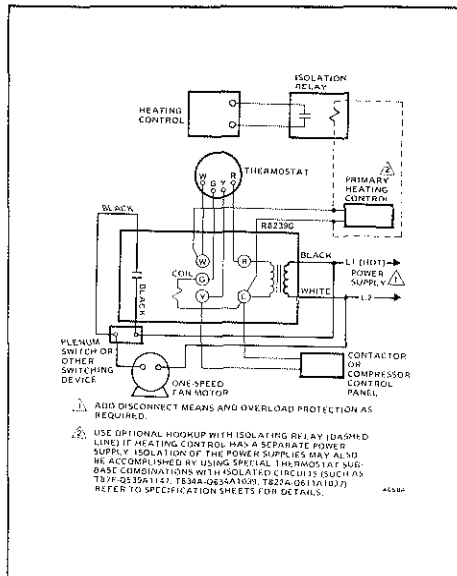

Fig. 4—R8239C,G typical hookup with 1-speed fan in heating-cooling system.

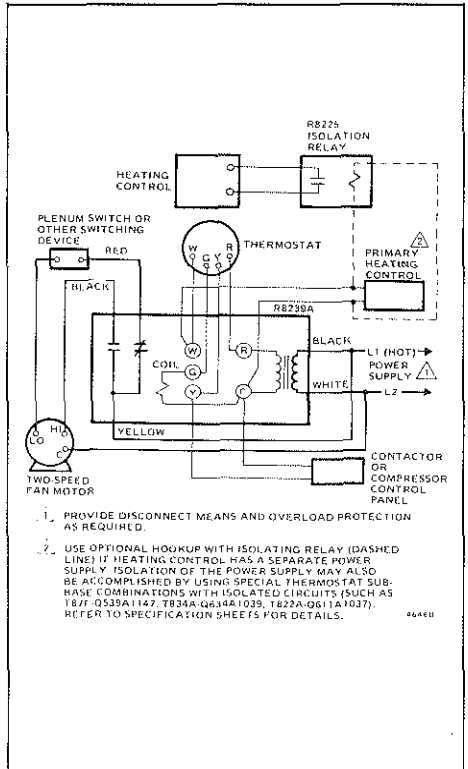

Fig. 2—R8239A,H typical hookup with 2-speed fan in heating-cooling system.

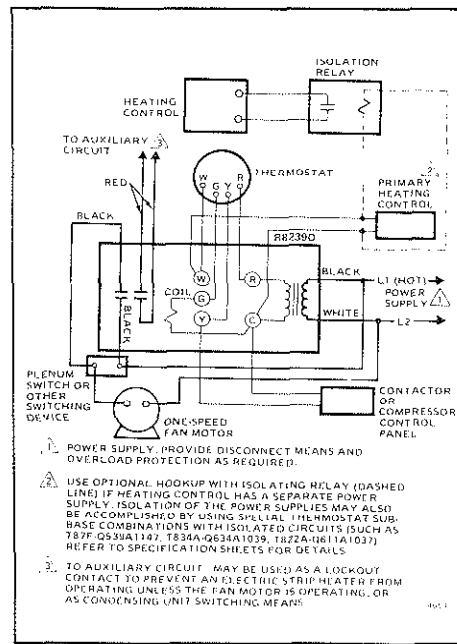

Fig. 5—Typical hookup R8239D with 1-speed fan in heating-cooling system and pilot duty contacts to power auxiliary circuit. R8239F is similar, but has 2 normally open power rated contacts.

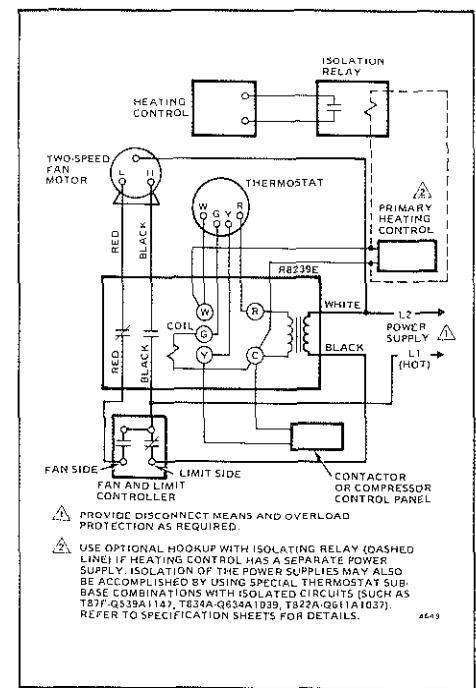

Fig. 6—R8239E typical hookup with 2-speed fan and limit controller in heating-cooling system.

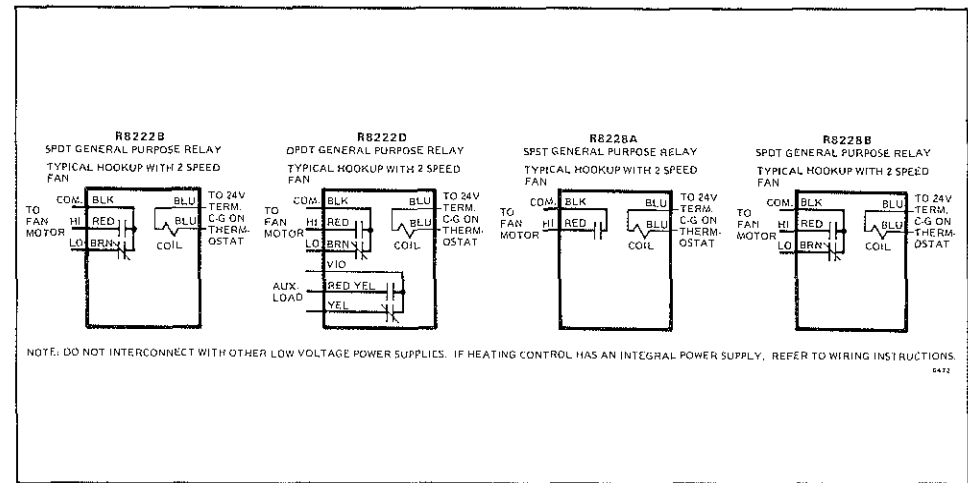

Fig. 7—Q633A1007 receptacle plate wiring hookups with typical relays.

On Q633A1007 Plate-mounted Relay Receptacle, lead-wires are provided for additional relay pole positions. Insert the required leadwires in the relay receptacle as follows.

Determine the leadwire colors required for the relay and application desired (Fig. 7). Push the leadwire terminal into the receptacle plate from the side stamped with the color code (Fig. 8). When inserting the leadwire, the tang on the quick-connect terminal must align with the small clearance slot in the terminal opening. Press the terminal in until it locks in place.

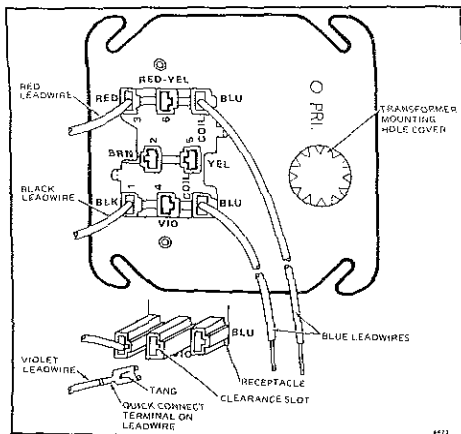

Fig. 8—Bottom of O633A1007 plate-mounted Relay Receptacle showing leadwire installation.

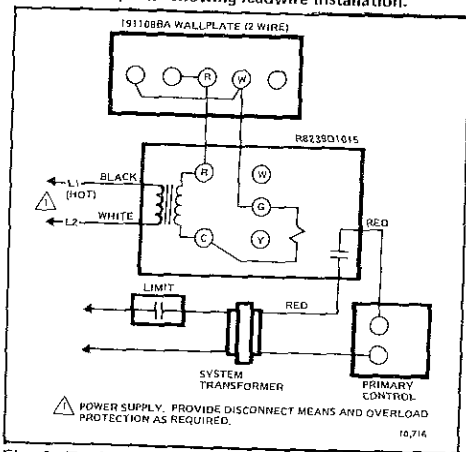

Fig. 9—Typical hookup for R8239D used as isolating relay in an intermittent pilot system.

CHECKOUT

Always conduct a thorough checkout when installation is complete. Place the system into operation. Operate the system through at least one complete cycle to make sure that the system equipment and the fan center operates as intended.

SERVICE

CAUTION

Disconnect the power supply to prevent electrical shock and equipment damage.

The relay in the R8239 is field replaceable. See Table 1—Model Descriptions on page 1 for appropriate relay. To replace the relay use the following procedure:

1. Remove the 2 relay cover screws and remove the cover.
2. Remove the plug-in relay from the receptacle, and replace with new relay.
3. Replace the cover and 2 screws removed in step 1.

Dear Customer,

We welcome your comments and suggestions for improving this publication. Your assistance is greatly appreciated and will enable us to provide better technical information for you.

Please send your comments and suggestions to:
 Honeywell Inc.
 10400 Yellow Circle Drive
 Minnetonka, Minnesota 55343
 ATTN: Publications Supervisor MN38-3247

HONEYWELL MINNEAPOLIS, MN 55408 INTERNATIONAL Sales Offices in all principal cities of the world. Manufacturing in Australia, Canada, Finland, France, Germany, Japan, Mexico, Netherlands, Spain, Taiwan, United Kingdom, U.S.A.

PRINTED IN U.S.A.