

CAPITOL manufacturing

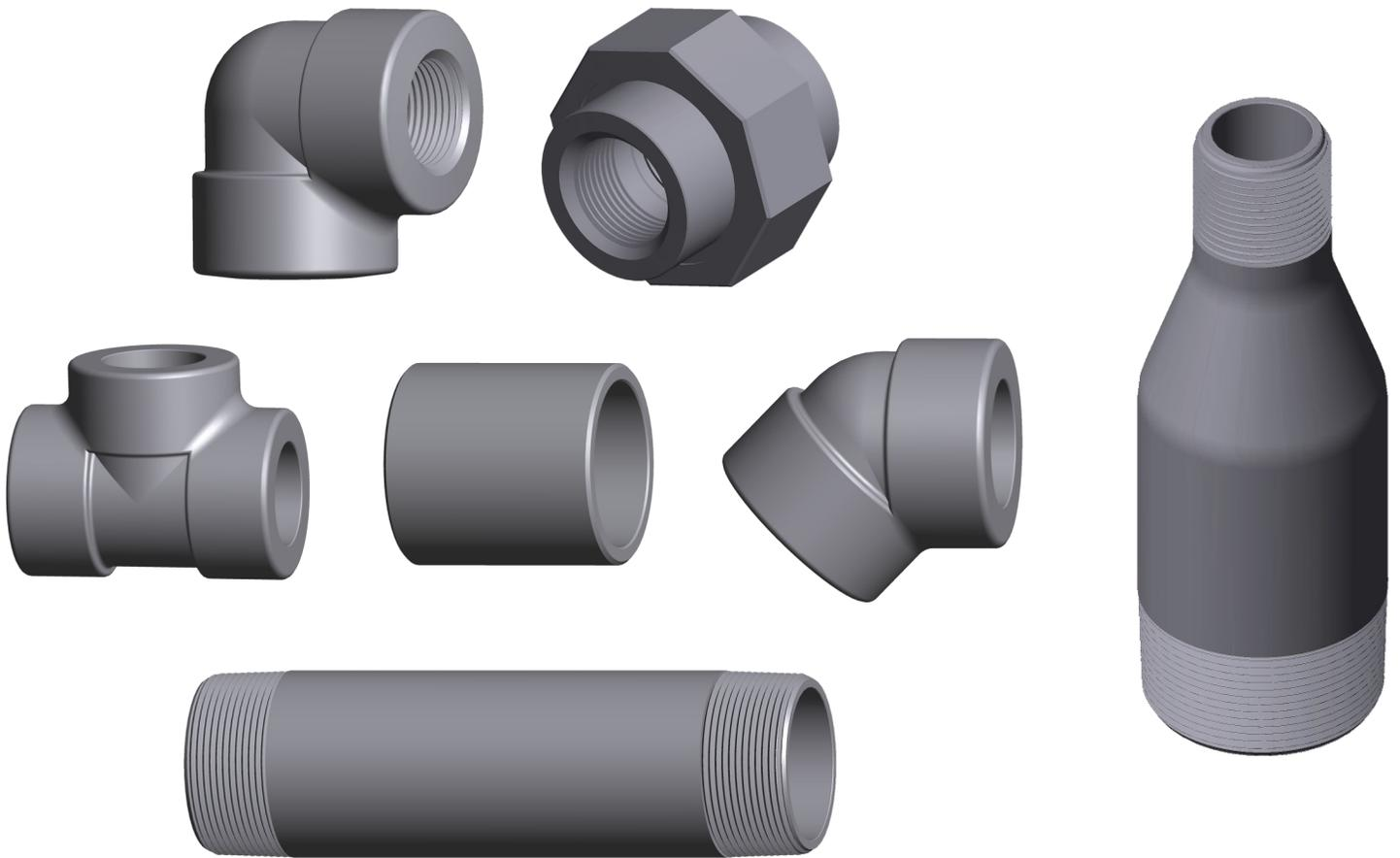

THE PHOENIX FORGE GROUP

Commanding a Higher Standard

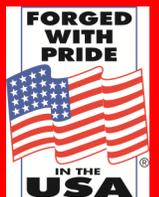



PRODUCT CATALOG

PIPE FITTINGS

Forged Carbon Steel Threaded Fittings Index Page	1
Class 2000 Forged Carbon Steel Threaded Fittings	1
Class 3000 Forged Carbon Steel Threaded Fittings	2
Class 3000 Forged Carbon Steel Threaded Reducing Couplings	3
Class 6000 Forged Carbon Steel Threaded Fittings	4
Class 6000 Forged Carbon Steel Threaded Reducing Couplings	5
Forged Steel Threaded Hex Bushings	6
Forged Steel Threaded Plugs (Square Head, Round Head and Hex Head)	7
Forged Steel Threaded Refinery Plugs	7
Forged Carbon Steel Socket Weld Fittings Index Page	8
Class 3000 Forged Carbon Steel Socket Weld Fittings	9
Class 6000 Forged Carbon Steel Socket Weld Fittings	10
Class 9000 Forged Carbon Steel Socket Weld Fittings	11
Class 3000 Forged Carbon Steel Socket Weld Reducing Couplings	12
Class 6000 Forged Carbon Steel Socket Weld Reducing Couplings	14
Class 9000 Forged Carbon Steel Socket Weld Reducing Couplings	15
Class 3000 Forged Carbon Steel Socket Weld Reducer Inserts	16
Class 6000 Forged Carbon Steel Socket Weld Reducer Inserts	17
Class 3000 Forged Carbon Steel Threaded Unions X-Series	18
Class 3000 Forged Carbon Steel Threaded Lug Unions X-Series	19
Class 3000 Forged Carbon Steel Threaded Lug O-Ring Unions X-Series	19
Class 6000 Forged Carbon Steel Threaded Unions X-Series	20
Class 6000 Forged Carbon Steel Threaded Lug Unions X-Series	20
Class 3000 Forged Carbon Steel Socket Welding Unions X-Series	21
Class 3000 Forged Carbon Steel Socket Welding High Speed Unions X-Series	21
Class 3000 Forged Carbon Steel Socket Welding High Speed O-Ring Unions X-Series	21
Class 3000 Forged Carbon Steel Socket Welding Lug Unions X-Series	22
Class 3000 Forged Carbon Steel Socket Welding Lug O-Ring Unions X-Series	22
Class 6000 Forged Carbon Steel Socket Welding Unions X-Series	23
Class 6000 Forged Carbon Steel Socket Welding Lug Unions X-Series	23



PRODUCT CATALOG (contd)

PIPE NIPPLES

Pipe Nipples Welded and Seamless, Carbon Steel and Stainless Steel	24
Pipe Nipples End Finishes	25

API PRODUCTS

API Casing Nipples	26
API Tubing Nipples EUE (With and Without Center Turned)	26
API Tubing Nipples NUE	26
API Tubing Nipples Combination EUE x NUE	27
API Tubing Nipples Combination EUE x LP	27
API Casing Swage Nipples	28
API Tubing Swage Nipples	29

COUPLINGS

Couplings Standard Merchant Full	30
Couplings Standard Merchant R&L	30
Couplings Standard Merchant Half	30
Couplings API Line Pipe	31
Couplings Extra Heavy No Recess	31
Couplings Waterwell Ream & Drifted	32
Couplings Extra Heavy Recess Half	32
Couplings Extra Heavy No Recess Half	32

SWAGE NIPPLES

Swage Nipples Threaded Both Ends	33
Swage Nipples Beveled Both Ends	34
Swage Nipples Plain Both Ends	35
Swage Nipples Eccentric TBE, BBE, PBE	36

CAPITOL manufacturing

1125 Capitol Avenue Crowley, La 70526

1-800-848-1100 Fax: (337) 783-5360

sales@capitolcamco.com

www.capitolcamco.com



PRODUCT CATALOG (contd)

BULL PLUGS

Bull Plugs Round Threaded	37
Bull Plugs Hollow Threaded	37
Bull Plugs Hollow Threaded Tapped	37
Bull Plugs Hex Threaded	38
Bull Plugs Hollow Welding Bevel	38
Bull Plugs Hollow API 8RD Threads	38

STANDARD PRESSURE FITTINGS

Standard Pressure Pipe Plugs Square Head	39
Standard Pressure Pipe Plugs Square & Hex Counter Sunk	39
Standard Pressure Hex Bushings	39
Standard Pressure Pipe Caps	39

ADAPTERS

Serrated Male Adapters	40
Serrated Female Adapters	40
Serrated Insert Couplings	40
Serrated Male Venturi	41
Serrated Well Seal Elbows (Both Ends Serrated)	42
Serrated Well Seal Elbows (Serrated x NPT)	42

SIPHONS

Siphons Angle	43
Siphons Pigtail	43
Siphons Straight	43

Forged Carbon Steel Threaded Fittings

ASTM A105, ASME B16.11, ASME B1.20.1

CAPITOL
manufacturing



90° Threaded Elbows
1/8" to 4" Class 2000
1/8" to 4" Class 3000
1/8" to 4" Class 6000

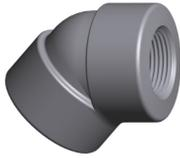

45° Threaded Elbows
1/4" to 4" Class 2000
1/8" to 4" Class 3000
1/8" to 4" Class 6000



Threaded TEEs
1/8" to 4" Class 2000
1/8" to 4" Class 3000
1/8" to 4" Class 6000



Threaded Crosses
1/8" to 4" Class 2000
1/8" to 4" Class 3000
1/8" to 3" Class 6000



Threaded Street Elbows
1/8" to 2" Class 3000
1/4" to 1 1/2" Class 6000



Threaded Laterals
1/2 to 2" Class 3000
3/4" to 1 1/2" Class 6000



Threaded Couplings
1/8" to 4" Class 3000
1/8" to 4" Class 6000

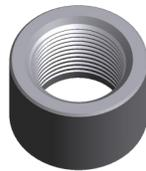

Threaded Half Couplings
1/8" to 4" Class 3000
1/8" to 4" Class 6000



Threaded Pipe Caps
1/8" to 4" Class 3000
1/8" to 4" Class 6000



Threaded Couplets
1/4" to 4" Class 3000
1/4" to 4" Class 6000

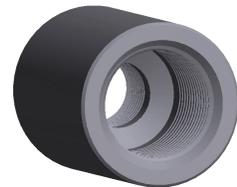

Threaded Reducing Couplings
1/4" to 4" Class 3000
1/4" to 4" Class 6000

Class 2000 Forged Carbon Steel Threaded Fittings

ASTM A105, ASME B16.11, ASME B1.20.1

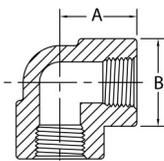

90 Degree Elbows

Pipe Size	1/8	1/4	3/8	1/2	3/4	1	1-1/4	1-1/2	2	2-1/2	3	4
A	0.810	0.810	0.970	1.120	1.310	1.500	1.750	2.000	2.380	3.000	3.380	4.190
B	0.880	0.880	1.000	1.310	1.500	1.810	2.190	2.440	2.970	3.690	4.310	6.000
Wt. Ea.	0.38	0.34	0.28	0.49	0.70	1.03	1.63	2.04	3.38	6.56	10.00	22.50

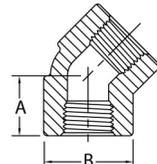

45 Degree Elbows

Pipe Size	1/8	1/4	3/8	1/2	3/4	1	1-1/4	1-1/2	2	2-1/2	3	4
A		0.690	0.750	0.880	1.000	1.120	1.310	1.380	1.690	2.060	2.500	3.120
B		0.880	1.000	1.310	1.500	1.810	2.190	2.440	2.970	3.690	4.310	6.000
Wt. Ea.		0.14	0.23	0.45	0.59	0.90	1.40	1.65	2.63	7.63	12.00	19.75

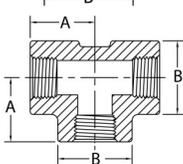

Tees

Pipe Size	1/8	1/4	3/8	1/2	3/4	1	1-1/4	1-1/2	2	2-1/2	3	4
A	0.810	0.810	0.970	1.120	1.310	1.500	1.750	2.000	2.380	3.000	3.380	4.190
B	0.880	0.880	1.000	1.310	1.500	1.810	2.190	2.440	2.970	3.620	4.310	5.750
Wt. Ea.	0.28	0.26	0.34	0.69	0.95	1.35	2.10	2.75	4.25	9.06	13.50	32.50

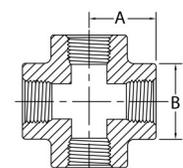

Crosses

Pipe Size	1/8	1/4	3/8	1/2	3/4	1	1-1/4	1-1/2	2	*2-1/2	3	*4
A	0.970	0.970	0.970	1.120	1.310	1.500	1.750	2.000	2.380	3.380	3.380	4.500
B	1.000	1.000	1.000	1.310	1.500	1.810	2.190	2.440	2.970	4.310	4.310	6.000
Wt. Ea.	0.52	0.51	0.50	0.80	1.05	1.65	2.35	3.28	5.00	17.20	22.10	34.13

* 2-1/2 and 4 are not to ASME B16.11

Class 3000 Forged Carbon Steel Threaded Fittings

ASTM A105, ASME B16.11, ASME B1.20.1

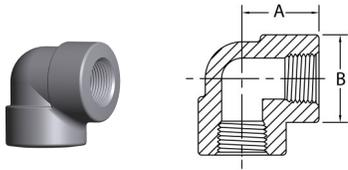

90 Degree Elbows

Pipe Size	1/8	1/4	3/8	1/2	3/4	1	1-1/4	1-1/2	2	2-1/2	3	4
A	0.810	0.970	1.120	1.310	1.500	1.750	2.000	2.380	2.500	3.250	3.750	4.500
B	0.880	1.000	1.310	1.500	1.810	2.190	2.440	2.970	3.310	4.000	4.750	6.000
Wt. Ea.	0.21	0.31	0.60	0.91	1.43	2.28	2.88	4.88	5.44	10.00	17.13	29.25

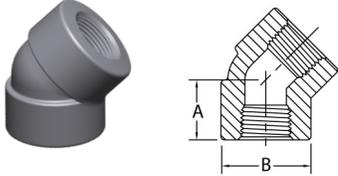

45 Degree Elbows

Pipe Size	1/8	1/4	3/8	1/2	3/4	1	1-1/4	1-1/2	2	2-1/2	3	4
A	0.690	0.750	0.880	1.000	1.120	1.310	1.380	1.690	1.720	2.060	2.500	3.120
B	0.880	1.000	1.310	1.500	1.810	2.190	2.440	2.970	3.310	4.000	4.750	6.000
Wt. Ea.	0.18	0.26	0.54	0.75	1.18	2.03	2.13	4.05	4.25	7.63	12.00	19.75

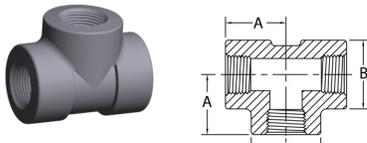

Tees

Pipe Size	1/8	1/4	3/8	1/2	3/4	1	1-1/4	1-1/2	2	2-1/2	3	4
A	0.810	0.970	1.120	1.310	1.500	1.750	2.000	2.380	2.500	3.250	3.750	4.500
B	0.880	1.000	1.310	1.500	1.810	2.190	2.440	2.970	3.310	4.000	4.750	6.000
Wt. Ea.	0.28	0.43	0.84	1.23	1.85	3.00	3.63	6.83	7.00	13.75	21.00	38.00

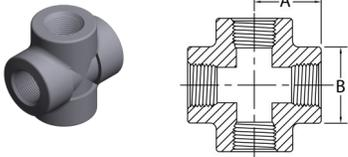

Crosses

Pipe Size	1/8	1/4	3/8	1/2	3/4	1	1-1/4	1-1/2	2	*2-1/2	3	4
A	0.970	0.970	1.120	1.310	1.500	1.750	2.000	2.380	2.500	3.380	3.750	4.500
B	1.000	1.000	1.310	1.500	1.810	2.190	2.440	2.970	3.310	4.310	4.750	6.000
Wt. Ea.	0.51	0.50	0.96	1.43	2.30	3.73	4.40	8.13	8.31	16.94	20.75	34.13

* 2-1/2 is not to ASME B16.11

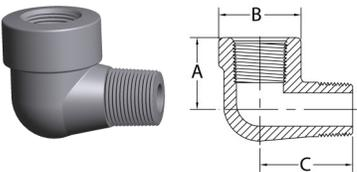

Street Elbows

Pipe Size	1/8	1/4	3/8	1/2	3/4	1	1-1/4	1-1/2	2	2-1/2	3	4
A	0.880	0.880	1.000	1.120	1.380	1.750	2.000	2.120	2.500			
B	0.875	1.000	1.250	1.500	1.750	2.000	2.440	2.750	3.310			
C	1.250	1.250	1.500	1.620	1.880	2.250	2.620	2.810	3.310			
Wt. Ea.	0.20	0.25	0.36	0.53	0.85	1.38	2.25	2.81	5.09			

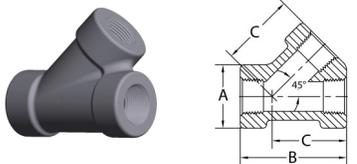

Laterals

Laterals not covered by ASME B16.11

Pipe Size	1/8	1/4	3/8	1/2	3/4	1	1-1/4	1-1/2	2	2-1/2	3	4
A				1.500	1.750	2.219	2.500	3.030	3.344			
B				2.500	3.000	4.813	5.375	6.438	6.625			
C				1.750	2.125	3.500	3.938	4.750	5.000			
Wt. Ea.				1.12	1.50	2.62	3.10	11.00	11.00			

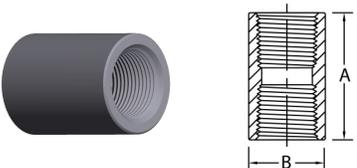

Couplings

Pipe Size	1/8	1/4	3/8	1/2	3/4	1	1-1/4	1-1/2	2	2-1/2	3	4
A	1.250	1.375	1.500	1.875	2.000	2.375	2.625	3.125	3.375	3.625	4.250	4.750
B	0.625	0.750	0.875	1.125	1.375	1.750	2.250	2.500	3.000	3.625	4.250	5.500
Wt. Ea.	0.11	0.10	0.13	0.28	0.42	0.85	1.50	2.19	3.02	4.56	6.79	12.00

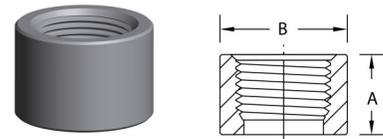

Half Couplings

Pipe Size	1/8	1/4	3/8	1/2	3/4	1	1-1/4	1-1/2	2	2-1/2	3	4
A	0.625	0.688	0.750	0.938	1.000	1.188	1.312	1.562	1.688	1.812	2.125	2.375
B	0.625	0.750	0.875	1.125	1.375	1.750	2.250	2.500	3.000	3.625	4.250	5.500
Wt. Ea.	0.06	0.05	0.06	0.14	0.21	0.43	0.75	1.09	1.57	2.28	3.40	6.00

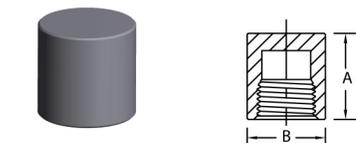

Pipe Caps

Pipe Size	1/8	1/4	3/8	1/2	3/4	1	1-1/4	1-1/2	2	2-1/2	3	4
A	0.812	1.062	1.062	1.312	1.500	1.687	1.781	1.937	2.250	2.375	2.562	2.687
B	0.750	0.750	0.875	1.125	1.375	1.750	2.250	2.500	3.000	3.625	4.250	5.500
Wt. Ea.	0.08	0.09	0.11	0.24	0.39	0.72	1.32	1.54	2.34	4.05	5.84	10.08

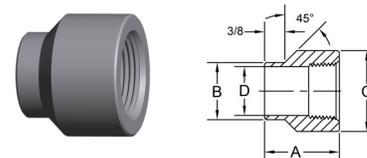

Couplets

Pipe Size	1/8	1/4	3/8	1/2	3/4	1	1-1/4	1-1/2	2	2-1/2	3	4
A		1.187	1.187	1.312	1.375	1.687	1.875	2.000	2.250	2.500	2.750	3.000
B		0.687	0.812	0.937	1.062	1.312	1.687	1.937	2.437	2.875	3.500	4.500
C		0.937	1.062	1.312	1.500	1.812	2.250	2.500	3.000	3.625	4.375	5.562
D		0.437	0.562	0.703	0.906	1.141	1.484	1.718	2.187	2.531	3.140	4.125
Wt. Ea.		0.12	0.14	0.26	0.26	0.52	0.82	1.06	1.54	2.40	6.70	7.30

Class 3000 Carbon Forged Steel Threaded Reducing Couplings

ASTM A105, ASME B16.11, ASME B1.20.1

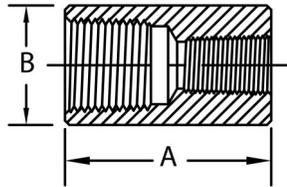
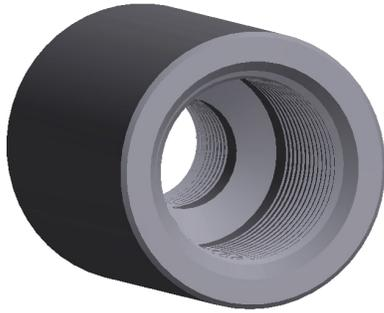

Pipe Size	A	B	Approx. Weight
1/4 X 1/8	1.375	0.750	0.1
3/8 X 1/8			
3/8 X 1/4	1.500	0.875	0.13
1/2 X 1/8	1.875	1.125	0.28
1/2 X 1/4			
1/2 X 3/8	1.875	1.250	0.28
3/4 X 1/8			
3/4 X 1/4			
3/4 X 3/8	2.000	1.375	0.42
3/4 X 1/2			
1 X 1/8			
1 X 1/4			
1 X 3/8	2.375	1.750	0.85
1 X 1/2			
1 X 3/4			
1-1/4 X 1/8			
1-1/4 X 1/4			
1-1/4 X 3/8			
1-1/4 X 1/2	2.625	2.250	1.50
1-1/4 X 3/4			
1-1/4 X 1			
1-1/2 X 1/8			
1-1/2 X 1/4			
1-1/2 X 3/8			
1-1/2 X 1/2	3.125	2.500	2.19
1-1/2 X 3/4			
1-1/2 X 1			
1-1/2 X 1-1/4			
2 X 1/8			
2 X 1/4			
2 X 3/8			
2 X 1/2			
2 X 3/4	3.375	3.000	3.02
2 X 1			
2 X 1-1/4			
2 X 1-1/2			
2-1/2 X 1/8			
2-1/2 X 1/4			
2-1/2 X 3/8			
2-1/2 X 1/2			
2-1/2 X 3/4	3.625	3.625	4.56
2-1/2 X 1			
2-1/2 X 1-1/4			
2-1/2 X 1-1/2			
2-1/2 X 2			
3 X 1/8			
3 X 1/4			
3 X 3/8			
3 X 1/2			
3 X 3/4			
3 X 1	4.250	4.250	6.79
3 X 1-1/4			
3 X 1-1/2			
3 X 2			
3 X 2-1/2			
4 X 1/8			
4 X 1/4			
4 X 3/8			
4 X 1/2			
4 X 3/4			
4 X 1			
4 X 1-1/4	4.750	5.500	12.00
4 X 1-1/2			
4 X 2			
4 X 2-1/2			
4 X 3			
4 X 3-1/2			

Class 6000 Forged Carbon Steel Threaded Fittings

ASTM A105, ASME B16.11, ASME B1.20.1

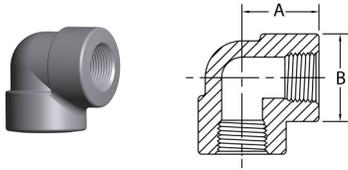

90 Degree Elbows

Pipe Size	1/8	1/4	3/8	1/2	3/4	1	1-1/4	1-1/2	2	2-1/2	3	4
A	0.970	1.120	1.310	1.500	1.750	2.000	2.380	2.500	3.250	3.750	4.190	4.500
B	1.000	1.310	1.500	1.810	2.190	2.440	2.970	3.310	4.000	4.750	5.750	6.000
Wt. Ea.	0.38	0.66	1.45	1.59	2.54	3.56	5.88	7.06	13.00	21.78	36.22	36.22

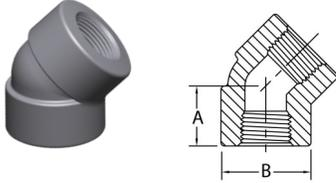

45 Degree Elbows

Pipe Size	1/8	1/4	3/8	1/2	3/4	1	1-1/4	1-1/2	2	2-1/2	* 3	4
A	0.750	0.880	1.000	1.120	1.310	1.380	1.690	1.720	2.060	2.500	3.120	3.120
B	1.000	1.310	1.500	1.810	2.190	2.440	2.970	3.310	4.000	4.750	6.000	6.000
Wt. Ea.	0.25	0.59	0.85	1.34	2.25	2.59	4.56	5.75	9.63	11.00	35.00	22.00

* 3 is not to ASME B16.11

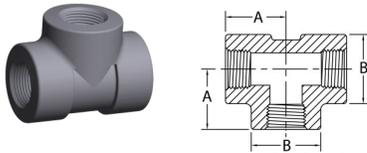

Tees

Pipe Size	1/8	1/4	3/8	1/2	3/4	1	1-1/4	1-1/2	2	2-1/2	3	4
A	0.970	1.120	1.310	1.500	1.750	2.000	2.380	2.500	3.250	3.750	4.190	4.500
B	1.000	1.310	1.500	1.810	2.190	2.440	2.970	3.310	4.000	4.750	5.750	6.000
Wt. Ea.	0.44	0.92	1.38	2.16	3.63	4.83	7.75	9.75	17.38	28.90	49.60	49.60

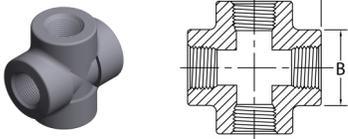

Crosses

Pipe Size	1/8	1/4	3/8	1/2	3/4	1	1-1/4	1-1/2	* 2	2-1/2	3	4
A	0.970	1.120	1.310	1.500	1.750	2.000	2.380	2.500	3.380	3.750	4.500	
B	1.000	1.310	1.500	1.810	2.190	2.440	2.970	3.310	4.310	4.750	6.000	
Wt. Ea.	0.50	1.12	1.55	2.59	4.21	5.64	9.58	11.39	21.37	25.45	32.10	

* 2 is not to ASME B16.11

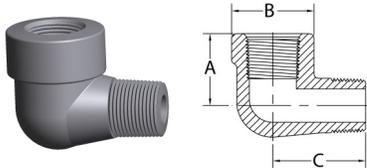

Street Elbows

Pipe Size	1/8	1/4	3/8	1/2	3/4	1	1-1/4	1-1/2	2	2-1/2	3	4
A		1.000	1.120	1.380	1.750	2.000	2.120	2.500				
B		1.250	1.500	1.750	2.000	2.440	2.750	3.310				
C		1.500	1.620	1.880	2.250	2.620	2.810	3.310				
Wt. Ea.		0.50	0.99	1.02	1.84	2.45	3.60	6.55				

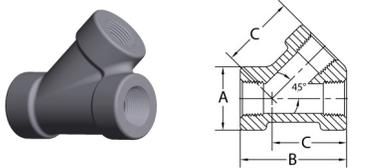

Laterals

Laterals not covered by ASME B16.11

Pipe Size	1/8	1/4	3/8	1/2	3/4	1	1-1/4	1-1/2	2	2-1/2	3	4
A					2.219	2.500	3.030	3.344				
B					4.813	5.375	6.438	6.625				
C					3.500	3.938	4.750	5.000				
Wt. Ea.					1.84	1.90	5.60	7.50				

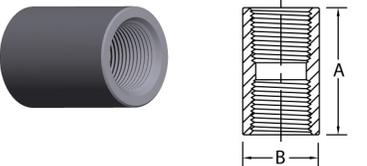

Couplings

Pipe Size	1/8	1/4	3/8	1/2	3/4	1	1-1/4	1-1/2	2	2-1/2	3	4
A	1.250	1.375	1.500	1.875	2.000	2.375	2.625	3.125	3.375	3.625	4.250	4.750
B	0.875	1.000	1.250	1.500	1.750	2.250	2.500	3.000	3.625	4.250	5.000	6.250
Wt. Ea.	0.18	0.14	0.40	0.69	0.90	1.88	2.31	4.00	6.20	9.25	13.44	22.13

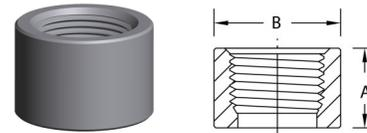

Half Couplings

Pipe Size	1/8	1/4	3/8	1/2	3/4	1	1-1/4	1-1/2	2	2-1/2	3	4
A	0.625	0.688	0.750	0.938	1.000	1.188	1.312	1.562	1.688	1.812	2.125	2.375
B	0.875	1.000	1.250	1.500	1.750	2.250	2.500	3.000	3.625	4.250	5.000	6.250
Wt. Ea.	0.09	0.07	0.20	0.35	0.45	0.94	1.15	2.00	3.75	4.62	6.72	11.06



Pipe Caps

Pipe Size	* 1/8	1/4	3/8	1/2	3/4	1	1-1/4	1-1/2	2	2-1/2	3	4
A	0.875	1.125	1.125	1.375	1.562	1.750	1.844	1.968	2.219	2.531	2.750	3.062
B	0.875	1.062	1.250	1.500	1.750	2.250	2.500	3.000	3.625	4.250	5.000	6.250
Wt. Ea.	0.13	0.21	0.35	0.42	0.58	1.16	1.40	2.14	3.62	8.10	11.70	20.00

* 1/8 is not to ASME B16.11

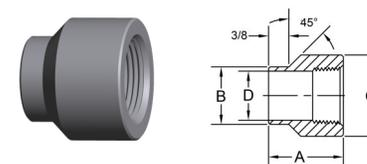

Couplets

Pipe Size	1/8	1/4	3/8	1/2	3/4	1	1-1/4	1-1/2	2	2-1/2	3	4
A		1.187	1.187	1.312	1.375	1.687	1.875	2.000	2.250	2.500	2.750	3.000
B		0.687	0.812	0.937	1.062	1.312	1.687	1.937	2.437	2.875	3.500	4.500
C		1.000	1.250	1.500	1.750	2.250	2.500	3.000	3.625	4.250	5.000	6.250
D		0.437	0.562	0.703	0.906	1.140	1.500	1.718	2.187	2.609	3.250	4.250
Wt. Ea.		0.35	0.42	0.50	0.60	0.85	1.20	1.40	1.90	2.20	3.60	

Class 6000 Forged Steel Reducing Couplings Threaded

ASTM A105, ASME B16.11, ASME B1.20.1

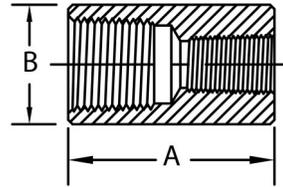
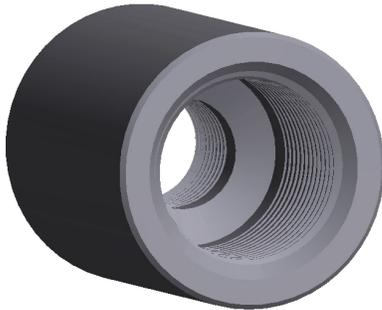

Pipe Size	A	B	Approx. Weight
1/4 X 1/8	1.375	1.062	0.14
3/8 X 1/8			
3/8 X 1/4			
1/2 X 1/8	1.500	1.250	0.40
1/2 X 1/4			
1/2 X 3/8			
3/4 X 1/8	1.875	1.500	0.69
3/4 X 1/4			
3/4 X 3/8			
3/4 X 1/2	2.000	1.750	0.90
1 X 1/8			
1 X 1/4			
1 X 3/8	2.375	2.250	1.88
1 X 1/2			
1 X 3/4			
1-1/4 X 1/8	2.625	2.500	2.31
1-1/4 X 1/4			
1-1/4 X 3/8			
1-1/4 X 1/2	2.625	2.500	2.31
1-1/4 X 3/4			
1-1/4 X 1			
1-1/2 X 1/8	3.125	3.000	4.00
1-1/2 X 1/4			
1-1/2 X 3/8			
1-1/2 X 1/2	3.125	3.000	4.00
1-1/2 X 3/4			
1-1/2 X 1			
1-1/2 X 1-1/4	3.375	3.625	7.50
2 X 1/8			
2 X 1/4			
2 X 3/8	3.375	3.625	7.50
2 X 1/2			
2 X 3/4			
2 X 1	3.375	3.625	7.50
2 X 1-1/4			
2 X 1-1/2			

Pipe Size	A	B	Approx. Weight
2-1/2 X 1/8	3.625	4.250	9.25
2-1/2 X 1/4			
2-1/2 X 3/8			
2-1/2 X 1/2	3.625	4.250	9.25
2-1/2 X 3/4			
2-1/2 X 1			
2-1/2 X 1-1/4	3.625	4.250	9.25
2-1/2 X 1-1/2			
2-1/2 X 2			
3 X 1/8	4.250	5.000	13.44
3 X 1/4			
3 X 3/8			
3 X 1/2	4.250	5.000	13.44
3 X 3/4			
3 X 1			
3 X 1-1/4	4.250	5.000	13.44
3 X 1-1/2			
3 X 2			
3 X 2-1/2	4.750	6.250	22.13
4 X 1/8			
4 X 1/4			
4 X 3/8	4.750	6.250	22.13
4 X 1/2			
4 X 3/4			
4 X 1	4.750	6.250	22.13
4 X 1-1/4			
4 X 1-1/2			
4 X 2	4.750	6.250	22.13
4 X 2-1/2			
4 X 3			
4 X 3-1/2	4.750	6.250	22.13

Forged Steel Hex Bushings Threaded

ASTM A105, ASME B16.11, ASME B1.20.1

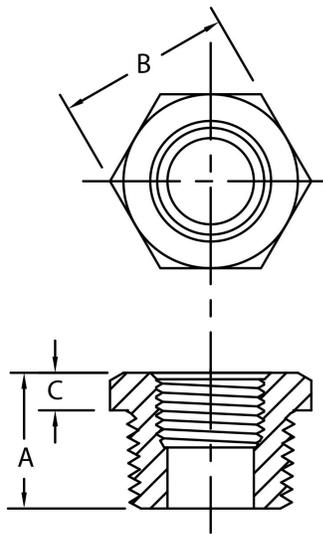

Pipe Size	A	B	C	Approx Weight
1/4 x 1/8	.44	.62	.12	0.02
3/8 x 1/8				0.05
3/8 x 1/4	.50	.69	.16	0.03
1/2 x 1/8				0.11
1/2 x 1/4	.56	.88	.19	0.09
1/2 x 3/8				0.06
3/4 x 1/8				0.21
3/4 x 1/4	.62	1.06	.22	0.18
3/4 x 3/8				0.15
3/4 x 1/2				0.10
1 x 1/8				0.36
1 x 1/4				0.33
1 x 3/8	.75	1.38	.25	0.30
1 x 1/2				0.27
1 x 3/4				0.19
1-1/4 x 1/8				0.79
1-1/4 x 1/4				0.76
1-1/4 x 3/8	.81	1.75	.28	0.73
1-1/4 x 1/2				0.68
1-1/4 x 3/4				0.64
1-1/4 x 1				0.60
1-1/2 x 1/8				1.08
1-1/2 x 1/4				1.01
1-1/2 x 3/8				0.83
1-1/2 x 1/2	.81	2.00	.31	0.93
1-1/2 x 3/4				0.84
1-1/2 x 1				0.80
1-1/2 x 1-1/4				0.75
2 x 1/8				1.88
2 x 1/4				1.84
2 x 3/8				1.80
2 x 1/2				1.74
2 x 3/4	.88	2.50	.34	1.63
2 x 1				1.55
2 x 1-1/4				1.50
2 x 1-1/2				1.45
2-1/2 x 1/8				-
2-1/2 x 1/4				3.75
2-1/2 x 3/8				3.50
2-1/2 x 1/2				3.25
2-1/2 x 3/4	1.06	3.00	.38	3.00
2-1/2 x 1				2.75
2-1/2 x 1-1/4				2.25
2-1/2 x 1-1/2				2.00
2-1/2 x 2				1.13
3 x 1/8				-
3 x 1/4				5.50
3 x 3/8				-
3 x 1/2				5.00
3 x 3/4	1.12	3.50	.41	4.75
3 x 1				4.50
3 x 1-1/4				4.13
3 x 1-1/2				3.63
3 x 2				2.75
3 x 2-1/2				2.13
4 x 1/8				-
4 x 1/4				9.00
4 x 3/8				9.00
4 x 1/2				9.00
4 x 3/4				9.00
4 x 1	1.25	4.62	.50	9.00
4 x 1-1/4				9.00
4 x 1-1/2				8.12
4 x 2				7.00
4 x 2-1/2				6.75
4 x 3				4.50

Forged Steel Threaded Plugs

ASTM A105, ASME B16.11, ASME B1.20.1

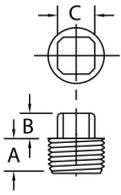

Square Head Plugs

Pipe Size	1/8	1/4	3/8	1/2	3/4	1	1-1/4	1-1/2	2	2-1/2	3	4
A	0.395	0.455	0.515	0.580	0.640	0.770	0.830	0.830	0.910	1.062	1.188	1.250
B	0.250	0.250	0.310	0.380	0.440	0.500	0.560	0.620	0.690	0.750	0.875	1.000
C	0.295	0.405	0.465	0.575	0.645	0.835	0.965	1.145	1.335	1.500	1.875	2.500
Wt. Ea.	0.02	0.03	0.06	0.13	0.19	0.31	0.56	0.88	1.50	2.25	2.87	7.18

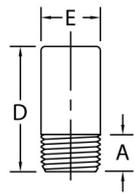

Round Head Plugs

Pipe Size	1/8	1/4	3/8	1/2	3/4	1	1-1/4	1-1/2	2	2-1/2	3	4
A	0.380	0.562	0.562	0.812	0.812	0.937	0.937	1.000	1.062	1.500	1.562	1.625
D	1.380	1.620	1.620	1.750	1.750	2.000	2.000	2.000	2.500	2.750	2.750	3.000
E	0.437	0.562	0.750	0.875	1.062	1.312	1.750	2.000	2.375	3.000	3.625	4.625
Wt. Ea.	0.06	0.11	0.20	0.30	0.44	0.77	1.27	1.78	3.48	5.50	8.04	14.28

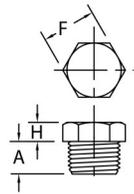

Hex Head Plugs

Pipe Size	1/8	1/4	3/8	1/2	3/4	1	1-1/4	1-1/2	2	*2-1/2	*3	*4
A	0.437	0.593	0.593	0.781	0.781	0.968	1.000	1.000	1.062	1.125	1.375	1.562
F	0.437	0.625	0.687	0.875	1.062	1.375	1.750	2.000	2.500	3.000	3.625	4.625
H	0.250	0.250	0.310	0.310	0.380	0.380	0.560	0.620	0.690	0.500	0.562	0.687
Wt. Ea.	0.06	0.06	0.07	0.19	0.30	0.59	1.10	1.54	2.54	2.34	6.24	11.00

* 2 1/2, 3 and 4 are not to ASME B16.11

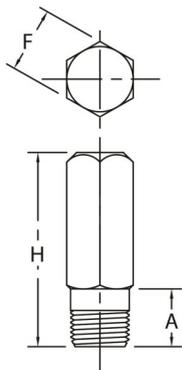

Hex Head Refinery

Pipe Size	1/4	3/8	1/2	3/4	1	1-1/4	1-1/2	2
A	0.810	0.810	1.250	1.375	1.562	1.625	1.625	1.750
F	0.625	0.750	0.875	1.125	1.375	1.750	2.000	2.500
H	3.000	3.000	3.000	3.000	3.000	3.000	3.000	3.000
Wt. Ea.	0.26	0.39	0.52	0.83	1.23	2.49	2.74	4.20

Forged Carbon Steel Socket Weld Fittings

ASTM A105, ASME B16.11

CAPITOL
manufacturing



90° Socket Weld Elbows

1/8" to 4" Class 3000
1/8" to 4" Class 6000
1/4" to 3" Class 9000



45° Socket Weld Elbows

1/8" to 4" Class 3000
1/8" to 3" Class 6000
1/4" to 2 1/2" Class 9000



Socket Weld TEES

1/8" to 4" Class 3000
1/8" to 4" Class 6000
1/4" to 2" Class 9000



Socket Weld Crosses

1/8" to 4" Class 3000
1/2" to 2" Class 6000



Socket Weld Laterals

1/2" to 2" Class 3000
1/2" to 2" Class 6000
3/4" to 1 1/2" Class 9000



Socket Weld Couplings

1/8" to 4" Class 3000
1/8" to 4" Class 6000
1/4" to 2" Class 9000



Socket Weld Half Couplings

1/8" to 4" Class 3000
1/8" to 4" Class 6000
1/2" to 2" Class 9000

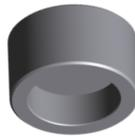

Socket Weld Pipe Caps

1/8" to 4" Class 3000
1/8" to 4" Class 6000
1/2" to 2" Class 9000

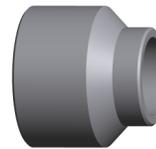

Socket Weld Couplets

1/8" to 4" Class 3000
1/8" to 3" Class 6000

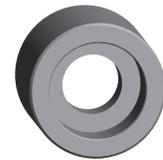

Socket Weld Reducing Couplings

1/4" to 4" Class 3000
1/4" to 4" Class 6000
1/4" to 2 1/2" Class 9000

Class 3000 Forged Carbon Steel Socket Weld Fittings

ASTM A105, ASME B16.11

Common Dimensions

Pipe Size	1/8	1/4	3/8	1/2	3/4	1	1-1/4	1-1/2	2	2-1/2	3	4
C	0.420/ 0.440	0.555/ 0.575	0.690/ 0.710	0.855/ 0.875	1.065/ 1.085	1.330/ 1.350	1.675/ 1.695	1.915/ 1.935	2.406/ 2.426	2.906/ 2.931	3.535/ 3.560	4.545/ 4.570
D	0.380	0.380	0.380	0.380	0.500	0.500	0.500	0.500	0.620	0.620	0.620	0.750

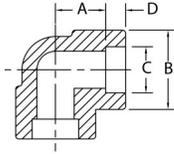

90 Degree Elbows

Pipe Size	1/8	1/4	3/8	1/2	3/4	1	1-1/4	1-1/2	2	2-1/2	3	4
A	0.440	0.440	0.530	0.620	0.750	0.880	1.060	1.250	1.500	1.620	2.250	2.620
B	0.880	0.880	1.040	1.310	1.500	1.810	2.250	2.500	3.030	3.690	4.380	5.750
Wt. Ea.	0.20	0.16	0.25	0.48	0.68	1.06	1.59	2.13	3.78	6.74	10.94	24.13

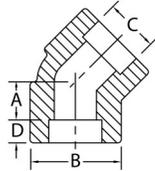

45 Degree Elbows

Pipe Size	1/8	1/4	3/8	1/2	3/4	1	1-1/4	1-1/2	2	2-1/2	3	4
A	0.310	0.310	0.310	0.440	0.500	0.560	0.690	0.810	1.000	1.120	1.250	1.620
B	0.880	0.880	1.040	1.310	1.500	1.810	2.250	2.500	3.030	3.680	4.370	6.000
Wt. Ea.	0.15	0.13	0.20	0.43	0.58	0.89	1.40	1.70	2.69	7.88	11.25	20.75

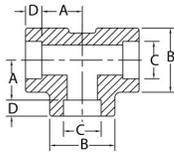

Tees

Pipe Size	1/8	1/4	3/8	1/2	3/4	1	1-1/4	1-1/2	2	2-1/2	3	4
A	0.440	0.440	0.530	0.620	0.750	0.880	1.060	1.250	1.500	1.620	2.250	2.620
B	0.880	0.880	1.040	1.310	1.500	1.810	2.250	2.500	3.030	3.690	4.380	5.750
Wt. Ea.	0.23	0.19	0.33	0.71	0.87	1.44	2.19	2.98	4.57	8.60	13.00	31.30

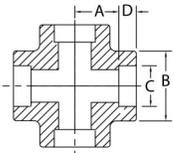

Crosses

Pipe Size	1/8	1/4	3/8	1/2	3/4	1	1-1/4	1-1/2	2	2-1/2	3	4
A	0.530	0.530	0.530	0.620	0.750	0.880	1.060	1.250	1.500	1.620	2.250	2.620
B	1.040	1.040	1.040	1.310	1.500	1.810	2.250	2.500	3.030	4.310	4.310	6.000
Wt. Ea.	0.57	0.51	0.39	0.83	1.03	1.68	2.56	3.46	5.60	13.70	21.10	35.00

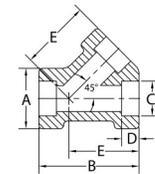

Laterals

Laterals not covered by ASME B16.11

Pipe Size	1/8	1/4	3/8	1/2	3/4	1	1-1/4	1-1/2	2	2-1/2	3	4
A				1.500	1.750	2.000	2.380	2.500	3.030			
B				2.500	3.000	3.500	4.000	5.375	6.438			
E				1.750	2.125	2.500	2.812	3.938	4.750			
Wt. Ea.				0.90	1.40	2.55	2.80	4.13	6.29			

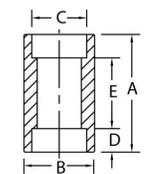

Couplings

Pipe Size	1/8	1/4	3/8	1/2	3/4	1	1-1/4	1-1/2	2	2-1/2	3	4
A	1.025	1.025	1.085	1.245	1.335	1.415	1.415	1.415	1.905	1.865	1.865	2.125
B	0.750	0.875	1.063	1.250	1.500	1.875	2.250	2.500	3.000	3.625	4.312	5.500
E	0.250	0.250	0.250	0.380	0.380	0.500	0.500	0.500	0.750	0.750	0.750	0.750
Wt. Ea.	0.09	0.11	0.16	0.29	0.42	0.59	1.07	1.30	2.13	3.14	4.14	7.30

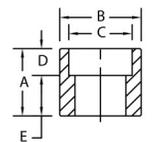
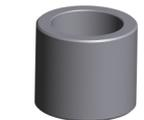

Half Couplings

Pipe Size	1/8	1/4	3/8	1/2	3/4	1	1-1/4	1-1/2	2	2-1/2	3	4
A	1.025	1.025	1.085	1.245	1.425	1.585	1.655	1.715	2.205	2.255	2.315	2.575
B	0.750	0.875	1.063	1.250	1.500	1.875	2.250	2.500	3.000	3.625	4.312	5.500
E	0.620	0.620	0.690	0.880	0.940	1.120	1.190	1.250	1.620	1.690	1.750	1.880
Wt. Ea.	0.09	0.11	0.16	0.29	0.42	0.59	1.07	1.30	2.13	3.14	4.14	7.30

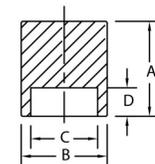
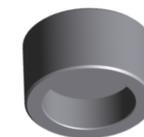

Pipe Caps

Pipe Size	1/8	1/4	3/8	1/2	3/4	1	1-1/4	1-1/2	2	2-1/2	3	4
A	0.705	0.705	0.705	0.765	0.875	1.045	1.045	1.105	1.265	1.395	1.515	1.765
B	0.750	0.875	1.062	1.250	1.500	1.875	2.250	2.500	3.000	3.625	4.312	5.500
Wt. Ea.	0.07	0.09	0.12	0.22	0.36	0.48	0.91	1.30	1.88	2.74	4.27	7.40

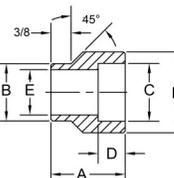

Couplets

Pipe Size	1/8	1/4	3/8	1/2	3/4	1	1-1/4	1-1/2	2	2-1/2	3	4
A	1.187	1.187	1.187	1.312	1.375	1.687	1.875	2.000	2.250	2.500	2.750	3.000
B	0.562	0.687	0.812	0.937	1.062	1.312	1.687	1.937	2.437	2.875	3.500	4.500
E	0.364	0.364	0.443	0.608	0.824	1.049	1.380	1.610	2.067	2.462	3.068	4.026
F	0.750	0.875	1.062	1.250	1.500	1.875	2.250	2.500	3.000	3.625	4.312	5.500
Wt. Ea.	0.25	0.30	0.35	0.50	0.26	0.85	1.07	1.30	2.13	3.14	4.14	7.30

Class 6000 Forged Carbon Steel Socket Weld Fittings

ASTM A105, ASME B16.11

Common Dimensions

Pipe Size	1/8	1/4	3/8	1/2	3/4	1	1-1/4	1-1/2	2	2-1/2	3	4
C	0.420/ 0.440	0.555/ 0.575	0.690/ 0.710	0.855/ 0.875	1.065/ 1.085	1.330/ 1.350	1.675/ 1.695	1.915/ 1.935	2.406/ 2.426	2.906/ 2.931	3.535/ 3.560	4.545/ 4.570
D	0.380	0.380	0.380	0.380	0.500	0.500	0.500	0.500	0.620	0.620	0.620	0.750

90 Degree Elbows

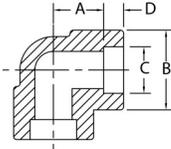

Pipe Size	1/8	1/4	3/8	1/2	3/4	1	1-1/4	1-1/2	2	*2-1/2	*3	*4
A	0.440	0.530	0.620	0.750	0.880	1.060	1.250	1.500	1.620	2.250	2.500	2.875
B	1.040	1.040	1.310	1.500	1.810	2.250	2.500	3.030	3.310	4.000	4.750	6.000
Wt. Ea.	0.25	0.35	0.68	0.88	1.38	2.63	3.00	5.31	6.00	10.47	18.84	31.54

* 2-1/2, 3 and 4 not covered by ASME B16.11

45 Degree Elbows

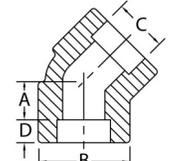

Pipe Size	1/8	1/4	3/8	1/2	3/4	1	1-1/4	1-1/2	2	*2-1/2	*3	4
A	0.310	0.310	0.440	0.500	0.560	0.690	0.810	1.000	1.120	1.125	1.250	
B	1.040	1.040	1.310	1.500	1.810	2.250	2.500	3.030	3.310	4.000	4.750	
Wt. Ea.	0.20	0.30	0.30	0.68	1.14	2.03	2.25	4.22	5.03	7.00	15.00	

* 2-1/2 and 3 not covered by ASME B16.11

Tees

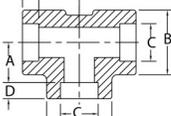

Pipe Size	1/8	1/4	3/8	1/2	3/4	1	1-1/4	1-1/2	2	*2-1/2	*3	*4
A	0.440	0.530	0.620	0.750	0.880	1.060	1.250	1.500	1.620	2.250	2.500	2.875
B	1.040	1.040	1.310	1.500	1.810	2.250	2.500	3.030	3.310	4.000	4.750	6.000
Wt. Ea.	0.35	0.35	0.42	1.16	1.94	3.17	3.95	7.13	7.72	15.30	23.10	34.90

* 2-1/2, 3 and 4 not covered by ASME B16.11

Crosses



Pipe Size	1/8	1/4	3/8	1/2	3/4	1	1-1/4	1-1/2	2	2-1/2	3	4
A				0.750	0.880	1.060	1.250	1.500	1.620			
B				1.500	1.810	2.250	2.500	3.030	3.310			
Wt. Ea.				1.44	2.31	3.46	4.65	8.70	13.00			

Laterals

Laterals not covered by ASME B16.11

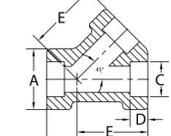

Pipe Size	1/8	1/4	3/8	1/2	3/4	1	1-1/4	1-1/2	2	2-1/2	3	4
A				0.750	0.880	1.060	1.250	1.500	1.620			
B				1.500	1.810	2.250	2.500	3.030	3.310			
E				0.380	0.500	0.500	0.500	0.500	0.620			
Wt. Ea.				1.44	2.31	3.46	4.65	8.70	13.00			

Couplings

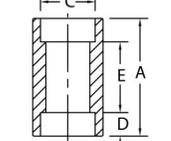

Pipe Size	1/8	1/4	3/8	1/2	3/4	1	1-1/4	1-1/2	2	*2-1/2	*3	*4
A	1.025	1.025	1.025	1.095	1.335	1.415	1.415	1.415	1.905	1.865	1.865	2.125
B	0.875	1.000	1.125	1.375	1.688	2.000	2.500	2.750	3.625	4.250	5.000	6.000
E	0.250	0.250	0.250	0.380	0.380	0.500	0.500	0.500	0.750	0.750	0.750	0.750
Wt. Ea.	0.09	0.16	0.28	0.51	0.70	1.40	1.59	2.58	4.58	6.14	7.10	13.70

* 2-1/2, 3 and 4 not covered by ASME B16.11

Half Couplings

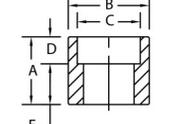
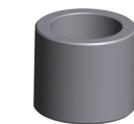

Pipe Size	1/8	1/4	3/8	1/2	3/4	1	1-1/4	1-1/2	2	*2-1/2	*3	*4
A	1.015	1.015	1.085	1.245	1.425	1.585	1.655	1.715	2.205	2.555	2.315	2.575
B	0.875	1.000	1.125	1.375	1.687	2.000	2.500	2.750	3.625	4.250	5.000	6.000
E	0.620	0.620	0.690	0.880	0.940	1.120	1.190	1.250	1.620	1.690	1.750	1.880
Wt. Ea.	0.13	0.19	0.38	0.42	0.35	0.70	0.80	1.29	2.29	6.14	7.10	12.38

* 2-1/2, 3 and 4 not covered by ASME B16.11

Pipe Caps

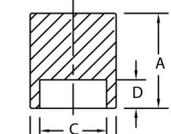
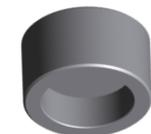

Pipe Size	1/8	1/4	3/8	1/2	3/4	1	1-1/4	1-1/2	2	*2-1/2	*3	*4
A	0.765	0.765	0.765	0.825	0.955	1.075	1.075	1.135	1.395	1.515	1.635	2.015
B	0.875	1.000	1.125	1.375	1.688	2.000	2.500	2.750	3.625	4.250	5.000	6.000
Wt. Ea.	0.12	0.25	0.19	0.42	0.58	1.16	1.40	2.14	3.62	4.90	7.60	12.75

* 2-1/2, 3 and 4 not covered by ASME B16.11

Couplets

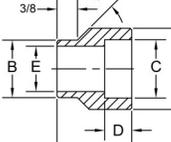

Pipe Size	1/8	1/4	3/8	1/2	3/4	1	1-1/4	1-1/2	2	2-1/2	3	4
A	1.187	1.187	1.187	1.312	1.375	1.687	1.875	2.000	2.250	2.500	2.750	
B	0.562	0.687	0.812	0.937	1.062	1.312	1.687	1.937	2.437	2.875	3.500	
E	0.156	0.250	0.359	0.464	0.612	0.815	1.160	1.338	1.687	2.125	2.625	
F	0.875	1.000	1.125	1.375	1.687	2.000	2.500	2.750	3.625	4.250	5.000	

Class 9000 Forged Carbon Steel Socket Weld Fittings

ASTM A105, ASME B16.11

Common Dimensions

Pipe Size	1/4	3/8	1/2	3/4	1	1-1/4	1-1/2	2	2-1/2	3
C	0.555/ 0.575	0.690/ 0.710	0.855/ 0.875	1.065/ 1.085	1.330/ 1.350	1.675/ 1.695	1.915/ 1.935	2.406/ 2.426	2.906/ 2.931	3.535/ 3.560
D	0.380	0.380	0.380	0.500	0.500	0.500	0.500	0.620	0.620	0.620

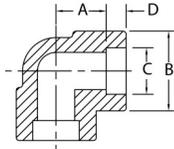

90 Degree Elbows

Pipe Size	*1/4	*3/8	1/2	3/4	1	1-1/4	1-1/2	2	*2-1/2	*3
A	0.687	0.880	1.000	1.120	1.250	1.380	1.500	2.120	2.500	2.937
B	1.310	1.500	1.810	2.250	2.500	3.030	3.310	3.690	4.750	5.750
Wt. Ea.	0.59	1.10	1.44	2.25	4.09	5.81	6.69	12.00	13.00	N/A

* 1/4, 3/8, 2-1/2 and 3 not covered by ASME B16.11

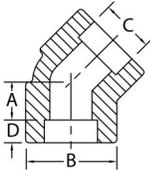

45 Degree Elbows

Pipe Size	*1/4	*3/8	1/2	3/4	1	1-1/4	1-1/2	2	*2-1/2	3
A	0.440	0.562	0.620	0.750	0.810	0.880	1.000	1.120	1.312	
B	1.312	1.500	1.812	2.250	2.500	3.030	3.312	3.680	4.750	
Wt. Ea.	N/A	0.90	1.42	2.06	2.50	5.00	6.51	10.44	N/A	

* 1/4, 3/8 and 2-1/2 not covered by ASME B16.11

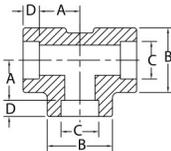

Tees

Pipe Size	*1/4	*3/8	1/2	3/4	1	1-1/4	1-1/2	2	2-1/2	3
A	0.687	0.880	1.000	1.120	1.250	1.380	1.500	2.120		
B	1.310	1.500	1.810	2.250	2.500	3.030	3.310	3.690		
Wt. Ea.	N/A	N/A	2.37	4.00	5.35	7.44	7.88	8.75		

* 1/4 and 3/8 not covered by ASME B16.11

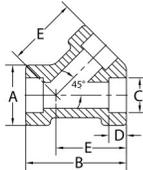

Laterals

Pipe Size	1/4	3/8	1/2	3/4	1	1-1/4	1-1/2	2	2-1/2	3
A				2.219	2.500	3.030	3.344			
B				4.813	5.375	6.438	6.625			
E				3.500	3.938	4.750	5.000			
Wt. Ea.										

Couplings

Pipe Size	*1/4	*3/8	1/2	3/4	1	1-1/4	1-1/2	2	2-1/2	3
A	1.030	1.030	1.090	1.330	1.410	1.410	1.410	1.900		
B	1.250	1.380	1.690	2.000	2.500	2.750	3.000	3.620		
E	0.250	0.250	0.380	0.380	0.500	0.500	0.500	0.750		
Wt. Ea.	0.50	0.53	0.85	0.91	1.65	1.85	2.00	3.51		

* 1/4 and 3/8 not covered by ASME B16.11

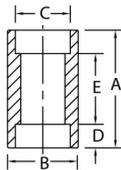

Half Couplings

Pipe Size	1/4	3/8	1/2	3/4	1	1-1/4	1-1/2	2	2-1/2	3
A			1.245	1.425	1.585	1.655	1.715	2.205		
B			1.687	2.000	2.500	2.750	3.000	3.625		
E			0.880	0.940	1.120	1.190	1.250	1.620		
Wt. Ea.			0.45	1.14	1.99	2.34	2.76	4.85		

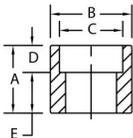

Pipe Caps

Pipe Size	1/4	3/8	1/2	3/4	1	1-1/4	1-1/2	2	2-1/2	3
A			0.955	1.135	1.205	1.205	1.265	1.515		
B			1.688	2.000	2.500	2.750	3.000	3.625		
Wt. Ea.			0.59	1.10	1.58	1.81	1.58	3.87		

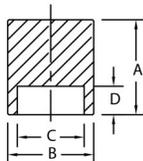
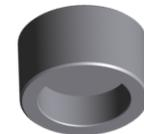

Class 3000 Forged Steel Socket Weld Reducing Couplings

ASTM A105, ASME B16.11

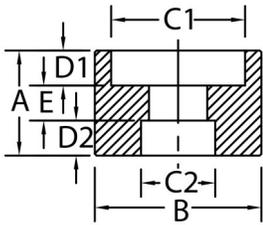
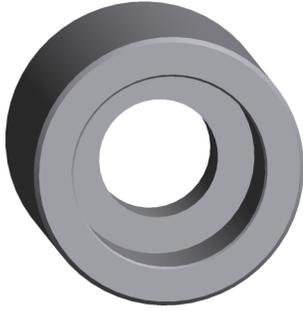

Sizes marked with * are not covered by ASME B16.11

Pipe Size	A	B	C1	C2	D1	D2	E	Wt. Ea.
1/4 X 1/8	1.030	0.875	.555/.575	.420/.430	0.395	0.395	0.250	0.18
3/8 X 1/8	1.030	1.063	.690/.710	.420/.430	0.395	0.395	0.250	0.18
3/8 X 1/4				.555/.575				
1/2 X 1/8	1.095	1.250	.855/.875	.420/.430	0.395	0.395	0.380	0.26
1/2 X 1/4				.555/.575				
1/2 X 3/8				.690/.710				
3/4 X 1/8	1.335	1.500	1.065/1.085	.420/.430	0.515	0.515	0.380	0.41
3/4 X 1/4				.555/.575				
3/4 X 3/8				.690/.710				
3/4 X 1/2				.855/.875				
1 X 1/8	1.415	1.875	1.330/1.350	.420/.430	0.515	0.515	0.500	0.65
1 X 1/4				.555/.575				
1 X 3/8				.690/.710				
1 X 1/2				.855/.875				
1 X 3/4				1.065/1.085				
1-1/4 X 1/8				1.415				
1-1/4 X 1/4	.555/.575							
1-1/4 X 3/8	.690/.710							
1-1/4 X 1/2	.855/.875							
1-1/4 X 3/4	1.065/1.085							
1-1/4 X 1	1.330/1.350							
1-1/2 X 1/8	1.415	2.500	1.915/1.935	.420/.430	0.515	0.515	0.500	0.92
1-1/2 X 1/4				.555/.575				
1-1/2 X 3/8				.690/.710				
1-1/2 X 1/2				.855/.875				
1-1/2 X 3/4				1.065/1.085				
1-1/2 X 1				1.330/1.350				
1-1/2 X 1-1/4				1.675/1.695				
2 X 1/8	1.905	3.000	2.406/2.426	.420/.430	0.635	0.635	0.750	1.62
2 X 1/4				.555/.575				
2 X 3/8				.690/.710				
2 X 1/2				.855/.875				
2 X 3/4				1.065/1.085				
2 X 1				1.330/1.350				
2 X 1-1/4				1.675/1.695				
2 X 1-1/2				1.915/1.935				

Class 3000 Forged Steel Socket Weld Reducing Couplings

ASTM A105, ASME B16.11

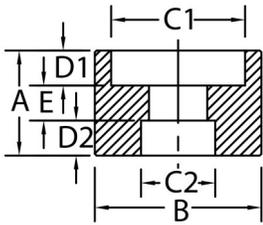
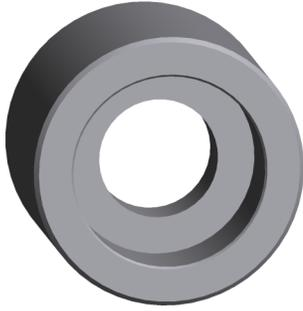

Sizes marked with * are not covered by ASME B16.11

Pipe Size	A	B	C1	C2	D1	D2	E	Wt. Ea.
2-1/2 X 1/8 *	1.865	3.625	2.906/2.931	.420/.430	0.635	0.635	0.750	2.61
2-1/2 X 1/4 *				.555/.575				
2-1/2 X 3/8 *				.690/.710				
2-1/2 X 1/2 *				.855/.875				
2-1/2 X 3/4 *				1.065/1.085				
2-1/2 X 1 *				1.330/1.350				
2-1/2 X 1-1/4 *				1.675/1.695				
2-1/2 X 1-1/2 *				1.915/1.935				
2-1/2 X 2 *				2.406/2.426				
3 X 1/8 *				1.865				
3 X 1/4 *	.555/.575							
3 X 3/8 *	.690/.710							
3 X 1/2 *	.855/.875							
3 X 3/4 *	1.065/1.085							
3 X 1 *	1.330/1.350							
3 X 1-1/4 *	1.675/1.695							
3 X 1-1/2 *	1.915/1.935							
3 X 2 *	2.406/2.426							
3 X 2-1/2 *	2.906/2.931							
3-1/2 X 1/8 *	2.125	5.000	4.040/4.055	.420/.430	0.765	0.765	0.750	4.15
3-1/2 X 1/4 *				.555/.575				
3-1/2 X 3/8 *				.690/.710				
3-1/2 X 1/2 *				.855/.875				
3-1/2 X 3/4 *				1.065/1.085				
3-1/2 X 1 *				1.330/1.350				
3-1/2 X 1-1/4 *				1.675/1.695				
3-1/2 X 1-1/2 *				1.915/1.935				
3-1/2 X 2 *				2.406/2.426				
3-1/2 X 2-1/2 *				2.906/2.931				
3-1/2 X 3 *	3.535/3.550							
4 X 1/8 *	2.125	5.500	4.545/4.570	.420/.430	0.765	0.765	0.750	5.17
4 X 1/4 *				.555/.575				
4 X 3/8 *				.690/.710				
4 X 1/2 *				.855/.875				
4 X 3/4 *				1.065/1.085				
4 X 1 *				1.330/1.350				
4 X 1-1/4 *				1.675/1.695				
4 X 1-1/2 *				1.915/1.935				
4 X 2 *				2.406/2.426				
4 X 2-1/2 *				2.906/2.931				
4 X 3 *				3.535/3.550				
4 X 3-1/2 *				4.040/4.055				

Class 6000 Forged Steel Socket Weld Reducing Couplings

ASTM A105, ASME B16.11

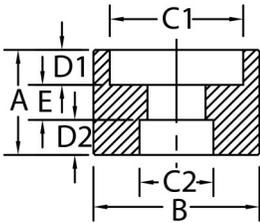
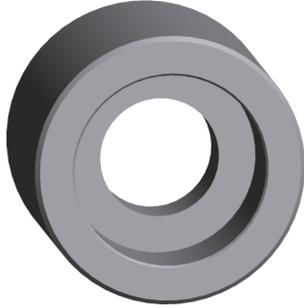

Sizes marked with * are not covered by ASME B16.11

Pipe Size	A	B	C1	C2	D1	D2	E	Wt. Ea.
1/4 X 1/8	1.025	1.000	.555/.575	.420/.430	0.395	0.395	0.250	0.09
3/8 X 1/8	1.025	1.125	.690/.710	.420/.430	0.395	0.395	0.250	0.22
3/8 X 1/4				.555/.575				
1/2 X 1/8				.420/.430				
1/2 X 1/4	1.095	1.375	.855/.875	.555/.575	0.395	0.395	0.380	0.37
1/2 X 3/8				.690/.710				
3/4 X 1/8				.420/.430				
3/4 X 1/4	1.335	1.750	1.065/1.085	.555/.575	0.515	0.515	0.380	0.62
3/4 X 3/8				.690/.710				
3/4 X 1/2				.855/.875				
1 X 1/8				.420/.430				
1 X 1/4				.555/.575				
1 X 3/8	1.415	2.000	1.330/1.350	.690/.710	0.515	0.515	0.500	0.86
1 X 1/2				.855/.875				
1 X 3/4				1.065/1.085				
1-1/4 X 1/8				.420/.430				
1-1/4 X 1/4				.555/.575				
1-1/4 X 3/8	1.415	2.500	1.675/1.695	.690/.710	0.515	0.515	0.500	1.29
1-1/4 X 1/2				.855/.875				
1-1/4 X 3/4				1.065/1.085				
1-1/4 X 1				1.330/1.350				
1-1/2 X 1/8				.420/.430				
1-1/2 X 1/4				.555/.575				
1-1/2 X 3/8				.690/.710				
1-1/2 X 1/2	1.415	2.750	1.915/1.935	.855/.875	0.515	0.515	0.500	1.47
1-1/2 X 3/4				1.065/1.085				
1-1/2 X 1				1.330/1.350				
1-1/2 X 1-1/4				1.675/1.695				
2 X 1/8				.420/.430				
2 X 1/4				.555/.575				
2 X 3/8				.690/.710				
2 X 1/2	1.905	3.625	2.406/2.426	.855/.875	0.635	0.635	0.750	3.66
2 X 3/4				1.065/1.085				
2 X 1				1.330/1.350				
2 X 1-1/4				1.675/1.695				
2 X 1-1/2				1.915/1.935				
2-1/2 X 1/8 *				.420/.430				
2-1/2 X 1/4 *				.555/.575				
2-1/2 X 3/8 *				.690/.710				
2-1/2 X 1/2 *	1.865	4.250	2.906/2.931	.855/.875	0.635	0.635	0.750	4.90
2-1/2 X 3/4 *				1.065/1.085				
2-1/2 X 1 *				1.330/1.350				
2-1/2 X 1-1/4 *				1.675/1.695				
2-1/2 X 1-1/2 *				1.915/1.935				
2-1/2 X 2 *				2.406/2.426				
3 X 1/8 *				.420/.430				
3 X 1/4 *				.555/.575				
3 X 3/8 *				.690/.710				
3 X 1/2 *				.855/.875				
3 X 3/4 *	1.865	5.000	3.535/3.550	1.065/1.085	0.635	0.635	0.750	6.34
3 X 1 *				1.330/1.350				
3 X 1-1/4 *				1.675/1.695				
3 X 1-1/2 *				1.915/1.935				
3 X 2 *				2.406/2.426				
3 X 2-1/2 *				2.906/2.931				
4 X 1/8 *				.420/.430				
4 X 1/4 *				.555/.575				
4 X 3/8 *				.690/.710				
4 X 1/2 *				.855/.875				
4 X 3/4 *				1.065/1.085				
4 X 1 *	2.125	6.000	4.545/4.570	1.330/1.350	0.765	0.765	0.750	8.83
4 X 1-1/4 *				1.675/1.695				
4 X 1-1/2 *				1.915/1.935				
4 X 2 *				2.406/2.426				
4 X 2-1/2 *				2.906/2.931				
4 X 3 *				3.535/3.550				
4 X 3-1/2 *				4.040/4.055				

Class 9000 Forged Steel Socket Weld Reducing Couplings

ASTM A105, ASME B16.11

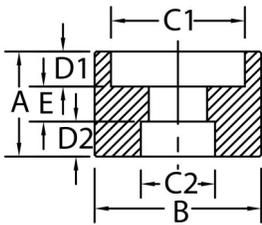
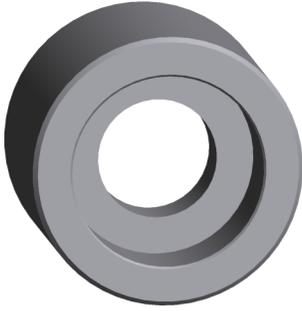

Sizes marked with * are not covered by ASME B16.11

Pipe Size	A	B	C1	C2	D1	D2	E	Wt. Ea.
1/4 X 1/8 *	1.025	1.250	.555/.575	.420/.430	0.395	0.395	0.250	0.45
3/8 X 1/8 *	1.025	1.375	.690/.710	.420/.430	0.395	0.395	0.250	0.55
3/8 X 1/4 *				.555/.575				
1/2 X 1/8	1.025	1.688	.855/.875	.420/.430	0.395	0.395	0.380	0.64
1/2 X 1/4				.555/.575				
1/2 X 3/8				.690/.710				
3/4 X 1/8	1.335	2.000	1.065/1.085	.420/.430	0.515	0.515	0.380	1.30
3/4 X 1/4				.555/.575				
3/4 X 3/8				.690/.710				
3/4 X 1/2				.855/.875				
1 X 1/8	1.415	2.500	1.330/1.350	.420/.430	0.515	0.515	0.500	1.95
1 X 1/4				.555/.575				
1 X 3/8				.690/.710				
1 X 1/2				.855/.875				
1 X 3/4				1.065/1.085				
1-1/4 X 1/8	1.415	2.750	1.675/1.695	.420/.430	0.515	0.515	0.500	1.81
1-1/4 X 1/4				.555/.575				
1-1/4 X 3/8				.690/.710				
1-1/4 X 1/2				.855/.875				
1-1/4 X 3/4				1.065/1.085				
1-1/4 X 1				1.330/1.350				
1-1/2 X 1/8	1.415	3.000	1.915/1.935	.420/.430	0.515	0.515	0.500	2.30
1-1/2 X 1/4				.555/.575				
1-1/2 X 3/8				.690/.710				
1-1/2 X 1/2				.855/.875				
1-1/2 X 3/4				1.065/1.085				
1-1/2 X 1				1.330/1.350				
1-1/2 X 1-1/4				1.675/1.695				
2 X 1/8	1.905	3.625	2.406/2.426	.420/.430	0.635	0.635	0.750	3.81
2 X 1/4				.555/.575				
2 X 3/8				.690/.710				
2 X 1/2				.855/.875				
2 X 3/4				1.065/1.085				
2 X 1				1.330/1.350				
2 X 1-1/4				1.675/1.695				
2 X 1-1/2	1.915/1.935							
2-1/2 X 1/8 *	1.865	4.312	2.906/2.931	.420/.430	0.635	0.635	0.750	4.10
2-1/2 X 1/4 *				.555/.575				
2-1/2 X 3/8 *				.690/.710				
2-1/2 X 1/2 *				.855/.875				
2-1/2 X 3/4 *				1.065/1.085				
2-1/2 X 1 *				1.330/1.350				
2-1/2 X 1-1/4 *				1.675/1.695				
2-1/2 X 1-1/2 *				1.915/1.935				
2-1/2 X 2 *				2.406/2.426				

Class 3000 Forged Carbon Steel Socket Weld Reducer Inserts

ASTM A105, MSS SP-79

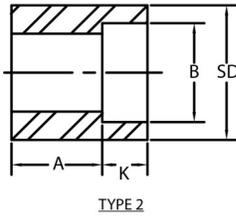
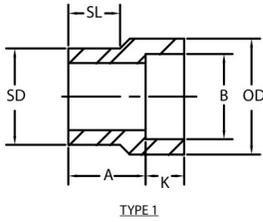
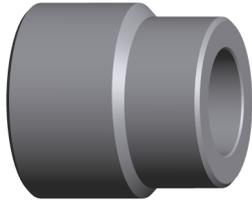

Sizes marked with * not covered by MSS SP-79

Pipe Size	Type	K	A	SD	B	OD	SL	Wt. Ea.
1/4 x 1/8 *	1	0.380	0.750	0.540	0.430	0.750	0.560	0.40
3/8 x 1/4	1	0.380	0.750	0.675	0.565	0.875	0.560	0.07
3/8 x 1/8 *	1		0.750		0.430	0.875	0.560	0.07
1/2 x 3/8	1	0.380	0.810	0.840	0.700	1.062	0.620	0.20
1/2 x 1/4	1		0.810		0.565	0.875	0.620	0.13
1/2 x 1/8 *	2	0.380	0.810	1.050	0.430	---	---	0.15
3/4 x 1/2	1		0.880		0.865	1.250	0.690	0.25
3/4 x 3/8	2		0.620		0.700	---	---	0.18
3/4 x 1/4	2		0.690		0.565	---	---	0.20
3/4 x 1/8 *	2	0.500	0.690	1.315	0.430	---	---	0.22
1 x 3/4	1		0.940		1.075	1.500	0.750	0.35
1 x 1/2	2	0.380	0.620	1.660	0.865	---	---	0.36
1 x 3/8	2		0.690		0.700	---	---	0.40
1 x 1/4	2		0.750		0.565	---	---	0.44
1 x 1/8 *	2		0.750		0.430	---	---	0.48
1-1/4 x 1	1	0.500	1.000	1.900	1.340	1.875	0.810	0.65
1-1/4 x 3/4	2		0.690		1.075	---	---	0.62
1-1/4 x 1/2	2	0.380	0.750	2.375	0.865	---	---	0.65
1-1/4 x 3/8	2		0.810		0.700	---	---	0.68
1-1/4 x 1/4	2		0.880		0.565	---	---	0.72
1-1/4 x 1/8 *	2		0.880		0.430	---	---	---
1-1/2 x 1-1/4	1	0.500	1.120	2.875	1.685	2.188	0.880	0.75
1-1/2 x 1	2		0.690		1.340	---	---	0.75
1-1/2 x 3/4	2	0.380	0.750	3.500	1.075	---	---	0.83
1-1/2 x 1/2	2		0.810		0.865	---	---	0.90
1-1/2 x 3/8	2		0.880		0.700	---	---	0.95
1-1/2 x 1/4 *	2		0.880		0.565	---	---	0.95
1-1/2 x 1/8 *	2	0.500	0.880	4.500	0.430	---	---	0.95
2 x 1-1/2	1		1.250		1.925	2.500	1.000	0.93
2 x 1-1/4	2	0.380	0.810	5.625	1.685	---	---	1.30
2 x 1	2		0.880		1.340	---	---	1.40
2 x 3/4	2		0.940		1.075	---	---	1.52
2 x 1/2	2		1.000		0.865	---	---	1.59
2 x 3/8 *	2	0.500	1.000	6.750	0.700	---	---	1.69
2 x 1/4 *	2		1.000		0.565	---	---	1.80
2 x 1/8 *	2	0.620	1.000	7.875	0.430	---	---	1.90
2-1/2 x 2	1		1.810		2.416	3.000	1.500	1.60
2-1/2 x 1-1/2	2	0.500	1.380	8.500	1.925	---	---	1.70
2-1/2 x 1-1/4	2		1.440		1.685	---	---	1.80
2-1/2 x 1	2		1.500		1.340	---	---	1.90
2-1/2 x 3/4	2		1.560		1.075	---	---	2.00
2-1/2 x 1/2 *	2	0.620	1.560	9.125	0.865	---	---	2.10
2-1/2 x 3/8 *	2		1.560		0.700	---	---	2.10
2-1/2 x 1/4 *	2	0.500	1.560	9.750	0.565	---	---	---
2-1/2 x 1/8 *	2		1.560		0.430	---	---	---
3 x 2-1/2	1	0.620	1.500	10.375	2.916	3.625	1.250	2.95
3 x 2	2		1.000		2.416	---	---	3.40
3 x 1-1/2	2	0.500	1.120	11.000	1.925	---	---	3.00
3 x 1-1/4	2		1.190		1.685	---	---	2.60
3 x 1	2		1.250		1.340	---	---	2.30
3 x 3/4 *	2		1.250		1.075	---	---	2.20
3 x 1/2 *	2	0.620	1.250	11.625	0.865	---	---	2.40
3 x 3/8 *	2		1.250		0.700	---	---	---
3 x 1/4 *	2	0.500	1.250	12.250	0.565	---	---	---
3 x 1/8 *	2		1.250		0.430	---	---	---
4 x 3	2	0.620	1.310	12.875	3.545	---	---	6.25
4 x 2-1/2	2		1.500		2.916	---	---	6.50
4 x 2	2	0.500	1.500	13.500	2.416	---	---	6.80
4 x 1-1/2	2		1.620		1.925	---	---	7.00
4 x 1-1/4	2		1.690		1.685	---	---	7.20
4 x 1 *	2		1.690		1.340	---	---	7.40
4 x 3/4 *	2	0.620	1.690	14.125	1.075	---	---	---
4 x 1/2 *	2		1.690		0.865	---	---	---
4 x 3/8 *	2	0.500	1.690	14.750	0.700	---	---	---
4 x 1/4 *	2		1.690		0.565	---	---	---
4 x 1/8 *	2	1.690	0.430	---	---	---		

For Use With Schedule 40 or 80 Pipe

Class 6000 Forged Carbon Steel Socket Weld Reducer Inserts

ASTM A105, MSS SP-79

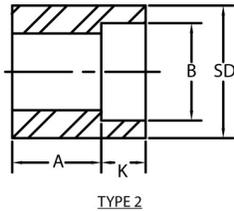
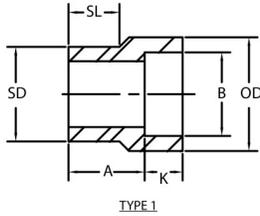
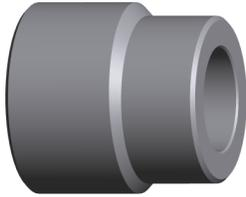

Sizes marked with * not covered by MSS SP-79

Pipe Size	Type	K	A	SD	B	OD	SL	Wt. Ea.
1/2 x 3/8	1	0.380	0.910	0.840	0.700	1.125	0.620	0.18
1/2 x 1/4	1		0.810		0.565	1.000	0.620	---
3/4 x 1/2	1	0.380	1.000	1.050	0.865	1.375	0.750	0.20
3/4 x 3/8	1		0.880		0.700	1.125	0.750	0.23
3/4 x 1/4	2		0.880		0.565	---	---	0.25
1 x 3/4	1	0.500	0.120	1.315	1.075	1.750	0.810	0.42
1 x 1/2	1	0.380	1.120		0.865	1.375	0.810	0.45
1 x 3/8	2		0.880		0.700	---	---	0.50
1 x 1/4	2		0.940		0.565	---	---	0.50
1-1/4 x 1	1	0.500	1.190	1.660	1.340	2.000	0.880	0.95
1-1/4 x 3/4	2		0.810		1.075	---	---	0.95
1-1/4 x 1/2	2	0.380	0.880		0.865	---	---	0.95
1-1/4 x 3/8	2		0.940		0.700	---	---	---
1-1/4 x 1/4	2		1.000	0.565	---	---	---	
1-1/2 x 1-1/4	1	0.500	1.380	1.900	1.685	2.500	1.000	0.95
1-1/2 x 1	2		1.150		1.340	---	---	1.12
1-1/2 x 3/4	2	1.000	1.075		---	---	1.05	
1-1/2 x 1/2	2	0.380	1.060		0.865	---	---	1.12
1-1/2 x 3/8	2		1.120		0.700	---	---	---
1-1/2 x 1/4 *	2		1.120		0.565	---	---	1.12
2 x 1-1/2	1	0.500	1.530	2.375	1.900	2.750	1.130	1.70
2 x 1-1/4	2		0.940		1.685	---	---	1.80
2 x 1	2		1.000		1.340	---	---	1.90
2 x 3/4	2		1.060		1.075	---	---	2.00
2 x 1/2	2	0.380	1.120		0.865	---	---	2.10
2 x 3/8 *	1		1.560		0.700	2.500	1.562	---
2 x 1/4 *	1		1.810		0.565	2.500	1.562	---

For Use With Schedule 160 Pipe

Class 3000 Forged Steel Threaded Unions X-Series

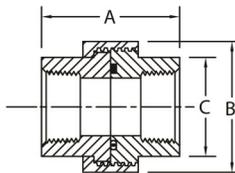
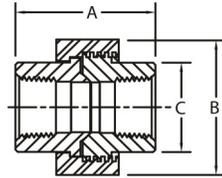
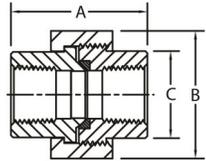
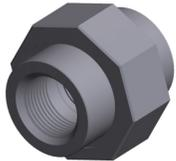
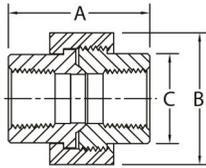

Threaded, X-Series

ASTM A-105, AAR M-404-42, MSS SP-83, ASME B1.20.1

Pipe Size	1/8	1/4	3/8	1/2	3/4	1	1-1/4	1-1/2	2	2-1/2	3
A	1.630	1.630	1.810	1.930	2.240	2.440	2.800	3.010	3.390	4.030	4.290
B	1.375	1.375	1.594	1.812	2.187	2.546	3.046	3.406	4.062	4.828	5.687
C	0.859	0.859	1.015	1.234	1.468	1.797	2.172	2.468	3.032	3.640	4.390
Wt. Ea.	0.34	0.34	0.49	0.68	1.19	1.68	2.54	3.33	5.30	8.60	12.70

Brass Seat, X-Series

ASTM A-105, AAR M-404-42 (where applicable), MSS SP-83 (where applicable), ASME B1.20.1

Pipe Size	1/8	1/4	3/8	1/2	3/4	1	1-1/4	1-1/2	2	2-1/2	3
A		1.690	1.850	1.960	2.280	2.490	2.820	3.050	3.450		
B		1.375	1.594	1.812	2.187	2.546	3.046	3.406	4.062		
C		0.859	1.015	1.234	1.468	1.797	2.172	2.468	3.032		
Wt. Ea.		0.34	0.49	0.68	1.19	1.68	2.54	3.33	5.30		

High Speed, Acme Threads, Threaded, X-Series

ASTM A-105, AAR M-404-42 (where applicable), MSS SP-83 (where applicable), ASME B1.20.1

Pipe Size	1/8	1/4	3/8	1/2	3/4	1	1-1/4	1-1/2	2	2-1/2	3
A				1.995	2.312	2.504	2.828	3.073	3.520	4.122	4.313
B				1.812	2.187	2.546	3.046	3.406	4.062	4.828	5.640
C				1.234	1.468	1.797	2.172	2.468	3.032	3.656	4.390
Wt. Ea.				0.68	1.45	1.68	2.54	3.33	5.30	8.60	12.70

High Speed, Acme Threads, O-Ring, Threaded, X-Series

ASTM A-105, AAR M-404-42 (where applicable), MSS SP-83 (where applicable), ASME B1.20.1

Pipe Size	1/8	1/4	3/8	1/2	3/4	1	1-1/4	1-1/2	2	2-1/2	3
A				1.995	2.312	2.504	2.828	3.073	3.520	4.122	4.313
B				1.812	2.187	2.546	3.046	3.406	4.062	4.828	5.640
C				1.234	1.468	1.797	2.172	2.468	3.032	3.656	4.390
Wt. Ea.				0.83	1.20	1.68	2.54	3.33	5.30	8.60	12.70

Class 3000 Forged Steel Threaded Unions X-Series

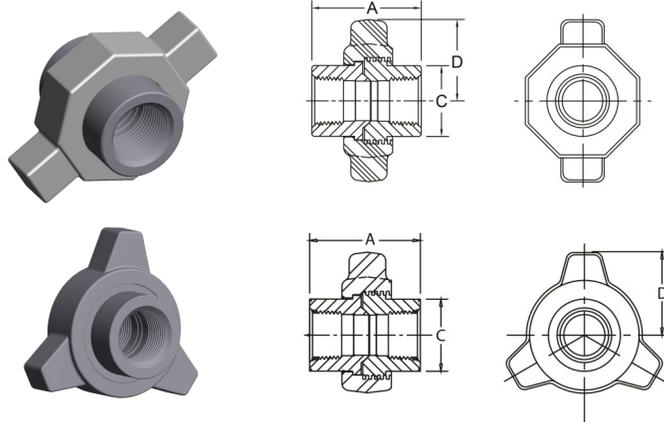

Lug, Threaded, X-Series

ASTM A-105, MSS SP-83 (where applicable), ASME B1.20.1

Pipe Size	1/4	3/8	1/2	3/4	1	1-1/4	1-1/2	2	2-1/2	3
A	1.995	1.995	1.995	2.312	2.504	2.828	3.073	3.463	4.122	4.313
C	1.234	1.234	1.234	1.468	1.797	2.172	2.468	3.032	3.656	4.390
D 2 Lug	N/A	N/A	1.545	1.862	2.172	2.468	2.937	3.422	3.906	4.500
D 3 Lug	1.410	1.410	1.410	1.681	2.188	2.273	2.522	2.959	3.396	4.072
Wt. Ea.	0.83	0.83	0.83	1.41	1.97	3.25	3.90	6.50	10.63	14.60

Available in 2 Lug and 3 Lug Unions

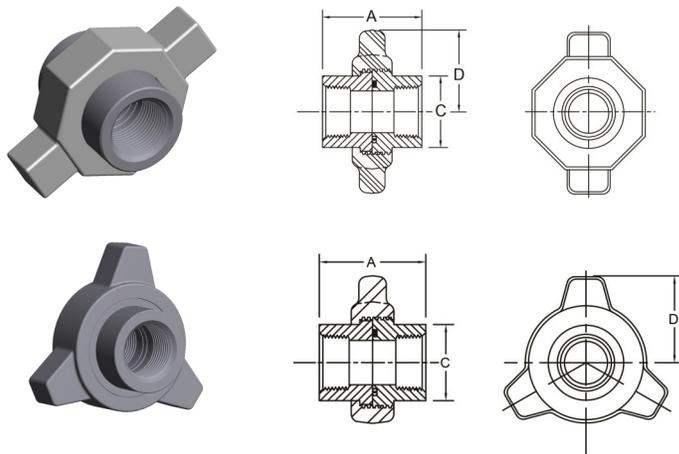

Lug, O-Ring, Threaded, X-Series

ASTM A-105, MSS SP-83 (where applicable), ASME B1.20.1

Pipe Size	1/2	3/4	1	1-1/4	1-1/2	2	2-1/2	3
A	1.995	2.312	2.504	2.828	3.073	3.463	4.122	4.313
C	1.234	1.468	1.797	2.172	2.468	3.032	3.656	4.390
D 2 Lug	1.545	1.862	2.172	2.468	2.937	3.422	3.906	4.500
D 3 Lug	1.410	1.681	2.188	2.273	2.522	2.959	3.396	4.072
Wt. Ea.	0.83	1.41	1.97	3.25	3.90	6.50	10.63	14.60

Available in 2 Lug and 3 Lug Unions

Class 6000 Forged Steel Threaded Unions X-Series

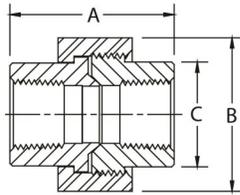

Threaded, X-Series

ASTM A-105, MSS SP-83 (where applicable), ASME B1.20.1

Pipe Size	1/8	1/4	3/8	1/2	3/4	1	1-1/4	1-1/2	2
A	1.692	1.875	2.000	2.312	2.500	2.875	3.031	3.500	4.090
B	1.375	1.582	1.812	2.186	2.546	3.043	3.393	4.053	4.821
C	0.865	1.024	1.253	1.475	1.800	2.175	2.470	3.032	3.655
Wt. Ea.	0.36	0.55	0.75	1.36	2.00	3.10	5.85	6.55	10.50

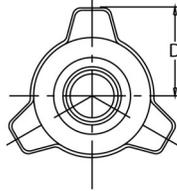
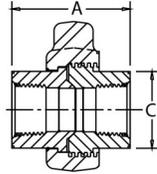
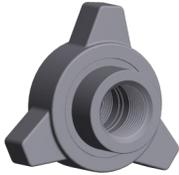

Lug, Threaded, X-Series

ASTM A-105, MSS SP-83 (where applicable), ASME B1.20.1

Pipe Size	1/2	3/4	1	1-1/4	1-1/2	2
A	2.317	2.507	2.873	3.030	3.529	4.089
C	1.485	1.810	2.195	2.485	3.032	3.660
D	1.681	2.188	2.273	2.522	2.959	3.396
Wt. Ea.	1.66	2.44	3.78	4.00	7.99	12.81

Class 3000 Forged Steel Socket Weld Unions X-Series

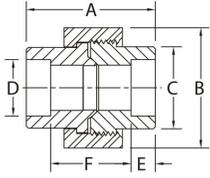

Socket Welding, X-Series

ASTM A-105, AAR M-404-42, MSS SP-83

Pipe Size	1/8	1/4	3/8	1/2	3/4	1	1-1/4	1-1/2	2	2-1/2	3
A	1.630	1.630	1.810	1.930	2.240	2.440	2.800	3.010	3.390	4.030	4.290
B	1.375	1.375	1.582	1.812	2.186	2.546	3.100	3.393	4.090	4.821	5.671
C	0.863	0.863	1.021	1.230	1.465	1.790	2.160	2.455	3.025	3.650	4.390
D	.420/ .440	.555/ .575	.690/ .710	.855/ .875	1.065/ 1.085	1.330/ 1.350	1.675/ 1.695	1.915/ 1.935	2.406/ 2.426	2.906/ 2.931	3.535/ 3.560
E	0.380	0.380	0.380	0.380	0.500	0.500	0.500	0.500	0.620	0.620	0.620
F	.75/ .88	.75/ .88	.81/ 1.06	.81/ 1.06	1.00/ 1.25	1.03/ 1.35	1.28/ 1.60	1.34/ 1.66	1.47/ 1.79	2.05/ 1.43	2.11/ 2.51
Wt. Ea.	0.34	0.34	0.49	0.68	1.19	1.68	2.54	2.33	5.30	8.60	12.70

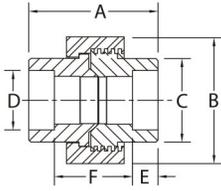
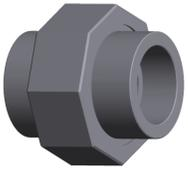

High Speed Acme Threads, Socket Welding, X-Series

ASTM A-105, AAR M-404-42 (where applicable), MSS SP-83 (where applicable)

Pipe Size	1/8	1/4	3/8	1/2	3/4	1	1-1/4	1-1/2	2	2-1/2	3
A				1.995	2.312	2.504	2.828	3.073	3.520	4.122	4.313
B				1.812	2.187	2.546	3.046	3.406	4.062	4.828	5.640
C				1.234	1.468	1.797	2.172	2.468	3.032	3.656	4.390
D				.855/ .875	1.065/ 1.085	1.330/ 1.350	1.675/ 1.695	1.915/ 1.935	2.406/ 2.426	2.906/ 2.931	3.535/ 3.560
E				0.380	0.500	0.500	0.500	0.500	0.620	0.620	0.620
F				.81/ 1.06	1.00/ 1.25	1.03/ 1.35	1.28/ 1.60	1.34/ 1.66	1.47/ 1.79	2.05/ 1.43	2.11/ 2.51
Wt. Ea.				0.68	1.19	1.68	2.54	3.33	5.30	8.60	12.70

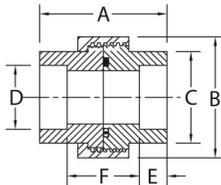

High Speed Acme Threads, O-Ring, Socket Welding, X-Series

ASTM A-105, AAR M-404-42 (where applicable), MSS SP-83 (where applicable)

Pipe Size	1/8	1/4	3/8	1/2	3/4	1	1-1/4	1-1/2	2	2-1/2	3
A				1.995	2.312	2.504	2.828	3.073	3.520	4.122	4.313
B				1.812	2.187	2.546	3.046	3.406	4.062	4.828	5.640
C				1.234	1.468	1.797	2.172	2.468	3.032	3.656	4.390
D				.855/ .875	1.065/ 1.085	1.330/ 1.350	1.675/ 1.695	1.915/ 1.935	2.406/ 2.426	2.906/ 2.931	3.535/ 3.560
E				0.380	0.500	0.500	0.500	0.500	0.620	0.620	0.620
F				.887/ .981	1.074/ 1.168	1.145/ 1.244	1.369/ 1.468	1.483/ 1.585	1.616/ 1.715	2.232/ 2.346	2.272/ 2.388
Wt. Ea.				0.68	1.19	1.68	2.54	3.33	5.30	8.60	12.70

Class 3000 Forged Steel Socket Weld Unions X-Series

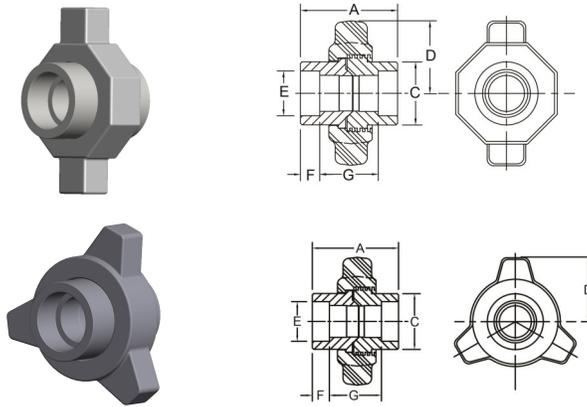

Lug, Socket Welding, X-Series

ASTM A-105, MSS SP-83 (where applicable)

Available in 2 Lug and 3 Lug styles

Pipe Size	1/2	3/4	1	1-1/4	1-1/2	2	2-1/2	3
A	1.995	2.312	2.504	2.828	3.073	3.463	4.122	4.313
C	1.234	1.468	1.797	2.172	2.468	3.032	3.656	4.390
D 2 Lug	1.545	1.862	2.172	2.468	2.937	3.422	3.906	4.500
D 3 Lug	1.410	1.681	2.188	2.273	2.522	2.959	3.396	4.072
E	.855/.875	1.065/1.085	1.330/1.350	1.675/1.695	1.915/1.935	2.406/2.426	2.906/2.931	3.535/3.560
F	0.380	0.500	0.500	0.500	0.500	0.620	0.620	0.620
G	1.06/.81	1.25/1.00	1.35/1.03	1.60/1.28	1.66/1.34	1.79/1.47	2.43/2.05	2.51/2.11
Wt. Ea.	0.83	1.41	1.97	3.25	3.90	6.50	10.63	14.60

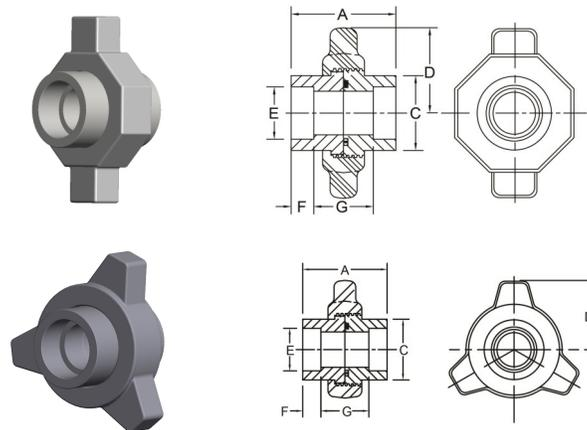

Lug, O-Ring, Socket Welding, X-Series

ASTM A-105, MSS SP-83 (where applicable)

Available in 2 Lug and 3 Lug styles

Pipe Size	1/2	3/4	1	1-1/4	1-1/2	2	2-1/2	3
A	1.995	2.312	2.504	2.828	3.073	3.463	4.122	4.313
C	1.234	1.468	1.797	2.172	2.468	3.032	3.656	4.390
D 2 Lug	1.545	1.862	2.172	2.468	2.937	3.422	3.906	4.500
D 3 Lug	1.410	1.681	2.188	2.273	2.522	2.959	3.396	4.072
E	.855/.875	1.065/1.085	1.330/1.350	1.675/1.695	1.915/1.935	2.406/2.426	2.906/2.931	3.535/3.560
F	0.380	0.500	0.500	0.500	0.500	0.620	0.620	0.620
G	.981/.887	1.168/1.074	1.244/1.145	1.468/1.369	1.585/1.483	1.715/1.616	2.346/2.232	2.388/2.272
Wt. Ea.	0.83	1.41	1.97	3.25	3.90	6.50	10.63	14.60

Class 6000 Forged Steel Socket Weld Unions X-Series

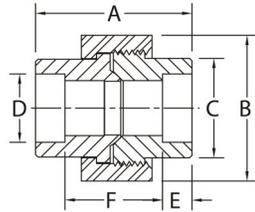
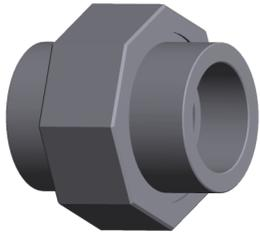

Socket Welding, X-Series

ASTM A-105, MSS SP-83 (where applicable)

Pipe Size	1/2	3/4	1	1-1/4	1-1/2	2
A	2.312	2.500	2.875	3.031	3.500	4.090
B	2.186	2.546	3.043	3.393	4.053	4.821
C	1.475	1.800	2.175	2.470	3.032	3.655
D	.855/ .875	1.065/ 1.085	1.330/ 1.350	1.675/ 1.695	1.915/ 1.935	2.406/ 2.426
E REF	0.562	0.625	0.750	0.812	0.875	1.000
F	1.195	1.259	1.379	1.413	1.734	2.077
Wt. Ea.	1.36	2.00	3.10	5.85	6.55	10.50

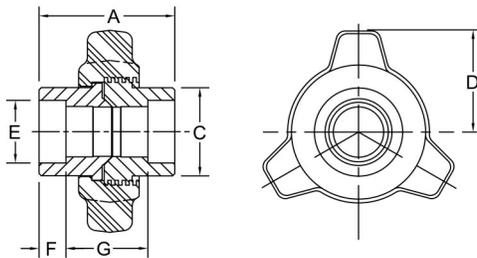
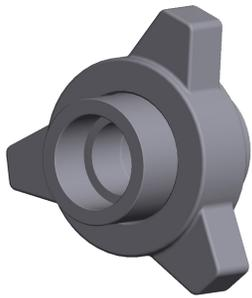

Lug Socket Welding, X-Series

ASTM A-105, MSS SP-83 (where applicable)

Pipe Size	1/2	3/4	1	1-1/4	1-1/2	2	2-1/2
A	2.317	2.507	2.873	3.030	3.529	4.089	4.314
C	1.485	1.810	2.195	2.485	3.032	3.660	4.395
D	1.681	2.188	2.273	2.522	2.959	3.396	4.072
E	.855/ .875	1.065/ 1.085	1.330/ 1.350	1.675/ 1.695	1.915/ 1.935	2.406/ 2.426	2.906/ 2.931
F REF	0.562	0.625	0.750	0.960	0.875	1.000	0.918
G	1.195	1.259	1.379	1.413	1.783	2.077	2.446
Wt. Ea.	1.66	2.44	7.87	7.14	7.99	7.99	11.00

Pipe Nipples

ASME B1.20.1

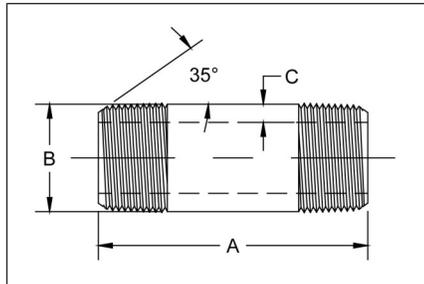

Pipe Nipples, Welded and Seamless, Carbon Steel and Stainless Steel

PIPE SIZE	PIPE OD B	LENGTH A		NOMINAL WALL C			
		CLOSE	SPACE	STD	XH	160	XXH
1/8	0.405	3/4	1-1/2 - 24	0.068	0.095	N/A	N/A
1/4	0.540	7/8	1-1/2 - 24	0.088	0.119	N/A	N/A
3/8	0.675	1	1-1/2 - 24	0.091	0.126	N/A	N/A
1/2	0.840	1-1/8	1-1/2 - 24	0.109	0.147	0.188	0.294
3/4	1.050	1-3/8	1-1/2 - 24	0.113	0.154	0.219	0.308
1	1.315	1-1/2	2 - 24	0.133	0.179	0.250	0.358
1-1/4	1.660	1-5/8	2 - 24	0.140	0.191	0.250	0.382
1-1/2	1.900	1-3/4	2 - 24	0.145	0.200	0.281	0.400
2	2.375	2	2-1/2 - 24	0.154	0.218	0.344	0.436
2-1/2	2.875	2-1/2	3 - 24	0.203	0.276	0.375	0.552
3	3.500	2-5/8	3 - 24	0.216	0.300	0.438	0.600
3-1/2	4.000	2-3/4	4 - 24	0.226	0.318	N/A	N/A
4	4.500	2-7/8	4 - 24	0.237	0.337	0.531	0.674
5	5.563	3	4-1/2 - 24	0.258	0.375	0.625	0.750
6	6.625	3-1/8	4-1/2 - 24	0.280	0.432	0.719	0.864
8	8.625	3-1/2	5 - 24	0.322	0.500	0.906	0.875

Continuous Welded - ASTM A53 Type F

Electric Resistance Welded - ASTM A53 Type E, Grade B

Seamless, High Temperature - ASTM A106 Grade B, ASTM A53 Type S, Grade B, API 5L, Grade B

Seamless, Low Temperature - ASTM A333 Grade 6

Electric Resistance Welded - ASTM A312, Type 304/304L or 316/316L

Seamless, ASTM A312 Type 304/304L or 316/316L

Threads conform to ASME B.1.20.1

Pipe Nipples

ASME B1.20.1

Pipe Nipple End Finishes

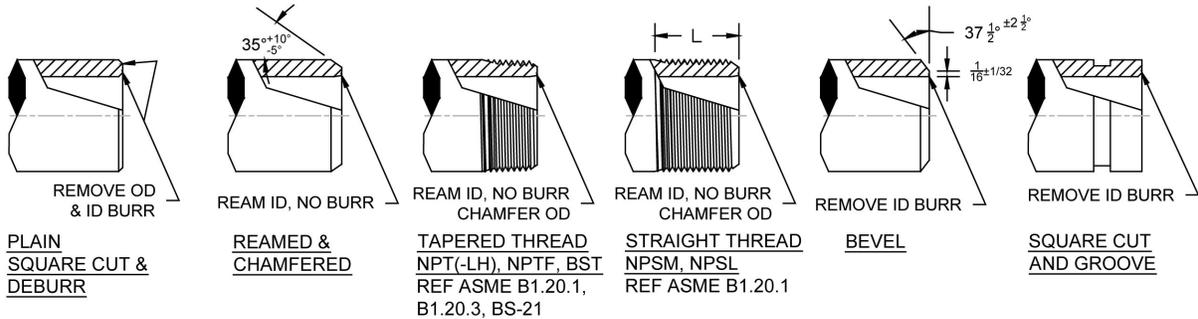

PIPE NIPPLE DESCRIPTION AND TERMINOLOGY

EXAMPLE: $\frac{3}{4}$ x 12 SCH40 SMLS 304 NIPPLE T x B NPSM x 2"

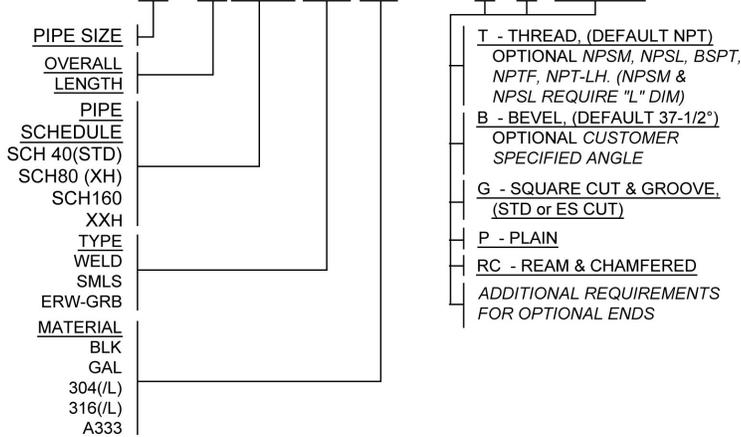

- NOTES: 1) END FINISH ABBREVIATION ORDER; T, B, G, P, RC.
 2) TBE, BBE, GBE, AND PBE MAY BE SUBSTITUTED FOR NIPPLES WITH SAME END FINISHES ON BOTH ENDS.
 3) DEFAULT END FINISHES LISTED FOR THREAD, BEVEL, AND PLAIN. OPTIONAL VARIATIONS TO BE CALLED OUT IN TEXT INCLUDING ADDITIONAL REQUIREMENTS.
 4) STD CUT GROOVE IS STANDARD. ES CUT GROOVE END FINISH AVAILABLE UPON REQUEST
 5) NIPPLES CLOSE TOUGH 12" LONG SHALL HAVE A LENGTH TOLERANCE OF $\pm \frac{1}{16}$ ". NIPPLES OVER 12" LONG SHALL HAVE A TOLERANCE OF $\pm \frac{1}{8}$ ".

TBE - "THREAD BOTH ENDS" (BOTH ENDS THREADED WITH STANDARD NPT THREADS)

TOE - "THREAD ONE END" (ONE END THREADED WITH STANDARD NPT THREAD. CUSTOMER MUST SPECIFY OTHER END, OTHERWISE SQUARE CUT & DEBURR WILL BE SHIPPED)

NPTF - "DRYSEAL" (STANDARD TAPER DRYSEAL PIPE THREADS)

NPSL - "STRAIGHT LOCKNUT" (STANDARD STRAIGHT PIPE THREADS FOR LOOSE-FITTING MECHANICAL WITH LOCKNUTS)

NPSM - "STRAIGHT MECHANICAL" (STANDARD STRAIGHT PIPE THREADS FOR FREE-FITTING MECHANICAL JOINTS FOR FIXTURES)

BST (BS21, ISO 7/1) - BRITISH STANDARD TAPER PIPE THREADS

API Products

API 5B, API 5CT

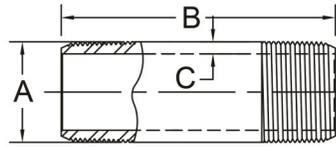

API Casing Nipples, 8RD

K55, N80, L80 and P110 Materials

Casing Size	4-1/2	4-1/2	5-1/2	5-1/2	7	8-5/8	9-5/8
Lbs per Foot	10.5	11.6	14.0	15.5	20.0	24.0	36.0
A	4.500	4.500	5.500	5.500	7.000	8.625	9.625
B	Per Customer Requirements						
C	0.224	0.250	0.244	0.275	0.272	0.264	0.352
Wt. Ea.	Available Upon Request						

API 8RD Threads Identified with Red Stripe

Electro-Zinc Plated

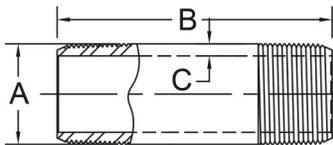

API Tubing Nipples, EUE -With and Without Center Turned

J55, N80 STD, XH and XXH Schedules

NPS Size	3/4	1	1-1/4	1-1/2	2	2-1/2	3	3-1/2	4
API 5CT Size	1.050	1.315	1.660	1.900	2-3/8	2-7/8	3-1/2	4	4-1/2
Threads/Inch	10 RD	10 RD	10 RD	10 RD	8 RD	8 RD	8 RD	8 RD	8 RD
A	1.315	1.469	1.812	2.094	2.594	3.094	3.750	4.250	4.750
B	Per Customer Requirements								
C for Std	0.246	0.210	0.216	0.242	0.299	0.326	0.379	0.387	0.396
C for XH	0.287	0.256	0.266	0.296	0.360	0.390	0.437	0.438	0.467
C for XXH	0.441	0.435	0.458	0.497	0.547	0.672	0.750	0.75	0.812
D	1.050	1.315	1.660	1.900	2.375	2.875	3.500	4.000	4.500
E	2.250	2.375	2.500	2.563	3.063	3.250	3.500	3.625	3.750
Approx. Weight	Available Upon Request								

API 8RD Threads Identified with Red Stripe
API 10RD Threads Identified with Yellow Stripe

Electro-Zinc Plated

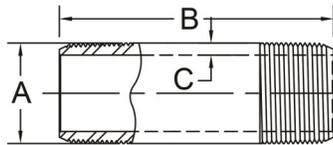

API Tubing Nipples, NUE

J55, N80 STD and XH Schedules

NPS Size	3/4	1	1-1/4	1-1/2	2	2-1/2	3	3-1/2	4
API 5CT Size	1.050	1.315	1.660	1.900	2-3/8	2-7/8	3-1/2	4	4-1/2
Threads/Inch	10 RD	10 RD	10 RD	10 RD	10 RD	10 RD	10 RD	8 RD	8 RD
A	1.050	1.315	1.660	1.900	2.375	2.875	3.500	4.000	4.500
B	Per Customer Requirements								
C for Std	0.113	0.133	0.140	0.145	0.190	0.217	0.254	0.262	0.271
C for XH	0.154	0.179	0.191	0.200	0.250	0.281	0.312	0.312	0.343
Approx. Weight	Available Upon Request								

API 8RD Threads Identified with Red Stripe
API 10RD Threads Identified with Yellow Stripe

Electro-Zinc Plated

API Products

API 5B, API 5CT, API 5L

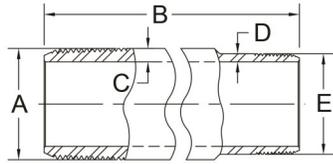

API Tubing Nipples, Combination EUE x NUE J55, N80 STD and XH Schedules

EUE x NUE Size	2x2	2-1/2x2-1/2	3x3	3-1/2x3-1/2	4x4
EUE Threads/Inch	8 RD	8 RD	8 RD	8 RD	8 RD
NUE Threads/Inch	10RD	10RD	10RD	10RD	8RD
A	2.594	3.094	3.750	4.250	4.750
B	Per Customer Requirements				
C for Std	0.299	0.326	0.379	0.387	0.396
C for XH	0.360	0.390	0.437	0.438	0.467
D for Std	0.190	0.217	0.254	0.226	0.271
D for XH	0.250	0.281	0.312	0.312	0.343
E	2.375	2.875	3.500	4.000	4.500
Approx. Wt. #	Available Upon Request				

API 8RD Threads Identified with Red Stripe
API 10RD Threads Identified with Yellow Stripe

Electro-Zinc Plated

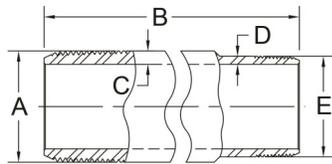

API Tubing Nipples, Combination EUE x LP J55, N80 STD and XH Schedules

EUE x LP Size	2x2	2-1/2x2-1/2	3x3	3-1/2x3-1/2	4x4
EUE Threads/Inch	8 RD	8 RD	8 RD	8 RD	8 RD
LP Threads/Inch	11.5	8.0	8.0	8.0	8.0
A	2.594	3.094	3.750	4.250	4.750
B	Per Customer Requirements				
C for Std	0.299	0.326	0.379	0.387	0.396
C for XH	0.360	0.390	0.437	0.438	0.467
D for Std	0.176	0.232	0.247	0.258	0.271
D for XH	0.251	0.281	0.312	0.313	0.342
E	2.375	2.875	3.500	4.000	4.500
Wt. Ea.	Available Upon Request				

Electro-Zinc Plated

API 8RD Threads are Identified with Red Stripe

API Casing Swage Nipples

API 5B, API 5CT, API 5L, K55 and N80

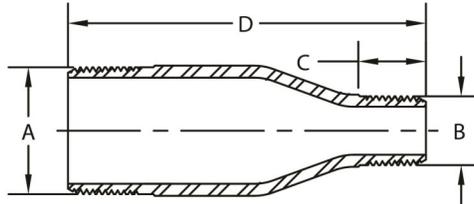

Pipe Size	A	B	C	D	Wt Ea.
4-1/2 OD 8RD 11.6 lb/ft x 2 NUE 10RD XH	4.500	2.375	2.125	9.00	12.00
4-1/2 OD 8RD 10.5 lb/ft X 2-1/2 EUE 8RD STD		3.094	2.625	11.00	8.00
4-1/2 OD 8RD 11.6 lb/ft X 2-1/2 EUE 8RD XH					12.00
4-1/2 OD 8RD 11.6 lb/ft X 3 NUE 10RD XH		3.500	2.750	9.00	7.50
5-1/2 OD 8RD 14.0 lb/ft X 2 LP 11.5V STD	5.500	2.375	1.625	11.00	12.50
5-1/2 OD 8RD 20.0 lb/ft X 2 LP 11.5V XH					17.00
5-1/2 OD 8RD 14.0 lb/ft X 2-1/2 EUE 8RD STD		3.094	2.625		12.50
5-1/2 OD 8RD 14.0 lb/ft X 3 LP 8V STD		3.500	2.000		12.50
7 OD 8RD 23.0 lb/ft X 2 LP 11.5V STD	7.000	2.375	1.562	12.00	16.10
7 OD 8RD 38.0 lb/ft X 2 LP 11.5V XH					25.00
7 OD 8RD 23.0 lb/ft X 4-1/2 OD 8RD STD		4.500	3.000		17.00
8-5/8 OD 8RD 32.0 lb/ft X 2 LP 11.5V STD	8.625	2.375	1.562	13.00	-
8-5/8 OD 8RD 32.0 lb/ft X 4-1/2 OD 8RD STD		4.500	3.125		-
8-5/8 OD 8RD 24.0 lb/ft X 7 OD 8RD STD		7.000	3.625		-

API Tubing Swage Nipples

API 5B, API 5CT, API 5L, J55, K55, L80, N80 and P110

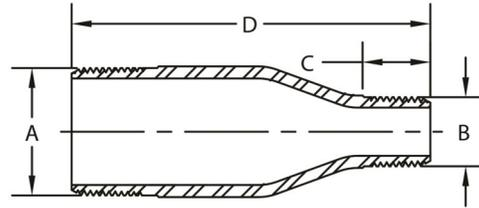

Pipe Size	A	B	C	D	Approx. Wt.			
					Std	XH	XXH	
1-1/2" NUE 10RD X 1" LP 11.5V	1.900	1.315	0.985	4.50	-	2.50	-	
2" NUE 10RD X 1-1/2" NUE 10RD	2.375	1.900	1.375	6.50	2.00	3.00	-	
2" LP 11.5V X 1-1/2" NUE 10RD					2.00	2.33	-	
2" EUE 8RD X 1" LP 11.5V	2.594	1.315	0.985	8.00	2.50	4.00	-	
2" EUE 8RD X 1-1/4" EUE 10RD		1.812	1.375		2.50	-	-	
2" EUE 8RD X 1-1/2" EUE 10RD		2.094	1.438	2.50	4.00	-		
2" EUE 8RD x 2" NUE 10RD		2.375	1.625	6.00	3.50	-	-	
2" EUE 8RD X 2" NUE 10RD				8.00	4.00	-	-	
2" EUE 8RD X 2" NUE 10RD				12.00	7.00	-	-	
2-1/2" NUE 10RD X 2" LP 11.5V		2.875	2.375	1.058	8.00	3.00	6.00	-
2-1/2" LP 8V X 2" EUE 8RD	2.594		1.938	7.00	4.00	6.00	-	
2-1/2" EUE 8RD X 2" LP 11.5V	3.094	2.375	1.058	8.00	5.00	6.00	-	
2-1/2" EUE 8RD X 2" NUE 10RD			1.625		5.00	-	-	
2-1/2" EUE 8RD X 2" EUE 8RD		2.594	1.938	12.00	7.50	-	-	
2-1/2" EUE 8RD X 2-1/2" NUE 10RD				2.875	2.063	6.00	3.50	-
3" NUE 10RD X 2" LP 11.5V		3.500	2.375	1.058	8.00	4.50	6.00	-
3" LP 8V X 2" EUE 8RD			2.594	1.938		6.00	7.50	-
3" NUE 10RD X 2-1/2" EUE 8RD	3.094		2.125	12.00	6.00	9.00	-	
3" LP 8V X 2-1/2" EUE 8RD				10.80	13.85	-	-	
3" EUE 8RD X 2" LP 11.5V	3.750	2.375	1.058	8.00	7.50	7.50	-	
3" EUE 8RD X 2" EUE 8RD		2.594	1.938		7.50	9.00	-	
3" EUE 8RD X 2-1/2" LP 8V		2.875	1.571		7.50	9.50	-	
3" EUE 8RD X 2-1/2" EUE 8RD		3.094	2.125		7.50	9.00	-	
3" EUE 8RD X 2-1/2" EUE 8RD					12.00	10.00	12.40	-
4" LP 8V X 2-1/2" EUE 8RD	4.500	3.094	2.125	9.00	-	-	-	
4" NPT 8V X 3" EUE 8RD		3.750	2.375	12.00	14.67	-	-	
4" NUE 8RD X 2" LP 11.5V		2.375	1.058	9.00	7.50	7.50	18.00	
4" NUE 8RD X 2-1/2" EUE 8RD					3.094	2.125	-	-
4" NUE 8RD X 3" LP 8V		3.500	1.634	7.50	10.00	-		
4" EUE 8RD X 2" LP 11.5V	4.750	2.375	1.058	9.00	8.00	14.67	-	
4" EUE 8RD X 2" LP 11.5V				11.00	-	-	-	
4" EUE 8RD X 2-1/2" EUE 8RD		3.094	2.125	12.00	14.67	-	-	
4" EUE 8RD X 3" EUE 8RD				14.67	-	-		
4" EUE 8RD X 3" EUE 8RD		3.750	2.375	9.00	8.00	-	-	

Available STD, XH, and XXH upon request

Note: NUE and EUE tubing size descriptions are the former NPS ID pipe size nomenclature still used in the swage nipple and bull plug industry. For current NUE and EUE OD tubing size description labels see API 5CT.

Couplings—Standard Merchant

ASTM A53 Type F 1/8" - 3", ASTM A106 Grade B 3-1/2" - 6"

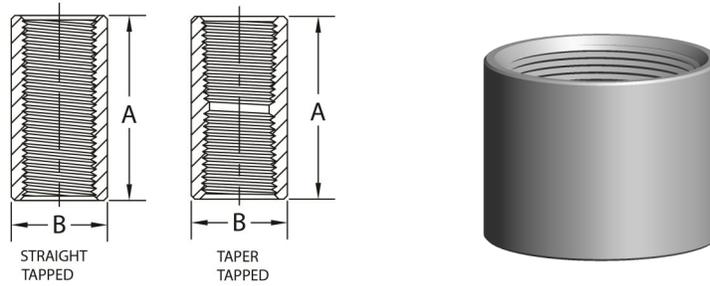

Couplings, Standard Merchant

ASTM A865, ASME B1.20.1

Pipe Size	1/8	1/4	3/8	1/2	3/4	1	1-1/4	1-1/2	2	2-1/2	3	3-1/2	4	5	6
A	0.812	1.188	1.188	1.562	1.625	2.000	2.062	2.062	2.125	3.125	3.250	3.375	3.500	3.750	4.000
B	0.562	0.719	0.875	1.062	1.312	1.576	1.900	2.200	2.750	3.250	4.000	4.625	5.000	6.296	7.390
Wt. Ea.	0.05	0.07	0.09	0.17	0.26	0.40	0.48	0.67	1.05	2.09	3.35	4.82	4.61	8.52	11.27

Unless otherwise specified, Standard Merchant Couplings are furnished straight tapped in sizes in sizes 1/8" to 2" inclusive.

Standard Merchant Couplings in 2" size are available Taper Tapped as special.

Standard Merchant Couplings in sizes 2-1/2" to 6" are furnished Taper Tapped.

Galvanized couplings are Electro Zinc Plated.

Black couplings are phosphate coated.



Standard Merchant, R&L

ASTM A865, ASME B1.20.1

Pipe Size	1/8	1/4	3/8	1/2	3/4	1	1-1/4	1-1/2	2	2-1/2	3	3-1/2	4
A	0.812	1.188	1.188	1.562	1.625	2.000	2.062	2.062	2.125	3.125	3.250	3.375	3.500
B	0.562	0.719	0.875	1.062	1.312	1.576	1.900	2.200	2.750	3.250	4.000	4.625	5.000
Wt. Ea.	0.05	0.07	0.09	0.17	0.26	0.40	0.48	0.67	1.05	2.09	3.35	4.82	4.61

All R&L Couplings are Taper Tapped

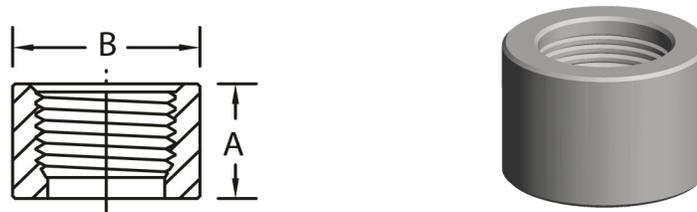

Half Couplings, Standard Merchant

ASTM A865, ASME B1.20.1

Pipe Size	1/8	1/4	3/8	1/2	3/4	1	1-1/4	1-1/2	2	2-1/2	3	3-1/2	4	5	6
A	0.344	0.531	0.531	0.719	0.750	0.937	0.969	0.969	1.000	1.500	1.562	1.625	1.688	1.750	1.875
B	0.562	0.719	0.875	1.062	1.312	1.576	1.900	2.200	2.750	3.250	4.000	4.625	5.000	6.296	7.390
Wt. Ea.	0.02	0.04	0.05	0.08	0.12	0.18	0.23	0.32	0.47	0.96	1.60	2.22	2.11	3.80	5.28

Unless otherwise specified, Standard Merchant Half Couplings are furnished Taper Tapped in sizes 1/8" to 1" inclusive,

Straight Tapped in sizes 1-1/4" to 2" inclusive and Taper Tapped in sizes 2-1/2" to 6" inclusive.

Galvanized couplings are Electro Zinc Plated.

Black couplings are phosphate coated.

Couplings

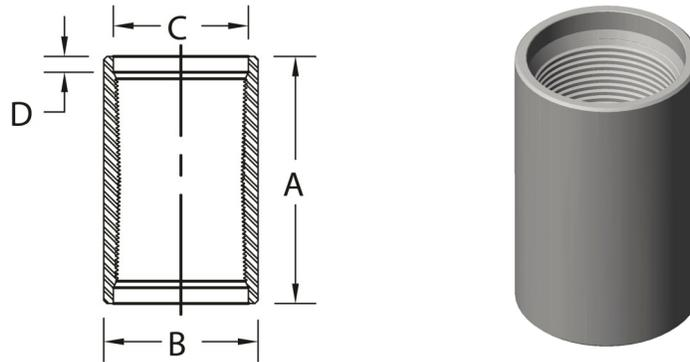

API Line Pipe Couplings

API 5L, API 5B

Pipe Size	1/8	1/4	3/8	1/2	3/4	1	1-1/4	1-1/2	2
A	1.062	1.625	1.625	2.125	2.125	2.625	2.750	2.750	2.875
B	0.562	0.718	0.875	1.062	1.312	1.576	2.054	2.200	2.875
C	0.468	0.603	0.738	0.903	1.113	1.378	1.723	1.963	2.469
D	0.052	0.120	0.115	0.158	0.152	0.224	0.228	0.244	0.238
Wt. Ea.	0.04	0.09	0.13	0.24	0.34	0.54	1.03	1.30	1.86

Pipe Size	2-1/2	3	3-1/2	4	5	6	8	10	12
A	4.125	4.250	4.375	4.500	4.625	4.875	5.250	5.750	6.125
B	3.375	4.000	4.625	5.200	6.296	7.390	9.625	11.750	14.000
C	2.969	3.594	4.094	4.594	5.657	6.719	8.719	10.844	12.844
D	0.492	0.471	0.466	0.492	0.505	0.586	0.677	0.739	0.787
Wt. Ea.	3.27	4.09	5.92	7.59	9.98	12.92	23.18	31.55	49.27

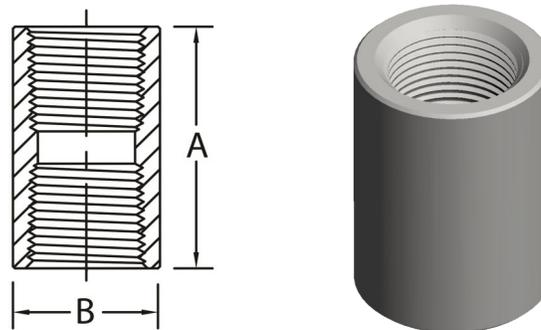

Couplings, XH No Recess, Threaded

ASTM A106, AAR 404, ASME B1.20.1

Pipe Size	1/8 *	1/4	3/8	1/2	3/4	1	1-1/4	1-1/2	2	2-1/2	3	3-1/2 *	4 *	5 *	6 *
A	1.062	1.625	1.625	2.125	2.125	2.625	2.750	2.750	2.875	4.125	4.250	4.375	4.500	4.625	4.875
B	0.562	0.719	0.875	1.062	1.312	1.576	2.054	2.200	2.875	3.375	4.000	4.625	5.200	6.296	7.390
Wt. Ea.	0.04	0.09	0.14	0.25	0.36	0.68	1.08	0.95	2.01	3.53	4.61	6.25	8	10.51	13.74

Sizes marked " * " not covered under AAR 404

Couplings

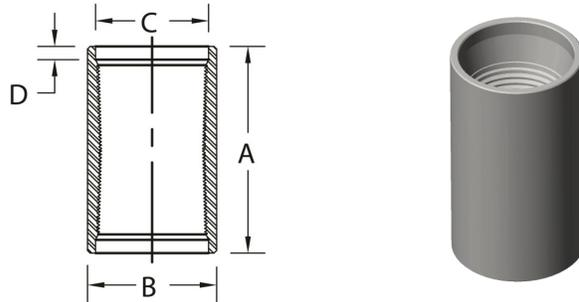

Couplings, Waterwell Ream & Drifted, Threaded ASTM A106, ASTM 865, ASME B1.20.1

Pipe Size	1-1/4	1-1/2	2	2-1/2	3	3-1/2	4
A	2.750	2.750	3.375	3.937	4.062	4.187	4.312
B	1.718	1.969	2.468	2.969	3.594	4.094	4.594
C	0.188	0.188	0.188	0.188	0.188	0.188	0.188
D	1.900	2.200	2.750	3.250	4.000	4.625	5.200
Wt. Ea.	0.60	0.84	1.58	2.32	3.80	5.53	7.14

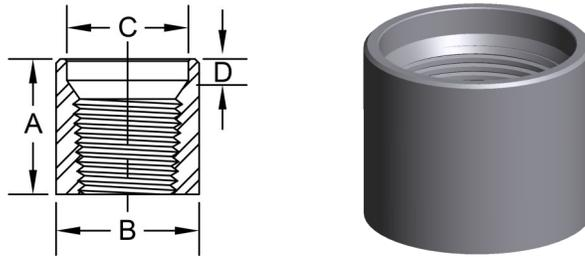

Half Couplings, XH, Recess, Taper Thread ASTM A106, ASME B1.20.1

Pipe Size	3/4	2	2-1/2	3	4	8	10	12
A	1.000	1.375	2.000	2.062	2.188	2.500	2.750	2.937
B	1.313	2.875	3.375	4.000	5.200	9.625	11.750	14.000
C	1.113	2.469	2.969	3.594	4.594	8.719	10.844	12.844
D	0.152	0.238	0.492	0.471	0.492	0.677	0.739	0.787
Wt. Ea.	0.17	0.92	1.72	2.12	3.84	11.50	14.50	17.00

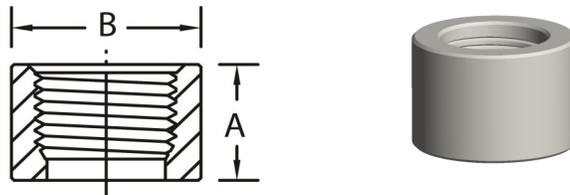

Half Couplings, XH, No Recess, Taper Thread ASTM A106, ASME B1.20.1

Pipe Size	1/8	1/4	3/8	1/2	3/4	1	1-1/4
A	0.469	0.750	0.750	1.000	1.000	1.250	1.312
B	0.563	0.719	0.875	1.063	1.313	1.576	2.054
Wt. Ea.	0.02	0.04	0.06	0.11	0.17	0.35	0.51

Pipe Size	1-1/2	2	2-1/2	3	4	5	6
A	1.312	1.375	2.000	2.062	2.188	2.188	2.312
B	2.200	2.875	3.375	4.000	5.200	6.296	7.390
Wt. Ea.	0.45	0.92	1.72	2.12	3.84	4.85	6.85

Swage Nipples - Threaded Both Ends

ASTM A234, MSS SP-95, ASME B1.20.1

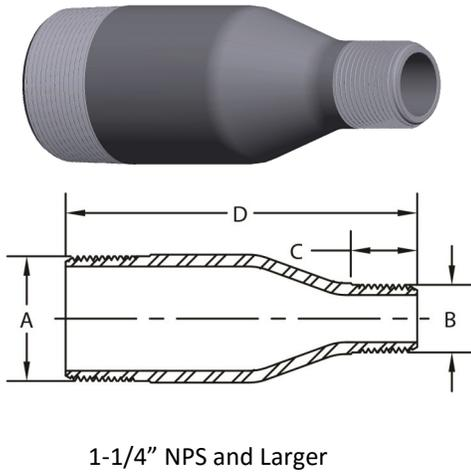
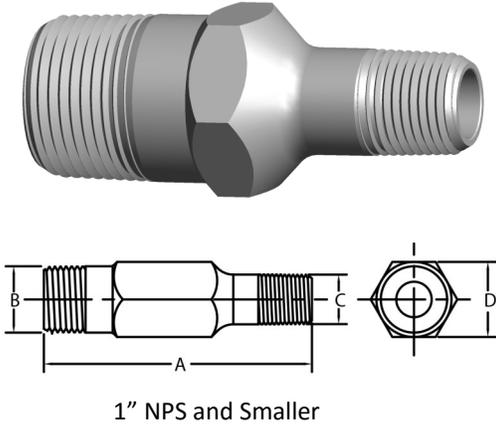

Pipe Size	A	B	C	D	Wt. Ea.			
					Std	XH	160	XXH
1/2 X 1/8	2.750	0.840	0.405	0.875	N/A	0.33	0.50	0.50
1/2 X 1/4			0.540					
1/2 X 3/8			0.675					
3/4 X 1/8	3.000	1.050	0.405	1.125	N/A	0.50	0.75	0.75
3/4 X 1/4			0.540					
3/4 X 3/8			0.675					
3/4 X 1/2	3.500	1.315	0.840	1.375	N/A	0.67	1.00	1.00
1 X 1/8			0.405					
1 X 1/4			0.540					
1 X 3/8			0.675					
1 X 1/2			0.840					
1 X 3/4	1.050							
1-1/4 x 1/2	4.000	1.660	0.840	1.250	N/A	1.00	1.50	1.50
1-1/4 x 3/4			1.050	1.250				
1-1/4 x 1	4.500	1.900	1.315	1.375	N/A	1.17	2.00	2.00
1-1/2 x 1/2			0.840	1.250				
1-1/2 x 3/4			1.050	1.250				
1-1/2 x 1			1.315	1.375				
1-1/2 x 1-1/4			1.660	1.375				
2 x 1/4	6.500	2.375	0.540	1.000	N/A	3.00	4.25	4.25
2 x 3/8			0.675	1.000				
2 x 1/2			0.840	1.250				
2 x 3/4			1.050	1.250				
2 x 1			1.315	1.375				
2 x 1-1/4	7.000	2.875	1.660	1.375	2.00	2.33	4.25	4.25
2 x 1-1/2			1.900	1.437				
2-1/2 x 3/4			1.050	1.250				
2-1/2 x 1	7.000	2.875	1.315	1.375	3.00	3.50	8.00	8.00
2-1/2 x 1-1/4			1.660	1.375				
2-1/2 x 1-1/2			1.900	1.437				
2-1/2 x 2			2.375	1.500				
3 x 1/2			2.875	1.500				
3 x 3/4	8.000	3.500	0.840	1.250	N/A	6.00	11.00	11.00
3 x 1			1.050	1.250				
3 x 1-1/4			1.315	1.375				
3 x 1-1/2			1.660	1.375				
3 x 2			1.900	1.437				
3 x 2-1/2	9.000	4.500	2.375	1.500	4.50	6.00	11.00	11.00
4 x 1/2			2.875	1.937				
4 x 3/4			0.840	1.250				
4 x 1			1.050	1.250				
4 x 1-1/4			1.315	1.375				
4 x 1-1/2	11.000	5.563	1.660	1.375	7.50	10.00	18.00	18.00
4 x 2			1.900	1.437				
4 x 2-1/2			2.375	1.500				
4 x 3			2.875	1.937				
5 x 2			3.500	2.000				
5 x 3	12.000	6.625	3.500	2.000	11.50	17.00	N/A	N/A
5 x 4			4.500	2.062				
6 x 1-1/2			1.900	1.437				
6 x 2	12.000	6.625	2.375	1.500	17.00	25.00	N/A	N/A
6 x 3			3.500	2.000				
6 x 4			4.500	2.062				
6 x 5			5.563	2.188				

Swage Nipples - Beveled Both Ends

ASTM A234, MSS SP-95, ASME B16.9

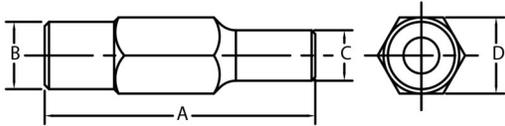
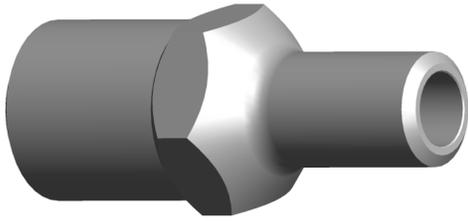

1" NPS and Smaller

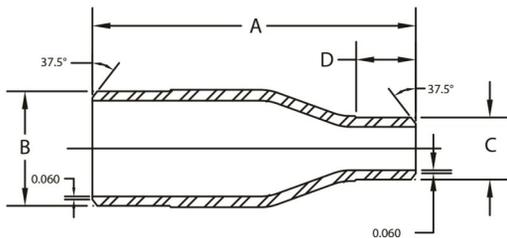

1-1/4" NPS and Larger

Pipe Size	A	B	C	D	Wt. Ea.			
					Std	XH	160	XXH
1/2 X 1/8	2.750	0.840	0.405	0.875	N/A	0.33	0.50	0.50
1/2 X 1/4			0.540					
1/2 X 3/8			0.675					
3/4 X 1/8	3.000	1.050	0.405	1.125	N/A	0.50	0.75	0.75
3/4 X 1/4			0.540					
3/4 X 3/8			0.675					
3/4 X 1/2			0.840					
1 X 1/8	3.500	1.315	0.405	1.375	N/A	0.66	1.00	1.00
1 X 1/4			0.540					
1 X 3/8			0.675					
1 X 1/2			0.840					
1 X 3/4			1.050					
1-1/4 x 1/2	4.000	1.660	0.840	1.250	N/A	1.00	1.50	1.50
1-1/4 x 3/4			1.050					
1-1/4 x 1			1.315					
1-1/2 x 1/2	4.500	1.900	0.840	1.250	N/A	1.16	2.00	2.00
1-1/2 x 3/4			1.050					
1-1/2 x 1			1.315	1.375				
1-1/2 x 1-1/4			1.660					
2 x 1/4			0.540					
2 x 3/8	0.675							
2 x 1/2	6.500	2.375	0.840	1.250	N/A	3.00	4.25	4.25
2 x 3/4			1.050					
2 x 1			1.315	1.375				
2 x 1-1/4			1.660					
2 x 1-1/2			1.900	1.437				
2-1/2 x 2			7.000	2.875				
3 x 3/4	8.000	3.500	1.050	1.250	N/A	6.00	11.00	11.00
3 x 1			1.315	1.375				
3 x 2			2.375	1.500				
3 x 2-1/2			2.875	1.937				
4 x 3/4	9.000	4.500	1.050	1.250	N/A	10.00	18.00	18.00
4 x 1			1.315	1.375				
4 x 2			2.375	1.500				
4 x 2-1/2			2.875	1.937				
4 x 3			3.500	2.000				
5 x 3	11.000	5.563	3.500	2.000	11.50	17.00	N/A	N/A
5 x 4			4.500	2.062				
6 x 2	12.000	6.625	2.375	1.500	17.00	25.00	N/A	N/A
6 x 3			3.500	2.000				
6 x 4			4.500	2.062				
6 x 5			5.563	2.188				

Swage Nipples - Plain Both Ends

ASTM A234, MSS SP-95

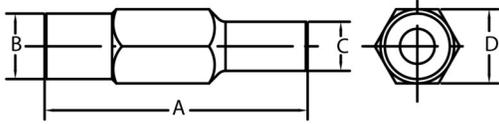
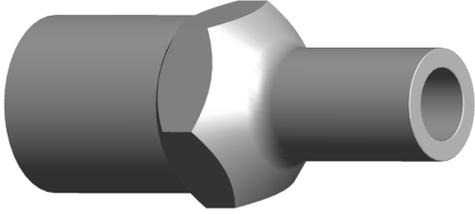

1" NPS and Smaller

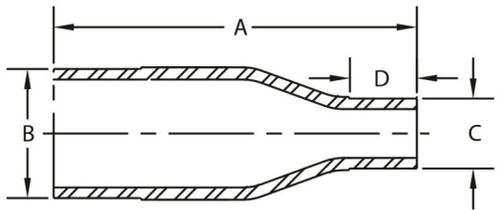

1-1/4" NPS and Larger

Pipe Size	A	B	C	D	Wt. Ea.			
					Std	XH	160	XXH
1/2 X 1/8	2.750	0.840	0.405	0.875	N/A	0.33	0.50	0.50
1/2 X 1/4			0.540					
1/2 X 3/8			0.675					
3/4 X 1/8	3.000	1.050	0.405	1.125	N/A	0.50	0.75	0.75
3/4 X 1/4			0.540					
3/4 X 3/8			0.675					
3/4 X 1/2			0.840					
1 X 1/8	3.500	1.315	0.405	1.375	N/A	0.67	1.00	1.00
1 X 1/4			0.540					
1 X 3/8			0.675					
1 X 1/2			0.840					
1 X 3/4			1.050					
1-1/4 X 1/2	4.000	1.660	0.840	1.250	N/A	1.00	1.50	1.50
1-1/4 X 3/4			1.050					
1-1/4 X 1			1.315					
1-1/2 X 1/2	4.500	1.900	0.840	1.250	N/A	1.16	2.00	2.00
1-1/2 X 3/4			1.050					
1-1/2 X 1			1.315					
1-1/2 X 1-1/4			1.660					
2 X 1/4			6.500					
2 X 3/8	0.675	1.000						
2 X 1/2	0.840	1.250						
2 X 3/4	1.050							
2 X 1	1.315	1.375						
2 X 1-1/4	1.660							
2 X 1-1/2	1.900							
2-1/2 X 2	7.000	2.875	2.375	1.500	3.00	3.50	8.00	8.00
3 X 3/4	8.000	3.500	1.050	1.250	N/A	6.00	11.00	11.00
3 X 1			1.315	1.375				
3 X 1-1/2			1.900	1.437				
3 X 2			2.375	1.500				
3 X 2-1/2			2.875	1.937				
4 X 3/4	9.000	4.500	1.050	1.250	N/A	10.00	18.00	18.00
4 X 1			1.315	1.375				
4 X 2			2.375	1.500				
4 X 2-1/2			2.875	1.937				
4 X 3			3.500	2.000				
5 X 3	11.000	5.563	3.500	2.000	11.00	17.00	N/A	N/A
5 X 4			4.500	2.062				
6 X 2	12.000	6.625	2.375	1.500	17.00	25.00	N/A	N/A
6 X 3			3.500	2.000				
6 X 4			4.500	2.062				
6 X 5			5.563	2.188				

Swage Nipples - Eccentric TBE, BBE, PBE

ASTM A234, MSS SP-95, ASME B1.20.1, ANSI B16.25

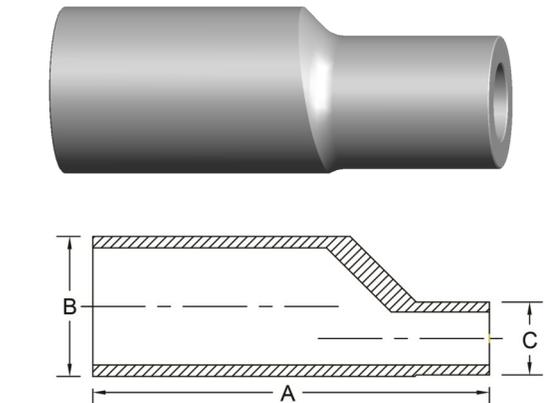
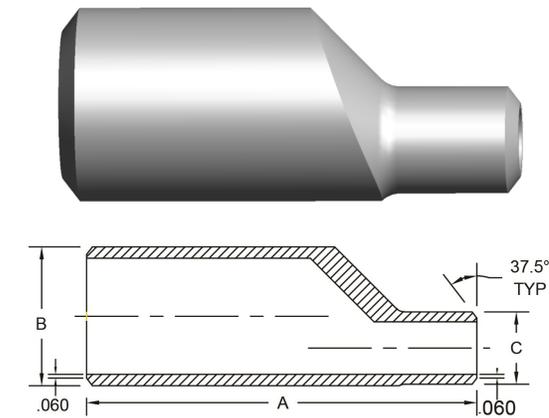
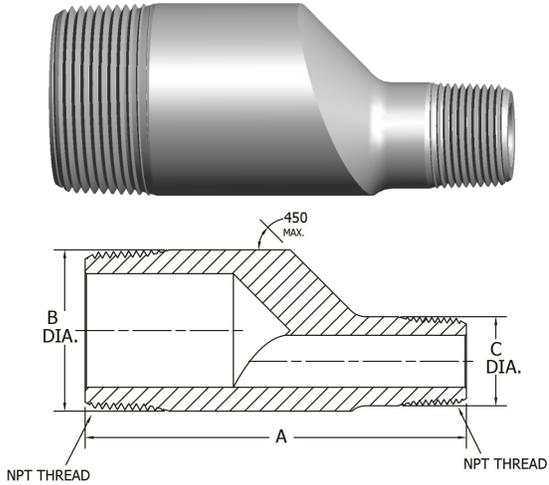

Pipe Size	A	B	C	Wt. Ea.			
				Std	XH	160	XXH
3/8 x 1/8	2.500	0.675	0.405	N/A	0.25	0.38	0.38
3/8 x 1/4			0.540				
1/2 x 1/4	2.750	0.840	0.540	N/A	0.33	0.50	0.50
1/2 x 3/8			0.675				
3/4 x 1/4	3.000	1.050	0.540	N/A	0.50	0.75	0.75
3/4 x 3/8			0.675				
3/4 x 1/2			0.840				
1 x 1/4	3.500	1.315	0.540	N/A	0.67	1.00	1.00
1 x 3/8			0.675				
1 x 1/2			0.840				
1 x 3/4			1.050				
1-1/4 x 1/2	4.000	1.660	0.840	N/A	1.00	1.50	1.50
1-1/4 x 3/4			1.050				
1-1/4 x 1			1.315				
1-1/2 x 1/2	4.500	1.900	0.840	N/A	1.16	2.00	2.00
1-1/2 x 3/4			1.050				
1-1/2 x 1			1.315				
1-1/2 x 1-1/4			1.660				
2 x 1/4	6.500	2.375	0.540	N/A	3.00	4.25	4.25
2 x 3/8			0.675				
2 x 1/2			0.840				
2 x 3/4			1.050	2.00			
2 x 1			1.315				
2 x 1-1/4			1.660				
2 x 1-1/2			1.900				
2-1/2 x 1	7.000	2.875	1.315	3.00	3.50	8.00	8.00
2-1/2 x 1-1/4			1.660				
2-1/2 x 1-1/2			1.900				
2-1/2 x 2			2.375				
3 x 1/2	8.000	3.500	0.840	4.50	6.00	11.00	11.00
3 x 3/4			1.050				
3 x 1			1.315				
3 x 1-1/4			1.660				
3 x 1-1/2			1.900				
3 x 2			2.375				
3 x 2-1/2	2.875						
4 x 1	9.000	4.500	1.315	7.50	10.00	18.00	18.00
4 x 1-1/4			1.660				
4 x 1-1/2			1.900				
4 x 2			2.375				
4 x 2-1/2			2.875				
4 x 3			3.500				

Combination of End Styles are also available

Bull Plugs

ASTM A234, MSS SP-95, ASME B1.20.1

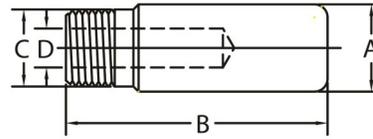

Round, Threaded

Pipe Size	A	B	C	D				Wt. Ea.			
				STD	XH	160	XXH	STD	XH	160	XXH
1/8	0.437	2.000	0.405	0.250	0.218	-	-	-	-	-	-
1/4	0.562	2.000	0.540	0.343	0.281	-	-	-	-	-	-
3/8	0.750	2.250	0.675	0.468	0.406	-	-	-	-	-	-
1/2	0.875	2.500	0.840	0.609	0.531	-	-	-	-	-	-
3/4	1.062	2.750	-	0.812	0.718	0.609	0.421	-	-	-	-
1	1.312	3.000	-	1.031	0.937	0.781	0.593	-	-	-	-
1-1/4	1.687	3.250	-	1.343	1.250	1.140	0.875	-	1.00	1.50	1.50
1-1/2	2.000	3.500	1.900	1.593	1.484	1.312	1.062	-	1.17	2.00	2.00
2	2.375	4.000	-	2.000	1.937	1.671	1.484	2.25	2.50	3.50	3.50

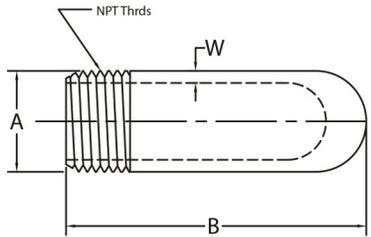

Hollow, Threaded

Pipe Size	A	B	C	W				Wt. Ea.			
				STD	XH	160	XXH	STD	XH	160	XXH
2	2.375	4.000	-	0.154	0.218	0.344	0.436	2.25	2.50	3.50	3.50
2-1/2	2.875	5.000	-	0.203	0.276	0.375	0.552	3.00	3.50	-	8.00
3	3.500	6.000	-	0.216	0.300	0.438	0.600	4.50	6.00	-	11.00
4	4.500	7.000	-	0.237	0.337	0.531	0.674	7.50	10.00	-	18.00

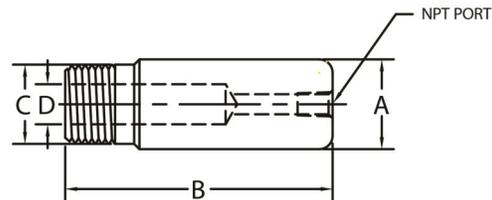

Hollow, Threaded, Tapped

Pipe Size	A	B	C	D			Wt. Ea.		
				STD	XH	XXH	STD	XH	XXH
1	1.312	3.000	1.312	1.031	0.937	0.593	-	0.67	1.00
1-1/4	1.687	3.250	1.660	1.343	1.250	0.875	-	1.00	1.50
1-1/2	2.000	3.500	1.900	1.593	1.484	1.062	-	1.17	2.00
2	2.375	4.000	2.375	2.000	1.937	1.484	2.25	2.50	5.00

Note: NPT Ports Available in 1/4" or 1/2" Sizes
Electro-Zinc Plated

Bull Plugs

ASTM A234, MSS SP-95, ASME B1.20.1

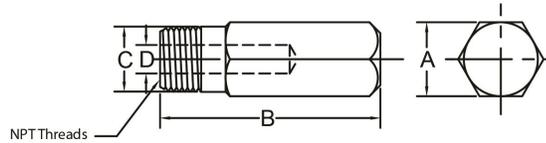

Hex, Threaded

Pipe Size	A	B	C	D			Wt. Ea.		
				XH	160	XXH	XH	160	XXH
1/4	0.625	2.000	0.540	0.581	0.218	0.156	0.11	0.40	0.40
3/8	0.750	2.250	0.675	0.406	0.328	0.218	0.14	-	-
1/2	0.875	2.500	0.840	0.531	0.437	0.250	0.33	0.50	0.50
3/4	1.125	2.750	1.050	0.718	0.609	0.421	0.50	0.75	0.75
1	1.375	3.000	1.315	0.937	0.781	0.593	0.67	1.00	1.00

Electro-Zinc Plated

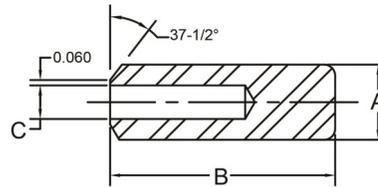

Hollow, Welding Bevel

ASTM A234, MSS SP-95, ASME B16.25

Pipe Size	A	B	C				Wt. Ea.			
			STD	XH	160	XXH	STD	XH	160	XXH
1	1.312	3.000	1.031	0.937	0.781	0.578	-	0.67	1.38	1.00
1-1/4	1.688	3.250	1.343	1.250	1.140	0.875	-	1.00	2.25	1.50
1-1/2	2.000	3.500	1.593	1.484	1.312	1.062	-	1.17	2.00	2.00
2	2.375	4.000	2.000	1.937	1.671	1.484	2.25	2.74	3.50	3.50

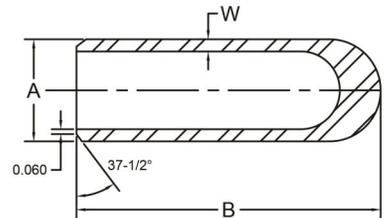

Hollow, Welding Bevel

ASTM A234, MSS SP-95, ASME B16.25

Pipe Size	A	B	W				Wt. Ea.			
			STD	XH	160	XXH	STD	XH	160	XXH
2-1/2	2.875	5.000	0.203	0.276	0.375	0.552	3.00	3.50	-	8.00
3	3.500	6.000	0.216	0.300	0.438	0.600	4.50	6.00	-	11.00
4	4.500	7.000	0.237	0.337	0.531	0.674	7.50	10.00	-	18.00

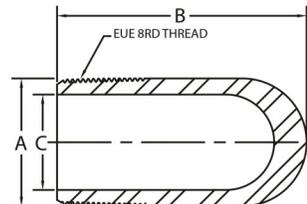

Hollow, API 8 Round Threads

API 5B, API J55 or N80, API EUE 8RD

Pipe Size	A	B	C			Wt. Ea.		
			STD	XH	XXH	STD	XH	XXH
2	2.594	5.000	1.995	1.875	1.500	3.50	4.00	9.00
2-1/2	3.093	5.500	2.441	2.312	1.750	4.25	6.00	14.00
3	3.750	6.500	2.992	2.875	2.250	10.00	15.00	25.00
3-1/2	4.250	7.000	3.476	3.375	2.750	-	-	-

Electro-Zinc Plated

Standard Pressure Fittings

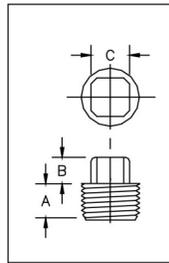

Pipe Plugs, Standard Pressure, Square Head

Pipe Size	1/8	1/4	3/8	1/2	3/4
A	0.375	0.500	0.500	0.688	0.688
B	0.250	0.281	0.312	0.375	0.437
C	0.281	0.375	0.437	0.562	0.625
Wt. Ea.	0.02	0.04	0.06	0.12	0.19

Available in black phosphate coatings or electro-zinc plated
SAE J531, ASME B1.20.3, AISI C1008-C1010

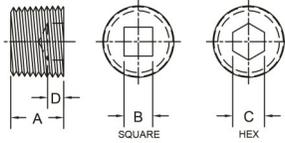

Pipe Plugs, Standard Pressure, Square & Hex Counter Sunk

Pipe Size	1/8	1/4	3/8	1/2	3/4	1	1-1/4	1-1/2	2
A	0.312	0.469	0.469	0.625	0.812	0.781	0.812	0.844	0.891
B	0.188	0.250	0.328	0.359	0.500	0.500	0.750	0.750	0.875
C	0.188	0.250	0.312	0.375	0.562	0.625	0.750	1.000	1.000
D	0.125	0.188	0.188	0.250	0.312	0.375	0.422	0.406	0.406
Wt. Ea.	0.01	0.02	0.03	0.06	0.10	0.20	0.33	0.46	0.88

Available in black phosphate coatings or electro-zinc plated

Dimensions 1/8" through 1" conforms to SAE J531

Dimensions 1-1/4" through 2" conforms to ASME B16.14

Material: 1/8" - 1 1/4" AISI C1008-C1010

1 1/2" - 2" AISI C12L14

NPTF threads specified in ASME B1.20.3

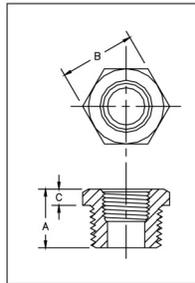

Hex Bushings, Standard Pressure

Pipe Size	1/4	3/8	1/2	3/4	1
A	0.640	0.700	0.880	0.970	1.190
B	0.620	0.690	0.880	1.060	1.380
C	0.140	0.190	0.190	0.220	0.310
Wt. Ea.	0.02	0.05	0.11	0.21	0.36

ASME B16.14, ASME B1.20.1, AISI C1010

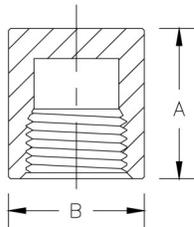

Pipe Caps, Standard Pressure, Threaded

Pipe Size	1/8	1/4	3/8	1/2	3/4	1
A	0.500	0.750	0.750	0.938	1.062	1.188
B	0.625	0.719	0.875	1.032	1.312	1.562
Wt. Ea.	0.02	0.04	0.06	0.12	0.20	0.31

ASME B16.14, ASME B1.20.1

Adapters

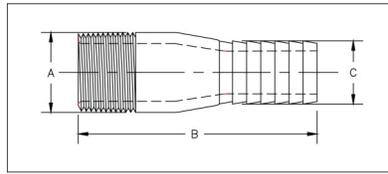

Serrated Male Adapters for Plastic Pipe

ASTM A53 Galvanized Pipe or ASTM B43 Red Brass

Pipe Size	1/2	3/4	1	1-1/4	1-1/2	2	2-1/2	3	4
Part No. (Galvanized Pipe)	M-10	M-20	M-30	M-40	M-50	M-60	M-70	M-80	M-90
Part No. (Red Brass)	BM-10	BM-20	BM-30	BM-40	BM-50	BM-60	BM-70	BM-80	BM-90
A	0.840	1.050	1.315	1.660	1.900	2.375	2.875	3.500	4.500
B	3.125	3.375	3.500	3.500	4.250	4.250	5.375	5.875	7.000
C	0.645	0.845	1.075	1.405	1.640	2.095	2.505	3.100	4.060
Wt. Ea.	0.14	0.23	0.34	0.50	0.64	0.90	2.00	2.50	4.50

Serrated dimensions per ASTM D.2609
NPT Threads per ASME B1.20.1

Use with Schedule 40 Plastic Pipe
Plastic Pipe must be secured to Adapter with One or Two Worm Type Hose Clamps
Pressure Rating equals that of Plastic Pipe

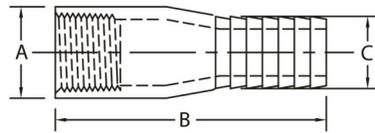

Serrated Female Adapters for Plastic Pipe

ASTM A53 Galvanized Pipe or ASTM B43 Red Brass

Pipe Size	1/2	3/4	1	1-1/4	1-1/2	2
Part No. (Galvanized Pipe)	F-10	F-20	F-30	F-40	F-50	F-60
Part No. (Red Brass)	BF-10	BF-20	BF-30	BF-40	BF-50	BF-60
A	0.921	1.132	1.380	1.753	2.000	2.485
B	3.406	3.625	3.781	3.906	4.437	4.531
C	0.645	0.845	1.075	1.405	1.640	2.095
Wt. Ea.	0.20	0.25	0.33	0.50	0.65	0.93

Serrated dimensions per ASTM D.2609
NPT Threads per ASME B1.20.1

Use with Schedule 40 Plastic Pipe
Plastic Pipe must be secured to Adapter with One or Two Worm Type Hose Clamps
Pressure Rating equals that of Plastic Pipe

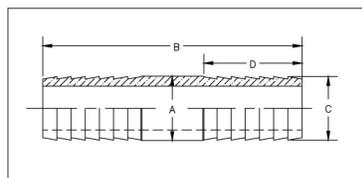

Serrated Insert Couplings for Plastic Pipe

ASTM A53 Galvanized Pipe or ASTM B43 Red Brass

Pipe Size	1/2	3/4	1	1-1/4	1-1/2	2	2-1/2	3
Part No. (Galvanized Pipe)	C-10	C-20	C-30	C-40	C-50	C-60	C-70	C-80
Part No. (Red Brass)	BC-10	BC-20	BC-30	BC-40	BC-50	BC-60	BC-70	BC-80
A	0.675	0.840	1.075	1.525	1.660	2.162	2.505	3.100
B	3.375	3.375	3.625	3.625	3.750	3.750	5.500	6.000
C	0.645	0.845	1.075	1.405	1.640	2.095	2.505	3.100
D	1.281	1.281	1.281	1.281	1.281	1.281	2.250	2.750
Approx Weight Steel	0.10	0.18	0.38	0.36	0.60	1.21	1.50	2.50
Approx Weight Brass	0.09	0.19	0.30	0.46	0.62	1.07	-	2.50

Serrated dimensions per ASTM D.2609

Adapters

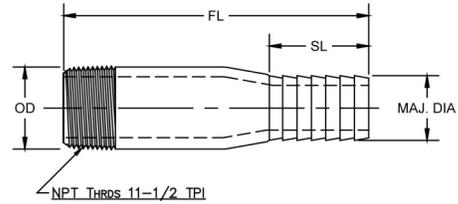

ASTM A53 Galvanized Pipe or ASTM B43 Red Brass

Serrated Dimensions per ASTM D.2609

NPT Pipe Threads per ASME B1.20.1

Serrated Adapters Male Venturi

Pipe Size	Part No. (Galv Steel)	Part No. (Red Brass)	OD	FL	SL	Maj. Dia.
1 x 6	MV-36	BMV-36	1.315	6	1-9/32	1.075
1 x 8	MV-38	BMV-38		8		
1 x 10	MV-310	BMV-310		10		
1 x 12	MV-312	BMV-312		12		
1-1/4 x 6	MV-46	BMV-46	1.660	6	1-9/32	1.405
1-1/4 x 8	MV-48	BMV-48		8		
1-1/4 x 10	MV-410	BMV-410		10		
1-1/4 x 12	MV-412	BMV-412		12		
1-1/2 x 6	MV-56	BMV-56	1.900	6	1-11/16	1.640
1-1/2 x 8	MV-58	BMV-58		8		
1-1/2 x 10	MV-510	BMV-510		10		
1-1/2 x 12	MV-512	BMV-512		12		

Use with Schedule 40 Plastic Pipe

Plastic Pipe must be secured to Adapter with One or Two Worm Type Hose Clamps

Pressure Rating equals that of Plastic Pipe

Adapters

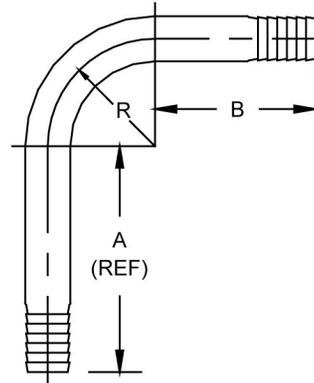

ASTM A53 Galvanized Pipe, ASTM B43 Red Brass
Serrated Dimensions per ASTM D.2609

Serrated Adapters, Well Seal Elbows (Both Ends Serrated)

Pipe Size	Part No. (Galv. Steel)	Dim A Ref	Dim B	R
3/4	W-20	5-1/4	3-3/4	2-1/2
1	W-30			3
1-1/4	W-40			4-7/8
1-1/2	W-50			4-7/8

Pipe Size	Part No. (Red Brass)	Dim A Ref	Dim B	R
1	BW-30	5-1/4	3-3/4	2-1/4
1-1/4	BW-40			3-7/8
1-1/2	BW-50			3-7/8

Use with Schedule 40 Plastic Pipe

Plastic Pipe must be secured to Adapter with One or Two Worm Type Hose Clamps

Pressure Rating equals that of Plastic Pipe

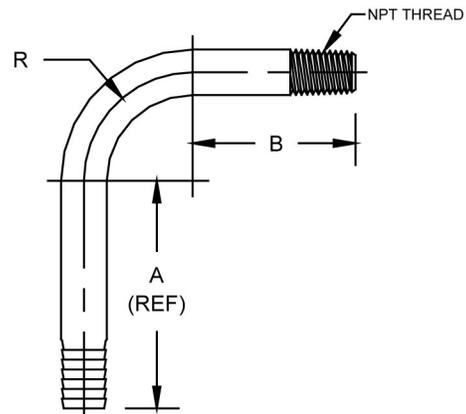

ASTM A53 Galvanized Pipe, ASTM B43 Red Brass
Serrated Dimensions per ASTM D.2609
NPT Pipe Threads per ASME B1.20.1

Serrated Adapters, Well Seal Elbows (Serrated x NPT)

Pipe Size	Part No. (Galv. Steel)	Dim A Ref	Dim B	R
3/4	-	5-1/4	3-3/4	2-1/2
1	-			3
1-1/4	-			4-7/8
1-1/2	-			4-7/8

Pipe Size	Part No. (Red Brass)	Dim A Ref	Dim B	R
1	-	5-1/4	3-3/4	2-1/4
1-1/4	-			3-7/8
1-1/2	-			3-7/8

Use with Schedule 40 Plastic Pipe

Plastic Pipe must be secured to Adapter with One or Two Worm Type Hose Clamps

Pressure Rating equals that of Plastic Pipe

Siphons

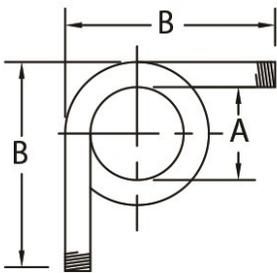
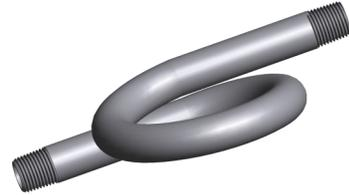
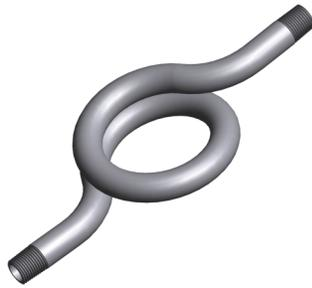

ANGLE

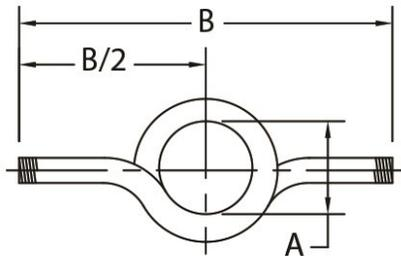

PIGTAIL

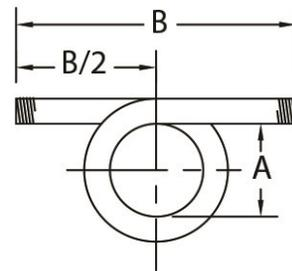

STRAIGHT

SIPHON - ANGLE

SIZE	1/4	1/2
A	2	3
B	4-1/2	6-1/4

SIPHON - PIGTAIL

SIZE	1/4	1/2
A	2	3
B	8	10-3/4

SIPHON - STRAIGHT

SIZE	1/4	1/2
A	2	3
B	6	8

Available in Standard and XH Schedules

ASTM A53 Type F Butt Welded

ASTM A106 Grade B Seamless

ASTM B43 Red Brass

ASTM A312 Grade 304/L Welded or Seamless

ASTM A312 Grade 316/L Welded or Seamless