



Quality Tools for Smart Cleaning™



# PRODUCT CATALOG



### HYDROPOWER<sup>®</sup> ULTRA

PAGES 6-9

HydroPower Ultra professional window cleaning system is the fastest, safest, and most efficient way to clean outdoor glass surfaces, leaving a spot-free finish. HydroPower Ultra sets the new standard in deionizing technology for pure water cleaning.



### nLITE<sup>®</sup>

PAGES 11-15

UNGER's Generation 2 nLITE Waterfed Pole System exemplifies innovation and high quality. Discover the best and most advanced telescopic pole system today.



### STINGRAY

*The Ultimate Indoor Cleaning Tool*



PAGES 36-37

The award-winning Unger Stingray Indoor Cleaning Tool quickly cleans your indoor glass drip-free and easily reaches high access areas without the need for ladders. Its unique design cleans windows up to 25% faster with either easy gliding microfiber or absorbent QuikPad™ disposable pads.



### RESTROOM<sub>x</sub>

*A HIGHER LEVEL OF CLEAN*

PAGES 42-45

The Restroom<sub>x</sub> Cart System is the first cleaning system designed by custodians to help them work safer, faster and better than ever before. Comprised of three parts, an innovative restroom cart, advanced floor care tools and best in class cleaning accessories, the Restroom<sub>x</sub> Cart System supports the entire process and improves productivity while delivering the highest level of clean.



### OmniClean



PAGES 48-50

Unger OmniClean is the newest, groundbreaking innovation in floor cleaning. For the first time in history, you can truly clean your floors with a mop and bucket! Ditch that old mop and dirty water and start truly cleaning with Unger OmniClean.



### Unger Excella™

*Clean floors twice as fast*



PAGES 51-53

Unger Excella is ready for immediate use. With its ability to provide quick spot cleaning around tables and quick drying capability, Unger Excella Floor Cleaning is the fastest floor cleaning method.



# INDEX SECTIONS

## WINDOW CLEANING



Page **4**

Pure Water Cleaning Tools  
Squeegees, T-Bars and Sleeves  
Scrapers and Accessories  
Pro Window Kits  
Chemicals, Cloths and Buckets

## HIGH ACCESS & DUSTING CLEANING



Page **26**

Brushes & Microfiber Dusting Tools  
Bulb Changing and Adapter Tools  
Telescopic Poles

## SURFACE CLEANING



Page **34**

MicroWipe  
Desk and Table Cleaning Kit  
Stingray®  
SpeedClean™

## RESTROOM CLEANING



Page **40**

RestroomRx™  
Restroom Kits & Accessories

## FLOOR CARE



Page **46**

OmniClean  
Unger Excella  
SmartColor™ Cleaning System  
Floor Mops, Scrapers and Squeegees  
Handles  
Tool Holders

## LITTER REMOVAL



Page **66**

NiftyNabber Tools  
People's Paper Picker Pin  
Neoprene Gloves



# WINDOW CLEANING

At Unger, the window cleaning industry is both where the company started and where we continue to be a world leader. Starting with founder Henry Unger's desire to create a better squeegee, Unger has built a reputation of creating the highest quality, most innovative tools available.

Products such as the HydroPower Ultra and the Generation 2 nLITE demonstrate that today, and moving forward, quality and innovation remain core values of Unger.

## FEATURED PRODUCT



### nLITE Carbon 24K – 39'/12 m Kit

PART NO.: NLKT3 CASE QTY.: 1

- CF86G nLITE® Carbon 24K Main Pole, 6 Sections – 28'/8.5 m
- CF33G nLITE® Carbon 24K Ext. Pole, 2 Sections – 10.5' /3.2 m
- NLHCC Extension Adapter
- NGS15 Angle Adapter S – 6"/15 cm
- NFK28 Power Brush Complete – 11"/28 cm
- DLS25 DuroFlex Hose – 82'/25 m
- NLWVI Water Flow Regulator
- NLBAG nLITE® Carrying Bag

.....

**Keep workers safe on the ground while cleaning windows up to four floors high!**



Scan here for more information.



# Pure Water Cleaning

## What is pure water?

**Pure water** is water that has been treated and any dissolved, solid particles have been removed from it. With pure water, there is no need to wipe or polish the glass, the water dries streak free leaving your windows spotless.

**Pure water** cleaning is not just eliminating the need for lifts and ladders making it safer, it eliminates the need for detergents, making it environmentally safe as well.

**The Unger HydroPower** systems are designed to be the perfect fit for professional cleaners. They are engineered to be portable, easy to operate, and extremely efficient.

**HYDRO POWER<sup>®</sup> RO SYSTEM**



**HYDRO POWER<sup>®</sup> ULTRA**



## Reverse Osmosis (RO)

Reverse osmosis is the process of removing impurities (technically, ions) from water by forcing it through a filter (referred to as a membrane).

## Deionization (DI)

Deionization is the process of removing positive metallic ions (impurities) and replacing them with hydrogen and hydroxyl, respectively forming pure water. This process removes up to 99% of all the sediment and minerals which creates impurity-free water.

# Unger Pure Water Cleaning System



**The Advantages of Water Fed Poles**  
**Clean & Efficient + Cost Savings**  
**Environmentally Friendly + Safety**

**BOOST MODE!**



Cleaning with pure water can be achieved at minimal running cost – especially in hard water areas. The RO pressurizes water through a 3-stage filtration process, resulting in water with a particularly high cleaning efficiency that will leave surfaces without streaks. Featuring a boost function, you can remove dirt and debris that cannot be removed with a brush.

**HIGH QUALITY 3-STAGE FILTRATION**

**POWERFUL HIGH-VALUE PUMP**

**COMPACT AND ROBUST DESIGN**

**EASY TDS METER**

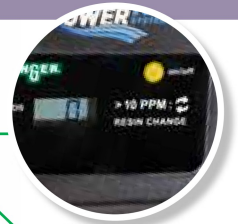

**EASY TO TRANSPORT AND MAINTAIN**



### HydroPower RO

PART NO.: R020S CASE QTY.: 1

- Compact design
- Water output up to 39 gal./h (150 l/h) in pure water mode
- Maximum operating pressure 145 PSI
- TDS sensor with water flow meter
- 15' / 4.6m power cable length
- Pump dry run protection



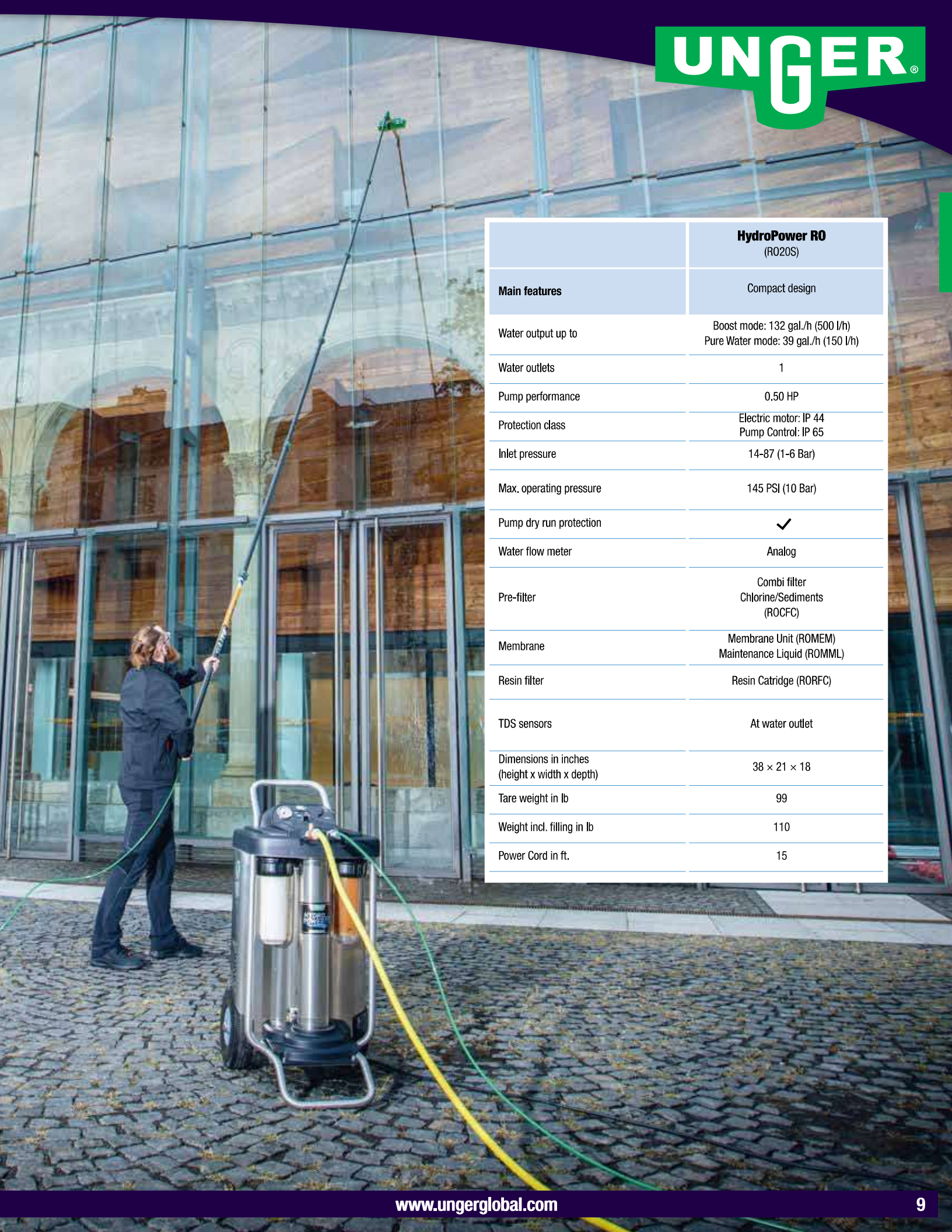

	<b>HydroPower RO (R020S)</b>
<b>Main features</b>	Compact design
Water output up to	Boost mode: 132 gal./h (500 l/h) Pure Water mode: 39 gal./h (150 l/h)
Water outlets	1
Pump performance	0.50 HP
Protection class	Electric motor: IP 44 Pump Control: IP 65
Inlet pressure	14-87 (1-6 Bar)
Max. operating pressure	145 PSI (10 Bar)
Pump dry run protection	✓
Water flow meter	Analog
Pre-filter	Combi filter Chlorine/Sediments (ROCF)
Membrane	Membrane Unit (ROMEM) Maintenance Liquid (ROMML)
Resin filter	Resin Cartridge (RORFC)
TDS sensors	At water outlet
Dimensions in inches (height x width x depth)	38 × 21 × 18
Tare weight in lb	99
Weight incl. filling in lb	110
Power Cord in ft.	15

Designed to be the perfect fit for professional window cleaners that demand the best for their window washing services. With over 30% more pure water per resin filling, the FloWater Technology 2.0 ensures an efficient flow of water through the whole tank, optimizing the resin saturation.



**HydroPower Ultra Large Tank with Cart**

PART NO.: **UHP3C** CASE QTY.: **1**

- Large Tank Unit (Includes 3 resin packs)



**HydroPower Ultra Large Tank**

PART NO.: **UHP03** CASE QTY.: **1**

- Large Tank Unit (Includes 3 resin packs)



**HydroPower Ultra Small Tank**

PART NO.: **UHP01** CASE QTY.: **1**

- Small Tank Unit (Includes 1 resin pack)

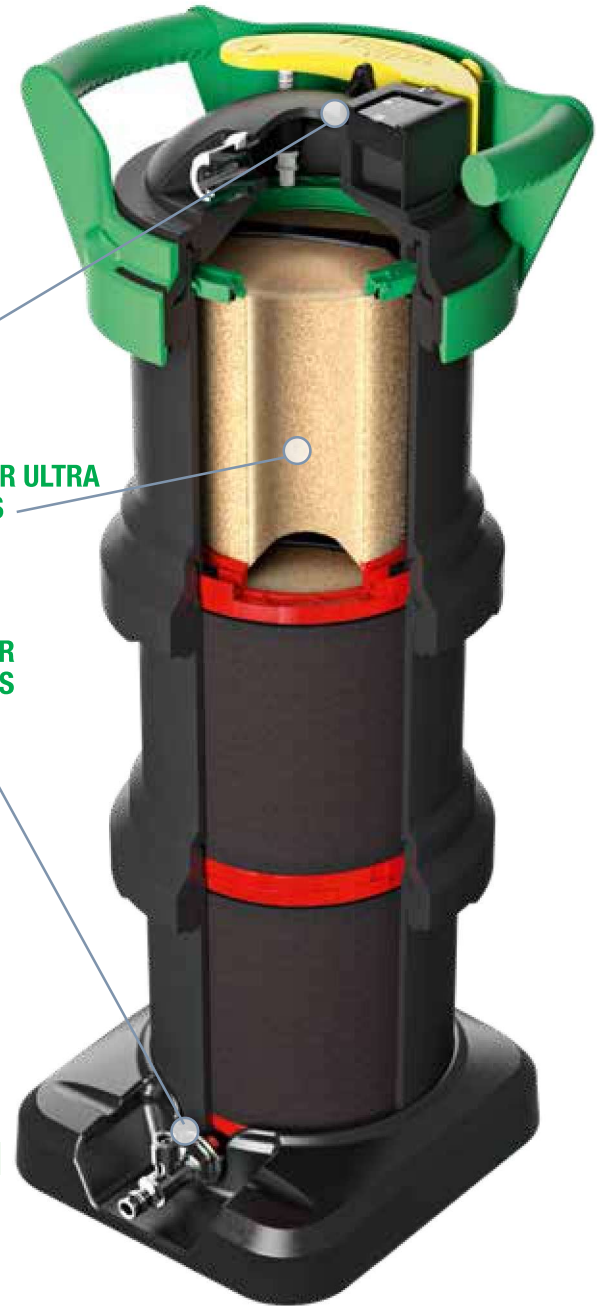

DIGITAL TDS METER

HYDROPOWER ULTRA RESIN PACKS

METAL WATER CONNECTIONS

## HYDROPOWER ULTRA RESIN PACKS



**HydroPower Ultra Small Tank Resin**

PART NO.: **UHPR1** CASE QTY.: **1**

- 1 Green Resin Pack  
For use with UHP01



**HydroPower Ultra Small Tank Resin (3)**

PART NO.: **UHPR2** CASE QTY.: **1**

- 3 Green Resin Packs  
For use with UHP01



**HydroPower Ultra Large Tank Resin (3)**

PART NO.: **UHPR3** CASE QTY.: **1**

- 1 Green Resin Pack  
• 2 Red Resin Packs  
For use with UHP03 and UHP3C

Carbon 24K Main/Extension Poles (CF86G, CF33G) reach heights up to 52.5'. Up to 2 Extensions can be added to the Main Pole.  
Telescopic Poles (CF60T, CC85T, CC60T, CC32T) can extend up to 28' depending on pole size chosen. Extension Poles cannot be added to Telescopic Poles.

## Generation 2 nLITE CARBON COMPOSITE



**32.5 FEET (10m)**

WORKING HEIGHT

### Composite Telescopic Pole

PART NO.: **CC85T** SECTIONS.: **6** CASE QTY.: **1**

- Extended Height: 28' / 8.5m  
Collapsed Height: 5.5' / 1.7m
- Weight: 4.9lb / 2.2kg

**24.5 FEET (7.5m)**

WORKING HEIGHT

### Composite Telescopic Pole

PART NO.: **CC60T** SECTIONS.: **4** CASE QTY.: **1**

- Extended Height: 20' / 6m  
Collapsed Height: 5.5' / 1.7m
- Weight: 3.0lb / 1.4kg

**10.5 FEET (3.2m)**

WORKING HEIGHT

### Composite Telescopic Pole

PART NO.: **CC32T** SECTIONS.: **2** CASE QTY.: **1**

- Extended Height: 10.5' / 3.2m  
Collapsed Height: 5.5' / 1.7m
- Weight: 1.5lb / 0.7kg

**Strength of Material: 100 GPa\***

High quality mix of carbon and glass fibers.

*Excellent rigidity and value.*

## Generation 2 nLITE CARBON 24K



**24.5 FEET (7.5m)**

WORKING HEIGHT

### Carbon 24K Telescopic Pole

PART NO.: **CF60T** SECTIONS.: **4** CASE QTY.: **1**

- Extended Height: 20' / 6m  
Collapsed Height: 5.5' / 1.7m
- Weight: 2.5lb / 1.16kg

**52.5 FEET (16m)**

WORKING HEIGHT  
(1x Main Pole, 2x Ext. Poles)

### Carbon 24K Main Pole

PART NO.: **CF86G** SECTIONS.: **6** CASE QTY.: **1**

- Extended Height: 28' / 8.5m  
Collapsed Height: 5.5' / 1.7m
- Weight: 4.0lb / 1.84kg
- Up to 2 Extension Poles (CF33G) can be added

### Carbon 24K Extension Pole

PART NO.: **CF33G** SECTIONS.: **2** CASE QTY.: **1**

- Extended Height: 10.5' / 3.2m  
Collapsed Height: 6' / 1.8m
- Weight: 1.8lb / 0.82kg
- For use with CF86G Main Pole

**Strength of Material: 210 GPa\***

Premium carbon fibers in a unique weave of 24,000 fibers per bundle.

*Superior rigidity, lightweight pole.*

## Generation 1 nLite HiMODULUS CARBON

HiMOD Master/Extension Poles reach heights up to 65'.

*The ultimate in rigidity, ultra-light pole.*

**Strength of Material: 180 GPa\***



**65 FEET (20m)**

WORKING HEIGHT

### HiModulus Master Pole

PART NO.: **UC67G** SECTIONS.: **4** CASE QTY.: **1**

- Extended Height: 22' / 6.71m  
Collapsed Height: 6' / 1.8m
- Weight: 3.3lb / 1.5kg

### HiModulus Extension Pole

PART NO.: **UC35G** SECTIONS.: **2** CASE QTY.: **1**

- Extended Height: 11' / 3.4m  
Collapsed Height: 6.25' / 1.9m
- Weight: 1.5lb / 0.7kg

## Generation 1 nLite ALUMINUM

ALU Master/Extension Poles reach heights up to 30'.

*Great quality and value for lower heights.*

**Strength of Material: 30 GPa\***



**32.5 FEET (10m)**

WORKING HEIGHT

### HiFlo Master ALU Pole

PART NO.: **AN60G** SECTIONS.: **4** CASE QTY.: **1**

- Extended Height: 20' / 6.1m  
Collapsed Height: 5.6' / 1.7m
- Weight: 4.4lb / 2.0kg

### HiFlo Extension ALU Pole

PART NO.: **AN30G** SECTIONS.: **2** CASE QTY.: **1**

- Extended Height: 10' / 3.1m  
Collapsed Height: 5.5' / 1.5m
- Weight: 2.4lb / 1.1kg



# 55'

### HydroPower Ultra Professional 55'/17 m Kit

PART NO.: UHPK4 CASE QTY.: 1 Gen 1

- UHP3C HydroPower Ultra Large Tank with Cart (3 resin packs)
- UC67G HiFlo nLite HiMod Carbon Master Pole, 4 Sections – 22'/7 m
- UC35G (3) HiFlo nLite HiMod Carbon Extension Pole, 2 Sections – 11'/3.4 m
- NLG20 HiFlo nLite MultiLink Gooseneck – 8"/20 cm
- TMOOV HiFlo Control
- NUK28 Power Brush Complete – 11"/28 cm
- NLQUI Hose Connection Kit
- NL25G HiFlo nLite Hose – 82'/25 m
- NLBA1 HiFlo nLite Carrying Bag



# 39'

### HydroPower Ultra Large Carbon 39'/12 m Kit

PART NO.: UNLK5 CASE QTY.: 1

- UHP3C HydroPower Ultra Large Tank with Cart (3 resin packs)
- CF86G nLITE Carbon 24K Main Pole, 6 Sections – 28'/8.5 m
- CF33G nLITE Carbon 24K Ext. Pole, 2 Sections – 10.5'/3.2 m
- NLHCC Extension Adapter
- NGS15 Angle Adapter S – 6"/15 cm
- NFK28 Power Brush Complete – 11"/28 cm
- DLS25 DuroFlex Hose – 82'/25 m
- NLWVI Water Flow Regulator
- NLBAG nLITE Carrying Bag



# 39'

### HydroPower Ultra – Advanced Kit 39'/12 m

PART NO.: UNLK2 CASE QTY.: 1

- UHP01 HydroPower Ultra Small Tank (1 resin pack)
- CF86G nLITE Carbon 24K Main Pole, 6 Sections – 28'/8.5 m
- CF33G nLITE Carbon 24K Ext. Pole, 2 Sections – 10.5'/3.2 m
- NLHCC Extension Adapter
- NGS15 Angle Adapter S – 6"/15 cm
- NFK28 Power Brush Complete – 11"/28 cm
- DLS25 DuroFlex Hose – 82'/25 m
- NLWVI Water Flow Regulator
- NLBAG nLITE Carrying Bag



# 20'

### HydroPower Ultra – Entry Kit 20'/6 m

PART NO.: UNLK1 CASE QTY.: 1

- UHP01 HydroPower Ultra Small Tank (1 resin pack)
- CC60T nLITE Carbon Composite Telescopic Pole, 4 Sections – 20'/6 m
- NGS15 Angle Adapter S – 6"/15 cm
- NFF28 Power Brush - 11"/28 cm
- DLS25 DuroFlex Hose – 82'/25 m



# 20'

### HydroPower Ultra – Entry Kit 20'/6 m

PART NO.: UHPK1 CASE QTY.: 1 Gen 1

- UHP01 HydroPower Ultra Small Tank (1 resin pack)
- AN60G HiFlo nLITE ALU Master Pole, 4 Sections – 20'/6 m
- FTGOS MultiLink Adapter
- NFK28 nLITE Power Brush Complete, flagged - 11"/28 cm
- NL11G HiFlo nLite Hose - 36'/11 m

## nLITE KITS



### nLITE Carbon 24K – 39'/12 m Kit

PART NO.: **NLKT3** CASE QTY.: **1**

- CF86G nLITE Carbon 24K Main Pole, 6 Sections – 28'/8.5 m
- CF33G nLITE Carbon 24K Ext. Pole, 2 Sections – 10.5'/27 cm
- NLHCC Extension Adapter
- NGS15 Angle Adapter S – 6"/15 cm
- NFK28 Power Brush Complete – 11"/28 cm
- DLS25 DuroFlex Hose – 82'/25 m
- NLWVI Water Flow Regulator
- NLBAG nLITE Carrying Bag



### nLite HiMod – 55'/17m Kit

PART NO.: **NLKU3** CASE QTY.: **1** Gen 1

- UC67G HiFlo nLITE HiMod Carbon Master Pole, 4 Sections – 22'/7 m
- UC35G (3) HiFlo nLITE HiMod Carbon Extension Pole, 2 Sections – 11'/3.4 m
- NLG20 HiFlo nLite MultiLink Gooseneck – 8'/20 cm
- TM00V HiFlo Control
- NLBJF HiFlo nLite Fan Jets, Set of 2
- NUK28 Power Brush Complete – 11"/28 m
- NL25G HiFlo nLite Hose – 82'/25 m
- NLBA1 HiFlo nLITE Carrying Bag



### nLite Aluminum – 20'/6m Kit

PART NO.: **AN60K** CASE QTY.: **1** Gen 1

- AN60G HiFlo nLite ALU Master Pole, 4 Sections - 20'/6.1 m
- NFK28 Power Brush Complete, flagged – 11"/28 m
- NL11G HiFlo nLite Hose – 36'/11 m
- FTGOS HiFlo MultiLink Adapter

## nLITE ACCESSORIES



### Hose Keeper Set (6)

PART NO.: **NLHKP** CASE QTY.: **1**

- Clips for outer hose routing on nLITE pole



### DuroFlex Hose

PART NO.: **DLS25** SIZE: **82'/25m** CASE QTY.: **1**

- Durable quick connect hose for pure water supply from water filter to brush



### nLITE Angle Adapters

PART NO.: <b>NGS15</b>	NAME: <b>Short</b>	SIZE: <b>6"/15cm</b>	CASE QTY.: <b>1</b>
PART NO.: <b>NGS30</b>	NAME: <b>Mid</b>	SIZE: <b>16.5"/42cm</b>	CASE QTY.: <b>1</b>
PART NO.: <b>NGS45</b>	NAME: <b>Long</b>	SIZE: <b>32"/82cm</b>	CASE QTY.: <b>1</b>

- Modular angle system easily reaches places that are difficult to access
- Simple, fast, and secure connection for every work situation
- Adjust brush angle in 45° stages
- No twisting when cleaning



### nLITE Classic Tool Adapter

PART NO.: **NLCLA** CASE QTY.: **1**

- Thread adapter for attaching classic tools on the new nLITE telescopic poles



### nLITE Euro Thread Adapter

PART NO.: **NLTHR** SIZE: **11"/28 cm** CASE QTY.: **1**

- Thread adapter for attaching Gen 1 brushes on the new nLITE telescopic poles



### nLITE Carrying Case

PART NO.: **NLBAG** CASE QTY.: **1**

- Convenient carrying bag for storage and transportation of the nLITE pole system and accessories



### Water Flow Regulator

PART NO.: **NLWVI** CASE QTY.: **1**

- Turn water flow to the brush completely on/off or adjust as needed
- Use with internal or external hoses



### Hose Connection Kit

PART NO.: **NLQUI** CASE QTY.: **1**

- For quick connection of two hoses
- Kit includes: Two Hose end pieces and one Quick Connector



### nLITE Extension Adapter

PART NO.: **NLHCC** SIZE: **16"/41cm** CASE QTY.: **1**

- Connects the first telescopic extension pole to the telescopic main pole with internal hose routing



### nLITE Power Brush - Flagged

PART NO.: **NFF28** SIZE: **11"/28cm** BRISTLES: **Flagged** CASE QTY: **1**  
 PART NO.: **NFF41** SIZE: **16"/41cm** BRISTLES: **Flagged** CASE QTY: **1**

- Green flagged bristles for maximum cleaning performance and gliding results
- Water jets built in the middle of brush block for powerful dirt removal
- Includes hose with quick connector



### nLITE Power Brush - Unflagged

PART NO.: **NUF28** SIZE: **11"/28cm** BRISTLES: **Unflagged** CASE QTY: **1**  
 PART NO.: **NUF41** SIZE: **16"/41cm** BRISTLES: **Unflagged** CASE QTY: **1**

- Gray unflagged bristles are stiffer for perfect cleaning results and optimized durability
- Water jets built in the middle of brush block for powerful dirt removal
- Includes hose with quick connector



### nLITE Power Brush Complete - Flagged

PART NO.: **NFK28** SIZE: **11"/28cm** BRISTLES: **Flagged** CASE QTY: **1**  
 PART NO.: **NFK41** SIZE: **16"/41cm** BRISTLES: **Flagged** CASE QTY: **1**

- Green flagged bristles for maximum cleaning performance and gliding results
- Soft touch bumper protects against scratches and damage to window frames
- Rinse bar above the brush delivers the right amount of pure water to the surface
- Water jets built in the middle of brush block for powerful dirt removal
- Swivel Lock function swivels brush 180° - use in an "S" motion to clean entire surface (for use up to 20')
- Includes hose with quick connector



### nLITE Power Brush Complete - Unflagged

PART NO.: **NUK28** SIZE: **11"/28cm** BRISTLES: **Unflagged** CASE QTY: **1**  
 PART NO.: **NUK41** SIZE: **16"/41cm** BRISTLES: **Unflagged** CASE QTY: **1**

- Gray unflagged bristles are stiffer for perfect cleaning results and optimized durability
- Soft touch bumper protects against scratches and damage to window frames
- Rinse bar above the brush delivers the right amount of pure water to the surface
- Water jets built in the middle of brush block for powerful dirt removal
- Swivel Lock function swivels brush 180° - use in an "S" motion to clean entire surface (for use up to 20')
- Includes hose with quick connector



### nLITE Hybrid Boar's Hair Brush Complete

PART NO.: **NUH28** SIZE: **11"/28cm** BRISTLES: **Unflagged** CASE QTY: **1**  
 PART NO.: **NUH41** SIZE: **16"/41cm** BRISTLES: **Unflagged** CASE QTY: **1**

- Powerful cleaning performance with easier glide and less weight than full natural hair brushes.
- Recommended for maintenance cleaning and solar cleaning.
- Outside boar bristles - high cleaning power of the folded bristles, no streaks
- Inside bristles with Power Bristle Technology - very high scrubbing power - easy glide
- Low water absorption
- Rinse nozzle strip above the brush for powerful rinsing
- Includes hoses with quick connectors



### nLITE Soft Brush Complete

PART NO.: **NFS28** SIZE: **11"/28cm** BRISTLES: **Unflagged** CASE QTY: **1**  
 PART NO.: **NFS41** SIZE: **16"/41cm** BRISTLES: **Unflagged** CASE QTY: **1**

- Gentle surface cleaning. Reduces risk of damage to sensitive surfaces.
- Thin bristles with high flexibility
- Short bristles in high density for stable fiber layout
- Nozzle block integrated in the middle of the brush for powerful dirt removal
- Rinse nozzle strip above the brush for powerful rinsing
- Includes hoses with quick connectors

## BRUSH OVERVIEW for nLITE® telescopic pole system - also compatible with nLite® Gen 1 telescopic pole system

		WEIGHT		WIDTH		BRISTLES			FEATURES			APPLICATION			
		Brush complete				Material	flagged/ unflagged	Length (outside/inside)	Center Nozzle Block	Rinse Bar	Swivel Lock	Initial cleaning	Maintenance cleaning	Sensitive surfaces	Solar*
	<b>nLITE POWER BRUSH COMPLETE</b>	NFK28	12.2 oz	11.02 in	Power-Technology	flagged	2.17 in / 1.57 in	✓	✓	✓		✓			
		NFK41	17.21 oz	16.14 in											
	<b>nLITE POWER BRUSH</b>	NFF28	10.23 oz	11.02 in	Power-Technology	flagged	2.17 in / 1.57 in	✓				✓			
		NFF41	14.07 oz	16.14 in											
	<b>nLITE POWER BRUSH COMPLETE</b>	NUK28	12.56 oz	11.02 in	Power-Technology	unflagged	2.17 in / 1.57 in	✓	✓	✓		✓		✓	
		NUK41	17.32 oz	16.14 in											
	<b>nLITE POWER BRUSH</b>	NUF28	10.37 oz	11.02 in	Power-Technology	unflagged	2.17 in / 1.57 in	✓				✓		✓	
		NUF41	14.18 oz	16.14 in											
	<b>nLITE SOFT BRUSH COMPLETE</b>	NFS28	11.28 oz	11.02 in	Thin Synthetic Bristles	unflagged	.98 in	✓	✓	✓			✓		
		NFS41	15.52 oz	16.14 in											
	<b>nLITE HYBRID BOAR'S HAIR BRUSH COMPLETE</b>	NUH28	11.75 oz	11.02 in	Boar + Power	unflagged	1.77 in / 1.18 in-	✓	✓	✓	✓			✓	
		NUH41	16.226 oz	16.14 in											

\*Solar panels can damage easily; please use caution and proper tool maintenance when cleaning with water fed tools

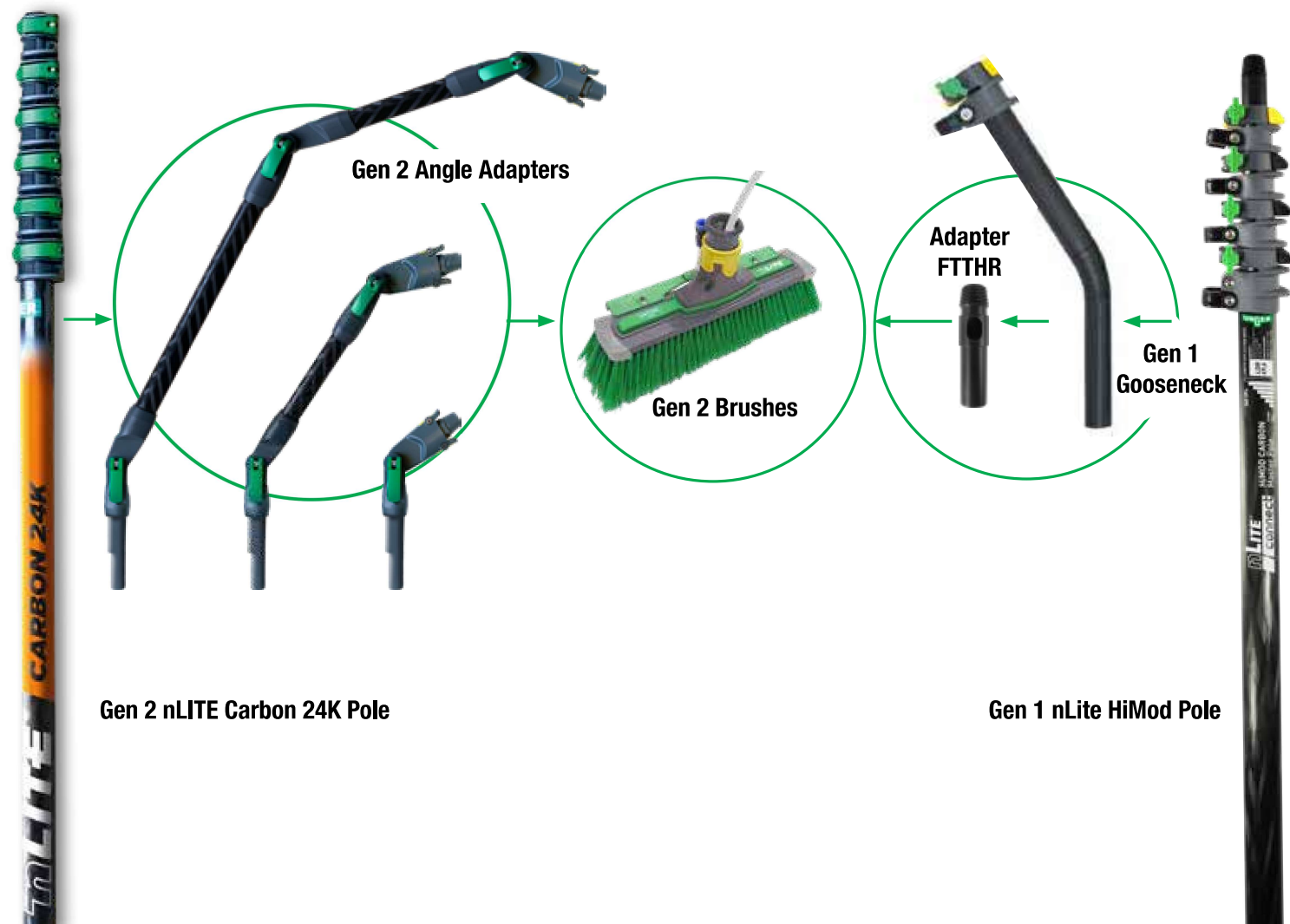

## WASHERS

### ErgoTec NINJA



#### ErgoTec Ninja Washer Complete

PART NO.: **NA450** SIZE: **18"/45 cm** CASE QTY: **5**

- Superior water retention and cleaning
- Built-in microfiber scrubbing bristles with center lock
- Two abrasive pads provide extra scrubbing power
- Ergonomic swivel handle
- Wash Cycles: 500



#### Micro StripWasher® Complete

PART NO.: **NC350** SIZE: **14"/35 cm** CASE QTY: **10**

PART NO.: **NC450** SIZE: **18"/45 cm** CASE QTY: **10**

- Microfiber sleeve absorbs up to six times it's weight
- Scrub pad provides extra cleaning power
- Lightweight plastic T-bar with patented water wells for high water retention, reducing number of bucket dips
- Wash Cycles: 500



#### Monsoon Plus StripWasher Complete

PART NO.: **MC350** SIZE: **14"/35 cm** CASE QTY: **10**

PART NO.: **MC450** SIZE: **18"/45 cm** CASE QTY: **10**

- Woven fabric holds large amounts of water
- Reinforced sewn ends & durable backing for extended life
- Ideal for cleaning large windows/areas
- T-bar with water wells included



#### The Original StripWasher Complete

PART NO.: **WC250** SIZE: **10"/25 cm** CASE QTY: **10**

PART NO.: **WC350** SIZE: **14"/35 cm** CASE QTY: **10**

PART NO.: **WC450** SIZE: **18"/45 cm** CASE QTY: **10**

- Gentle but strong
- Reinforced zigzag stitched ends ensure long life
- Excellent for cleaning windows, screens and dusting
- T-bar with water wells included



#### The Pad StripWasher Complete

PART NO.: **RC350** SIZE: **14"/35 cm** CASE QTY: **10**

PART NO.: **RC450** SIZE: **18"/45 cm** CASE QTY: **10**

- Plush, woven synthetic fabric with reinforced zigzag stitching for extended life
- Rough-textured, non-abrasive nylon cleaning pad removes tough dirt
- T-bar with water wells included



#### ErgoTec Ninja T-Bar

PART NO.: **NI350** SIZE: **14"/35 cm** CASE QTY: **5**

PART NO.: **NI450** SIZE: **18"/45 cm** CASE QTY: **5**

PART NO.: **NI550** SIZE: **22"/55 cm** CASE QTY: **5**

PART NO.: **NI750** SIZE: **30"/75 cm** CASE QTY: **5**

- Ergonomic T-bar with polypropylene handle
- Two-component handle provides less strain and more control
- Water wells offer increased water retention
- Ergonomic handle with swivel center lock



#### ErgoTec T-Bar

PART NO.: **EH250** SIZE: **10"/25 cm** CASE QTY: **10**

PART NO.: **EH350** SIZE: **14"/35 cm** CASE QTY: **10**

PART NO.: **EH450** SIZE: **18"/45 cm** CASE QTY: **10**

- Ergonomic T-bar with polypropylene handle
- Two-component handle provides less strain and more control
- Water wells create increased water retention



#### Swivel Strip T-Bar

PART NO.: **SV350** SIZE: **14"/35 cm** CASE QTY: **5**

PART NO.: **SV450** SIZE: **18"/45 cm** CASE QTY: **5**

- Lightweight aluminum T-bar with adjustable head
- Angle adjusts to seven different positions
- Usable with all Unger washer sleeves and telescopic poles



## BLACK SERIES

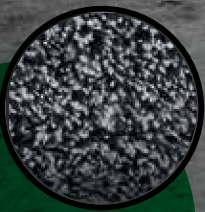

20% higher water absorption than standard microfiber sleeves

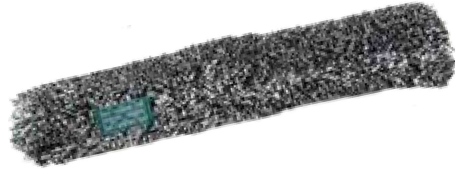

### Black Series Sleeve

PART NO. <b>BS350</b>	SIZE: <b>14"/35 cm</b>	CASE QTY: <b>10</b>
PART NO. <b>BS450</b>	SIZE: <b>18"/45 cm</b>	CASE QTY: <b>10</b>

- 20% higher water absorption than standard microfiber sleeve
- Power microfiber sleeve with scrubbing pad for ultimate cleaning power
- Machine washable & tumble dry



### ErgoTec Ninja Sleeve

PART NO. <b>NJ250</b>	SIZE: <b>10"/25 cm</b>	CASE QTY: <b>5</b>
PART NO. <b>NJ350</b>	SIZE: <b>14"/35 cm</b>	CASE QTY: <b>5</b>
PART NO. <b>NJ450</b>	SIZE: <b>18"/45 cm</b>	CASE QTY: <b>5</b>
PART NO. <b>NJ550</b>	SIZE: <b>22"/55 cm</b>	CASE QTY: <b>5</b>
PART NO. <b>NJ750</b>	SIZE: <b>30"/75 cm</b>	CASE QTY: <b>5</b>

- Extra long fiber: Built-in microfiber scrubbing bristles
- Two abrasive pads: One on each side providing extra scrubbing power
- Wash Cycles: 500

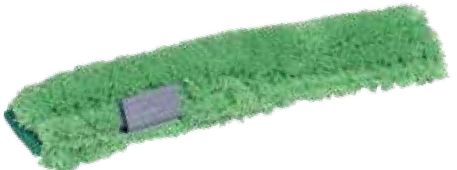

### Micro StripWasher Sleeve

PART NO. <b>NS250</b>	SIZE: <b>10"/25 cm</b>	CASE QTY: <b>10</b>
PART NO. <b>NS350</b>	SIZE: <b>14"/35 cm</b>	CASE QTY: <b>10</b>
PART NO. <b>NS450</b>	SIZE: <b>18"/45 cm</b>	CASE QTY: <b>10</b>
PART NO. <b>NS550</b>	SIZE: <b>22"/55 cm</b>	CASE QTY: <b>10</b>

- Microfiber washer sleeve with scrub pad and hook & loop fastening
- Can absorb up to six times its weight
- Scrub pad provides extra cleaning power
- Wash Cycles: 500

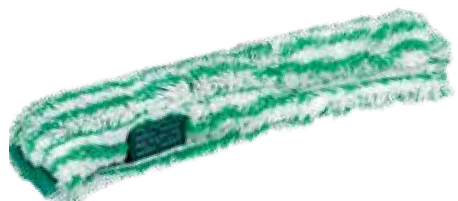

### Monsoon Plus StripWasher Sleeve

PART NO. <b>MS250</b>	SIZE: <b>10"/25 cm</b>	CASE QTY: <b>10</b>
PART NO. <b>MS350</b>	SIZE: <b>14"/35 cm</b>	CASE QTY: <b>10</b>
PART NO. <b>MS450</b>	SIZE: <b>18"/45 cm</b>	CASE QTY: <b>10</b>
PART NO. <b>MS550</b>	SIZE: <b>22"/55 cm</b>	CASE QTY: <b>10</b>

- Heavy-duty washer sleeve with extra-long fibers, scrub pad, and hook & loop fastening
- Woven fabric holds large amounts of water. Reinforced sewn ends & durable backing for extended life
- Ideal for cleaning large windows/areas



### The Original StripWasher Sleeve

PART NO. <b>WS250</b>	SIZE: <b>10"/25 cm</b>	CASE QTY: <b>10</b>
PART NO. <b>WS350</b>	SIZE: <b>14"/35 cm</b>	CASE QTY: <b>10</b>
PART NO. <b>WS450</b>	SIZE: <b>18"/45 cm</b>	CASE QTY: <b>10</b>
PART NO. <b>WS550</b>	SIZE: <b>22"/55 cm</b>	CASE QTY: <b>10</b>

- Standard washer sleeve made with plush, woven synthetic fabric with hook & loop fastening
- Reinforced zigzag stitched ends ensure long life
- Excellent for cleaning windows, screens, and dusting



### The Pad StripWasher Sleeve

PART NO. <b>RS350</b>	SIZE: <b>14"/35 cm</b>	CASE QTY: <b>10</b>
PART NO. <b>RS450</b>	SIZE: <b>18"/45 cm</b>	CASE QTY: <b>10</b>

- Standard washer sleeve with plush, woven synthetic fabric on front and textured pad strip on back with hook & loop fastening
- Plush, woven synthetic fabric with reinforced zigzag stitching for extended life
- Rough-textured, non-abrasive nylon cleaning pad removes tough dirt



### ErgoTec Ninja Squeegee Complete

PART NO.: **EN300** SIZE: **12"/30 cm** CASE QTY: **5**  
 PART NO.: **EN450** SIZE: **18"/45 cm** CASE QTY: **5**

- The most advanced squeegee ever built
- Swivel and TriLoc safety function
- Extruded Aircraft Aluminum T6 Channel is lightweight and will not bend
- Center position can be locked by pressing the Lock Button
- 40° Head Angle



### ErgoTec Ninja Squeegee Handle - 40°

PART NO.: **EN000** CASE QTY: **5**

### ErgoTec Ninja Squeegee Handle - 30°

PART NO.: **E3000** CASE QTY: **5**

- Ergonomic two-component handle with a 40° or 30° head angle, perfect for use with pole
- Swivel and TriLoc safety function for secure channel hold
- Center position can be locked by press of a button



### ErgoTec Ninja Aluminum Channels

PART NO.: **AC200** SIZE: **8"/20 cm** CASE QTY: **5**  
 PART NO.: **AC250** SIZE: **10"/25 cm** CASE QTY: **5**  
 PART NO.: **AC300** SIZE: **12"/30 cm** CASE QTY: **5**  
 PART NO.: **AC350** SIZE: **14"/35 cm** CASE QTY: **5**  
 PART NO.: **AC450** SIZE: **18"/45 cm** CASE QTY: **5**  
 PART NO.: **AC550** SIZE: **22"/55 cm** CASE QTY: **5**

- Channel is constructed from aircraft-grade aluminum; will not break or bend
- Features laser-etched star markings to make finding the center position easy when attaching to handle
- Flexible rubber positioning allows for a lower position (for shorter channels) and a higher position (for longer channels)
- Comes complete with revolutionary soft rubber "SmartClip" end clips that eliminate the need for separate brass or plastic clips



### ErgoTec Squeegee Handle

PART NO.: **ETG00** CASE QTY: **10**

- Ergonomic, two-component handle has a comfortable, non-slip rubber grip that is ideal for all weather conditions
- Textured thumb plate for easy adjustment and channel change
- Simple, quick-release "S" spring for fast rubber change

### ErgoTec SL Handle

PART NO.: **ETX00** CASE QTY: **10**

- Extra long, two-component ergonomically designed handle
- Textured thumb plate for easy adjustment and channel change
- Handle is almost a full inch longer for large hands
- Quick-release "S" spring for fast rubber change

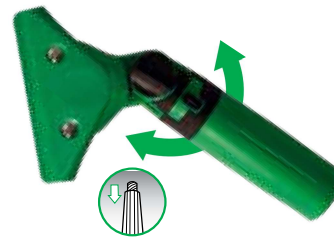

### ErgoTec SwivelLoc

PART NO.: **LA000** ANGLE: **30°** CASE QTY: **5**  
 PART NO.: **LS000** ANGLE: **Strt. 0°** CASE QTY: **5**

- Handle comes in two models, both with swivel action and ergonomic grip
- 0° for cleaning low windows. 30° head angle for working above ledges
- 0° – Brass or Stainless Steel "S" Channel, 30° – "S" Channel only



### GoldenClip® Brass Handle

PART NO.: **GS000** CASE QTY: **10**

- Classic solid brass handle with screw locks
- Use with Brass Channel or "S" Channel

### Pro Stainless Steel Handle

PART NO.: **PR000** CASE QTY: **10**

- Stainless steel handle with ergonomic rubber grip and fast lock for quick channel changes

## Tool Connections



**Press On**  
Special grooves on the cone ensure a secure fit for the tools.



**Snap On**  
These tools snap directly onto Unger telescopic poles.



**Screw On**  
These tools screw onto the ACME thread of an Unger cone.

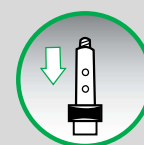

**Lock On**  
Any tool with a hole in the handle and "LOCK" inscribed on it locks onto the ErgoTec® Locking Cone preventing the tool from twisting or pulling off the pole during work.

## ErgoTec Squeegee Complete

PART NO.:	<b>ES150</b>	SIZE: <b>6"/15 cm</b>	CASE QTY.: <b>10</b>
PART NO.:	<b>ES250</b>	SIZE: <b>10"/25 cm</b>	CASE QTY.: <b>10</b>
PART NO.:	<b>ES300</b>	SIZE: <b>12"/30 cm</b>	CASE QTY.: <b>10</b>
PART NO.:	<b>ES350</b>	SIZE: <b>14"/35 cm</b>	CASE QTY.: <b>10</b>
PART NO.:	<b>ES400</b>	SIZE: <b>16"/40 cm</b>	CASE QTY.: <b>10</b>
PART NO.:	<b>ES450</b>	SIZE: <b>18"/45 cm</b>	CASE QTY.: <b>10</b>

- Ergonomic, two-component handle
- Complete with "S" Channel and ErgoTec Soft Rubber
- Non-slip grip ideal for all weather conditions
- Quick-release "S" spring for fast rubber change

ErgoTec Squeegee Complete



## Pro Stainless Steel Squeegee Complete

PART NO.:	<b>PR250</b>	SIZE: <b>10"/25 cm</b>	CASE QTY.: <b>10</b>
PART NO.:	<b>PR300</b>	SIZE: <b>12"/30 cm</b>	CASE QTY.: <b>10</b>
PART NO.:	<b>PR350</b>	SIZE: <b>14"/35 cm</b>	CASE QTY.: <b>10</b>
PART NO.:	<b>PR400</b>	SIZE: <b>16"/40 cm</b>	CASE QTY.: <b>10</b>
PART NO.:	<b>PR450</b>	SIZE: <b>18"/45 cm</b>	CASE QTY.: <b>10</b>

- Stainless steel squeegee with ergonomic rubber grip Complete with "S" Channel and ErgoTec Soft Rubber
- Non-slip rubber grip ideal for all weather conditions
- Features a fast lock for quick channel changes

Pro Stainless Steel Squeegee Complete



## GoldenClip Brass Squeegee Complete

PART NO.:	<b>GS250</b>	SIZE: <b>10"/25 cm</b>	CASE QTY.: <b>10</b>
PART NO.:	<b>GS300</b>	SIZE: <b>12"/30 cm</b>	CASE QTY.: <b>10</b>
PART NO.:	<b>GS350</b>	SIZE: <b>14"/35 cm</b>	CASE QTY.: <b>10</b>
PART NO.:	<b>GS400</b>	SIZE: <b>16"/40 cm</b>	CASE QTY.: <b>10</b>
PART NO.:	<b>GS450</b>	SIZE: <b>18"/45 cm</b>	CASE QTY.: <b>10</b>

- Complete with handle, channel, ErgoTec soft rubber, and plastic end clips
- Classic brass squeegee with screw lock to firmly hold channel and rubber

GoldenClip Brass Squeegee Complete

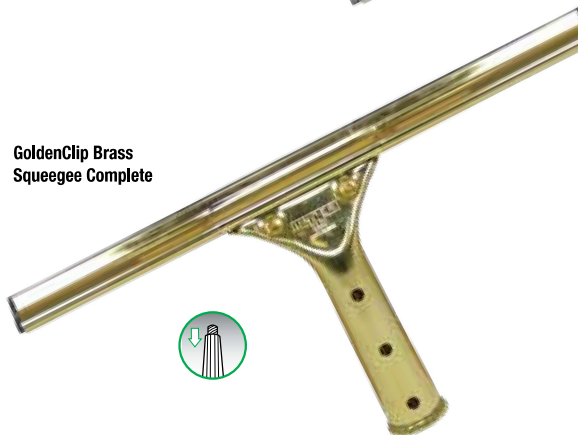

## UniTec™ Lite Squeegee

PART NO.:	<b>US300</b>	SIZE: <b>12"/30 cm</b>	CASE QTY.: <b>10</b>
-----------	--------------	------------------------	----------------------

- Ultra-light plastic squeegee for glass or flat surfaces in household areas
- Lightweight and comfortable to hold
- For glass or smooth surfaces

UniTec Lite Squeegee



## VisaVersa®

PART NO.:	<b>VP250</b>	SIZE: <b>10"/25 cm</b>	CASE QTY.: <b>10</b>
PART NO.:	<b>VP350</b>	SIZE: <b>14"/35 cm</b>	CASE QTY.: <b>10</b>
PART NO.:	<b>VP450</b>	SIZE: <b>18"/45 cm</b>	CASE QTY.: <b>10</b>

- Ultra-light plastic squeegee for glass or flat surfaces in household areas
- Lightweight and comfortable to hold
- For glass or smooth surfaces

VisaVersa



## Auto Squeegee

PART NO.:	<b>AUSQ0</b>	SIZE: <b>8"/20 cm</b>	CASE QTY.: <b>20</b>
-----------	--------------	-----------------------	----------------------

- Squeegee and scrubber in one
- Heavy-duty mesh scrubber for the hard-to-remove buildup on windows
- 21"/53 cm plastic handle for extended reach

Auto Squeegee





### “S” Channel

PART NO.: NE150	SIZE: 6"/15 cm	CASE QTY.: 10	PART NO.: NE400	SIZE: 16"/40 cm	CASE QTY.: 10
PART NO.: NE250	SIZE: 10"/25 cm	CASE QTY.: 10	PART NO.: NE450	SIZE: 18"/45 cm	CASE QTY.: 10
PART NO.: NE300	SIZE: 12"/30 cm	CASE QTY.: 10	PART NO.: NE550	SIZE: 22"/55 cm	CASE QTY.: 10
PART NO.: NE350	SIZE: 14"/35 cm	CASE QTY.: 10			

- Stainless steel “S” Channel complete with ErgoTec® Soft Replacement Rubber
- Fits on ErgoTec and Pro Stainless Steel handles



### Brass Channel for GoldenClip

PART NO.: GC150	SIZE: 6"/15 cm	CASE QTY.: 10	PART NO.: GC400	SIZE: 16"/40 cm	CASE QTY.: 10
PART NO.: GC250	SIZE: 10"/25 cm	CASE QTY.: 10	PART NO.: GC450	SIZE: 18"/45 cm	CASE QTY.: 10
PART NO.: GC300	SIZE: 12"/30 cm	CASE QTY.: 10	PART NO.: GC550	SIZE: 22"/55 cm	CASE QTY.: 10
PART NO.: GC350	SIZE: 14"/35 cm	CASE QTY.: 10			

- Sturdy brass channel complete with ErgoTec soft rubber. Includes plastic end clips



### S-CHANNEL PLUS

PART NO.: UC300	SIZE: 12"/30 cm	CASE QTY.: 10
PART NO.: UC350	SIZE: 14"/35 cm	CASE QTY.: 10
PART NO.: UC450	SIZE: 18"/45 cm	CASE QTY.: 10

- Stainless Steel channel complete with ErgoTec® Soft Replacement Rubber
- Curved ends support the rubber at the edges for improved cleaning close to frame
- Fits on ErgoTec and Pro Stainless Steel handles



### Power Squeegee Rubber

PART NO.: RR35G	SIZE: 14"/35 cm	CASE QTY.: 10
PART NO.: RR45G	SIZE: 18"/45 cm	CASE QTY.: 10

- Squeegee rubber designed for year round use
- Streak-free results
- Reliable, long-lasting
- Professional quality – Made in Europe



### Hard Replacement Rubber

PART NO.: RG25H	SIZE: 10"/25 cm	CASE QTY.: 144
PART NO.: RG35H	SIZE: 14"/35 cm	CASE QTY.: 144
PART NO.: RG40H	SIZE: 16"/40 cm	CASE QTY.: 144
PART NO.: RG45H	SIZE: 18"/45 cm	CASE QTY.: 144
PART NO.: RG55H	SIZE: 22"/55 cm	CASE QTY.: 144
PART NO.: RG92H	SIZE: 36"/92 cm	CASE QTY.: 144

- Ideal for warmer temperatures
- Optimum liquid removal on large, flat surfaces
- Coated with talcum to ensure freshness



### ErgoTec Soft Rubber - 12pk

PART NO.: RT150	SIZE: 6"/15 cm	CASE QTY.: 12
PART NO.: RT200	SIZE: 8"/20 cm	CASE QTY.: 12
PART NO.: RT250	SIZE: 10"/25 cm	CASE QTY.: 12
PART NO.: RT300	SIZE: 12"/30 cm	CASE QTY.: 12
PART NO.: RT350	SIZE: 14"/35 cm	CASE QTY.: 12
PART NO.: RT400	SIZE: 16"/40 cm	CASE QTY.: 12
PART NO.: RT450	SIZE: 18"/45 cm	CASE QTY.: 12
PART NO.: RT500	SIZE: 20"/50 cm	CASE QTY.: 12
PART NO.: RT550	SIZE: 22"/55 cm	CASE QTY.: 12
PART NO.: RT600	SIZE: 24"/60 cm	CASE QTY.: 12
PART NO.: RT750	SIZE: 30"/75 cm	CASE QTY.: 12
PART NO.: RT920	SIZE: 36"/92 cm	CASE QTY.: 12
PART NO.: RT990	SIZE: 42"/105 cm	CASE QTY.: 12

- Ideal for cooler temperatures
- Conforms to uneven surfaces
- Better glide with streak-free performance



### ErgoTec Soft Rubber Gross Packs

PART NO.: RG300	SIZE: 12"/30 cm	CASE QTY.: 144
PART NO.: RG350	SIZE: 14"/35 cm	CASE QTY.: 144
PART NO.: RG400	SIZE: 16"/40 cm	CASE QTY.: 144
PART NO.: RG450	SIZE: 18"/45 cm	CASE QTY.: 144
PART NO.: RG550	SIZE: 22"/55 cm	CASE QTY.: 144
PART NO.: RG920	SIZE: 36"/92 cm	CASE QTY.: 144

- Ideal for cooler temperatures
- Conforms to uneven surfaces
- Sturdy storage box is shrink-wrapped for protection



### Plastic Clips and Case

PART NO.: PCLIP
CONTENTS: 40 Clips per Dispenser
CASE QTY.: 10

- Increases strength of rubber edge
- Clips easily separate from dispenser
- Solid plastic clip fits between channel and squeegee rubber
- Increases stability, offering sharper end strokes



# ERGOTEC<sup>®</sup> NINJA Scraper System

Use the ErgoTec Ninja Scraper System to clean glass and flat surfaces quickly. With an adjustable working angle from 0-30°, these dual-sided, rust-resistant blades are perfect for every application. Work faster and safer with an ErgoTec Ninja Scraper and Holster combination.

### ErgoTec Ninja Scraper

PART NO.:	EN100	SIZE:	4"/10 cm	CASE QTY.:	5
PART NO.:	EN150	SIZE:	6"/15 cm	CASE QTY.:	5

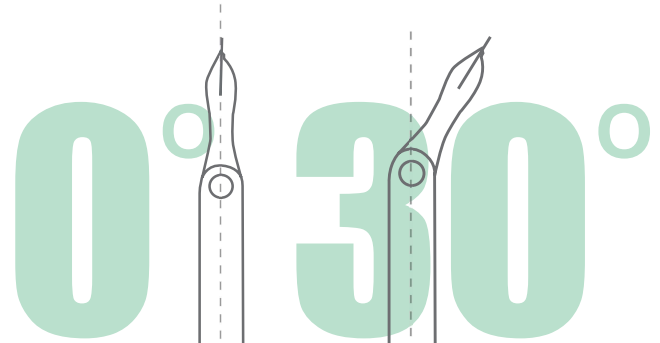

## 2 TOOLS IN 1

The working angle of the scraper head can be changed from 0° for hand scraping to 30° for window scraping with the push of a button!



### Premium Glass Scraper Blades

PART NO.:	ENB10	CONTENTS:	25 Blades
SIZE:	4"/10 cm	CASE QTY.:	10
PART NO.:	ENB15	CONTENTS:	25 Blades
SIZE:	6"/15 cm	CASE QTY.:	10

- Dual-sided sharp blades made from rust resistant 440A grade stainless steel which provides excellent edge retention and ensures that blades stay sharp
- Each blade is honed to a precise edge, creating a perfect cutting angle that is razor sharp and consistent
- Compatible with most 4"/10 cm and 6"/15 cm scrapers



### ErgoTec Ninja Scraper Holster

PART NO.:	HT150	CASE QTY.:	5
-----------	-------	------------	---

### ErgoTec Ninja Scraper - Combo

PART NO.:	ENH15	SIZE:	6"/15 cm	CASE QTY.:	5
-----------	-------	-------	----------	------------	---

- Lock the Scraper in the Holster in seconds
- The Easy Clip secures the handle in place and prevents it from falling out
- Durable solid plastic holster with stainless steel insert withstands frequent contact with sharp blade and protects the worker from cuts to legs and hands
- Holster is compatible with most 4" – 6" (10 - 15 cm) scrapers on the market, flat or angled



ErgoTec Glass Scraper - 6"



ErgoTec Glass Scraper - 4"



### ErgoTec Glass Scraper

PART NO.: **EG100** SIZE: **4"/10 cm** CASE QTY.: **10**  
 PART NO.: **EG150** SIZE: **6"/15 cm** CASE QTY.: **10**

- Complete with lightweight ergonomic handle and protective cap
- Reversible blade has two razor edges ideal for cleaning large surfaces and scraping off paint, stickers, etc.



### Trim 10 Scraper

PART NO.: **TM100** SIZE: **4"/10 cm** CASE QTY.: **10**

- Glass scraper in strong stainless steel blade holder
- Double-edged carbon steel blade
- Fits ErgoTec® and Pro Squeegees for window cleaning with telescopic poles



TM100 Inserted into an ErgoTec Handle

### ProTrim 10

PART NO.: **TX100** SIZE: **4"/10 cm** CASE QTY.: **10**

- Compact scraper for everyday use
- Easily handled, and fits in pocket
- Integrated safety guard for blade protection
- Scraper opens with a push of a button for quick blade replacement and cleaning



ErgoTec Safety Scraper

### ErgoTec Safety Scraper

PART NO.: **SR040** SIZE: **1.5"/4 cm** CASE QTY.: **50**

- Unique locking system eliminates blades from sliding out while working
- Rubber grip on SR040 prevents scraper from slipping in hand

### Safety Scraper

PART NO.: **SR500** SIZE: **1.5"/4 cm** CASE QTY.: **50**

- Unique locking system eliminates blades from sliding out while working
- SR500 made with stainless steel



Safety Scraper

### Mini Scraper

PART NO.: **STMIN** SIZE: **1 1/2"/4 cm** CASE QTY.: **100**

- Comes packaged in a storage bucket, perfect for countertops
- Easily snaps open for quick blade replacement



Mini Scraper

## Expert Tips - How Professionals Scrape

- Check if glass is scratch-resistant and suitable for scraper use  
*Unsuitable glass surfaces include: plexiglass, crown glass, solar glass, and safety glass (ESG)*
- Always follow the manufacturer's instructions
- Perform a scrape test in advance on a small section
- Before starting, check the glass for any damage and report it, if necessary
- Check the blade for damage and change or reverse it
- The surface to be scraped should always be wet
- It is best to use a releasing agent, such as EasyGlide Glass Cleaner
- Scrape in one direction. Never pull the scraper back, as this may cause scratches





ErgoTec Scraper

Brute Scraper

Maxi Scraper



**Replacement Blades - Carbon Steel**

PART NO.: **RB10C** SIZE: **4"/10 cm**  
 CONTENTS: 10 Dispensers of 10 Blades

PART NO.: **RB30C** SIZE: **4"/10cm**  
 CONTENTS: **30 Dispensers of 10 Blades**

- Compact handy dispenser safely stores new and used blades – easily slide in and out
- Sharp side for scraping off paint, stickers, etc., and dull side for removing cement and stucco
- For SH00C, SH25C, STMAX



**Replacement Blades - Stainless Steel**

PART NO.: **RB100** SIZE: **4"/10 cm**  
 CONTENTS: **10 Dispensers of 10 Blades**

- Compact handy dispenser safely stores new and used blades
- Long-lasting, rust-free blades that easily slide in and out of dispenser
- Sharp side for scraping off paint, stickers, etc., and dull side for removing cement and stucco
- For SH00C, SH25C, STMAX

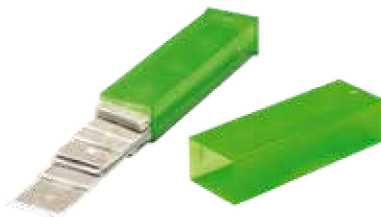

**Trim/Glass Scraper Replacement Blades**

PART NO.: **TR100** SIZE: **4"/10 cm** CONTENTS: **10 Dispensers of 25 Blades**

PART NO.: **TR150** SIZE: **6"/15 cm** CONTENTS: **10 Dispensers of 25 Blades**

- Rust-resistant, coated carbon steel blades with a reversible razor edge
- Handy dispenser protects blades
- Individually wrapped in wax paper to prevent rusting
- For TX100, TM100, EG100/150, EN100/EN150

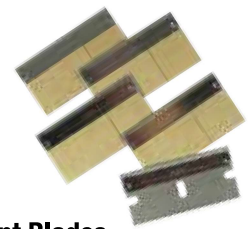

**Trim/Glass Scraper Replacement Blades**

PART NO.: **SRBDB** SIZE: **1 1/2"/4 cm** CONTENTS: **1 Display Box of 48 Dispensers**

PART NO.: **SRB10** SIZE: **1 1/2"/4 cm** CONTENTS: **1 Tray of 100 Blades**

PART NO.: **SRB30** SIZE: **1 1/2"/4 cm** CONTENTS: **10 Trays of 100 Blades**

- Razor sharp No. 9 (1-1/2") standard blades
- Packed in a convenient reclosable plastic tray so blades are kept safe and dry to prevent rusting
- SRBDB: Compact display box for general merchandising areas
- Contains 48 individually packaged dispensers: each dispenser contains 10 blades
- For SR040, SR500, STMIN



### ErgoTec Professional Window Cleaning Kit

PART NO.: **ETSET** CASE QTY.: **1**

- ErgoTec T-Bar – 14”/35 cm
- Micro StripWasher Sleeve – 14”/35 cm
- ErgoTec Squeegee Handle
- “S” Channel w/ ErgoTec Soft Rubber – 10”/25 cm
- “S” Channel w/ErgoTec Soft Rubber – 14”/35 cm
- “S” Channel w/ErgoTec Soft Rubber – 18”/45 cm
- ErgoTec Soft Replacement Rubber – 36”/93 cm
- Plastic Clips and Case
- ErgoTec Scraper – 4”/10 cm
- ErgoTec Safety Scraper – 1.5”/4 cm
- MicroWipe (3)
- OptiLoc 2-Section Tele-Pole – 8’/2.4 m
- ErgoTec Safety Cone
- The Pill Glass Cleaner (10 pack)
- Nylon Carrying Case



### Advanced Window Cleaning Kit

PART NO.: **TRS00** CASE QTY.: **1**

- Pro Stainless Steel Squeegee Handle
- “S” Channel w/ErgoTec Soft Rubber – 10”/25 cm
- “S” Channel w/ErgoTec Soft Rubber – 14”/35 cm
- “S” Channel w/ErgoTec Soft Rubber – 18”/45 cm
- ErgoTec Soft Rubber – 36”/93 cm
- Original Complete – 14”/35 cm
- OptiLoc 2-Section Tele-Pole – 8’/2.4 m
- ErgoTec Locking Cone
- FIXI-clamp
- HandiBrush
- Large Sponge
- ErgoTec Safety Scraper
- ProTrim10 Scraper
- Nylon Carrying Case



### Starter Pro Window Cleaning Kit

PART NO.: **PWK00** CASE QTY.: **1**

- Original Complete – 18”/45 cm
- Pro Stainless Steel Squeegee Handle
- “S” Channel w/ErgoTec Soft Rubber – 14”/35 cm
- “S” Channel w/ErgoTec Soft Rubber – 18”/45 cm
- ProTrim10 Scraper
- Large Sponge
- OptiLoc 2-Section Tele-Pole – 8’/2.4 m

## CHEMICALS & CLOTHS



### The Pill Glass Cleaner

PART NO.: **PL100** CASE QTY.: **10**

CONTENTS: **10 Strips of 10 Pills**

PART NO.: **PL500** CASE QTY.: **1**

CONTENTS: **5 Rolls of 100 Pills**

PART NO.: **PLBTL** CASE QTY.: **1**

CONTENTS: **12 bottles of 100 Pills**

- Pre-measured - mix with 2 1/2 gallons of water
- Biodegradable, skin friendly and non-toxic
- PL100/PL500 individually packaged

### RubOut

PART NO.: **RUB50** SIZE: **1 Pint** CASE QTY.: **12**

- Professional surface cleaner for removing hard-water stains, rust, mineral deposits, lime scale and soap scum
- Scrub stains without harming surface

### EasyGlide Glass Cleaner

PART NO.: **FR110** SIZE: **1 Quart** CASE QTY.: **6**

PART NO.: **FR380** SIZE: **1 Gallon** CASE QTY.: **4**

- Liquid window cleaner that leaves behind a smooth surface for squeegees to glide across. 100:1 concentrate (Makes 25 gallons per quart)
- Biodegradable, skin friendly and non-toxic

### MicroWipe™

PART NO.: **MF40L** SIZE: **16”x16”/40x40 cm** CASE QTY.: **10**

PART NO.: **MF10L** SIZE: **4”x4”/10x10 cm** CASE QTY.: **10**

- Ultrafine microfiber cloth ideal for ledges and frames on windows and mirrors
- Superior water absorption, no streaks
- Two surfaces: coarse for cleaning, smooth for polishing
- Pocket sized cloth perfect for cleaning eye glasses, phone and tablet screens

### Ninja MicroWipe

PART NO.: **MN40U** SIZE: **16”x16”/40x40 cm** CASE QTY.: **5**

- Premium microfiber cloth for streak-free glass and window cleaning
- Four scrub zones for extra cleaning power
- Wash Cycles: 500



**Pro Bucket**

PART NO.: **QB120** CASE QTY.: **10**  
CAPACITY: **4.5 gal./18 L**

- Excellent for window cleaning
- Easy to handle and lightweight
- Plastic sieve for washer and squeegee
- Holds up to 4.5 gallons and 14" washer



**Bucket Sieve**

PART NO.: **QB060** CASE QTY.: **5**

- Bucket sieve for wringing out washers
- Features a chemical-resistant coating
- Can wring out up to an 18" washer

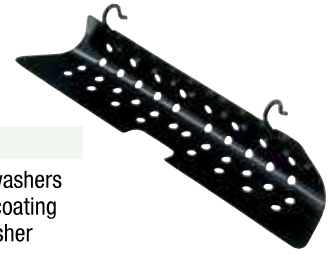

**Pro Bucket**

PART NO.: **QB220** CASE QTY.: **5**  
CAPACITY: **6 gal./23 L**

- Heavy-duty bucket with ergonomic handle
- Holds over six gallons of liquid and 18" T-bar
- Includes measuring units, large footprint for increased stability, and rounded pour spouts on two corners for easy emptying



**Pro Bucket Lid**

PART NO.: **QB080** CASE QTY.: **5**

- Sturdy snap-on lid for Pro Bucket
- Notched tabs lock handle into upright position when lid is in place
- Inner seal provides splash and leak protection
- Removes easily using tabs on each corner



TOOL HOLDERS

**Leather Holster**

PART NO.: **HT000** CASE QTY.: **5**

- Leather tool holder with two compartments
- Holds squeegees and washers
- Made of top grain leather and attaches to any belt



Leather Holster

**The Belt**

PART NO.: **UB000** CASE QTY.: **5**

- For attaching the Bucket On A Belt and other tools
- Two loops hold additional tools
- Easy-to-use, side-release buckle
- Made with 2" / 5 cm heavy-duty nylon webbing



The Belt

**ErgoTec Belt**

PART NO.: **BSTBT** SIZE: **32"-50"/80-130cm** CASE QTY.: **1**

- Sturdy padded belt for carrying tool pouches
- Four clips, quick-release closure



ErgoTec Belt

**Bucket On A Belt**

PART NO.: **BB010** STYLE: **ErgoTec Ninja** CASE QTY.: **5**  
PART NO.: **BB020** STYLE: **Classic** CASE QTY.: **5**

- Holder for squeegees, washer, scraper, and cleaning liquid
- Holds all important tools at your side, reducing the need to climb up and down ladders
- Available in ErgoTec® and classic versions
- ErgoTec® version is for right- or left-handed use
- Sturdy quick-release strap for easy removal from belt



Ninja Bucket on a Belt



ErgoTec Pouch



Classic Bucket on a Belt

**ErgoTec Pouch**

PART NO.: **BSPOU** SIZE: **12"x 14.5"/30x 37 cm** CASE QTY.: **1**

- Contains three waterproof compartments for storing dry and damp cloths separately
- Front pocket features tool loop and hook and loop closure



# HIGH ACCESS AND DUSTING

Unger's line of commercial cleaning tools specifically designed for tall spaces can effectively remove the layers of built-up dust and grime that have accumulated over time.

Cleaning hard-to-reach spaces at high heights present many challenges, from safety and cleanliness concerns to putting physical strain on your employees. All of Unger's commercial cleaning products are designed for efficiency and ease of use so you're able to quickly and effectively clean high windows, high ceilings, pipes, ductwork and ledges.

**FEATURED PRODUCT**



**StarDuster® Pipe Brush**

PART NO.: **PIPE0** CASE QTY: **5**

- Bendable 11"/28 cm curved brush for cleaning pipes and other round surfaces
- Made with heavy-duty wire and polypropylene bristles

.....  
**Keep your workers safe on the ground while dusting difficult to reach areas!**



Scan here for more information.

## TELESCOPIC POLES

High-access cleaning simplified. Wherever there is a need for extended reach, choose an Unger telescopic pole.

All of the Unger poles have ergonomic handles for worker comfort. All fit a full range of cleaning tools – washers, squeegees, dusters, and brushes.

No matter what the job, using an Unger pole allows performance and safety to be top priorities.

### Henry's Handi Handle

PART NO.: **HH240** LENGTH: **2'/60 cm** SECTIONS: **1** PACK UNIT: **5**

- Ergonomic, one section handle with ErgoTec® Locking Cone

### UniTec

PART NO.: **OS250** LENGTH: **10'/3 m** SECTIONS: **2** PACK UNIT: **Any 10**  
 PART NO.: **OS260** LENGTH: **13'/4 m** SECTIONS: **2** PACK UNIT: **Any 10**

- Telescopic pole in two sections
- Features an interior lock that secures with a half turn in either direction

### OptiLoc 2 and 3-Section Poles

PART NO.: **EZ120** LENGTH: **4'/1.25 m** SECTIONS: **2** PACK UNIT: **Any 10**  
 PART NO.: **EZ250** LENGTH: **8'/2.5 m** SECTIONS: **2** PACK UNIT: **Any 10**  
 PART NO.: **EZ300** LENGTH: **10'/3 m** SECTIONS: **2** PACK UNIT: **Any 10**  
 PART NO.: **EZ400** LENGTH: **13'/4 m** SECTIONS: **2** PACK UNIT: **Any 10**  
 PART NO.: **ED180** LENGTH: **6'/1.85 m** SECTIONS: **3** PACK UNIT: **Any 10**  
 PART NO.: **ED370** LENGTH: **12'/3.75 m** SECTIONS: **3** PACK UNIT: **Any 10**  
 PART NO.: **ED450** LENGTH: **14'/4.5 m** SECTIONS: **3** PACK UNIT: **Any 10**  
 PART NO.: **ED550** LENGTH: **18'/5.5 m** SECTIONS: **3** PACK UNIT: **Any 10**  
 PART NO.: **ED600** LENGTH: **20'/6 m** SECTIONS: **3** PACK UNIT: **Any 10**  
 PART NO.: **ED750\*** LENGTH: **24'/7.5 m** SECTIONS: **3** PACK UNIT: **Any 10**  
 PART NO.: **ED900\*** LENGTH: **30'/9 m** SECTIONS: **3** PACK UNIT: **Any 10**

- Work safely from the ground with sturdy 2- or 3-section telescopic extension poles
- Constructed of anodized, extruded drawn aluminum with sure grip locking collars and ErgoTec Locking Cone for faster and easier tool change
- Sure Grip Locking Collars and Handle Grip are ergonomically designed for comfort allowing a better grip
- Anti-Slip End Cap helps keep the OptiLoc pole in place when on the ground and protects against damage

### OptiLoc™

- 2- or 3-section telescopic pole available in 13 sizes

### UniTec™

- 2-section telescopic pole, available in three sizes
- Interior lock, 1/2 turn in either direction

### Henry's Handi Handle

- Allows for easier access to hard-to-reach places



## Tool Connections



**Press On**  
Special grooves on the cone ensure a secure fit for the tools.

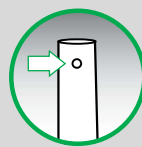

**Snap On**  
These tools snap directly onto Unger telescopic poles.



**Screw On**  
These tools screw onto the ACME thread of an Unger cone.

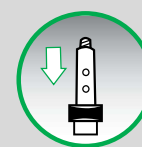

**Lock On**  
Any tool with a hole in the handle and "LOCK" inscribed on it locks onto the ErgoTec Locking Cone preventing the tool from twisting or pulling off the pole during work.

## TelePlus Pole System

A flexible, modular pole system available in 2- or 3-section starter units, with 6-foot extensions. The TelePlus system enables you to easily reach heights from 12 to 30 feet and allows you to only carry the sections you need.

The poles, made of drawn anodized aluminum, are light and can be handled easily and safely, even when assembled, to provide a maximum reach.

### Customize Your System:

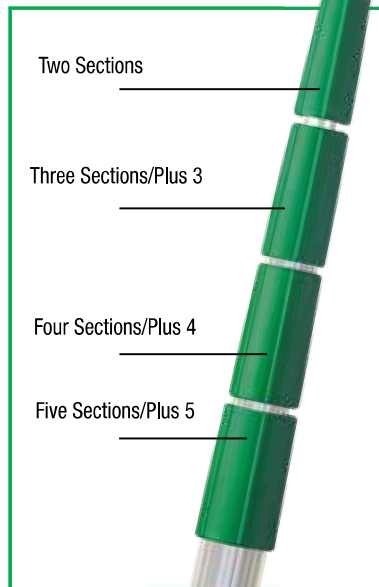
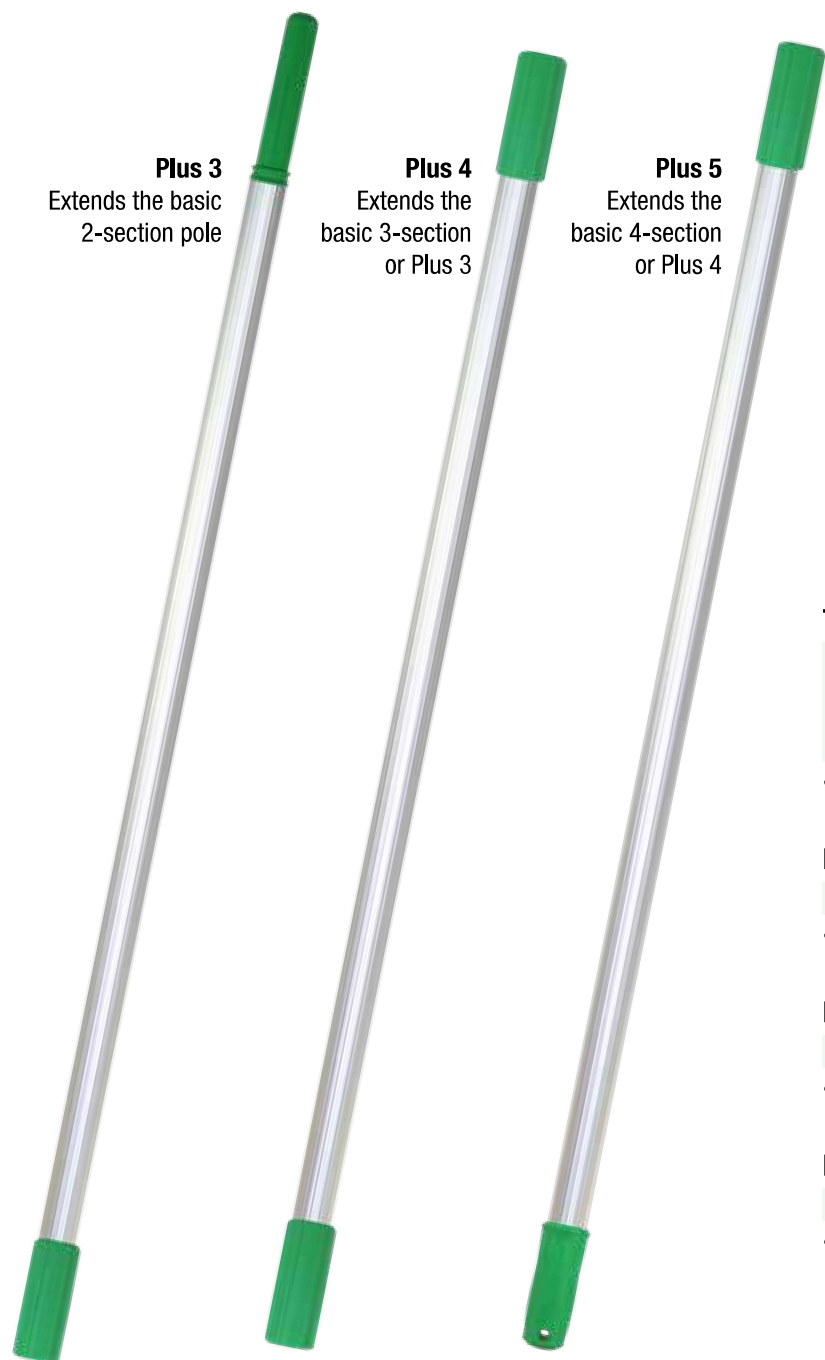

### TelePlus™ 6'/1.85m System

PART NO.: <b>TZ370</b>	LENGTH: <b>12'/3.75 m</b>	SECTIONS: <b>2</b>	PACK UNIT: <b>Any 10</b>
PART NO.: <b>TD550</b>	LENGTH: <b>18'/5.5 m</b>	SECTIONS: <b>3</b>	PACK UNIT: <b>Any 10</b>
PART NO.: <b>TV750</b>	LENGTH: <b>24'/7.4 m</b>	SECTIONS: <b>4</b>	PACK UNIT: <b>Any 10</b>
PART NO.: <b>TF900</b>	LENGTH: <b>30'/9 m</b>	SECTIONS: <b>5</b>	PACK UNIT: <b>Any 10</b>

- Modular Telescopic pole with the ErgoTec Locking Cone

### Plus 3

PART NO.: <b>T3180</b>	LENGTH: <b>6'/1.85 m</b>	SECTIONS: <b>1</b>	PACK UNIT: <b>Any 10</b>
------------------------	--------------------------	--------------------	--------------------------

- 6-foot extensions for 2-section base TelePlus modular pole system

### Plus 4

PART NO.: <b>T4180</b>	LENGTH: <b>6'/1.85 m</b>	SECTIONS: <b>1</b>	PACK UNIT: <b>Any 10</b>
------------------------	--------------------------	--------------------	--------------------------

- 6-foot extensions for 3-section base TelePlus modular pole system

### Plus 5

PART NO.: <b>T5180</b>	LENGTH: <b>6'/1.85 m</b>	SECTIONS: <b>1</b>	PACK UNIT: <b>Any 10</b>
------------------------	--------------------------	--------------------	--------------------------

- 6-foot extensions for 4-section base TelePlus modular pole system

*\*Please confirm freight free minimum with your Customer Service Representative.*

### StarDuster ProFlex

PART NO.: **PXD7G** SIZE: **30"/75 cm** CASE QTY.: **10**

### StarDuster ProFlat

PART NO.: **PFD7G** SIZE: **30"/75 cm** CASE QTY.: **10**

- ProFlex (PXD7G): Bends and retains shape to clean hard-to-reach areas
- ProFlat (PFD7G) retains its shape to slide between tight spaces
- Great for cleaning overhead, underneath furniture, appliances, and around corners
- Microfiber sleeve is removable and machine washable
- Comes with three electrostatic disposable sleeves (wash cycles: 300)

### StarDuster ProFlex/Proflat Sleeves

PART NO.: **PS50W** CONTENTS: **50pk** CASE QTY.: **1**

PART NO.: **PM05W** CONTENTS: **5pk** CASE QTY.: **1**

- PS50W: Disposable, electrostatic replacement sleeves for ProFlex (PXD7G) and ProFlat (PFD7G) dusters
- PM05W microfiber replacement sleeves are machine washable (wash cycles: 300)

### StarDuster Pro Duster

PART NO.: **LWDUR** SIZE: **30" - 60"/70-150 cm** CASE QTY.: **10**

- Telescopic lambswool duster with bendable head and sleeve
- Ideal for dusting in high places
- Disposable duster sleeve attracts and holds dust, keeping it away from workers and fixtures below

### StarDuster Lambswool

PART NO.: **LWDUO** CASE QTY.: **6**

- Perfect for dusting shelves and other surfaces
- Superior cleaning and dust removal
- Duster attaches to any Unger cone or standard ACME thread
- Also use with ProDuster Replacement Sleeves (DS50Y) or microfiber (MMSLG)

### StarDuster Pro Duster/Lambswool Replacement Sleeves

PART NO.: **DS10Y** CONTENTS: **10pk** CASE QTY.: **1**

PART NO.: **DS50Y** CONTENTS: **50pk** CASE QTY.: **1**

- Disposable duster sleeve attracts and holds dust, keeping it away from workers and fixtures below

### StarDuster Pro Ceiling Fan Duster

PART NO.: **CEDUG** CASE QTY.: **5**

- Thick, soft microfiber strands clean all shapes and sizes of ceiling fan blades, and vents
- Microfiber sleeve is removable and machine washable
- Wash Cycles: 300



StarDuster ProFlex



StarDuster ProFlat



StarDuster Pro Duster



StarDuster Pro Ceiling Fan Duster



StarDuster Lambswool



## Tool Connections



**Press On**  
Special grooves on the cone ensure a secure fit for the tools.

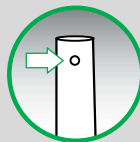

**Snap On**  
These tools snap directly onto Unger telescopic poles.



**Screw On**  
These tools screw onto the ACME thread of an Unger cone.

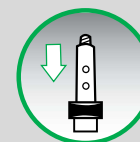

**Lock On**  
Any tool with a hole in the handle and "LOCK" inscribed on it locks onto the ErgoTec® Locking Cone. This prevents the tool from twisting or pulling off the pole during work.



## StarDuster Pipe Brush

PART NO.: PIPE0 CASE QTY.: 5

- Bendable 11"/28 cm curved brush for cleaning pipes and other round surfaces
- Made with heavy-duty wire and polypropylene bristles



## StarDuster Wall Brush

PART NO.: WALBO CASE QTY.: 5

- Oval shape for ceiling fans, walls, and ceilings
- Made of heavy-duty galvanized wire and 49% horsehair bristles
- Ideal for dusting rough surfaces and for removing cobwebs and dust from flat objects



## CobWeb Duster Brush

PART NO.: COBWO CASE QTY.: 6

- Split-tipped soft poly fibers allow for effective dusting without scratching
- Great for dusting ceilings, moldings, and corners inside or outdoors
- Electrostatic energy attracts and holds dust, dirt, and cobwebs



## High Access Dusting Kit

PART NO.: HADK2 CASE QTY.: 1

- PIPE0 StarDuster® Pipe Brush
  - WALBO StarDuster® Wall Brush
  - CEDUG StarDuster® Pro Ceiling Fan Duster
  - PXD7G StarDuster® ProFlex
  - PM50W StarDuster® ProFlex Sleeves (50)
  - COBWO CobWeb Duster Brush
  - NLCLA nLITE® Classic Tool Adapter
- \*Will include attachment to use with Gen 1 or Gen 2 nLITE Poles





### Flood Sucker Bulb Changer

PART NO.: **FS000** CASE QTY.: **5**

- Easily change floodlights and other flat lightbulbs safely from the ground
- Features suction cups that attach to bulb
- Fully insulated
- Snaps onto telescopic poles for changing bulbs in high-access areas



### Sticky Fingers Bulb Changer

PART NO.: **BS010** CASE QTY.: **5**

- Easily change lightbulbs safely from the ground
- Rubber-coated spring steel fingers for quality turning power
- Adjusts to fit various-shaped CFL bulbs
- Snaps onto telescopic poles for changing bulbs in high-access areas

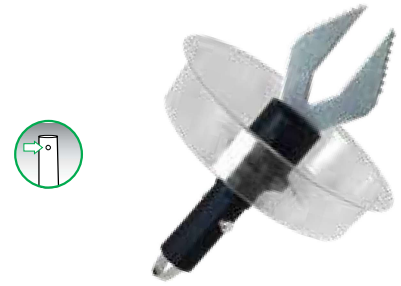

### The Bebbe

PART NO.: **BEBE0** CASE QTY.: **5**

- Safely remove broken lightbulb base from socket
- Complete with plastic tray for catching broken bulb pieces
- Fully insulated
- Snaps onto telescopic poles for changing bulbs in high-access areas

## TOOL ADAPTERS



### ErgoTec Locking Cone

PART NO.: **NCANO** CASE QTY.: **5**

- Securely locks select Unger tools onto pole
- Fast tool change with quick-release button
- Other tools attach by pressing on, snap on, or screw on



### Threaded Wood Cone Adapter

PART NO.: **TWA00** CASE QTY.: **5**

- Wood cone adapter for attaching tools
- Features an internal ACME thread
- Pressure fitted



### Cranked Joint Angle Adapter

PART NO.: **CJA00** THREAD: **Zinc** CASE QTY.: **5**  
 PART NO.: **CJN00** THREAD: **Plastic** CASE QTY.: **5**

- Adjust tools to clean at any angle up to 300°
- Squeegees, washers, etc. quickly attach to adapter
- Available in strong zinc or plastic



### Fixi-Clamp

PART NO.: **FIX10** ITEM: **Fixi-Clamp** CASE QTY.: **5**  
 PART NO.: **SP010** ITEM: **Sponge** CASE QTY.: **10**

- Adjustable plastic clamp firmly holds tools like brushes, sponges, and cloths
- Open cellulose foam sponge is perfect for general cleaning and can be used with Fixi-Clamp
- FIX10 has 3.5"/9 cm max opening

### Soot Master Sponge

PART NO.: **SP060** SIZE: **2" x 3" x 6" / 5 x 7.6 x 15 cm** CASE QTY.: **6**

- Perfect for cleanup after fire or smoke damage
- Dry sponge absorbs dust and soot particles
- Can be cut, if smaller size is required.
- Rinsable rubber material



## Bulb Changing



Aluminum Telescopic Pole

Remove the ErgoTec Locking Cone in order to attach all bulb changing tools.



# ELIMINATE LADDERS AND LIFTS



## Classic Window & High Access Cleaning

## Indoor Window & Glass Cleaning

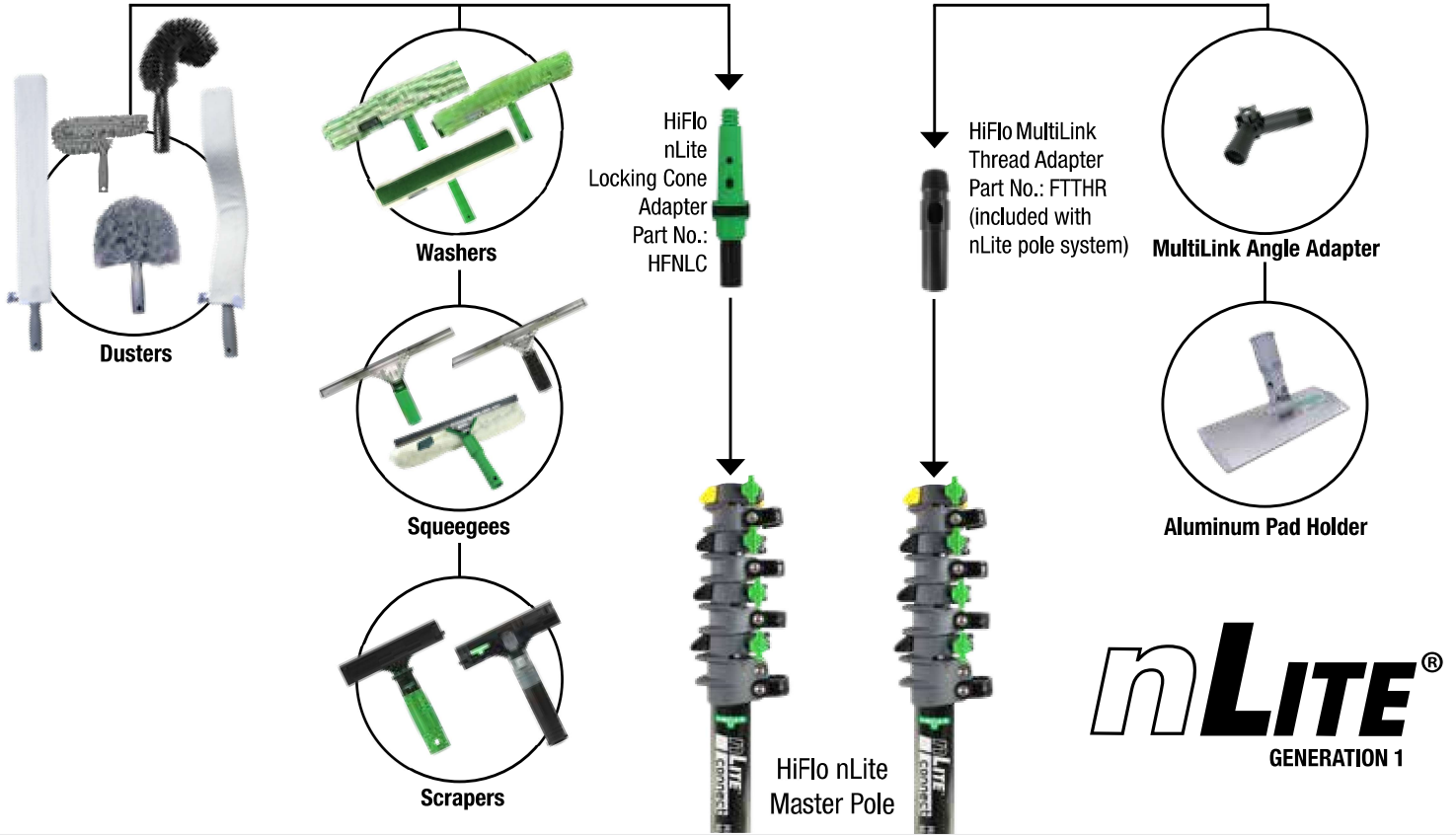

## Classic Window & High Access Cleaning

## Indoor Window & Glass Cleaning

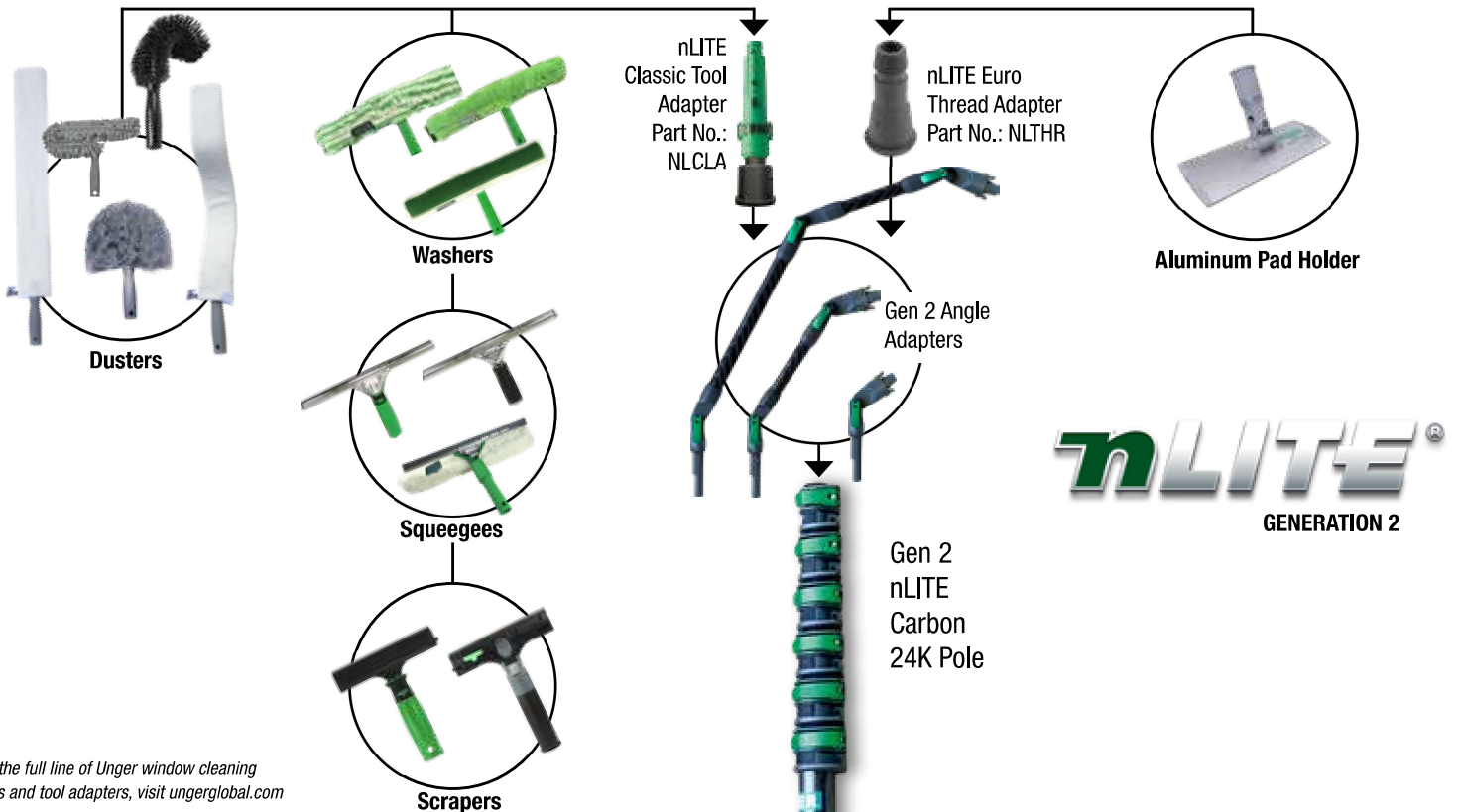

For the full line of Unger window cleaning tools and tool adapters, visit [ungerglobal.com](http://ungerglobal.com)



# SURFACE CLEANING

Whether in schools, restaurants or other public spaces, dirt, debris and virus-laden droplets can remain infectious for several hours on surfaces. Viruses generally remain active longer on stainless steel, plastic and similar hard surfaces, making frequent surface cleaning imperative to limiting the spread of potentially harmful germs.

Unger offers an array of surface, table and desk cleaning tools designed to minimize the spread of infectious diseases by removing impurities before the disinfecting process.



**FEATURED PRODUCT**



**Stingray Refillable  
Microfiber Cleaning Kit 11'**

PART NO.: **SRKB4** CASE QTY: **1**

- Stingray Handheld
- SREPL Extension Pole – Long 4' (2)
- SREPS Extension Pole – Short 2' (1)
- SRPD2 Glass Washing Pad (2)
- SRBT1 Stingray Refillable Bottle (2)

**Clean your indoor windows and table surfaces and keep your cleaning solution contained!**



Scan here for more information.

## STINGRAY MICROFIBER KITS



### Stingray Refillable Microfiber Cleaning Kit Deluxe 11'

PART NO.: **SRKB7** CASE QTY.: **1**

- Stingray Handheld
- SREPL Extension Pole – Long 4' (2)
- SREPS Extension Pole – Short 2' (1)
- SRPD2 Glass Washing Pad (2)
- SRBT1 Stingray Refillable Bottle (2)
- SRBAG Stingray Bag (1)



### Stingray Refillable Microfiber Cleaning Kit 11'

PART NO.: **SRKB4** CASE QTY.: **1**

- Stingray Handheld
- SREPL Extension Pole – Long 4' (2)
- SREPS Extension Pole – Short 2' (1)
- SRPD2 Glass Washing Pad (2)
- SRBT1 Stingray Refillable Bottle (2)



### Stingray Refillable Microfiber Cleaning Kit 5'

PART NO.: **SRKB5** CASE QTY.: **1**

- Stingray Handheld
- SREPL Extension Pole – Long 4' (1)
- SRPD2 Glass Washing Pad (2)
- SRBT1 Stingray Refillable Bottle (2)



### Stingray Refillable Microfiber Cleaning Kit 3'

PART NO.: **SRKB6** CASE QTY.: **1**

- Stingray Handheld
- SREPS Extension Pole Short 2' (1)
- SRPD2 Glass Washing Pad (2)
- SRBT1 Stingray Refillable Bottle (2)

## STINGRAY QUICKPAD KITS

## Stingray Refillable System - More flexible than ever

### REFILLABLE 5 oz BOTTLE

- Can be filled with conventional multi-surface or window and glass cleaners
- Large opening for easy filling: ready to use in seconds

### CLEANING PADS

- Three pad options available: reusable microfiber pads, reusable cleaning pad, and disposable quickpad
- QuikPads: one pad can be used to clean up to 150 SF/13.9 SM
- Microfiber Washing Pad: one pad can be used to clean up to 1,800 SF/167.2 SM
- Microfiber Cleaning Pad: one pad can be used to clean up to 1,800 SF/167.2 SM



### Stingray Refillable System Kit 11'

PART NO.: **SRKB1** CASE QTY.: **1**

- Stingray Handheld
- SREPL Extension Pole – Long 4' (2)
- SREPS Extension Pole – Short 2' (1)
- SRADK QuikPad™ Adapter Kit
- SRBT1 Stingray Refillable Bottle (2)



### Stingray Refillable System Kit 5'

PART NO.: **SRKB2** CASE QTY.: **1**

- Stingray Handheld
- SREPL Extension Pole – Long 4' (1)
- SRADK QuikPad™ Adapter Kit
- SRBT1 Stingray Refillable Bottle (2)



### Stingray Refillable System Kit 3'

PART NO.: **SRKB3** CASE QTY.: **1**

- Stingray Handheld
- SREPS Extension Pole – Short 2' (1)
- SRADK QuikPad™ Adapter Kit
- SRBT1 Stingray Refillable Bottle (2)

## STINGRAY ACCESSORIES



### Stingray Refillable Handheld

PART NO.: **SRHBT** CASE QTY.: **1**

- Perfect tool for cleaning most flat surfaces
- Enclosed spray nozzle prevents chemicals from becoming airborne
- Low profile head cleans frames on the move, minimizing steps
- Triangular handle and pole shape facilitates comfortable grip
- Refillable 5 oz bottle allows you to use your preferred cleaning solution



### Stingray Extension Pole

PART NO.: **SREPL** LENGTH: **4'1.24m** CASE QTY.: **1**  
 PART NO.: **SREPS** LENGTH: **2'0.63m** CASE QTY.: **1**

- Triangular shape for better grip
- Light, rigid aluminum
- Easy-click connection and activation button



### Stingray Carrying Bag

PART NO.: **SRBAG** CASE QTY.: **1**

- Durable bag to safely store and carry your Stingray tools



### Stingray Refillable Bottle

PART NO.: **SRBT1** CASE QTY.: **1**

- Refillable bottle to use with your preferred cleaning chemical
  - 5oz capacity
- For use with Stingray Refillable System (SRHBT)*



### Stingray Glass Cleaning Pad

PART NO.: **SRPD1** CASE QTY.: **5**

- Triangle shape for perfect reach into corners
- Elastic bands for secure fit and easy assembly
- Removes dust, fingerprints, grease, and other light dirt
- Wash Cycles: 200

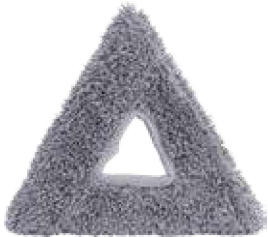

### Stingray Glass Washing Pad

PART NO.: **SRPD2** CASE QTY.: **5**

- Triangle shape for perfect reach into corners
- Elastic bands for secure fit and easy assembly
- Long fibers for removing heavy dirt and grime
- Wash Cycles: 300
- \*Color coding tabs to prevent cross-contamination



### Stingray QuikPad Adapter Kit

PART NO.: **SRADK** CASE QTY.: **1**

- Adapter plate with 25 disposable QuikPads
- Hook & loop Adapter Plate easily snaps on to the Stingray unit to allow use of QuikPads



### Stingray QuikPad – 25pk\*

PART NO.: **SRPD3** CASE QTY.: **1**

- Durable, lasting QuikPads™ clean up to 150 SF/13.9 SM without having to launder pads
- Pads are can be easily replaced for each use

*\*Adapter plate required when using QuikPad*



### Stingray QuikPad – 100pk\*

PART NO.: **SRPD4** CASE QTY.: **1**

- Durable, lasting QuikPads™ clean up to 150 SF/13.9 SM without having to launder pads
- Pads are can be easily replaced for each use

*\*Adapter plate required when using QuikPad*



### SpeedClean™ Starter Kit

PART NO.: **WNK04** CASE QTY.: **4**

- PHH20 Aluminum Pad Holder
- PHW20 Microfiber Washing Pad
- PHL20 Microfiber Cleaning Pad
- AFAET HiFlo Thread Adapter
- EZ120 OptiLoc 2-Section Telescopic Pole - 4'/1.24 m



### SpeedClean Window Kit

PART NO.: **CK053** CASE QTY.: **1**

- SOABG Sprayer On A Belt
- PHH20 Aluminum Pad Holder
- PHW20 (3) Microfiber Washing Pad
- PHL20 (3) Microfiber Cleaning Pad
- AFAET HiFlo Euro Thread Adapter
- ED180 OptiLoc 3-Section Telescopic Pole - 6'/1.8 m



### SpeedClean Window Kit

PART NO.: **CK054** CASE QTY.: **1**

- SOABG Sprayer On A Belt
- PHH20 Aluminum Pad Holder
- PHD20 Handheld Aluminum Pad Holder
- PHW20 (3) Microfiber Washing Pad
- PHL20 (3) Microfiber Cleaning Pad
- AFAET HiFlo Euro Thread Adapter
- ED180 OptiLoc 3-Section Telescopic Pole - 6'/1.8 m

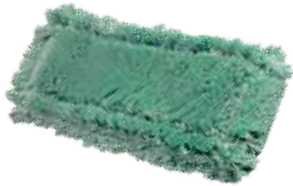

### Microfiber Washing Pad

PART NO.: **PHW20** SIZE: **11.5"/29 cm** CASE QTY.: **5**

- Long fibers for removing heavy dirt and grime
- Best cleaning with minimal drag
- Use with pad holder PHH20 or PHD20
- Wash Cycles: 500



### Microfiber Cleaning Pad

PART NO.: **PHL20** SIZE: **10.5"/27 cm** CASE QTY.: **5**

- Cleans glass with less drag
- Removes dust, fingerprints, grease, and other light dirt from glass
- Use with pad holder PHH20 or PHD20
- Wash Cycles: 100



### Scrub Pad

PART NO.: **OPS20** SIZE: **10"/25 cm** CASE QTY.: **10**

- Special scrub pad for removing tough soils
- Optimal for outdoor cleaning
- Use with pad holder PHH20 or PHD20



### Aluminum Pad Holder

PART NO.: **PHH20** SIZE: **9.5"/24 cm** CASE QTY.: **5**

- Pad holder with swivel head easily glides across windows
- Attach to Unger pole with thread adapter AFAET
- Full coverage hook & loop fastener backing for strong hold of pads



### Handheld Aluminum Pad Holder

PART NO.: **PHD20** SIZE: **9.5"/24 cm** CASE QTY.: **5**

- Perfect hand control and power distribution while cleaning glass with less drag
- Full coverage hook & loop fastener backing for strong hold of pads



### HiFlo Euro Thread Adapter

PART NO.: **AFAET** CASE QTY.: **5**

- Adapter connects aluminum poles to pad holder and other tools with euro thread



### Sprayer On A Belt

PART NO.: **SOABG** CAPACITY: **33oz/1 L** CASE QTY.: **5**

- Sprayer hooks onto belt, providing optimal weight support
- Flexible hose extends 3'/0.9 m for upside-down spraying
- Includes SmartColor™ Decal Kit to customize for designated areas



**Unger Desk and Table Cleaning Kit**

PART NO.: **CK047** CASE QTY.: **1**

- CMOBG SmartColor Dual Bucket - 32 Qt.
- SM40G SmartColor EZ Flat Mop Holder
- HH240 Henry's Handi Handle - 2'
- MD400 SmartColor MicroMop 7.0 - Green (2)

**MicroWipe Grading System**

**Specifications**

**Usage**

**MicroWipe 4000 Heavy Duty**

- Durability\*\*: 4000
- Wash Cycles: 1500
- Scrub Factor\*\*: 38 (Abrasiveness)
- Absorbency\*: 1700 ml or 5.2 oz

- Highest quality superior-grade textile
- Manufactured to withstand heavy-duty commercial washing cycles
- Designed for facilities that clean in multiple shifts and seven days a week
- Cleans industrial soil loads – oils, dry dust, embedded soils
- Extended product life – lower long-term cost
- Maximum absorbency

**MicroWipe 2000 Medium Duty**

- Durability\*\*: 2000
- Wash Cycles: 1000
- Scrub Factor\*\*: 36 (Abrasiveness)
- Absorbency\*: 1400 ml or 4.4 oz

- Medium absorbency for general-purpose cleaning
- Hand or normal wash / dry cycles
- Designed for 5-day-a-week cleaning operations
- Multipurpose surface applications
- Cleans medium-duty soil loads
- Average product life

**MicroWipe 500 Light Duty**

- Durability\*\*: 500
- Wash Cycles: 500
- Scrub Factor\*\*: 34 (Abrasiveness)
- Absorbency\*: 1100 ml or 3.3 oz

- Good choice for daily dusting tasks
- Least aggressive mechanical action
- Shorter product life than medium and heavy-duty wipes

**MicroWipe 200 UltraLite**

- Durability\*\*: 200
- Wash Cycles: 200
- Scrub Factor\*\*: 39 (Abrasiveness)
- Absorbency\*: 1700 ml or 5.2 oz

- Cleans light-duty soil loads
- Dry / damp dusting tasks
- Shortest product life cycle
- Maximum absorbency

\*Standard US Industry Test • \*\*ASTM Tests

**MicroWipe 4000 Heavy Duty**

PART NO. <b>MF40R</b>	COLOR: <b>Red</b>
PART NO. <b>MF40Y</b>	COLOR: <b>Yellow/Red</b>
PART NO. <b>MF40J</b>	COLOR: <b>Yellow</b>
PART NO. <b>MF40G</b>	COLOR: <b>Green</b>
PART NO. <b>MF40B</b>	COLOR: <b>Blue</b>
SIZE: <b>16" x 15"/40 x 38 cm</b>	
WASH CYCLES: <b>1500</b>	CASE QTY.: <b>10</b>

**MicroWipe 2000 Medium Duty**

PART NO. <b>MB40R</b>	COLOR: <b>Red</b>
PART NO. <b>MB40J</b>	COLOR: <b>Yellow</b>
PART NO. <b>MB40G</b>	COLOR: <b>Green</b>
PART NO. <b>MB40B</b>	COLOR: <b>Blue</b>
SIZE: <b>16" x 16"/40 x 40 cm</b>	
WASH CYCLES: <b>1000</b>	CASE QTY.: <b>10</b>

**MicroWipe 500 Light Duty**

PART NO. <b>MC40R</b>	COLOR: <b>Red</b>
PART NO. <b>MC40J</b>	COLOR: <b>Yellow</b>
PART NO. <b>MC40G</b>	COLOR: <b>Green</b>
PART NO. <b>MC40B</b>	COLOR: <b>Blue</b>
SIZE: <b>16" x 16"/40 x 40 cm</b>	
WASH CYCLES: <b>500</b>	CASE QTY.: <b>10</b>

**MicroWipe 200 UltraLite**

PART NO. <b>ME40R</b>	COLOR: <b>Red</b>
PART NO. <b>ME40J</b>	COLOR: <b>Yellow</b>
PART NO. <b>ME40G</b>	COLOR: <b>Green</b>
PART NO. <b>ME40B</b>	COLOR: <b>Blue</b>
SIZE: <b>16" x 16"/40 x 40 cm</b>	
WASH CYCLES: <b>200</b>	CASE QTY.: <b>10</b>



# RESTROOM CLEANING

Unger's restroom cleaning tools produce unparalleled results. You'll find commercial mops, squeegees, sprayers, and brushes of all varieties to suit every restroom cleaning need. Whether your facility requires heavy duty deep cleaning or light daily maintenance, these tools get the job done quickly and efficiently.



## FEATURED PRODUCT



### RestroomR<sub>x</sub> Cleaning Specialist System Complete - 32 Qt.

PART NO.: **RRSPL**

CAPACITY: **32 Qt./30 L**

CASE QTY.: **1**

- RRCRT Cleaning Cart (includes vinyl trash bag, supply module, all tool clips and holders).
- COMBR Dual-Compartment Mop Bucket - 32 Qt./30 L
- SM40R EZ Mop Holder
- EP18R Ergo TelePole Compact - 6'15 cm
- MM40R SmartColor Micro Mop 15.0 - Red
- BBWHR Ergo Toilet Bowl Brush (includes 18369, black base for holder)
- WH180 Easy Adapter Hose
- LWDUR StarDuster Pro Duster with Sleeve
- EDTBR Ergo Dustpan Telescopic
- NN40R NiftyNabber® 18"/45 cm
- NCANR ErgoTec Locking Cone - Red (2)
- CB20G SmartColor Swivel Corner Brush
- SB20G SmartColor Swivel Brush

.....  
**Stay organized and fully equipt  
when using your cleaning cart.**



Scan here for more information.

The best way to clean is with an efficient system, and the Unger RestroomRx is the first janitorial cart developed as a completely coordinated system by cleaning professionals.

Every detail is designed for ergonomics and safety. Tools stay organized and securely fastened in place while moving from job to job.

The Unger RestroomRx streamlined cart systems will enable your custodians to work faster and more productively than ever.

**70%** Savings on Chemical and Water Usage!

► **EASY TO MANEUVER**

The handrail allows you to maneuver the cart in and out of restroom entrances quicker and easier.

► **STAY ORGANIZED**

Every tool in the system has a designated position on the cart. Tools are always where they need to be, and always clipped on securely.

► **LARGE STORAGE**

With an expanded storage module, you'll minimize trips to the supply closet.

► **SMART DESIGN**

The narrow tool tower design allows all tools to remain within the boundaries of the cart. The base of the cart also acts as a drip tray catching excess liquid, so nothing ever drips on restroom or hallway floors.



**SAFETY**

The Ergo Rail eliminates poor posture. No matter which side of the cart you're on, it can be pushed and pulled with ease.

The handrail allows you to maneuver the cart in and out of restroom entrances quicker and easier.

Patented clip system ensures all tools have an identified position on the cart. Tools are securely in place while you are moving down the hall. No bending or reaching to get tools out/off of the cart.

**EFFICIENCY**

The Storage Module eliminates restroom complaints. The effort it takes to return to a supply closet to restock supplies can waste more than just time.

With an expanded storage module, you'll minimize trips to the supply closet. Even eliminating one trip increases productivity.

The patent pending Narrow Tool Tower design allows all tools to remain within the boundaries of the cart. Since no tools hang over the outside edge of the cart, getting through tight doorways is easy.

**CLEANLINESS**

From the Dual Bucket to the Telescopic Dustpan, the tools that comprise the system were developed to deliver optimal productivity and cleaning results.

A patent pending Drip Tray keeps dripping from tools off the floor, and delivers ultimate bucket stability, even when going over curbs or thresholds.

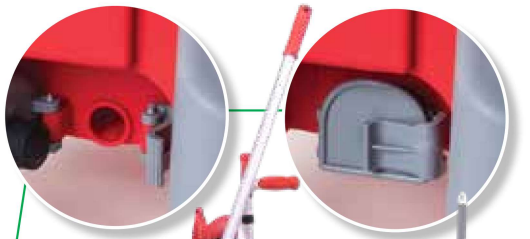

**32qt.**

**RestroomR<sub>x</sub> Cleaning Specialist System Complete - 32 Qt./30 L**

PART NO.: **RRSPL** CAPACITY: **32 Qt./30 L** CASE QTY.: **1**

- RRCRT Cleaning Cart (includes vinyl trash bag, supply module, all tool clips and holders).
- COMBR Dual-Compartment Mop Bucket - 32 Qt./30 L
- SM40R EZ Mop Holder
- EP18R Ergo TelePole Compact - 6'/1.8 m
- MM40R SmartColor Micro Mop 15.0 - Red
- BBWHR Ergo Toilet Bowl Brush (includes 18369, black base for holder)
- WH180 Easy Adapter Hose
- LWDUR StarDuster Pro Duster with Sleeve
- EDTBR Ergo Dustpan Telescopic
- NN40R NiftyNabber Red Pro 20"/52 cm
- NCANR ErgoTec Locking Cone - Red (2)
- CB20G SmartColor Swivel Corner Brush
- SB20G SmartColor Swivel Brush



**16qt.**

**RestroomR<sub>x</sub> Cleaning Specialist System Complete - 16 Qt./15 L**

PART NO.: **RRSPC** CAPACITY: **16 Qt./15 L** CASE QTY.: **1**

- RRCRT Cleaning Cart (includes vinyl trash bag, supply module, all tool clips and holders).
- COMSR Dual-Compartment Mop Bucket - 16 Qt./15 L
- SM40R EZ Mop Holder
- EP18R Ergo TelePole Compact - 6'/1.8 m
- MM40R SmartColor Micro Mop 15.0 - Red
- BBWHR Ergo Toilet Bowl Brush (includes 18369, black base for holder)
- WH180 Easy Adapter Hose
- LWDUR StarDuster Pro Duster with Sleeve
- EDTBR Ergo Dustpan Telescopic
- NN40R NiftyNabber Red Pro 20"/52 cm
- NCANR ErgoTec Locking Cone - Red (2)
- CB20G SmartColor Swivel Corner Brush
- SB20G SmartColor Swivel Brush



**Unger Double Supply Cleaning Cart**

PART NO.: **RRBSC** CASE QTY.: **1**

- Tool clips and holders
- Vinyl Supply Module



**Unger Standard Cleaning Cart**

PART NO.: **RRCRT** CASE QTY.: **1**

- Tool clips and holders
- Vinyl Trash Bag



### Pro Restroom Cleaning Kit - Flat Mop

PART NO.: **RRPRO** CAPACITY: **32 Qt./30 L** CASE QTY: **1**

- COMBR Dual Bucket - 32 Qt./30 L
- MS14G Knock Down Mop Handle
- BBWHR Ergo Toilet Bowl Brush - Complete
- SOABG Sprayer On A Belt
- MF40R SmartColor MicroWipe (5)
- MM40R Micro Mop 15.0
- SM40R EZ Flat Mop Holder
- Training material



### Restroom Floor Pack

PART NO.: **SMFPR** CAPACITY: **32 Qt./30 L** CASE QTY: **1**

- COMBR Dual Bucket - 32 Qt./30 L
- MM40R SmartColor Micro Mop
- SM40R EZ Flat Mop Holder
- EP24R Ergo TelePole - 8'2.4 m



### Restroom Complete Mop Pack

PART NO.: **SMCMR** CASE QTY: **1**

- MM40R SmartColor Micro Mop
- SM40R EZ Flat Mop Holder
- EP24R Ergo TelePole - 8'2.4 m



### Ergo Dustpan

PART NO.: **EDPBR** COLOR: **Red**  
 SIZE: **33" x 12"/83 x 30 cm** CASE QTY: **6**

- For quick removal of debris without bending
- Ergonomic handle minimizes hand and wrist strain
- Broom attaches to dustpan handle for easy storage and retrieval
- Swivel dustpan opens when base hits floor and collapses without spilling its contents



Telescopic Broom

Telescopic Dustpan

### SmartColor/Restroom Ergo Dustpan Telescopic

PART NO.: **EDTBG** COLOR: **Gray** SIZE: **45" x 12"/114 x 30 cm** CASE QTY: **6**  
 PART NO.: **EDTBR** COLOR: **Red** SIZE: **45" x 12"/114 x 30 cm** CASE QTY: **6**

- For quick removal of debris without bending
- Telescopic feature allows adjustable handles to be raised up to 10"/25 cm to accommodate worker's height
- Ergonomic handle minimizes hand and wrist strain
- Broom attaches to dustpan handle for easy storage and retrieval
- Swivel dustpan opens when base hits floor and collapses without spilling its contents



**SmartColor Washer 15.0 Red**

PART NO.: **NS45R** VERSION: **Sleeve**  
 SIZE: **18"/45 cm** CASE QTY.: **10**

- Microfiber sleeve for cleaning restroom mirrors, stalls, and walls
- Long-lasting, durable, 15.0 mm pile can penetrate small surfaces and remove dirt
- Absorbs up to six times its own weight of quick liquid pickup
- For use with 18" T-Bars, sold separately

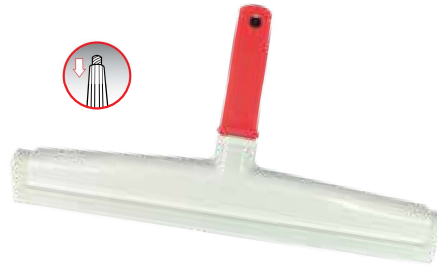

**Ergo Wall Squeegee**

PART NO.: **EW35R** SIZE: **14"/35 cm** CASE QTY.: **10**

- Dry or remove cleaning solutions in one quick step
- White, non-marking moss rubber is ideal for drying grout lines
- T-bar material made of acid-proof polypropylene
- Ergonomic handle can attach to Ergo TelePole (EP24R) or Ergo Pole (HH13R)



**ErgoTec Squeegee**

PART NO.: **ES35R** VERSION: **Complete**  
 SIZE: **14"/35 cm** CASE QTY.: **10**  
 PART NO.: **NE350** VERSION: **Channel & Rubber**  
 SIZE: **14"/35 cm** CASE QTY.: **10**

- Ergonomic squeegee for restroom mirrors and smooth surfaces
- Ergonomic, two-component handle offers a comfortable hold without stress or strain
- Features a stainless steel "S" channel for quick rubber replacement
- ErgoTec Soft Rubber blade offers professional cleaning results

**Ergo Toilet Bowl Brush Complete**

PART NO.: **BBWHR** CASE QTY.: **5**  
 CONTENTS: **Handle, Holder and Two Brush Heads**  
 PART NO.: **BSWHR** CASE QTY.: **5**  
 CONTENTS: **Handle, Holder and Two Swab Heads**

- Ergonomic toilet brush/swab featuring a 26"/66 cm handle for improved worker safety
- Longer handle means no bending
- Hygienic, ergonomic holder is lightweight and keeps bacteria isolated
- Holder can be hand-carried or hung on cart and features a detachable base for easy emptying

**Ergo Toilet Bowl Brush Handle**

PART NO.: **BBCOR** CASE QTY.: **5**  
 CONTENTS: **Handle with Two Brush Heads**  
 PART NO.: **BSCOR** CASE QTY.: **5**  
 CONTENTS: **Handle with Two Swab Heads**

- Increased productivity with 26"/66 cm long handle and replaceable brush heads that provide a 360° cleaning surface
- Nylon bristle heads dry quickly
- Bowl cleaner can be applied directly to swab inside bowl for effective cleaning



**NiftyNabber**

PART NO.: **NN40R** SIZE: **18"/45cm** CASE QTY.: **5**

- The hygienic all-purpose grabber
- Keeps hands away from debris with its 18"/45 cm long handle
- Ergonomically designed grip with smooth trigger-pull action for increased comfort and efficiency
- Access hard-to-reach areas or items with 360° rotating head
- Magnetic tip for picking up metal objects

**Ergo Toilet Bowl Brush Replacement Heads**

PART NO.: **BBRHR** CASE QTY.: **5**  
 CONTENTS: **2 Brush Heads**  
 PART NO.: **BSRHR** CASE QTY.: **5**  
 CONTENTS: **2 Swab Heads**



Toilet Brush



Toilet Swab





# FLOOR CARE

Traditional floor mopping systems lack the ability to truly clean given their outdated design features, leaving dirt and infectious germs behind that work against your efforts to produce a cleaner facility. At Unger, we create groundbreaking innovations in floor care, including commercial floor cleaning and floor finishing solutions designed to meet the unique needs of your facility and specific cleaning procedures.

Our comprehensive selection of floor maintenance equipment supports the cleaning of all hard surfaces, including hardwood, vinyl, porcelain, ceramic tile and more.



**FEATURED PRODUCT**

**Unger OmniClean Dual Bucket Kit**

PART NO.: **CLBK1** CASE QTY: **1**

- Straight Pole with Clip
- Pad Holder
- Microfiber Pads (2)
- SmartColor Rectangular Labels (2)
- Carriage with Wringer
- Gray Bucket - 1.5 gal/5.7 L (2)
- Blue StayClean Guide
- Gray Scrub Board
- Gray Bucket Handle
- Blue StayClean Bucket Handle
- Offset Carriage Handle
- Casters (4)

**Clean your facilities floors  
faster and safer!**



Scan here for more information.



OmniClean features dual bucket technology to separate clean and dirty water, ensuring the StayClean bucket is always clean.

# Never Clean with Dirty Water Again

Stand-Up Wringer

Soil-Catching Bucket

StayClean Bucket



Scan here for more information.



### Unger OmniClean Dual Bucket Kit

PART NO.: **CLBK1** CASE QTY.: **1**

Included in this kit is an Excella Straight Pole with storage clip.

- Straight Pole with Clip
- Pad Holder
- Microfiber Pads (2)
- SmartColor Rectangular Labels (2)
- Carriage with Wringer
- Gray Bucket - 1.5 gal/5.7 L (2)
- Blue StayClean Guide
- Gray Scrub Board
- Gray Bucket Handle
- Blue StayClean Bucket Handle
- Offset Carriage Handle
- Casters (4)



### Unger OmniClean Spot Kit

PART NO.: **CLSPK** CASE QTY.: **1**

This spot kit includes multiple storage areas, a bottle on board for desired cleaning solution, and a clip system to secure cleaning accessories.

- Offset Pole with Actuator
- Small Bottle 17 oz/0.5 L
- Large Bottle 34 oz/1 L
- Pad Holder
- Microfiber Pads (2)
- DustPan Telescopic gray
- SmartColor Rectangular Labels (2)
- Carriage with Wringer
- Gray Bucket - 1.5 gal./5.7 L
- Gray Scrub Board
- Offset Carriage Handle
- Gray Bucket Handle
- Excella Bottle Holder Clip
- DustPan Holder Clip
- Storage Bins (2)
- Storage Caddy
- Excella Clip
- Casters (4)



### Unger OmniClean Dual Bucket Kit - Offset

PART NO.: **CLBK2** CASE QTY.: **1**

Included in this kit is an Excella Offset Pole for ergonomic floor mopping.

- Offset Pole
- Pad Holder
- Microfiber Pads (2)
- SmartColor Rectangular Labels (2)
- Carriage with Wringer
- Gray Bucket - 1.5 gal/5.7 L (2)
- Blue StayClean Guide
- Gray Scrub Board
- Gray Bucket Handle
- Blue StayClean Bucket Handle
- Offset Carriage Handle
- Casters (4)



### Unger OmniClean Restroom Kit

PART NO.: **CLRRK** CASE QTY.: **1**

This restroom kit includes multiple storage areas, a bottle on board for desired cleaning solution, Restroom cleaning tools and is color coded for SmartColor Cleaning.

- Offset Pole with Actuator
- Small Bottle 17 oz/0.5 L
- Large Bottle 34 oz/1 L
- Pad Holder
- Microfiber Pads (2)
- DustPan Telescopic red
- Toilet Brush Handle w/ 2 brush heads
- NiftyNabber Red 20"/52 cm
- SmartColor Rectangular Labels (2)
- Carriage with Wringer
- Gray Bucket - 1.5 gal/5.7 L
- Gray Scrub Board
- Offset Carriage Handle
- Red Bucket Handle
- Excella Bottle Holder Clip
- DustPan Holder Clip
- Toilet Brush Holder Clip
- Nifty Nabber Holder Clip
- Storage Caddy
- Excella Clip
- Casters (4)





### OmniClean Microfiber Pad (5)

PART NO.: CLMFP SIZE: 16"/40 cm CASE QTY: 1

- Microfiber pad specifically designed for use with the OmniClean system
- Made of durable 100% polyester microfiber with a 7 mm looped pile
- Color coding tabs to prevent cross-contamination
- Wash cycle: 300



### OmniClean Mop Pad Holder

PART NO.: CLMPH SIZE: 16"/40 cm CASE QTY: 1



### Unger Excella Straight Pole OmniClean

PART NO.: CLEF1 CASE QTY: 1

- Telescopic offset pole with adjustable height 45"-60" (114 - 152 cm)
- Rubber coated non slip grips reduces stress and repetitive motion strains while mopping
- Added clip to hang the pole on the OmniClean carriage

Visit pages 52-53 to view additional poles compatible with OmniClean System.

## ADVANCED FLOOR CARE KITS DESIGN FEATURES

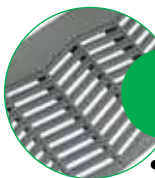

### Scrub Board Bucket

- Removes larger dirt particles from microfiber mop pad before placing in wringer.



### Dirty Water Bucket

- Separated dirty water bucket for all debris and dirt particles.



### Clean Charge Bucket

- Contains a constant supply of fresh cleaning solution. Splash-free guide minimizes spills during transport.



### Ergonomic Handle

- Adjustable height pole with bottle on board provides a constant supply of fresh cleaning agent. Dual swivel handles included with some kits.

### Innovative Wringer

- Agitates remaining debris from microfiber mop pad resulting in cleaner water and better cleaning performance.



# THE NEW BENCHMARK IN SAFETY, SPEED, AND EFFICIENCY.



## EXCELLA STARTER KITS

### Unger Excella Floor Cleaning Kit allows you to:

- Achieve a healthier level of clean with a microfiber-based mopping system
- Ease back-breaking work with an innovative ergonomic design
- Increase cleaning speed with a self-steering pole and the elimination of buckets
- Clean a variety of spaces with enhanced system portability and size options



**Unger Excella Starter Kit 18''/45 cm**

PART NO.: **EFHC1** CASE QTY.: **1**

- EFPL1 Offset Pole with Actuator
- EF40B Mop Pad Holder 18''/45 cm
- EFBTL Large Bottle - 34 oz/1 L



**Unger Excella Starter Straight Kit 18''/45 cm**

PART NO.: **EFHC2** CASE QTY.: **1**

- EFPL4 Straight Pole with Actuator
- EF40B Mop Pad Holder 18''/45 cm
- EFBTL Large Bottle - 34 oz/1 L

## EXCELLA FLOOR CLEANING KITS



**Unger Excella Floor Cleaning Kit 18''/45 cm**

PART NO.: **EFKT1** CASE QTY.: **1**

- EFPL1 Offset Pole with Actuator
- EF40B Mop Pad Holder 18''/45 cm
- EF40M Cleaning Pad 20''/51 cm (2)
- EFBTL Large Bottle - 34 oz/1 L
- EFBTS Small Bottle - 17 oz/0.5 L



**Unger Excella Floor Cleaning Straight Kit 18''/45 cm**

PART NO.: **EFKT8** CASE QTY.: **1**

- EFPL4 Straight Pole with Actuator
- EF40B Mop Pad Holder 18''/45 cm
- EF40M Cleaning Pad 20''/51 cm (2)
- EFBTL Large Bottle - 34 oz/1 L
- EFBTS Small Bottle - 17 oz/0.5 L



**Unger Excella Floor Cleaning Kit 24''/60 cm**

PART NO.: **EFKT2** CASE QTY.: **1**

- EFPL1 Offset Pole with Actuator
- EF60B Mop Pad Holder 24''/60 cm
- EF60M Cleaning Pad 26''/66 cm (2)
- EFBTL Large Bottle - 34 oz/1 L
- EFBTS Small Bottle - 17 oz/0.5 L

## EXCELLA FLOOR FINISHING KITS



**Unger Excella  
Floor Finishing Kit 18"/45 cm**

PART NO.: **EFKT3** CASE QTY.: **1**

- EFPL1 Offset Pole with Actuator
- EF40B Mop Pad Holder – 18"/45 cm
- EF40F Finishing Pad – 20"/51 cm (3)
- EFBTL Large Bottle – 34 oz/1 L
- EFBTS Small Bottle – 17 oz/0.5 L
- EFBAP Backpack Complete – 1.3 gal/5 L



**Unger Excella  
Floor Finishing Straight Kit 18"/45 cm**

PART NO.: **EFKT9** CASE QTY.: **1**

- EFPL4 Straight Pole with Actuator
- EF40B Mop Pad Holder – 18"/45 cm
- EF40F Finishing Pad – 20"/51 cm (3)
- EFBTL Large Bottle – 34 oz/1 L
- EFBTS Small Bottle – 17 oz/0.5 L
- EFBAP Backpack Complete – 1.3 gal/5 L



**Unger Excella  
Floor Finishing Kit 24"/60 cm**

PART NO.: **EFKT4** CASE QTY.: **1**

- EFPL1 Offset Pole with Actuator
- EF60B Mop Pad Holder – 24"/60 cm
- EF60F Finishing Pad – 26"/66 cm (3)
- EFBTL Large Bottle – 34 oz/1 L
- EFBTS Small Bottle – 17 oz/0.5 L
- EFBAP Backpack Complete – 1.3 gal/5 L

## EXCELLA POCKET MOP KITS



**Unger Excella Floor  
Cleaning Mop Pack**

PART NO.: **EFKT6** CASE QTY.: **1**

- EFPL2 Offset Pole
- EFPMH Pocket Mop Holder – 16"/40 cm



**Unger Excella Floor  
Cleaning Pocket Mop Kit**

PART NO.: **EFKT5** CASE QTY.: **1**

- EFPL1 Offset Pole with Actuator
- EFPMH Pocket Mop Holder – 16"/40 cm
- EFPMM Pocket Mop – 16"/40 cm (2)
- EFBTL Large Bottle – 34 oz/1 L
- EFBTS Small Bottle – 17 oz/0.5 L



**Unger Excella Floor  
Cleaning Bucket Pack**

PART NO.: **EFKT7** CASE QTY.: **1**

- EFPL2 Offset Pole
  - EFPMH Pocket Mop Holder – 16"/40 cm
  - COMBG SmartColor™ Dual Bucket – 2 Qt./30 L
- For use with SmartColor Micro/Damp mop pads*



## EXCELLA POLES



**Unger Excella Offset Pole with Actuator**

PART NO.: EFPL1 HANDLE: Offset CASE QTY.: 1

**Unger Excella Straight Pole with Actuator**

PART NO.: EFPL4 HANDLE: Straight CASE QTY.: 1



**Unger Excella Offset Pole**

PART NO.: EFPL2 HANDLE: Offset CASE QTY.: 1

**Unger Excella Straight Pole**

PART NO.: EFPL3 HANDLE: Straight CASE QTY.: 1

## EXCELLA MOP PAD HOLDERS



**Unger Excella Mop Holder**

PART NO.: EF40B SIZE: 18"/45 cm CASE QTY.: 5  
PART NO.: EF60B SIZE: 24"/60 cm CASE QTY.: 5



**Unger Excella Pocket Mop Holder**

PART NO.: EFPMH SIZE: 16"/40 cm CASE QTY.: 5

## EXCELLA MOP PADS



**Unger Excella Cleaning Pad**

PART NO.: EF40M SIZE: 20"/51 cm CASE QTY.: 5  
PART NO.: EF60M SIZE: 26"/66 cm CASE QTY.: 5

- Microfiber pad made of durable 100% polyester microfiber with a 10mm looped pile
- Color coding tabs to prevent cross-contamination
- Hook and loop backing securely attach to Unger Excella Mop Pad Holder
- Wash cycles: 300



**Unger Excella Restroom Cleaning Pad**

PART NO.: EF40R SIZE: 20"/51 cm CASE QTY.: 5

- Microfiber pad made of durable 100% polyester microfiber with a 10mm looped pile
- Color coding tabs to prevent cross-contamination
- Hook and loop backing securely attach to Unger Excella Mop Pad Holder
- Wash cycles: 300



**Unger Excella Pocket Mop**

PART NO.: EFPMM SIZE: 16"/40 cm CASE QTY.: 5

- Microfiber pad made of durable 100% polyester microfiber with a 10mm looped pile
- Color coding tabs to prevent cross-contamination
- Stitched pockets securely attach to pocket mop holder
- Wash cycles: 300



**Unger Excella Micro Mop 10.0**

PART NO.: EFPMG SIZE: 16"/40 cm CASE QTY.: 5

- 10mm looped pile cleaning pad with maximum gliding ability and great dirt absorption
- Made of durable 100% polyester microfiber
- Color coding tabs to prevent cross-contamination
- For use with Mop Holder SM40G/R & EFPMMH
- Wash Cycles: 300

## EXCELLA FLOOR ACCESSORIES



**Unger Excella Finishing Pad**

PART NO.: EF40F SIZE: 20"/51 cm CASE QTY.: 5  
PART NO.: EF60F SIZE: 26"/66 cm CASE QTY.: 5

- Finishing pad with lint-free material
- Evenly distributes floor finishing product
- Wash cycle: 300



**Unger Excella Bottles**

PART NO.: EFBTS SIZE: 17 oz/0.5 L CASE QTY.: 6  
PART NO.: EFBTL SIZE: 34 oz/1 L CASE QTY.: 6

- High precision dispensing mechanism and nozzle
- Refillable bottle with filling level measurement guide
- No clogging or flushing required
- Compatible with EFPL1 & EFPL4



**Unger Excella Backpack Complete**

PART NO.: EFBAP SIZE: 1.3 gal/5 L CASE QTY.: 1

- Backpack with soft and thick shoulder straps for comfort
- Integrated waist belt for a secure fit
- Includes a 1.3 gal/5 L refillable pouch, hose, and nozzle assembly



# DUAL BUCKET SYSTEM

## INCREASE PRODUCTIVITY & IMPROVE HYGIENE

The Unger Dual Bucket System sets the standard for cleaning efficiency and hygiene.

Its many distinctive ergonomic design features enhance worker productivity, reduce injuries, and increased cleaning performance.

- **Separate Cleaning Solution from Soiled Rinse Water**
- **Prevent Cross-Contamination**
- **Save on Water and Chemicals**
- **Up to 63% Lighter when Full**
- **Mounts on all Standard Cleaning Carts**
- **Casters Removable for Additional Stability**
- **Two 4-Gallon Capacity Compartments**
- **Additional Cleaning Tools can be Stored on Front Handle or in Optional Side Bucket**



Immerse mop in front compartment for fresh cleaning solution

Wring and rinse soiled mop in rear compartment to release dirt

## Microfiber Flat Mops vs. Cotton String Mops

Black light experiment reveals the advantages of using microfiber flat mops vs. cotton string mops



VS.

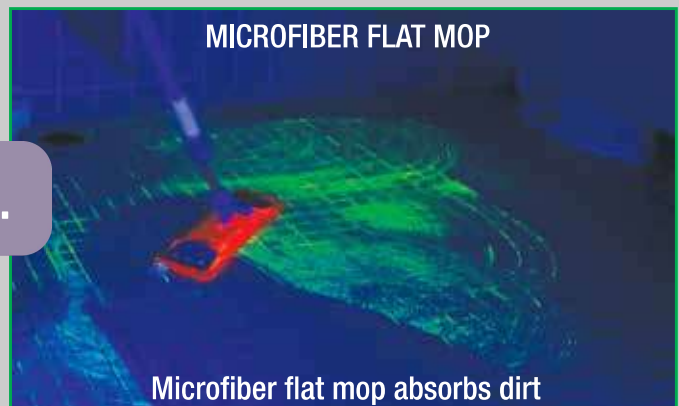

# SmartColor Cleaning System

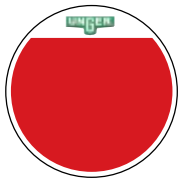
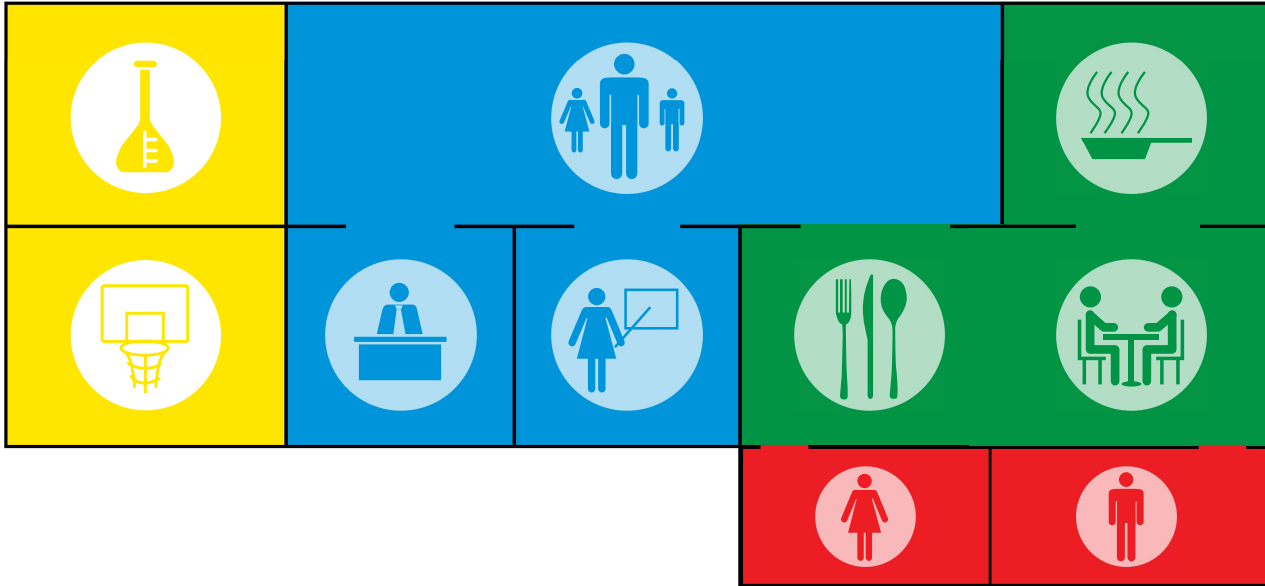

Restrooms  
High Bacteria Areas

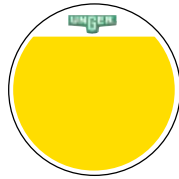

Speciality Areas  
Laboratories  
Gymnasiums

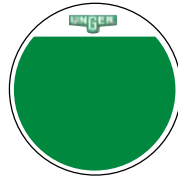

Break Rooms  
Kitchens  
Food Service Areas

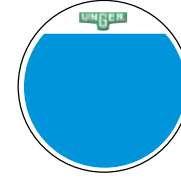

General Areas  
Low-Risk Bacteria Areas  
Offices/Lobbies/Classrooms

## THE ADVANTAGES OF COLOR-CODING:

Improves Training and Communication • Prevents Cross-Contamination

Enhances Building Safety • Deters Chemical Misuse

Simplifies Supply Management • Elevates Employee Performance

Every facility is unique, which is why the Unger SmartColor Cleaning System is the first visual coding system designed to adapt to the specific, and changing, needs of your business. As your building's footprint grows or personnel needs fluctuate, SmartColor will keep your business ahead of all its cleaning demands.

SmartColor achieves its distinct color-coding through interchangeable features and durable metallic decals. This gives you the flexibility to easily retask tools for different areas or functions as required.

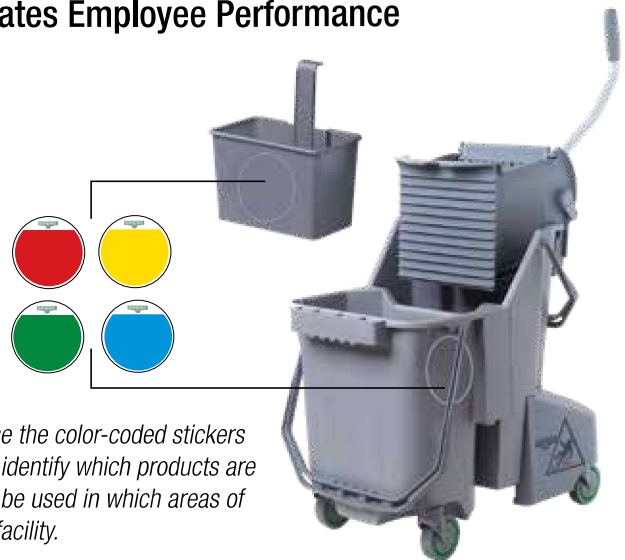

### Unger Dual-Bucket Cleaning System

Hygiene is a priority, so Unger designed a dual-compartment bucket, isolating dirt and maximizing usage of cleaning solution.

#### SmartColor Floor Cleaning Kit - 32 Qt./30 L

- Convenient floor care set, perfect for professional floor care
- Includes SmartColor Decal Kit to customize for designated areas or tasks

PART NO.: **FMK01** CAPACITY: **32 Qt./30 L** CASE QTY.: **1**

- COMBG SmartColor Dual Bucket - 32 Qt./30 L
- MS14G Mop Handle 140 KD
- SM40G SmartColor EZ Flat Mop Holder
- MM40R SmartColor Micro Mop 15.0 Red
- MD40B SmartColor MicroMop 7.0 Blue
- BBWHR Ergo Toilet Bowl Brush w/Holder
- MF40B MicroWipe Heavy Duty Blue (5)
- MF40R MicroWipe Heavy Duty Red (5)



#### SmartColor Floor Pack - 32 Qt./30 L

- Convenient floor care starter set
- Select a microfiber flat mop from Unger's wide range of products (not included)
- Includes SmartColor Decal Kit to customize for designated areas or tasks

PART NO.: **SCFPG** CAPACITY: **32 Qt./30 L** CASE QTY.: **1**

- COMBG SmartColor Dual Bucket - 32 Qt./30 L
- EZ25G SmartColor Tele-Pole 250
- SM40G SmartColor EZ Flat Mop Holder



#### SmartColor Dual Bucket - 32 Qt./30 L

PART NO.: **COMBG** CASE QTY.: **1**  
 CAPACITY: **32 Qt./30 L** COLOR: **Gray**  
 PART NO.: **COMBR** CASE QTY.: **1**  
 CAPACITY: **32 Qt./30 L** COLOR: **Red**

- Dual-compartment bucket system that separates clean and dirty water
- Empty using a rear-mounted dump spout or quick-release drain spout
- Easy-to-read fill guide for accurate chemical dilution

#### SmartColor Dual Bucket - 16 Qt./15 L

PART NO.: **COMSG** CASE QTY.: **1**  
 CAPACITY: **16 Qt./15 L** COLOR: **Gray**  
 PART NO.: **COMSR** CASE QTY.: **1**  
 CAPACITY: **16 Qt./15 L** COLOR: **Red**

- Dual-compartment bucket system that separates clean and dirty water
- Easy-to-read fill guide for accurate chemical dilution
- Ideal for smaller spaces, limited storage areas, and stairs



#### SmartColor Side Bucket

PART NO.: **SMSBG** SIZE: **8.75"/22 cm** CASE QTY.: **1**

- Additional storage snaps onto side of SmartColor Dual Bucket - 32 Qt./30 L
- Includes SmartColor Decal Kit to customize for designated areas or tasks

#### Easy Adapter Hose

PART NO.: **WH180** SIZE: **8"/180 cm** CASE QTY.: **10**

- Fits onto standard faucet for easy bucket filling
- Hose remains firmly in place, will not detach from faucet





# Floor Mopping

Keep floors cleaner and safer than ever with Unger's selection of floor cleaning tools. Choose from a wide selection of microfiber flat mops, pads, and string mops that can handle even the toughest jobs.

To get the most out of a microfiber mop, begin by outlining the space to be cleaned. Then, starting in the corner furthest from the exit, walk backwards creating an overlapping "S" motion with the mop. Adjusting the height of the mop to the individual user is important to avoid strain and maintain proper form.

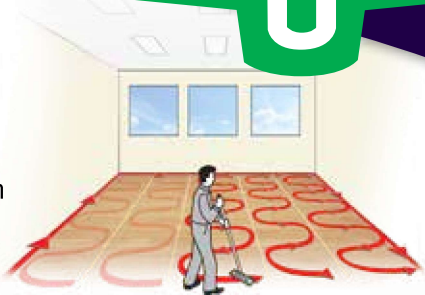

## PRODUCT GUIDE - FLOOR CLEANING - WET MOPPING

Our product guide below will help you to identify the best set of tools for keeping your floor clean.

Mops / Pads	Ceramic Tiles	Natural Stone (Granite, Marble, Slate)	Flexible Coverings (Linoleum, PVC/Vinyl, Rubber)	Laminate	Parquet / Wood	Cork	Concrete/Cement	Epoxy Covering	Mop Holders	Double Buckets
<b>Excella mops</b> Pocket Mop  MicroMop	✓	✓	Tiles/Sheet	✓	Sealed*		✓	✓	Excella Pocket Mop Holder	SmartColor Dual Buckets
<b>SmartColor SPILL MOP 1 I</b> 	✓						Sealed*	✓*	SmartColor EZ Flat Mop Holder	
<b>SmartColor MICRO MOP 15.0</b> 	✓		Sheet				Sealed*	✓*		
<b>SmartColor MICRO MOP 7.0</b> 			Sheet		Sealed		Sealed	✓*		
<b>SmartColor RoughMop ST30</b> 		✓	Tiles	✓*	Sealed*		Sealed*	✓*	SmartColor String Mop Holder	
<b>SmartColor RoughMop ST45</b> 	✓		Sheet				Sealed*			
<b>Excella Cleaning Pad</b> 	✓	✓	Sheet	✓	Sealed*		✓	✓	Excella Mop Pad Holder	
<b>Disposable Pad Mops</b> 	✓	✓	Tiles/Sheet	✓	Sealed	✓	Sealed	✓	SmartColor Damp Mop Pad Holder	
<b>SmartColor Scrub Mop Pad</b> 	✓	✓	Tiles/Sheet	✓	Sealed		Sealed	✓		
<b>OmniClean Microfiber Pad</b> 	✓	✓	Tiles/Sheet	✓	Sealed		Sealed	✓	OmniClean Mop Pad Holder	OmniClean

This information provided in this chart is for guidance only.  
 \*To clean wooden floors for sealed surfaces, use damp or dry mop.



### SmartColor Micro Mop - 15.0

PART NO.:	<b>MM40R</b>	COLOR:	<b>Red</b>	SIZE:	<b>16"/40 cm</b>	CASE QTY.:	<b>5</b>
PART NO.:	<b>MM40Y</b>	COLOR:	<b>Yellow</b>	SIZE:	<b>16"/40 cm</b>	CASE QTY.:	<b>5</b>
PART NO.:	<b>MM40G</b>	COLOR:	<b>Green</b>	SIZE:	<b>16"/40 cm</b>	CASE QTY.:	<b>5</b>
PART NO.:	<b>MM40B</b>	COLOR:	<b>Blue</b>	SIZE:	<b>16"/40 cm</b>	CASE QTY.:	<b>5</b>

- Heavy-duty 15 mm pile microfiber for stone and tile floors with grout lines
- Features aggressive cleaning edges that clean with less water, less effort
- For use with Mop Holder SM40G/R & EFPMH
- Wash Cycles: 500



### Unger Excella Micro Mop 10.0

PART NO.:	<b>EFPMG</b>	COLOR:	<b>Gray</b>	SIZE:	<b>16"/40 cm</b>	CASE QTY.:	<b>5</b>
-----------	--------------	--------	-------------	-------	------------------	------------	----------

- 10mm looped pile cleaning pad with maximum gliding ability and great dirt absorption
- Made of durable 100% polyester microfiber
- Color coding tabs to prevent cross contamination
- For use with Mop Holder SM40G/R & EFPMH
- Wash Cycles: 300



### SmartColor EZ Flat Mop Holder

PART NO.:	<b>SM40R</b>	COLOR:	<b>Red</b>	SIZE:	<b>16"/40 cm</b>	CASE QTY.:	<b>5</b>
PART NO.:	<b>SM40G</b>	COLOR:	<b>Gray</b>	SIZE:	<b>16"/40 cm</b>	CASE QTY.:	<b>5</b>

- Flat mop holder with pivoting, low-profile head
- Large 16"/40 cm surface provides more direct cleaning contact, more scrubbing pressure
- Easily collapses with the touch of a button to rinse or change mop head
- Use handle socket with nylon-threaded cone or tapered handles from 21-23 mm in diameter

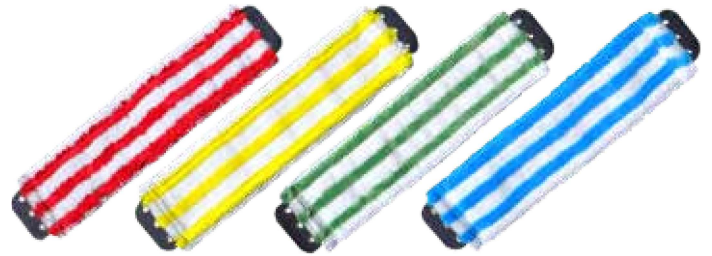

### SmartColor Micro Mop - 7.0

PART NO.:	<b>MD40R</b>	COLOR:	<b>Red</b>	SIZE:	<b>16"/40 cm</b>	CASE QTY.:	<b>5</b>
PART NO.:	<b>MD40Y</b>	COLOR:	<b>Yellow</b>	SIZE:	<b>16"/40 cm</b>	CASE QTY.:	<b>5</b>
PART NO.:	<b>MD40G</b>	COLOR:	<b>Green</b>	SIZE:	<b>16"/40 cm</b>	CASE QTY.:	<b>5</b>
PART NO.:	<b>MD40B</b>	COLOR:	<b>Blue</b>	SIZE:	<b>16"/40 cm</b>	CASE QTY.:	<b>5</b>

- Medium-duty 7 mm pile microfiber for vinyl or sealed floors without grout lines
- Features aggressive cleaning edges that clean with less water, less effort
- For use with Mop Holder SM40G/R & EFPMH
- Wash Cycles: 500

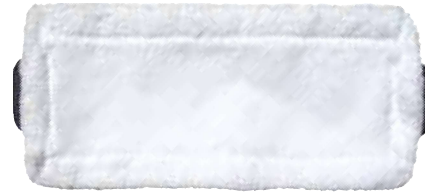

### SmartColor Spill Mop 1L

PART NO.:	<b>MA450</b>	COLOR:	<b>White</b>	SIZE:	<b>16"/40 cm</b>	CASE QTY.:	<b>5</b>
-----------	--------------	--------	--------------	-------	------------------	------------	----------

- Extra absorbent microfiber, with large surface area and 14 mm pile
- Absorbs up to one liter of liquid
- For use with Mop Holder SM40G/R & EFPMH
- Wash Cycles: 500

### SmartColor EZ Flat Mop Holder "Drop and Mop" Feature

The "no spin" design allows the user to quickly drop the mop down and start working.

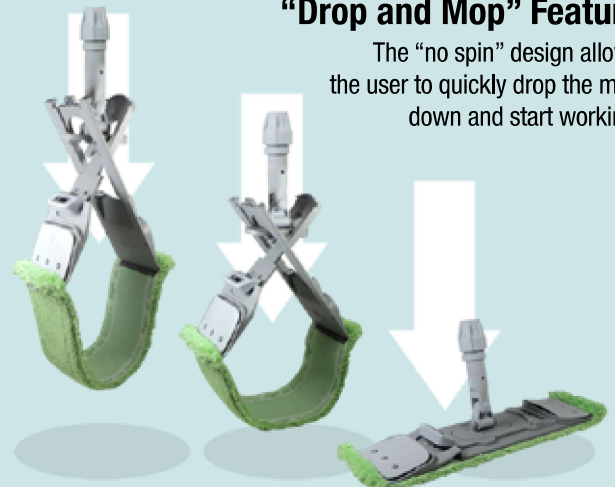



**SmartColor RoughMop ST45 Series**

PART NO.: <b>ST45R</b>	COLOR: <b>Red</b>	STRAND COUNT: <b>32 Strands</b>	WEIGHT: <b>16 oz./450 g</b>	CASE QTY.: <b>5</b>
PART NO.: <b>ST45Y</b>	COLOR: <b>Yellow</b>	STRAND COUNT: <b>32 Strands</b>	WEIGHT: <b>16 oz./450 g</b>	CASE QTY.: <b>5</b>
PART NO.: <b>ST45G</b>	COLOR: <b>Green</b>	STRAND COUNT: <b>32 Strands</b>	WEIGHT: <b>16 oz./450 g</b>	CASE QTY.: <b>5</b>
PART NO.: <b>ST45B</b>	COLOR: <b>Blue</b>	STRAND COUNT: <b>32 Strands</b>	WEIGHT: <b>16 oz./450 g</b>	CASE QTY.: <b>5</b>

- Double-sided microfiber tube mop
- Cleaning power increased with 6"/15 cm scrub pad material on headband
- Wash Cycles: 500



**SmartColor Scrub Mop Pad**

PART NO.: <b>SCMPD</b>	SIZE: <b>20"/51 cm</b>	CASE QTY.: <b>5</b>
------------------------	------------------------	---------------------

- Microfiber pad made of durable 100% polyester microfiber with a 7mm looped pile
- Color coding tabs to prevent cross-contamination
- For use with hook & loop mop holders including Unger Excella and Unger Damp Mop Pad Holder
- Wash cycles: 300



**SmartColor String Mop Holder**

PART NO.: <b>FC03G</b>	CASE QTY.: <b>5</b>
------------------------	---------------------

- Heavy-duty clamp-style mop holder
- For use with all SmartColor Microfiber String mop series
- Use with poles 21-23 mm in diameter



**Damp Mop Pad Holder**

PART NO.: <b>SV40G</b>	SIZE: <b>18"/45 cm</b>	CASE QTY.: <b>5</b>
------------------------	------------------------	---------------------

- Mop holder with swivel head easily glides across floors
- Quickly attaches to SmartColor Damp Mop Pads using Unger "Z" hook & loop fastening technology
- Use with DD40, DV40, EF40M/R, SCMPD and DMWS series mop pads



**SmartColor RoughMop ST30 Series**

PART NO.: <b>ST30R</b>	COLOR: <b>Red</b>	STRAND COUNT: <b>22 Strands</b>	WEIGHT: <b>11 oz./300 g</b>	CASE QTY.: <b>5</b>
PART NO.: <b>ST30G</b>	COLOR: <b>Green</b>	STRAND COUNT: <b>22 Strands</b>	WEIGHT: <b>11 oz./300 g</b>	CASE QTY.: <b>5</b>
PART NO.: <b>ST30B</b>	COLOR: <b>Blue</b>	STRAND COUNT: <b>22 Strands</b>	WEIGHT: <b>11 oz./300 g</b>	CASE QTY.: <b>5</b>

- Double-sided microfiber tube mop
- Cleaning power increased with 6"/15 cm scrub pad material on headband
- Wash Cycles: 500



**Disposable Mop Pad (50pk)**

PART NO.: <b>DMWS2</b>	SIZE: <b>18.5"/47 cm</b>	CASE QTY.: <b>1</b>
------------------------	--------------------------	---------------------

- No need to launder disposable pads
- Single use disposable pads prevent cross-contamination risks with a new pad for each use
- Cleans floors evenly and allows for consistent dwell times when using disinfectants
- For use with hook & loop mop holders including Unger Excella and Unger Damp Mop Pad Holder

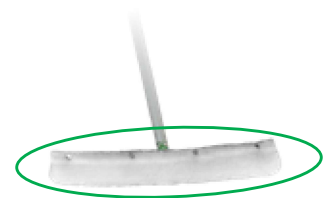

**Wonder Waxer Replacement Sleeve**

PART NO.: <b>QS010</b>	LENGTH: <b>17"/43 cm</b>	CASE QTY.: <b>10</b>
------------------------	--------------------------	----------------------

- Replacement sleeve made out of washable, low-lint fabric
- Snap fasteners for quick replacement and secure fit

### SmartColor Tele-Pole 250

PART NO.: **EZ25G** SIZE: **8'/2.6 m** CASE QTY.: **10**

- Convenient 2-section telescoping pole
- Extends from 4'/1.3 m to 8'/2.5 m
- 21 mm diameter
- Lightweight, made of aluminum
- Includes snap-in Taper/ACME cone adapter for attaching Unger cleaning tools

### Ergo Tele-Pole

PART NO.: **EP24R** SIZE: **8'/2.5 m** CASE QTY.: **10**

PART NO.: **EP18R** SIZE: **6'/1.8 m** CASE QTY.: **10**

- Convenient 2-section telescoping handle
- Extends from 4'/1.2 m to 6'/1.8m - 8'/2.5 m
- 21 mm diameter
- Includes snap-in Taper/ACME cone adapter for attaching Unger cleaning tools
- Lightweight aluminum construction with ergonomic grip



### ErgoTec Locking Cone - Red

PART NO.: **NCANR** CASE QTY.: **5**

- Securely locks select Unger tools onto pole
- Fast tool change with quick-release button
- Other tools attach by pressing on, snap on, or screw on



### SmartColor Swivel Brush

PART NO.: **SB20G** CASE QTY.: **10**

SIZE: **8" x 3"/20 x 8cm**

- Durable polypropylene PET bristles offer superior scrubbing action
- Angled bristles provide optimal cleaning of corners and edges
- ACME threaded handle socket

### Mop Handle 140 KD

PART NO.: **MS14G** SIZE: **4.5'/1.4 m** CASE QTY.: **10**

- Compact mop handle "knocked down" for shipping convenience
- Complete 3-section assembly
- 23 mm diameter
- Lightweight aluminum construction with ergonomic grip

### Ergo Pole

PART NO.: **HH13R** SIZE: **4'/1.2 m** CASE QTY.: **10**

- 1 section, 21 mm diameter
- Includes snap-in Taper/ACME threaded cone adapter for attaching Unger cleaning tools
- Lightweight aluminum construction with ergonomic grip



### Sanitary Brush - Red

PART NO.: **PB45R** SIZE: **18'/45 cm** CASE QTY.: **10**

- Acid-resistant, non-corroding squeegee and brush in one
- Double black foam-rubber squeegee is perfect for drying tiles and grout lines
- Polypropylene bristles offer effective scrubbing while being gentle on floors



### SmartColor Swivel Corner Brush

PART NO.: **CB20G** SIZE: **8.6"/22 cm** CASE QTY.: **10**

- Durable polypropylene PET bristles offer superior scrubbing action
- Angled bristles provide optimal cleaning of corners, edges, and grout lines
- Low-profile pivoting head reduces bending and over-reaching
- ACME threaded handle socket



SmartColor  
Tele-Pole 250

Mop Handle  
140 KD

Ergo Pole

Ergo Tele-Pole



## TOOL HOLDERS



### Hang Up

PART NO.: **H0350**    SIZE: **14"/35 cm**    CASE QTY.: **5**  
 PART NO.: **H0700**    SIZE: **28"/70 cm**    CASE QTY.: **5**

- Easy access all-purpose tool holder
- Tools are inserted in the front and held firmly in place by rubber grips
- Snap tools quickly in and out of holder for easy access
- Hanging hardware included

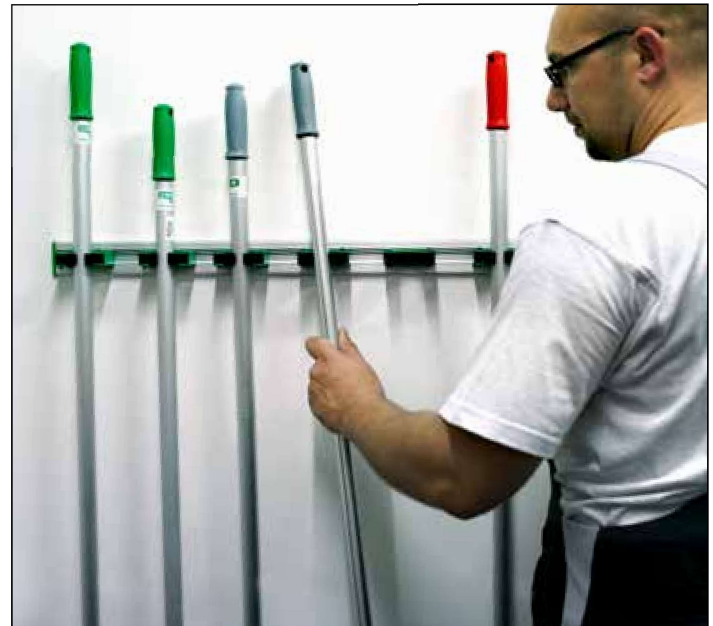

### Hold Up

PART NO.: **HU450**    SIZE: **18"/45 cm**    CASE QTY.: **5**  
 PART NO.: **HU900**    SIZE: **36"/90 cm**    CASE QTY.: **5**

- Tools are inserted from the bottom and held in place by strong rubber fingers
- Equipped with hooks on the front to hang up smaller tools
- Hanging hardware included





### Light-Duty Scraper

PART NO.: **LH12C** LENGTH: **4'/1.2 m** CASE QTY.: **10**

- For light-duty jobs, with an aluminum handle and 4"/10 cm angled zinc alloy head
- Good for scraping gum, stickers, wax, etc.
- Lightweight with ergonomic grip and hang hole



### 4" Replacement Blades - Carbon Steel

PART NO.: **RB10C** SIZE: **4"/10 cm** CASE QTY.: **10**

CASE PACK: 10 Dispensers of 10 Blades

PART NO.: **RB30C** SIZE: **4"/10 cm** CASE QTY.: **30**

CASE PACK: 30 Dispensers of 10 Blades

- Compact handy dispenser safely stores new and used blades – easily slide in and out
- Sharp side for scraping off paint, stickers, etc., and dull side for removing cement and stucco
- For LH12C, SH00C, SH25C, STMAX



### 4" Replacement Blades - Stainless Steel

PART NO.: **RB100** SIZE: **4"/10 cm** CASE QTY.: **10**

CASE PACK: 10 Dispensers of 10 Blades

### Medium-Duty Scraper

PART NO.: **MDSCO** LENGTH: **5'/1.5 m** CASE QTY.: **10**

- For medium-duty jobs, with an aluminum handle and 6" angled zinc alloy head
- Good for industrial scraping, tape, and heavy dirt
- Ergonomic grip and hang hole

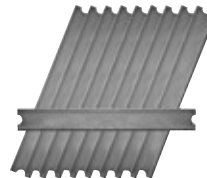

### 6" Replacement Blades

PART NO.: **MDSB0** SIZE: **6"/15 cm** CASE QTY.: **5**

CASE PACK: 5 Tubes of 10 Blades

- For use with MDSCO
- Double-edged .036" thick carbon steel blades

### Heavy-Duty Scraper

PART NO.: **HDSS0** LENGTH: **5'/1.5 m** CASE QTY.: **10**

- For heavy-duty jobs, with a steel handle and 8" angled zinc alloy head
- Good for stripping tile floors, removing carpets, and heavy-duty adhesives
- 1"/2.5 cm diameter galvanized steel handle with ergonomic grip and hang hole

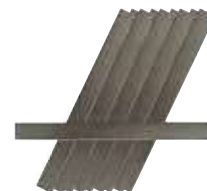

### 8" Replacement Blades

PART NO.: **HDSB0** LENGTH: **8"/20 cm** CASE QTY.: **5**

- For use with HDSS0
- Double-edged .036"/.09 cm thick carbon steel blades

For handheld scrapers, go to page 21-23

## PRO ALUMINUM HANDLES

### Pro Aluminum 1.5°

PART NO.: **AL140**    LENGTH: **56"/1.42 m**    CASE QTY: **10**

- Heavy duty handle fits 1.5° taper socket, ideal for WaterWand squeegees

### Pro Aluminum 1.5° Knock Down

PART NO.: **AL14G**    LENGTH: **56"/1.42 m**    CASE QTY: **10**

- Heavy duty handle fits 1.5° taper socket.
- Rigid, fluted aluminum construction ideal for WaterWand squeegees



### Pro Aluminum ACME

PART NO.: **AL14A**    LENGTH: **58"/1.47 m**    CASE QTY: **10**

- Heavy duty handle with threaded zinc alloy tip is ideal for Sanitary Squeegees, and other products with ACME universal sockets

### Pro Aluminum 3.0°

PART NO.: **AL14T**    LENGTH: **61"/1.55 m**    CASE QTY: **10**

- Heavy duty handle with ACME threaded zinc alloy tip fits 3.0° taper socket is ideal for AquaDozer squeegees



### WaterWand™ ACME Insert

PART NO.: **FWAIO**    CASE QTY: **10**

- Easily converts WaterWand squeegees from tapered to an ACME compatible socket for use with either type of handle



### AquaDozer® ACME Insert

PART NO.: **FAAIO**    CASE QTY: **10**

- Easily converts AquaDozer squeegees from tapered to an ACME compatible socket for use with either type of handle

## Aluminum Handle Guide

All poles feature a 1"/2.5 cm diameter anodized aluminum handle with convenient hang-up hole and fluted finish for strength. Ergonomic grip provides a comfortable hold.



### Pro Aluminum 1.5°

- Tapered



### Pro Aluminum 1.5° Knock Down (AL14G)

- Tapered



### Pro Aluminum ACME

- ACME thread



### Pro Aluminum 3.0°

- 3° Conical top



Pro Aluminum 1.5°

Pro Aluminum 1.5° Knock Down

Pro Aluminum ACME

Pro Aluminum 3.0°

SmartFit WaterWand Standard (MW18A)



SmartFit WaterWand Heavy Duty (HM22A)

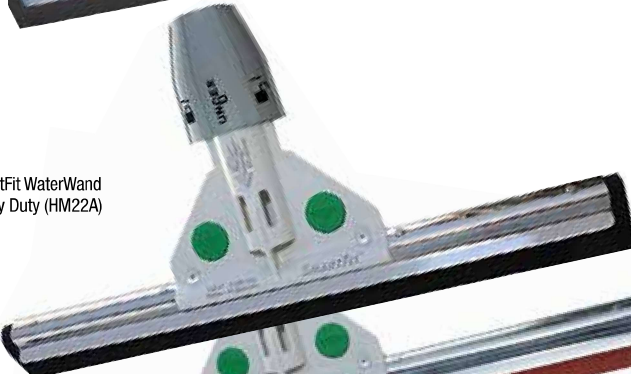

SmartFit WaterWand Heavy Duty (HW30A)



Sanitary Standard



AL14A



AL14T



Sanitary Brush

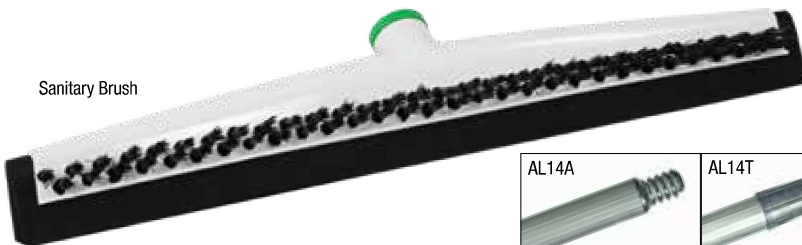

AL14A



AL14T



WaterWand Heavy Duty

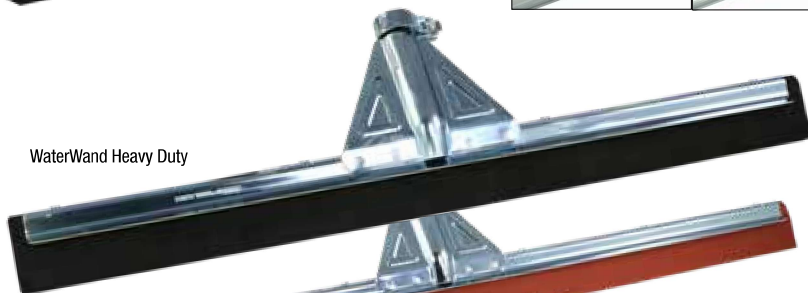

WaterWand Heavy Duty - HW750

AL140

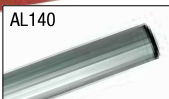

AL14G

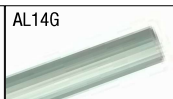

### SmartFit™ WaterWand™ Standard

PART NO.: <b>MW18A</b>	LENGTH: <b>18"/45 cm</b>	CASE QTY: <b>10</b>
PART NO.: <b>MW22A</b>	LENGTH: <b>22"/55 cm</b>	CASE QTY: <b>10</b>

- General purpose floor squeegee for kitchens, decks, pools, and other lighter jobs
- Twin natural foam-rubber blade and heavy-duty galvanized steel channel
- Easy flush-and-rinse design reduces harmful bacteria buildup
- Custom color coding chip system by zone reduces cross-contamination
- Universal power socket locks onto standard handles including straight, tapered, thread and non-thread tips

### SmartFit™ WaterWand™ Heavy Duty

PART NO.: <b>HM22A</b>	LENGTH: <b>22"/55 cm</b>	CASE QTY: <b>10</b>
PART NO.: <b>HM30A</b>	LENGTH: <b>30"/75 cm</b>	CASE QTY: <b>10</b>
PART NO.: <b>HM30K</b>	LENGTH: <b>30"/75 cm</b>	CASE QTY: <b>1</b>
PART NO.: <b>HW30A</b>	LENGTH: <b>30"/75 cm</b>	CASE QTY: <b>10</b>

- Removes water easily from uneven floor surfaces, such as grouted tile, or non-slip and broadcast grid floors
- Double black foam-rubber blade and heavy-duty galvanized steel channel
- Easy flush-and-rinse design reduces harmful bacteria buildup
- Custom color coding chip system by zone reduces cross-contamination
- HM30K – includes compact mop handle (MS14G)
- HW30A – double red neoprene foam-rubber blade
- Universal power socket locks onto standard handles including straight, tapered, thread and non-thread tips

### Sanitary Squeegees

PART NO.: <b>PM45A</b>	LENGTH: <b>18"/45 cm</b>	CASE QTY: <b>10</b>
PART NO.: <b>PM55A</b>	LENGTH: <b>22"/55 cm</b>	CASE QTY: <b>10</b>

- Acid-resistant, non-corroding squeegee with natural black double foam-rubber blade with ACME thread and splash guard
- Durable threaded socket accepts ACME threaded handles

### Sanitary Brush

PART NO.: <b>PB45A</b>	LENGTH: <b>18"/45 cm</b>	CASE QTY: <b>10</b>
PART NO.: <b>PB55A</b>	LENGTH: <b>22"/55 cm</b>	CASE QTY: <b>10</b>

- Acid-resistant, non-corroding squeegee and brush in one
- Double black foam-rubber squeegee is perfect for drying tiles and grout lines
- Polypropylene bristles offer effective scrubbing while being gentle on floors
- Also available in red (see page 55 - PB45R)

### WaterWand Heavy-Duty

PART NO.: <b>HM550</b>	LENGTH: <b>22"/55 cm</b>	CASE QTY: <b>10</b>
PART NO.: <b>HM750</b>	LENGTH: <b>30"/75 cm</b>	CASE QTY: <b>10</b>
PART NO.: <b>HW750</b>	LENGTH: <b>30"/75 cm</b>	CASE QTY: <b>10</b>

- Removes water easily from uneven floor surfaces such as grouted tile or non-slip and broadcast grid floors with double black foam-rubber blade
- HW750 - Double red neoprene foam-rubber blade
- Reinforced handle socket to tackle heavy dirt
- Sturdy 20-gauge steel frame with socket clamp
- Optional ACME thread insert sold separately



## FLOOR SQUEEGEES

### Push Pull Floor Squeegee

PART NO.: **FH600**      LENGTH: **24"/60 cm**      CASE QTY.: **10**

- Frame is made of lightweight, heavy-duty aluminum with a pivoting channel and rust-resistant plated steel handle socket
- For pushing and pulling standard water volumes
- Ideal for light- to medium-duty industrial applications
- Hard SBR tan rubber for smooth coated concrete and commercial floors

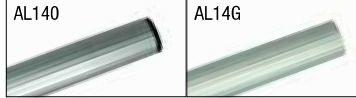

Push Pull Floor Squeegee

### WaterWand Standard

PART NO.: **MW450**      LENGTH: **18"/45 cm**      CASE QTY.: **10**

PART NO.: **MW550**      LENGTH: **22"/55 cm**      CASE QTY.: **10**

- Screw-locking socket and twin natural foam-rubber blade
- Ideal for kitchens, decks, pools, and other light jobs
- Sturdy 20 gauge steel frame with socket clamp
- Optional ACME thread insert sold separately
- Use with Pro Aluminum handles: 1.5° (AL140) or 1.5° Knock Down (AL14G)

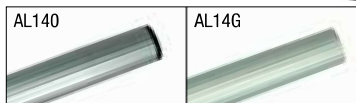

WaterWand Standard

### AquaDozer Eco

PART NO.: **FE450**      LENGTH: **18"/45 cm**      CASE QTY.: **6**

PART NO.: **FE600**      LENGTH: **22"/55 cm**      CASE QTY.: **6**

- 14-gauge galvanized steel frame with black EPDM rubber
- Use with Pro Aluminum handle: 3.0° (AL14T)



AquaDozer Eco

### AquaDozer Heavy-Duty

PART NO.: **FP450**      LENGTH: **Straight 18"/45 cm**      CASE QTY.: **6**

PART NO.: **FP600**      LENGTH: **Straight 24"/60 cm**      CASE QTY.: **6**

PART NO.: **FP750**      LENGTH: **Straight 30"/75 cm**      CASE QTY.: **6**

PART NO.: **FP900**      LENGTH: **Straight 36"/90 cm**      CASE QTY.: **6**

PART NO.: **FP60C**      LENGTH: **Curved 24"/60 cm**      CASE QTY.: **6**

PART NO.: **FP90C**      LENGTH: **Curved 36"/90 cm**      CASE QTY.: **6**

- For heavy-duty jobs and moving large volumes of water, mud, and debris
- Made with black EPDM rubber
- Constructed with 14-gauge powder-coated steel frame
- Reinforced zinc alloy handle socket
- Optional ACME threaded insert sold separately
- Use with Pro Aluminum handle: 3.0° (AL14T)



AquaDozer Heavy Duty

### AquaDozer Max

PART NO.: **FX600**      LENGTH: **Straight 24"/60 cm**      CASE QTY.: **4**

PART NO.: **FX900**      LENGTH: **Straight 36"/90 cm**      CASE QTY.: **4**

PART NO.: **FX60C**      LENGTH: **Curved 24"/60 cm**      CASE QTY.: **4**

PART NO.: **FX90C**      LENGTH: **Curved 36"/90 cm**      CASE QTY.: **4**

- Unique curved blade maximizes cleaning performance
- Durable steel body for tough demands including flood clean up
- Rubber blade cleans and dries floor
- Best for smooth surfaces like asphalt and concrete floors
- Use with Pro Aluminum handle: 3.0° (AL14T)



AquaDozer Max (Straight)

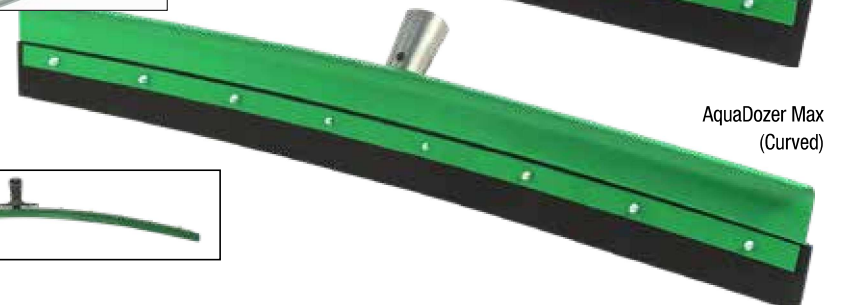

AquaDozer Max (Curved)

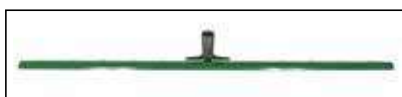

Straight

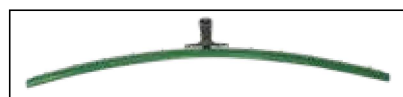

Curved



# Litter Removal

When litter is a problem, Unger's cleaning tools are your solution. These tools and accessories are designed for safety and efficiency, minimizing strain and injury. No more bending or backaches, great for retrieving out of reach objects high or low. Ergonomic handles and lightweight design help get cleaning jobs done fast. Keep your grounds spotless with these high-quality litter removal tools.



NiftyNabber Trigger Grip

NiftyNabber Bagger

People's Paper Picker Pin

NiftyNabber Pro



Neoprene Gloves

## NiftyNabber Pro

PART NO.: <b>NN400</b>	LENGTH: <b>20"/52 cm</b>	CASE QTY: <b>5</b>
PART NO.: <b>NN900</b>	LENGTH: <b>38"/97 cm</b>	CASE QTY: <b>10</b>
PART NO.: <b>NN140</b>	LENGTH: <b>51"/130 cm</b>	CASE QTY: <b>5</b>
PART NO.: <b>NN960</b>	LENGTH: <b>94"/238 cm</b>	CASE QTY: <b>6</b>

- Strong enough for heavy-duty work, light enough to protect from back and arm strain
- Shaft made from durable steel for long-lasting, dependable use
- Shaft on the NN960 is made of aluminum, designed to decrease fatigue and make overhead use easier

## NiftyNabber Trigger Grip

PART NO.: <b>NT060</b>	LENGTH: <b>24"/63 cm</b>	CASE QTY: <b>5</b>
PART NO.: <b>NT080</b>	LENGTH: <b>32"/83 cm</b>	CASE QTY: <b>5</b>
PART NO.: <b>NN090</b>	LENGTH: <b>36"/93 cm</b>	CASE QTY: <b>5</b>

- Comfortable grip with smooth, trigger-pull action
- Access hard-to-reach areas or items with 360° rotating head
- Magnetic tip allows user to pick up small metal objects, up to .25 lbs
- Lightweight aluminum shaft, designed to decrease fatigue and make waist-high and overhead use easier

## People's Paper Picker Pin

PART NO.: <b>PPPP0</b>	LENGTH: <b>42"/107 cm</b>	CASE QTY: <b>10</b>
------------------------	---------------------------	---------------------

- Effective waste removal using strong metal pin
- Easily picks up litter such as paper, cans, and plastic cups

## Replacement Pin Plugs

PART NO.: <b>PINP0</b>	CASE QTY: <b>10</b>
------------------------	---------------------

## NiftyNabber Bagger

PART NO.: <b>NB300</b>	SIZE/CAPACITY: <b>23" x 27"/40 Gal.</b>	CASE QTY: <b>1</b>
	SIZE/CAPACITY: <b>58 x 68 cm/38 L</b>	

- Bagger collapses and secures for compact shipping and easy storage
- Bottom drainage holes make rinsing out easy.
- Uses standard 55 gal. trash bags (weight capacity: 65 lbs)
- Sturdy web handles and rugged bottom allow easy dragging over pavement

## Neoprene Gloves

PART NO.: <b>GLOV2</b>	SIZE: <b>Large</b>	CASE QTY: <b>10 Pairs</b>
PART NO.: <b>GLOV3</b>	SIZE: <b>XLarge</b>	CASE QTY: <b>10 Pairs</b>

- Neoprene exterior, plus interior foam insulation
- Textured palm provides a non-slip grip
- Hook & loop strap provides a secure fit

## NiftyNabber® Trigger Grip Design Advantages



### Rotating Head

Access hard-to-reach areas or items with 360° rotating head.



### Magnetic Tip

Use the grabber to pick up small metal objects - up to .25 lbs.

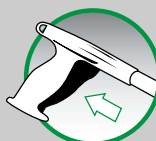

### Ergonomic Design

Ergonomically designed grip with smooth trigger-pull action for increased comfort and efficiency.



### Tight Grip

The rubber claws allow users to pick up and hold small objects.



KEY CODE	PART NO.	DESCRIPTION	CASE QTY.
A	18641	Outlet with O-Ring	1
B	18481	Outlet Hose Quick Connect	1
C	DIPRE	FloWater™ Unit	1
D	18482	Inlet On/Off Valve	1
E	DISKT	O-Rings (5), Care Resolution	1
F	DITCP	Top Cap Assembly	1
G	21151	TDS Meter	1
H	19034	Inlet Quick Connect	1
I	HPB06	Resin Bag 6L	1
J	HPB24	Resin Bags 6L (4 in pail)	1



KEY CODE	PART NO.	DESCRIPTION	CASE QTY.
A	21064	Water OUT Connection with O-Ring	1
B	18481	Water OUT Hose Connection	1
C	21066	FloWater™ Unit	1
D	21065	Water IN On/Off Connection	1
E	UHP5R	O-Rings (5), Care Resolution	1
F	21071	Top Cap Assembly	1
G	21151	TDS Meter	1
H	21504	Water IN Hose Connection	1
I	22601	Transportation Cart	1



KEY CODE	PART NO.	DESCRIPTION	DETAILED INFORMATION	CASE QTY.
A	ROMML	Membrane Maintenance Liquid		1
B	ROWFV	Water Flow Valve w/Tap		1
C	ROPTB	Preservation Tube		1
D	ROCFC	Combi Pre-Filter Cartridge		1
E	ROMEM	Membrane Filter	(Pay attention for the right position of the membrane [ROMEM]) • The printed arrow must point upwards. • The rubber seal at the end of the membrane must always be at the top!	1
F	ROWOC	Water Out Connector		1
G	RORFC	DI Resin Filter Replacement Cartridge	(Pay attention for the right position of the resin filter [RORFC]) • Position the blue filter insert to the top The incorrect position of the filter can cause damage to the unit!	1
H	ROFCC	Filter Housing (empty)		1
I	ROFKY	Filter Key		1
J	ROWHC	Wheel with Cap		1
K	ROPCS	Protective Clips for Cart (2pk)		1
L	ROCWK	Cap and Washer Kit		1

## GEN 1 nLite SPARE PARTS

### HiFlo nLite WATERFED POLE SYSTEM

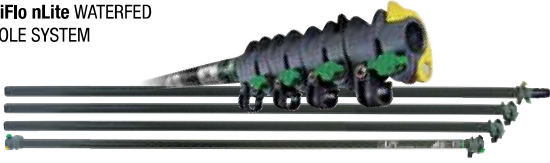

#### nLite POLE TUBE, HIMOD MASTER (UC67G)

PART NO.	Ø MM	SEGMENT	CLAMP	CASE QTY.
17254	26	1	●	1
17260	29	2	●	1
17266	32	3	●	1
17269	35	4	● + ●	1

#### nLite POLE TUBE, HIMOD EXTENSION (UC35G)

PART NO.	Ø MM	SEGMENT	CLAMP	CASE QTY.
17279	32	1	-	1
17396	35	2	● + ●	1

#### nLite POLE TUBE, CARBON MASTER (CT67G)

PART NO.	Ø MM	SEGMENT	CLAMP	CASE QTY.
17253	26	1	●	1
17259	29	2	●	1
17265	32	3	●	1
17268	35	4	● + ●	1

#### nLite POLE TUBE, CARBON EXTENSION (CT35G)

PART NO.	Ø MM	SEGMENT	CLAMP	CASE QTY.
17278	32	1	-	1
17394	35	2	● + ●	1

#### nLite POLE TUBE, HYBRID MASTER (HT67G)

PART NO.	Ø MM	SEGMENT	CLAMP	CASE QTY.
17252	26	1	●	1
17258	29	2	●	1
17264	32	3	●	1
17267	35	4	● + ●	1

#### nLite POLE TUBE, HYBRID EXTENSION (HT35G)

PART NO.	Ø MM	SEGMENT	CLAMP	CASE QTY.
17277	32	1	-	1
17395	35	2	● + ●	1

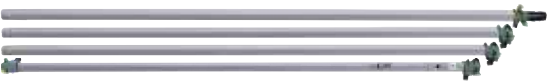

#### nLite POLE TUBE, ALU MASTER (AN45U / AN60U)

PART NO.	Ø MM	SEGMENT	CLAMP	CASE QTY.
17828	26	1 (45U)	●	1
17829	29	2 (45U)	●	1
17830	32	3 (45U)	●	1
17831	35	4 (45U)	● + ●	1
17824	26	1 (60U)	●	1
17825	29	2 (60U)	●	1
17826	32	3 (60U)	●	1
17827	35	4 (60U)	● + ●	1



#### nLite POLE TUBE, ALU EXTENSION (AN30U)

PART NO.	Ø MM	SEGMENT	CLAMP	CASE QTY.
17832	32	1	-	1
17833	35	2	● + ●	1



**HiFlo SOAP DISPENSER**

PART NO.	CASE QTY.
HCDUS	1



**nLite HOSE CLIPS**

PART NO.	CASE QTY.
17149	10



**HiFlo CONTROL**

PART NO.	CASE QTY.
TMOOV	1



**HiFlo nLite HOSE BRUSH CONNECTION KIT**

PART NO.	INFO	CASE QTY.
NLHPC	Connection kit 5mm	1



**nLite JETS**

PART NO.	INFO	CASE QTY.
NLBJF	1 Set = 2 Jets	1
NLBJP	1 Set = 2 Jets	1



**HiFlo nLite ENDCAP**

PART NO.	CASE QTY.
TMECP	1



**nLite TOOL ADAPTERS**

PART NO.	INFO	CASE QTY.
FTTHR	Eurothread Adaptor	1
HFNLC	Locking Cone Adaptor	1



**nLite HOSE**

PART NO.	LENGTH	CASE QTY.
NL11G	36' / 11 m	1
NL20G	65' / 20 m	1
NL25G	82' / 25 m	1



**nLite MULTILINK GOOSENECKS**

PART NO.	SIZE	WEIGHT	MATERIAL	CASE QTY.
NLG20	8" / 20 cm	130 g	Carbon	1
NLG30	12" / 30 cm	140 g	Carbon	1
FTGOS	6" / 15 cm	50 g	Plastic	1



**nLite BRUSH SOCKET**

PART NO.	CASE QTY.
NLBRS	1

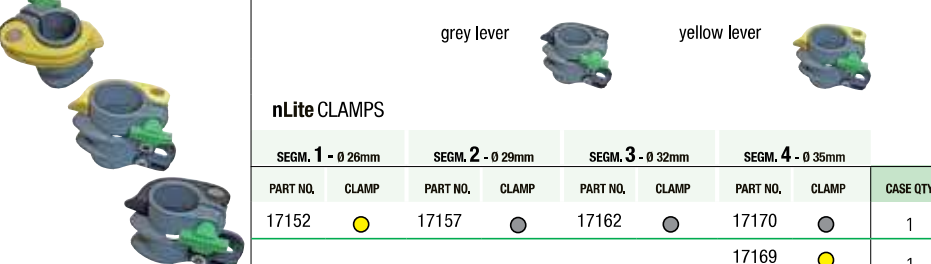

**nLite CLAMPS**

SEGM. 1 - Ø 26mm		SEGM. 2 - Ø 29mm		SEGM. 3 - Ø 32mm		SEGM. 4 - Ø 35mm		CASE QTY.
PART NO.	CLAMP	PART NO.	CLAMP	PART NO.	CLAMP	PART NO.	CLAMP	
17152	●	17157	●	17162	●	17170	●	1
						17169	●	1



**HiFlo nLite CARRYING BAG**

PART NO.	CASE QTY.
NLBA1	1

Segments  
1 2 3 4 5 6



Segment 1



Segment 2-5



Segment 6 (outside)



### nLITE Carbon Composite POLE SECTIONS

POLE	LENGTH	SEGMENTS	SEGM. 1	SEGM. 2	SEGM. 3	SEGM. 4	SEGM. 5	SEGM. 6
			22 mm	25 mm	28 mm	31 mm	33 mm	37 mm
Extended			PART NO.	PART NO.	PART NO.	PART NO.	PART NO.	PART NO.
CC32T	10,5'/3,20 m	2	23118	23117				
CC60T	20'/6,00 m	4	23118	23119	23120	23121		
CC85T	28'/8,60 m	6	23118	23119	23120	23122	23123	23124

### nLITE Carbon 24K POLE SECTIONS

POLE	LENGTH	SEGMENTS	SEGM. 1	SEGM. 2	SEGM. 3	SEGM. 4	SEGM. 5	SEGM. 6
			22 mm	25 mm	28 mm	31 mm	34 mm	37 mm
Extended			PART NO.	PART NO.	PART NO.	PART NO.	PART NO.	PART NO.
CF60T	20'/6,00 m	4	23125	23126	23127	23128		
CF86G	28'/8,60 m	6	23125	23126	23127	23129	23130	23132
CF33G	10,5'/3,20 m	4					23131	23133



nLite CLAMP REPLACEMENT SET		
PART NO.	SIZE	CASE QTY.
23145	6 clips, 6 screws, 6 bars	1



nLITE PROTECTION CAP	
PART NO.	CASE QTY.
NLPCP	1



#### EXCHANGING OF POLE SECTIONS:

1. Remove the lower screw of the clamp. The double sided adhesive tape of the clamp must be replaced if necessary (see below)
2. Carefully pull the pole section upwards with the clamp.

**ATTENTION:** There is a stop tape at the end of each pole section, this must not be damaged during removal and reinserting!

#### nLITE SmartLock CLAMPS



SEGM. 1 - Ø 22 mm	SEGM. 2 - Ø 25 mm	SEGM. 3 - Ø 28 mm	SEGM. 4 - Ø 31 mm	SEGM. 5 - Ø 34 mm	SEGM. 6 - Ø 37 mm
PART NO. 23134	PART NO. 23135	PART NO. 23136	PART NO. 23137	PART NO. 23138	PART NO. 23139



#### REPLACING SMART LOCK CLAMPS:

1. Remove the lower screw of the clamp.
  2. Carefully pull the clamp upwards.
  3. If the adhesive tape under the clamp shifts, replace it (1,5' of tape included with replacement spare clamps).
  4. Carefully slide the clamp over the tape (spread the clamp) and retighten the screw.
- ATTENTION:** The clamps must always be fixed with adhesive tape to ensure stability during work!



#### nLITE HANDLE

POLE	Small Ø	Medium Ø	Large Ø
	25 mm	31 mm	37 mm
	PART NO.	PART NO.	PART NO.
CC16T / CC32T	23140		
CC60T / CF60T		23141	
CC85T / CF86G / CF33G			23142



SAFETY RING		
PART NO.	INFO	CASE QTY.
22623	for Swivel Brush Socket	1



HOSELOCK ALU CONNECTOR		
PART NO.	INFO	CASE QTY.
CTHLC	for DLS25 (hose)	1



BRUSH SOCKET		
PART NO.	INFO	CASE QTY.
NLSWS	Swivel mechanism	1
23104	Fixed mechanism	1
23103	Fastening screw (1 pc.)	1



#### nLITE ANGLE ADAPTER ELEMENTS

PART NO.	INFO	CASE QTY.
22805	Element A - pole adapter	1
22806	Element B - brush adapter	1
22807	Element C - short (incl. hose & quick connector)	1
22808	Element D - long (incl. hose & quick connector)	1



QUICK CONNECTOR		
PART NO.	SIZE	CASE QTY.
22809	8m>8m	1 Set (5)



QUICK CONNECTOR ANGLE		
PART NO.	SIZE	CASE QTY.
22811	8m>8m, 90°	1



HOSE FOR BRUSH CONNECTION		
PART NO.	SIZE	CASE QTY.
22813	20 cm	1 Set (5)



SOFT TOUCH BUMPER		
PART NO.	INFO	CASE QTY.
22125		1



RINSE BAR FOR BRUSHES		
PART NO.	SIZE	CASE QTY.
NLR28	28 cm	1
NLR41	41 cm	1



nLITE JET BLOCK FOR BRUSHES		
PART NO.	SIZE	CASE QTY.
23114	28 cm	1
23115	41 cm	1

TELESCOPIC POLES

**SMOOTH INSIDE POLE (21 mm)**

PART NO.	FOR	CASE QTY.
12713	EZ250 / ED370 / TZ250	1
12714	ED450	1
12715	ED550 / TZ370	1
12717	EZ500	1
12718	ED900 (parts must be shipped by truck)	1
13908	EZ400	1

**SMOOTH FLUTED POLE (25 mm)**

PART NO.	FOR	CASE QTY.
13903	EZ250 / ED370	1
12721	ED450	1
13905	EZ400	1
13907	ED900 (parts must be shipped by truck)	1
13951	ED550	1

**LARGE FLUTED POLE (29mm)**

PART NO.	FOR	CASE QTY.
12727	ED370	1
12729	ED550	1
13344	ED900 (parts must be shipped by truck)	1

**LOCKING COLLAR**

PART NO.	SIZE	FOR	CASE QTY.
10949	29mm (3rd Arm)	TD550/TV750/TF900/T3180	1
10952	33mm (4th Arm)	TV750/TF900/T4180	1
10953	37mm (5th Arm)	TF900/T5180	1

**LOCKING COLLAR**

PART NO.	SIZE	FOR	CASE QTY.
10956	25mm	Poles	1

INSIDE SINGLE STONE (THREADED PIECE)			DOUBLE-THREADED STONE (BASIC SECTION)		
PART NO.	FOR	CASE QTY.	PART NO.	FOR	CASE QTY.
10950	Poles	1	10958	Poles	1

**INSIDE COLLET (GRAY)**

PART NO.	SIZE	FOR	CASE QTY.
12686	Small 25 mm	OptiLoc Poles	1
10917	Large 29 mm	OptiLoc Poles	1

**OUTSIDE LOCKING COLLAR**

PART NO.	SIZE	FOR	CASE QTY.
10914	25 mm	OptiLoc / Excella Poles	1

**OUTSIDE LOCKING COLLAR - OVERMOLD**

PART NO.	SIZE	FOR	CASE QTY.
20941	25 mm	OptiLoc Poles	1
20943	29 mm	OptiLoc Poles	1

**GRIP**

PART NO.	FOR	CASE QTY.
13764	TZ370	1
13765	T3180	1
13766	T4180	1

**GRIP**

PART NO.	FOR	CASE QTY.
10954	TF900 / T5180	1

**GRIP**

PART NO.	SIZE	FOR	CASE QTY.
10868	25 mm	OptiLoc Poles	1
10870	29 mm	OptiLoc Poles	1

WINDOW / GLASS CLEANING

STINGRAY

**STINGRAY O-RING**

PART NO.	FOR	CASE QTY.
18863	Stingray	1

**STINGRAY BATTERY COVERS**

PART NO.	FOR	CASE QTY.
19352	SRHHD (black)	1
22237	SRHBT (green)	1

**STINGRAY TOP COVERS**

PART NO.	FOR	CASE QTY.
19353	SRHHD (chrome)	1
22180	SRHBT (black)	1

**STINGRAY SPRAY NOZZLE KIT**

PART NO.	FOR	CASE QTY.
SRSNS	Stingray	1

**STRINGRAY PROFESSIONAL GLASS CLEANER**  
(For use with Stingray Classic)

PART NO.	FOR	CASE QTY.
SRGCL	SRHHD	1

**ALU PAD HOLDER REPLACEMENT STRIP**

PART NO.	FOR	CASE QTY.
20184	PHH20 & PHD20	1

WASHERS

**VISA HEAD**  
(Holds end piece & washer sleeve)

PART NO.	FOR	CASE QTY.
10962	VP Series	1

**VERSA HEAD**  
(Holds channel)

PART NO.	FOR	CASE QTY.
10483	VP Series	1

**VISAVERSA HANDLE / GRIP**

PART NO.	FOR	CASE QTY.
10964	VP Series	1

**WASHER HANDLE**

PART NO.	FOR	CASE QTY.
10969	T-Bar	1

**REPLACEMENT WASHER**  
(For use with T-Bar end piece)

PART NO.	FOR	CASE QTY.
10966	10"	1
10967	14"	1
10968	18"	1

**WINDOW CLEANING KIT BAG**

PART NO.	FOR	CASE QTY.
20704	ETSET & TRS00	1

SCRAPERS

**ERGO TEC HOLSTER BELT CLIP**

PART NO.	FOR	SIZE	CASE QTY.
18460		HT150 / ENH10 / ENH15	1

**COVER - MAXI SCRAPER**

PART NO.	FOR	SIZE	CASE QTY.
STMXC		STMAX	1

**BLADE HOLDER, ERGO TEC GLASS**

PART NO.	FOR	SIZE	CASE QTY.
EGH10	EG100	4"/10 mm	1
EGH15	EG150	6"/15 mm	1

**BLADE HOLDER ERGO TEC NINJA**

PART NO.	FOR	SIZE	CASE QTY.
18108	EG100 / ENH10	4"/10 mm	1
18098	EN150 / ENH15	6"/15 mm	1

**GLASS SCRAPER COVER**

PART NO.	FOR	SIZE	CASE QTY.
EGC10	EG100	4"/10 mm	1
EGC15	EN150	6"/15 mm	1

**ERGO TEC SCRAPER COVER**

PART NO.	FOR	SIZE	CASE QTY.
18103	EN100 / ENH10	4"/10 mm	1
18085	EN150 / ENH15	6"/15 mm	1













**ERGO TEC HOLSTER RETAINER CLIP & SCREW**

PART NO.	FOR	CASE QTY.
18459	HT150 / ENH10 / ENH15	1







**UNGER STICKER**

PART NO.	FOR	CASE QTY.
18405	NINJA SCRAPER	1

### DUSTPAN

	TELESCOPIC DUSTPAN HANDLE WITH YOKE - GRAY				HANDLE FOR TELESCOPIC BROOM - GRAY				HANDLE FOR TELESCOPIC DUSTPAN - GRAY			
	PART NO.	FOR	CASE QTY.		PART NO.	FOR	CASE QTY.		PART NO.	FOR	CASE QTY.	
	17926	EDTBG	1		17128	EDPBG	1		17127	EDPBG	1	
	TELESCOPIC DUSTPAN HANDLE WITH YOKE - RED				HANDLE FOR TELESCOPIC BROOM - RED				HANDLE FOR TELESCOPIC DUSTPAN - RED			
	PART NO.	FOR	CASE QTY.		PART NO.	FOR	CASE QTY.		PART NO.	FOR	CASE QTY.	
	17927	EDTBR	1		17126	EDTBR	1		17125	EDPBR	1	
	GRIP FOR DUSTPAN HANDLE - GRAY				GRIP FOR BROOM HANDLE - GRAY				BROOM HANDLE FOR DUSTPAN			
	PART NO.	FOR	CASE QTY.		PART NO.	FOR	CASE QTY.		PART NO.	FOR	CASE QTY.	
	18193	EDTBG	1		18194	EDTBG	1		15492	EDPBR	1	
	GRIP FOR DUSTPAN HANDLE - RED				GRIP FOR BROOM HANDLE - RED				DUSTPAN			
	PART NO.	FOR	CASE QTY.		PART NO.	FOR	CASE QTY.		PART NO.	FOR	CASE QTY.	
	18195	EDTBR	1		18196	EDTBR	1		12931	EDTBG / EDPBR	1	
	BROOM HEAD FOR DUSTPAN											
	PART NO.	FOR	CASE QTY.									
	15494	EDPBR / EDTBG / EDPBR	1									





















### RESTROOM

	SIDE PRESS HANDLE (WHITE/GRAY HANDLE WITH GRAY e-CLIP)				CONE ADAPTER (RED)				SMARTCOLOR PRESS & BUCKET HANDLE (WHITE / GRAY)			
	PART NO.	FOR	CASE QTY.		PART NO.	FOR	CASE QTY.		PART NO.	FOR	CASE QTY.	
	18393	COMBG / COMSG	1		NCAOR	Poles	5		SPREG	COMBG / COMSG COMBR / COMSR	1	
	SIDE PRESS HANDLE (WHITE/GRAY HANDLE WITH RED e-CLIP)				CONE ADAPTER (GRAY)				SMARTCOLOR PRESS & BUCKET HANDLE (WHITE / GRAY)			
	PART NO.	FOR	CASE QTY.		PART NO.	FOR	CASE QTY.		PART NO.	FOR	CASE QTY.	
	18394	COMBR / COMSR	1		NCAOG	Poles	5		SPRER	COMBG / COMSG COMBR / COMSR	1	
	GRAY DIVIDER				CONE ADAPTER (GREEN)							
	PART NO.	FOR	CASE QTY.		PART NO.	FOR	CASE QTY.					
	13381	Bucket Press Handle / Mop Holder	1		NCA00	Poles	5					
	E-CLIP				GRIP FOR BROOM HANDLE - RED							
	PART NO.	FOR	CASE QTY.		PART NO.	FOR	CASE QTY.					
	13381	Bucket Press Handle / Mop Holder	1		18196	EDTBR	1					
	GRIP				SPRING FOR NYLON CONE ADAPTERS							
	PART NO.	FOR	CASE QTY.		PART NO.	FOR	CASE QTY.					
	10892	Poles	1		11076	NCA00 / NCAOG / NCAOR	1					
	SMARTCOLOR™ STICKERS (2 SHEETS)				LOCKING COLLAR (RED)							
	PART NO.	FOR	CASE QTY.		PART NO.	FOR	CASE QTY.					
	SCCRO	Round	1			10894	EP24R	1				
	SCCSO	Square	1									
	END CLIPS FOR SV40G MOP PAD HOLDER (2 PACK)				VELCRO REPLACEMENT STRIPS							
	PART NO.	FOR	CASE QTY.		PART NO.	FOR	CASE QTY.					
	15090	SV40G	1		15377	SV40G / EF40B	1					
	SPRAYER FOR THE SPRAY ON A BELT				PRESS SPRING							
	PART NO.	FOR	CASE QTY.		PART NO.	SIZE	FOR	CASE QTY.				
		12946	SOABG		1	14001	1" Spring	COMBG / COMBR / COMSG / COMSR	1			
						18211	3" Spring		1			
				18210	1" S-Hook		1					
	GRAY CASTER											
	PART NO.	FOR	CASE QTY.									
	17891	COMSR / COMSG / OmniClean	1									





## CART / DUSTING / FLOOR CARE SPARE PARTS

### CARTS

	<b>SUPPLY MODULE STORAGE BAG</b> PART NO. RRMOD CASE QTY. 1		<b>VINYL TRASH BAG</b> PART NO. RRBAG SIZE 13.4"L X 12.6"W X 30.5"H CAPACITY 21.4 Gal US Liquid / 18.4 Gal US Dry CASE QTY. 1		<b>SMALL TOOL SHELF - NABBER</b> PART NO. RRSTS CASE QTY. 1
	<b>TOILET BOWL HOLDER CLIP</b> PART NO. 18370 CASE QTY. 1		<b>TOOL ICONS STICKER SHEET</b> PART NO. RRICN CASE QTY. 1		<b>RESTROOM FLOOR SIGN HOLDER</b> PART NO. RRF5H CASE QTY. 1
	<b>RAIL BRACKET</b> PART NO. 18002 CASE QTY. 1		<b>RAIL BRACKET COVER</b> PART NO. 18003 CASE QTY. 1		<b>LOBBY DUST PAN KICKPLATE</b> PART NO. RRLDP CASE QTY. 1
	<b>CART BASE (Complete with wheels)</b> PART NO. 18493 CASE QTY. 1		<b>CART MIDDLE SHELF</b> PART NO. 17990 CASE QTY. 1		<b>TOOL CLIPS - MEDIUM</b> PART NO. RRTMD CASE QTY. 5
	<b>CART FRONT - CURVE WALL</b> PART NO. 17989 CASE QTY. 1		<b>FRONT CASTERS</b> PART NO. 18011 CASE QTY. 1		<b>CART TOP SHELF (Without handrail)</b> PART NO. 17991 CASE QTY. 1
	<b>AXEL CAP</b> PART NO. 18017 CASE QTY. 1		<b>TOILET BOWL BRUSH HOLDER BASE</b> PART NO. 18369 CASE QTY. 1		<b>BACK AXEL</b> PART NO. 18015 CASE QTY. 1
					<b>TOILET BOWL BRUSH HOLDER WITH BASE</b> PART NO. 18001 CASE QTY. 1
					<b>TRASH BAG WIRE</b> PART NO. 18008 CASE QTY. 5

### DUSTING & MAINTENANCE

	<b>CEILING FAN DUSTER REPLACEMENT SLEEVES (5)</b> PART NO. CE05G FOR CEDUG CASE QTY. 1		<b>FLOOD SUCKER - PLASTIC CUP</b> PART NO. 10921 FOR FS000 CASE QTY. 1		<b>BEBBE - PLASTIC TRAY (Catches broken glass)</b> PART NO. 10907 FOR BEBE0 CASE QTY. 1
--	---	---	---	---	--





### FLOOR CARE

	<b>BLADE COVER - 8" SCRAPER (CLEAR)</b> PART NO. 10864 FOR HDSCO CASE QTY. 1		<b>PRO BUCKET HANDLE FOR QB220</b> PART NO. 10941 FOR QB220 CASE QTY. 1		<b>ENDCAP FOR HOLD UP</b> PART NO. 12066 SIDE Left FOR HU450 / HU90 CASE QTY. 1 12068 SIDE Right FOR HU450 / HU90
	<b>BLADE COVER - 6" SCRAPER</b> PART NO. 10863 FOR MDSCO CASE QTY. 1		<b>RUBBER FOR HOLD UP</b> PART NO. 10971 FOR HU450 / HU900 CASE QTY. 1		
	<b>BLADE COVER - 4" SCRAPER</b> PART NO. 10947 FOR LH12C / SH00C / SH25C CASE QTY. 1		<b>HANG UP SLIDE-IN "CLAWS"</b> PART NO. 14715 FOR H0350 / H0700 CASE QTY. 1		

### OMNICLEAN

	<b>OMNICLEAN EXCELLA CLIP</b>		<b>OMNICLEAN BLUE CHARGE GUIDE</b>		<b>OMNICLEAN GRAY SCRUB BOARD</b>	
<b>PART NO.</b>	<b>CASE QTY.</b>	<b>PART NO.</b>	<b>CASE QTY.</b>	<b>PART NO.</b>	<b>CASE QTY.</b>	
21805	1	21387	1	21533	1	
	<b>OMNICLEAN TOILET BRUSH HOLDER CLIP</b>		<b>OMNICLEAN STORAGE BINS</b>		<b>OMNICLEAN DUSTPAN HOLDER CLIP</b>	
<b>PART NO.</b>	<b>CASE QTY.</b>	<b>PART NO.</b>	<b>CASE QTY.</b>	<b>PART NO.</b>	<b>CASE QTY.</b>	
21463	1	21460	1	21458	1	
	<b>PAD HOLDER REPLACEMENT ADHESIVE STRIPS (3)</b>		<b>NIFTY NABBER HOLDER CLIP</b>		<b>OMNICLEAN EXCELLA BOTTLE HOLDER CLIP</b>	
<b>PART NO.</b>	<b>CASE QTY.</b>	<b>PART NO.</b>	<b>CASE QTY.</b>	<b>PART NO.</b>	<b>FOR</b>	<b>CASE QTY.</b>
21614	1	17997	1	21457	EFBAP	1
	<b>OMNICLEAN STRAIGHT / OFFSET CARRIAGE HANDLES</b>		<b>CASTER</b>		<b>OMNICLEAN CARRIAGE WITH WRINGER</b>	
<b>PART NO.</b>	<b>HANDLE</b>	<b>CASE QTY.</b>	<b>PART NO.</b>	<b>CASE QTY.</b>	<b>PART NO.</b>	<b>CASE QTY.</b>
21572	Straight	1	17891	1	21483	1
21484	Offset	1				
	<b>OMNICLEAN STORAGE CADDY</b>		<b>OMNICLEAN PAD HOLDER END CLIPS (2)</b>		<b>OMNICLEAN GRAY BUCKET</b>	
<b>PART NO.</b>	<b>CASE QTY.</b>	<b>PART NO.</b>	<b>CASE QTY.</b>	<b>PART NO.</b>	<b>SIZE</b>	<b>CASE QTY.</b>
21462	1	21613	1	21375	1.5 gal / 5.7 L	1
					<b>OMNICLEAN BUCKET HANDLES</b>	
				<b>PART NO.</b>	<b>COLOR</b>	<b>CASE QTY.</b>
				21526	Blue	1
				21527	Red	1
				21531	Gray	1

### EXCELLA

	<b>UNGER EXCELLA VALVE ASSEMBLY</b>		<b>UNGER EXCELLA BACKPACK HOSE ASSEMBLY</b>		<b>UNGER EXCELLA BACKPACK REPLACEMENT POUCH</b>	
<b>PART NO.</b>	<b>FOR USE WITH</b>	<b>CASE QTY.</b>	<b>PART NO.</b>	<b>FOR</b>	<b>CASE QTY.</b>	
EFVAS	EFBTS / EFBTL / EFVAS / EFBAAH / EFBAP	1	EFBAH	EFBAP	1	
	<b>UNGER EXCELLA REPLACEMENT TUBES (5)</b>		<b>MOP PAD HOLDER REPLACEMENT STRIPS (2)/(4)</b>			
<b>PART NO.</b>	<b>FOR USE WITH</b>	<b>CASE QTY.</b>	<b>PART NO.</b>	<b>SIZE</b>	<b>FOR USE WITH</b>	<b>CASE QTY.</b>
EFDTS	EFBTS / EFBTL / EFVAS / EFBAAH / EFBAP	1	15377	18" / 45 cm	EF40B	1
			20724	24" / 60 cm	EF40B	1



# ENGAGE WITH UNGER ONLINE!

Explore the complete line of professional, high quality cleaning supplies online at ungerglobal.com.

Whether looking for tips on cleaning tasks or more information on a specific product, ungerglobal.com is the perfect resource for cleaning professionals.

- Explore our comprehensive Online Resource Center, where you'll find a wide variety of downloadable catalogs, manuals, safety data sheets and how-to videos
- Check out our Unger Blog for relevant Industry news, cleaning tips and much more!
- Evaluate short and long term savings with our online ROI Calculators
- Instantly locate Unger suppliers throughout the US and Canada using our advanced Distributor Look-Up Tool
- Follow Unger USA on LinkedIn, Facebook, Instagram, YouTube and Twitter for product announcements, videos and industry information!

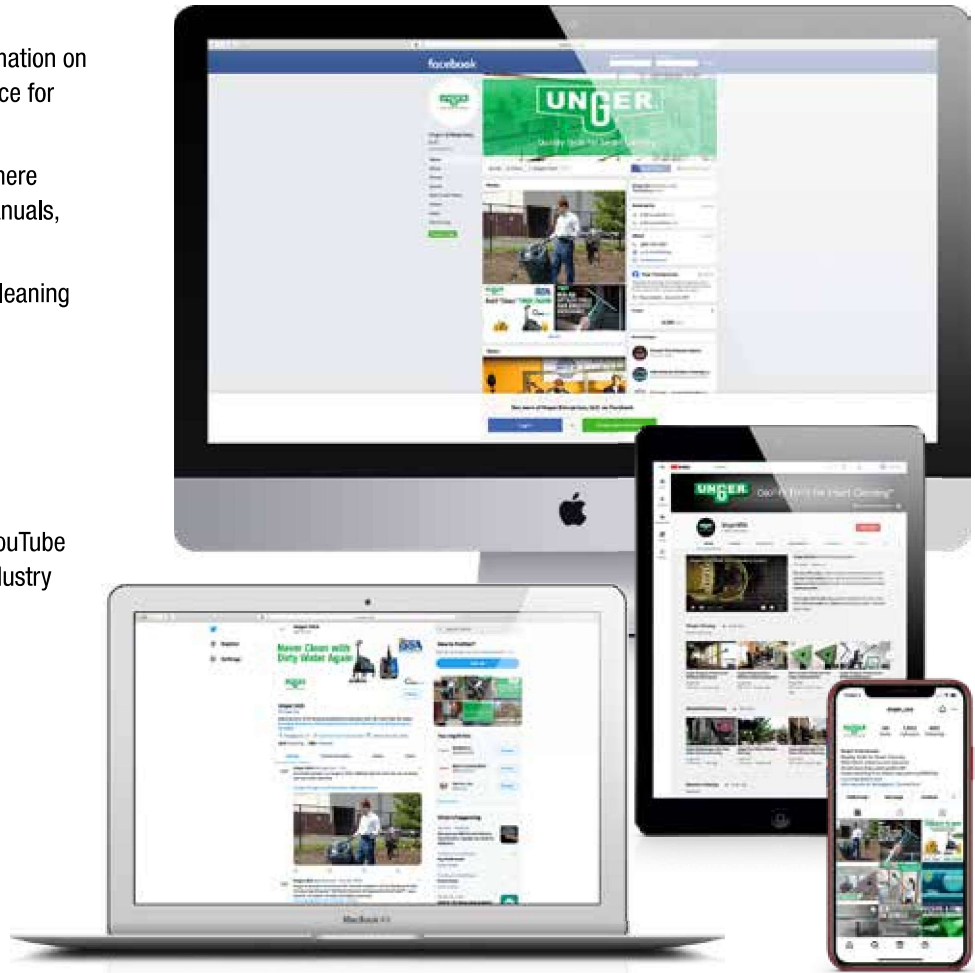

LinkedIn: Unger Enterprises



FB: @UngerUSA



Insta: @Unger\_USA



YT: UngerUSA



Twitter: @UngerUSA

## 100% SATISFACTION GUARANTEE

We design and build our tools to be tougher than the dirt they clean. We stand behind everything we make, 100%.

If for any reason you're not satisfied with an Unger tool, please return it to us within two years of purchase and we'll make it right.

Here's how:

Mail the item back to us at the address listed below along with a completed 100% Satisfaction Guarantee Form.

Unger Enterprises, LLC  
 Attn: Customer Satisfaction  
 650 Long Beach Blvd.  
 Stratford, CT 06615



We will replace the item with a comparable item based on style, functionality, and price. Please allow 4-6 weeks for processing. To help ensure fairness to all customers, we do require a receipt in certain situations. Please see our Special Conditions for details.

### Special Conditions

To help protect our customers and make sure every return or exchange is dealt with fairly, in certain situations we may either require a receipt or decline a return or exchange, including:

- We can't accept items for return that were not purchased directly from an Unger authorized distributor.
- If an item has a missing label or it has been defaced, we can't accept it for return without a receipt because we can't be certain it was purchased directly from an Unger authorized distributor.
- On rare occasions we may find it necessary to require a receipt for returns and exchanges based on the nature of prior transactions.
- For the safety of our employees, we can't accept items that have been soiled or contaminated until they have been cleaned.
- Normal wear and tear is not covered by the guarantee.

Questions?

Email us at: unger@ungerglobal.com

Call Customer Service at: 1.800.431.2324



Quality Tools for Smart Cleaning™

**100%**  
**CUSTOMER**  
**SATISFACTION**  
**GUARANTEE**

At Unger, we aim to stand apart from the rest thanks to our special “Yes We Can!” service spirit. We love what we do and as proof of that, we promise to deliver a 100% Customer Satisfaction Guarantee on every product and service we offer.

For our latest terms and conditions, please refer to our website:  
[usa.ungerglobal.com/terms-of-use/](http://usa.ungerglobal.com/terms-of-use/)

or scan here!



**THE MOST INNOVATIVE CLEANING TOOL SOLUTIONS  
FOR FASTER, SAFER AND CLEANER RESULTS**

Unger Enterprises, LLC  
425 Asylum Street  
Bridgeport, CT 06610  
Tel.: (1) 800.431.2324  
Fax: (1) 800.367.1988  
ungers@ungerglobal.com

Unger Germany GmbH  
Piepersberg 44  
D-42653 Solingen  
Tel.: (49) 212 2207 0  
Fax: (49) 212 2207 222  
ungereurope@ungerglobal.com

Unger UK Ltd.  
F1 Deansgate  
62-70 Tettenhall Road  
Wolverhampton, WV1 4TH  
Tel.: (44) 01902 306633  
Fax: (44) 01902 306644  
ungeluk@ungerglobal.com

