

**Effective Date 3/1/2013
With Addendum 5/13/2013, & 5/20/2013**

**Supersedes Price Book
1/20/2012**

tyco

Fire Protection Products

U. S. List Prices

for

**Sprinklers, Devices, Grooved Piping,
CPVC, Accessories and Repair Parts**

IMPORTANT NOTICE

Customer acknowledges and agrees that, in the absence of a previously executed agreement between the parties, products provided hereunder are provided pursuant to the Tyco Fire Products LP General Terms and Conditions of Sale. **CUSTOMER'S ATTENTION IS DIRECTED TO THE LIMITATION OF LIABILITY, WARRANTY, INDEMNITY AND OTHER CONDITIONS AVAILABLE AT: www.tyco-fire.com/terms**

Section 1 - Standard Spray Sprinklers

TY-L, Pendent, Recessed Pendent & Upright, K=5.6, 1/2" N.P.T.	1-1
TY-L, Pendent, Recessed Pendent & Upright, K=8.0, 3/4" N.P.T.	1-2
TY-L, Pendent, Recessed Pendent and Upright Sprinklers, K=8.0, 1/2" N.P.T.	1-3
TY-L, Horizontal Sidewall Sprinkler, K=5.6, 1/2" N.P.T.	1-3
TY-FRL, Pendent, Recessed Pendent & Upright, Quick Response Sprinkler, K=2.8, 1/2" N.P.T.	1-4
TY-FRL, Pendent, Recessed Pendent & Upright, Quick Response Sprinkler, K=5.6, 1/2" N.P.T.	1-5
TY-FRL, Pendent & Upright, Quick Response Sprinkler, K=8.0, 3/4" N.P.T.	1-6
TY-FRL, Horizontal Sidewall Sprinkler, K=5.6, 1/2" N.P.T.	1-6
TY-B, 5mm Bulb, Pendent, Recessed Pendent and Upright, K=5.6, 1/2" N.P.T.	1-7
TY-B, 5mm Bulb, Pendent and Upright Sprinklers, K=8.0, 1/2" N.P.T.	1-8
TY-B, 5mm Bulb, Pendent, Recessed Pendent and Upright Sprinklers, K=8.0, 3/4" N.P.T.	1-9
TY-B, 5mm Bulb, Horizontal, Recessed Horizontal, and Vertical Sidewall Sprinklers, K=5.6, 1/2" N.P.T.	1-10
TY-FRB, 3mm Bulb, Quick Response, Pendent, Recessed Pendent and Upright Sprinklers, K=2.8, 1/2" N.P.T.	1-11
TY-FRB, 3mm Bulb, Quick Response, Pendent, Recessed Pendent and Upright Sprinklers, K=4.2, 1/2" N.P.T.	1-12
TY-FRB, 3mm Bulb, Quick Response, Pendent, Recessed Pendent and Upright Sprinkler, K=5.6, 1/2" N.P.T.	1-13
TY-FRB, 3mm Bulb, Quick Response, Pendent, Recessed Pendent and Upright Sprinkler, K=8.0, 3/4" N.P.T.	1-14
TY-FRB, 3mm Bulb, Quick Response, Horizontal, Recessed Horizontal Sidewall and Vertical Sidewall, K=5.6, 1/2" N.P.T.	1-15
RFII, Standard Response, "Royal Flush II" Pendent Concealed Sprinklers, K=5.6, 1/2" N.P.T.	1-16
RFII, Quick Response, "Royal Flush II" Pendent Concealed Sprinklers, K=5.6, 1/2" N.P.T.	1-17
TYQR, Quick Response Standard Coverage, Flush Pendent Sprinkler, K=5.6, 1/2" N.P.T.	1-18
TY-B, 5mm Bulb, Pendent, Recessed Pendent and Upright, K=5.6, 1/2" N.P.T. (New Design)	1-19
TY-FRB, 3mm Bulb, Quick Response, Pendent, Recessed Pendent and Upright Sprinkler, K=5.6, 1/2" N.P.T. (New Design)	1-20

Section 2 - Extended Coverage Sprinklers

EC-14, Upright Sprinklers, K=14.0, 3/4" N.P.T.	2-1
EC-14, Pendent and Recessed Pendent Sprinklers, K=14.0, 3/4" N.P.T.	2-2
EC-11, Pendent, Recessed Pendent and Upright Sprinklers, K=11.2, 3/4" N.P.T.	2-3
TY-FRB, 3mm Bulb, Quick Response, Extended Coverage, Horizontal & Recessed Horizontal Sidewall, K=5.6, 1/2" N.P.T.	2-4
TY-FRB, 3mm Bulb, Quick Response, Extended Coverage, Horizontal & Recessed Horizontal Sidewall, K=8.0, 3/4" N.P.T.	2-5
ELO SW-20, ECOH, Sidewall Sprinklers, K=11.2, 3/4" N.P.T.	2-6
ELO SW-24, ECOH, Sidewall Sprinklers, K=11.2, 3/4" N.P.T.	2-6
ELOC Extended Coverage, Concealed Sprinklers, K=11.2, 3/4" N.P.T.	2-6
RFII, "Royal Flush II" Pendent Concealed Sprinklers Extended Coverage, Quick & Standard Response, K=5.6.	2-7
TY-FRL, Extended Coverage Quick Response, Horizontal Sidewall Sprinkler, K=5.6, 1/2" N.P.T.	2-7
TY-FRL, Quick Response, Extended Coverage Horizontal Sidewall Sprinklers, K=8.0, 3/4" N.P.T.	2-8
CHEC, ECLH Concealed Horizontal Sidewall Extended Coverage Sprinklers, K=8.0, 3/4" N.P.T.	2-8
EC-8, QR, ECLH, Pendent and Recessed Pendent Sprinklers, K=8.0, 3/4" N.P.T.	2-9
EC-5, QR, Pendent, Recessed Pendent and Sidewall Sprinklers, K=5.6, 1/2" N.P.T.	2-10

Section 3 - Storage Sprinklers

ESFR-25™, Early Suppression, Fast Response Sprinkler, K=25.2, 1" N.P.T.	3-1
EC-25, Upright, Area/Density, Extended Coverage, K=25.2, 1" N.P.T.	3-1
ESFR-17, Early Suppression, Fast Response Upright Sprinkler, K=16.8, 3/4" N.P.T.	3-1
ESFR-17, Early Suppression, Fast Response Pendent Sprinkler, K=16.8, 3/4" N.P.T.	3-2
ESFR-17, Dry-Type, Early Suppression, Fast Response Pendent Sprinkler, K=16.8, 1-1/4" N.P.T.	3-2
ESFR-1, Early Suppression, Fast Response Sprinkler, K=14.0, 3/4" N.P.T.	3-3
Ultra K17, Upright, Thread Specific Application, K=16.8, 3/4" N.P.T.	3-3
K17-231, Thread, Upright, K=16.8, 3/4" N.P.T.	3-4
K17-231, Thread, Pendent, K=16.8, 3/4" N.P.T.	3-4
ELO-231, Standard Response, Upright and Pendent Sprinklers, K=11.2, 1/2" N.P.T. & 3/4" N.P.T.	3-5
ELO-231B, Standard Response, Upright and Pendent Sprinklers, K=11.2, 1/2" N.P.T. & 3/4" N.P.T.	3-6
ELO-231 FRB, Quick Response, Upright, Pendent Sprinklers, K=11.2, 3/4" N.P.T.	3-7
LD, Large Drop Upright Sprinklers, K=11.2, 3/4" N.P.T.	3-7
TY-B, 5mm Bulb, Standard Response, Intermediate Level Upright and Pendent Sprinklers with Shield, K=5.6, 1/2" N.P.T.	3-8
TY-B, 5mm Bulb, Standard Response, Intermediate Level Upright and Pendent Sprinklers with Shield, K=8.0, 3/4" N.P.T.	3-9
TY-FRB, 3mm Bulb, Quick Response, Intermediate Level Upright and Pendent Sprinklers with Shield, K=5.6, 1/2" N.P.T.	3-10
TY-FRB, 3mm Bulb, Quick Response, Intermediate Level Upright and Pendent Sprinklers with Shield, K=8.0, 3/4" N.P.T.	3-11
TY-L, Standard Response, Intermediate Level Upright and Pendent Sprinklers with Shield, K=5.6, 1/2" N.P.T.	3-12
TY-L, Standard Response, Intermediate Level Upright and Pendent Sprinklers with Shield, K=8.0, 3/4" N.P.T.	3-13
TY-FRL, Quick Response, Intermediate Level Upright and Pendent Sprinkler with Shield, K=5.6, 1/2" N.P.T.	3-14
TY-FRL, Quick Response, Intermediate Level Upright and Pendent Sprinkler with Shield, K=8.0, 3/4" N.P.T.	3-15

Visit www.tyco-fire.com/terms for terms and conditions of sale.

Section 4 - Residential Products

LFII, Low Flow Pendent, Fast Response, K=3.0, 1/2" N.P.T.	4-1
LFII, Low Flow Horizontal Sidewall, K=4.2, 1/2" N.P.T.	4-1
LFII, Low Flow Horizontal Sidewall, K=4.4, 1/2" N.P.T.	4-2
LFII, Low Flow Pendent, K=4.9, 1/2" N.P.T.	4-2
LFII, Residential Concealed Pendent Domed Plate, K=4.9 (pendent), 1/2" N.P.T.	4-3
LFII, Residential Flat-Plate Concealed Sprinkler, K=4.9, 1/2" N.P.T.	4-3
LFII, Residential Flush Pendent, K=4.2, 1/2" N.P.T.	4-4
LFII, Residential Flush Horizontal Sidewall Sprinkler, K=4.2, 1/2" N.P.T.	4-4
LFII, Residential NFPA 13 Optimized Horizontal Sidewall Sprinkler, K=5.8 & K=5.6, 1/2" N.P.T.	4-5
LFII, Residential NFPA 13 Optimized Pendent Recessed & Concealed, K=6.9, 3/4" N.P.T.	4-6
LFII, Residential Dry, Recessed Pendent and Domed Concealed Pendent, K=4.9	4-7
LFII, Residential Dry, Horizontal Sidewall and Recessed Horizontal Sidewall, K=4.4	4-7
RCP-1, Residential Control Panel 1" & 1 1/2", 175 psi	4-8
Residential Domestic Shutoff Valve	4-9

Section 5 - Dry Sprinklers

DS-1, Dry, Standard Coverage, Pendent, Upright & Horizontal Sidewall, Standard Response, K=5.6, 1" NPT.	5-1
DS-1, Dry, Standard Coverage, Pendent, & Horizontal Sidewall, Standard Response, K=5.6, 3/4" NPT.	5-2
DS-1, Dry, Standard Coverage, Pendent, Upright & Horizontal Sidewall, Quick Response, K=5.6	5-3
DS-1, Dry, Extended Coverage, Horizontal Sidewall, Quick Response & Standard Response, K=5.6	5-4
DS-1, Dry, Stainless Steel, Standard Coverage, Pendent, QR or SR, K=5.6	5-5
DS-1, Dry, Stainless Steel, Standard & Extended Coverage, Horizontal Sidewall, QR or SR, K=5.6	5-6
DS-2, Dry, ELO Standard Coverage, Pendent, Standard Response, K=11.2.	5-7
DS-2, Dry, ELO Standard Coverage, Pendent, Quick Response, K=11.2	5-8
DS-2, Dry, ELO Extended Coverage, Pendent, Quick Response & Standard Response, K=11.2.	5-9
DS-3, Dry, Extended Coverage Ordinary Hazard (EOH), Horizontal Sidewall, 1" NPT, 3 mm bulb, K=11.2	5-10
DS-C, Dry Concealed, Standard Response, K=5.6	5-11
DS-C, Dry Concealed, Quick Response, K=5.6	5-12
DS-ECC, Dry Extended Concealed Coverage, Quick Response, K=5.6	5-13
ESFR-17, Dry-Type, Early Suppression, Fast Response Pendent Sprinkler, K=16.8, 1-1/4" N.P.T.	5-14

Section 6 - Special Sprinklers

Illusion™ Casino Sprinkler ELO Extra Large Orifice, Concealed Pendent Sprinklers, K=11.2, 3/4" N.P.T.	6-1
CC2, Combustible Concealed Space Upright Sprinklers, K=5.6, 1/2" N.P.T.	6-1
CC2, Combustible Concealed Space Upright Sprinklers, K=4.2, 1/2" N.P.T.	6-2
CC1, Combustible Concealed Space Upright Sprinklers, K=2.8, 1/2" N.P.T.	6-2
WS Window Sprinklers, K=5.6, 1/2" N.P.T.	6-2
Attic Sprinklers, K=4.2, 1/2" N.P.T., K=5.6, 1/2" N.P.T. & K=8.0, 3/4" N.P.T., Models BB, SD, HIP & AP	6-3
TFP TY-B, Stainless Steel & Titanium, Upright and Pendent Sprinkler, K=5.6 & 8.0, 1/2" & 3/4" N.P.T.	6-4
TFP TY-B, Stainless Steel & Titanium, Horizontal Sidewall Sprinkler, K=5.6 & 8.0, 1/2" & 3/4" N.P.T.	6-5
TFP TY-FRB, Stainless Steel & Titanium, Upright and Pendent Sprinkler, QR, K=5.6 & 8.0, 1/2" & 3/4" N.P.T.	6-6
TFP TY-FRB, Stainless Steel & Titanium, Horizontal Sidewall Sprinkler, QR, K=5.6 & 8.0, 1/2" & 3/4" N.P.T.	6-7
Tyco® RAVEN™, I-Series Institutional Pendent & Horizontal Sidewall Sprinkler, QR, Standard & Extended Coverage	6-8
PH2, Institutional Pendent, Standard Response Sprinkler, K=5.6, 1/2" N.P.T.	6-9
PH5, Institutional Horizontal Sidewall, Standard Response Sprinkler, K=5.6, 1/2" N.P.T.	6-10
TY-B, 5mm Bulb, Conventional (Old Style) Sprinklers, K=5.6, 1/2" N.P.T.	6-11
TY-B, 5mm Bulb, Conventional (Old Style) Sprinklers, K=8.0, 3/4" N.P.T.	6-12
TY-FRB, 3mm Bulb, Quick Response, Conventional (Old Style) Sprinklers, K=5.6, 1/2" N.P.T.	6-13
TY-FRB, 3mm Bulb, Quick Response, Conventional (Old Style) Sprinklers, K=8.0, 3/4" NPT.	6-14
Issue "D" Quartzoid®, High Temperature, K=5.6, 1/2" N.P.T.	6-15
Issue "D" Quartzoid®, Series – High Temperature, K=8.0, 3/4" NPT.	6-16
TY-B, 5mm Bulb, Conventional (Old Style) Sprinklers, K=5.6, 1/2" N.P.T. (New Design)	6-17
TY-FRB, 3mm Bulb, Quick Response, Conventional (Old Style) Sprinklers, K=5.6, 1/2" N.P.T. (New Design)	6-18

Section 7 - Nozzles and Sprinkler Accessories

D-3, Protectospray Nozzles, 1/2" N.P.T.	7-1
EA-1, Protectospray Nozzles	7-2
Mulsifyre Nozzles, 800 Series, 3/4" NPT Connection.	7-3
High Velocity Spray Nozzles Type HV.	7-3
Cooling Tower Nozzles, 3/4" NPT, K=2.90	7-4
Exposure Sprinklers, Model A, 1/2" NPT	7-4
Exposure Nozzles, B, 3/4" NPT	7-4
B-1, 1/2" Foam Water Sprinkler, 1/2" Male NPT.	7-5
U.S. Navy, Nozzle, Type G, 1/2" NPT	7-5
U.S. Navy, Nozzle, Type SB, 1/2" NPT	7-5
Protectospray Nozzles, Type D4-A, 1/2" NPT	7-6
AM4, WaterMist Nozzles, Open Type, 1/2" NPT	7-6
AM6, WaterMist Nozzles, Bulb Type, 1/2" NPT	7-7
AM10, WaterMist Nozzles, Open Type, 1/2" NPT	7-7
AM11, WaterMist Nozzles, Bulb Type, 1/2" NPT	7-8
AM22, WaterMist Nozzles, Bulb Type, 1/2" NPT	7-8
AM24, WaterMist Nozzles, Bulb Type, 1/2" NPT	7-9
FTR-1, Fixed Temperature Release for Deluge & Preaction Systems Wet or Dry Pilot Release Service, 1/2" NPT	7-9
Blow-Off Caps and Dust Caps for Mulsifyre Projectors and Nozzles	7-10
Blow-Off Plugs for Protectospray Nozzles, Model D-3	7-10
Miscellaneous Escutcheons	7-10
Typical Escutcheons	7-11
Sprinkler Head Cabinets	7-12
G1 and G4 Sprinkler Guards, G1/S1 and G4/S3 Guards and Shields	7-12
DS-1 Dry Sprinkler Guard.	7-12
G2 Guard, WS-2 Shield and WSG-2 Guard & Shield for ELO-231 Series	7-13
Special Services	7-13
Sprinkler Wrenches	7-14

Section 8 - Wet System Valves

AV-1-300, Alarm Valves	8-1, 8-2
CV-1FR, Shotgun Riser Check Valve	8-2
Residential Domestic Shutoff Valve	8-3
Riser Manifolds – Commercial & Residential	8-3
RC-1, Retard Chamber	8-4
Resi-Risers	8-4

Section 9 - Water Motor Alarms

WMA-1, Water Motor Alarm.	9-1
-----------------------------------	-----

Section 10 - Dry Pipe Valves

DPV-1, Dry Pipe Valve	10-1
---------------------------------	------

Section 11 - Quick Opening Devices

"VISOR" Model EDPA - Electronic Dry Pipe Accelerator	11-1
QRS, Electronic Accelerator	11-2
ACC-1, Dry Pipe Valve Accelerator	11-3

Section 12 - Air Maintenance Devices

Air Maintenance Devices	12-1
Accessories for Air Maintenance Devices	12-1

Section 13 - Deluge Valves & Accessories

DV-5, Deluge Valves, Diaphragm Style	13-1, 13-2
DP-1, Dry Pilot Actuator	13-3
Deluge Valve Accessories	13-3
Model DV-5 Deluge Valves With Remote-Resetting Trim	13-4, 13-5
Model DV-5 Deluge Valves With Remote-Resetting, Pressure-Reducing Trim	13-6, 13-7
Full Deluge Systems and Components	
DV-5 Deluge Valves, Wet Pilot Actuation – 1½" thru 8"	13-8
DV-5 Deluge Valves, Dry Pilot Actuation – 1½" thru 8"	13-9
DV-5 Deluge Valves, Electric Actuation – 1½" thru 8"	13-10
Red-E-Cabinets, with DV-5 Valves, Deluge, Double Interlock and Preaction Systems in Cabinets	13-11 thru 13-13
Red-E-Cabinets, with "MCC" Mist Control Center, Preassembled Fire Pump, Controller, Deluge Valve Cabinet.	13-14
DV-5 Deluge Valve and Preaction Pre-Trimmed, Wet Pilot, Dry Pilot, & Electric Actuation	13-15
DV-5 Deluge Valve and Preaction Pre-Trimmed, Single or Double Interlock	13-16
DV-5 Deluge Valve and Preaction Pre-Trimmed, Remote-Resetting Trim, or Remote-Resetting, Pressure-Reducing Trim	13-17

Section 14 - Preaction Systems

Full Preaction Systems and Components	
DV-5 Single Interlock, Wet Pilot Actuation, 1½" thru 8"	14-1
DV-5 Single Interlock, Dry Pilot Actuation, 1½" thru 8"	14-2
DV-5 Single Interlock, Electric Actuation, 1½" thru 8"	14-3
DV-5 Double Interlock, Electric/Pneumatic Actuation, 1½" thru 8"	14-4
DV-5 Double Interlock, Electric/Electric Actuation, 1½" thru 8"	14-5
Optional Equipment for Single Interlock, Preaction Systems, Supervised	14-6
Preaction Trim for Model DV-5	14-7, 14-8

Section 15 - General Purpose Valves

CV-1F Grooved Check Valves	15-1
BFV-N Butterfly Valves - Wafer Style with Supervisory Switches - 250psi	15-2
BFV-N Butterfly Valves - Lug Style with Supervisory Switches - 250psi	15-2
Additional Wafer and Lug Lengths, withPIVA	15-2
BFV-N Butterfly Valves - G x G, Gear Operated with Tamper Switches - 300psi	15-3
PRV-1 Pressure Regulating Valve, 2" thru 8", 250 psi, Pilot Operated	15-3
Model RV-1 Pressure Relief Valves 2" thru 8", 250 psi, Pilot Operated, Globe and Angle Body Styles	15-4

Section 16 - Specialty Items

Valve System Accessories	16-1
F350 Sectional Control Accessories	16-1
F1321 Sight Flow Connection	16-1
Ball Drip Valves	16-1
Fill or Drip Cups	16-1
DD-1 (Drum Drip) Wiliag Drain	16-1
Manual Control Stations	16-2
G16AC812 Automatic Supervisory Air Supply	16-2
Water and Air Gauges	16-2
Fusible Links/Fire Door Links Type C	16-2
Zonecheck Flow Switch Tester	16-3
"A" Strainers and SS Baskets	16-3
"B-1" Strainer, Painted Finish and SS Baskets	16-4
"C" Strainer, Heavy Duty, Welded Body	16-4
Sprinkler Identification Signs	16-5
Restriction Unions	16-5

Section 17 - Steel Pipe & Threaded Fittings

Contact your TFPP Representative. (not included in this price book)

Section 18 - Grooved Products *

#577 G-FIRE Global and Domestic – Rigid Coupling with Grade “A” EPDM Fire Protection Pre-Lubricated Gasket	18-1
#577 G-FIRE Domestic – Rigid Tri-Seal Coupling with Grade “E” EPDM Tri-Seal Gasket	18-1
#705 Global and Domestic – Flexible Coupling with Grade “A” EPDM Fire Protection Pre-Lubricated Gasket	18-2
#705 Domestic – Flexible Tri-Seal Coupling with Grade “E” EPDM Tri-Seal Gasket	18-2
#707 Domestic Heavy-Duty Flexible Coupling with Grade “E” EPDM Gasket	18-3
#707 Domestic Heavy-Duty Flexible Coupling with Grade “E” EPDM Tri-Seal Gasket	18-3
#716 Domestic – Reducing Coupling with Grade “E” EPDM Non-Lubricated Gasket	18-4
#716 Reducing Coupling Plate	18-4
Replacement Gaskets, Grade “E” EPDM Gasket for #716 Reducing Coupling	18-4
#71 Domestic – Grooved Flange Adapter with Grade “E” EPDM Non-Lubricated Gasket	18-5
#71 Flange Adapter – Metal Washer & Nut, Bolt, and Gasket Kit	18-5
#702 Global – Outlet Coupling Grade “E” Gasket, Female Threaded End	18-6
#702 Global – Outlet Coupling Grade “E” Gasket, Male Threaded End	18-6
#702 Global – Outlet Coupling Grade “E” Gasket, Grooved End	18-6
Replacement Gaskets	18-7
Coupling Nut and Bolt Kit	18-7
GRINNELL Gasket Lubricant	18-7
Pipe Tape	18-7
#510S Global and Domestic – Fire Protection Short Pattern Grooved 90° Elbow	18-8
#519S Global and Domestic – Fire Protection Short Pattern Grooved Tee	18-8
#501 Global and Domestic – Fire Protection Standard Pattern Grooved 45° Elbow	18-8
#510 Global and Domestic – Fire Protection Standard Pattern Grooved 90° Elbow	18-9
#510DE Domestic – 90° Elbow with 1" Outlet	18-9
#519 Global and Domestic – Fire Protection Standard Pattern Grooved Tee	18-9
#260 Domestic and Global – Grooved Cap	18-10
#260 Domestic and Global – Grooved Cap with 1/2" Tap	18-10
#260 Domestic and Global – Grooved Cap with 1" Tap	18-10
#40-5 Domestic – Strap	18-11
ADACAP #750 Domestic	18-11
#512 Domestic – Grooved 22 1/2° Elbow	18-12
#511 Domestic – Grooved 11 1/4° Elbow	18-12
#321 Domestic – Grooved Reducing Tee	18-13
#550 and #350 Domestic – Concentric Reducer	18-14
#341 Domestic – Grooved x Flanged Adapter 150 Lbs. – Schedule 40	18-15
#342 Domestic – Grooved x Flanged Adapter 300 Lbs. – Schedule 40	18-15
#320 Domestic – Grooved x Male Thread Tee	18-15
Standpipe Domestic – Tee	18-16
#507/#50L Domestic – Bullhead Tee	18-16
#323 Domestic – Reducing Tee with Threaded Branch	18-16
#327 Domestic – Grooved Cross	18-17
#372 Domestic – Reducer Small End Threaded (Male)	18-17
#391 Domestic – Groove x Male Thread Adapter Nipple	18-18
#392 Domestic – Groove x Groove Adapter Nipple	18-18
#393 Domestic – Groove x Plain Adapter Nipple	18-19
#730 Domestic – Threaded Mechanical Tee with Grade “E” EPDM Gasket Threaded Outlet	18-20
#730 Domestic – Grooved Mechanical Tee with Grade “E” EPDM Gasket Grooved Outlet	18-21
#730 Domestic – Threaded Mechanical Cross with Grade “E” EPDM Gasket Threaded Outlet	18-22
#730 Domestic – Grooved Mechanical Cross with Grade “E” EPDM Gasket Grooved Outlet	18-23
#BFV-N Domestic – Grooved Butterfly Valves Fire Protection	18-24
#CV-1F Global – Grooved Check Valve	18-24
Roll Grooving Machine Selection Chart	18-25
Roll Grooving – Accessories	18-25
Roll Grooving – Roll Selection Chart	18-26
Domestic Grooved Couplings – Packaging Quantity	18-27
Domestic Grooved Fittings – Packaging Quantity	18-27 – 18-28
Grooved Fittings – Pieces Per Carton/Case	18-28
Global Grooved Couplings – Packaging Quantity	18-29
Global Grooved Fittings – Packaging Quantity	18-29

*As used in this Table of Contents and Price Book, the designation “domestic” is meant to identify where the last point of manufacture or assembly takes place for a product. However, this designation does not represent compliance with any government regulatory standards or contract specifications and should not be relied upon for such purposes. You must request separate certifications or other representations concerning the specific regulatory standards or contract specifications which apply for your application.

In order to request regulatory or specification certifications/representations please contact Tyco Trade Compliance at 215-362-0700 for assistance. In your request, please identify the part numbers and specific regulatory standards or contract specifications about which you are inquiring.

Visit www.tyco-fire.com/terms for terms and conditions of sale.

Section 19 - CPVC

Cap (Slip)	19-1
Coupling (Slip x Slip)	19-1
Reducing Coupling (Slip x Slip)	19-1
90° Elbow (Slip x Slip)	19-1
45° Elbow (Slip x Slip)	19-1
Tee (Slip x Slip x Slip)	19-1
Reducing Tee (Slip x Slip x Slip)	19-2
Cross (Slip x Slip x Slip x Slip)	19-2
Reducer Bushing (Slip x Slip)	19-2
Female Sprinkler Head Adapter (Slip x FIPT) with Brass Threaded Insert	19-3
Back-to-Back Tee, Sprinkler Head Adapter (FIPT x FIPT x Slip) with Brass Threaded Inserts	19-3
Back-to-Back Cross Sprinkler Head Adapter (Slip x FIPT) with Brass Threaded Inserts	19-3
Spigot Sprinkler Head Adapter (Slip x FIPT) with Brass Threaded Insert	19-3
Sprinkler Head 90° Elbow (Slip x FIPT) with Brass Threaded Insert	19-3
Sprinkler Head Tee (Slip x Female) with Brass Threaded Insert	19-3
CPVC to Female Adapter (slip x female) with Brass Threaded Insert	19-4
Male Adapter (Slip x Male) with Brass Threaded Insert	19-4
Grooved Coupling Adapter (Groove x Slip)	19-4
CPVC Pipe	19-5
Primers & Cements	19-6
Accessories	19-6
Fire Stop	19-6
Rothenberger Tools	19-6
Tyco Fire Products CPVC Tools	19-6
McNulty Tools	19-6
Reed Tool Manufacturing	19-6

Section 20 - Miscellaneous

Discontinued Valve Replacement Parts	
Model "AF" or "AG" - 4" Dry Pipe Valve (2002)	20-1
Model "AF" or "AG" - 6" Dry Pipe Valves (2002)	20-1
Model "H & K" - 4" Dry Pipe Valve (1988)	20-1
Model "H & K" - 6" Dry Pipe Valve (1988)	20-1
Model "D" - 2" & 2½" Dry Pipe Valve (1988)	20-2
Model "D" - 3" Dry Pipe Valve (1988)	20-2
Model "D" - 4" Dry Pipe Valve (1988)	20-2
Model "A" - 4" Deluge Valve (2001)	20-2
Model "A" - 6" Deluge Valve (2001)	20-2
Model DV-3 Deluge Valve (2007)	20-3
Model "F" and "G" - 2½" thru 8" Alarm Valve (2003)	20-3
Model "AF" 2", 2½" and 3" Dry Pipe Valves/Trim (2007)	20-4
Model F-302 & F-3021, 4" Dry Pipe Valve Replacement Parts (2002)	20-4
Model F-302 & F-3021, 6" Dry Pipe Valve Replacement Parts (2002)	20-4
Model A-2, 2" Dry Pipe Valve Replacement Parts (1999)	20-4
Model B Deluge Valve (2004)	20-5
Model DV-1 Deluge Valves (2007)	20-5
Model E Alarm Check Valve 8" - (1999)	20-6
Model F Alarm Check Valves 4" & 6" - (1999)	20-6
Model A-1 Dry Pipe Valves, 4" & 6" (2002)	20-6
Model F and G Dry Pipe Valves 3", 4" & 6" (1985)	20-7
Model "A-1" Preaction Valve (2003)	20-7
Model "D" - Deluge Valve 3", 6" & Coils - (Electromatic) (2002)	20-8
Model BB - Exhauster (2006)	20-8
Discontinued Sprinkler Accessories	
A Royal Flush Concealed Ceiling Plate Assembly (2002)	20-9
Starmist Escutcheons (2002)	20-9
LFII - Residential Concealed Sprinkler, K=4.2, 1/2" N.P.T. (2010)	20-10
LFII - Residential Concealed Sprinkler, K=4.9, 1/2" N.P.T. (2010)	20-10

Section 21 - Electrical

Electrical	
Waterflow Switches	21-1
Tamper Switches - OS&Y	21-1
Tamper Switches - Butterfly/PIV	21-1
Pressure Switches	21-1
Explosion Proof Switches	21-1
Switches for Copper Systems	21-1
Electric Bells	21-1
Weatherproof Backbox	21-1
Horns	21-1
Release Panel	21-1
Batteries for Release Panel	21-1
Corrosion Inhibiting Device	21-1
Solenoid Valves	
Ordinary Location	21-1
Hazardous Location	21-1
Heat Detectors	21-1
Horn Strobes	21-1
General Air Products	
Air Compressors	21-2
Magnetic Line Starter	21-2
Riser Mount Kits - Universal Bracket	21-2
Dry Air Pacs	21-2
Accessories	21-2
Quell Fire Sprinkler Systems Products	
Thermocable LHD - Linear Heat Detection Wire, PVC Jacket (Vinyl)	21-3
Mounting Straps, Temperatures -40°F to 185°F	21-3
Mounting Clips and Clamps, Temperatures -40°F to 185°F	21-4
GuideWire Mounting Accessories	21-4
Surface Mounting	21-5
Installation	21-5
Cable Connecting Accessories	21-5
Cable Splicing Accessories	21-6
Fire Alarm Control / Releasing Panel - Modules	21-6

Section C - Valves and Hose Equipment

Kennedy Valves	
O.S.&Y. Gate Valve UL/FM Resilient Wedge with ¾" Tap and Plug - Model #4068A	C-1
O.S.&Y. Valve Flanged x Grooved - Model #7092A	C-1
Grooved Check Valve - Model #426	C-1
Iron Body Swing Check Valves UL/FM Flanged 175 PSI – Model 126A	C-1
Wafer Check Valves UL/FM 300 PSI – Model 706	C-1
Flanged PIV Non Rising Stem Gate Valve Resilient Wedge – Model 4701	C-1
#01G - Grooved BFV	C-1
#01G - Wafer BFV	C-1
PIV, NRS Gate Valve UL/FM Mechanical Joint with Accessories Resilient Wedge – Model 4071	C-1
Wall Post Indicator Model 641-13 Includes Stem and Coupling	C-1
Vertical Post Indicator (Formerly Model #741)	C-1
Babbitt Valve Chainwheels	
Cast Iron Standard Chainwheel	C-1
Epoxy Coated Corrosion Resistant Chainwheel	C-1
Hot Dipped Galvanized Standard Chain	C-1
United Brass Bronze Valves	
Globe Valves	C-2
Swing Checks	C-2
Ball Valves	C-2
Angle Valves	C-2
OS&Y Valves	C-2
Lansdale Powerball 300 Valves	
Slow Close Valve with Integral Tamper Switch	C-2
Trim Valves	
Globe Valves	C-2
Swing Checks	C-2
Ball Valves	C-2
Angle Valves	C-2
Hose Valves & FDC's	
Hose Valves	C-3
STORZ Equipment	C-3
Fire Department Connections	C-3
Croker Standpipe and Hose Equipment	
Hose Rack Units	C-3
Adjustable Fog Nozzles	C-3
Fire Hose	C-3
Hose Valves	C-3
Fire Department Inlet Connections	C-4 – C-5
Check Valves	C-5
Storz Connections (with Plate & Cap)	C-5
Roof Manifolds (Body Only)	C-5
Cabinets	C-5
Guardian Standpipe and Hose Equipment	
Hose Rack Units	C-6
Adjustable Fog Nozzles	C-6
Fire Hose	C-6
Hose Valves	C-6
Reducer	C-6
Pressure Restricting Hose Valves	C-6
Fire Department Inlet Connections	C-6 – C-7
Check Valves	C-7
Storz Connections (with Plate & Cap)	C-7
Roof Manifolds (Body Only)	C-8
Cabinets	C-8

Section "D" Backflow

Ames	
Model Maxim M200 With FxG OS&Y Valve	D-1
Model Maxim M200 With Grooved Butterfly Valve	D-1
Model Maxim M300 DCDA With FxG OS&Y Valve (GPM Meter)	D-1
Model Maxim M300 DCDA With FxG OS&Y Valve (CFM Meter)	D-1
Model Maxim M300 DCDA With Grooved Butterfly Valve (GPM Meter)	D-1
Model Maxim M300 DCDA With Grooved Butterfly Valve (CFM Meter)	D-1
Model Maxim M400 With FxG OS&Y Valve	D-1
Model Maxim M400N With Grooved Butterfly Valve	D-1
Model Maxim M500 RPDA With FxG OS&Y Valve (GPM Meter)	D-1
Model Maxim M500 RPDA With FxG OS&Y Valve (CFM Meter)	D-1
Model Maxim M500N RPDA With Grooved Butterfly Valve (GPM Meter)	D-1
Model Maxim M500N RPDA With Grooved Butterfly Valve (CFM Meter)	D-1
Model 1000 DCV Detector Check	D-1
Model 1005 DCV Detector Check	D-1
Model 2000B Brass Double Check Assy	D-1
Model 3000B Brass Assembly	D-2
Model 4000B Brass Reduced Pressure Backflow Assy	D-2
Model 2000 SS Double Check Backflow Assembly	D-2
Model 3000 SS Double Check Detector Backflow Assembly	D-2
Model 4000 SS Reduced Pressure Backflow Prevention Assembly	D-2
Model 5000 SS Reduced Pressure Detector Assembly	D-2
Air Gap Drains Model 2001 SS Double Check Assembly	D-2
Maxim/Colt Air Gap Drains	D-2
Colt	
Model C200 Double Check Assembly	D-3
Model C300 Double Check Detector Assembly	D-3
Model C400 Reduced Pressure Assembly	D-3
Model C500 Reduced Pressure Detector Assembly	D-3
Febco	
Model 850 Double Check Assembly	D-3
Model 870V (Vertical) Double Check Assembly	D-3
Model 856 Double Check Detector Assembly	D-3
Model 876V (Vertical) Double Check Detector Assembly (with O.S.&Y. Valves)	D-4
Model 860 Reduced Pressure Assembly (with O.S.&Y. Valves)	D-4
Model 880V Reduced Pressure Assembly	D-4
Model 826 Reduced Pressure Detector Assembly	D-4
Model 850U Double Check Assembly	D-4
Model 850 Double Check Assembly	D-4
Model 860 Reduced Pressure Assembly	D-4
Model 825 Y Reduced Pressure Assembly	D-4
Air Gaps Drains	D-4
Wilkins	
Model 310 & 310A Single Check Valve Assembly	D-5
Model 350AB & 350A Double Check Valve	D-5
Model 350ADA Double Check Detector	D-5
Model 375 Reduced Pressure Principle	D-5
Model 375ADA Reduced Pressure Detector Assembly	D-5, D-6
Model 475 Reduced Pressure Principle	D-6
Model 950XL Double Check Valve Assembly	D-6
Model 975 Reduced Pressure Principle	D-6
Watts Regulator (Small Backflow Preventors)	
Model 007 LF, Model 007 QT Double Check Backflow	D-7
Model 009 LF, Model 009 QT Reduced Pressure Backflow	D-7
Air Gap Drains	D-7
Backflow Repair Kits	D-7
Model 709 Double Check Valve Backflow Assembly	D-7
Model 007/709 Double Check Detector Assembly	D-7
Model 009/909 Reduced Pressure Zone Backflow Preventor	D-7, D-8
Model 909 Reduced Pressure Zone Backflow Detector Assembly	D-8

Visit www.tyco-fire.com/terms for terms and conditions of sale.

Section "F" Pipe & Accessories

SCI		
SCI Coop-Let F.T. & Grooved		F-1
Merit		
Grooved Outlets		F-2
Adjustable Drop Nipples		F-2
Welded Flange		F-2
Flexhead Flexible Drop Nipples		F-2
SprinkFlex Flexible Drop Nipples		F-2
Test/Drain Assemblies		F-3
Sight Drains		F-3
Bolt, Nut, Gasket Kits		F-3
Red Rubber Gaskets		F-3
Split Rings Plastic Floor and Ceiling Plates		F-3
Flanged Fittings		
Flanged 90° Elbow		F-4
Flanged 45° Elbow		F-4
Flanged Straight Tee		F-4
Flanged Reducing Tee		F-4
Cast Iron Companion Flange		F-4
Flanged Concentric Reducer		F-4
Blind Flange		F-4
Long Radius Flanged 90° Elbow		F-4
Floor Flange		F-4
Flanged Reducing 90° Elbow		F-5
Flanged Bull Tee		F-5
Flanged Eccentric Reducer		F-5
Ductile Iron Fittings		
#811 Ductile Iron 90° Elbows		F-5
#813 Ductile Iron 45° Elbows		F-5
#814 Ductile Iron Tees		F-5
#818 Ductile Iron Couplings		F-5
#820 Ductile Iron Caps		F-5
#817 Ductile Iron Crosses		F-5
#719 Ductile Iron Plugs		F-5
#825 Ductile Iron Extension Pieces		F-5
#817 Ductile Iron Reducing Crosses		F-5
#827 Ductile Iron Hex Bushings		F-5
#816 Ductile Iron Reducing Couplings		F-6
#830 Ductile Iron Unions		F-6
#812 Ductile Iron Reducing 90° Elbows		F-6
#815 Ductile Iron Reducing Tees		F-6
Central Sprinkler California Fittings		F-7
Male Outlets Tees		F-7
Male 90° Street Elbow		F-7
Standard Black Nipple		F-7
Extra Heavy Black Nipple		F-8
Galvanized Nipple		F-8

Section "H" Hangers

Erico Hangers	
CPVC Hangers & Surge Restraints	H-1
CPVC Hangers - Head Set Bracket	H-1
Heavy Duty Swivel Hanger - Model 115	H-1
Beam Clamps - Model 300	H-1
Heavy Duty Beam Clamps - Model 547	H-1
Steel C-Clamp - Model 200	H-1
Eye Sockets - Model 37	H-1
300-C Retaining Strap (Bulk Units)	H-1
Eye Socket Offset - Model 38	H-1
Wide Flange Purlin Clamp - Model 315	H-1
Steel Wood Drive Screw - Model 43	H-1
Steel Rod Coupling - Model 25	H-2
Knurled Hanger Inserts - Model 100N	H-2
Coach Screw Rod Machine Thread - Model 41	H-2
Lag Screw - Model 42	H-2
Clevis Hanger Standard - Model 400	H-2
Concrete Insert - Model 355 & 355N	H-2
Nail Plate - Model 30482	H-2
Plastic Rod Button - Model 15	H-2
Toggle - Model 148	H-2
Pipe Clamp Standard - Model 450	H-2
Riser Clamp - Model 510	H-2
Steel Side Beam Attachment - Model 325	H-3
Tapped Side Beam Steel Connector - Model 328	H-3
Steel Wall Plate - Model 365	H-3
Yook U Type Hanger - Model 135 (Fits 1" & 1 1/4" Pipe)	H-3
Yook Wrap-a-Round U Type Hanger Model 137	H-3
Strut Clamp - Model RIGD	H-3
Multi-Flange Rod Hanger	H-3
Tolco for CPVC	
Hangers for CPVC Plastic Pipe, Model 22, Model 23, Model 24	H-4
Ring Hangers - Model 200	H-4
Tolco Earthquake Bracing	
Fast Clamp Sway Brace Attachment - #1000 & #1001	H-4
Longitudinal 4-way Brace Attachment - #907	H-4
Non-Threaded Structural Attachment - #909	H-4
Threaded Structural Attachment - #910	H-4
Threaded Straight Fittings - #975	H-4
Pipe Clamp for Sway Bracing - #4A	H-4
Beam Clamp Retaining Straps - #69	H-4
Threaded Rod Company	
All Thread Rod	H-5
All Thread Stud	H-5
Elco Ind. - Hanger Mate	
Wood, Metal, and Concrete Screws	H-5
Drill Adapters, Masonry Bit, Drive Sockets	H-5
Sammy Super Screw	
Steel, Concrete, & Wood Screws	H-6
Nut Drivers	H-6
Sammy Screw Sidewinder	H-6
Sammy Screw X-Press	H-6
Swivel-Head Sammy Screw - Wood and Steel	H-6
Afcon	
Sway Brace Clamp Model E-001, Model 410, Model E-020	H-7
Threaded Attachment End - Model E-070	H-7
Locking Attachment - Model 077	H-7
U-Bolt With Nut - Model 240	H-7
Surge Restrainer	H-7
Afcon for CPVC	H-7

Visit www.tyco-fire.com/terms for terms and conditions of sale.

Section “J” Lubricants

LA-CO Industries	
Thread Sealant Paste	J-1
Gasket Lubricant	J-1
Tape	J-1
Pipe Markers (Valve Action)	J-1
Noble Company “Fire Fighter”	
Anti-Freeze - Glycol for Steel Pipe (pre-mix, concentrate, pure)	J-1
Gasket Lubricant	
Silicone Gasket Lubricant	J-1
FPPI Sealant	
FPPI Thread-Fit Cutting Oil	J-2
FPPI PipeFit Thread Sealant	J-2
Oatey Great White Thread Sealant	J-2
FPPI LubeFit Gasket Lubricant	J-2

Section “K” Misc.

MIFAB / PMR	
Access Doors	K-1
Acudor Products	
Access Door, Flush, Prime coated steel, UF5000	K-1

3/1/2013 – Price Book Addendums

<i>Description</i>	<i>Date</i>
GRINNELL Groove Fire Protection Products	5/13/2013
CPVC Pipe	5/20/2013
Vendor Price Increase	5/20/2013

Model TY-L, K=5.6, 1/2" NPT

100 Box Quantity (Upright 21.5 lbs/box (SIN TY3111), Pendent 19 lbs/box (SIN TY3211))

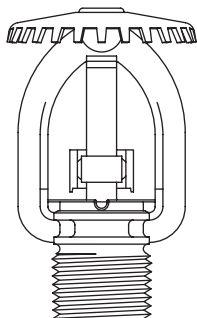
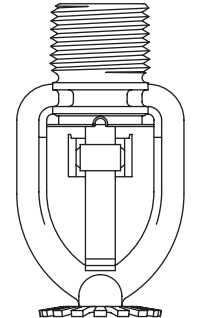
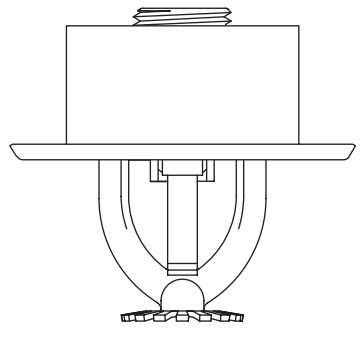
	C.O.	Upright	Pendent	Finish	Temperature	List Price
		53-111-1-165	53-112-1-165	Brass	165°F (74°C)	\$26.75
		53-111-1-212	53-112-1-212	Brass	212°F (100°C)	\$26.75
		53-111-1-280	53-112-1-280	Brass	280°F (138°C)	\$26.75
		53-111-9-165	53-112-9-165	Chrome	165°F (74°C)	\$32.75
	▶	53-111-9-212	53-112-9-212	Chrome	212°F (100°C)	\$32.75
	▶	53-111-9-280	53-112-9-280	Chrome	280°F (138°C)	\$32.75
	▶	53-111-7-165	53-112-7-165	Lead Coated	165°F (74°C)	\$69.50
	▶	53-111-7-212	53-112-7-212	Lead Coated	212°F (100°C)	\$69.50
	▶	53-111-7-280	53-112-7-280	Lead Coated	280°F (138°C)	\$69.50
	▶	53-111-6-165	53-112-6-165	Wax Coated	165°F (74°C)	\$66.25
	▶	53-111-6-212	53-112-6-212	Wax Coated	212°F (100°C)	\$66.25
	▶	53-111-8-165	53-112-8-165	Wax over Lead Coated	165°F (74°C)	\$92.50
▶	53-111-8-212	53-112-8-212	Wax over Lead Coated	212°F (100°C)	\$92.50	
	Recessed Escutcheons (Order Separately)					
		56-705-2-010	1/2" Brass Plated (Style 20)			\$9.50
		56-705-9-010	1/2" Chrome Plated (Style 20)			\$6.55
	56-705-4-010	1/2" Signal White (RAL 9003) (Style 20)			\$6.55	
	Sprinkler Wrench					
		56-000-1-849	W-Type 9 Wrench			\$45.75
	56-000-1-948	W-Type 10 Wrench (Recessed Only)			\$70.50	
Technical Data Sheet: TFP110						

Section 1
Standard Spray Sprinklers

Section 2
Extended Coverage Sprinklers

Section 3
Storage Sprinklers

Section 4
Residential Products

Section 5
Dry Sprinklers

Section 6
Special Sprinklers

Section 7
Nozzles and Sprinkler Accessories

See latest Technical Data Sheets for specific Approvals, Listings, Design Parameters & available finishes. Sprinkler heads & escutcheons are priced separately unless otherwise noted.

Items marked "C.O." are made to order and may require longer delivery times. Please contact customer service for availability.

Section 1
Standard Spray Sprinklers

Section 2
Extended Coverage Sprinklers



Section 3
Storage Sprinklers

Section 4
Residential Products

Section 5
Dry Sprinklers

Section 6
Special Sprinklers

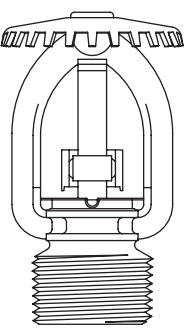
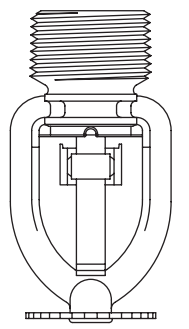
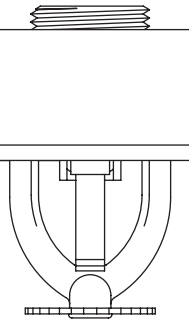
Section 7
Nozzles and Sprinkler Accessories

Model TY-L, K=8.0, 3/4" Male NPT						
100 Box Quantity (Upright 21.5 lbs/box (SIN TY4111), Pendent 21.5 lbs/box (SIN TY4211))						
	<i>C.O.</i>	<i>Upright</i>	<i>Pendent</i>	<i>Finish</i>	<i>Temperature</i>	<i>List Price</i>
		53-101-1-165	53-102-1-165	Brass	165°F (74°C)	\$45.75
	▶	53-101-1-212	53-102-1-212	Brass	212°F (100°C)	\$45.75
		53-101-1-280	53-102-1-280	Brass	280°F (138°C)	\$45.75
		53-101-9-165	53-102-9-165	Chrome	165°F (74°C)	\$52.00
	▶	53-101-9-212	53-102-9-212	Chrome	212°F (100°C)	\$52.00
	▶	53-101-7-165	53-102-7-165	Lead Coated	165°F (74°C)	\$113.00
	▶	53-101-7-212	53-102-7-212	Lead Coated	212°F (100°C)	\$113.00
	▶	53-101-7-280	53-102-7-280	Lead Coated	280°F (138°C)	\$113.00
	▶	53-101-6-165	53-102-6-165	Wax Coated	165°F (74°C)	\$106.50
	▶	53-101-6-212	53-102-6-212	Wax Coated	212°F (100°C)	\$106.50
	▶	53-101-8-165	53-102-8-165	Wax over Lead Coated	165°F (74°C)	\$145.00
	▶	53-101-8-212	53-102-8-212	Wax over Lead Coated	212°F (100°C)	\$145.00
	Recessed Escutcheons (Order Separately)					
		56-705-2-011	3/4" Brass Recessed (Style 30)			\$9.50
		56-705-9-011	3/4" Chrome Recessed (Style 30)			\$6.85
	56-705-4-011	3/4" Signal White (RAL 9003) Recessed (Style 30)			\$6.85	
	Sprinkler Wrench					
		56-000-1-849	W-Type 9 Wrench			\$45.75
	56-000-1-948	W-Type 10 Wrench (Recessed Only)			\$70.50	
	Technical Data Sheet: TFP110					

Items marked "C.O." are made to order and may require longer delivery times. Please contact customer service for availability.

See latest Technical Data Sheets for specific Approvals, Listings, Design Parameters & available finishes. Sprinkler heads & escutcheons are priced separately unless otherwise noted.

Model TY-L, K=8.0, 1/2" Male NPT, Pendent, Recessed Pendent and Upright Sprinklers

100 Box Quantity (Upright 21.5 lbs/box (SIN TY4811), Pendent 21.5 lbs/box (SIN TY4911))

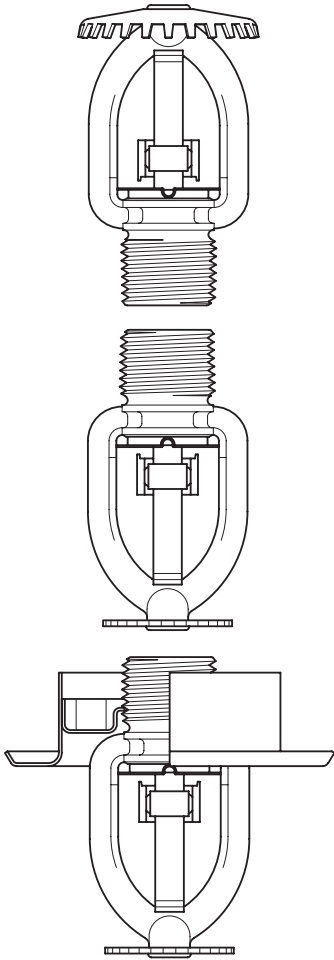
C.O.	Upright	Pendent	Finish	Temperature	List Price	
	53-106-1-165	53-107-1-165	Brass	165°F (74°C)	\$80.25	
	53-106-1-212	53-107-1-212	Brass	212°F (100°C)	\$80.25	
	53-106-1-280	53-107-1-280	Brass	280°F (138°C)	\$80.25	
	53-106-7-165	53-107-7-165	Lead Coated	165°F (74°C)	\$154.50	
	53-106-7-212	53-107-7-212	Lead Coated	212°F (100°C)	\$154.50	
	53-106-7-280	53-107-7-280	Lead Coated	280°F (138°C)	\$154.50	
	53-106-6-165	53-107-6-165	Wax Coated	165°F (74°C)	\$147.50	
	53-106-6-212	53-107-6-212	Wax Coated	212°F (100°C)	\$147.50	
	53-106-8-165	53-107-8-165	Wax over Lead	165°F (74°C)	\$181.00	
	53-106-8-212	53-107-8-212	Wax over Lead	212°F (100°C)	\$181.00	
	Recessed Escutcheons (Order Separately)					
	56-705-2-010	1/2" Brass Plated (Style 20)				\$9.50
56-705-9-010	1/2" Chrome Plated (Style 20)				\$6.55	
56-705-4-010	1/2" Signal White (RAL 9003) (Style 20)				\$6.55	
Sprinkler Wrench						
56-000-1-849	W-Type 9 Wrench				\$45.75	
56-000-1-948	W-Type 10 Wrench (Recessed Only)				\$70.50	
Technical Data Sheet: TFP110						

Section 1
Standard Spray Sprinklers

Section 2
Extended Coverage Sprinklers

Section 3
Storage Sprinklers

Section 4
Residential Products

Section 5
Dry Sprinklers

Model TY-L, K=5.6, 1/2" NPT, Horizontal Sidewall Sprinkler

100 Box Quantity (19 lbs/box) (SIN TY3311)

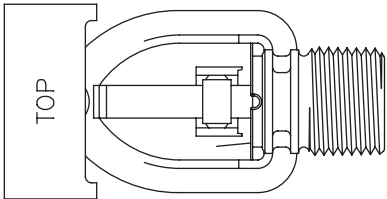
C.O.	Horiz. Sidewall	Finish	Temperature	List Price	
	53-113-1-165	Brass	165°F (74°C)	\$47.25	
	53-113-1-212	Brass	212°F (100°C)	\$47.25	
	53-113-1-280	Brass	280°F (138°C)	\$47.25	
	53-113-9-165	Chrome	165°F (74°C)	\$52.50	
	53-113-9-212	Chrome	212°F (100°C)	\$52.50	
	53-113-9-280	Chrome	280°F (138°C)	\$52.50	
	Sprinkler Wrench				
	56-000-1-849	W-Type 9 Wrench			\$45.75
	Technical Data Sheet: TFP120				

Section 6
Special Sprinklers

Section 7
Nozzles and Sprinkler Accessories

See latest Technical Data Sheets for specific Approvals, Listings, Design Parameters & available finishes. Sprinkler heads & escutcheons are priced separately unless otherwise noted.

Items marked "C.O." are made to order and may require longer delivery times. Please contact customer service for availability.

Model TY-FRL , K=2.8, 1/2" NPT, Quick Response Sprinkler

100 Box Quantity (Upright 20 lbs/box (SIN TY1121), Pendent 18.5 lbs/box (SIN TY1221))

C.O.	Upright	Pendent	Finish	Temperature	List Price
	58-973-1-165	58-981-1-165	Brass	165°F (74°C)	\$93.25
	58-973-1-212	58-981-1-212	Brass	212°F (100°C)	\$93.25
	58-973-9-165	58-981-9-165	Chrome	165°F (74°C)	\$100.50
	58-973-9-212	58-981-9-212	Chrome	212°F (100°C)	\$100.50
Recessed Escutcheons (Order Separately)					
	56-705-2-010	1/2" Brass (Style 20)			\$9.50
	56-705-9-010	1/2" Chrome (Style 20)			\$6.55
	56-705-4-010	1/2" Signal White (RAL 9003) (Style 20)			\$6.55
Sprinkler Wrench					
	56-000-1-849	W-Type 9 Wrench			\$45.75
	56-798-1-001	W-Type 12 (Recessed Only)			\$64.75

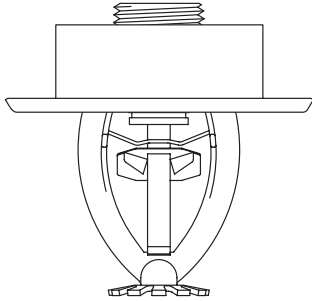
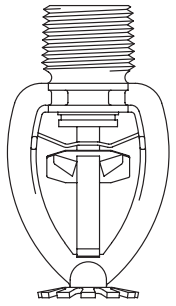
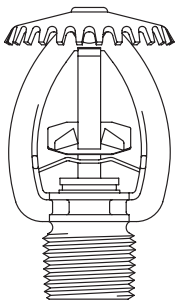

Technical Data Sheet: TFP130

Section 1
Standard Spray Sprinklers

Section 2
Extended Coverage Sprinklers

Section 3
Storage Sprinklers

Section 4
Residential Products

Section 5
Dry Sprinklers

Section 6
Special Sprinklers

Section 7
Nozzles and Sprinkler Accessories

Items marked "C.O." are made to order and may require longer delivery times. Please contact customer service for availability.

See latest Technical Data Sheets for specific Approvals, Listings, Design Parameters & available finishes. Sprinkler heads & escutcheons are priced separately unless otherwise noted.

Model TY-FRL, K=5.6, 1/2" NPT, Quick Response Sprinkler

100 Box Quantity (Upright 20 lbs/box (SIN TY3121), Pendent 18.5 lbs/box (SIN TY3221))

C.O.	Upright pp	Pendent	Description	Temperature	List Price
	58-974-1-165	58-982-1-165	Brass	165°F (74°C)	\$83.00
	58-974-1-212	58-982-1-212	Brass	212°F (100°C)	\$83.00
	58-974-9-165	58-982-9-165	Chrome	165°F (74°C)	\$90.50
	58-974-9-212	58-982-9-212	Chrome	212°F (100°C)	\$90.50
Recessed Escutcheons (Order Separately)					
	56-705-2-010	1/2" Brass (Style 20)			\$9.50
	56-705-9-010	1/2" Chrome (Style 20)			\$6.55
	56-705-4-010	1/2" Signal White (RAL 9003) (Style 20)			\$6.55
Sprinkler Wrench					
	56-000-1-849	W-Type 9 Wrench			\$45.75
	56-798-1-001	W-Type 12 (Recessed Only)			\$64.75

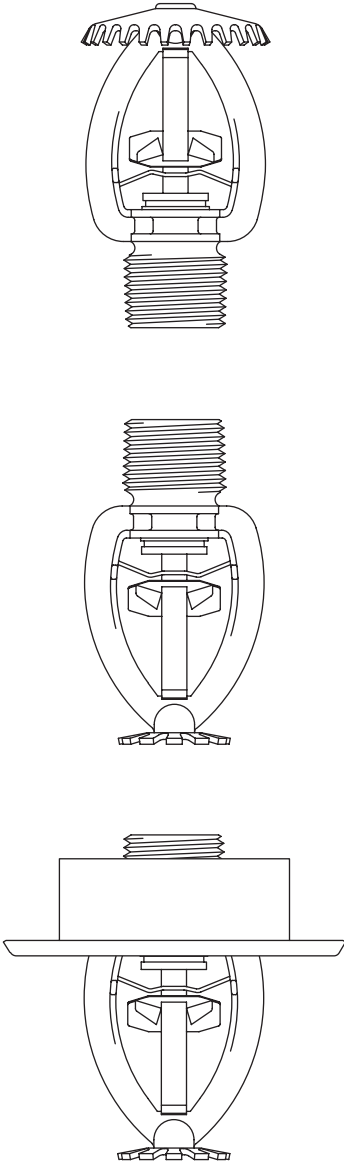

Technical Data Sheet: TFP130

Section 1
Standard Spray Sprinklers

Section 2
Extended Coverage Sprinklers

Section 3
Storage Sprinklers

Section 4
Residential Products

Section 5
Dry Sprinklers

Section 6
Special Sprinklers

Section 7
Nozzles and Sprinkler Accessories

See latest Technical Data Sheets for specific Approvals, Listings, Design Parameters & available finishes. Sprinkler heads & escutcheons are priced separately unless otherwise noted.

Items marked "C.O." are made to order and may require longer delivery times. Please contact customer service for availability.

Model TY-FRL, K=8.0, 3/4" NPT, Quick Response Sprinkler

100 Box Quantity (Upright 25 lbs/box (SIN TY4121), Pendent 25 lbs/box (SIN TY4221))

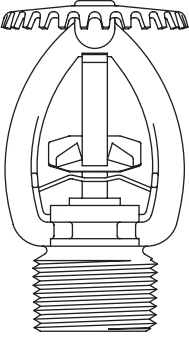
	C.O.	Upright	Pendent	Description	Temperature	List Price
		58-174-1-165	58-172-1-165	Brass	165°F (74°C)	\$96.75
		58-174-1-212	58-172-1-212	Brass	212°F (100°C)	\$96.75
		58-174-9-165	58-172-9-165	Chrome	165°F (74°C)	\$117.50
		58-174-9-212	58-172-9-212	Chrome	212°F (100°C)	\$117.50
Sprinkler Wrench						
	56-000-1-849	W-Type 9 Wrench				\$45.75
Technical Data Sheet: TFP130						

Model TY-FRL, K=5.6, 1/2" NPT, Horizontal Sidewall Quick Response Sprinkler

100 Box Quantity (20 lbs/box) (SIN TY3321)

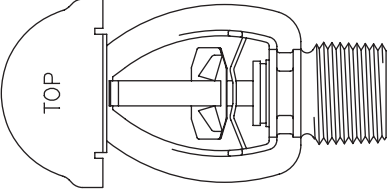
	C.O.	Horiz. Sidewall	Finish	Temperature	List Price
		58-946-1-165	Brass	165°F (74°C)	\$106.00
	▶	58-946-1-212	Brass	212°F (100°C)	\$106.00
		58-946-9-165	Chrome	165°F (74°C)	\$117.00
	▶	58-946-9-212	Chrome	212°F (100°C)	\$117.00
Sprinkler Wrench					
	56-000-1-849	W-Type 9 Wrench			\$45.75
Technical Data Sheet: TFP140					

Items marked "C.O." are made to order and may require longer delivery times. Please contact customer service for availability.

See latest Technical Data Sheets for specific Approvals, Listings, Design Parameters & available finishes. Sprinkler heads & escutcheons are priced separately unless otherwise noted.

TY-B, 5mm Bulb, K=5.6, 1/2" NPT Pendent, Recessed Pendent and Upright *

100 Box Quantity (Upright 18 lbs/box (SIN TY3151), Pendent 17 lbs/box (SIN TY3251))

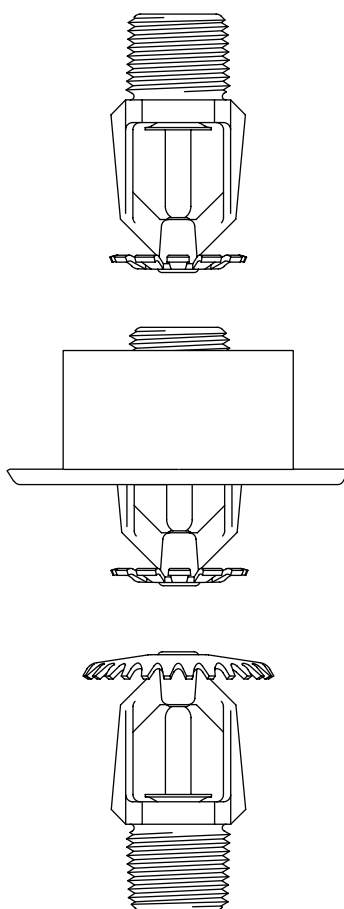
	C.O.	Upright	Pendent	Finish	Temperature	List Price
	▶	57-570-1-135	57-571-1-135	Brass	135°F (57°C)	\$19.25
		57-570-1-155	57-571-1-155	Brass	155°F (68°C)	\$18.00
	▶	57-570-1-175	57-571-1-175	Brass	175°F (79°C)	\$19.25
		57-570-1-200	57-571-1-200	Brass	200°F (93°C)	\$18.00
		57-570-1-286	57-571-1-286	Brass	286°F (141°C)	\$18.00
	▶	57-570-1-360	57-571-1-360	Brass	360°F (182°C)	\$22.25
	▶	57-570-9-135	57-571-9-135	Chrome	135°F (57°C)	\$22.25
		57-570-9-155	57-571-9-155	Chrome	155°F (68°C)	\$21.25
	▶	57-570-9-175	57-571-9-175	Chrome	175°F (79°C)	\$22.25
	▶	57-570-9-200	57-571-9-200	Chrome	200°F (93°C)	\$22.25
	▶	57-570-9-286	57-571-9-286	Chrome	286°F (141°C)	\$22.25
	▶	57-570-9-360	57-571-9-360	Chrome	360°F (182°C)	\$26.75
	▶	57-570-4-135	57-571-4-135	Signal White (RAL 9003)	135°F (57°C)	\$22.25
		57-570-4-155	57-571-4-155	Signal White (RAL 9003)	155°F (68°C)	\$21.25
	▶	57-570-4-175	57-571-4-175	Signal White (RAL 9003)	175°F (79°C)	\$22.25
		57-570-4-200	57-571-4-200	Signal White (RAL 9003)	200°F (93°C)	\$22.25
	▶	57-570-4-286	57-571-4-286	Signal White (RAL 9003)	286°F (141°C)	\$22.25
	▶	57-570-4-360	57-571-4-360	Signal White (RAL 9003)	360°F (182°C)	\$26.75
		57-570-X-155	57-571-X-155	Jet Black (RAL 9005)	155°F (68°C)	\$53.75
		57-570-X-200	57-571-X-200	Jet Black (RAL 9005)	200°F (93°C)	\$53.75
	▶	57-570-7-135	57-571-7-135	Lead Coated	135°F (57°C)	\$62.00
	▶	57-570-7-155	57-571-7-155	Lead Coated	155°F (68°C)	\$62.00
	▶	57-570-7-175	57-571-7-175	Lead Coated	175°F (79°C)	\$62.00
	▶	57-570-7-200	57-571-7-200	Lead Coated	200°F (93°C)	\$62.00
	▶	57-570-7-286	57-571-7-286	Lead Coated	286°F (141°C)	\$62.00
	▶	57-570-7-360	57-571-7-360	Lead Coated	360°F (182°C)	\$62.00
	▶	57-570-6-135	57-571-6-135	Wax Coated	135°F (57°C)	\$57.25
	▶	57-570-6-155	57-571-6-155	Wax Coated	155°F (68°C)	\$57.25
	▶	57-570-6-175	57-571-6-175	Wax Coated	175°F (79°C)	\$57.25
	▶	57-570-6-200	57-571-6-200	Wax Coated	200°F (93°C)	\$57.25
▶	57-570-6-286	57-571-6-286	Wax Coated	286°F (141°C)	\$57.25	
▶	57-570-8-135	57-571-8-135	Wax over Lead Coated	135°F (57°C)	\$82.25	
▶	57-570-8-155	57-571-8-155	Wax over Lead Coated	155°F (68°C)	\$82.25	
▶	57-570-8-175	57-571-8-175	Wax over Lead Coated	175°F (79°C)	\$82.25	
▶	57-570-8-200	57-571-8-200	Wax over Lead Coated	200°F (93°C)	\$82.25	
▶	57-570-8-286	57-571-8-286	Wax over Lead Coated	286°F (141°C)	\$82.25	
Recessed Escutcheons (Order Separately)						
	56-701-2-010	1/2" Brass Plated (Style 10)				\$9.50
	56-701-9-010	1/2" Chrome Plated (Style 10)				\$6.55
	56-701-4-010	1/2" Signal White (RAL 9003) (Style 10)				\$6.55
	56-701-6-010	1/2" Jet Black (RAL 9005) (Style 10)				\$8.55
Sprinkler Wrench						
	56-000-6-387	W-Type 6 Wrench				\$51.25
	56-850-4-001	W-Type 7 Wrench (Recessed Only)				\$85.00
Technical Data Sheet: TFP151						

Section 1
Standard Spray Sprinklers

Section 2
Extended Coverage Sprinklers

Section 3
Storage Sprinklers

Section 4
Residential Products

Section 5
Dry Sprinklers

Section 6
Special Sprinklers

Section 7
Nozzles and Sprinkler Accessories

*** Note:**
Updated design will replace existing sprinkler model beginning in March 2013. This transition will occur on a part-by-part basis. Specific temperatures and finishes will transition to the updated design once current inventory is depleted for the current sprinkler.

TY-B, 5mm Bulb, K=8.0, 1/2" NPT, Pendent and Upright Sprinklers,

100 Box Quantity (Upright 21 lbs/box (SIN TY4851), Pendent 21 lbs/box (SIN TY4951))

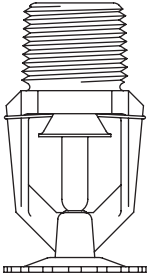
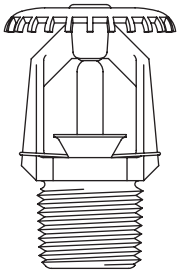
	<i>C.O.</i>	<i>Upright</i>	<i>Pendent</i>	<i>Finish</i>	<i>Temperature</i>	<i>List Price</i>
	▶	57-560-1-135	57-561-1-135	Brass	135°F (57°C)	\$26.25
		57-560-1-155	57-561-1-155	Brass	155°F (68°C)	\$26.25
	▶	57-560-1-175	57-561-1-175	Brass	175°F (79°C)	\$26.25
		57-560-1-200	57-561-1-200	Brass	200°F (93°C)	\$26.25
		57-560-1-286	57-561-1-286	Brass	286°F (141°C)	\$26.25
	▶	57-560-1-360	57-561-1-360	Brass	360°F (182°C)	\$29.00
	▶	57-560-9-135	57-561-9-135	Chrome	135°F (57°C)	\$29.00
		57-560-9-155	57-561-9-155	Chrome	155°F (68°C)	\$29.00
	▶	57-560-9-175	57-561-9-175	Chrome	175°F (79°C)	\$29.00
	▶	57-560-9-200	57-561-9-200	Chrome	200°F (93°C)	\$29.00
	▶	57-560-9-286	57-561-9-286	Chrome	286°F (141°C)	\$29.00
	▶	57-560-9-360	57-561-9-360	Chrome	360°F (182°C)	\$32.25
	▶	57-560-4-135	57-561-4-135	Signal White (RAL 9003)	135°F (57°C)	\$29.00
		57-560-4-155	57-561-4-155	Signal White (RAL 9003)	155°F (68°C)	\$29.00
	▶	57-560-4-175	57-561-4-175	Signal White (RAL 9003)	175°F (79°C)	\$29.00
	▶	57-560-4-200	57-561-4-200	Signal White (RAL 9003)	200°F (93°C)	\$29.00
	▶	57-560-4-286	57-561-4-286	Signal White (RAL 9003)	286°F (141°C)	\$29.00
	▶	57-560-4-360	57-561-4-360	Signal White (RAL 9003)	360°F (182°C)	\$32.25
	▶	57-560-X-155	57-561-X-155	Jet Black (RAL 9005)	155°F (68°C)	\$78.50
	▶	57-560-X-200	57-561-X-200	Jet Black (RAL 9005)	200°F (93°C)	\$78.50
Sprinkler Wrench						
		56-000-6-387	W-Type 6 Wrench			\$51.25
Technical Data Sheet: TFP151						

Items marked "C.O." are made to order and may require longer delivery times. Please contact customer service for availability.

See latest Technical Data Sheets for specific Approvals, Listings, Design Parameters & available finishes. Sprinkler heads & escutcheons are priced separately unless otherwise noted.

Section 1 Standard Spray Sprinklers
 Section 2 Extended Coverage Sprinklers
 Section 3 Storage Sprinklers
 Section 4 Residential Products
 Section 5 Dry Sprinklers
 Section 6 Special Sprinklers
 Section 7 Nozzles and Sprinkler Accessories

TY-B, 5mm Bulb, K=8.0, 3/4" NPT, Pendent, Recessed Pendent and Upright Sprinklers

100 Box Quantity (Upright 21 lbs/box (SIN TY4151), Pendent 21 lbs/box (SIN TY4251))

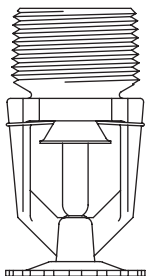
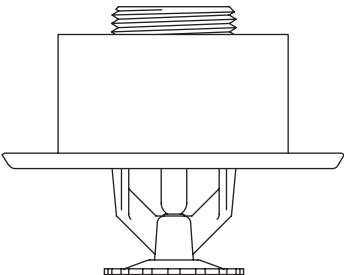
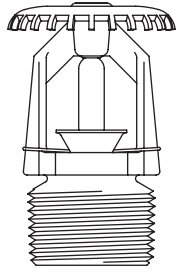
	C.O.	Upright	Pendent	Finish	Temperature	List Price
	▶	57-590-1-135	57-591-1-135	Brass	135°F (57°C)	\$22.00
		57-590-1-155	57-591-1-155	Brass	155°F (68°C)	\$21.00
	▶	57-590-1-175	57-591-1-175	Brass	175°F (79°C)	\$22.00
		57-590-1-200	57-591-1-200	Brass	200°F (93°C)	\$21.00
		57-590-1-286	57-591-1-286	Brass	286°F (141°C)	\$21.00
	▶	57-590-1-360	57-591-1-360	Brass	360°F (182°C)	\$25.50
	▶	57-590-9-135	57-591-9-135	Chrome	135°F (57°C)	\$25.50
		57-590-9-155	57-591-9-155	Chrome	155°F (68°C)	\$25.50
	▶	57-590-9-175	57-591-9-175	Chrome	175°F (79°C)	\$25.50
	▶	57-590-9-200	57-591-9-200	Chrome	200°F (93°C)	\$25.50
▶	57-590-9-286	57-591-9-286	Chrome	286°F (141°C)	\$25.50	
▶	57-590-9-360	57-591-9-360	Chrome	360°F (182°C)	\$28.50	
	▶	57-590-4-135	57-591-4-135	Signal White (RAL 9003)	135°F (57°C)	\$25.50
		57-590-4-155	57-591-4-155	Signal White (RAL 9003)	155°F (68°C)	\$25.50
	▶	57-590-4-175	57-591-4-175	Signal White (RAL 9003)	175°F (79°C)	\$25.50
	▶	57-590-4-200	57-591-4-200	Signal White (RAL 9003)	200°F (93°C)	\$25.50
	▶	57-590-4-286	57-591-4-286	Signal White (RAL 9003)	286°F (141°C)	\$25.50
	▶	57-590-4-360	57-591-4-360	Signal White (RAL 9003)	360°F (182°C)	\$28.50
	▶	57-590-5-155	57-591-X-155	Jet Black (RAL 9005)	155°F (68°C)	\$62.75
	▶	57-590-X-200	57-591-X-200	Jet Black (RAL 9005)	200°F (93°C)	\$62.75
	▶	57-590-7-135	57-591-7-135	Lead Coated	135°F (57°C)	\$67.00
	▶	57-590-7-155	57-591-7-155	Lead Coated	155°F (68°C)	\$67.00
▶	57-590-7-175	57-591-7-175	Lead Coated	175°F (79°C)	\$67.00	
▶	57-590-7-200	57-591-7-200	Lead Coated	200°F (93°C)	\$67.00	
▶	57-590-7-286	57-591-7-286	Lead Coated	286°F (141°C)	\$67.00	
▶	57-590-7-360	57-591-7-360	Lead Coated	360°F (182°C)	\$67.00	
	▶	57-590-6-135	57-591-6-135	Wax Coated	135°F (57°C)	\$62.50
	▶	57-590-6-155	57-591-6-155	Wax Coated	155°F (68°C)	\$62.50
	▶	57-590-6-175	57-591-6-175	Wax Coated	175°F (79°C)	\$62.50
	▶	57-590-6-200	57-591-6-200	Wax Coated	200°F (93°C)	\$62.50
	▶	57-590-6-286	57-591-6-286	Wax Coated	286°F (141°C)	\$62.50
	▶	57-590-8-135	57-591-8-135	Wax over Lead Coated	135°F (57°C)	\$87.25
▶	57-590-8-155	57-591-8-155	Wax over Lead Coated	155°F (68°C)	\$87.25	
▶	57-590-8-175	57-591-8-175	Wax over Lead Coated	175°F (79°C)	\$87.25	
▶	57-590-8-200	57-591-8-200	Wax over Lead Coated	200°F (93°C)	\$87.25	
▶	57-590-8-286	57-591-8-286	Wax over Lead Coated	286°F (141°C)	\$87.25	
Recessed Escutcheons (Order Separately)						
		56-700-2-010	3/4" Brass Recessed (Style 40)			\$9.50
		56-700-9-010	3/4" Chrome Recessed (Style 40)			\$6.85
		56-700-4-010	3/4" Signal White (RAL 9003) Recessed (Style 40)			\$6.85
		56-700-6-010	3/4" Jet Black (RAL 9005) Recessed (Style 40)			\$8.70
Sprinkler Wrench						
		56-000-6-387	W-Type 6 Wrench			\$51.25
		56-850-4-001	W-Type 7 Wrench (Recessed Only)			\$85.00
Technical Data Sheet: TFP151						

Section 1
Standard Spray Sprinklers

 Section 2
Extended Coverage Sprinklers

 Section 3
Storage Sprinklers

 Section 4
Residential Products

 Section 5
Dry Sprinklers

 Section 6
Special Sprinklers

 Section 7
Nozzles and Sprinkler Accessories

See latest Technical Data Sheets for specific Approvals, Listings, Design Parameters & available finishes. Sprinkler heads & escutcheons are priced separately unless otherwise noted.

Items marked "C.O." are made to order and may require longer delivery times. Please contact customer service for availability.

**TY-B, 5mm Bulb, K=5.6, 1/2" NPT, Horizontal,
Recessed Horizontal, and Vertical Sidewall Sprinklers**

100 Box Quantity (HSW 18 lbs/box (SIN TY3351), VSW 18 lbs/box (SIN TY3451))

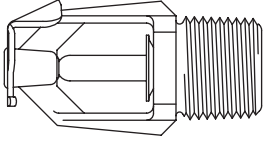
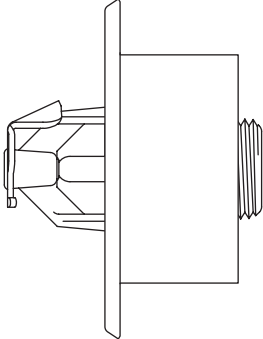
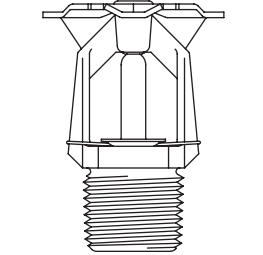
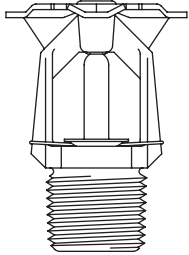
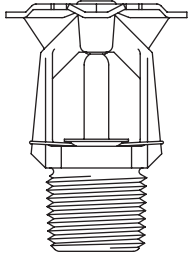
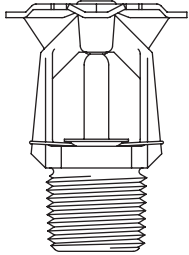
	C.O.	Horiz. Sidewall	Vertical	Finish	Temperature	List Price
	▶	57-578-1-135	57-575-1-135	Brass	135°F (57°C)	\$35.00
		57-578-1-155	57-575-1-155	Brass	155°F (68°C)	\$35.00
	▶	57-578-1-175	57-575-1-175	Brass	175°F (79°C)	\$35.00
		57-578-1-200	57-575-1-200	Brass	200°F (93°C)	\$35.00
		57-578-1-286	57-575-1-286	Brass	286°F (141°C)	\$35.00
	▶	57-578-1-360	57-575-1-360	Brass	360°F (182°C)	\$40.00
	▶	57-578-9-135	57-575-9-135	Chrome	135°F (57°C)	\$37.25
		57-578-9-155	57-575-9-155	Chrome	155°F (68°C)	\$37.25
	▶	57-578-9-175	57-575-9-175	Chrome	175°F (79°C)	\$37.25
		57-578-9-200	57-575-9-200	Chrome	200°F (93°C)	\$37.25
	▶	57-578-9-286	57-575-9-286	Chrome	286°F (141°C)	\$37.25
	▶	57-578-9-360	57-575-9-360	Chrome	360°F (182°C)	\$45.00
	▶	57-578-4-135	57-575-4-135	Signal White (RAL 9003)	135°F (57°C)	\$37.25
		57-578-4-155	57-575-4-155	Signal White (RAL 9003)	155°F (68°C)	\$37.25
	▶	57-578-4-175	57-575-4-175	Signal White (RAL 9003)	175°F (79°C)	\$37.25
	▶	57-578-4-200	57-575-4-200	Signal White (RAL 9003)	200°F (93°C)	\$37.25
	▶	57-578-4-286	57-575-4-286	Signal White (RAL 9003)	286°F (141°C)	\$37.25
	▶	57-578-4-360	57-575-4-360	Signal White (RAL 9003)	360°F (182°C)	\$45.00
	▶	57-578-5-155	57-575-X-155	Jet Black (RAL 9005)	155°F (68°C)	\$104.50
	▶	57-578-5-200	57-575-X-200	Jet Black (RAL 9005)	200°F (93°C)	\$104.50
	▶	57-578-7-135	57-575-7-135	Lead Coated	135°F (57°C)	\$75.00
	▶	57-578-7-155	57-575-7-155	Lead Coated	155°F (68°C)	\$75.00
	▶	57-578-7-175	57-575-7-175	Lead Coated	175°F (79°C)	\$75.00
	▶	57-578-7-200	57-575-7-200	Lead Coated	200°F (93°C)	\$75.00
	▶	57-578-7-286	57-575-7-286	Lead Coated	286°F (141°C)	\$75.00
	▶	57-578-7-360	57-575-7-360	Lead Coated	360°F (182°C)	\$75.00
	▶	57-578-6-135	57-575-6-135	Wax Coated	135°F (57°C)	\$71.50
	▶	57-578-6-155	57-575-6-155	Wax Coated	155°F (68°C)	\$71.50
	▶	57-578-6-175	57-575-6-175	Wax Coated	175°F (79°C)	\$71.50
	▶	57-578-6-200	57-575-6-200	Wax Coated	200°F (93°C)	\$71.50
	▶	57-578-6-286	57-575-6-286	Wax Coated	286°F (141°C)	\$71.50
	▶	57-578-8-135	57-575-8-135	Wax over Lead Coated	135°F (57°C)	\$95.75
	▶	57-578-8-155	57-575-8-155	Wax over Lead Coated	155°F (68°C)	\$95.75
	▶	57-578-8-175	57-575-8-175	Wax over Lead Coated	175°F (79°C)	\$95.75
	▶	57-578-8-200	57-575-8-200	Wax over Lead Coated	200°F (93°C)	\$95.75
	▶	57-578-8-286	57-575-8-286	Wax over Lead Coated	286°F (141°C)	\$95.75
Recessed Escutcheons (Order Separately)						
	▶	56-701-2-010	1/2" Brass Plated (Style 10)			\$9.50
	▶	56-701-9-010	1/2" Chrome Plated (Style 10)			\$6.55
	▶	56-701-4-010	1/2" Signal White (RAL 9003) (Style 10)			\$6.55
	▶	56-701-6-010	1/2" Jet Black (RAL 9005) (Style 10)			\$8.55
Sprinkler Wrench						
	▶	56-000-6-387	W-Type 6 Wrench			\$51.25
	▶	56-850-4-001	W-Type 7 Wrench (Recessed Only)			\$85.00
Technical Data Sheet: TFP161						

Items marked "C.O." are made to order and may require longer delivery times. Please contact customer service for availability.

See latest Technical Data Sheets for specific Approvals, Listings, Design Parameters & available finishes. Sprinkler heads & escutcheons are priced separately unless otherwise noted.

**TY-FRB, 3mm Bulb, Quick Response, K=2.8,
1/2" NPT, Pendent, Recessed Pendent and Upright Sprinklers**

100 Box Quantity (Upright 18 lbs/box (SIN TY1131), Pendent 17 lbs/box (SIN TY1231))

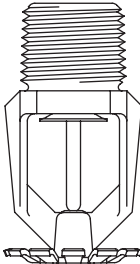
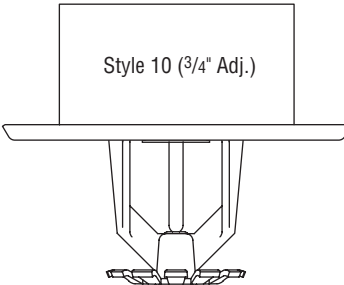
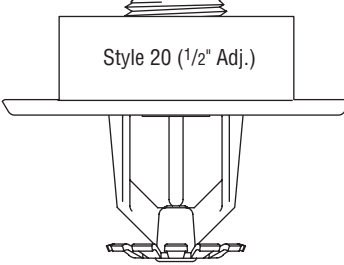
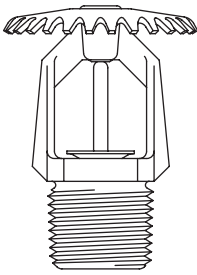
	C.O.	Upright	Pendent	Finish	Temperature	List Price	
	▶	57-330-1-135	57-331-1-135	Brass	135°F (57°C)	\$38.75	
		57-330-1-155	57-331-1-155	Brass	155°F (68°C)	\$38.75	
	▶	57-330-1-175	57-331-1-175	Brass	175°F (79°C)	\$38.75	
		57-330-1-200	57-331-1-200	Brass	200°F (93°C)	\$38.75	
	▶	57-330-1-286	57-331-1-286	Brass	286°F (141°C)	\$38.75	
	▶	57-330-9-135	57-331-9-135	Chrome	135°F (57°C)	\$42.25	
		57-330-9-155	57-331-9-155	Chrome	155°F (68°C)	\$42.25	
	▶	57-330-9-175	57-331-9-175	Chrome	175°F (79°C)	\$42.25	
	▶	57-330-9-200	57-331-9-200	Chrome	200°F (93°C)	\$42.25	
	▶	57-330-9-286	57-331-9-286	Chrome	286°F (141°C)	\$42.25	
	▶	57-330-4-135	57-331-4-135	Signal White (RAL 9003)	135°F (57°C)	\$42.25	
		57-330-4-155	57-331-4-155	Signal White (RAL 9003)	155°F (68°C)	\$42.25	
	▶	57-330-4-175	57-331-4-175	Signal White (RAL 9003)	175°F (79°C)	\$42.25	
	▶	57-330-4-200	57-331-4-200	Signal White (RAL 9003)	200°F (93°C)	\$42.25	
	▶	57-330-4-286	57-331-4-286	Signal White (RAL 9003)	286°F (141°C)	\$42.25	
	▶	57-330-X-155	57-331-5-155	Jet Black (RAL 9005)	155°F (68°C)	\$115.75	
	57-330-X-200	57-331-5-200	Jet Black (RAL 9005)	200°F (93°C)	\$115.75		
Recessed Escutcheons (Order Separately)							
	56-701-2-010	1/2" Brass Plated (Style 10)				\$9.50	
	56-701-9-010	1/2" Chrome Plated (Style 10)				\$6.55	
	56-701-4-010	1/2" Signal White (RAL 9003) (Style 10)				\$6.55	
	56-701-6-010	1/2" Jet Black (RAL 9005) (Style 10)				\$8.55	
		56-705-2-010	1/2" Brass Plated (Style 20)				\$9.50
		56-705-9-010	1/2" Chrome Plated (Style 20)				\$6.55
		56-705-4-010	1/2" Signal White (RAL 9003) (Style 20)				\$6.55
		56-705-6-010	1/2" Jet Black (RAL 9005) (Style 20)				\$8.55
Sprinkler Wrench							
	56-000-6-387	W-Type 6 Wrench				\$51.25	
	56-850-4-001	W-Type 7 Wrench (Recessed Only)				\$85.00	
	Technical Data Sheet: TFP 171						

Section 1
Standard Spray Sprinklers

Section 2
Extended Coverage Sprinklers

Section 3
Storage Sprinklers

Section 4
Residential Products

Section 5
Dry Sprinklers

Section 6
Special Sprinklers

Section 7
Nozzles and Sprinkler Accessories

See latest Technical Data Sheets for specific Approvals, Listings, Design Parameters & available finishes. Sprinkler heads & escutcheons are priced separately unless otherwise noted.

Items marked "C.O." are made to order and may require longer delivery times. Please contact customer service for availability.

**TY-FRB, 3mm Bulb, Quick Response, K=4.2,
1/2" NPT, Pendent, Recessed Pendent and Upright Sprinklers**

100 Box Quantity (Upright 18 lbs/box (SIN TY2131), Pendent 17 lbs/box (SIN TY2231))

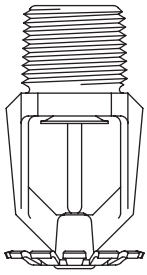
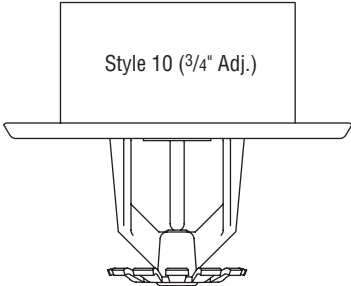
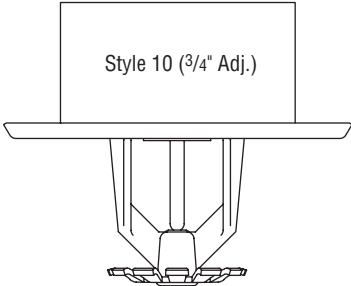
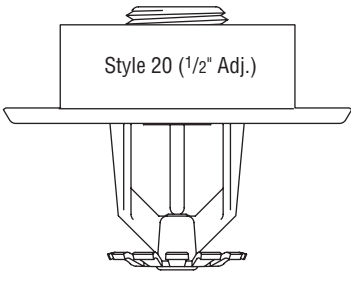
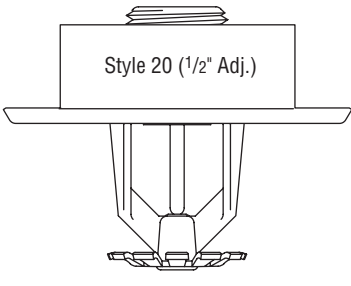
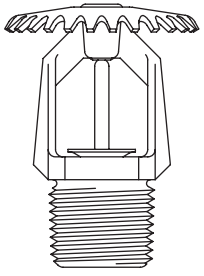
	<i>C.O.</i>	<i>Upright</i>	<i>Pendent</i>	<i>Finish</i>	<i>Temperature</i>	<i>List Price</i>
	▶	57-340-1-135	57-341-1-135	Brass	135°F (57°C)	\$38.75
		57-340-1-155	57-341-1-155	Brass	155°F (68°C)	\$38.75
	▶	57-340-1-175	57-341-1-175	Brass	175°F (79°C)	\$38.75
		57-340-1-200	57-341-1-200	Brass	200°F (93°C)	\$38.75
	▶	57-340-1-286	57-341-1-286	Brass	286°F (141°C)	\$38.75
	▶	57-340-9-135	57-341-9-135	Chrome	135°F (57°C)	\$42.25
		57-340-9-155	57-341-9-155	Chrome	155°F (68°C)	\$42.25
	▶	57-340-9-175	57-341-9-175	Chrome	175°F (79°C)	\$42.25
	▶	57-340-9-200	57-341-9-200	Chrome	200°F (93°C)	\$42.25
	▶	57-340-9-286	57-341-9-286	Chrome	286°F (141°C)	\$42.25
 Style 10 (3/4" Adj.)	▶	57-340-4-135	57-341-4-135	Signal White (RAL 9003)	135°F (57°C)	\$42.25
		57-340-4-155	57-341-4-155	Signal White (RAL 9003)	155°F (68°C)	\$42.25
	▶	57-340-4-175	57-341-4-175	Signal White (RAL 9003)	175°F (79°C)	\$42.25
	▶	57-340-4-200	57-341-4-200	Signal White (RAL 9003)	200°F (93°C)	\$42.25
	▶	57-340-4-286	57-341-4-286	Signal White (RAL 9003)	286°F (141°C)	\$42.25
 Style 10 (3/4" Adj.)	▶	57-340-X-155	57-341-X-155	Jet Black (RAL 9005)	155°F (68°C)	\$115.75
	▶	57-340-X-200	57-341-X-200	Jet Black (RAL 9005)	200°F (93°C)	\$115.75
Recessed Escutcheons (Order Separately)						
 Style 20 (1/2" Adj.)		56-701-2-010	1/2" Brass Plated (Style 10)			\$9.50
		56-701-9-010	1/2" Chrome Plated (Style 10)			\$6.55
		56-701-4-010	1/2" Signal White (RAL 9003) (Style 10)			\$6.55
		56-701-6-010	1/2" Jet Black (RAL 9005) (Style 10)			\$8.55
 Style 20 (1/2" Adj.)		56-705-2-010	1/2" Brass Plated (Style 20)			\$9.50
		56-705-9-010	1/2" Chrome Plated (Style 20)			\$6.55
		56-705-4-010	1/2" Signal White (RAL 9003) (Style 20)			\$6.55
		56-705-6-010	1/2" Jet Black (RAL 9005) (Style 20)			\$8.55
Sprinkler Wrench						
		56-000-6-387	W-Type 6 Wrench			\$51.25
		56-850-4-001	W-Type 7 Wrench (Recessed Only)			\$85.00
Technical Data Sheet: TFP171						

Items marked "C.O." are made to order and may require longer delivery times. Please contact customer service for availability.

See latest Technical Data Sheets for specific Approvals, Listings, Design Parameters & available finishes. Sprinkler heads & escutcheons are priced separately unless otherwise noted.

TY-FRB, 3mm Bulb, Quick Response, K=5.6, 1/2" NPT, Pendent, Recessed Pendent and Upright Sprinkler *

100 Box Quantity (Upright 18 lbs/box (SIN TY3131), Pendent 17 lbs/box (SIN TY3231))

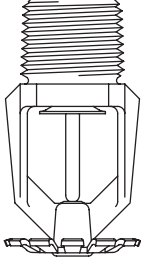
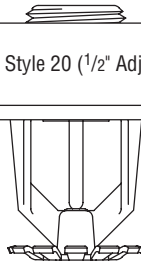
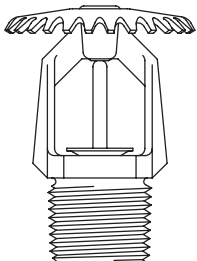
	C.O.	Upright	Pendent	Finish	Temperature	List Price	
	▶	57-370-1-135	57-371-1-135	Brass	135°F (57°C)	\$32.25	
		57-370-1-155	57-371-1-155	Brass	155°F (68°C)	\$30.25	
	▶	57-370-1-175	57-371-1-175	Brass	175°F (79°C)	\$32.25	
		57-370-1-200	57-371-1-200	Brass	200°F (93°C)	\$30.25	
		57-370-1-286	57-371-1-286	Brass	286°F (141°C)	\$30.25	
	▶	57-370-9-135	57-371-9-135	Chrome	135°F (57°C)	\$35.25	
		57-370-9-155	57-371-9-155	Chrome	155°F (68°C)	\$32.75	
	▶	57-370-9-175	57-371-9-175	Chrome	175°F (79°C)	\$35.25	
	▶	57-370-9-200	57-371-9-200	Chrome	200°F (93°C)	\$35.25	
	▶	57-370-9-286	57-371-9-286	Chrome	286°F (141°C)	\$35.25	
		▶	57-370-4-135	57-371-4-135	Signal White (RAL 9003)	135°F (57°C)	\$32.75
			57-370-4-155	57-371-4-155	Signal White (RAL 9003)	155°F (68°C)	\$32.75
		▶	57-370-4-175	57-371-4-175	Signal White (RAL 9003)	175°F (79°C)	\$32.75
		▶	57-370-4-200	57-371-4-200	Signal White (RAL 9003)	200°F (93°C)	\$32.75
		▶	57-370-4-286	57-371-4-286	Signal White (RAL 9003)	286°F (141°C)	\$32.75
			57-370-X-155	57-371-X-155	Jet Black (RAL 9005)	155°F (68°C)	\$92.25
			57-370-X-200	57-371-X-200	Jet Black (RAL 9005)	200°F (93°C)	\$92.25
		▶	57-370-7-135	57-371-7-135	Lead Coated	135°F (57°C)	\$98.00
		▶	57-370-7-155	57-371-7-155	Lead Coated	155°F (68°C)	\$98.00
		▶	57-370-7-175	57-371-7-175	Lead Coated	175°F (79°C)	\$98.00
	▶	57-370-7-200	57-371-7-200	Lead Coated	200°F (93°C)	\$98.00	
	▶	57-370-7-286	57-371-7-286	Lead Coated	286°F (141°C)	\$98.00	
	Recessed Escutcheons (Order Separately)						
		56-701-2-010	1/2" Brass Plated (Style 10)			\$9.50	
		56-701-9-010	1/2" Chrome Plated (Style 10)			\$6.55	
		56-701-4-010	1/2" Signal White (RAL 9003) (Style 10)			\$6.55	
		56-701-6-010	1/2" Jet Black (RAL 9005) (Style 10)			\$8.55	
		56-705-2-010	1/2" Brass Plated (Style 20)			\$9.50	
		56-705-9-010	1/2" Chrome Plated (Style 20)			\$6.55	
		56-705-4-010	1/2" Signal White (RAL 9003) (Style 20)			\$6.55	
		56-705-6-010	1/2" Jet Black (RAL 9005) (Style 20)			\$8.55	
	Sprinkler Wrench						
		56-000-6-387	W-Type 6 Wrench			\$51.25	
	56-850-4-001	W-Type 7 Wrench (Recessed Only)			\$85.00		

*** Note:**

Updated design will replace existing sprinkler model beginning in March 2013. This transition will occur on a part-by-part basis. Specific temperatures and finishes will transition to the updated design once current inventory is depleted for the current sprinkler.

Technical Data Sheet: TFP171

Section 1
Standard Spray Sprinklers

Section 2
Extended Coverage Sprinklers

Section 3
Storage Sprinklers

Section 4
Residential Products

Section 5
Dry Sprinklers

Section 6
Special Sprinklers

Section 7
Nozzles and Sprinkler Accessories

TY-FRB, 3mm Bulb, Quick Response, K=8.0, 3/4" NPT, Pendent, Recessed Pendent and Upright Sprinkler

100 Box Quantity (Upright 18 lbs/box (SIN TY4131), Pendent 17 lbs/box (SIN TY4231))

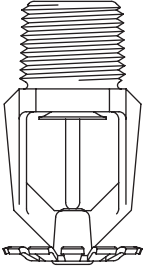
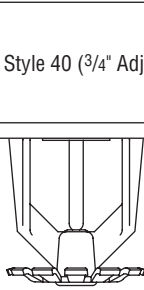
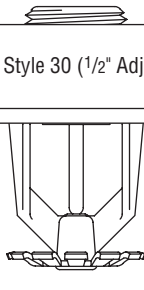
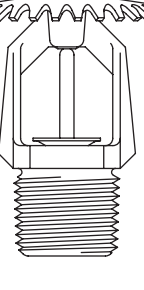
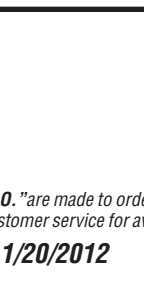
	C.O.	Upright	Pendent	Finish	Temperature	List Price
	▶	57-390-1-135	57-391-1-135	Brass	135°F (57°C)	\$42.75
		57-390-1-155	57-391-1-155	Brass	155°F (68°C)	\$42.75
	▶	57-390-1-175	57-391-1-175	Brass	175°F (79°C)	\$42.75
	▶	57-390-1-200	57-391-1-200	Brass	200°F (93°C)	\$42.75
		57-390-1-286	57-391-1-286	Brass	286°F (141°C)	\$42.75
	▶	57-390-9-135	57-391-9-135	Chrome	135°F (57°C)	\$45.50
		57-390-9-155	57-391-9-155	Chrome	155°F (68°C)	\$45.50
	▶	57-390-9-175	57-391-9-175	Chrome	175°F (79°C)	\$45.50
		57-390-9-200	57-391-9-200	Chrome	200°F (93°C)	\$45.50
	▶	57-390-9-286	57-391-9-286	Chrome	286°F (141°C)	\$45.50
	▶	57-390-4-135	57-391-4-135	Signal White (RAL 9003)	135°F (57°C)	\$45.50
		57-390-4-155	57-391-4-155	Signal White (RAL 9003)	155°F (68°C)	\$45.50
	▶	57-390-4-175	57-391-4-175	Signal White (RAL 9003)	175°F (79°C)	\$45.50
		57-390-4-200	57-391-4-200	Signal White (RAL 9003)	200°F (93°C)	\$45.50
	▶	57-390-4-286	57-391-4-286	Signal White (RAL 9003)	286°F (141°C)	\$45.50
	▶	57-390-X-155	57-391-X-155	Jet Black (RAL 9005)	155°F (68°C)	\$127.75
	▶	57-390-X-200	57-391-X-200	Jet Black (RAL 9005)	200°F (93°C)	\$127.75
	▶	57-390-7-135	57-391-7-135	Lead Coated	135°F (57°C)	\$110.50
	▶	57-390-7-155	57-391-7-155	Lead Coated	155°F (68°C)	\$110.50
	▶	57-390-7-175	57-391-7-175	Lead Coated	175°F (79°C)	\$110.50
	▶	57-390-7-200	57-391-7-200	Lead Coated	200°F (93°C)	\$110.50
	▶	57-390-7-286	57-391-7-286	Lead Coated	286°F (141°C)	\$110.50
Recessed Escutcheons (Order Separately)						
		56-705-2-011	3/4" Brass Recessed (Style 30)			\$9.50
		56-705-9-011	3/4" Chrome Recessed (Style 30)			\$6.85
		56-705-4-011	3/4" Signal White (RAL 9003) Recessed (Style 30)			\$6.85
		56-705-6-011	3/4" Jet Black (RAL 9005) Recessed (Style 30)			\$8.70
		56-700-2-010	3/4" Brass Plated (Style 40)			\$9.50
		56-700-9-010	3/4" Chrome Plated (Style 40)			\$6.85
		56-700-4-010	3/4" Signal White (RAL 9003) Recessed (Style 40)			\$6.85
		56-700-6-010	3/4" Jet Black (RAL 9005) Recessed (Style 40)			\$8.70
Sprinkler Wrench						
		56-000-6-387	W-Type 6 Wrench			\$51.25
		56-850-4-001	W-Type 7 Wrench (Recessed Only)			\$85.00
Technical Data Sheet: TFP171						

Items marked "C.O." are made to order and may require longer delivery times. Please contact customer service for availability.

See latest Technical Data Sheets for specific Approvals, Listings, Design Parameters & available finishes. Sprinkler heads & escutcheons are priced separately unless otherwise noted.

**TY-FRB, 3mm Bulb, Quick Response, K=5.6, 1/2" NPT
Horizontal Sidewall Sprinkler, Recessed Horizontal Sidewall and Vertical Sidewall**

100 Box Quantity (18 lbs/box) (Horizontal Sidewall SIN TY3331) (Vertical Sidewall SIN TY3431)

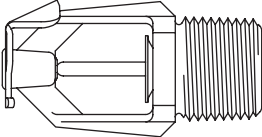
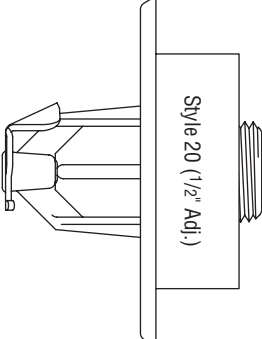
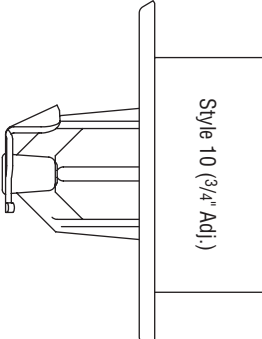
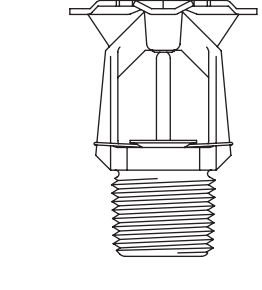
	C.O.	Horiz. Sidewall	Vertical Sidewall	Finish	Temperature	List Price
	▶	57-378-1-135	57-375-1-135	Brass	135°F (57°C)	\$58.50
		57-378-1-155	57-375-1-155	Brass	155°F (68°C)	\$58.50
	▶	57-378-1-175	57-375-1-175	Brass	175°F (79°C)	\$58.50
		57-378-1-200	57-375-1-200	Brass	200°F (93°C)	\$58.50
	▶	57-378-1-286	57-375-1-286	Brass	286°F (141°C)	\$58.50
	▶	57-378-9-135	57-375-9-135	Chrome	135°F (57°C)	\$63.00
		57-378-9-155	57-375-9-155	Chrome	155°F (68°C)	\$63.00
	▶	57-378-9-175	57-375-9-175	Chrome	175°F (79°C)	\$63.00
		57-378-9-200	57-375-9-200	Chrome	200°F (93°C)	\$63.00
	▶	57-378-9-286	57-375-9-286	Chrome	286°F (141°C)	\$63.00
	▶	57-378-4-135	57-375-4-135	Signal White (RAL 9003)	135°F (57°C)	\$63.00
		57-378-4-155	57-375-4-155	Signal White (RAL 9003)	155°F (68°C)	\$63.00
	▶	57-378-4-175	57-375-4-175	Signal White (RAL 9003)	175°F (79°C)	\$63.00
		57-378-4-200	57-375-4-200	Signal White (RAL 9003)	200°F (93°C)	\$63.00
	▶	57-378-4-286	57-375-4-286	Signal White (RAL 9003)	286°F (141°C)	\$63.00
	▶	57-378-X-155	57-375-X-155	Jet Black (RAL 9005)	155°F (68°C)	\$174.75
		57-378-X-200	57-375-X-200	Jet Black (RAL 9005)	200°F (93°C)	\$174.75
	▶	57-378-7-135	57-375-7-135	Lead Coated	135°F (57°C)	\$110.50
		57-378-7-155	57-375-7-155	Lead Coated	155°F (68°C)	\$110.50
	▶	57-378-7-175	57-375-7-175	Lead Coated	175°F (79°C)	\$110.50
	57-378-7-200	57-375-7-200	Lead Coated	200°F (93°C)	\$110.50	
	57-378-7-286	57-375-7-286	Lead Coated	286°F (141°C)	\$110.50	
Recessed Escutcheons (Order Separately)						
	56-701-2-010	1/2" Brass (Style 10)				\$9.50
	56-701-9-010	1/2" Chrome (Style 10)				\$6.55
	56-701-4-010	1/2" Signal White (RAL 9003) (Style 10)				\$6.55
	56-701-6-010	1/2" Jet Black (RAL 9005) (Style 10)				\$8.55
	56-705-2-010	1/2" Brass (Style 20)				\$9.50
	56-705-9-010	1/2" Chrome (Style 20)				\$6.55
	56-705-4-010	1/2" Signal White (RAL 9003) (Style 20)				\$6.55
	56-705-6-010	1/2" Jet Black (RAL 9005) (Style 20)				\$8.55
Sprinkler Wrench						
	56-000-6-387	W-Type 6 Wrench				\$51.25
	56-850-4-001	W-Type 7 Wrench (Recessed Only)				\$85.00
Technical Data Sheet: TFP176						

Section 1
Standard Spray Sprinklers

Section 2
Extended Coverage Sprinklers

Section 3
Storage Sprinklers

Section 4
Residential Products

Section 5
Dry Sprinklers

Section 6
Special Sprinklers

Section 7
Nozzles and Sprinkler Accessories

See latest Technical Data Sheets for specific Approvals, Listings, Design Parameters & available finishes. Sprinkler heads & escutcheons are priced separately unless otherwise noted.

Items marked "C.O." are made to order and may require longer delivery times. Please contact customer service for availability.

Series RFI, 5.6 K-factor, Standard Response, "Royal Flush II" Pendent Concealed Sprinklers

80 Box Quantity (29 lbs/box) SIN TY3551 - 250 psi

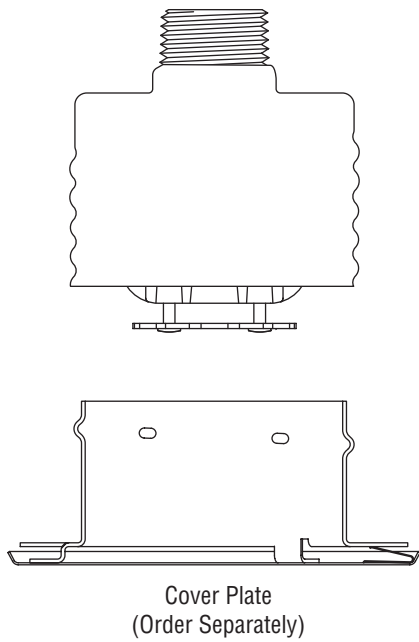

Note:
All "Special Order" cover plates are special ordered and are Non-Returnable. Please see "Terms & Conditions"

C.O.	Pendent	Finish	Temperature	List Price
High Pressure (250 psi)				
▶	51-790-1-155	Brass	155°F (68°C)	\$43.25
▶	51-790-1-200	Brass	200°F (93°C)	\$43.25
Cover Plate (For use with 155° F Sprinkler)				
80 Box Quantity (14.5 lbs/box)				
	56-792-1-135	Brass	135°F (57°C)	\$22.25
	56-792-9-135	Chrome	135°F (57°C)	\$22.25
	56-792-0-135	Grey White (RAL9002)	135°F (57°C)	\$22.25
	56-792-4-135	Signal White (RAL 9003)	135°F (57°C)	\$22.25
▶	56-792-X-135	Special Order*	135°F (57°C)	\$24.00
Cover Plate (For use with 200° F Sprinkler)				
80 Box Quantity (14.5 lbs/box)				
	56-792-1-165	Brass	165°F (74°C)	\$22.25
	56-792-9-165	Chrome	165°F (74°C)	\$22.25
	56-792-0-165	Grey White (RAL9002)	165°F (74°C)	\$22.25
	56-792-4-165	Signal White (RAL 9003)	165°F (74°C)	\$22.25
▶	56-792-X-165	Special Order*	165°F (74°C)	\$24.00
Notes				
	6012	*Special Order paint match subject to set-up charge. (Net Price)		\$376.50
Sprinkler Wrench				
	56-000-1-075	RFII Wrench		\$85.00
Air and Dust Seal				
	56-908-1-001	Air and Dust Seal		\$12.50
Technical Data Sheet: TFP181				

Section 1
Standard Spray Sprinklers

Section 2
Extended Coverage Sprinklers

Section 3
Storage Sprinklers

Section 4
Residential Products

Section 5
Dry Sprinklers

Section 6
Special Sprinklers

Section 7
Nozzles and Sprinkler Accessories

Items marked "C.O." are made to order and may require longer delivery times. Please contact customer service for availability.

See latest Technical Data Sheets for specific Approvals, Listings, Design Parameters & available finishes. Sprinkler heads & escutcheons are priced separately unless otherwise noted.

**Series RFII, 5.6 K-factor, Quick Response,
"Royal Flush II" Pendent Concealed Sprinklers**

80 Box Quantity (29 lbs/box) SIN TY3531 - 250 psi

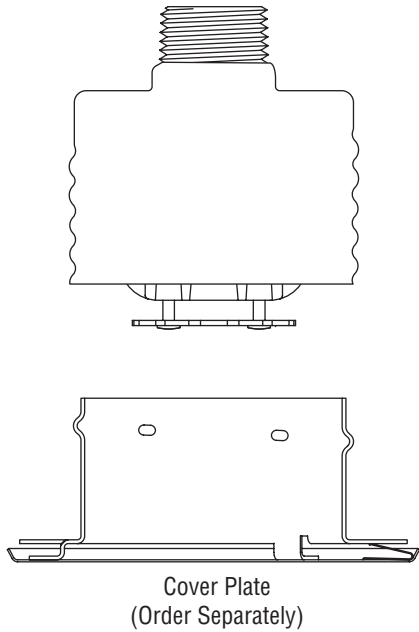

Note:
All "Special Order" cover plates are special ordered and are Non-Returnable. Please see "Terms & Conditions"

C.O.	Pendent	Finish	Temperature	List Price
High Pressure (250 psi)				
▶	51-792-1-155	Brass	155°F (68°C)	\$41.50
▶	51-792-1-200	Brass	200°F (93°C)	\$41.50
Cover Plate (For use with 155° F Sprinkler)				
80 Box Quantity (14.5 lbs/box)				
	56-792-1-135	Brass	135°F (57°C)	\$22.25
	56-792-9-135	Chrome	135°F (57°C)	\$22.25
	56-792-0-135	Grey White (RAL9002)	135°F (57°C)	\$22.25
	56-792-4-135	Signal White (RAL 9003)	135°F (57°C)	\$22.25
▶	56-792-X-135	Special Order*	135°F (57°C)	\$24.00
Cover Plate (For use with 200° F Sprinkler)				
80 Box Quantity (14.5 lbs/box)				
	56-792-1-165	Brass	165°F (74°C)	\$22.25
	56-792-9-165	Chrome	165°F (74°C)	\$22.25
	56-792-0-165	Grey White (RAL9002)	165°F (74°C)	\$22.25
	56-792-4-165	Signal White (RAL 9003)	165°F (74°C)	\$22.25
▶	56-792-X-165	Special Order*	165°F (74°C)	\$24.00
Notes				
	6012	*Special Order paint match subject to set-up charge. (Net Price)		\$376.50
Sprinkler Wrench				
	56-000-1-075	RFII Wrench		\$85.00
Air and Dust Seal				
	56-908-1-001	Air and Dust Seal		\$12.50
Technical Data Sheet: TFP181				

Section 1
Standard Spray Sprinklers

Section 2
Extended Coverage Sprinklers

Section 3
Storage Sprinklers

Section 4
Residential Products

Section 5
Dry Sprinklers

Section 6
Special Sprinklers

Section 7
Nozzles and Sprinkler Accessories

See latest Technical Data Sheets for specific Approvals, Listings, Design Parameters & available finishes. Sprinkler heads & escutcheons are priced separately unless otherwise noted.

Items marked "C.O." are made to order and may require longer delivery times. Please contact customer service for availability.

Model TYQRF, K=5.6, Quick Response Standard Coverage, Flush Pendent Sprinklers

(SIN TY3261)

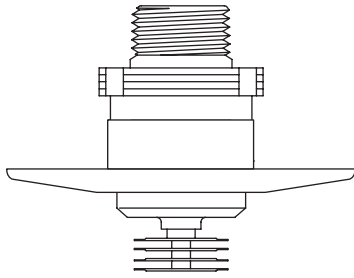

C.O.	Pendent	Finish	Temperature	List Price
	53-261-9-162	Chrome	162°F (72°C)	\$61.50
	53-261-4-162	Signal White (RAL 9003)	162°F (72°C)	\$61.50
	53-261-6-162	Jet Black (RAL 9005)	162°F (72°C)	\$69.25
Trim Plates (Order Separately)				
	56-123-9-001	Chrome Escutcheon		\$7.60
	56-123-4-001	Signal White (RAL 9003) Escutcheon		\$7.60
	56-123-6-001	Jet Black (RAL 9005) Escutcheon		\$7.60
Sprinkler Wrench				
	56-000-4-947	Wrench (Socket Only)		\$90.75
	56-000-4-948	Socket/Ratchet Wrench		\$135.00
	56-000-4-300	Protective Cover Removal Tool		\$30.00
Technical Data Sheet: TFP190				

Section 1
Standard Spray Sprinklers

Section 2
Extended Coverage Sprinklers

Section 3
Storage Sprinklers

Section 4
Residential Products

Section 5
Dry Sprinklers

Section 6
Special Sprinklers



Section 7
Nozzles and Sprinkler Accessories

Items marked "C.O." are made to order and may require longer delivery times. Please contact customer service for availability.

See latest Technical Data Sheets for specific Approvals, Listings, Design Parameters & available finishes. Sprinkler heads & escutcheons are priced separately unless otherwise noted.

**TY-B, 5mm Bulb, K=5.6, 1/2" NPT Pendent,
Recessed Pendent and Upright (New Design*)**

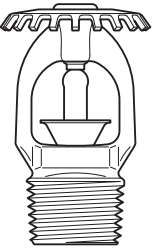
100 Box Quantity (Upright 18 lbs/box (SIN TY315), Pendent 17 lbs/box (SIN TY325))

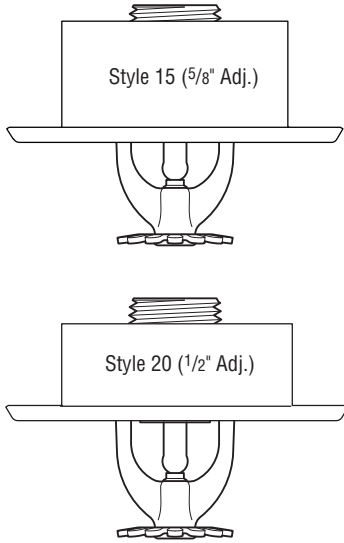
	C.O.	Upright	Pendent	Finish	Temperature	List Price	
	▶	77-570-1-135	77-571-1-135	Natural Brass	135°F (57°C)	\$19.25	
		77-570-1-155	77-571-1-155	Natural Brass	155°F (68°C)	\$18.00	
	▶	77-570-1-175	77-571-1-175	Natural Brass	175°F (79°C)	\$19.25	
		77-570-1-200	77-571-1-200	Natural Brass	200°F (93°C)	\$18.00	
		77-570-1-286	77-571-1-286	Natural Brass	286°F (141°C)	\$18.00	
	▶	77-570-9-135	77-571-9-135	Chrome Plated	135°F (57°C)	\$22.25	
		77-570-9-155	77-571-9-155	Chrome Plated	155°F (68°C)	\$21.25	
	▶	77-570-9-175	77-571-9-175	Chrome Plated	175°F (79°C)	\$22.25	
	▶	77-570-9-200	77-571-9-200	Chrome Plated	200°F (93°C)	\$22.25	
	▶	77-570-9-286	77-571-9-286	Chrome Plated	286°F (141°C)	\$22.25	
	▶	77-570-4-135	77-571-4-135	Signal White (RAL 9003)	135°F (57°C)	\$22.25	
		77-570-4-155	77-571-4-155	Signal White (RAL 9003)	155°F (68°C)	\$21.25	
	▶	77-570-4-175	77-571-4-175	Signal White (RAL 9003)	175°F (79°C)	\$22.25	
		77-570-4-200	77-571-4-200	Signal White (RAL 9003)	200°F (93°C)	\$22.25	
	▶	77-570-4-286	77-571-4-286	Signal White (RAL 9003)	286°F (141°C)	\$22.25	
Recessed Escutcheons (Order Separately)							
		56-715-2-010	1/2" Brass Plated (Style 15)			\$9.50	
		56-715-9-010	1/2" Chrome Plated (Style 15)			\$6.55	
		56-715-4-010	1/2" Signal White (RAL 9003) (Style 15)			\$6.55	
		56-715-6-010	1/2" Jet Black (RAL 9005)(Style 15)			\$8.55	
		56-705-2-010	1/2" Brass (Style 20)			\$9.50	
		56-705-9-010	1/2" Chrome (Style 20)			\$6.55	
		56-705-4-010	1/2" Signal White (RAL 9003) (Style 20)			\$6.55	
		56-705-6-010	1/2" Jet Black (RAL 9005) (Style 20)			\$8.55	
	Sprinkler Wrench						
		56-000-6-387	W-Type 6 Wrench			\$51.25	
	56-850-4-001	W-Type 7 Wrench (Recessed Only)			\$85.00		
<p>* Note: Updated design will replace existing sprinkler model beginning in March 2013. This transition will occur on a part-by-part basis. Specific temperatures and finishes will transition to the updated design once current inventory is depleted for the current sprinkler.</p>							
Technical Data Sheet: TFP152							

Section 1
Standard Spray Sprinklers

Section 2
Extended Coverage Sprinklers

Section 3
Storage Sprinklers

Section 4
Residential Products

Section 5
Dry Sprinklers

Section 6
Special Sprinklers

Section 7
Nozzles and Sprinkler Accessories

See latest Technical Data Sheets for specific Approvals, Listings, Design Parameters & available finishes. Sprinkler heads & escutcheons are priced separately unless otherwise noted.

Items marked "C.O." are made to order and may require longer delivery times. Please contact customer service for availability.

TY-FRB, 3mm Bulb, Quick Response, K=5.6, 1/2" NPT, Pendent, Recessed Pendent and Upright Sprinkler (New Design *)

100 Box Quantity (Upright 18 lbs/box (SIN TY313), Pendent 17 lbs/box (SIN TY323))

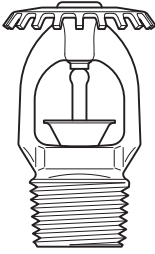
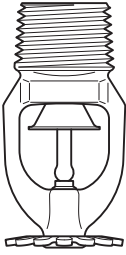
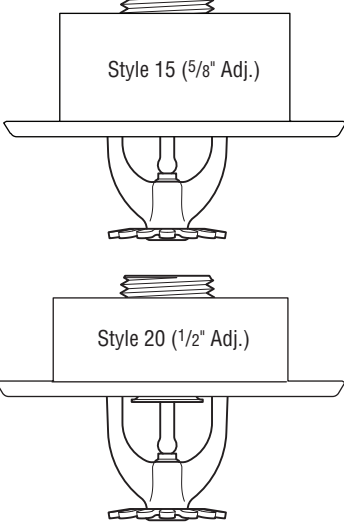
	C.O.	Upright	Pendent	Finish	Temperature	List Price
	▶	77-370-1-135	77-371-1-135	Brass	135°F (57°C)	\$32.25
		77-370-1-155	77-371-1-155	Brass	155°F (68°C)	\$30.25
	▶	77-370-1-175	77-371-1-175	Brass	175°F (79°C)	\$32.25
		77-370-1-200	77-371-1-200	Brass	200°F (93°C)	\$30.25
		77-370-1-286	77-371-1-286	Brass	286°F (141°C)	\$30.25
	▶	77-370-9-135	77-371-9-135	Chrome	135°F (57°C)	\$35.25
		77-370-9-155	77-371-9-155	Chrome	155°F (68°C)	\$32.75
	▶	77-370-9-175	77-371-9-175	Chrome	175°F (79°C)	\$35.25
		77-370-9-200	77-371-9-200	Chrome	200°F (93°C)	\$35.25
		77-370-9-286	77-371-9-286	Chrome	286°F (141°C)	\$35.25
	▶	77-370-4-135	77-371-4-135	Signal White (RAL 9003)	135°F (57°C)	\$32.75
		77-370-4-155	77-371-4-155	Signal White (RAL 9003)	155°F (68°C)	\$32.75
	▶	77-370-4-175	77-371-4-175	Signal White (RAL 9003)	175°F (79°C)	\$32.75
	▶	77-370-4-200	77-371-4-200	Signal White (RAL 9003)	200°F (93°C)	\$32.75
	▶	77-370-4-286	77-371-4-286	Signal White (RAL 9003)	286°F (141°C)	\$32.75
	Recessed Escutcheons (Order Separately)					
		56-715-2-010	1/2" Brass Plated (Style 15)			\$9.50
		56-715-9-010	1/2" Chrome Plated (Style 15)			\$6.55
		56-715-4-010	1/2" Signal White (RAL 9003) (Style 15)			\$6.55
		56-715-6-010	1/2" Jet Black (RAL 9005) (Style 15)			\$8.55
		56-705-2-010	1/2" Brass Plated (Style 20)			\$9.50
		56-705-9-010	1/2" Chrome Plated (Style 20)			\$6.55
		56-705-4-010	1/2" Signal White (RAL 9003) (Style 20)			\$6.55
		56-705-6-010	1/2" Jet Black (RAL 9005) (Style 20)			\$8.55
Sprinkler Wrench						
		56-000-6-387	W-Type 6 Wrench			\$51.25
		56-850-4-001	W-Type 7 Wrench (Recessed Only)			\$85.00
<p>* Note: Updated design will replace existing sprinkler model beginning in March 2013. This transition will occur on a part-by-part basis. Specific temperatures and finishes will transition to the updated design once current inventory is depleted for the current sprinkler.</p>						

Technical Data Sheet: TFP172

Items marked "C.O." are made to order and may require longer delivery times. Please contact customer service for availability.

See latest Technical Data Sheets for specific Approvals, Listings, Design Parameters & available finishes. Sprinkler heads & escutcheons are priced separately unless otherwise noted.

Section 1
Standard Spray Sprinklers

Section 2
Extended Coverage Sprinklers

Section 3
Storage Sprinklers

Section 4
Residential Products

Section 5
Dry Sprinklers

Section 6
Special Sprinklers

Section 7
Nozzles and Sprinkler Accessories

Model EC-25, K=25.2, 1" NPT, Upright, Area/Density, Extended Coverage (SIN TY9128)

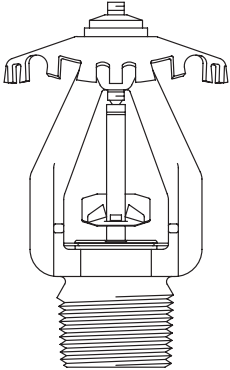
SIN TY9128					
	C.O.	Upright	Description	Temperature	List Price
		58-450-1-165	Brass	165°F (74°C)	\$94.25
		58-450-1-214	Brass	214°F (101°C)	\$94.25
	Sprinkler Wrench				
		56-872-1-025	W-Type 1 Wrench		\$64.75
Technical Data Sheet: TFP213					

Section 1
Standard Spray Sprinklers

Section 2
Extended Coverage Sprinklers

Series EC-14, Upright Sprinklers K=14.0, 3/4" N.P.T.

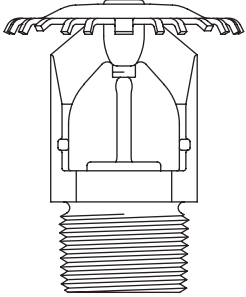
100 Box Quantity 27 lbs/box SIN TY6137						
	C.O.	Upright	Description	Temperature	List Price	
	▶	51-896-1-135	Brass	135°F (57°C)	\$85.50	
		51-896-1-155	Brass	155°F (68°C)	\$85.50	
	▶	51-896-1-175	Brass	175°F (79°C)	\$85.50	
		51-896-1-200	Brass	200°F (93°C)	\$85.50	
	▶	51-896-1-286	Brass	286°F (141°C)	\$85.50	
	▶	51-896-9-135	Chrome	135°F (57°C)	\$89.75	
		51-896-9-155	Chrome	155°F (68°C)	\$89.75	
	▶	51-896-9-175	Chrome	175°F (79°C)	\$89.75	
	▶	51-896-9-200	Chrome	200°F (93°C)	\$89.75	
	▶	51-896-9-286	Chrome	286°F (141°C)	\$89.75	
	▶	51-896-4-135	Signal White (RAL 9003)	135°F (57°C)	\$89.75	
		51-896-4-155	Signal White (RAL 9003)	155°F (68°C)	\$89.75	
	▶	51-896-4-175	Signal White (RAL 9003)	175°F (79°C)	\$89.75	
	▶	51-896-4-200	Signal White (RAL 9003)	200°F (93°C)	\$89.75	
	▶	51-896-4-286	Signal White (RAL 9003)	286°F (141°C)	\$89.75	
	▶	51-896-X-155	Jet Black (RAL 9005)	155°F (68°C)	\$130.00	
	▶	51-896-X-200	Jet Black (RAL 9005)	200°F (93°C)	\$130.00	
	▶	51-896-7-135	Lead Coated	135°F (57°C)	\$136.50	
	▶	51-896-7-155	Lead Coated	155°F (68°C)	\$136.50	
	▶	51-896-7-175	Lead Coated	175°F (79°C)	\$136.50	
	▶	51-896-7-200	Lead Coated	200°F (93°C)	\$136.50	
	▶	51-896-7-286	Lead Coated	286°F (141°C)	\$136.50	
	Sprinkler Wrench					
		56-895-1-001	W-Type 3 Wrench		\$70.50	
Technical Data Sheet: TFP220						

Section 3
Storage Sprinklers

Section 4
Residential Products

Section 5
Dry Sprinklers

Section 6
Special Sprinklers

Section 7
Nozzles and Sprinkler Accessories

See latest Technical Data Sheets for specific Approvals, Listings, Design Parameters & available finishes. Sprinkler heads & escutcheons are priced separately unless otherwise noted.

Items marked "C.O." are made to order and may require longer delivery times. Please contact customer service for availability.

Series EC-14, Pendent and Recessed Pendent Sprinklers K=14.0, 3/4" N.P.T.

100 Box Quantity, 27 lbs/box (SIN TY6237)

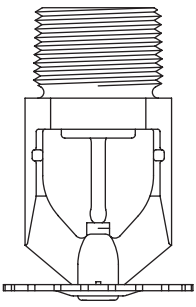
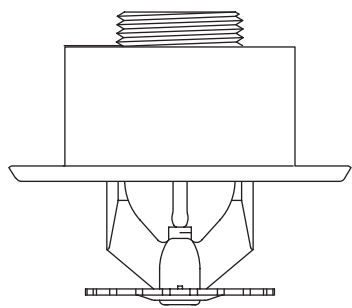
	C.O.	Pendent	Description	Temperature	List Price
	▶	51-895-1-135	Brass	135°F (57°C)	\$60.50
		51-895-1-155	Brass	155°F (68°C)	\$60.50
	▶	51-895-1-175	Brass	175°F (79°C)	\$60.50
		51-895-1-200	Brass	200°F (93°C)	\$60.50
	▶	51-895-1-286	Brass	286°F (141°C)	\$60.50
	▶	51-895-9-135	Chrome	135°F (57°C)	\$63.75
		51-895-9-155	Chrome	155°F (68°C)	\$63.75
	▶	51-895-9-175	Chrome	175°F (79°C)	\$63.75
	▶	51-895-9-200	Chrome	200°F (93°C)	\$63.75
	▶	51-895-9-286	Chrome	286°F (141°C)	\$63.75
	▶	51-895-4-135	Signal White (RAL 9003)	135°F (57°C)	\$63.75
		51-895-4-155	Signal White (RAL 9003)	155°F (68°C)	\$63.75
	▶	51-895-4-175	Signal White (RAL 9003)	175°F (79°C)	\$63.75
	▶	51-895-4-200	Signal White (RAL 9003)	200°F (93°C)	\$63.75
	▶	51-895-4-286	Signal White (RAL 9003)	286°F (141°C)	\$63.75
	▶	51-895-X-155	Jet Black (RAL 9005)	155°F (68°C)	\$119.50
	▶	51-895-X-200	Jet Black (RAL 9005)	200°F (93°C)	\$119.50
	▶	51-895-7-135	Lead Coated	135°F (57°C)	\$125.50
	▶	51-895-7-155	Lead Coated	155°F (68°C)	\$125.50
	▶	51-895-7-175	Lead Coated	175°F (79°C)	\$125.50
▶	51-895-7-200	Lead Coated	200°F (93°C)	\$125.50	
▶	51-895-7-286	Lead Coated	286°F (141°C)	\$125.50	
Recessed Escutcheons (Order Separately)					
		56-705-2-011	3/4" Brass Recessed (Style 30)		\$9.50
		56-705-9-011	3/4" Chrome Recessed (Style 30)		\$6.85
		56-705-4-011	3/4" Signal White (RAL 9003) Recessed (Style 30)		\$6.85
		56-705-6-011	3/4" Jet Black (RAL 9005) Recessed (Style 30)		\$8.70
		56-700-2-010	3/4" Brass Recessed (Style 40)		\$9.50
		56-700-9-010	3/4" Chrome Recessed (Style 40)		\$6.85
		56-700-4-010	3/4" Signal White (RAL 9003) Recessed (Style 40)		\$6.85
		56-700-6-010	3/4" Jet Black (RAL 9005) Recessed (Style 40)		\$8.70
		208102	3/4" Chrome Recessed (Style 60)		\$6.85
		208104	3/4" Signal White (RAL 9003) Recessed (Style 60)		\$6.85
		208107	3/4" Brass Recessed (Style 60)		\$9.50
Sprinkler Wrench					
		56-895-1-001	W-Type 3 Wrench		\$70.50
		56-665-7-001	W-Type 22 (Recessed Only)		\$85.00
Technical Data Sheet: TFP220					

Items marked "C.O." are made to order and may require longer delivery times. Please contact customer service for availability.

See latest Technical Data Sheets for specific Approvals, Listings, Design Parameters & available finishes. Sprinkler heads & escutcheons are priced separately unless otherwise noted.

Section 1
Standard Spray Sprinklers

Section 2
Extended Coverage Sprinklers

Section 3
Storage Sprinklers

Section 4
Residential Products

Section 5
Dry Sprinklers

Section 6
Special Sprinklers

Section 7
Nozzles and Sprinkler Accessories

Series EC-11, Pendent, Recessed Pendent and Upright Sprinklers - K=11.2, 3/4" NPT

100 Box Quantity (Upright 27 lbs/box (SIN TY5137), Pendent 27 lbs/box (SIN TY5237))

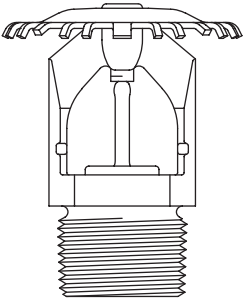
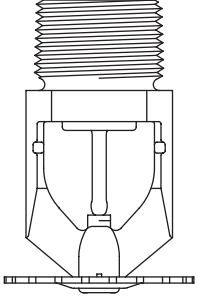
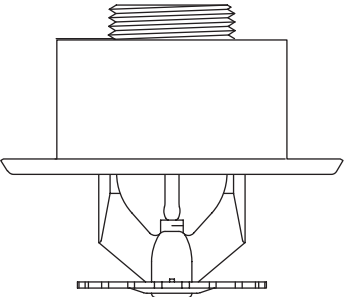
	<i>C.O.</i>	<i>Upright</i>	<i>Pendent</i>	<i>Description</i>	<i>Temperature</i>	<i>List Price</i>
	▶	51-894-1-135	51-893-1-135	Brass	135°F (57°C)	\$54.75
		51-894-1-155	51-893-1-155	Brass	155°F (68°C)	\$54.75
	▶	51-894-1-175	51-893-1-175	Brass	175°F (79°C)	\$54.75
		51-894-1-200	51-893-1-200	Brass	200°F (93°C)	\$54.75
	▶	51-894-1-286	51-893-1-286	Brass	286°F (141°C)	\$54.75
	▶	51-894-9-135	51-893-9-135	Chrome	135°F (57°C)	\$57.50
		51-894-9-155	51-893-9-155	Chrome	155°F (68°C)	\$57.50
	▶	51-894-9-175	51-893-9-175	Chrome	175°F (79°C)	\$57.50
	▶	51-894-9-200	51-893-9-200	Chrome	200°F (93°C)	\$57.50
	▶	51-894-9-286	51-893-9-286	Chrome	286°F (141°C)	\$57.50
	▶	51-894-4-135	51-893-4-135	Signal White (RAL 9003)	135°F (57°C)	\$57.50
		51-894-4-155	51-893-4-155	Signal White (RAL 9003)	155°F (68°C)	\$57.50
	▶	51-894-4-175	51-893-4-175	Signal White (RAL 9003)	175°F (79°C)	\$57.50
	▶	51-894-4-200	51-893-4-200	Signal White (RAL 9003)	200°F (93°C)	\$57.50
	▶	51-894-4-286	51-893-4-286	Signal White (RAL 9003)	286°F (141°C)	\$57.50
	▶	51-894-X-155	51-893-X-155	Jet Black (RAL 9005)	155°F (68°C)	\$108.00
	▶	51-894-X-200	51-893-X-200	Jet Black (RAL 9005)	200°F (93°C)	\$108.00
	▶	51-894-7-135	51-893-7-135	Lead Coated	135°F (57°C)	\$113.50
	▶	51-894-7-155	51-893-7-155	Lead Coated	155°F (68°C)	\$113.50
	▶	51-894-7-175	51-893-7-175	Lead Coated	175°F (79°C)	\$113.50
▶	51-894-7-200	51-893-7-200	Lead Coated	200°F (93°C)	\$113.50	
▶	51-894-7-286	51-893-7-286	Lead Coated	286°F (141°C)	\$113.50	
	Recessed Escutcheons (Order Separately)					
		56-705-2-011	3/4" Brass Recessed (Style 30)			\$9.50
		56-705-9-011	3/4" Chrome Recessed (Style 30)			\$6.85
		56-705-4-011	3/4" Signal White (RAL 9003) Recessed (Style 30)			\$6.85
		56-705-6-011	3/4" Jet Black (RAL 9005) Recessed (Style 30)			\$8.70
		56-700-2-010	3/4" Brass Recessed (Style 40)			\$9.50
		56-700-9-010	3/4" Chrome Recessed (Style 40)			\$6.85
		56-700-4-010	3/4" Signal White (RAL 9003) Recessed (Style 40)			\$6.85
		56-700-6-010	3/4" Jet Black (RAL 9005) Recessed (Style 40)			\$8.70
		208102	3/4" Chrome Recessed (Style 60)			\$6.85
	208104	3/4" Signal White (RAL 9003) Recessed (Style 60)			\$6.85	
	208107	3/4" Brass Recessed (Style 60)			\$9.50	
Sprinkler Wrench						
	56-895-1-001	W-Type 3 Wrench			\$70.50	
	56-665-7-001	W-Type 22 (Recessed Only)			\$85.00	
Technical Data Sheet: TFP220						

Section 1
Standard Spray Sprinklers

Section 2
Extended Coverage Sprinklers

Section 3
Storage Sprinklers

Section 4
Residential Products

Section 5
Dry Sprinklers

Section 6
Special Sprinklers

Section 7
Nozzles and Sprinkler Accessories

See latest Technical Data Sheets for specific Approvals, Listings, Design Parameters & available finishes. Sprinkler heads & escutcheons are priced separately unless otherwise noted.

Items marked "C.O." are made to order and may require longer delivery times. Please contact customer service for availability.

TY-FRB, 3 mm Bulb, K=5.6, 1/2" NPT, Quick Response
Extended Coverage, Horizontal Sidewall and Recessed Horizontal Sidewall Sprinklers

100 Box Quantity (21 lbs/box) (SIN TY3332)

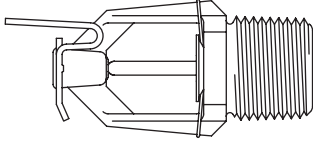
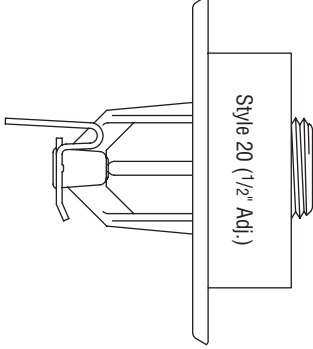
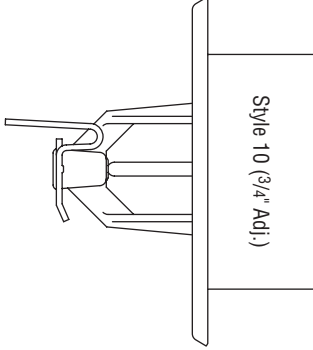
	C.O.	Horizontal Sidewall	Finish	Temperature	List Price	
	▶	57-376-1-135	Brass	135°F (57°C)	\$35.50	
		57-376-1-155	Brass	155°F (68°C)	\$35.50	
	▶	57-376-1-175	Brass	175°F (79°C)	\$35.50	
	▶	57-376-9-135	Chrome	135°F (57°C)	\$38.25	
		57-376-9-155	Chrome	155°F (68°C)	\$38.25	
	▶	57-376-9-175	Chrome	175°F (79°C)	\$38.25	
	▶	57-376-4-135	Signal White (RAL 9003)	135°F (57°C)	\$38.25	
		57-376-4-155	Signal White (RAL 9003)	155°F (68°C)	\$38.25	
	▶	57-376-4-175	Signal White (RAL 9003)	175°F (79°C)	\$38.25	
	▶	57-376-X-135	Jet Black (RAL 9005)	135°F (57°C)	\$105.00	
	▶	57-376-X-155	Jet Black (RAL 9005)	155°F (68°C)	\$105.00	
	▶	57-376-X-175	Jet Black (RAL 9005)	175°F (79°C)	\$105.00	
	Recessed Escutcheons (Order Separately)					
		56-701-2-010	1/2" Brass Recessed (Style 10)			\$9.50
		56-701-9-010	1/2" Chrome Recessed (Style 10)			\$6.55
		56-701-4-010	1/2" Signal White (RAL 9003) Recessed (Style 10)			\$6.55
		56-701-6-010	1/2" Jet Black (RAL 9005) Recessed (Style 10)			\$8.55
			56-705-2-010	1/2" Brass Recessed (Style 20)		
		56-705-9-010	1/2" Chrome Recessed (Style 20)			\$6.55
		56-705-4-010	1/2" Signal White (RAL 9003) (Style 20)			\$6.55
		56-705-6-010	1/2" Jet Black (RAL 9005) (Style 20)			\$8.55
Sprinkler Wrench						
		56-000-6-387	W-Type 6 Wrench			\$51.25
		56-850-4-001	W-Type 7 Wrench (Recessed Only)			\$85.00
Technical Data Sheet: TFP296						

Items marked "C.O." are made to order and may require longer delivery times. Please contact customer service for availability.

See latest Technical Data Sheets for specific Approvals, Listings, Design Parameters & available finishes. Sprinkler heads & escutcheons are priced separately unless otherwise noted.

Section 1
Standard Spray Sprinklers

Section 2
Extended Coverage Sprinklers

Section 3
Storage Sprinklers

Section 4
Residential Products

Section 5
Dry Sprinklers

Section 6
Special Sprinklers

Section 7
Nozzles and Sprinkler Accessories

**TY-FRB, 3 mm Bulb, K=8.0, 3/4" NPT, Quick Response-Extended Coverage,
Horizontal Sidewall and Recessed Horizontal Sidewall Sprinklers**

100 Box Quantity (21 lbs/box) (SIN TY4332)

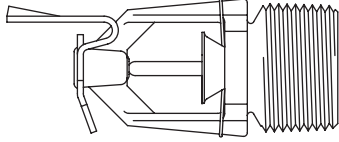
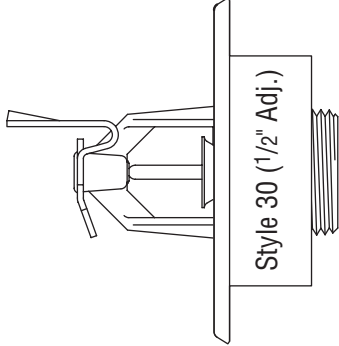
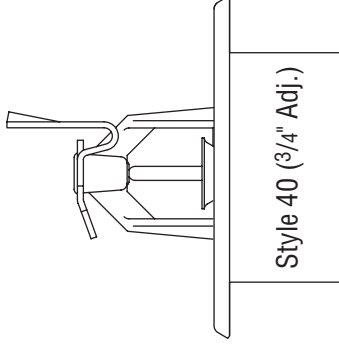
	C.O.	Sidewall	Finish	Temperature	List Price
	▶	57-396-1-135	Brass	135°F (57°C)	\$36.25
		57-396-1-155	Brass	155°F (68°C)	\$36.25
	▶	57-396-1-175	Brass	175°F (79°C)	\$36.25
	▶	57-396-9-135	Chrome	135°F (57°C)	\$41.00
		57-396-9-155	Chrome	155°F (68°C)	\$41.00
	▶	57-396-9-175	Chrome	175°F (79°C)	\$41.00
	▶	57-396-4-135	Signal White (RAL 9003)	135°F (57°C)	\$41.00
		57-396-4-155	Signal White (RAL 9003)	155°F (68°C)	\$41.00
	▶	57-396-4-175	Signal White (RAL 9003)	175°F (79°C)	\$41.00
	▶	57-396-X-135	Jet Black (RAL 9005)	135°F (57°C)	\$108.25
	▶	57-396-X-155	Jet Black (RAL 9005)	155°F (68°C)	\$108.25
	▶	57-396-X-175	Jet Black (RAL 9005)	175°F (79°C)	\$108.25
Recessed Escutcheons (Order Separately)					
		56-705-2-011	3/4" Brass Recessed (Style 30)		\$9.50
		56-705-9-011	3/4" Chrome Recessed (Style 30)		\$6.85
		56-705-4-011	3/4" Signal White (RAL 9003) Recessed (Style 30)		\$6.85
		56-705-6-011	3/4" Jet Black (RAL 9005) Recessed (Style 30)		\$8.70
		56-700-2-010	3/4" Brass Recessed (Style 40)		\$9.50
		56-700-9-010	3/4" Chrome Recessed (Style 40)		\$6.85
		56-700-4-010	3/4" Signal White (RAL 9003) Recessed (Style 40)		\$6.85
		56-700-6-010	3/4" Jet Black (RAL 9005) Recessed (Style 40)		\$8.70
Sprinkler Wrench					
		56-000-6-387	W-Type 6 Wrench		\$51.25
		56-850-4-001	W-Type 7 Wrench (Recessed Only)		\$85.00
Technical Data Sheet: TFP296					

Section 1	Standard Spray Sprinklers
Section 2	Extended Coverage Sprinklers
Section 3	Storage Sprinklers
Section 4	Residential Products
Section 5	Dry Sprinklers
Section 6	Special Sprinklers
Section 7	Nozzles and Sprinkler Accessories

See latest Technical Data Sheets for specific Approvals, Listings, Design Parameters & available finishes. Sprinkler heads & escutcheons are priced separately unless otherwise noted.

Items marked "C.O." are made to order and may require longer delivery times. Please contact customer service for availability.

ELO SW-20 ECOH, Sidewall Sprinklers, K=11.2, 3/4" N.P.T.

100 Box Quantity (32 lbs/box) (SIN TY5332)

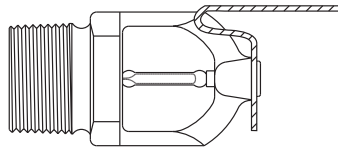

C.O.	Part No.	Model	Finish	Temperature	List Price
	51-072-1-155	ECOH ELO S/W-20	Brass	155°F (68°C)	\$131.50
	51-072-1-200	ECOH ELO S/W-20	Brass	200°F (93°C)	\$131.50
	51-072-9-155	ECOH ELO S/W-20	Chrome	155°F (68°C)	\$136.00
	51-072-9-200	ECOH ELO S/W-20	Chrome	200°F (93°C)	\$136.00
	51-072-4-155	ECOH ELO S/W-20	Signal White (RAL 9003)	155°F (68°C)	\$136.00
	51-072-4-200	ECOH ELO S/W-20	Signal White (RAL 9003)	200°F (93°C)	\$136.00

Sprinkler Wrench

56-895-1-001	W-Type 3 Wrench	\$70.50
--------------	-----------------	---------

Technical Data Sheet: TFP230

ELO SW-24 ECOH, Sidewall Sprinklers, K=11.2, 3/4" N.P.T.

100 Box Quantity (32 lbs/box) (SIN TY5337)

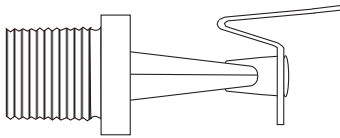

C.O.	Part No.	Model	Finish	Temperature	List Price
	51-073-1-200	ECOH ELO SW-24	Brass	200°F (93°C)	\$131.50
	51-073-9-200	ECOH ELO SW-24	Chrome	200°F (93°C)	\$136.00
	51-073-4-200	ECOH ELO SW-24	Signal White (RAL 9003)	200°F (93°C)	\$136.00

Sprinkler Wrench

56-895-1-001	W-Type 3 Wrench	\$70.50
--------------	-----------------	---------

Technical Data Sheet: TFP230

ELOC Extended Coverage, Concealed Sprinklers, K=11.2, 3/4" N.P.T. (SIN TY5522)

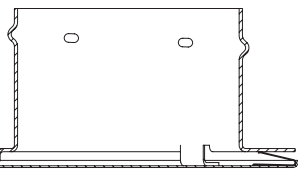
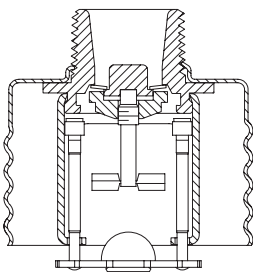

C.O.	Part No.	Model	Finish	Temperature	List Price
	50-701-1-160	ELOC	Brass	160°F (71°C)	\$59.25
▶	50-701-1-212	ELOC	Brass	212°F (100°C)	\$59.25

Cover Plates (Order Separately)

56-892-1-135	ELOC Cover Plate	Brass	139°F (59°C)	\$22.25	
56-892-8-135	ELOC Cover Plate	Chrome	139°F (59°C)	\$22.25	
56-892-8-165	ELOC Cover Plate	Chrome	165°F (74°C)	\$22.25	
56-892-9-135	ELOC Cover Plate	Brushed Chrome	139°F (59°C)	\$22.25	
56-892-9-165	ELOC Cover Plate	Brushed Chrome	165°F (74°C)	\$22.25	
56-892-0-135	ELOC Cover Plate	Grey White (RAL9002)	139°F (59°C)	\$22.25	
56-892-0-165	ELOC Cover Plate	Grey White (RAL9002)	165°F (74°C)	\$22.25	
56-892-4-135	ELOC Cover Plate	Signal White (RAL 9003)	139°F (59°C)	\$22.25	
▶	56-892-X-135	ELOC Cover Plate	Special Order*	139°F (59°C)	\$26.25

Clean Room Seals (Order Separately)

56-908-1-001	ELOC Clean Room Seal	\$12.50
--------------	----------------------	---------

Sprinkler Wrench

56-000-1-265	W-Type 18 Wrench	\$85.00
--------------	------------------	---------

Notes

6012	*Special Order paint match subject to set-up charge. (Net Price)	\$376.50
------	--	----------

Technical Data Sheet: TFP250

Note: All "Special Order" cover plates are special ordered and are Non-Returnable. Please see "Terms & Conditions"

Items marked "C.O." are made to order and may require longer delivery times. Please contact customer service for availability.

See latest Technical Data Sheets for specific Approvals, Listings, Design Parameters & available finishes. Sprinkler heads & escutcheons are priced separately unless otherwise noted.

Series RFII, 5.6 K-factor, "Royal Flush II" Pendent Concealed Sprinklers
Extended Coverage, Quick and Standard Response

80 Box Quantity (29 lbs/box) (SIN TY3532)

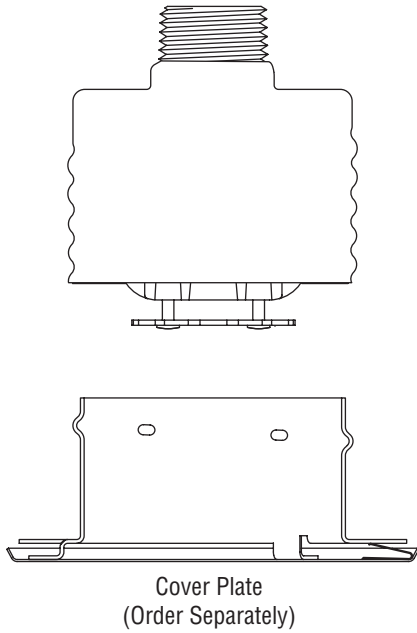

Note: All "Special Order" cover plates are special ordered and are Non-Returnable. Please see "Terms & Conditions"

C.O.	Pendent	Finish	Temperature	List Price
Standard Pressure (175 psi)				
	51-794-1-155	Bronze	155°F (68°C)	\$44.75
	51-794-1-200	Bronze	200°F (93°C)	\$44.75
Cover Plate (For use with 155° F Sprinkler)				
80 Box Quantity (14.5 lbs/box)				
	56-792-1-135	Brass	135°F (57°C)	\$22.25
	56-792-9-135	Chrome	135°F (57°C)	\$22.25
	56-792-0-135	Grey White (RAL9002)	135°F (57°C)	\$22.25
	56-792-4-135	Signal White (RAL 9003)	135°F (57°C)	\$22.25
	56-792-X-135	Special Order*	135°F (57°C)	\$24.00
Cover Plate (For use with 200° F Sprinkler)				
80 Box Quantity (14.5 lbs/box)				
	56-792-1-165	Brass	165°F (74°C)	\$22.25
	56-792-9-165	Chrome	165°F (74°C)	\$22.25
	56-792-0-165	Grey White (RAL9002)	165°F (74°C)	\$22.25
	56-792-4-165	Signal White (RAL 9003)	165°F (74°C)	\$22.25
	56-792-X-165	Special Order*	165°F (74°C)	\$24.00
Air and Dust Seal				
	56-908-1-001	Air and Dust Seal		\$12.50
Sprinkler Wrench				
	56-000-1-075	RFII Wrench		\$85.00
Notes				
	6012	*Special Order paint match subject to set-up charge. (Net Price)		\$376.50
Technical Data Sheet: TFP260				

Model TY-FRL, K=5.6, 1/2" NPT Extended Coverage Quick Response
Horizontal Sidewall Sprinkler

100 Box Quantity (20 lbs/box) (SIN TY3322)

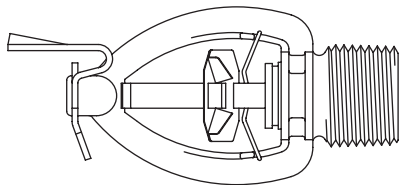

C.O.	Horizontal Sidewall	Finish	Temperature	List Price
	58-970-1-165	Brass	165°F (74°C)	\$78.75
	58-970-9-165	Chrome	165°F (74°C)	\$88.75
Sprinkler Wrench				
	56-000-1-849	W-Type 9 Wrench		\$45.75
Technical Data Sheet: TFP280				

See latest Technical Data Sheets for specific Approvals, Listings, Design Parameters & available finishes. Sprinkler heads & escutcheons are priced separately unless otherwise noted.

Items marked "C.O." are made to order and may require longer delivery times. Please contact customer service for availability.

Section 1
Standard Spray Sprinklers

Section 2
Extended Coverage Sprinklers

Section 3
Storage Sprinklers

Section 4
Residential Products

Section 5
Dry Sprinklers

Section 6
Special Sprinklers

Section 7
Nozzles and Sprinkler Accessories

Model TY-FRL, K=8.0, 3/4" NPT, Quick Response
Extended Coverage Horizontal Sidewall Sprinklers

100 Box Quantity (25 lbs/box) (SIN TY4322)

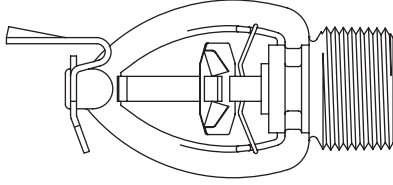

C.O.	Horizontal Sizewall	Description	Temperature	List Price
	58-170-1-165	Brass	165°F (74°C)	\$88.75
	58-170-9-165	Chrome	165°F (74°C)	\$99.00
Sprinkler Wrench				
	56-000-1-849	W-Type 9 Wrench		\$45.75

Technical Data Sheet: TFP280

CHEC Concealed Horizontal Sidewall
Extended Coverage Sprinklers, K=8.0, 3/4" N.P.T. ECLH (SIN TY4332)

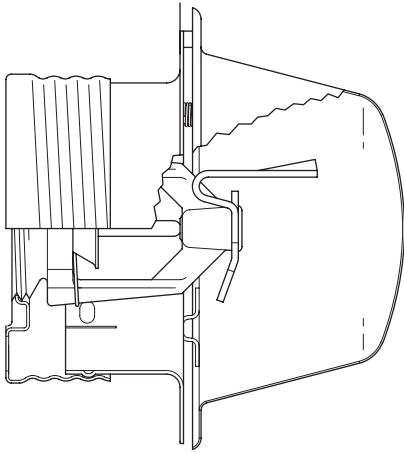

C.O.	Number	Model	Temperature	List Price
	51-396-1-155	CHEC Sidewall	155°F (68°C)	\$37.50
Cover Plate (Order Separately)				
	56-396-4-135	Signal White (RAL 9003)		\$21.00
	56-396-9-135	Chrome		\$21.00
	56-396-X-135	Special Order		\$21.00

Sprinkler Wrench

56-850-4-001	Wrench W-Type 7	\$85.00
---------------------	-----------------	---------

Notes

6012	*Special Order paint match subject to set-up charge. (Net Price)	\$376.50
-------------	--	----------

Note: All "Special Order" cover plates are special ordered and are Non-Returnable. Please see "Terms & Conditions"

Technical Data Sheet: TFP265

Items marked "C.O." are made to order and may require longer delivery times. Please contact customer service for availability.

See latest Technical Data Sheets for specific Approvals, Listings, Design Parameters & available finishes. Sprinkler heads & escutcheons are priced separately unless otherwise noted.

EC-8 QR Pendent and Recessed Pendent Sprinklers K=8.0, 3/4" N.P.T. ECLH

100 Box Quantity (24 lbs/box) (SIN TY4232)

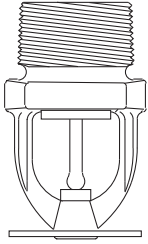
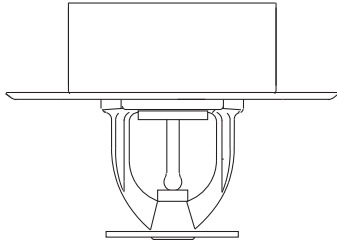
	<i>C.O.</i>	<i>Number</i>	<i>Model</i>	<i>Finish</i>	<i>Temperature</i>	<i>List Price</i>	
	▶	50-801-1-135	EC-8 QR	Brass	135°F (57°C)	\$39.00	
		50-801-1-155	EC-8 QR	Brass	155°F (68°C)	\$39.00	
	▶	50-801-9-135	EC-8 QR	Chrome	135°F (57°C)	\$42.50	
		50-801-9-155	EC-8 QR	Chrome	155°F (68°C)	\$42.50	
	▶	50-801-4-135	EC-8 QR	Signal White (RAL 9003)	135°F (57°C)	\$42.50	
		50-801-4-155	EC-8 QR	Signal White (RAL 9003)	155°F (68°C)	\$42.50	
	Recessed Escutcheons (Order Separately)						
	▶	56-705-2-011	3/4" Brass Recessed (Style 30)				\$9.50
		56-705-9-011	3/4" Chrome Recessed (Style 30)				\$6.85
		56-705-4-011	3/4" Signal White (RAL 9003) Recessed (Style 30)				\$6.85
	56-700-2-010	3/4" Brass Recessed (Style 40)				\$9.50	
	56-700-9-010	3/4" Chrome Recessed (Style 40)				\$6.85	
	56-700-4-010	3/4" Signal White (RAL 9003) Recessed (Style 40)				\$6.85	
	Sprinkler Wrench						
		56-895-1-001	W-Type 3 Wrench				\$70.50
		56-000-6-838	W-Type 23 Wrench (Recessed Only)				\$85.00
	Technical Data Sheet: TFP223						

Section 1
Standard Spray Sprinklers

Section 2
Extended Coverage Sprinklers

Section 3
Storage Sprinklers

Section 4
Residential Products

Section 5
Dry Sprinklers

Section 6
Special Sprinklers

Section 7
Nozzles and Sprinkler Accessories

See latest Technical Data Sheets for specific Approvals, Listings, Design Parameters & available finishes. Sprinkler heads & escutcheons are priced separately unless otherwise noted.

Items marked "C.O." are made to order and may require longer delivery times. Please contact customer service for availability.

EC-5 QR Pendant, Recessed Pendant and Sidewall Sprinklers K=5.6, 1/2" N.P.T.

100 Box Quantity (Pendant 15 lbs/box (SIN TY3232), Sidewall 16 lbs/box (SIN TY3302))

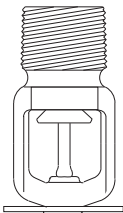
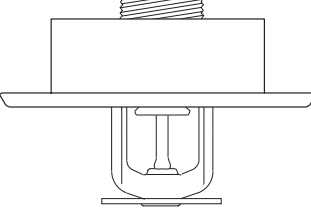
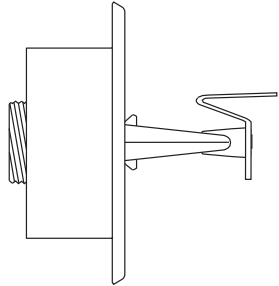
	C.O.	Pendant	Sidewall	Model	Finish	Temperature	List Price	
		51-051-1-135	51-053-1-135	EC-5 1/2"	Brass	135°F (57°C)	\$43.50	
		51-051-1-155	51-053-1-155	EC-5 1/2"	Brass	155°F (68°C)	\$43.50	
		-	51-053-1-200	EC-5 1/2"	Brass	200°F (93°C)	\$43.50	
		51-051-9-135	51-053-9-135	EC-5 1/2"	Chrome	135°F (57°C)	\$47.25	
		51-051-9-155	51-053-9-155	EC-5 1/2"	Chrome	155°F (68°C)	\$47.25	
		-	51-053-9-200	EC-5 1/2"	Chrome	200°F (93°C)	\$47.25	
			51-051-4-135	51-053-4-135	EC-5 1/2"	Signal White (RAL 9003)	135°F (57°C)	\$47.25
			51-051-4-155	51-053-4-155	EC-5 1/2"	Signal White (RAL 9003)	155°F (68°C)	\$47.25
			-	51-053-4-200	EC-5 1/2"	Signal White (RAL 9003)	200°F (93°C)	\$47.25
Recessed Escutcheons (Order Separately)								
	56-711-2-010	1/2" Brass Recessed (Style 50)					\$9.50	
	56-711-9-010	1/2" Chrome Recessed (Style 50)					\$6.55	
	56-711-4-010	1/2" Signal White (RAL 9003) Recessed (Style 50)					\$6.55	
Sprinkler Wrench								
		56-000-6-387	W-Type 6 Wrench				\$51.25	
		56-850-4-001	W-Type 7 Wrench (Recessed Only)				\$85.00	

Technical Data Sheet: Pendant-TFP228, Sidewall-TFP298

Items marked "C.O." are made to order and may require longer delivery times. Please contact customer service for availability.

See latest Technical Data Sheets for specific Approvals, Listings, Design Parameters & available finishes. Sprinkler heads & escutcheons are priced separately unless otherwise noted.

Section 1 Standard Spray Sprinklers
 Section 2 Extended Coverage Sprinklers
 Section 3 Storage Sprinklers
 Section 4 Residential Products
 Section 5 Dry Sprinklers
 Section 6 Special Sprinklers
 Section 7 Nozzles and Sprinkler Accessories

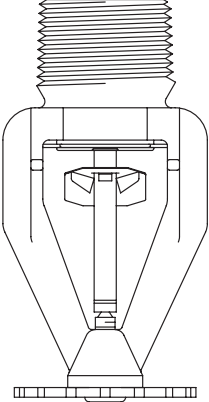
Model ESRF-25™, K=25.2, 1" NPT, Early Suppression, Fast Response Sprinkler						
50 Box Quantity (23 lbs/box) (SIN TY9226)						
	C.O.	Pendent	Description	Temperature	Price	
			58-441-1-165	Brass	165°F (74°C)	\$91.50
			58-441-1-214	Brass	214°F (101°C)	\$91.50
	Sprinkler Wrench					
			56-872-1-025	W-Type 1 Wrench		\$64.75
Technical Data Sheet: TFP312						

Section 1
Standard Spray Sprinklers

Section 2
Extended Coverage Sprinklers

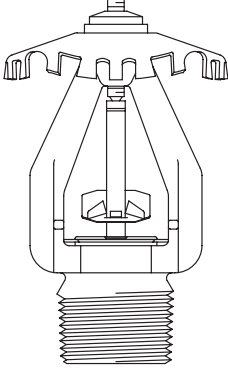
Model EC-25, K=25.2, 1" NPT, Upright, Area/Density, Extended Coverage (SIN TY9128)						
SIN TY9128						
	C.O.	Upright	Description	Temperature	List Price	
			58-450-1-165	Brass	165°F (74°C)	\$94.25
			58-450-1-214	Brass	214°F (101°C)	\$94.25
	Sprinkler Wrench					
			56-872-1-025	W-Type 1 Wrench		\$64.75
Technical Data Sheet: TFP213						

Section 3
Storage Sprinklers

Section 4
Residential Products

Section 5
Dry Sprinklers

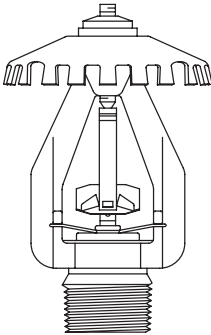
ESFR-17, K=16.8, 3/4" NPT, Early Suppression, Fast Response Upright Sprinkler						
50 Box Quantity (20 lbs/box) (SIN TY7126)						
	C.O.	Upright	Description	Temperature	Price	
			58-447-1-165	Brass	165°F (74°C)	\$83.00
			58-447-1-214	Brass	214°F (101°C)	\$83.00
	Sprinkler Wrench					
			56-001-0-686	W-Type 21 Wrench		\$51.25
Technical Data Sheet: TFP316						

Section 6
Special Sprinklers

Section 7
Nozzles and Sprinkler Accessories

See latest Technical Data Sheets for specific Approvals, Listings, Design Parameters & available finishes. Sprinkler heads & escutcheons are priced separately unless otherwise noted.

Items marked "C.O." are made to order and may require longer delivery times. Please contact customer service for availability.

ESFR-17, K=16.8, 3/4" NPT, Early Suppression, Fast Response Pendent Sprinkler

50 Box Quantity (20 lbs/box) (SIN TY7226)

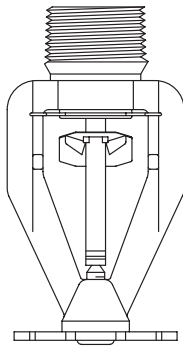

C.O.	Pendent	Description	Temperature	Price
	58-445-1-165	Brass	165°F (74°C)	\$61.75
	58-445-1-214	Brass	214°F (101°C)	\$61.75
Sprinkler Wrench				
	56-001-0-686	W-Type 21 Wrench		\$51.25

Technical Data Sheet: TFP315

ESFR-17, K=16.8, 1-1/4" NPT, Dry-Type Pendent Early Suppression, Fast Response Sprinkler

(SIN TY7229)

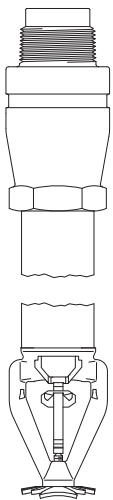

(Note: includes two insulating sealing assemblies)

C.O.	Pendent	Description	Temperature	Price
	61-441-1-360	Brass with Grooved/NPT Threads	165°F (74°C)	\$1,200.00
	61-442-1-360	Brass with Grooved/NPT Threads	214°F (101°C)	\$1,200.00
	I61-441-1-360	Brass with Grooved/ISO Threads	165°F (74°C)	\$1,200.00
	I61-442-1-360	Brass with Grooved/ISO Threads	214°F (101°C)	\$1,200.00
Replacement Parts				
	91-106-1-500	Replacement Insulating Sealing Assembly		\$53.50
Sprinkler Wrench				
	56-341-1-001	W-Type 26 Wrench		\$64.75

Technical Data Sheet: TFP320

Items marked "C.O." are made to order and may require longer delivery times. Please contact customer service for availability.

See latest Technical Data Sheets for specific Approvals, Listings, Design Parameters & available finishes. Sprinkler heads & escutcheons are priced separately unless otherwise noted.

Model ESFR-1, K=14.0, 3/4" NPT, Early Suppression, Fast Response Sprinkler

50 Box Quantity (21 lbs/box) (SIN TY6226)

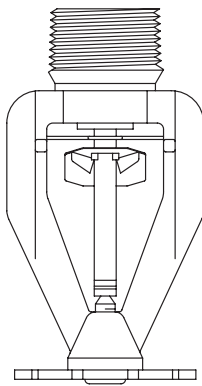

C.O.	Pendent	Description	Temperature	Price
	58-440-1-165	Brass	165°F (74°C)	\$49.00
	58-440-1-214	Brass	214°F (101°C)	\$49.00
Sprinkler Wrench				
	56-872-1-001	W-Type 2 Wrench		\$51.25

Technical Data Sheet: TFP318

Ultra K17, Upright, K=16.8, 3/4" Thread Specific Application

50 Box Quantity (18 lbs/box) (SIN TY7153)

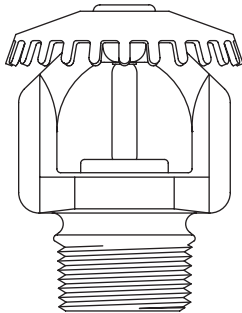

C.O.	Upright	Description	Temperature	Price
	51-887-1-155	Brass	155°F (68°C)	\$78.75
	51-887-1-200	Brass	200°F (93°C)	\$78.75
	51-887-1-286	Brass	286°F (141°C)	POA
Sprinkler Wrench				
	56-892-1-001	W-Type 8 Wrench		\$85.00

Technical Data Sheet: TFP330

Section 1
Standard Spray Sprinklers

Section 2
Extended Coverage Sprinklers

Section 3
Storage Sprinklers

Section 4
Residential Products

Section 5
Dry Sprinklers

Section 6
Special Sprinklers

Section 7
Nozzles and Sprinkler Accessories

See latest Technical Data Sheets for specific Approvals, Listings, Design Parameters & available finishes. Sprinkler heads & escutcheons are priced separately unless otherwise noted.

Items marked "C.O." are made to order and may require longer delivery times. Please contact customer service for availability.

Model K17-231, K=16.8, 3/4" Thread, Upright Sprinkler

50 Box Quantity (18 lbs/box) (SIN TY7151)

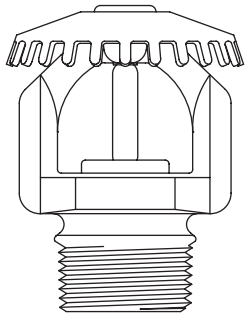

<i>C.O.</i>	<i>Upright</i>	<i>Description</i>	<i>Temperature</i>	<i>Price</i>
	51-888-1-155	Brass	155°F (68°C)	\$45.00
	51-888-1-200	Brass	200°F (93°C)	\$45.00
	51-888-1-286	Brass	286°F (141°C)	\$45.00
Sprinkler Wrench				
	56-892-1-001	W-Type 8 Wrench		\$85.00
Technical Data Sheet: TFP332				

Model K17-231, K=16.8, 3/4" Thread, Pendent Sprinkler

50 Box Quantity (18 lbs/box) (SIN TY7251)

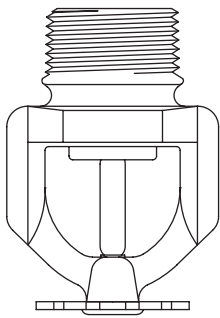

<i>C.O.</i>	<i>Pendent</i>	<i>Description</i>	<i>Temperature</i>	<i>Price</i>
	51-889-1-155	Brass	155°F (68°C)	\$42.00
	51-889-1-200	Brass	200°F (93°C)	\$42.00
	51-889-1-286	Brass	286°F (141°C)	\$42.00
Sprinkler Wrench				
	56-892-1-001	W-Type 8 Wrench		\$85.00
Technical Data Sheet: TFP332				

Section 1
Standard Spray Sprinklers

Section 2
Extended Coverage Sprinklers

Section 3
Storage Sprinklers

Section 4
Residential Products

Section 5
Dry Sprinklers

Section 6
Special Sprinklers

Section 7
Nozzles and Sprinkler Accessories

Items marked "C.O." are made to order and may require longer delivery times. Please contact customer service for availability.

See latest Technical Data Sheets for specific Approvals, Listings, Design Parameters & available finishes. Sprinkler heads & escutcheons are priced separately unless otherwise noted.

**Model ELO-231, Standard Response,
Upright and Pendent Sprinklers K=11.2, 1/2" & 3/4" NPT**

50 Box Quantity (19 lbs/box) - Upright (SIN-TY5111), Pendent (SIN-TY5211), Upright - 1/2" NPT - (SIN-TY5811)

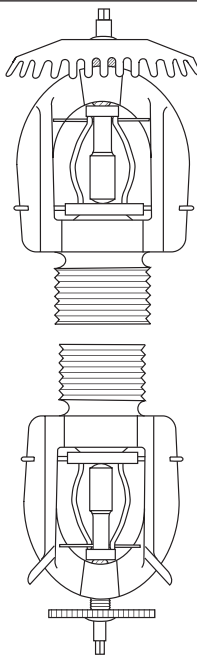
	C.O.	Upright	Pendent	Model	Finish	Temperature	List Price
		50-110-1-165	50-112-1-165	ELO-231 x 3/4	Brass	165°F (74°C)	\$44.50
		50-110-1-212	50-112-1-212	ELO-231 x 3/4	Brass	212°F (100°C)	\$47.75
		50-110-1-286	50-112-1-286	ELO-231 x 3/4	Brass	286°F (141°C)	\$44.50
	▶	50-110-9-165	50-112-9-165	ELO-231 x 3/4	Chrome Plated	165°F (74°C)	\$72.00
	▶	50-110-9-212	50-112-9-212	ELO-231 x 3/4	Chrome Plated	212°F (100°C)	\$72.00
	▶	50-110-9-286	50-112-9-286	ELO-231 x 3/4	Chrome Plated	286°F (141°C)	\$72.00
	▶	50-110-7-165	50-112-7-165	ELO-231 x 3/4	Lead Coated	165°F (74°C)	\$101.00
	▶	50-110-7-212	50-112-7-212	ELO-231 x 3/4	Lead Coated	212°F (100°C)	\$101.00
	▶	50-110-7-286	50-112-7-286	ELO-231 x 3/4	Lead Coated	286°F (141°C)	\$101.00
	▶	50-110-6-165	50-112-6-165	ELO-231 x 3/4	Wax Coated	165°F (74°C)	\$92.75
	▶	50-110-6-212	50-112-6-212	ELO-231 x 3/4	Wax Coated	212°F (100°C)	\$92.75
	▶	50-110-6-286	50-112-6-286	ELO-231 x 3/4	Wax Coated	286°F (141°C)	\$92.75
	▶	50-110-8-165	50-112-8-165	ELO-231 x 3/4	Wax over Lead	165°F (74°C)	\$150.50
	▶	50-110-8-212	50-112-8-212	ELO-231 x 3/4	Wax over Lead	212°F (100°C)	\$150.50
	▶	50-110-8-286	50-112-8-286	ELO-231 x 3/4	Wax over Lead	286°F (141°C)	\$150.50
	▶	50-210-1-165	-	ELO-231 x 1/2	Brass	165°F (74°C)	\$68.00
	▶	50-210-1-212	-	ELO-231 x 1/2	Brass	212°F (100°C)	\$68.00
	▶	50-210-1-286	-	ELO-231 x 1/2	Brass	286°F (141°C)	\$68.00
	▶	50-210-9-165	-	ELO-231 x 1/2	Chrome Plated	165°F (74°C)	\$95.50
	▶	50-210-9-212	-	ELO-231 x 1/2	Chrome Plated	212°F (100°C)	\$95.50
	▶	50-210-9-286	-	ELO-231 x 1/2	Chrome Plated	286°F (141°C)	\$95.50
	▶	50-210-7-165	-	ELO-231 x 1/2	Lead Coated	165°F (74°C)	\$124.50
	▶	50-210-7-212	-	ELO-231 x 1/2	Lead Coated	212°F (100°C)	\$124.50
	▶	50-210-7-286	-	ELO-231 x 1/2	Lead Coated	286°F (141°C)	\$124.50
	▶	50-210-6-165	-	ELO-231 x 1/2	Wax Coated	165°F (74°C)	\$116.00
	▶	50-210-6-212	-	ELO-231 x 1/2	Wax Coated	212°F (100°C)	\$116.00
	▶	50-210-6-286	-	ELO-231 x 1/2	Wax Coated	286°F (141°C)	\$116.00
	▶	50-210-8-165	-	ELO-231 x 1/2	Wax over Lead	165°F (74°C)	\$174.00
▶	50-210-8-212	-	ELO-231 x 1/2	Wax over Lead	212°F (100°C)	\$174.00	
▶	50-210-8-286	-	ELO-231 x 1/2	Wax over Lead	286°F (141°C)	\$174.00	
Sprinkler Wrench							
		56-895-1-001		W-Type 3 Wrench			\$70.50
Technical Data Sheet: TFP340							

Section 1
Standard Spray Sprinklers

Section 2
Extended Coverage Sprinklers

Section 3
Storage Sprinklers

Section 4
Residential Products

Section 5
Dry Sprinklers

Section 6
Special Sprinklers

Section 7
Nozzles and Sprinkler Accessories

See latest Technical Data Sheets for specific Approvals, Listings, Design Parameters & available finishes. Sprinkler heads & escutcheons are priced separately unless otherwise noted.

Items marked "C.O." are made to order and may require longer delivery times. Please contact customer service for availability.

**Model ELO-231B, Standard Response,
Upright and Pendent Sprinklers K=11.2, 1/2" & 3/4" NPT**

50 Box Quantity (19 lbs/box) - Upright (SIN-TY5151), Pendent (SIN-TY5251), Upright - 1/2 NPT - (SIN-TY5851)

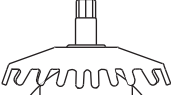
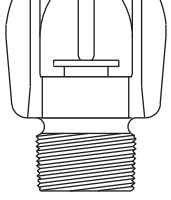
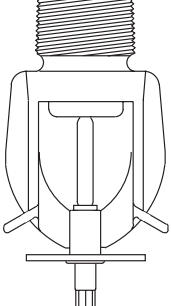
	C.O.	Upright	Pendent	Model	Finish	Temperature	List Price
		50-510-1-155	50-512-1-155	ELO-231B x 3/4	Brass	155°F (68°C)	\$42.75
		50-510-1-200	50-512-1-200	ELO-231B x 3/4	Brass	200°F (93°C)	\$42.75
		50-510-1-286	50-512-1-286	ELO-231B x 3/4	Brass	286°F (141°C)	\$42.75
	▶	50-510-9-155	50-512-9-155	ELO-231B x 3/4	Chrome Plated	155°F (68°C)	\$70.25
	▶	50-510-9-200	50-512-9-200	ELO-231B x 3/4	Chrome Plated	200°F (93°C)	\$70.25
	▶	50-510-9-286	50-512-9-286	ELO-231B x 3/4	Chrome Plated	286°F (141°C)	\$70.25
	▶	50-510-7-155	50-512-7-155	ELO-231B x 3/4	Lead Coated	155°F (68°C)	\$101.00
	▶	50-510-7-200	50-512-7-200	ELO-231B x 3/4	Lead Coated	200°F (93°C)	\$101.00
	▶	50-510-7-286	50-512-7-286	ELO-231B x 3/4	Lead Coated	286°F (141°C)	\$101.00
	▶	50-510-6-155	50-512-6-155	ELO-231B x 3/4	Wax Coated	155°F (68°C)	\$92.75
	▶	50-510-6-200	50-512-6-200	ELO-231B x 3/4	Wax Coated	200°F (93°C)	\$92.75
	▶	50-510-6-286	50-512-6-286	ELO-231B x 3/4	Wax Coated	286°F (141°C)	\$92.75
	▶	50-510-8-155	50-512-8-155	ELO-231B x 3/4	Wax over Lead	155°F (68°C)	\$150.50
	▶	50-510-8-200	50-512-8-200	ELO-231B x 3/4	Wax over Lead	200°F (93°C)	\$150.50
	▶	50-510-8-286	50-512-8-286	ELO-231B x 3/4	Wax over Lead	286°F (141°C)	\$150.50
Section 4 Residential Products	▶	50-501-1-155	-	ELO-231B x 1/2	Brass	155°F (68°C)	\$63.50
	▶	50-501-1-200	-	ELO-231B x 1/2	Brass	200°F (93°C)	\$63.50
	▶	50-501-1-286	-	ELO-231B x 1/2	Brass	286°F (141°C)	\$63.50
	▶	50-501-9-155	-	ELO-231B x 1/2	Chrome Plated	165°F (74°C)	\$91.00
	▶	50-501-9-200	-	ELO-231B x 1/2	Chrome Plated	212°F (100°C)	\$91.00
	▶	50-501-9-286	-	ELO-231B x 1/2	Chrome Plated	286°F (141°C)	\$91.00
	▶	50-501-7-155	-	ELO-231B x 1/2	Lead Coated	155°F (68°C)	\$122.00
	▶	50-501-7-200	-	ELO-231B x 1/2	Lead Coated	200°F (93°C)	\$122.00
	▶	50-501-7-286	-	ELO-231B x 1/2	Lead Coated	286°F (141°C)	\$122.00
Section 5 Dry Sprinklers	▶	50-501-6-155	-	ELO-231B x 1/2	Wax Coated	155°F (68°C)	\$113.50
	▶	50-501-6-200	-	ELO-231B x 1/2	Wax Coated	200°F (93°C)	\$113.50
	▶	50-501-6-286	-	ELO-231B x 1/2	Wax Coated	286°F (141°C)	\$113.50
Section 6 Special Sprinklers	▶	50-501-8-155	-	ELO-231B x 1/2	Wax over Lead	155°F (68°C)	\$171.50
	▶	50-501-8-200	-	ELO-231B x 1/2	Wax over Lead	200°F (93°C)	\$171.50
	▶	50-501-8-286	-	ELO-231B x 1/2	Wax over Lead	286°F (141°C)	\$171.50
Sprinkler Wrench							
		56-895-1-001		W-Type 3 Wrench			\$70.50

Technical Data Sheet: TFP342

Items marked "C.O." are made to order and may require longer delivery times. Please contact customer service for availability.

See latest Technical Data Sheets for specific Approvals, Listings, Design Parameters & available finishes. Sprinkler heads & escutcheons are priced separately unless otherwise noted.

Section 1
Standard Spray Sprinklers

Section 2
Extended Coverage Sprinklers

Section 3
Storage Sprinklers

Section 4
Residential Products

Section 5
Dry Sprinklers

Section 6
Special Sprinklers

Section 7
Nozzles and Sprinkler Accessories

ELO-231 FRB, Quick Response, Upright, Pendent Sprinklers K=11.2, 3/4" N.P.T.

50 Box Quantity (19 lbs/box) (SIN Upright TY5131) (SIN Pendent TY5231)

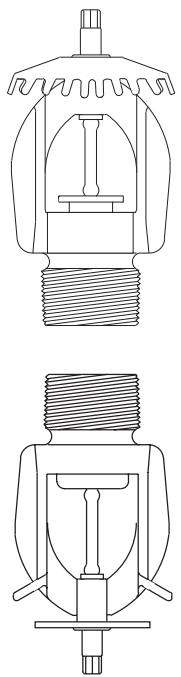
	C.O.	Upright	Pendent	Model	Finis	Temperature	List Price
		50-500-1-155	50-502-1-155	ELO-231FRB	Brass	155°F (68°C)	\$63.50
		50-500-1-200	50-502-1-200	ELO-231FRB	Brass	200°F (93°C)	\$63.50
		50-500-1-286	50-502-1-286	ELO-231FRB	Brass	286°F (141°C)	\$63.50
		50-500-9-155	50-502-9-155	ELO-231FRB	Chrome Plated	155°F (68°C)	\$74.50
		50-500-9-200	50-502-9-200	ELO-231FRB	Chrome Plated	200°F (93°C)	\$74.50
		50-500-9-286	50-502-9-286	ELO-231FRB	Chrome Plated	286°F (141°C)	\$74.50
Sprinkler Wrench							
		56-895-1-001	W-Type 3 Wrench				\$70.50

Technical Data Sheet: TFP344

Section 1
Standard Spray Sprinklers

Section 2
Extended Coverage Sprinklers

Section 3
Storage Sprinklers

Section 4
Residential Products

Section 5
Dry Sprinklers

Section 6
Special Sprinklers

Section 7
Nozzles and Sprinkler Accessories

LD Large Drop Upright Sprinklers K=11.2, 3/4" N.P.T.

50 Box Quantity (19 lbs/box) (SIN TY5153)

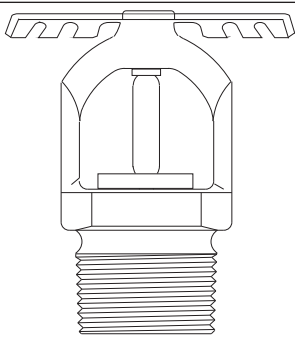
	C.O.	Upright	Model	Finis	Temperature	List Price	
		50-400-2-155	LD Large Drop	Brass	155°F (68°C)	\$67.50	
		50-400-2-200	LD Large Drop	Brass	200°F (93°C)	\$67.50	
		50-400-2-286	LD Large Drop	Brass	286°F (141°C)	\$67.50	
Sprinkler Wrench							
		56-895-1-001	W-Type 3 Wrench				\$70.50

Technical Data Sheet: TFP335

See latest Technical Data Sheets for specific Approvals, Listings, Design Parameters & available finishes. Sprinkler heads & escutcheons are priced separately unless otherwise noted.

Items marked "C.O." are made to order and may require longer delivery times. Please contact customer service for availability.

**TY-B, 5mm Bulb, K=5.6, 1/2" NPT, Standard Response,
Intermediate Level Upright and Pendent Sprinklers w/Shield**

50 Box Quantity (28 lbs/box) (Upright - SIN TY3153), (Pendent - SIN TY3251)

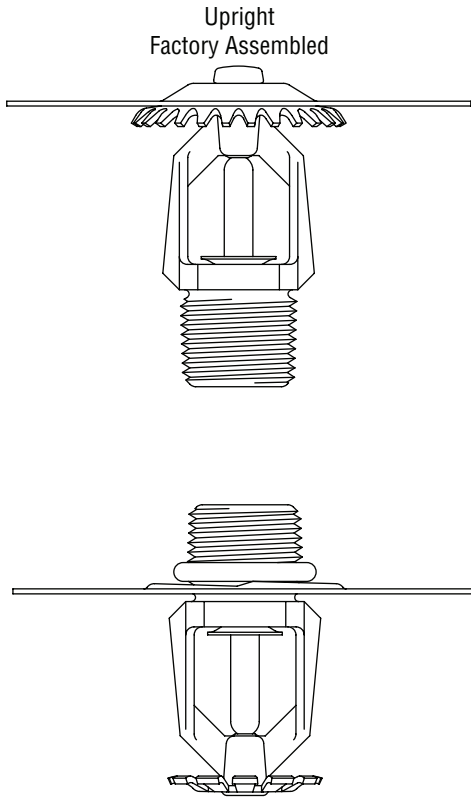

C.O.	Upright w/Shield	Description	Temperature	List Price
▶	57-533-1-135	Brass	135°F (57°C)	\$30.50
	57-533-1-155	Brass	155°F (68°C)	\$30.50
▶	57-533-1-175	Brass	175°F (79°C)	\$30.50
	57-533-1-200	Brass	200°F (93°C)	\$30.50
	57-533-1-286	Brass	286°F (141°C)	\$30.50
▶	57-533-1-360	Brass	360°F (182°C)	\$33.75
▶	57-533-7-135	Lead Coated	135°F (57°C)	\$82.00
▶	57-533-7-155	Lead Coated	155°F (68°C)	\$82.00
▶	57-533-7-175	Lead Coated	175°F (79°C)	\$82.00
▶	57-533-7-200	Lead Coated	200°F (93°C)	\$82.00
▶	57-533-7-286	Lead Coated	286°F (141°C)	\$82.00
▶	57-533-6-155	Wax Coated	155°F (68°C)	\$77.50
▶	57-533-6-175	Wax Coated	175°F (79°C)	\$77.50
▶	57-533-6-200	Wax Coated	200°F (93°C)	\$77.50
▶	57-533-6-286	Wax Coated	286°F (141°C)	\$77.50
Pendent Version				
For pendent TY-B with S2 Shield, order the pendent TY-B sprinkler (57-571-X-XXX) and the S2 deflector shield and O-Ring assembly separately				
	56-070-9-332	1/2" NPT, S2 Pendent Shield and O-Ring Assembly		\$7.90
Sprinkler Wrench				
	56-000-6-387	W-Type 6 Wrench		\$51.25
Technical Data Sheet: TFP351				

*Pendent Shown Field Assembled
(Order 57-571-X-XXX Sprinkler
and Shield Assembly Separately)

Items marked "C.O." are made to order and may require longer delivery times. Please contact customer service for availability.

See latest Technical Data Sheets for specific Approvals, Listings, Design Parameters & available finishes. Sprinkler heads & escutcheons are priced separately unless otherwise noted.

TY-B, 5mm Bulb, K=8.0, 3/4" NPT, Standard Response, Intermediate Level Upright and Pendent Sprinkler w/Shield

50 Box Quantity (30 lbs/box) (Upright - SIN TY4153), (Pendent TY4251)

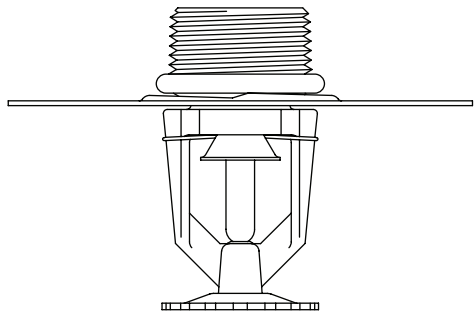
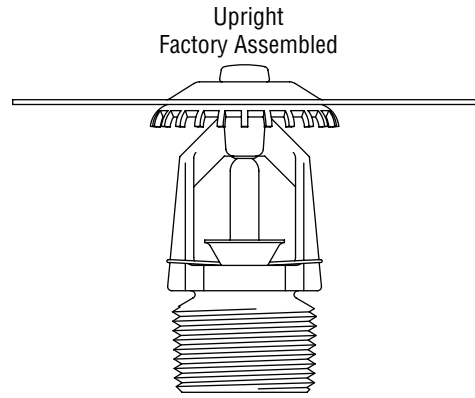

*Pendent Shown Field Assembled
(Order 57-591-X-XXX Sprinkler and Shield Assembly Separately)

C.O.	Upright w/Shield	Finish	Temperature	List Price
▶	57-543-1-135	Brass	135°F (57°C)	\$33.75
	57-543-1-155	Brass	155°F (68°C)	\$33.75
▶	57-543-1-175	Brass	175°F (79°C)	\$33.75
	57-543-1-200	Brass	200°F (93°C)	\$33.75
	57-543-1-286	Brass	286°F (141°C)	\$33.75
▶	57-543-1-360	Brass	360°F (182°C)	\$36.75
▶	57-543-7-135	Lead Coated	135°F (57°C)	\$86.75
▶	57-543-7-155	Lead Coated	155°F (68°C)	\$86.75
▶	57-543-7-175	Lead Coated	175°F (79°C)	\$86.75
▶	57-543-7-200	Lead Coated	200°F (93°C)	\$86.75
▶	57-543-7-286	Lead Coated	286°F (141°C)	\$86.75
▶	57-543-6-155	Wax Coated	155°F (68°C)	\$82.00
▶	57-543-6-175	Wax Coated	175°F (79°C)	\$82.00
▶	57-543-6-200	Wax Coated	200°F (93°C)	\$82.00
▶	57-543-6-286	Wax Coated	286°F (141°C)	\$82.00
Pendent Version				
For pendent TY-B with S2 Shield, order the pendent TY-B sprinkler (57-591-X-XXX) and the S2 deflector shield and O-Ring Assembly separately				
	56-070-9-342	3/4" NPT, S2 Pendent Shield & O-Ring Assembly		\$7.90
Sprinkler Wrench				
	56-000-6-387	W-Type 6 Wrench		\$51.25
Technical Data Sheet: TFP351				

Section 1
Standard Spray Sprinklers

Section 2
Extended Coverage Sprinklers

Section 3
Storage Sprinklers

Section 4
Residential Products

Section 5
Dry Sprinklers

Section 6
Special Sprinklers

Section 7
Nozzles and Sprinkler Accessories

See latest Technical Data Sheets for specific Approvals, Listings, Design Parameters & available finishes. Sprinkler heads & escutcheons are priced separately unless otherwise noted.

Items marked "C.O." are made to order and may require longer delivery times. Please contact customer service for availability.

**TY-FRB, 3mm Bulb, K=5.6, 1/2" NPT, Quick Response,
Intermediate Level Upright and Pendent Sprinklers w/Shield**

50 Box Quantity (28 lbs/box) - (Upright - SIN TY3133), (Pendent - SIN TY3231)

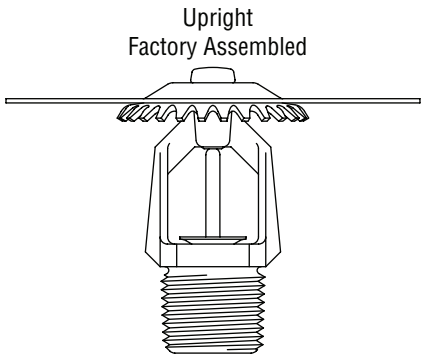
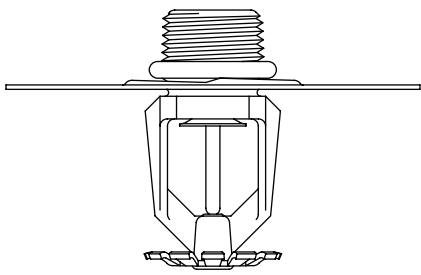
	C.O.	Upright w/Shield	Description	Temperature	Price
 <p>Upright Factory Assembled</p>	▶	57-333-1-135	Brass	135°F (57°C)	\$42.00
		57-333-1-155	Brass	155°F (68°C)	\$42.50
	▶	57-333-1-175	Brass	175°F (79°C)	\$42.50
		57-333-1-200	Brass	200°F (93°C)	\$42.50
		57-333-1-286	Brass	286°F (141°C)	\$42.50
	▶	57-333-7-135	Lead Coated	135°F (57°C)	\$102.00
	▶	57-333-7-155	Lead Coated	155°F (68°C)	\$102.00
	▶	57-333-7-175	Lead Coated	175°F (79°C)	\$102.00
	▶	57-333-7-200	Lead Coated	200°F (93°C)	\$102.00
	▶	57-333-7-286	Lead Coated	286°F (141°C)	\$102.00
 <p>*Pendent Shown Field Assembled (Order 57-371-X-XXX Sprinkler and Shield Assembly Separately)</p>	Pendent Version				
	For pendent TY-FRB with Shield, order the pendent TY-FRB sprinkler (57-371-X-XXX) and the deflector shield and O-Ring Assembly separately				
		56-070-9-332	1/2" NPT, S2 Pendent Shield and O-Ring Assembly		\$7.90
Sprinkler Wrench					
	56-000-6-387	W-Type 6 Wrench			\$51.25
Technical Data Sheet: TFP356					

Items marked "C.O." are made to order and may require longer delivery times. Please contact customer service for availability.

See latest Technical Data Sheets for specific Approvals, Listings, Design Parameters & available finishes. Sprinkler heads & escutcheons are priced separately unless otherwise noted.

**TY-FRB, 3mm Bulb, K=8.0, 3/4" NPT Quick Response,
Intermediate Level Upright and Pendent Sprinklers w/Shield**

50 Box Quantity (30 lbs/box) - (Upright - SIN TY4133), (Pendent - SIN TY4231)

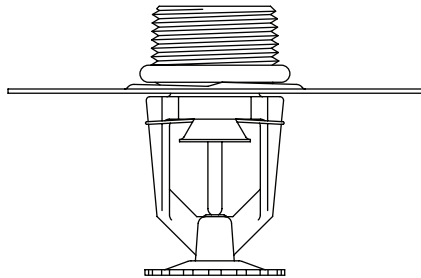
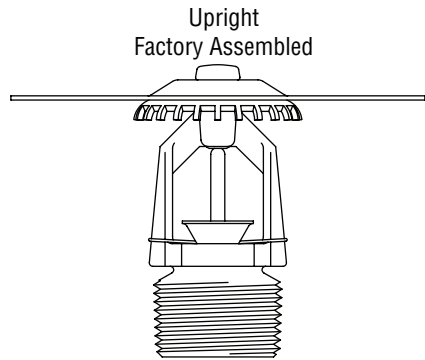

*Pendent Shown Field Assembled
(Order 57-391-X-XXX Sprinkler
and Shield Assembly Separately)

C.O.	Upright w/Shield	Description	Temperature	Price
▶	57-343-1-135	Brass	135°F (57°C)	\$46.50
	57-343-1-155	Brass	155°F (68°C)	\$46.50
▶	57-343-1-175	Brass	175°F (79°C)	\$46.50
	57-343-1-200	Brass	200°F (93°C)	\$46.50
	57-343-1-286	Brass	286°F (141°C)	\$46.50
▶	57-343-7-135	Lead Coated	135°F (57°C)	\$113.50
▶	57-343-7-155	Lead Coated	155°F (68°C)	\$113.50
▶	57-343-7-175	Lead Coated	175°F (79°C)	\$113.50
▶	57-343-7-200	Lead Coated	200°F (93°C)	\$113.50
▶	57-343-7-286	Lead Coated	286°F (141°C)	\$113.50
Pendent Version				
For pendent TY-FRB with Shield, order the pendent TY-FRB sprinkler (57-391-X-XXX) and the deflector shield and O-Ring Assembly separately				
	56-070-9-342	3/4" NPT Pendent Shield & O-Ring Assembly		\$7.90
Sprinkler Wrench				
	56-000-6-387	W-Type 6 Wrench		\$51.25

Technical Data Sheet: TFP356

Section 1
Standard Spray Sprinklers

Section 2
Extended Coverage Sprinklers

Section 3
Storage Sprinklers

Section 4
Residential Products

Section 5
Dry Sprinklers

Section 6
Special Sprinklers

Section 7
Nozzles and Sprinkler Accessories

See latest Technical Data Sheets for specific Approvals, Listings, Design Parameters & available finishes. Sprinkler heads & escutcheons are priced separately unless otherwise noted.

Items marked "C.O." are made to order and may require longer delivery times. Please contact customer service for availability.

**TY-L, K=5.6, 1/2" NPT, Standard Response
Intermediate Level Upright and Pendent Sprinklers w/Shield**

(Upright - SIN TY3113), (Pendent - SIN TY3211)

C.O.	Upright w/Shield	Description	Temperature	Price
	53-253-1-165	Brass	165°F (74°C)	\$34.75
	53-253-1-212	Brass	212°F (100°C)	\$34.75
	53-253-1-280	Brass	280°F (138°C)	\$34.75
Pendent Version				
For pendent TY-L with Shield, order the pendent TY-L sprinkler (53-112-X-XXX) and the deflector shield and O-Ring Assembly separately				
	56-015-6-802	1/2" TY-L Shield Package (Shield/O-Ring)		\$7.90
Sprinkler Wrench				
	56-000-1-849	W-Type 9 Wrench		\$45.75

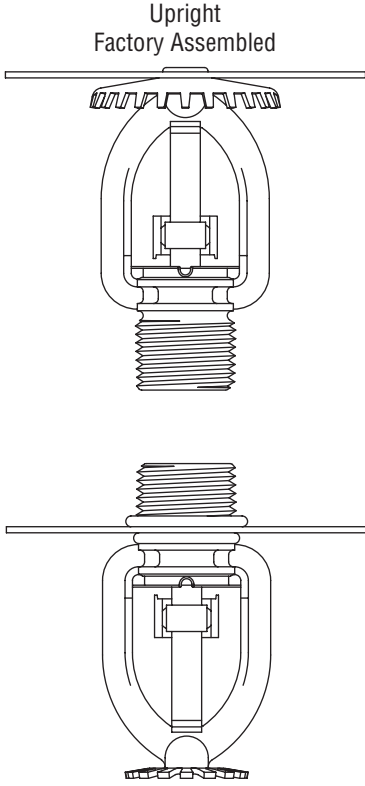

*Pendent Shown Field Assembled
(Order 53-112-X-XXX Sprinkler
and Shield Assembly Separately)

Technical Data Sheet: TFP350

Section 1
Standard Spray Sprinklers

Section 2
Extended Coverage Sprinklers

Section 3
Storage Sprinklers

Section 4
Residential Products

Section 5
Dry Sprinklers

Section 6
Special Sprinklers

Section 7
Nozzles and Sprinkler Accessories

Items marked "C.O." are made to order and may require longer delivery times. Please contact customer service for availability.

See latest Technical Data Sheets for specific Approvals, Listings, Design Parameters & available finishes. Sprinkler heads & escutcheons are priced separately unless otherwise noted.

**TY-L, K=8.0, 3/4" NPT, Standard Response
Intermediate Level Upright and Pendent Sprinklers w/Shield**

(Upright - SIN TY4113), (Pendent - SIN TY4211)

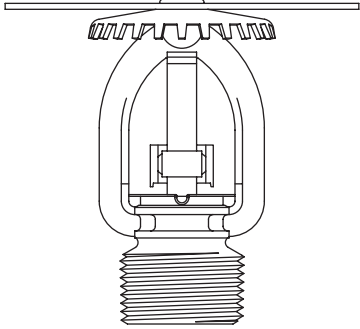
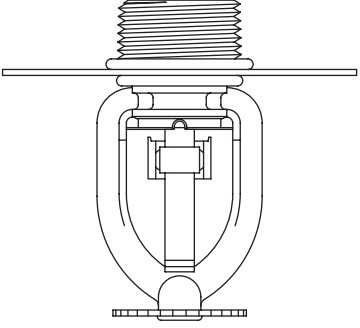
	<i>C.O.</i>	<i>Upright w/Shield</i>	<i>Description</i>	<i>Temperature</i>	<i>Price</i>
<p>Upright Factory Assembled</p> 		53-153-1-165	Brass	165°F (74°C)	\$48.25
	▶	53-153-1-212	Brass	212°F (100°C)	\$48.25
		53-153-1-280	Brass	280°F (138°C)	\$48.25
Pendent Version					
For pendent TY-L with Shield, order the pendent TY-L sprinkler (53-102-X-XXX) and the deflector shield and O-Ring separately					
		56-015-6-803	3/4" TY-L Shield Package (Shield/(2)O-Ring)		\$7.90
Sprinkler Wrench					
		56-000-1-849	W-Type 9 Wrench		\$45.75
 <p>Pendent Field Assembled (order separately) 53-102-X-XXX Sprinkler Shield</p>					

Technical Data Sheet: TFP350

Section 1
Standard Spray Sprinklers

Section 2
Extended Coverage Sprinklers

Section 3
Storage Sprinklers

Section 4
Residential Products

Section 5
Dry Sprinklers

Section 6
Special Sprinklers

Section 7
Nozzles and Sprinkler Accessories

See latest Technical Data Sheets for specific Approvals, Listings, Design Parameters & available finishes. Sprinkler heads & escutcheons are priced separately unless otherwise noted.

Items marked "C.O." are made to order and may require longer delivery times. Please contact customer service for availability.

**TY-FRL, K=5.6, 1/2" Male NPT, Quick Response,
Intermediate Level Upright and Pendent Sprinkler w/Shield**

(Upright - SIN TY3123), (Pendent - SIN TY3221)

Upright
Factory Assembled

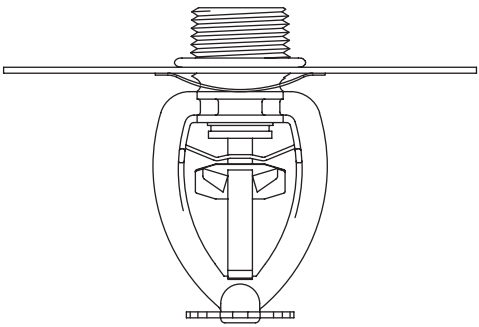
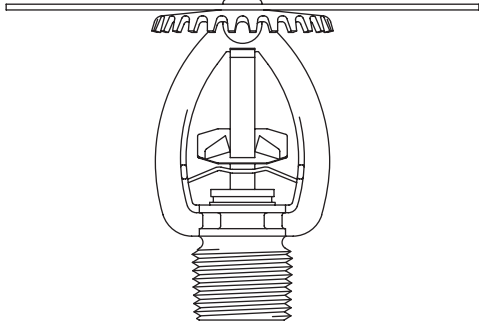

*Pendent Shown Field Assembled
(Order 57-972-X-XXX Sprinkler
and Shield Assembly Separately)

C.O.	Upright w/Shield	Description	Temperature	Price
	58-986-1-165	Brass	165°F (74°C)	\$66.75
▶	58-986-9-165	Chrome	165°F (74°C)	\$73.50

Pendent Version

For pendent TY-FRL with Shield, order the pendent TY-FRL sprinkler (57-982-X-XXX) and the deflector shield and O-Ring Assembly separately

	56-952-1-001	Brass 1/2" NPT, Pendent Shield /O-Ring/Speed Nut assembly		\$7.90
--	---------------------	---	--	--------

Sprinkler Wrench

	56-000-1-849	W-Type 9 Wrench		\$45.75
--	---------------------	-----------------	--	---------

Technical Data Sheet: TFP355

Section 1
Standard Spray Sprinklers

Section 2
Extended Coverage Sprinklers

Section 3
Storage Sprinklers

Section 4
Residential Products

Section 5
Dry Sprinklers

Section 6
Special Sprinklers

Section 7
Nozzles and Sprinkler Accessories

Items marked "C.O." are made to order and may require longer delivery times. Please contact customer service for availability.

See latest Technical Data Sheets for specific Approvals, Listings, Design Parameters & available finishes. Sprinkler heads & escutcheons are priced separately unless otherwise noted.

**TY-FRL, K=8.0, 3/4" NPT, Quick Response,
Intermediate Level Upright and Pendent Sprinkler w/Shield**

(Upright - SIN TY4123), (Pendent - SIN TY4221)

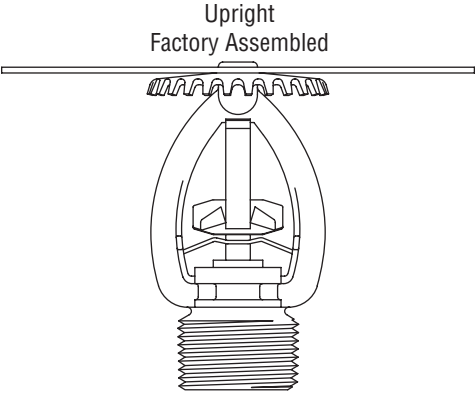
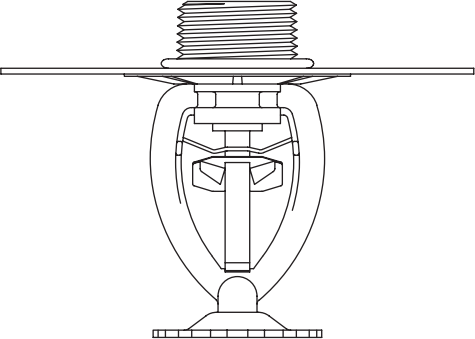
	<i>C.O.</i>	<i>Upright w/Shield</i>	<i>Description</i>	<i>Temperature</i>	<i>Price</i>
 <p>Upright Factory Assembled</p>  <p>*Pendent Shown Field Assembled (Order 58-172-X-XXX Sprinkler and Shield Assembly Separately)</p>		58-153-1-165	Brass	165°F (74°C)	\$77.25
		58-153-9-165	Chrome	165°F (74°C)	\$92.75
	Pendent Version				
	For pendent TY-FRL with Shield , order the pendent TY-FRL sprinkler (58-172-X-XXX) and the deflector shield and O-Ring Assembly separately				
		56-152-1-001	3/4" Shield Assy. Brass/O-Ring/Speed Nut		\$7.90
Sprinkler Wrench					
	56-000-1-849	W-Type 9 Wrench		\$45.75	

Technical Data Sheet: TFP355

Section 1
Standard Spray Sprinklers

Section 2
Extended Coverage Sprinklers

Section 3
Storage Sprinklers

Section 4
Residential Products

Section 5
Dry Sprinklers

Section 6
Special Sprinklers

Section 7
Nozzles and Sprinkler Accessories

See latest Technical Data Sheets for specific Approvals, Listings, Design Parameters & available finishes. Sprinkler heads & escutcheons are priced separately unless otherwise noted.

Items marked "C.O." are made to order and may require longer delivery times. Please contact customer service for availability.

Section 1 Standard Spray Sprinklers
Section 2 Extended Coverage Sprinklers
Section 3 Storage Sprinklers
Section 4 Residential Products
Section 5 Dry Sprinklers
Section 6 Special Sprinklers
Section 7 Nozzles and Sprinkler Accessories

Items marked "C.O." are made to order and may require longer delivery times.
Please contact customer service for availability.

Supersedes 1/20/2012

See latest Technical Data Sheets for specific Approvals, Listings,
Design Parameters & available finishes. Sprinkler heads & escutcheons
are priced separately unless otherwise noted.

LF II - Low Flow Pendant, Fast Response, K=3.0 1/2" N.P.T.

100 Box Quantity (Pendent 20 lbs/box (SIN TY1234))

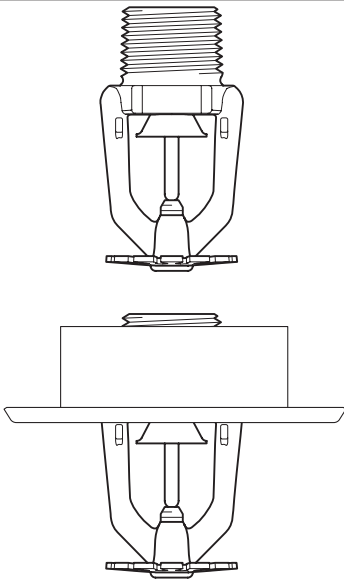
C.O.	Number	Model	Finish	Temperature	List Price	
	51-010-1-155	LFII Pendent	Brass	155°F (68°C)	\$34.50	
	51-010-1-175	LFII Pendent	Brass	175°F (79°C)	\$34.50	
	51-010-9-155	LFII Pendent	Chrome	155°F (68°C)	\$38.25	
	51-010-9-175	LFII Pendent	Chrome	175°F (79°C)	\$38.25	
	51-010-4-155	LFII Pendent	Signal White (RAL 9003)	155°F (68°C)	\$38.25	
	51-010-4-175	LFII Pendent	Signal White (RAL 9003)	175°F (79°C)	\$38.25	
	Recessed Escutcheons (Order Separately)					
	56-705-2-010	1/2" Bright Brass (Style 20)				\$9.50
	56-705-9-010	1/2" Chrome Plated (Style 20)				\$6.55
	56-705-4-010	1/2" Signal White (RAL 9003) (Style 20)				\$6.55
Sprinkler Wrench						
56-000-6-387	W-Type 6 Wrench				\$51.25	
56-850-4-001	W-Type 7 Wrench (Recessed Only)				\$85.00	
Notes:						
92-000-0-412	Plastic Cap Protective Cover.				\$0.30	
Technical Data Sheet: Pendent TFP402, Design Guide: TFP490						

Section 1
Standard Spray Sprinklers

Section 2
Extended Coverage Sprinklers

Section 3
Storage Sprinklers

LF II - Low Flow Horizontal Sidewall, K=4.2(HSW), 1/2" N.P.T.

100 Box Quantity HSW 19 lbs/box (SIN TY1334))

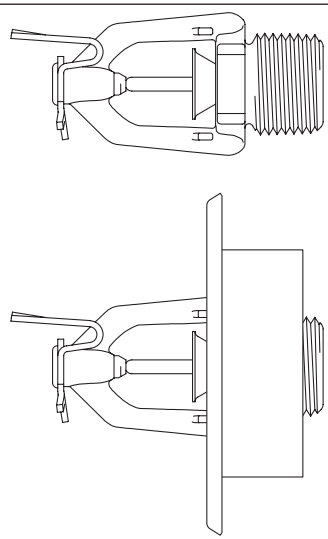
C.O.	Number	Model	Finish	Temperature	List Price	
	51-211-1-155	LFII Sidewall	Brass	155°F (68°C)	\$36.75	
	51-211-1-175	LFII Sidewall	Brass	175°F (79°C)	\$36.75	
	51-211-9-155	LFII Sidewall	Chrome	155°F (68°C)	\$39.00	
	51-211-9-175	LFII Sidewall	Chrome	175°F (79°C)	\$39.00	
	51-211-4-155	LFII Sidewall	Signal White (RAL 9003)	155°F (68°C)	\$39.00	
	51-211-4-175	LFII Sidewall	Signal White (RAL 9003)	175°F (79°C)	\$39.00	
	Recessed Escutcheons (Order Separately)					
	56-705-2-010	1/2" Bright Brass (Style 20)				\$9.50
	56-705-9-010	1/2" Chrome Plated (Style 20)				\$6.55
	56-705-4-010	1/2" Signal White (RAL 9003) (Style 20)				\$6.55
Sprinkler Wrench						
56-000-6-387	W-Type 6 Wrench				\$51.25	
56-850-4-001	W-Type 7 Wrench (Recessed Only)				\$85.00	
Notes:						
92-000-0-412	Plastic Cap Protective Cover.				\$0.30	
Technical Data Sheet: TFP410, Design Guide: TFP490						

Section 4
Residential Products

Section 5
Dry Sprinklers

Section 6
Special Sprinklers

Section 7
Nozzles and Sprinkler Accessories

See latest Technical Data Sheets for specific Approvals, Listings, Design Parameters & available finishes. Sprinkler heads & escutcheons are priced separately unless otherwise noted.

Items marked "C.O." are made to order and may require longer delivery times. Please contact customer service for availability.

LF II - Low Flow Horizontal Sidewall, K=4.4, 1/2" N.P.T.

SIN TY2334

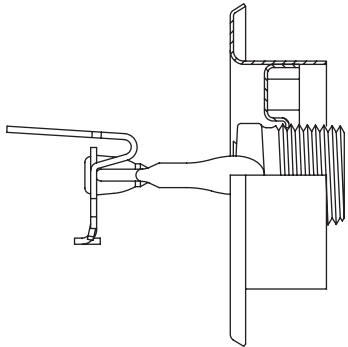
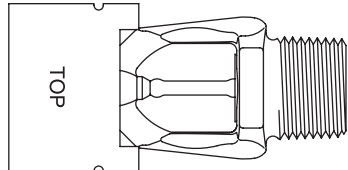

C.O.	Number	Model	Finish	Temperature	List Price
	51-215-1-155	LFII Sidewall	Brass	155°F (68°C)	\$36.75
▶	51-215-1-175	LFII Sidewall	Brass	175°F (79°C)	\$36.75
	51-215-9-155	LFII Sidewall	Chrome	155°F (68°C)	\$39.00
▶	51-215-9-175	LFII Sidewall	Chrome	175°F (79°C)	\$39.00
	51-215-4-155	LFII Sidewall	Signal White (RAL 9003)	155°F (68°C)	\$39.00
▶	51-215-4-175	LFII Sidewall	Signal White (RAL 9003)	175°F (79°C)	\$39.00
Recessed Escutcheons (Order Separately)					
▶	56-705-2-010	1/2" Bright Brass (Style 20)			\$9.50
	56-705-9-010	1/2" Chrome Plated (Style 20)			\$6.55
	56-705-4-010	1/2" Signal White (RAL 9003) (Style 20)			\$6.55
Sprinkler Wrench					
	56-000-6-387	W-Type 6 Wrench			\$51.25
	56-850-4-001	W-Type 7 Wrench (Recessed Only)			\$85.00
Notes:					
	92-000-0-412	Plastic Cap Protective Cover.			\$0.30

Technical Data Sheet: TFP412, Design Guide: TFP490

LF II - Low Flow Pendant, K=4.9 (pendent), 1/2" N.P.T.

100 Box Quantity (Pendent 20 lbs/box (SIN TY2234))

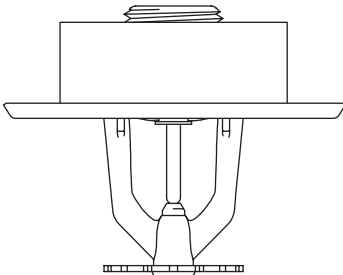

C.O.	Number	Model	Finish	Temperature	List Price
	51-201-1-155	LFII Pendent	Brass	155°F (68°C)	\$34.50
▶	51-201-1-175	LFII Pendent	Brass	175°F (79°C)	\$34.50
	51-201-9-155	LFII Pendent	Chrome	155°F (68°C)	\$38.25
▶	51-201-9-175	LFII Pendent	Chrome	175°F (79°C)	\$38.25
	51-201-4-155	LFII Pendent	Signal White (RAL 9003)	155°F (68°C)	\$38.25
▶	51-201-4-175	LFII Pendent	Signal White (RAL 9003)	175°F (79°C)	\$38.25
Recessed Escutcheons (Order Separately)					
▶	56-705-2-010	1/2" Bright Brass (Style 20)			\$9.50
	56-705-9-010	1/2" Chrome Plated (Style 20)			\$6.55
	56-705-4-010	1/2" Signal White (RAL 9003) (Style 20)			\$6.55
Sprinkler Wrench					
	56-000-6-387	W-Type 6 Wrench			\$51.25
	56-850-4-001	W-Type 7 Wrench (Recessed Only)			\$85.00
Notes:					
	92-000-0-412	Plastic Cap Protective Cover.			\$0.30

**Technical Data Sheet: Pendent TFP400,
HSW TFP410, Design Guide: TFP490**

Items marked "C.O." are made to order and may require longer delivery times. Please contact customer service for availability.

See latest Technical Data Sheets for specific Approvals, Listings, Design Parameters & available finishes. Sprinkler heads & escutcheons are priced separately unless otherwise noted.

LFII - Residential Concealed Pendent Sprinkler, Domed Plate, K=4.9, 1/2" N.P.T.

(SIN TY2234)

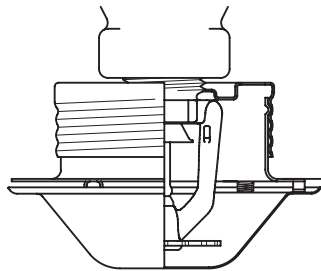

Note: All "Special Order" cover plates are special ordered and are Non-Returnable. Please see "Terms & Conditions"

C.O.	Number	Model	Finish	Temperature	List Price
	51-873-1-155	LFII Pendent Sprinkler	Brass	155°F (68°C)	\$49.75
Cover Plates (Order Separately)					
	56-873-9-135	LFII Cover Plate	Chrome	135°F (57°C)	\$25.00
	56-873-4-135	LFII Cover Plate	Signal White (RAL 9003)	135°F (57°C)	\$25.00
	56-873-X-135	LFII Cover Plate	Special Order*	135°F (57°C)	\$27.50
Sprinkler Wrench					
	56-850-4-001	W-Type 7 Wrench			\$85.00
Notes					
	6012	*Special Order paint match subject to set-up charge. (Net Price)			\$376.50
Technical Data Sheet: TFP450 Design Guide: TFP490					

Section 1
Standard Spray Sprinklers

Section 2
Extended Coverage Sprinklers

LFII - Residential Flat-Plate Concealed Pendent Sprinkler, K=4.9, 1/2" N.P.T.

(SIN TY3596)

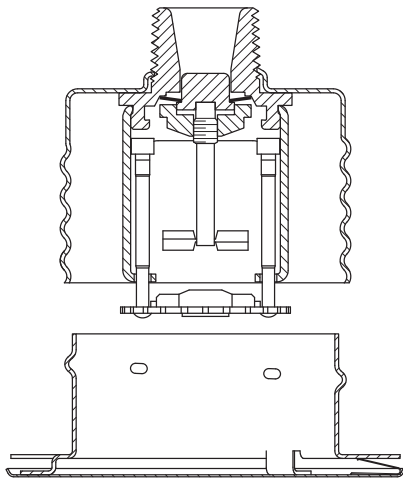

Note: All "Special Order" cover plates are special ordered and are Non-Returnable. Please see "Terms & Conditions"

C.O.	Number	Model	Finish	Temperature	List Price
	51-112-1-160	LFII Pendent Sprinkler	Brass	160°F (71°C)	\$55.00
Cover Plates (Order Separately)					
	56-202-0-135	LFII Cover Plate	Light Ivory (RAL 1015)	135°F (57°C)	\$23.00
	56-202-2-135	LFII Cover Plate	Beige (RAL 1001)	135°F (57°C)	\$23.00
	56-202-4-135	LFII Cover Plate	Signal White (RAL 9003)	135°F (57°C)	\$23.00
	56-202-5-135	LFII Cover Plate	Grey White (RAL 9002)	135°F (57°C)	\$23.00
	56-202-6-135	LFII Cover Plate	Terra Brown (RAL 8028)	135°F (57°C)	\$23.00
	56-202-7-135	LFII Cover Plate	Jet Black (RAL 9005)	135°F (57°C)	\$23.00
	56-202-8-135	LFII Cover Plate	Brushed Brass	135°F (57°C)	\$52.00
	56-202-9-135	LFII Cover Plate	Brushed Chrome	135°F (57°C)	\$38.00
	56-202-X-135	LFII Cover Plate	Custom Paint*	135°F (57°C)	\$23.00
Sprinkler Wrench					
	56-000-1-265	W-Type 18 Wrench			\$85.00
Notes					
	6012	*Special Order paint match subject to set-up charge. (Net Price).			\$376.50
Technical Data Sheet: TFP442 Design Guide: TFP490					

Section 3
Storage Sprinklers

Section 4
Residential Products

Section 5
Dry Sprinklers

Section 6
Special Sprinklers

Section 7
Nozzles and Sprinkler Accessories

See latest Technical Data Sheets for specific Approvals, Listings, Design Parameters & available finishes. Sprinkler heads & escutcheons are priced separately unless otherwise noted.

Items marked "C.O." are made to order and may require longer delivery times. Please contact customer service for availability.

Section 1
Standard Spray Sprinklers

Section 2
Extended Coverage Sprinklers

Section 3
Storage Sprinklers

Section 4
Residential Products

Section 5
Dry Sprinklers

Section 6
Special Sprinklers

Section 7
Nozzles and Sprinkler Accessories

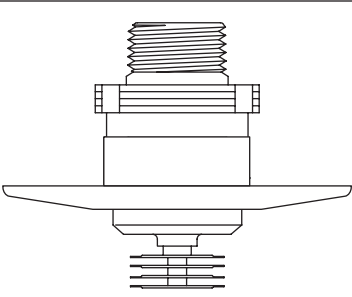
Model LFII, K=4.2, Residential Flush Pendent					
(SIN TY2284)					
	<i>C.O.</i>	<i>Pendent</i>	<i>Finish</i>	<i>Temperature</i>	<i>List Price</i>
		51-123-0-162	Chrome	162°F (72°C)	\$71.50
		51-123-4-162	Signal White (RAL 9003)	162°F (72°C)	\$71.50
		51-123-6-162	Jet Black (RAL 9005)	162°F (72°C)	\$85.00
		51-123-1-162	Antique Brass	162°F (72°C)	\$85.00
Trim Plates (Order Separately)					
		56-123-9-001	Chrome Escutcheon		\$7.60
		56-123-4-001	Signal White (RAL 9003) Escutcheon		\$7.60
		56-123-6-001	Jet Black (RAL 9005) Escutcheon		\$7.60
		56-123-1-001	Antique Brass Escutcheon		\$7.60
Sprinkler Wrench					
		56-000-4-947	Wrench (Socket Only)		\$90.75
		56-000-4-948	Socket/Ratchet Wrench		\$135.00
		56-000-4-300	Protective Cover Removal Tool		\$30.00
Technical Data Sheet: TFP420 Design Guide: TFP490					

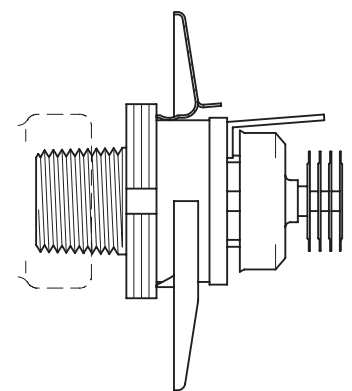
Model LFII, K=4.2, Residential Flush Horizontal Sidewall Sprinkler					
(SIN TY2384)					
	<i>C.O.</i>	<i>Horizontal Sidewall</i>	<i>Finish</i>	<i>Temperature</i>	<i>List Price</i>
		51-124-9-162	Chrome	162°F (72°C)	\$71.50
		51-124-4-162	Signal White (RAL 9003)	162°F (72°C)	\$71.50
		51-124-5-162	Jet Black (RAL 9005)	162°F (72°C)	\$85.00
	Trim Plates (Order Separately)				
		56-124-9-001	Chrome Escutcheon		\$7.45
		56-124-4-001	Signal White (RAL 9003) Escutcheon		\$7.45
		56-124-5-001	Jet Black (RAL 9005) Escutcheon		\$7.45
Sprinkler Wrench					
		56-000-4-949	Wrench (Socket Only)		\$90.75
		56-000-4-950	Socket/Ratchet Wrench		\$135.00
		56-000-4-300	Protective Cover Removal Tool		\$30.00
Technical Data Sheet: TFP425 Design Guide: TFP490					

Items marked "C.O." are made to order and may require longer delivery times. Please contact customer service for availability.

See latest Technical Data Sheets for specific Approvals, Listings, Design Parameters & available finishes. Sprinkler heads & escutcheons are priced separately unless otherwise noted.

**Model LFII, K=5.8 & K=5.6, Residential,
NFPA 13 Optimized Horizontal Sidewall Sprinklers**

(K=5.8 SIN TY4334)(K=5.6 SIN TY3334)

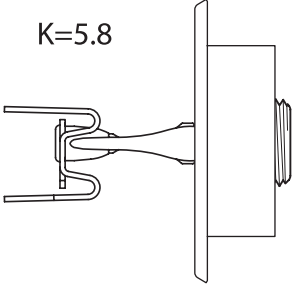
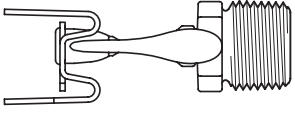
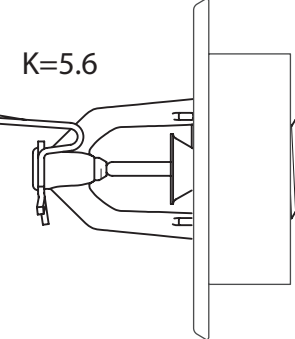
	C.O.	Part Numbers	K Factor	Finish	Temperature	List Price
 <p>K=5.8</p>		51-534-1-155	K=5.8	Brass	155°F (68°C)	\$45.00
		51-534-1-175	K=5.8	Brass	175°F (79°C)	\$45.00
		51-534-9-155	K=5.8	Chrome	155°F (68°C)	\$45.00
		51-534-9-175	K=5.8	Chrome	175°F (79°C)	\$45.00
		51-534-4-155	K=5.8	Signal White (RAL 9003)	155°F (68°C)	\$45.00
		51-534-4-175	K=5.8	Signal White (RAL 9003)	175°F (79°C)	\$45.00
		51-524-1-155	K=5.6	Brass	155°F (68°C)	\$41.50
		51-524-1-175	K=5.6	Brass	175°F (79°C)	\$41.50
		51-524-9-155	K=5.6	Chrome	155°F (68°C)	\$41.50
		51-524-9-175	K=5.6	Chrome	175°F (79°C)	\$41.50
		51-524-4-155	K=5.6	Signal White (RAL 9003)	155°F (68°C)	\$41.50
		51-524-4-175	K=5.6	Signal White (RAL 9003)	175°F (79°C)	\$41.50
Recessed Escutcheons (Order Separately)						
 <p>K=5.6</p>		56-705-2-010	1/2" Brass Plated (Style 20)			\$9.50
		56-705-9-010	1/2" Chrome Plated (Style 20)			\$6.55
		56-705-4-010	1/2" Signal White (RAL 9003) (Style 20)			\$6.55
Sprinkler Wrench						
		56-000-6-387	W-Type 6 Sprinkler Wrench			\$51.25
		56-850-4-001	W-Type 7 Sprinkler Wrench			\$85.00
<p>Technical Data Sheet: K=5.8 - TFP417, K=5.6 - TFP415 Design Guide: TFP490</p>						

Section 1
Standard Spray Sprinklers

Section 2
Extended Coverage Sprinklers

Section 3
Storage Sprinklers

Section 4
Residential Products

Section 5
Dry Sprinklers

Section 6
Special Sprinklers

Section 7
Nozzles and Sprinkler Accessories

See latest Technical Data Sheets for specific Approvals, Listings, Design Parameters & available finishes. Sprinkler heads & escutcheons are priced separately unless otherwise noted.

Items marked "C.O." are made to order and may require longer delivery times. Please contact customer service for availability.

**LFII - Residential NFPA 13 Optimized Pendant,
Recessed and Concealed Sprinklers, K=6.9, 3/4" N.P.T.**

100 Box Quantity (SIN TY4234)

C.O.	Number	Model	Finish	Temperature	List Price
	51-069-1-155	LFII Pendant Sprinkler	Brass	155°F (68°C)	\$43.75
	51-069-1-175	LFII Pendant Sprinkler	Brass	175°F (79°C)	\$43.75
	51-069-9-155	LFII Pendant Sprinkler	Chrome	155°F (68°C)	\$46.50
	51-069-9-175	LFII Pendant Sprinkler	Chrome	175°F (79°C)	\$46.50
	51-069-4-155	LFII Pendant Sprinkler	Signal White (RAL 9003)	155°F (68°C)	\$46.50
	51-069-4-175	LFII Pendant Sprinkler	Signal White (RAL 9003)	175°F (79°C)	\$46.50
	51-068-1-155	LFII Concealed Pendant Sprinkler		155°F (68°C)	\$51.50
	51-068-1-175	LFII Concealed Pendant Sprinkler		175°F (79°C)	\$51.50
Cover Plates (Order Separately)					
	56-873-9-135	LFII Cover Plate	Chrome	135°F (57°C)	\$25.00
	56-873-0-135	LFII Cover Plate	Grey White (RAL9002)	135°F (57°C)	\$25.00
	56-873-4-135	LFII Cover Plate	Signal White (RAL 9003)	135°F (57°C)	\$25.00
	56-873-X-135	LFII Cover Plate	Special Order*	135°F (57°C)	\$27.50
Recessed Escutcheons (Order Separately)					
	56-705-2-011	3/4" Bright Brass (Style 30)			\$9.50
	56-705-9-011	3/4" Chrome Plated (Style 30)			\$6.85
	56-705-4-011	3/4" Signal White (RAL 9003) Recessed (Style 30)			\$6.85
Sprinkler Wrench					
	56-000-6-387	W-Type 6 Wrench			\$51.25
	56-850-4-001	W-Type 7 Wrench (Recessed & Concealed Only)			\$85.00
Notes					
	6012	*Special Order paint match subject to set-up charge. (Net Price)			\$376.50

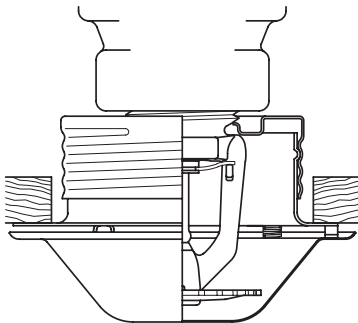
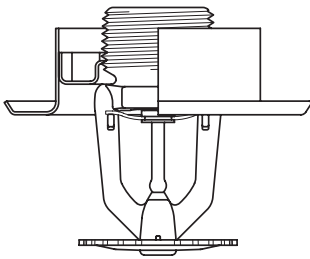
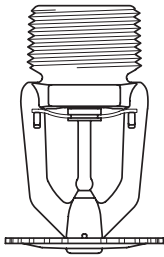

**Note: All "Special Order" cover plates
are special ordered and are Non-
Returnable.
Please see "Terms & Conditions"**

Technical Data Sheet: TFP408

Items marked "C.O." are made to order and may require longer delivery times. Please contact customer service for availability.

See latest Technical Data Sheets for specific Approvals, Listings, Design Parameters & available finishes. Sprinkler heads & escutcheons are priced separately unless otherwise noted.

**Series LFII, Dry-Type, Residential
Recessed Pendent, K=4.9, and
Horizontal Sidewall and Recessed Horizontal Sidewall, K=4.4**

P/N 63 - XX1 - X - XXX

	MODEL/SIN	TEMP. RATING	SPRINKLER FINISH	RECESSED ESCUTCHEON FINISH	ORDER LENGTH (EXAMPLES)
10	Pendent w/ Recessed Escutcheon TY2235	1 155°F (68°C)	9 Chrome Plated	Chrome	055 5.50"
12	Horizontal Sidewall with Recessed Escutcheon TY2335		4 White Polyester Coated	White	082 8.25"
13	Horizontal Sidewall without Escutcheon TY2335		2 Natural Brass	Brass Plated	180 18.00"
					187 18.75"
					240 24.00"

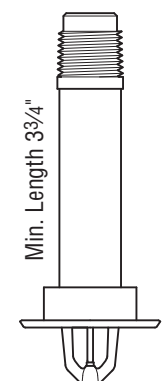
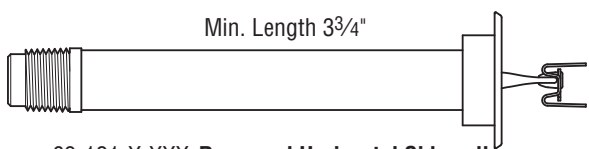
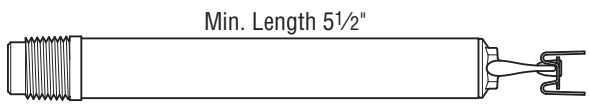
	Length (24" Max)	Pendent & HSW
 <p>63-101-X-XXX w/Std. Escutcheon</p>	3-3/4" to 6"	\$185.00
	6-1/4" to 8"	\$195.00
	8-1/4" to 12"	\$210.00
	12-1/4" to 15"	\$219.00
	15-1/4" to 18"	\$230.50
	18-1/4" to 21"	\$240.50
	21-1/4" to 24"	\$250.00
Replacement Escutcheons		
56-705-2-010	1/2" Brass Plated (Style 20)	\$9.50
56-705-9-010	1/2" Chrome Plated (Style 20)	\$6.55
56-705-4-010	1/2" Signal White (RAL 9003) (Style 20)	\$6.55
Sprinkler Wrench (Standard Pipe Wrench for Pipe Barrel)		
56-000-6-387	W-Type 6 Wrench	\$51.25
56-850-4-001	W-Type 7 Wrench (Recessed)	\$85.00
 <p>63-121-X-XXX Recessed Horizontal Sidewall w/Std. Escutcheon (1" NPT)</p>		
 <p>63-131-X-XXX Horizontal Sidewall (1" NPT)</p>		
Technical Data Sheets: Pendent - TFP460, HSW - TFP461		

Note: All Dry Sprinklers are special ordered and are Non-Returnable. Please see "Terms & Conditions".

See latest Technical Data Sheets for specific Approvals, Listings, Design Parameters & available finishes. Sprinkler heads & escutcheons are priced separately unless otherwise noted.

Items marked "C.O." are made to order and may require longer delivery times. Please contact customer service for availability.

Section 1
Standard Spray Sprinklers

Section 2
Extended Coverage Sprinklers

Section 3
Storage Sprinklers

Section 4
Residential Products

Section 5
Dry Sprinklers

Section 6
Special Sprinklers

Section 7
Nozzles and Sprinkler Accessories

**RAPID RESPONSE
Model RCP-1 Residential Control Panel 1" & 1½", 175 psi**

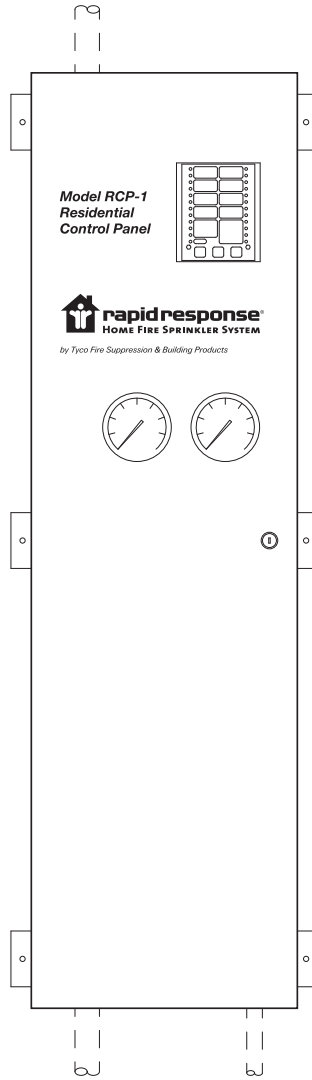

Model RCP-1 Panel

<i>Description</i>	<i>Part No.</i>	<i>List Price</i>
Model RCP-1 Residential Control Panel - 1"	52-310-2-601	POA
Model RCP-1 Residential Control Panel - 1½"	52-310-2-602	POA
Separately Ordered Parts for Model RCP-1 Panel		
Bezel for use with Model RCP-1 Residential Control Panel	52-310-2-603	POA
Replacement Battery (BT-80 8.0 AH Battery)	2656	\$79.50

Technical Data Sheet: TFP480

Section 1
Standard Spray Sprinklers

Section 2
Extended Coverage Sprinklers

Section 3
Storage Sprinklers

Section 4
Residential Products

Section 5
Dry Sprinklers

Section 6
Special Sprinklers

Section 7
Nozzles and Sprinkler Accessories

Items marked "C.O." are made to order and may require longer delivery times. Please contact customer service for availability.

See latest Technical Data Sheets for specific Approvals, Listings, Design Parameters & available finishes. Sprinkler heads & escutcheons are priced separately unless otherwise noted.

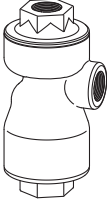
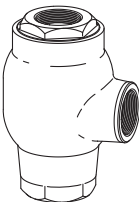
Residential Shutoff Valves			
	Description	Part No.	List Price
 <p>1" RSV-1</p>  <p>2" RSV-1</p>	1" Model RSV-1	52-540-1-001	\$1,098.00
	2" Model RSV-1	52-540-1-002	\$1,733.00
Technical Data Sheet - TFP980			

Section 1	Standard Spray Sprinklers
Section 2	Extended Coverage Sprinklers
Section 3	Storage Sprinklers
Section 4	Residential Products
Section 5	Dry Sprinklers
Section 6	Special Sprinklers
Section 7	Nozzles and Sprinkler Accessories

See latest Technical Data Sheets for specific Approvals, Listings, Design Parameters & available finishes. Sprinkler heads & escutcheons are priced separately unless otherwise noted.

Items marked "C.O." are made to order and may require longer delivery times. Please contact customer service for availability.

Section 1 Standard Spray Sprinklers
Section 2 Extended Coverage Sprinklers
Section 3 Storage Sprinklers
Section 4 Residential Products
Section 5 Dry Sprinklers
Section 6 Special Sprinklers
Section 7 Nozzles and Sprinkler Accessories

Items marked "C.O." are made to order and may require longer delivery times.
Please contact customer service for availability.

Supersedes 1/20/2012

See latest Technical Data Sheets for specific Approvals, Listings,
Design Parameters & available finishes. Sprinkler heads & escutcheons
are priced separately unless otherwise noted.

Series DS-1, Dry, Standard Coverage, Pendent, Upright & Horizontal Sidewall, SR, K=5.6, 5mm Bulb

P/N 60 - XXX - X - XXX

96	Pendent w/Std. Escutcheon (1" NPT)
93	Pendent w/Deep Escutcheon (1" NPT)
97	Pendent w/Std. Recessed Escutcheon (1" NPT)
92	Pendent w/o Escutcheon (1" NPT)
94	Sidewall w/Std. Escutcheon (1" NPT)
53	Sidewall w/Deep Escutcheon (1" NPT)
54	Sidewall w/o Escutcheon (1" NPT)
98	Upright w/o Escutcheon (1" NPT)

C.O. Temperature	
0	135°F (57°C)
1	155°F (68°C)
2	175°F (79°C)
3	200°F (93°C)
4	286°F (141°C)
5	360°F (182°C)

Finish	
Sprinkler	Escutcheon
2	Brass
1	Brass
4	White*
0	Chrome
9	Chrome

Length (for example)	
060	6.00"
062	6.25"
065	6.50"
067	6.75"
372	37.25"
480	48.00"

* Signal White (RAL 9003)

DS-1 Standard Coverage - Standard Response
SIN (Upright TY3155), (Pendent TY3255), (HSW TY3355)

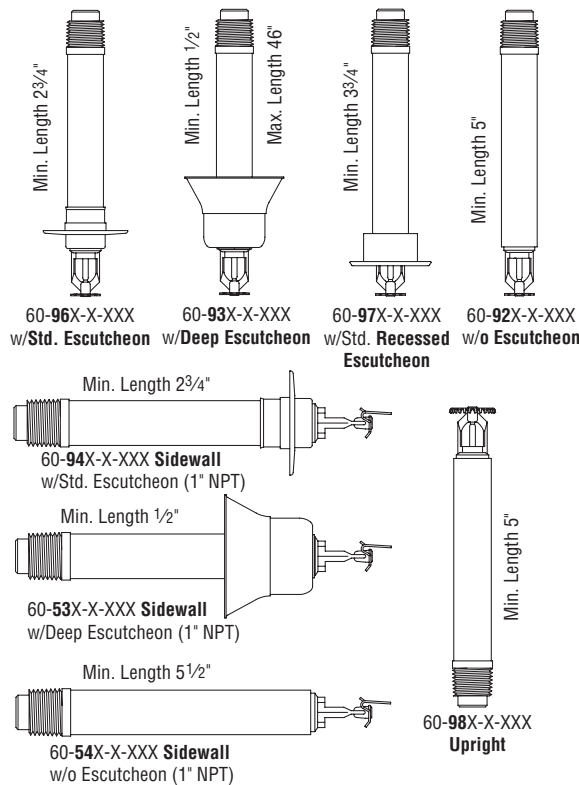

Length (48" Max)	60-98X-X-XXX Upright	60-96X-X-XXX 60-93X-X-XXX 60-97X-X-XXX 60-92X-X-XXX Pendent	60-53X-X-XXX 60-94X-X-XXX 60-54X-X-XXX Sidewall
1/2" to 5-3/4"	\$156.00	\$156.00	\$166.00
6"	\$149.00	\$149.00	\$156.00
6-1/4" to 7-3/4"	\$166.00	\$166.00	\$175.00
8"	\$158.50	\$158.50	\$166.00
8-1/4" to 11-3/4"	\$175.00	\$175.00	\$186.50
12"	\$167.50	\$167.50	\$175.00
12-1/4" to 15"	\$194.50	\$194.50	\$206.00
15-1/4" to 18"	\$206.00	\$206.00	\$215.50
18-1/4" to 21"	\$215.50	\$215.50	\$226.00
21 1/4" to 24"	\$226.00	\$226.00	\$235.50
24"-1/4" to 27"	\$237.50	\$237.50	\$244.00
27-1/4" to 30"	\$247.50	\$247.50	\$254.50
30-1/4" to 33"	\$255.00	\$255.00	\$266.00
33-1/4" to 36"	\$267.00	\$267.00	\$275.00
36-1/4" to 39"	\$276.00	\$276.00	\$285.50
39-1/4" to 42"	\$285.50	\$285.50	\$294.50
42-1/4" to 45"	\$294.50	\$294.50	\$303.50
45-1/4" to 48"	\$303.50	\$303.50	\$314.00

Replacement Escutcheons

56-701-2-010	1/2" Brass Plated (Style 10)	\$9.50
56-701-9-010	1/2" Chrome Plated (Style 10)	\$6.55
56-701-4-010	1/2" Signal White (RAL 9003) (Style 10)	\$6.55
91-106-2-007	Brass Plated (Push On)	\$6.65
91-106-9-007	Chrome Plated (Push On)	\$6.55
91-106-0-007	White Color (Push On)	\$6.55

Dry Sprinkler Rubber Boot Kit

63-000-0-002	DSB-2 Dry Sprinkler Boot Kit Includes: 1-EPDM Rubber Boot, 2-Nylon Ties, 1-1/3 oz tube of adhesive	\$45.75
--------------	--	---------

Sprinkler Wrench (Standard Pipe Wrench for pipe barrel)

56-850-4-001	W-Type 7 Wrench (Recessed Only)	\$85.00
--------------	---------------------------------	---------

Technical Data Sheet: TFP500, Sprinkler Boot-TFP591

Note: All sprinklers are special ordered and are Non-Returnable. Please see "Terms & Conditions"

See latest Technical Data Sheets for specific Approvals, Listings, Design Parameters & available finishes. Sprinkler heads & escutcheons are priced separately unless otherwise noted.

Items marked "C.O." are made to order and may require longer delivery times. Please contact customer service for availability.

Section 1
Standard Spray Sprinklers

Section 2
Extended Coverage Sprinklers

Section 3
Storage Sprinklers

Section 4
Residential Products

Section 5
Dry Sprinklers

Section 6
Special Sprinklers

Section 7
Nozzles and Sprinkler Accessories

Series DS-1, Dry, Standard Coverage, 3/4" NPT
Pendent, Upright & Horizontal Sidewall, QR, K=5.6, 3mm Bulb

P/N 60 - XXX - X - XXX

01	Pendent w/Std. Escutcheon (3/4" NPT)
02	Pendent w/Deep Escutcheon (3/4" NPT)
03	Pendent w/Std. Recessed Escutcheon (3/4" NPT)
04	Pendent w/o Escutcheon (3/4" NPT)
05	Sidewall w/Std. Escutcheon (3/4" NPT)
06	Sidewall w/Deep Escutcheon (3/4" NPT)
07	Sidewall w/o Escutcheon (3/4" NPT)

C.O.	Temperature
0	135°F (57°C)
1	155°F (68°C)
2	175°F (79°C)
3	200°F (93°C)
4	286°F (141°C)

Finish	
Sprinkler	Escutcheon
2	Brass
1	Brass
4	White*
0	White*
9	White*
0	Chrome
9	Chrome

Length (for example)	
060	6.00"
062	6.25"
065	6.50"
067	6.75"
372	37.25"
480	48.00"

* Signal White (RAL 9003)

3/4" NPT SIN (Pendent TY3935), (HSW TY3735)

Length
(48" Max)

Pendent

Sidewall

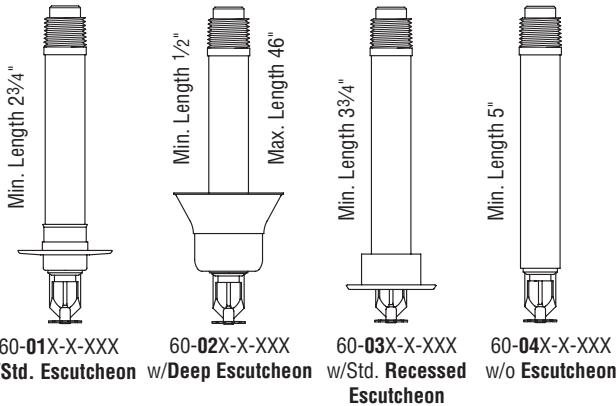

1/2" to 5-3/4"	\$200.50	\$214.00
6"	\$191.00	\$201.00
6-1/4" to 7-3/4"	\$212.50	\$223.50
8"	\$200.50	\$214.00
8-1/4" to 11-3/4"	\$229.00	\$242.00
12"	\$212.50	\$223.50
12-1/4" to 15"	\$240.00	\$255.00
15-1/4" to 18"	\$251.50	\$264.50
18-1/4" to 21"	\$263.50	\$276.50
21-1/4" to 24"	\$275.50	\$290.00
24-1/4" to 27"	\$286.50	\$298.50
27-1/4" to 30"	\$298.00	\$308.50
30-1/4" to 33"	\$308.00	\$322.00
33-1/4" to 36"	\$321.50	\$332.50
36-1/4" to 39"	\$332.00	\$345.00
39-1/4" to 42"	\$344.50	\$357.00
42-1/4" to 45"	\$356.00	\$367.50
45-1/4" to 48"	\$367.00	\$378.00

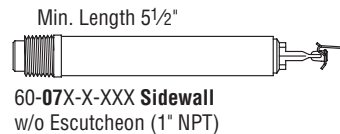
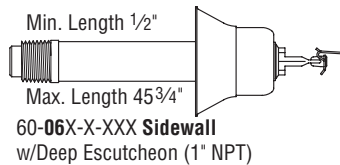
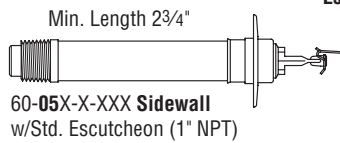

Replacement Escutcheons

56-701-2-010	1/2" Brass Plated (Style 10)	\$9.50
56-701-9-010	1/2" Chrome Plated (Style 10)	\$6.55
56-701-4-010	1/2" Signal White (RAL 9003) (Style 10)	\$6.55
91-106-2-007	Brass Plated (Push On)	\$6.65
91-106-9-007	Chrome Plated (Push On)	\$6.55
91-106-0-007	White Color (Push On)	\$6.55

Dry Sprinkler Rubber Boot Kit

63-000-0-002	DSB-2 Dry Sprinkler Boot Kit Includes: 1-EPDM Rubber Boot, 2-Nylon Ties, 1-1/3 oz tube of adhesive	\$45.75
---------------------	--	---------

Sprinkler Wrench (Standard Pipe Wrench for pipe barrel)

56-850-4-001	W-Type 7 Wrench (Recessed Only)	\$85.00
---------------------	---------------------------------	---------

Technical Data Sheet: TFP510, Sprinkler Boot-TFP591

Note: All Dry Sprinklers are special ordered and are Non-Returnable. Please see "Terms & Conditions"

Items marked "C.O." are made to order and may require longer delivery times. Please contact customer service for availability.

See latest Technical Data Sheets for specific Approvals, Listings, Design Parameters & available finishes. Sprinkler heads & escutcheons are priced separately unless otherwise noted.

**Series DS-1, Dry, Standard Coverage, 1" NPT
Pendent, Upright & Horizontal Sidewall, QR, K=5.6, 3mm Bulb**

P/N 60 - XXX - X - XXX

36	Pendent w/Std. Escutcheon (1" NPT)
33	Pendent w/Deep Escutcheon (1" NPT)
37	Pendent w/Std. Recessed Escutcheon (1" NPT)
32	Pendent w/o Escutcheon (1" NPT)
34	Sidewall w/Std. Escutcheon (1" NPT)
43	Sidewall w/Deep Escutcheon (1" NPT)
44	Sidewall w/o Escutcheon (1" NPT)
38	Upright w/o Escutcheon (1" NPT)

C.O.	Temperature
0	135°F (57°C)
1	155°F (68°C)
2	175°F (79°C)
3	200°F (93°C)
4	286°F (141°C)

Finish	
Sprinkler	Escutcheon
2	Brass
1	Brass
4	White*
0	Chrome
9	Chrome

Length (for example)	
060	6.00"
062	6.25"
065	6.50"
067	6.75"
372	37.25"
480	48.00"

* Signal White (RAL 9003)

1" NPT SIN (Upright TY3135), (Pendent TY3235), (HSW TY3335)

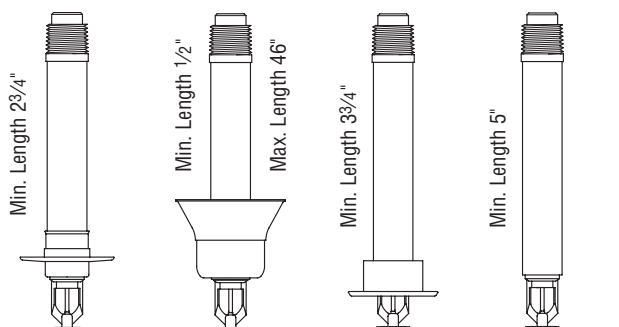

60-36X-X-XXX w/Std. Escutcheon
60-33X-X-XXX w/Deep Escutcheon
60-37X-X-XXX w/Std. Recessed Escutcheon
60-32X-X-XXX w/o Escutcheon

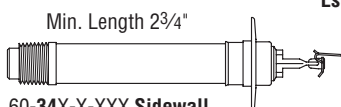

60-34X-X-XXX Sidewall w/Std. Escutcheon (1" NPT)

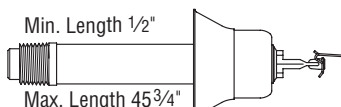

60-43X-X-XXX Sidewall w/Deep Escutcheon (1" NPT)

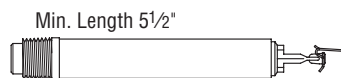

60-44X-X-XXX Sidewall w/o Escutcheon (1" NPT)

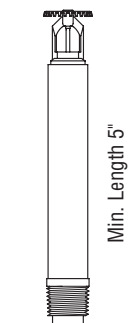

60-38X-X-XXX Upright

Note: All Dry Sprinklers are special ordered and are Non-Returnable. Please see "Terms & Conditions"

Length (48" Max)	Upright	Pendent	Sidewall
1/2" to 5-3/4"	\$174.50	\$174.50	\$186.50
6"	\$166.00	\$166.00	\$175.00
6-1/4" to 7-3/4"	\$185.00	\$185.00	\$194.50
8"	\$174.50	\$174.50	\$186.50
8-1/4" to 11-3/4"	\$199.00	\$199.00	\$210.00
12"	\$185.00	\$185.00	\$194.50
12-1/4" to 15"	\$209.00	\$209.00	\$221.50
15-1/4" to 18"	\$218.50	\$218.50	\$230.00
18-1/4" to 21"	\$229.00	\$229.00	\$240.50
21-1/4" to 24"	\$239.50	\$239.50	\$252.00
24-1/4" to 27"	\$249.50	\$249.50	\$259.50
27-1/4" to 30"	\$259.00	\$259.00	\$268.50
30-1/4" to 33"	\$268.00	\$268.00	\$280.50
33-1/4" to 36"	\$280.00	\$280.00	\$289.50
36-1/4" to 39"	\$289.00	\$289.00	\$300.00
39-1/4" to 42"	\$299.50	\$299.50	\$310.50
42-1/4" to 45"	\$310.00	\$310.00	\$319.50
45-1/4" to 48"	\$319.00	\$319.00	\$328.50

Replacement Escutcheons

56-701-2-010	1/2" Brass Plated (Style 10)	\$9.50
56-701-9-010	1/2" Chrome Plated (Style 10)	\$6.55
56-701-4-010	1/2" Signal White (RAL 9003) (Style 10)	\$6.55
91-106-2-007	Brass Plated (Push On)	\$6.65
91-106-9-007	Chrome Plated (Push On)	\$6.55
91-106-0-007	White Color (Push On)	\$6.55

Dry Sprinkler Rubber Boot Kit

63-000-0-002	DSB-2 Dry Sprinkler Boot Kit Includes: 1-EPDM Rubber Boot, 2-Nylon Ties, 1-1/3 oz tube of adhesive	\$45.75
--------------	--	---------

Sprinkler Wrench (Standard Pipe Wrench for pipe barrel)

56-850-4-001	W-Type 7 Wrench (Recessed Only)	\$85.00
--------------	---------------------------------	---------

Technical Data Sheet: TFP510, Sprinkler Boot-TFP591

See latest Technical Data Sheets for specific Approvals, Listings, Design Parameters & available finishes. Sprinkler heads & escutcheons are priced separately unless otherwise noted.

Items marked "C.O." are made to order and may require longer delivery times. Please contact customer service for availability.

Section 1
Standard Spray Sprinklers

Section 2
Extended Coverage Sprinklers

Section 3
Storage Sprinklers

Section 4
Residential Products

Section 5
Dry Sprinklers

Section 6
Special Sprinklers

Section 7
Nozzles and Sprinkler Accessories

Series DS-1, Dry, Extended Coverage, Horizontal Sidewall, QR & SR, K=5.6, 3mm & 5mm Bulb

P/N 60 - XXX - X - XXX

C.O. EC Sidewall 3mm Bulb (QR)		Finish		Length (for example)		
		Sprinkler	Escutcheon			
350	▶ 135°F (57°C) (1" NPT)	2	Brass	Brass	060	6.00"
351	155°F (68°C) (1" NPT)	1	Brass	White*	062	6.25"
		4	White*	White*	065	6.50"
		0	Chrome	White*	067	6.75"
		9	Chrome	Chrome	372	37.25"
					480	48.00"

C.O. EC Sidewall 5mm Bulb (SR)	
950	▶ 135°F (57°C) (1" NPT)
951	155°F (68°C) (1" NPT)

* Signal White (RAL 9003)

DS-1 Extended Coverage Sidewall
SIN (SR TY3358), (QR TY3338)

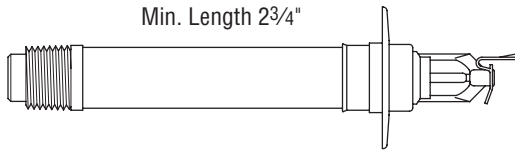

60-95X-X-XXX **Extended Coverage Sidewall**
SR, w/Std. Escutcheon (1" NPT)

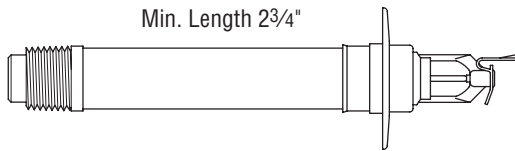

60-35X-X-XXX **Extended Coverage Sidewall**
QR, w/Std. Escutcheon (1" NPT)

Note: All Dry Sprinklers are special ordered and are Non-Returnable. Please see "Terms & Conditions"

Length
(48" Max)

(SR) EC S/W

(QR) EC S/W

2-3/4" to 6"	\$191.50	\$207.00
6-1/4" to 8"	\$201.50	\$217.00
8-1/4" to 12"	\$217.00	\$230.00
12-1/4" to 15"	\$226.00	\$240.50
15-1/4" to 18"	\$237.50	\$252.00
18-1/4" to 21"	\$247.50	\$259.50
21-1/4" to 24"	\$256.50	\$268.50
24-1/4" to 27"	\$268.00	\$280.50
27-1/4" to 30"	\$279.00	\$289.50
30-1/4" to 33"	\$289.50	\$300.00
33-1/4" to 36"	\$301.00	\$310.50
36-1/4" to 39"	\$310.00	\$319.50
39-1/4" to 42"	\$321.00	\$328.50
42-1/4" to 45"	\$329.50	\$346.00
45-1/4" to 48"	\$340.00	\$357.00

Replacement Escutcheons

91-106-2-007	Brass Plated (Push On)	\$6.65
91-106-9-007	Chrome Plated (Push On)	\$6.55
91-106-0-007	White Color (Push On)	\$6.55

Dry Sprinkler Rubber Boot Kit

63-000-0-002	DSB-2 Dry Sprinkler Boot Kit Includes: 1-EPDM Rubber Boot, 2-Nylon Ties, 1-1/3 oz tube of adhesive	\$45.75
---------------------	--	---------

Sprinkler Wrench (Standard Pipe Wrench for pipe barrel)

56-850-4-001	W-Type 7 Wrench	\$85.00
---------------------	-----------------	---------

Technical Data Sheet: TFP520, Sprinkler Boot-TFP591

Items marked "C.O." are made to order and may require longer delivery times. Please contact customer service for availability.

See latest Technical Data Sheets for specific Approvals, Listings, Design Parameters & available finishes. Sprinkler heads & escutcheons are priced separately unless otherwise noted.

Series DS-1, Dry, Stainless Steel, Standard Coverage, Pendent, QR or SR, K=5.6

P/N 60 - XXX - X - XXX

		SIN			Finish		ORDER LENGTH ⁽¹⁾ EXAMPLES	
11	SS Pendent QR w/ Standard Escutcheon	TY3230	C.O.	TEMPERATURE RATING ^{(2) (3)}	6	Stainless Steel for Sprinkler & Escutcheon	055	5.50"
12	SS Pendent QR w/ Recessed Escutcheon	TY3230	0	▶ 135°F (57°C)			082	8.25"
13	SS Pendent QR w/ Deep Escutcheon	TY3230	1	▶ 155°F (68°C)			180	18.00"
14	SS Pendent QR w/o Escutcheon	TY3230	2	▶ 175°F (79°C)			187	18.75"
21	SS Pendent SR w/ Standard Escutcheon	TY3250	3	▶ 200°F (93°C)			372	37.25"
22	SS Pendent SR w/ Recessed Escutcheon	TY3250	4	▶ 286°F (141°C)			480	48.00"
23	SS Pendent SR w/ Deep Escutcheon	TY3250	5	▶ 360°F (182°C) ⁽³⁾				
24	SS Pendent SR w/o Escutcheon	TY3250						

- Notes:**
- Dry-Type Sprinklers are furnished based upon "Order Length" as measured per Figures 10 through 17 in TD sheet TFP560 and for each individual sprinkler where it is to be installed. After taking the measurement, round it to the nearest 1/4 inch increment.
 - Temperature ratings 286°F/141°C and 360°F/182°C apply to non-recessed sprinkler assemblies.
 - Temperature rating 360°F/182°C apply to standard response, non-recessed sprinkler only (TY3250).

Section 1
Standard Spray Sprinklers

Section 2
Extended Coverage Sprinklers

Section 3
Storage Sprinklers

Section 4
Residential Products

Section 5
Dry Sprinklers

Section 6
Special Sprinklers

Section 7
Nozzles and Sprinkler Accessories

DS-1 Stainless Steel, Standard Coverage, Pendent Standard Response or Quick Response



SR - 60-21X-X-XXX
QR - 60-11X-X-XXX
w/Std. Escutcheon

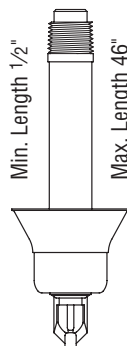

SR - 60-23X-X-XXX
QR - 60-13X-X-XXX
w/Deep Escutcheon



SR - 60-22X-X-XXX
QR - 60-12X-X-XXX
w/Std. Recessed Escutcheon



SR - 60-24X-X-XXX
QR - 60-14X-X-XXX
w/o Escutcheon

Note: All Dry Sprinklers are special ordered and are Non-Returnable. Please see "Terms & Conditions"

Length (48" Max)	List Price
1/2" to 5-3/4"	\$387.00
6"	\$387.00
6-1/4" to 7-3/4"	\$402.00
8"	\$402.00
8-1/4" to 11-3/4"	\$402.00
12"	\$402.00
12-1/4" to 15"	\$415.00
15-1/4" to 18"	\$428.00
18-1/4" to 21"	\$440.50
21-1/4" to 24"	\$453.50
24-1/4" to 27"	\$466.50
27-1/4" to 30"	\$479.50
30-1/4" to 33"	\$492.50
33-1/4" to 36"	\$505.00
36-1/4" to 39"	\$517.50
39-1/4" to 42"	\$531.00
42-1/4" to 45"	\$543.50
45-1/4" to 48"	\$556.00

Replacement Escutcheon

56-701-1-010	1/2" Stainless Steel Plain (Style 10)	\$18.50
56-701-S-010	1/2" Stainless Steel - Signal White (RAL 9003) (Style 10)	\$18.50
91-106-8-107	Stainless Steel (Push-On)	\$18.50

Dry Sprinkler Rubber Boot Kit

63-000-0-002	DSB-2 Dry Sprinkler Boot Kit Includes: 1-EPDM Rubber Boot, 2-Nylon Ties, 1-1/3 oz tube of adhesive	\$45.75
---------------------	--	---------

Sprinkler Wrench

(Standard Pipe Wrench for pipe barrel)

56-850-4-001	W-Type 7 Wrench (Recessed Only)	\$85.00
---------------------	---------------------------------	---------

Technical Data Sheet: TFP560, Sprinkler Boot-TFP591

See latest Technical Data Sheets for specific Approvals, Listings, Design Parameters & available finishes. Sprinkler heads & escutcheons are priced separately unless otherwise noted.

Items marked "C.O." are made to order and may require longer delivery times. Please contact customer service for availability.

Series DS-1, Dry, Stainless Steel, Standard & Extended Coverage, Horizontal Sidewall, QR or SR, K=5.6

P/N 60 - XXX - X- XXX

		SIN			ORDER LENGTH* EXAMPLES			
15	SS HSW QR, SC w/ Standard Escutcheon	TY3337	C.O.	TEMPERATURE RATING (2) (3)	6	FINISH Stainless Steel for Sprinkler & Escutcheon	055	5.50"
16	SS HSW QR, SC w/ Deep Escutcheon	TY3337					0	135°F (57°C)
17	SS HSW QR SC w/o Escutcheon	TY3337	1	155°F (68°C)	180	18.00"	187	18.75"
25	SS HSW SR, SC w/ Standard Escutcheon	TY3357	2	175°F (79°C)	372	37.25"	480	48.00"
26	SS HSW SR, SC w/ Deep Escutcheon	TY3357	3	200°F (93°C)				
27	SS HSW SR w/o Escutcheon	TY3357	4	286°F (141°C)				
18	SS HSW QR, EC w/ Standard Escutcheon Note: Available with 135°F/57°C & 155°F/68°C temperature ratings only.	TY3339	5	360°F (182°C) (3)				

- Notes:**
1. Dry-Type Sprinklers are furnished based upon "Order Length" as measured per Figures 10 through 17 and for each individual sprinkler where it is to be installed. After taking the measurement, round it to the nearest 1/4 inch increment.
 2. Temperature ratings 286°F/141°C and 360°F/182°C apply to non-recessed sprinkler assemblies.
 3. Temperature rating 360°F/182°C apply to standard response, non-recessed sprinkler only (TY3250).

DS-1 Stainless Steel, Standard Coverage, HSW Standard Response or Quick Response

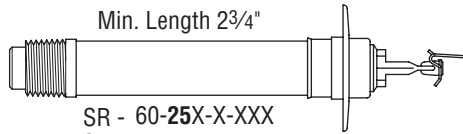

SR - 60-25X-X-XXX
QR - 60-15X-X-XXX
w/Std. Escutcheon (1" NPT)

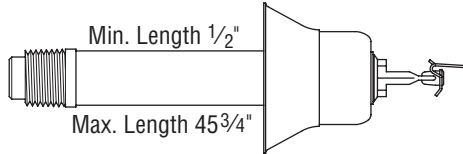

SR - 60-26X-X-XXX
QR - 60-16X-X-XXX
w/Deep Escutcheon (1" NPT)

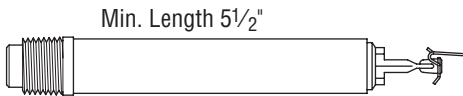

SR - 60-27X-X-XXX
QR - 60-17X-X-XXX
w/o Escutcheon (1" NPT)

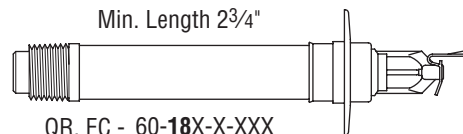

QR, EC - 60-18X-X-XXX
w/Std. Escutcheon (1" NPT)

Note: All Dry Sprinklers are special ordered and are Non-Returnable. Please see "Terms & Conditions"

Length (48" Max)	List Price
1/2" to 5-3/4"	\$387.00
6"	\$387.00
6-1/4" to 7-3/4"	\$402.00
8"	\$402.00
8-1/4" to 11-3/4"	\$402.00
12"	\$402.00
12-1/4" to 15"	\$415.00
15-1/4" to 18"	\$428.00
18-1/4" to 21"	\$440.50
21-1/4" to 24"	\$453.50
24-1/4" to 27"	\$466.50
27-1/4" to 30"	\$479.50
30-1/4" to 33"	\$492.50
33-1/4" to 36"	\$505.00
36-1/4" to 39"	\$517.50
39-1/4" to 42"	\$531.00
42-1/4" to 45"	\$543.50
45-1/4" to 48"	\$556.00
Replacement Escutcheons	
56-701-1-010	1/2" Stainless Steel Plain (Style 10) \$18.50
56-701-S-010	1/2" Stainless Steel - Signal White (RAL 9003) (Style 10) \$18.50
91-106-8-107	Stainless Steel (Push-On) \$18.50
Dry Sprinkler Rubber Boot Kit	
63-000-0-002	DSB-2 Dry Sprinkler Boot Kit Includes: 1-EPDM Rubber Boot, 2-Nylon Ties, 1-1/3 oz tube of adhesive \$45.75
Sprinkler Wrench	
(Standard Pipe Wrench for pipe barrel)	
56-850-4-001	W-Type 7 Wrench (Recessed Only) \$85.00
Technical Data Sheet: TFP560, Sprinkler Boot-TFP591	

Items marked "C.O." are made to order and may require longer delivery times. Please contact customer service for availability.

See latest Technical Data Sheets for specific Approvals, Listings, Design Parameters & available finishes. Sprinkler heads & escutcheons are priced separately unless otherwise noted.

Series DS-2, ELO Dry, Standard Coverage, Pendent, SR, K=11.2, 5mm Bulb

P/N 61 - XXX - X - XXX

Pendent		C.O. Temperature		Finish		Length (for example)	
				Sprinkler	Escutcheon		
10	w/Flush Escutcheon	0	135°F (57°C)	1	White*	060	6.00"
11	w/Recessed Escutcheon	1	155°F (68°C)	4	White*	062	6.25"
12	w/Extended Escutcheon	2	175°F (79°C)	9	Chrome	065	6.50"
13	w/o Escutcheon	3	200°F (93°C)	0	Chrome	067	6.75"
		4	286°F (141°C)	5	Brass	372	37.25"
						480	48.00"

* Signal White (RAL 9003)

DS-2 Standard Response
SIN TY5255

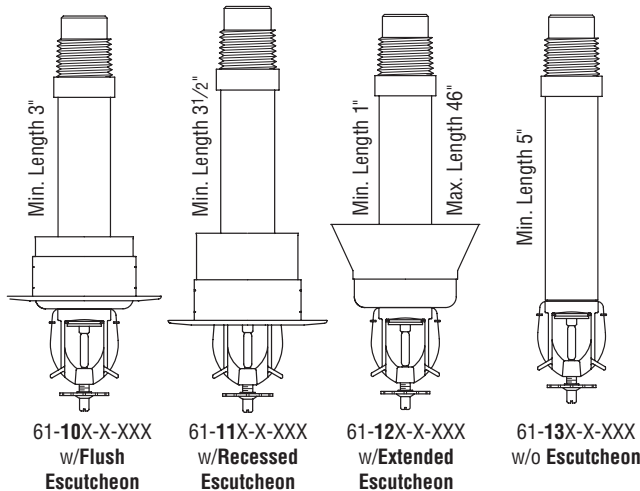

Note: All Dry Sprinklers are special ordered and are Non-Returnable. Please see "Terms & Conditions"

Length (48" Max)	List Price
1" to 6"	\$233.50
6-1/4" to 8"	\$243.00
8-1/4" to 12"	\$253.50
12-1/4" to 15"	\$264.00
15-1/4" to 18"	\$274.00
18-1/4" to 21"	\$284.00
21-1/4" to 24"	\$294.50
24-1/4" to 27"	\$305.00
27-1/4" to 30"	\$316.00
30-1/4" to 33"	\$326.50
33-1/4" to 36"	\$337.50
36-1/4" to 39"	\$348.00
39-1/4" to 42"	\$357.50
42-1/4" to 45"	\$368.00
45-1/4" to 48"	\$385.00
Replacement Escutcheons (Recessed Outer)	
854922	Brass Plated - Flush \$6.55
854912	Chrome Plated - Flush \$6.55
854902	Flush White Color - Flush \$9.50
854822	Brass Plated - Deep \$6.55
854812	Chrome Plated - Deep \$6.55
854802	White Color - Deep \$6.55
Dry Sprinkler Rubber Boot Kit	
63-000-0-002	DSB-2 Dry Sprinkler Boot Kit Includes: 1-EPDM Rubber Boot, 2-Nylon Ties, 1-1/3 oz tube of adhesive \$45.75
Sprinkler Pipe Wrench (Standard Pipe Wrench for pipe barrel)	
56-010-4-118	W-Type 17 Wrench (Recessed Only) \$73.50
Technical Data Sheet: TFP530, Sprinkler Boot-TFP591	

See latest Technical Data Sheets for specific Approvals, Listings, Design Parameters & available finishes. Sprinkler heads & escutcheons are priced separately unless otherwise noted.

Items marked "C.O." are made to order and may require longer delivery times. Please contact customer service for availability.

Section 1
Standard Spray Sprinklers

Section 2
Extended Coverage Sprinklers

Section 3
Storage Sprinklers

Section 4
Residential Products

Section 5
Dry Sprinklers

Section 6
Special Sprinklers

Section 7
Nozzles and Sprinkler Accessories

Series DS-2, ELO Dry, Standard Coverage, Pendent, QR, K=11.2, 3mm Bulb

P/N 61 - XXX - X - XXX

Pendent		C.O. Temperature		Finish		Length (for example)	
				Sprinkler	Escutcheon		
30	w/Flush Escutcheon	0	▶ 135°F (57°C)	1	Brass White*	060	6.00"
31	w/Recessed Escutcheon	1	155°F (68°C)	4	White* White*	062	6.25"
32	w/Extended Escutcheon	2	▶ 175°F (79°C)	9	Chrome Chrome	065	6.50"
35	w/o Escutcheon	3	200°F (93°C)	0	Chrome White*	067	6.75"
		4	286°F (141°C)	5	Brass Brass	372	37.25"
						480	48.00"

* Signal White (RAL 9003)

DS-2 Quick Response, Standard Coverage
SIN TY5235

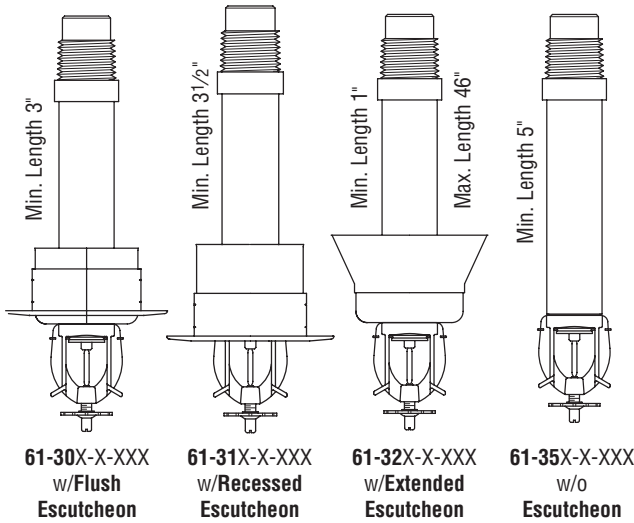

Note: All Dry Sprinklers are special ordered and are Non-Returnable. Please see "Terms & Conditions"

Length (48" Max)	List Price
1" to 6"	\$233.50
6-1/4" to 8"	\$243.00
8-1/4" to 12"	\$253.50
12-1/4" to 15"	\$264.00
15-1/4" to 18"	\$274.00
18-1/4" to 21"	\$284.00
21-1/4" to 24"	\$294.50
24-1/4" to 27"	\$305.00
27-1/4" to 30"	\$316.00
30-1/4" to 33"	\$326.50
33-1/4" to 36"	\$337.50
36-1/4" to 39"	\$348.00
39-1/4" to 42"	\$357.50
42-1/4" to 45"	\$368.00
45-1/4" to 48"	\$385.00
Replacement Escutcheons (Recessed Outer)	
854922	Brass Plated - Flush \$6.55
854912	Chrome Plated - Flush \$6.55
854902	Flush White Color - Flush \$9.50
854822	Brass Plated - Deep \$6.55
854812	Chrome Plated - Deep \$6.55
854802	White Color - Deep \$6.55
Dry Sprinkler Rubber Boot Kit	
63-000-0-002	DSB-2 Dry Sprinkler Boot Kit Includes: 1-EPDM Rubber Boot, 2-Nylon Ties, 1-1/3 oz tube of adhesive \$45.75
Sprinkler Wrench (Standard Pipe Wrench for pipe barrel)	
56-010-4-118	W-Type 17 Wrench \$73.50
Technical Data Sheet: TFP530, Sprinkler Boot-TFP591	

Items marked "C.O." are made to order and may require longer delivery times. Please contact customer service for availability.

See latest Technical Data Sheets for specific Approvals, Listings, Design Parameters & available finishes. Sprinkler heads & escutcheons are priced separately unless otherwise noted.

Section 1 Standard Spray Sprinklers
Section 2 Extended Coverage Sprinklers
Section 3 Storage Sprinklers
Section 4 Residential Products
Section 5 Dry Sprinklers
Section 6 Special Sprinklers
Section 7 Nozzles and Sprinkler Accessories

Series DS-2, ELO Dry, Extended Coverage, Pendent, QR & SR, K=11.2, 3mm Bulb

P/N 61 - XXX - X - XXX

Pendent	
40	w/Flush Escutcheon
41	w/Recessed Escutcheon
42	w/Extended Escutcheon
43	w/o Escutcheon

C.O. Temperature	
0	135°F (57°C)
1	155°F (68°C)
2	175°F (79°C)
3	200°F (93°C)
4	286°F (141°C)

Finish		
	Sprinkler	Escutcheon
1	Brass	White*
4	White*	White*
9	Chrome	Chrome
0	Chrome	White*
5	Brass	Brass

Length (for example)	
060	6.00"
062	6.25"
065	6.50"
067	6.75"
372	37.25"
480	48.00"

* Signal White (RAL 9003)

DS-2 Extended Coverage SIN TY5238		Length (48" Max)	List Price
<p>61-40X-X-XXX w/Flush Escutcheon</p> <p>61-41X-X-XXX w/Recessed Escutcheon</p> <p>61-42X-X-XXX w/Extended Escutcheon</p> <p>61-43X-X-XXX w/o Escutcheon</p> <p>Note: All Dry Sprinklers are special ordered and are Non-Returnable. Please see "Terms & Conditions"</p>	1" to 6"	\$284.00	
	6-1/4" to 8"	\$294.50	
	8-1/4" to 12"	\$305.00	
	12-1/4" to 15"	\$316.00	
	15-1/4" to 18"	\$326.50	
	18-1/4" to 21"	\$337.50	
	21-1/4" to 24"	\$348.00	
	24-1/4" to 27"	\$357.50	
	27-1/4" to 30"	\$368.00	
	30-1/4" to 33"	\$378.00	
	33-1/4" to 36"	\$388.00	
	36-1/4" to 39"	\$398.50	
	39-1/4" to 42"	\$409.50	
	42-1/4" to 45"	\$421.50	
	45-1/4" to 48"	\$441.50	
	Replacement Escutcheons		
854922	Brass Plated - Flush	\$6.55	
854912	Chrome Plated - Flush	\$6.55	
854902	Flush White Color - Flush	\$9.50	
854822	Brass Plated - Deep	\$6.55	
854812	Chrome Plated - Deep	\$6.55	
854802	White Color - Deep	\$6.55	
Dry Sprinkler Rubber Boot Kit			
63-000-0-002	DSB-2 Dry Sprinkler Boot Kit Includes: 1-EPDM Rubber Boot, 2-Nylon Ties, 1-1/3 oz tube of adhesive	\$45.75	
Sprinkler Wrench (Standard Pipe Wrench for pipe barrel)			
56-010-4-118	W-Type 17 Wrench	\$73.50	
Notes			
Quick response or standard response is dependent on hazard. See technical data sheet for additional information.			
Technical Data Sheet: TFP540, Sprinkler Boot-TFP591			

See latest Technical Data Sheets for specific Approvals, Listings, Design Parameters & available finishes. Sprinkler heads & escutcheons are priced separately unless otherwise noted.

Items marked "C.O." are made to order and may require longer delivery times. Please contact customer service for availability.

Section 1
Standard Spray Sprinklers

Section 2
Extended Coverage Sprinklers

Section 3
Storage Sprinklers

Section 4
Residential Products

Section 5
Dry Sprinklers

Section 6
Special Sprinklers

Section 7
Nozzles and Sprinkler Accessories

**Series DS-3, Dry, Extended Coverage Ordinary Hazard (ECOH),
Horizontal Sidewall, 1" NPT, K=11.2, 3mm bulb**

P/N 61 — XXX — X — XXX

		MODEL/SIN			ORDER LENGTH (1) (EXAMPLES)	
161	Flush Escutcheon (1"NPT), 155°F (68°C)	TY5339			055	5.50"
163	Flush Escutcheon (1"NPT), 200°F (93°C)	TY5339			082	8.25"
171	Deep Escutcheon Skirt (1"NPT), 155°F (68°C)	TY5339			180	18.00"
173	Deep Escutcheon Skirt (1"NPT), 200°F (93°C)	TY5339			187	18.75"
151	Without Escutcheon (1"NPT), 155°F (68°C)	TY5339			372	37.25"
153	Without Escutcheon (1"NPT), 200°F (93°C)	TY5339			480	48.00"

	SPRINKLER FINISH	ESCUTCHEON FINISH (2)
1	NATURAL BRASS	BRASS PLATED
4	WHITE *	WHITE *
9	CHROME PLATED	CHROME PLATED
0	CHROME PLATED	WHITE *

* Signal White (RAL 9003)

**DS-3 Extended Coverage Ordinary Hazard Sidewall
SIN (TY5339)**

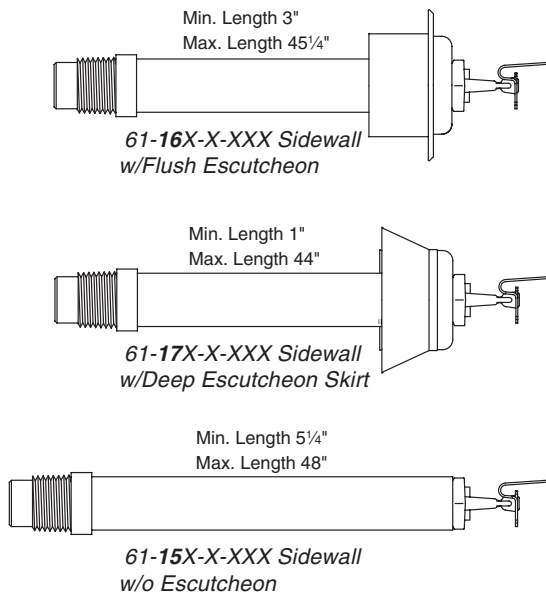

**Note: All Dry Sprinklers are special ordered and are
Non-Returnable. Please see "Terms & Conditions"**

<i>Length (48" Max)</i>	<i>ECOH S/W</i>
1" to 6"	\$261.00
6-1/4" to 8"	\$267.00
8-1/4" to 12"	\$274.50
12-1/4" to 15"	\$281.50
15-1/4" to 18"	\$289.00
18-1/4" to 21"	\$295.00
21-1/4" to 24"	\$302.50
24-1/4" to 27"	\$310.00
27-1/4" to 30"	\$316.50
30-1/4" to 33"	\$323.50
33-1/4" to 36"	\$330.00
36-1/4" to 39"	\$338.00
39-1/4" to 42"	\$345.00
42-1/4" to 45"	\$352.00
45-1/4" to 48"	\$358.00
Replacement Escutcheons	
854922	Brass Plated - Flush \$6.55
854912	Chrome Plated - Flush \$6.55
854902	Flush White Color - Flush \$9.50
854822	Brass Plated - Deep \$6.55
854812	Chrome Plated - Deep \$6.55
854802	White Color - Deep \$6.55
Dry Sprinkler Rubber Boot Kit	
63-000-0-002	DSB-2 Dry Sprinkler Boot Kit Includes: 1-EPDM Rubber Boot, 2-Nylon Ties, 1-1/3 oz tube of adhesive \$45.75
Sprinkler Wrench (Standard Pipe Wrench for pipe barrel)	
56-892-1-001	W-Type 8 Wrench \$85.00
Technical Data Sheet: TFP550, Sprinkler Boot-TFP591	

Items marked "C.O." are made to order and may require longer delivery times.
Please contact customer service for availability.

See latest Technical Data Sheets for specific Approvals, Listings,
Design Parameters & available finishes. Sprinkler heads & escutcheons
are priced separately unless otherwise noted.

Series DS-C, Dry Concealed, Standard Response, K=5.6, 5mm Bulb

DS-C SR Concealed SIN TY3555		c.o.	Length (48" Max)	List Price																				
<p>P/N 60 — 86 X — 1 — XXX</p> <table border="1"> <thead> <tr> <th>C.O.</th> <th>Temperature</th> </tr> </thead> <tbody> <tr> <td>1</td> <td>155°F (68°C)</td> </tr> <tr> <td>3</td> <td>200°F (93°C)</td> </tr> </tbody> </table> <table border="1"> <thead> <tr> <th colspan="2">Length (for example)</th> </tr> </thead> <tbody> <tr> <td>060</td> <td>6.00"</td> </tr> <tr> <td>062</td> <td>6.25"</td> </tr> <tr> <td>065</td> <td>6.50"</td> </tr> <tr> <td>067</td> <td>6.75"</td> </tr> <tr> <td>372</td> <td>37.25"</td> </tr> <tr> <td>480</td> <td>48.00"</td> </tr> </tbody> </table> <p>Note: All Dry Sprinklers are special ordered and are Non-Returnable. Please see "Terms & Conditions" Note: All Dry Sprinklers are 4 7/8" Min. Length and 48" Max.</p>		C.O.	Temperature	1	155°F (68°C)	3	200°F (93°C)	Length (for example)		060	6.00"	062	6.25"	065	6.50"	067	6.75"	372	37.25"	480	48.00"		5" to 8"	\$198.00
		C.O.	Temperature																					
		1	155°F (68°C)																					
		3	200°F (93°C)																					
		Length (for example)																						
		060	6.00"																					
		062	6.25"																					
		065	6.50"																					
		067	6.75"																					
		372	37.25"																					
		480	48.00"																					
			8-1/4" to 12"	\$210.50																				
			12-1/4" to 15"	\$225.00																				
			15-1/4" to 18"	\$240.50																				
			18-1/4" to 21"	\$254.50																				
	21-1/4" to 27"	\$269.00																						
	27-1/4" to 30"	\$284.00																						
	30-1/4" to 33"	\$299.50																						
	33-1/4" to 36"	\$314.50																						
	36-1/4" to 39"	\$327.00																						
	39-1/4" to 42"	\$342.00																						
	42-1/4" to 45"	\$357.00																						
	45-1/4" to 48"	\$370.00																						
Cover Plates																								
80 Box Quantity (14.5 lbs/box)																								
Cover Plate (For use with 155° F Sprinkler)																								
	56-792-1-135	Brass	139°F (59°C)	\$22.25																				
	56-792-9-135	Chrome	139°F (59°C)	\$22.25																				
	56-792-0-135	Grey White (RAL 9002)	139°F (59°C)	\$22.25																				
	56-792-4-135	Signal White (RAL 9003)	139°F (59°C)	\$22.25																				
	56-792-6-135	Jet Black (RAL 9005)	139°F (59°C)	\$22.25																				
	56-792-X-135	Special Order*	139°F (59°C)	\$24.00																				
Cover Plate (For use with 200° F Sprinkler)																								
	56-792-1-165	Brass	165°F (74°C)	\$22.25																				
	56-792-9-165	Chrome	165°F (74°C)	\$22.25																				
	56-792-0-165	Grey White (RAL 9002)	165°F (74°C)	\$22.25																				
	56-792-4-165	Signal White (RAL 9003)	165°F (74°C)	\$22.25																				
	56-792-6-165	Jet Black (RAL 9005)	165°F (74°C)	\$22.25																				
	56-792-X-165	Special Order*	165°F (74°C)	\$24.00																				
Notes																								
	6012	*Special order paint match subject to set-up charge. (Net Price)		\$376.50																				
Dry Sprinkler Rubber Boot Kit																								
	63-000-0-002	DSB-2 Dry Sprinkler Boot Kit Includes: 1-EPDM Rubber Boot, 2-Nylon Ties, 1-1/3 oz tube of adhesive		\$45.75																				
Sprinkler Wrench (Standard Pipe Wrench for pipe barrel)																								
	56-000-1-075	RFII Wrench		\$85.00																				
Technical Data Sheet: TFP515, Sprinkler Boot-TFP591																								

Section 1
Standard Spray Sprinklers

 Section 2
Extended Coverage Sprinklers

 Section 3
Storage Sprinklers

 Section 4
Residential Products

 Section 5
Dry Sprinklers

 Section 6
Special Sprinklers

 Section 7
Nozzles and Sprinkler Accessories

See latest Technical Data Sheets for specific Approvals, Listings, Design Parameters & available finishes. Sprinkler heads & escutcheons are priced separately unless otherwise noted.

Items marked "C.O." are made to order and may require longer delivery times. Please contact customer service for availability.

Series DS-C, Dry Concealed, Quick Response, K=5.6, 3mm Bulb

DS-C QR Concealed
SIN TY3535

P/N 60 —46 X —1 —XXX

C.O. Temperature		Length (for example)	
1	155°F (68°C)	060	6.00"
3	200°F (93°C)	062	6.25"
		065	6.50"
		067	6.75"
		372	37.25"
		480	48.00"



60-46X-1-XXX

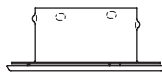

Cover Plate
(Order Separately)

Note: All Dry Sprinklers are special ordered and are Non-Returnable.
Please see "Terms & Conditions"
Note: All Dry Sprinklers are 4 7/8" Min. Length and 48" Max.

C.O.	Length (48" Max)	List Price
	5" to 8"	\$210.50
	8-1/4" to 12"	\$225.00
	12-1/4" to 15"	\$240.50
	15-1/4" to 18"	\$254.50
	18-1/4" to 21"	\$269.00
	21-1/4" to 27"	\$284.00
	27-1/4" to 30"	\$299.50
	30-1/4" to 33"	\$314.50
	33-1/4" to 36"	\$327.00
	36-1/4" to 39"	\$342.00
	39-1/4" to 42"	\$357.00
	42-1/4" to 45"	\$370.00
	45-1/4" to 48"	\$387.00

Cover Plates

80 Box Quantity (14.5 lbs/box)

Cover Plate (For use with 155° F Sprinkler)

Part No.	Material	Temperature	List Price
56-792-1-135	Brass	139°F (59°C)	\$22.25
56-792-9-135	Chrome	139°F (59°C)	\$22.25
56-792-0-135	Grey White (RAL9002)	139°F (59°C)	\$22.25
56-792-4-135	Signal White (RAL 9003)	139°F (59°C)	\$22.25
56-792-6-135	Jet Black (RAL 9005)	139°F (59°C)	\$22.25
56-792-X-135	Special Order*	139°F (59°C)	\$24.00

Cover Plate (For use with 200° F Sprinkler)

Part No.	Material	Temperature	List Price
56-792-1-165	Brass	165°F (74°C)	\$22.25
56-792-9-165	Chrome	165°F (74°C)	\$22.25
56-792-0-165	Grey White (RAL9002)	165°F (74°C)	\$22.25
56-792-4-165	Signal White (RAL 9003)	165°F (74°C)	\$22.25
56-792-6-165	Jet Black (RAL 9005)	165°F (74°C)	\$22.25
56-792-X-165	Special Order*	165°F (74°C)	\$24.00

Notes

6012	*Special order paint match subject to set-up charge. (Net Price)	\$376.50
------	--	----------

Dry Sprinkler Rubber Boot Kit

63-000-0-002	DSB-2 Dry Sprinkler Boot Kit Includes: 1-EPDM Rubber Boot, 2-Nylon Ties, 1-1/3 oz tube of adhesive	\$45.75
--------------	--	---------

Sprinkler Wrench (Standard Pipe Wrench for pipe barrel)

56-000-1-075	RFII Wrench	\$85.00
--------------	-------------	---------

**Technical Data Sheet: TFP515,
Sprinkler Boot-TFP591**

Items marked "C.O." are made to order and may require longer delivery times. Please contact customer service for availability.

See latest Technical Data Sheets for specific Approvals, Listings, Design Parameters & available finishes. Sprinkler heads & escutcheons are priced separately unless otherwise noted.

Section 1
Standard Spray Sprinklers

Section 2
Extended Coverage Sprinklers

Section 3
Storage Sprinklers

Section 4
Residential Products

Section 5
Dry Sprinklers

Section 6
Special Sprinklers

Section 7
Nozzles and Sprinkler Accessories

Series DS-ECC, Dry Extended Concealed Coverage, Quick Response, K=5.6, 3mm Bulb

DS-ECC Extended Concealed Coverage
SIN TY3539

P/N 60 —45 X —1 —XXX

C.O. Temperature		Length (for example)	
1	155°F (68°C)	060	6.00"
3	200°F (93°C)	062	6.25"
		065	6.50"
		067	6.75"
		372	37.25"
		480	48.00"

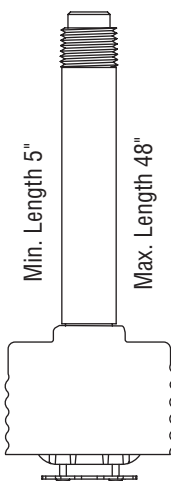

60-45X-1-XXX

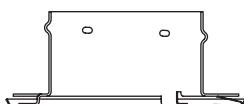

Cover Plate
(Order Separately)

Note: All Dry Sprinklers are special ordered and are Non-Returnable. Please see "Terms & Conditions"

Note: All Dry Sprinklers are 4 7/8" Min. Length and 48" Max.

c.o.	Length (48" Max)	List Price
	5" to 8"	\$225.00
	8-1/4" to 12"	\$240.50
	12-1/4" to 15"	\$254.50
	15-1/4" to 18"	\$269.00
	18-1/4" to 21"	\$284.00
	21-1/4" to 27"	\$299.50
	27-1/4" to 30"	\$314.50
	30-1/4" to 33"	\$327.00
	33-1/4" to 36"	\$342.00
	36-1/4" to 39"	\$357.00
	39-1/4" to 42"	\$370.00
	42-1/4" to 45"	\$387.00
	45-1/4" to 48"	\$407.50

Cover Plates

80 Box Quantity (14.5 lbs/box)

Cover Plate (For use with 155° F Sprinkler)

Part No.	Material	Temperature	List Price
56-792-1-135	Brass	139°F (59°C)	\$22.25
56-792-9-135	Chrome	139°F (59°C)	\$22.25
56-792-0-135	Grey White (RAL 9002)	139°F (59°C)	\$22.25
56-792-4-135	Signal White (RAL 9003)	139°F (59°C)	\$22.25
56-792-6-135	Jet Black (RAL 9005)	139°F (59°C)	\$22.25
56-792-X-135	Special Order*	139°F (59°C)	\$24.00

Cover Plate (For use with 200° F Sprinkler)

Part No.	Material	Temperature	List Price
56-792-1-165	Natural Brass	165°F (74°C)	\$22.25
56-792-9-165	Bright Chrome	165°F (74°C)	\$22.25
56-792-0-165	Grey White (RAL 9002)	165°F (74°C)	\$22.25
56-792-4-165	Signal White (RAL 9003)	165°F (74°C)	\$22.25
56-792-6-165	Jet Black (RAL 9005)	165°F (74°C)	\$22.25
56-792-X-165	Special Order*	165°F (74°C)	\$24.00

Notes

6012	*Special order paint match subject to set-up charge. (Net Price)	\$376.50
------	--	----------

Dry Sprinkler Rubber Boot Kit

63-000-0-002	DSB-2 Dry Sprinkler Boot Kit Includes: 1-EPDM Rubber Boot, 2-Nylon Ties, 1-1/3 oz tube of adhesive	\$45.75
--------------	--	---------

Sprinkler Wrench (Standard Pipe Wrench for pipe barrel)

56-000-1-075	RFII Wrench	\$85.00
--------------	-------------	---------

**Technical Data Sheet: TFP518,
Sprinkler Boot-TFP591**

Section 1
Standard Spray Sprinklers

Section 2
Extended Coverage Sprinklers

Section 3
Storage Sprinklers

Section 4
Residential Products

Section 5
Dry Sprinklers

Section 6
Special Sprinklers

Section 7
Nozzles and Sprinkler Accessories

See latest Technical Data Sheets for specific Approvals, Listings, Design Parameters & available finishes. Sprinkler heads & escutcheons are priced separately unless otherwise noted.

Items marked "C.O." are made to order and may require longer delivery times. Please contact customer service for availability.

ESFR-17, K=16.8, 1-1/4" NPT, Dry-Type Pendent Early Suppression, Fast Response Sprinkler

(SIN TY7229)

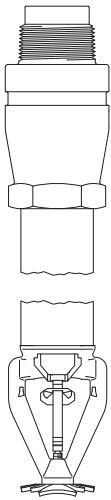

(Note: includes two insulating sealing assemblies)



<i>C.O.</i>	<i>Pendent</i>	<i>Description</i>	<i>Temperature</i>	<i>Price</i>
	61-441-1-360	Brass with Grooved/NPT Threads	165°F (74°C)	See
	61-442-1-360	Brass with Grooved/NPT Threads	214°F (101°C)	Section 3
	I61-441-1-360	Brass with Grooved/ISO Threads	165°F (74°C)	For
	I61-442-1-360	Brass with Grooved/ISO Threads	214°F (101°C)	Pricing
Replacement Parts				
	91-106-1-500	Replacement Insulating Sealing Assembly		\$53.50
Sprinkler Wrench				
	56-341-1-001	W-Type 26 Wrench		\$64.75
Technical Data Sheet: TFP320				

Section 1	Standard Spray Sprinklers
Section 2	Extended Coverage Sprinklers
Section 3	Storage Sprinklers
Section 4	Residential Products
Section 5	Dry Sprinklers
Section 6	Special Sprinklers
Section 7	Nozzles and Sprinkler Accessories

Items marked "C.O." are made to order and may require longer delivery times. Please contact customer service for availability.

See latest Technical Data Sheets for specific Approvals, Listings, Design Parameters & available finishes. Sprinkler heads & escutcheons are priced separately unless otherwise noted.

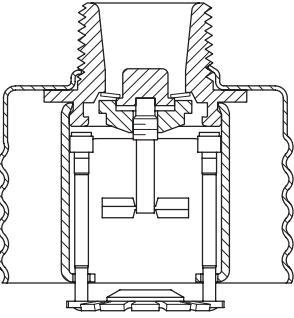
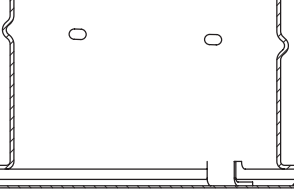
Illusion™ Casino Sprinkler ELO Extra Large Orifice, Concealed Pendent Sprinklers, Quick Response, Standard Coverage, K=11.2, 3/4" N.P.T. (SIN TY5521)

	C.O.	Part No.	Model	Finish	Temperature	List Price	
  <p>Note: All "Special Order" cover plates are special ordered and are Non-Returnable. Please see "Terms & Conditions"</p>		50-711-1-160	Illusion Casino	Brass	160°F (71°C)	\$43.75	
		50-711-1-212	Illusion Casino	Brass	212°F (100°C)	\$43.75	
	Cover Plates (Order Separately)						
			56-892-1-135	Cover Plate	Brass	135°F (57°C)	\$22.25
			56-892-1-165	Cover Plate	Brass	165°F (74°C)	\$22.25
			56-892-9-135	Cover Plate	Chrome	135°F (57°C)	\$22.25
			56-892-9-165	Cover Plate	Chrome	165°F (74°C)	\$22.25
			56-892-4-135	Cover Plate	Signal White (RAL 9003)	135°F (57°C)	\$22.25
			56-892-4-165	Cover Plate	Signal White (RAL 9003)	165°F (74°C)	\$22.25
			56-892-0-135	Cover Plate	Grey White (RAL9002)	135°F (57°C)	\$22.25
			56-892-0-165	Cover Plate	Grey White (RAL9002)	165°F (74°C)	\$22.25
			56-892-X-135	Cover Plate	Special Order*	135°F (57°C)	\$26.25
			56-892-X-165	Cover Plate	Special Order*	165°F (74°C)	\$26.25
	Clean Room Seals (Order Separately)						
			56-908-1-001	Air and Dust Seal			\$12.50
Sprinkler Wrench							
		56-000-1-265	W-Type 18 Wrench			\$85.00	
Notes							
		6012	*Special Order paint match subject to set-up charge. (Net Price)			\$376.50	
 Technical Data Sheet: TFP184							

Section 1
Standard Spray Sprinklers

Section 2
Extended Coverage Sprinklers

Section 3
Storage Sprinklers

Section 4
Residential Products

Section 5
Dry Sprinklers

CC2 Combustible Concealed Space Upright Sprinklers K=5.6, 1/2" N.P.T.

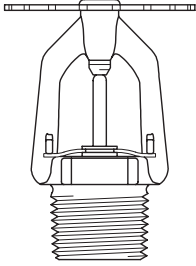
SIN TY3189							
	C.O.	No.	Model	Finish	Temp.	List Price	
		51-301-1-175	CC2	Brass	175°F (79°C)	\$48.50	
	Sprinkler Wrench						
			56-000-6-387	W-Type 6 Wrench			\$51.25
Technical Data Sheet: TFP632							

Section 6
Special Sprinklers

Section 7
Nozzles and Sprinkler Accessories

See latest Technical Data Sheets for specific Approvals, Listings, Design Parameters & available finishes. Sprinkler heads & escutcheons are priced separately unless otherwise noted.

Items marked "C.O." are made to order and may require longer delivery times. Please contact customer service for availability.

CC2 Combustible Concealed Space Upright Sprinklers K=4.2, 1/2" N.P.T.

SIN TY2189

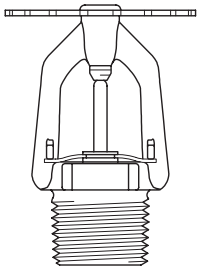

C.O.	No.	Model	Finish	Temp.	List Price
	51-311-1-175	CC2	Brass	175°F (79°C)	\$44.75
Sprinkler Wrench					
	56-000-6-387	W-Type 6 Wrench			\$51.25

Technical Data Sheet: TFP632

CC1 Combustible Concealed Upright Sprinklers K=2.8, 1/2" N.P.T.

SIN TY1189

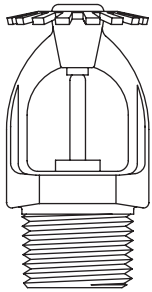

C.O.	No.	Model	Finish	Temp.	List Price
	50-300-1-175	CC1	Brass	175°F (79°C)	\$46.00
Sprinkler Wrench					
	56-000-1-106	W-Type 20 Combination Wrench			\$85.00

Technical Data Sheet: TFP630

WS Window Sprinklers K=5.6, 1/2" N.P.T.

100 Box Quantity (VSW 20 lbs/box (SIN TY3488), HSW 17 lbs/box (SIN TY3388))

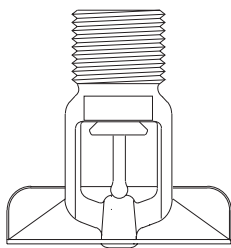

Vertical

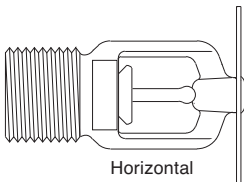

Horizontal

C.O.	No.	Model	Finish	Temperature	List Price
	50-305-1-155	Horizontal Sidewall	Brass	155°F (68°C)	\$384.00
	50-305-1-200	Horizontal Sidewall	Brass	200°F (93°C)	\$384.00
	50-305-9-155	Horizontal Sidewall	Chrome	155°F (68°C)	\$384.00
	50-305-9-200	Horizontal Sidewall	Chrome	200°F (93°C)	\$384.00
	50-305-4-155	Horizontal Sidewall	Signal White (RAL 9003)	155°F (68°C)	\$384.00
	50-305-4-200	Horizontal Sidewall	Signal White (RAL 9003)	200°F (93°C)	\$384.00
	50-304-1-155	Vertical Sidewall	Brass	155°F (68°C)	\$384.00
	50-304-1-200	Vertical Sidewall	Brass	200°F (93°C)	\$384.00
	50-304-9-155	Vertical Sidewall	Chrome	155°F (68°C)	\$384.00
	50-304-9-200	Vertical Sidewall	Chrome	200°F (93°C)	\$384.00
	50-304-4-155	Vertical Sidewall	Signal White (RAL 9003)	155°F (68°C)	\$384.00
	50-304-4-200	Vertical Sidewall	Signal White (RAL 9003)	200°F (93°C)	\$384.00

Sprinkler Wrench

	56-000-1-106	W-Type 20 Combination Wrench		\$85.00
--	--------------	------------------------------	--	---------



Technical Data Sheet: TFP620

Items marked "C.O." are made to order and may require longer delivery times. Please contact customer service for availability.

See latest Technical Data Sheets for specific Approvals, Listings, Design Parameters & available finishes. Sprinkler heads & escutcheons are priced separately unless otherwise noted.

Attic Sprinklers K=4.2, K=5.6 & K=8.0, 1/2" and 3/4" N.P.T.

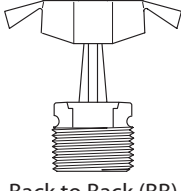
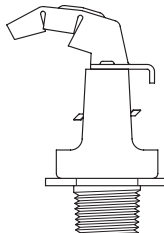
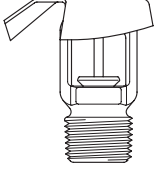
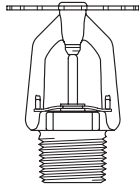
100 Box Quantity (BB/SD 31 lbs/box, HIP 22 lbs/box)

	C.O.	Part No.	Model	SIN Number	Pitch Rise over Run	Finish	K-Factor	Temperature	List Price
		51-623-1-200	ATTIC BB1, 17/32	TY4180	4/12 to < 7/12	Brass	8.0	200°F (93°C)	\$203.00
		51-621-1-200	ATTIC BB2, 17/32	TY4181	7/12 to < 10/12	Brass	8.0	200°F (93°C)	\$203.00
		51-622-1-200	ATTIC BB3, 17/32	TY4182	10/12 to 12/12	Brass	8.0	200°F (93°C)	\$203.00
Back to Back (BB)		50-601-1-212	ATTIC BB1, 1/2	TY3180	4/12 to < 7/12	Brass	5.6	212°F (100°C)	\$158.00
		50-602-1-212	ATTIC BB2, 1/2	TY3181	7/12 to < 10/12	Brass	5.6	212°F (100°C)	\$158.00
		50-603-1-212	ATTIC BB3, 1/2	TY3182	10/12 to 12/12	Brass	5.6	212°F (100°C)	\$158.00
		50-620-1-200	ATTIC BB1, 1/2	TY2180	4/12 to < 7/12	Brass	4.2	200°F (93°C)	\$76.75
		50-621-1-200	ATTIC BB2, 1/2	TY2181	7/12 to < 10/12	Brass	4.2	200°F (93°C)	\$76.75
		50-622-1-200	ATTIC BB3, 1/2	TY2182	10/12 to 12/12	Brass	4.2	200°F (93°C)	\$76.75
Single Directional (SD)		50-611-1-212	ATTIC SD1, 1/2	TY3183	4/12 to < 7/12	Brass	5.6	212°F (100°C)	\$158.00
		50-612-1-212	ATTIC SD2, 1/2	TY3184	7/12 to < 10/12	Brass	5.6	212°F (100°C)	\$158.00
		50-613-1-212	ATTIC SD3, 1/2	TY3185	10/12 to 12/12	Brass	5.6	212°F (100°C)	\$158.00
		51-620-1-200	ATTIC HIP	TY3187	4/12 to 12/12	Brass	5.6	200°F (93°C)	\$158.00
		50-625-1-200	AP, 1/2, K=5.6	TY3190	3/12 to 12/12	Brass	5.6	200°F (93°C)	\$28.25
		50-624-1-200	AP, 1/2, K=4.2	TY2190	3/12 to 12/12	Brass	4.2	200°F (93°C)	\$28.25
	Sprinkler Wrench								
		56-895-1-001	W-Type 3 Wrench						\$70.50
		56-000-6-387	W-Type 6 Wrench						\$51.25
		56-000-1-106	W-Type 20 Combination Wrench						\$85.00
 PEAK TM PERFORMANCE ATTIC PROTECTION SPRINKLER SYSTEM Technical Data Sheet: TFP610									

Section 1
Standard Spray Sprinklers

 Section 2
Extended Coverage Sprinklers

 Section 3
Storage Sprinklers

 Section 4
Residential Products

 Section 5
Dry Sprinklers

 Section 6
Special Sprinklers

 Section 7
Nozzles and Sprinkler Accessories

See latest Technical Data Sheets for specific Approvals, Listings, Design Parameters & available finishes. Sprinkler heads & escutcheons are priced separately unless otherwise noted.

Items marked "C.O." are made to order and may require longer delivery times. Please contact customer service for availability.

Series TY-B , K=5.6 & K=8.0 - Stainless Steel and Titanium, - Standard Response Upright, Pendent, and Conventional Sprinklers

P/N 57 — XXX — 0 — XXX — SUFFIX

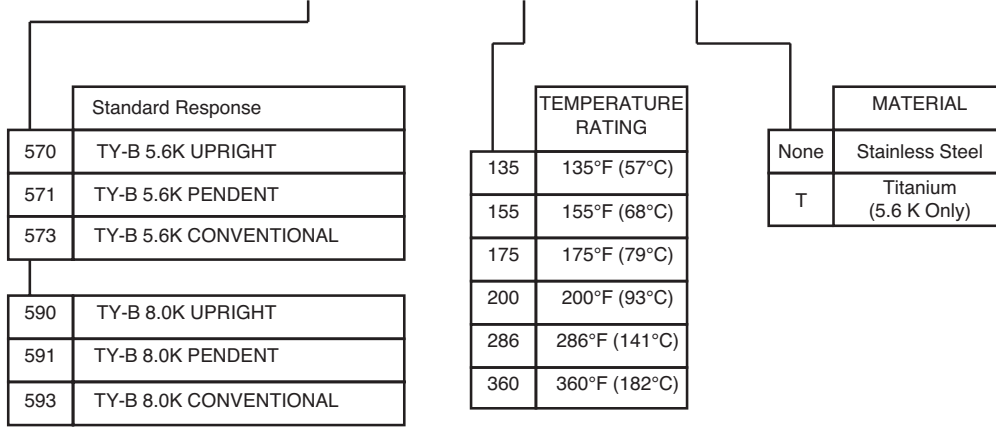

Product Symbol Numbers can be developed by using the table show above. Refer to the Technical data sheet for Sprinkler Identification Numbers. All response, orifice sizes, materials and finishes as follows:

Nozzle	Description	K-Factor	List Price
57-570-0-XXX	TY-B Upright, Standard Response	5.6	\$300.00
57-571-0-XXX	TY-B Pendent, Standard Response	5.6	\$300.00
57-573-0-XXX	TY-B Conventional, Standard Response	5.6	\$300.00
57-XXX-0-XXX T	Titanium Material - Add "T" Suffix (K=5.6 only)	5.6	POA
57-590-0-XXX	TY-B Upright, Standard Response	8.0	\$330.00
57-591-0-XXX	TY-B Pendent, Standard Response	8.0	\$330.00
57-593-0-XXX	TY-B Conventional, Standard Response	8.0	\$330.00
Recessed Escutcheons (Order Separately)			
56-701-0-010	1/2" Stainless Steel (Style 10), with White Paint Finish		\$18.50
56-700-0-010	3/4" Stainless Steel (Style 40), with White Paint Finish		\$18.50
Sprinkler Wrench			
56-000-6-387	W-Type 6 Wrench		\$51.25
56-850-4-001	W-Type 7 Wrench		\$85.00

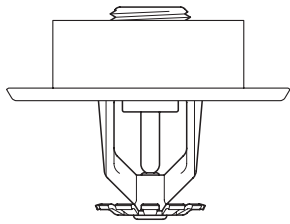

Note: TY-B Standard Response 1/2" NPT K=5.6 Sprinklers is shown

Note: All Alternate Materials Sprinklers are special ordered and are Non-Returnable. Please see "Terms & Conditions"
All Titanium Sprinklers are POA

Technical Data Sheet: TFP680

Items marked "C.O." are made to order and may require longer delivery times. Please contact customer service for availability.

See latest Technical Data Sheets for specific Approvals, Listings, Design Parameters & available finishes. Sprinkler heads & escutcheons are priced separately unless otherwise noted.

**Series TY-B , K=5.6 - Stainless Steel and Titanium, - Standard Response
Horizontal Sidewall and Recessed Horizontal Sidewall Sprinklers**

Product Symbol Numbers can be developed by using the table show above. Refer to the Technical data sheet for Sprinkler Identification Numbers. All response, orifice sizes, materials and finishes as follows:

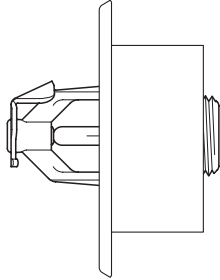
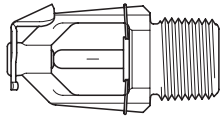

Note: TY-B Standard Response
1/2" NPT K=5.6 Sprinklers is shown

Nozzle	Description	Temperature	K-Factor	List Price
57-578-0-135	TY-B Horizontal Sidewall, SR	135°F (57°C)	5.6	\$300.00
57-578-0-155	TY-B Horizontal Sidewall, SR	155°F (68°C)	5.6	\$300.00
57-578-0-175	TY-B Horizontal Sidewall, SR	175°F (79°C)	5.6	\$300.00
57-578-0-200	TY-B Horizontal Sidewall, SR	200°F (93°C)	5.6	\$300.00
57-578-0-286	TY-B Horizontal Sidewall, SR	286°F (141°C)	5.6	\$300.00
57-578-0-360	TY-B Horizontal Sidewall, SR	360°F (182°C)	5.6	\$300.00
57-578-0-XXX T	Titanium Material - Add "T" Suffix (K=5.6 only)		5.6	POA
Recessed Escutcheons (Order Separately)				
56-701-0-010	1/2" Stainless Steel (Style 10), with White Paint Finish			\$18.50
Sprinkler Wrench				
56-000-6-387	W-Type 6 Wrench			\$51.25
56-850-4-001	W-Type 7 Wrench			\$85.00

Note: All Alternate Materials Sprinklers are special ordered and are Non-Returnable. Please see "Terms & Conditions"
All Titanium Sprinklers are POA

Technical Data Sheet: TFP680

Section 1
Standard Spray Sprinklers

Section 2
Extended Coverage Sprinklers

Section 3
Storage Sprinklers

Section 4
Residential Products

Section 5
Dry Sprinklers

Section 6
Special Sprinklers

Section 7
Nozzles and Sprinkler Accessories

**Series TY-FRB , K=5.6 & K=8.0 - Stainless Steel and Titanium, - Quick Response
Upright, Pendent, and Conventional Sprinklers**

P/N 57 — XXX — 0 — XXX — SUFFIX

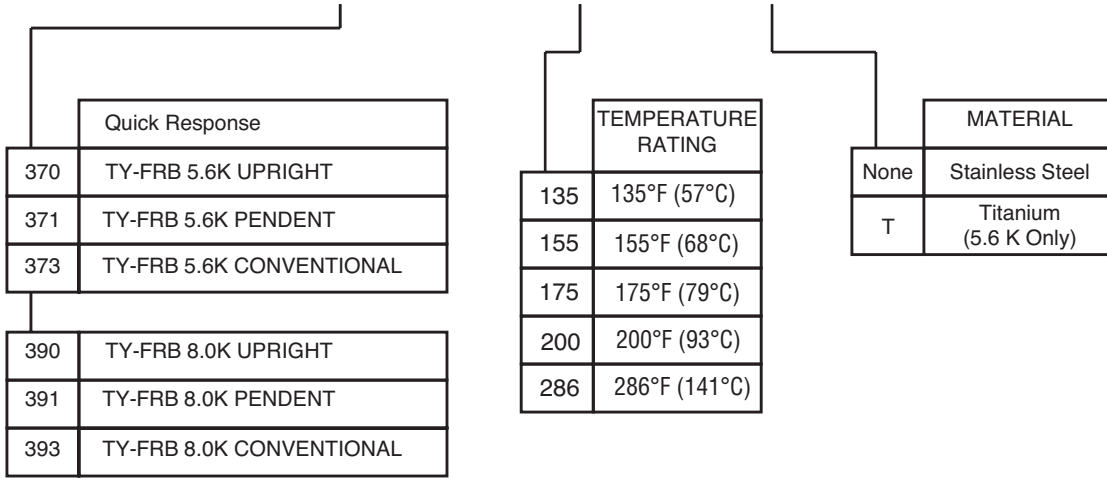

Product Symbol Numbers can be developed by using the table show above. Refer to the Technical data sheet for Sprinkler Identification Numbers. All response, orifice sizes, materials and finishes as follows:

	Nozzle	Description	K-Factor	List Price
	57-370-0-XXX	TY-FRB Upright, Quick Response	5.6	\$300.00
	57-371-0-XXX	TY-FRB Pendent, Quick Response	5.6	\$300.00
	57-373-0-XXX	TY-FRB Conventional, Quick Response	5.6	\$300.00
	57-XXX-0-XXX T	Titanium Material - Add "T" Suffix (K=5.6 only)	5.6	POA
	57-390-0-XXX	TY-FRB Upright, Quick Response	8.0	\$330.00
	57-391-0-XXX	TY-FRB Pendent, Quick Response	8.0	\$330.00
	57-393-0-XXX	TY-FRB Conventional, Quick Response	8.0	\$330.00
Recessed Escutcheons (Order Separately)				
	56-701-0-010	1/2" Stainless Steel (Style 10), with White Paint Finish		\$18.50
	56-700-0-010	3/4" Stainless Steel (Style 40), with White Paint Finish		\$18.50
Sprinkler Wrench				
	56-000-6-387	W-Type 6 Wrench		\$51.25
	56-850-4-001	W-Type 7 Wrench		\$85.00
	<p>Note: All Alternate Materials Sprinklers are special ordered and are Non-Returnable. Please see "Terms & Conditions"</p> <p>All Titanium Sprinklers are POA</p>			
	<p>Technical Data Sheet: TFP680</p>			

Note: TY-FRB Standard Response 3/4" NPT K=8.0 Sprinklers is shown

Items marked "C.O." are made to order and may require longer delivery times. Please contact customer service for availability.

See latest Technical Data Sheets for specific Approvals, Listings, Design Parameters & available finishes. Sprinkler heads & escutcheons are priced separately unless otherwise noted.

**Series TY-FRB , K=5.6 - Stainless Steel and Titanium, - Quick Response
Horizontal Sidewall and Recessed Horizontal Sidewall Sprinklers**

Product Symbol Numbers can be developed by using the table show above. Refer to the Technical data sheet for Sprinkler Identification Numbers. All response, orifice sizes, materials and finishes as follows:

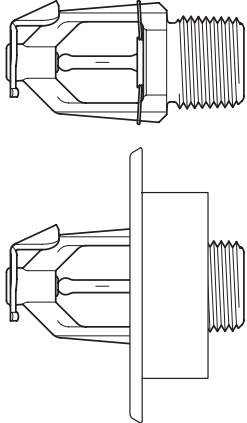
	Nozzle		Description		K-Factor	List Price
	 <p>Note: TY-FRB Standard Response 1/2" NPT K=5.6 Sprinklers is shown</p>	57-378-0-135	TY-FRB Horizontal Sidewall, QR	135°F (57°C)	5.6	\$300.00
57-378-0-155		TY-FRB Horizontal Sidewall, QR	155°F (68°C)	5.6	\$300.00	
57-378-0-175		TY-FRB Horizontal Sidewall, QR	175°F (79°C)	5.6	\$300.00	
57-378-0-200		TY-FRB Horizontal Sidewall, QR	200°F (93°C)	5.6	\$300.00	
57-378-0-286		TY-FRB Horizontal Sidewall, QR	286°F (141°C)	5.6	\$300.00	
57-378-0-360		TY-FRB Horizontal Sidewall, QR	360°F (182°C)	5.6	\$300.00	
57-378-0-XXX T		Titanium Material - Add "T" Suffix (K=5.6 only)		5.6	POA	
Recessed Escutcheons (Order Separately)						
56-701-0-010		1/2" Stainless Steel (Style 10), with White Paint Finish				\$18.50
Sprinkler Wrench						
56-000-6-387	W-Type 6 Wrench				\$51.25	
56-850-4-001	W-Type 7 Wrench				\$85.00	
<p>Note: All Alternate Materials Sprinklers are special ordered and are Non-Returnable. Please see "Terms & Conditions"</p> <p>All Titanium Sprinklers are POA</p>						
Technical Data Sheet: TFP680						

Section 1
Standard Spray Sprinklers

Section 2
Extended Coverage Sprinklers

Section 3
Storage Sprinklers

Section 4
Residential Products

Section 5
Dry Sprinklers

Section 6
Special Sprinklers

Section 7
Nozzles and Sprinkler Accessories

See latest Technical Data Sheets for specific Approvals, Listings, Design Parameters & available finishes. Sprinkler heads & escutcheons are priced separately unless otherwise noted.

Items marked "C.O." are made to order and may require longer delivery times. Please contact customer service for availability.

Tyco® RAVEN™, K=5.6, I-Series Institutional Pendent and Horizontal Sidewall, Quick Response, Standard and Extended Coverage Sprinklers

Pendent - (Standard Coverage SIN TY3281), (Extended Coverage SIN TY3282)
Horizontal Sidewall - (Standard Coverage SIN TY3381), (Extended Coverage SIN TY3382)

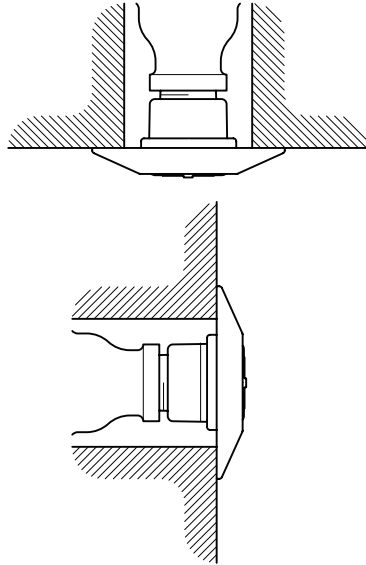

C.O.	Part Number	Finish	Coverage	Temperature	List Price
Pendent					
	50-314-9-165	Chrome	Standard	165°F (74°C)	\$65.75
	50-314-4-165	White Color	Standard	165°F (74°C)	\$65.75
	50-315-9-165	Chrome	Extended	165°F (74°C)	\$66.75
	50-315-4-165	White Color	Extended	165°F (74°C)	\$66.75
Horizontal Sidewall					
	50-316-9-165	Chrome	Standard	165°F (74°C)	\$78.75
	50-316-4-165	White Color	Standard	165°F (74°C)	\$78.75
	50-317-9-165	Chrome	Extended	165°F (74°C)	\$78.25
	50-317-4-165	White Color	Extended	165°F (74°C)	\$78.25
Order Escutcheon Separately					
	56-314-9-010	Chrome	Style F (3" Dia.)		\$19.75
	56-314-4-010	White Color	Style F (3" Dia.)		\$19.75
	56-312-9-010	Chrome	Style G (4" Dia.)		\$19.75
	56-312-4-010	White Color	Style G (4" Dia.)		\$19.75
Accessories					
	56-000-1-781	Centering Grommet – Model 1781			\$3.05
	56-000-1-780	Retaining Flange – Model 1780			\$36.50
	56-000-1-755	I-Series Adjustable Spacer Ring			\$0.40
Sprinkler Wrench					
	56-314-1-001	W-Type 25			\$148.50
Technical Data Sheet: TFP651					

Items marked "C.O." are made to order and may require longer delivery times. Please contact customer service for availability.

See latest Technical Data Sheets for specific Approvals, Listings, Design Parameters & available finishes. Sprinkler heads & escutcheons are priced separately unless otherwise noted.

Supersedes 1/20/2012

Section 1
Standard Spray Sprinklers

Section 2
Extended Coverage Sprinklers

Section 3
Storage Sprinklers

Section 4
Residential Products

Section 5
Dry Sprinklers

Section 6
Special Sprinklers

Section 7
Nozzles and Sprinkler Accessories

TFP PH2, K=5.6, Institutional Pendent, Standard Response Sprinkler

50 Box Quantity (33 lbs/box) (SIN TY3290)

	<i>C.O.</i>	<i>Pendent</i>	<i>Finish</i>	<i>Temperature</i>	<i>Price</i>	
<p>Escutcheon □ Style A</p> <p>Escutcheon □ Style B-1</p> <p>Escutcheon □ Style C</p>	▶	51-104-9-165	Chrome	165°F (74°C)	\$215.00	
	Order Escutcheon Separately					
			56-012-7-622	Type A, Chrome		\$20.75
			56-001-7-511	Type B-1, Chrome		\$20.75
			56-001-7-513	Type C, Chrome		\$20.75
	Accessories					
			56-000-1-781	Centering Grommet – Model 1781		\$3.05
			56-000-1-780	Retaining Flange – Model 1780		\$36.50
			56-000-1-752	Spacers		\$0.40
	Sprinkler Wrench					
			56-001-5-093	Model 1509-3		\$148.50
	Technical Data Sheet: TFP650					

Section 1
Standard Spray Sprinklers

Section 2
Extended Coverage Sprinklers

Section 3
Storage Sprinklers

Section 4
Residential Products

Section 5
Dry Sprinklers

Section 6
Special Sprinklers

Section 7
Nozzles and Sprinkler Accessories

See latest Technical Data Sheets for specific Approvals, Listings, Design Parameters & available finishes. Sprinkler heads & escutcheons are priced separately unless otherwise noted.

Items marked "C.O." are made to order and may require longer delivery times. Please contact customer service for availability.

TFP PH5, K=5.6, Institutional Horizontal Sidewall, Standard Response Sprinkler

50 Box Quantity (33 lbs/box) (SIN TY3390)

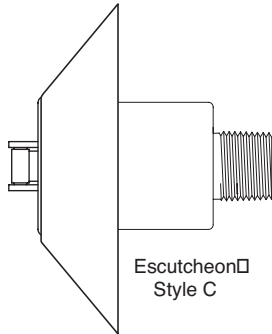
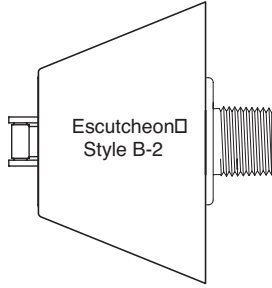
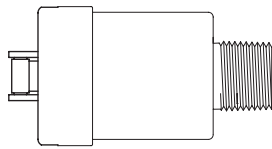

C.O.	Horizontal Sidewall	Finish	Temperature	Price
	51-106-9-165	Chrome	165°F (74°C)	\$215.00
Order Escutcheon Separately				
	56-001-7-512	Type B-2		\$20.75
	56-001-7-513	Type C, Chrome		\$20.75
Accessories				
	56-000-1-781	Centering Grommet – Model 1781		\$3.05
	56-000-1-780	Retaining Flange – Model 1780		\$36.50
	56-000-1-752	Spacers		\$0.40
Sprinkler Wrench				
	56-001-5-093	Model 1509-3		\$148.50

Technical Data Sheet: TFP654

Section 1
Standard Spray Sprinklers

Section 2
Extended Coverage Sprinklers

Section 3
Storage Sprinklers

Section 4
Residential Products

Section 5
Dry Sprinklers

Section 6
Special Sprinklers

Section 7
Nozzles and Sprinkler Accessories

Items marked "C.O." are made to order and may require longer delivery times. Please contact customer service for availability.

See latest Technical Data Sheets for specific Approvals, Listings, Design Parameters & available finishes. Sprinkler heads & escutcheons are priced separately unless otherwise noted.

TY-B, 5mm Bulb, K=5.6, 1/2" NPT Conventional (Old Style) Sprinklers *

100 Box Quantity (18 lbs/box) (SIN TY3651)

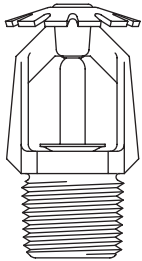
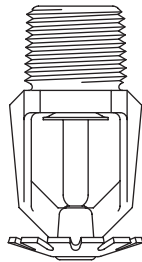
	<i>C.O.</i>	<i>Conventional</i>	<i>Finish</i>	<i>Temperature</i>	<i>List Price</i>
  <p>* Note: Updated design will replace existing sprinkler model beginning in March 2013. This transition will occur on a part-by-part basis. Specific temperatures and finishes will transition to the updated design once current inventory is depleted for the current sprinkler.</p>	▶	57-573-1-135	Brass	135°F (57°C)	\$21.50
		57-573-1-155	Brass	155°F (68°C)	\$21.50
	▶	57-573-1-175	Brass	175°F (79°C)	\$21.50
	▶	57-573-1-200	Brass	200°F (93°C)	\$21.50
		57-573-1-286	Brass	286°F (141°C)	\$21.50
	▶	57-573-1-360	Brass	360°F (182°C)	\$24.50
	▶	57-573-9-135	Chrome	135°F (57°C)	\$24.50
		57-573-9-155	Chrome	155°F (68°C)	\$24.50
	▶	57-573-9-175	Chrome	175°F (79°C)	\$24.50
	▶	57-573-9-200	Chrome	200°F (93°C)	\$24.50
	▶	57-573-9-286	Chrome	286°F (141°C)	\$24.50
	▶	57-573-9-360	Chrome	360°F (182°C)	\$27.50
	▶	57-573-4-135	Signal White (RAL 9003)	135°F (57°C)	\$24.50
		57-573-4-155	Signal White (RAL 9003)	155°F (68°C)	\$24.50
	▶	57-573-4-175	Signal White (RAL 9003)	175°F (79°C)	\$24.50
	▶	57-573-4-200	Signal White (RAL 9003)	200°F (93°C)	\$24.50
	▶	57-573-4-286	Signal White (RAL 9003)	286°F (141°C)	\$24.50
	▶	57-573-4-360	Signal White (RAL 9003)	360°F (182°C)	\$27.50
	▶	57-573-7-135	Lead Coated	135°F (57°C)	\$62.75
	▶	57-573-7-155	Lead Coated	155°F (68°C)	\$62.75
	▶	57-573-7-175	Lead Coated	175°F (79°C)	\$62.75
	▶	57-573-7-200	Lead Coated	200°F (93°C)	\$62.75
	▶	57-573-7-286	Lead Coated	286°F (141°C)	\$62.75
	▶	57-573-7-360	Lead Coated	360°F (182°C)	\$62.75
	▶	57-573-6-135	Wax Coated	135°F (57°C)	\$58.75
	▶	57-573-6-155	Wax Coated	155°F (68°C)	\$58.75
	▶	57-573-6-175	Wax Coated	175°F (79°C)	\$58.75
	▶	57-573-6-200	Wax Coated	200°F (93°C)	\$58.75
▶	57-573-6-286	Wax Coated	286°F (141°C)	\$58.75	
▶	57-573-8-135	Wax over Lead Coated	135°F (57°C)	\$83.25	
▶	57-573-8-155	Wax over Lead Coated	155°F (68°C)	\$83.25	
▶	57-573-8-175	Wax over Lead Coated	175°F (79°C)	\$83.25	
▶	57-573-8-200	Wax over Lead Coated	200°F (93°C)	\$83.25	
▶	57-573-8-286	Wax over Lead Coated	286°F (141°C)	\$83.25	
Sprinkler Wrench					
	56-000-6-387	W-Type 6 Wrench			\$51.25
Technical Data Sheet: TFP661					

Section 1
Standard Spray Sprinklers

Section 2
Extended Coverage Sprinklers

Section 3
Storage Sprinklers

Section 4
Residential Products

Section 5
Dry Sprinklers

Section 6
Special Sprinklers

Section 7
Nozzles and Sprinkler Accessories

See latest Technical Data Sheets for specific Approvals, Listings, Design Parameters & available finishes. Sprinkler heads & escutcheons are priced separately unless otherwise noted.

Items marked "C.O." are made to order and may require longer delivery times. Please contact customer service for availability.

TY-B, 5mm Bulb, K=8.0, 3/4" NPT Conventional (Old Style) Sprinklers

100 Box Quantity (21 lbs/box) (SIN TY4651)

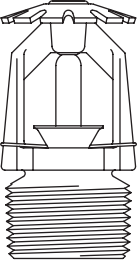
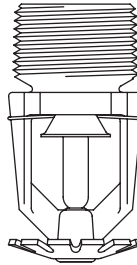
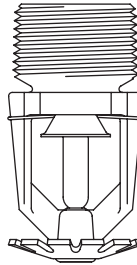
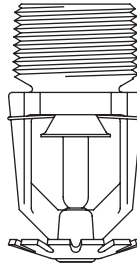
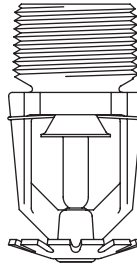
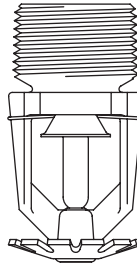
	C.O.	Conventional	Finish	Temperature	List Price
Section 1 Standard Spray Sprinklers		57-593-1-135	Brass	135°F (57°C)	\$24.00
		57-593-1-155	Brass	155°F (68°C)	\$24.00
		57-593-1-175	Brass	175°F (79°C)	\$24.00
		57-593-1-200	Brass	200°F (93°C)	\$24.00
		57-593-1-286	Brass	286°F (141°C)	\$24.00
		57-593-1-360	Brass	360°F (182°C)	\$26.75
Section 2 Extended Coverage Sprinklers		57-593-9-135	Chrome	135°F (57°C)	\$27.50
		57-593-9-155	Chrome	155°F (68°C)	\$27.50
		57-593-9-175	Chrome	175°F (79°C)	\$27.50
		57-593-9-200	Chrome	200°F (93°C)	\$27.50
		57-593-9-286	Chrome	286°F (141°C)	\$27.50
		57-593-9-360	Chrome	360°F (182°C)	\$31.25
Section 3 Storage Sprinklers		57-593-4-135	Signal White (RAL 9003)	135°F (57°C)	\$27.50
		57-593-4-155	Signal White (RAL 9003)	155°F (68°C)	\$27.50
		57-593-4-175	Signal White (RAL 9003)	175°F (79°C)	\$27.50
		57-593-4-200	Signal White (RAL 9003)	200°F (93°C)	\$27.50
		57-593-4-286	Signal White (RAL 9003)	286°F (141°C)	\$27.50
		57-593-4-360	Signal White (RAL 9003)	360°F (182°C)	\$31.25
Section 4 Residential Products		57-593-X-155	Jet Black (RAL 9005)	155°F (68°C)	\$71.75
		57-593-X-200	Jet Black (RAL 9005)	200°F (93°C)	\$71.75
		57-593-7-135	Lead Coated	135°F (57°C)	\$67.50
		57-593-7-155	Lead Coated	155°F (68°C)	\$67.50
		57-593-7-175	Lead Coated	175°F (79°C)	\$67.50
		57-593-7-200	Lead Coated	200°F (93°C)	\$67.50
Section 5 Dry Sprinklers		57-593-7-286	Lead Coated	286°F (141°C)	\$67.50
		57-593-7-360	Lead Coated	360°F (182°C)	\$67.50
		57-593-6-135	Wax Coated	135°F (57°C)	\$62.75
		57-593-6-155	Wax Coated	155°F (68°C)	\$62.75
		57-593-6-175	Wax Coated	175°F (79°C)	\$62.75
		57-593-6-200	Wax Coated	200°F (93°C)	\$62.75
Section 6 Special Sprinklers		57-593-6-286	Wax Coated	286°F (141°C)	\$62.75
		57-593-8-135	Wax over Lead Coated	135°F (57°C)	\$88.75
		57-593-8-155	Wax over Lead Coated	155°F (68°C)	\$88.75
		57-593-8-175	Wax over Lead Coated	175°F (79°C)	\$88.75
		57-593-8-200	Wax over Lead Coated	200°F (93°C)	\$88.75
		57-593-8-286	Wax over Lead Coated	286°F (141°C)	\$88.75
Sprinkler Wrench					
	56-000-6-387	W-Type 6 Wrench			\$51.25
Technical Data Sheet: TFP661					

Items marked "C.O." are made to order and may require longer delivery times. Please contact customer service for availability.

See latest Technical Data Sheets for specific Approvals, Listings, Design Parameters & available finishes. Sprinkler heads & escutcheons are priced separately unless otherwise noted.

Section 1
Standard Spray Sprinklers

Section 2
Extended Coverage Sprinklers

Section 3
Storage Sprinklers

Section 4
Residential Products

Section 5
Dry Sprinklers

Section 6
Special Sprinklers

Section 7
Nozzles and Sprinkler Accessories

TY-FRB, 3mm Bulb, Quick Response, K=5.6, 1/2" NPT Conventional (Old Style) Sprinklers *

100 Box Quantity (18 lbs/box) (SIN TY3631)

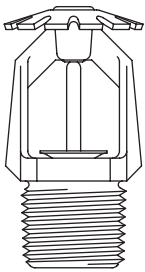
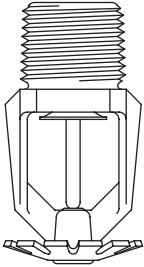
	<i>C.O.</i>	<i>Conventional</i>	<i>Finish</i>	<i>Temperature</i>	<i>List Price</i>
 	▶	57-373-1-135	Brass	135°F (57°C)	\$42.75
		57-373-1-155	Brass	155°F (68°C)	\$42.75
	▶	57-373-1-175	Brass	175°F (79°C)	\$42.75
	▶	57-373-1-200	Brass	200°F (93°C)	\$42.75
		57-373-1-286	Brass	286°F (141°C)	\$42.75
	▶	57-373-9-135	Chrome	135°F (57°C)	\$45.00
		57-373-9-155	Chrome	155°F (68°C)	\$45.00
	▶	57-373-9-175	Chrome	175°F (79°C)	\$45.00
	▶	57-373-9-200	Chrome	200°F (93°C)	\$45.00
	▶	57-373-9-286	Chrome	286°F (141°C)	\$45.00
	▶	57-373-4-135	Signal White (RAL 9003)	135°F (57°C)	\$45.00
		57-373-4-155	Signal White (RAL 9003)	155°F (68°C)	\$45.00
	▶	57-373-4-175	Signal White (RAL 9003)	175°F (79°C)	\$45.00
	▶	57-373-4-200	Signal White (RAL 9003)	200°F (93°C)	\$45.00
	▶	57-373-4-286	Signal White (RAL 9003)	286°F (141°C)	\$45.00
	▶	57-373-7-135	Lead Coated	135°F (57°C)	\$108.00
	▶	57-373-7-155	Lead Coated	155°F (68°C)	\$108.00
	▶	57-373-7-175	Lead Coated	175°F (79°C)	\$108.00
	▶	57-373-7-200	Lead Coated	200°F (93°C)	\$108.00
	▶	57-373-7-286	Lead Coated	286°F (141°C)	\$108.00
Sprinkler Wrench					
		56-000-6-387	W-Type 6 Wrench		\$51.25

*** Note:**

Updated design will replace existing sprinkler model beginning in March 2013. This transition will occur on a part-by-part basis. Specific temperatures and finishes will transition to the updated design once current inventory is depleted for the current sprinkler.

Technical Data Sheet: TFP666

Section 1	Standard Spray Sprinklers
Section 2	Extended Coverage Sprinklers
Section 3	Storage Sprinklers
Section 4	Residential Products
Section 5	Dry Sprinklers
Section 6	Special Sprinklers
Section 7	Nozzles and Sprinkler Accessories

See latest Technical Data Sheets for specific Approvals, Listings, Design Parameters & available finishes. Sprinkler heads & escutcheons are priced separately unless otherwise noted.

Items marked "C.O." are made to order and may require longer delivery times. Please contact customer service for availability.

TY-FRB, 3mm Bulb, Quick Response, K=8.0, 3/4" NPT Conventional (Old Style) Sprinklers

•100 Box Quantity (21 lbs/box) (SIN TY4631)

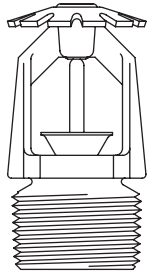
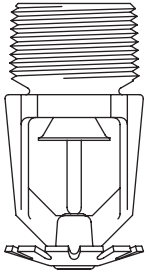
	<i>C.O.</i>	<i>Conventional</i>	<i>Finish</i>	<i>Temperature</i>	<i>List Price</i>
	▶	57-393-1-135	Brass	135°F (57°C)	\$48.00
		57-393-1-155	Brass	155°F (68°C)	\$48.00
	▶	57-393-1-175	Brass	175°F (79°C)	\$48.00
	▶	57-393-1-200	Brass	200°F (93°C)	\$48.00
		57-393-1-286	Brass	286°F (141°C)	\$48.00
	▶	57-393-9-135	Chrome	135°F (57°C)	\$52.00
		57-393-9-155	Chrome	155°F (68°C)	\$52.00
	▶	57-393-9-175	Chrome	175°F (79°C)	\$52.00
	▶	57-393-9-200	Chrome	200°F (93°C)	\$52.00
	▶	57-393-9-286	Chrome	286°F (141°C)	\$52.00
	▶	57-393-4-135	Signal White (RAL 9003)	135°F (57°C)	\$52.00
		57-393-4-155	Signal White (RAL 9003)	155°F (68°C)	\$52.00
	▶	57-393-4-175	Signal White (RAL 9003)	175°F (79°C)	\$52.00
	▶	57-393-4-200	Signal White (RAL 9003)	200°F (93°C)	\$52.00
	▶	57-393-4-286	Signal White (RAL 9003)	286°F (141°C)	\$52.00
	▶	57-393-X-155	Jet Black (RAL 9005)	155°F (68°C)	\$143.25
	▶	57-393-X-200	Jet Black (RAL 9005)	200°F (93°C)	\$143.25
	▶	57-393-7-135	Lead Coated	135°F (57°C)	\$122.00
	▶	57-393-7-155	Lead Coated	155°F (68°C)	\$122.00
	▶	57-393-7-175	Lead Coated	175°F (79°C)	\$122.00
▶	57-393-7-200	Lead Coated	200°F (93°C)	\$122.00	
▶	57-393-7-286	Lead Coated	286°F (141°C)	\$122.00	
Sprinkler Wrench					
		56-000-6-387	W-Type 6 Wrench		\$51.25

Technical Data Sheet: TFP666

Items marked "C.O." are made to order and may require longer delivery times. Please contact customer service for availability.

See latest Technical Data Sheets for specific Approvals, Listings, Design Parameters & available finishes. Sprinkler heads & escutcheons are priced separately unless otherwise noted.

Standard Spray Sprinklers	Section 1
Extended Coverage Sprinklers	Section 2
Storage Sprinklers	Section 3
Residential Products	Section 4
Dry Sprinklers	Section 5
Special Sprinklers	Section 6
Nozzles and Sprinkler Accessories	Section 7

Issue "D" Quartzoid® Series – High Temperature, K=5.6, 1/2" NPT, Special Sprinklers Issue D

100 Box Quantity (Upright 27.5 lbs/box (SIN TY3191), Pendent 27.5 lbs/box (SIN TY3296))

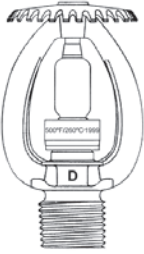
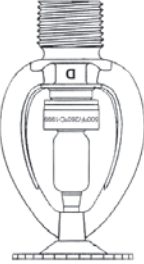
	<i>C.O.</i>	<i>Upright</i>	<i>Pendent</i>	<i>Finish</i>	<i>Temperature</i>	<i>List Price</i>
 	▶	51-036-1-400	51-040-1-400	Brass	400°F (204°C)	\$131.50
	▶	51-036-1-500	51-040-1-500	Brass	500°F (260°C)	\$131.50
	▶	51-036-1-650	51-040-1-650	Brass	650°F (343°C)	\$359.50
	▶	51-036-9-400	51-040-9-400	Chrome	500°F (260°C)	\$175.00
	▶	51-036-9-500	51-040-9-500	Chrome	500°F (260°C)	\$175.00
	▶	51-036-9-650	51-040-9-650	Chrome	650°F (343°C)	\$474.50
	▶	51-036-7-400	51-040-7-400	Lead Coated	400°F (204°C)	\$162.00
	▶	51-036-7-500	51-040-7-500	Lead Coated	500°F (260°C)	\$162.00
Sprinkler Wrench						
		56-452-1-001	W-Type 11 Wrench			\$31.00
<p>Note: All High Temperature Sprinklers are special ordered and are Non-Returnable. Please see "Terms & Conditions"</p> <p>Technical Data Sheet: TFP690</p>						

Section 1
Standard Spray Sprinklers

Section 2
Extended Coverage Sprinklers

Section 3
Storage Sprinklers

Section 4
Residential Products

Section 5
Dry Sprinklers

Section 6
Special Sprinklers

Section 7
Nozzles and Sprinkler Accessories

See latest Technical Data Sheets for specific Approvals, Listings, Design Parameters & available finishes. Sprinkler heads & escutcheons are priced separately unless otherwise noted.

Items marked "C.O." are made to order and may require longer delivery times. Please contact customer service for availability.

Issue "D" Quartzoid® Series – High Temperature, K=8.0, 3/4" NPT, Special Sprinklers Issue D

100 Box Quantity (Upright 27.5 lbs/box (SIN TY4191), Pendent 27.5 lbs/box (SIN TY4291))

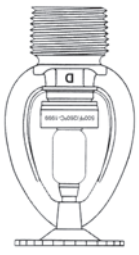
	C.O.	Upright	Pendent	Finish	Temperature	List Price
	▶	51-136-1-400	51-140-1-400	Brass	400°F (204°C)	\$175.00
	▶	51-136-1-500	51-140-1-500	Brass	500°F (260°C)	\$175.00
	▶	51-136-9-400	51-140-9-400	Chrome	400°F (204°C)	\$176.50
	▶	51-136-9-500	51-140-9-500	Chrome	500°F (260°C)	\$176.50
	▶	51-136-7-400	51-140-7-400	Lead Coated	400°F (204°C)	\$205.00
	▶	51-136-7-500	51-140-7-500	Lead Coated	500°F (260°C)	\$205.00
	▶	51-136-8-400	51-140-8-400	Wax over Lead Coated	400°F (204°C)	\$230.00
	▶	51-136-8-500	51-140-8-500	Wax over Lead Coated	500°F (260°C)	\$230.00
	Sprinkler Wrench					
		56-452-1-001	W-Type 11 Wrench			\$31.00
<p>Note: All High Temperature Sprinklers are special ordered and are Non-Returnable. Please see "Terms & Conditions"</p> <p>Technical Data Sheet: TFP690</p>						

Section 1
Standard Spray Sprinklers

Section 2
Extended Coverage Sprinklers

Section 3
Storage Sprinklers

Section 4
Residential Products

Section 5
Dry Sprinklers

Section 6
Special Sprinklers

Section 7
Nozzles and Sprinkler Accessories

Items marked "C.O." are made to order and may require longer delivery times. Please contact customer service for availability.

See latest Technical Data Sheets for specific Approvals, Listings, Design Parameters & available finishes. Sprinkler heads & escutcheons are priced separately unless otherwise noted.

TY-B, 5mm Bulb, K=5.6, 1/2" NPT Conventional (Old Style) Sprinklers (New Design*)

100 Box Quantity (18 lbs/box) (SIN TY365)

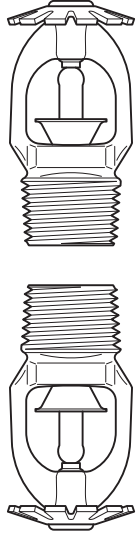
	<i>C.O.</i>	<i>Conventional</i>	<i>Finish</i>	<i>Temperature</i>	<i>List Price</i>
	▶	77-573-1-135	Brass	135°F (57°C)	\$21.50
		77-573-1-155	Brass	155°F (68°C)	\$21.50
	▶	77-573-1-175	Brass	175°F (79°C)	\$21.50
	▶	77-573-1-200	Brass	200°F (93°C)	\$21.50
		77-573-1-286	Brass	286°F (141°C)	\$21.50
	▶	77-573-1-360	Brass	360°F (182°C)	\$24.50
	▶	77-573-9-135	Chrome	135°F (57°C)	\$24.50
		77-573-9-155	Chrome	155°F (68°C)	\$24.50
	▶	77-573-9-175	Chrome	175°F (79°C)	\$24.50
	▶	77-573-9-200	Chrome	200°F (93°C)	\$24.50
	▶	77-573-9-286	Chrome	286°F (141°C)	\$24.50
	▶	77-573-9-360	Chrome	360°F (182°C)	\$27.50
	▶	77-573-4-135	Signal White (RAL 9003)	135°F (57°C)	\$24.50
		77-573-4-155	Signal White (RAL 9003)	155°F (68°C)	\$24.50
	▶	77-573-4-175	Signal White (RAL 9003)	175°F (79°C)	\$24.50
	▶	77-573-4-200	Signal White (RAL 9003)	200°F (93°C)	\$24.50
	▶	77-573-4-286	Signal White (RAL 9003)	286°F (141°C)	\$24.50
	▶	77-573-4-360	Signal White (RAL 9003)	360°F (182°C)	\$27.50
	▶	77-573-X-155	Jet Black (RAL 9005)	155°F (68°C)	\$64.25
	▶	77-573-X-200	Jet Black (RAL 9005)	200°F (93°C)	\$64.25
Sprinkler Wrench					
		56-000-6-387	W-Type 6 Wrench		\$51.25
Technical Data Sheet: TFP662					

***Note:**

Updated design will replace existing sprinkler model beginning in March 2013. This transition will occur on a part-by-part basis. Specific temperatures and finishes will transition to the updated design once current inventory is depleted for the current sprinkler.

Section 1	Standard Spray Sprinklers
Section 2	Extended Coverage Sprinklers
Section 3	Storage Sprinklers
Section 4	Residential Products
Section 5	Dry Sprinklers
Section 6	Special Sprinklers
Section 7	Nozzles and Sprinkler Accessories

See latest Technical Data Sheets for specific Approvals, Listings, Design Parameters & available finishes. Sprinkler heads & escutcheons are priced separately unless otherwise noted.

Items marked "C.O." are made to order and may require longer delivery times. Please contact customer service for availability.

**TY-FRB, 3mm Bulb, Quick Response, K=5.6, 1/2" NPT
Conventional (Old Style) Sprinklers (New Design*)**

100 Box Quantity (18 lbs/box) (SIN TY363)

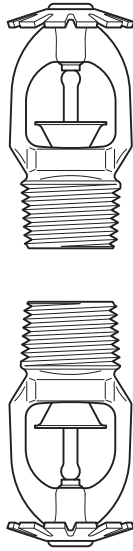

*** Note:**

Updated design will replace existing sprinkler model beginning in March 2013. This transition will occur on a part-by-part basis. Specific temperatures and finishes will transition to the updated design once current inventory is depleted for the current sprinkler.

C.O.	Conventional	Finish	Temperature	List Price
▶	77-373-1-135	Brass	135°F (57°C)	\$42.75
	77-373-1-155	Brass	155°F (68°C)	\$42.75
▶	77-373-1-175	Brass	175°F (79°C)	\$42.75
▶	77-373-1-200	Brass	200°F (93°C)	\$42.75
	77-373-1-286	Brass	286°F (141°C)	\$42.75
▶	77-373-9-135	Chrome	135°F (57°C)	\$45.00
	77-373-9-155	Chrome	155°F (68°C)	\$45.00
▶	77-373-9-175	Chrome	175°F (79°C)	\$45.00
▶	77-373-9-200	Chrome	200°F (93°C)	\$45.00
▶	77-373-9-286	Chrome	286°F (141°C)	\$45.00
▶	77-373-4-135	Signal White (RAL 9003)	135°F (57°C)	\$45.00
	77-373-4-155	Signal White (RAL 9003)	155°F (68°C)	\$45.00
▶	77-373-4-175	Signal White (RAL 9003)	175°F (79°C)	\$45.00
▶	77-373-4-200	Signal White (RAL 9003)	200°F (93°C)	\$45.00
▶	77-373-4-286	Signal White (RAL 9003)	286°F (141°C)	\$45.00
▶	77-373-X-155	Jet Black (RAL 9005)	155°F (68°C)	\$127.75
▶	77-373-X-200	Jet Black (RAL 9005)	200°F (93°C)	\$127.75
Sprinkler Wrench				
	56-000-6-387	W-Type 6 Wrench		\$51.25
Technical Data Sheet: TFP667				

Section 1
Standard Spray Sprinklers

Section 2
Extended Coverage Sprinklers

Section 3
Storage Sprinklers

Section 4
Residential Products

Section 5
Dry Sprinklers

Section 6
Special Sprinklers

Section 7
Nozzles and Sprinkler Accessories

Items marked "C.O." are made to order and may require longer delivery times. Please contact customer service for availability.

See latest Technical Data Sheets for specific Approvals, Listings, Design Parameters & available finishes. Sprinkler heads & escutcheons are priced separately unless otherwise noted.

Protectospray Nozzles Model D-3
Orifice Size #16 to #34 Inclusive with 1/2" NPT Connection, Brass

Protectospray Nozzles

Protectospray Nozzles are available as open nozzles (D Series) or as a bulb type nozzle (EA-1 Series). Both types are available with deflectors designed to produce discharge patterns having included angles of : 65, 80, 95, 110, 125, 140, 160 and 180 degree

49 – 3XX – X – XXX

ORIFICE		FINISH & MATERIAL		ANGLE	
16	.206" (1/2" NPT)	1	PLAIN BRONZE	065	65
18	.250" (1/2" NPT)	7	LEADED COATED BRONZE	080	80
21	.281" (1/2" NPT)	4	TEFLON COATED BRONZE	095	95
24	.328" (1/2" NPT)	9	CHROME PLATED BRONZE	110	110
28	.375" (1/2" NPT)	0	PLAIN STAINLESS STEEL 1/2" NPT only.	125	125
32	.438" (1/2" NPT)			140	140
34	.500" (1/2" NPT)			160	160
				180	180

Orifice size of "D" Series nozzles is by numerical designations with decimal inch equivalents. Product Symbol Numbers for D Series nozzles can be developed by using the table show above. All discharge spray pattern, orifice sizes, materials and finishes as follows:

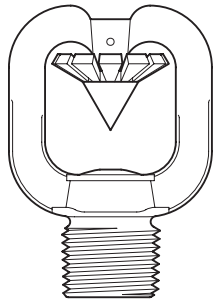

Nozzle	Finish	List Price
49-3XX-1-XXX	Plain Bronze	\$111.00
49-3XX-7-XXX	Lead Coated Bronze*	\$137.00
49-3XX-4-XXX	Teflon Coated Bronze*	\$266.00
49-3XX-9-XXX	Chrome Plated Bronze	\$133.50
49-3XX-0-XXX	Stainless Steel	\$483.50
Sprinkler Wrench		
56-452-1-001	W-Type 11 Wrench	\$31.00
Notes		
6012	*Special Order Lead or Teflon coating subject to set-up charge. (Net Price)	\$376.50

Note: All Protectospray Nozzles are special ordered and are Non-Returnable. Please see "Terms & Conditions"

Technical Data Sheet: TFP802

See latest Technical Data Sheets for specific Approvals, Listings, Design Parameters & available finishes. Sprinkler heads & escutcheons are priced separately unless otherwise noted.

Items marked "C.O." are made to order and may require longer delivery times. Please contact customer service for availability.

Section 1
Standard Spray Sprinklers

Section 2
Extended Coverage Sprinklers

Section 3
Storage Sprinklers

Section 4
Residential Products

Section 5
Dry Sprinklers

Section 6
Special Sprinklers

Section 7
Nozzles and Sprinkler Accessories

Protectospray Nozzles, Model EA-1

49 - XXX - X - XXX

ORIFICE		ANGLE		FINISH & MATERIAL		TEMPERATURE		C.O.
9	1/2" (1/2" NPT)	65	65°	1	PLAIN 135° thru 500°	135	135°F	
8	3/8" (1/2" NPT)	80	80°	7	LEADED COATED 135° thru 325°	175	175°F	
7	1/4" (1/2" NPT)	95	95°	9	CHROME PLATED 135° thru 325°	250	250°F	
		10	110°	6	WAX COATED 135° & 175° only.	325	325°F	
		25	125°					
		40	140°					
		60	160°					
		81	180°					

Plain Finish Only		
400	400°F	▶
500	500°F	▶

Product Symbol Numbers for Model EA-1 Protectospray Nozzles can be determined by using the following table.

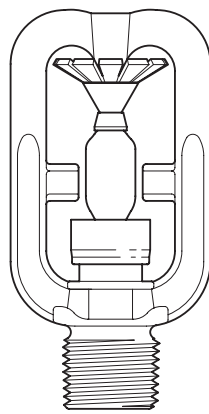

Note: All Protectospray Nozzles are special ordered and are Non-Returnable. Please see "Terms & Conditions"

Nozzle	Finish	List Price
1/2" Protectospray Nozzles Model EA-1		
49-9XX-1-XXX	Plain (135° - 325°)	\$256.50
49-9XX-1-400	Plain (Only)	\$459.50
49-9XX-1-500	Plain (Only)	\$460.50
49-9XX-7-XXX	Lead Coated *	\$331.00
49-9XX-9-XXX	Chrome Plated	\$352.00
49-9XX-6-XXX	Wax Coated	\$321.00
1/4" Protectospray Nozzles Model EA-1		
49-7XX-1-XXX	Plain (135° - 325°)	\$335.00
49-7XX-1-400	Plain (Only)	\$600.50
49-7XX-1-500	Plain (Only)	\$600.50
49-7XX-7-XXX	Lead Coated *	\$415.50
49-7XX-9-XXX	Chrome Plated	\$462.50
49-7XX-6-XXX	Wax Coated	\$396.50
3/8" Protectospray Nozzles Model EA-1		
49-8XX-1-XXX	Plain (135° - 325°)	\$324.50
49-8XX-1-400	Plain (Only)	\$579.00
49-8XX-1-500	Plain (Only)	\$579.00
49-8XX-7-XXX	Lead Coated *	\$396.50
49-8XX-9-XXX	Chrome Plated	\$439.50
49-8XX-6-XXX	Wax Coated	\$384.50
Sprinkler Wrench		
56-452-1-001	W-Type 11 Wrench	\$31.00
Notes		
Temperatures of 400° F & 500° F Available in Plain Finish Only		
6012	*Special Order Lead coating subject to set-up charge. (Net Price)	\$376.50
Technical Data Sheet: TFP 800		

Items marked "C.O." are made to order and may require longer delivery times. Please contact customer service for availability.

See latest Technical Data Sheets for specific Approvals, Listings, Design Parameters & available finishes. Sprinkler heads & escutcheons are priced separately unless otherwise noted.

Mulsifyre Nozzles, 800 Series, 3/4" NPT Connection

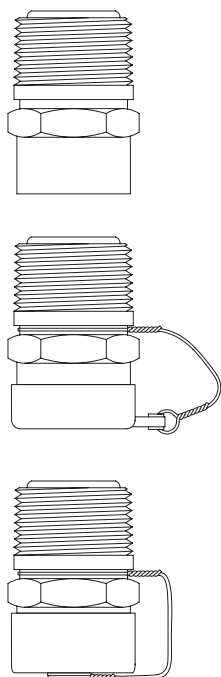
	Nozzle	Description	List Price
 <p>Note: All Mulsifyre Nozzles are special ordered and are Non-Returnable. Please see "Terms & Conditions"</p>	Without Blow-Off Cap		
	49-800-1-822	Model F822	\$138.50
	49-800-1-824	Model F824	\$138.50
	49-800-1-826	Model F826	\$138.50
	49-800-1-828	Model F828	\$138.50
	49-800-1-832	Model F832	\$138.50
	49-800-1-834	Model F834	\$138.50
	With Dust Cap		
	49-801-1-822	Model F822	\$187.50
	49-801-1-824	Model F824	\$187.50
	49-801-1-826	Model F826	\$187.50
	49-801-1-828	Model F828	\$187.50
	49-801-1-832	Model F832	\$187.50
	49-801-1-834	Model F834	\$187.50
	With Blow-Off Cap		
	49-802-1-822	Model F822B	\$480.50
	49-802-1-824	Model F824B	\$480.50
	49-802-1-826	Model F826B	\$480.50
	49-802-1-828	Model F828B	\$480.50
	49-802-1-832	Model F832B	\$480.50
	49-802-1-834	Model F834B	\$480.50
Technical Data Sheet: TFP810			

Section 1
Standard Spray Sprinklers

Section 2
Extended Coverage Sprinklers

Section 3
Storage Sprinklers

Section 4
Residential Products

Section 5
Dry Sprinklers

Section 6
Special Sprinklers

Section 7
Nozzles and Sprinkler Accessories

High Velocity Spray Nozzles Type HV

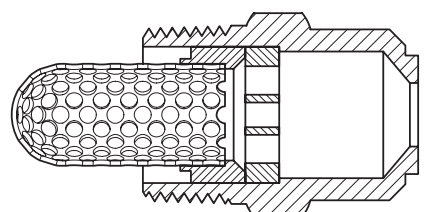
	Nozzle	Description	Finish	List Price	
 <p>Note: All High Velocity Spray Nozzles are special ordered and are Non-Returnable. Please see "Terms & Conditions"</p>	49-014-1-001	HV 14	Brass	\$193.00	
	49-017-1-001	HV 17	Brass	\$238.00	
	49-026-1-001	HV 26	Brass	\$238.00	
	49-037-1-001	HV 37	Brass	\$238.00	
	49-045-1-001	HV 45	Brass	\$238.00	
	49-060-1-001	HV 60	Brass	\$226.00	
	49-014-0-001	HV 14	Stainless Steel	\$552.00	
	49-017-0-001	HV 17	Stainless Steel	\$552.00	
	49-026-0-001	HV 26	Stainless Steel	\$552.00	
	49-037-0-001	HV 37	Stainless Steel	\$552.00	
	49-045-0-001	HV 45	Stainless Steel	\$552.00	
	49-060-0-001	HV 60	Stainless Steel	\$552.00	
	Technical Data Sheet: TFP 815				

See latest Technical Data Sheets for specific Approvals, Listings, Design Parameters & available finishes. Sprinkler heads & escutcheons are priced separately unless otherwise noted.

Items marked "C.O." are made to order and may require longer delivery times. Please contact customer service for availability.

3/4" NPT, K=2.90, Open Nozzle for Cooling Towers, Type 1 and Type 2

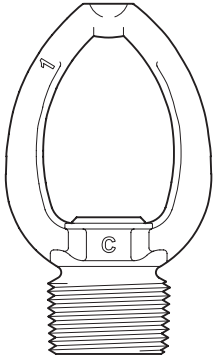

Nozzle	Type, Finish	List Price
50-081-1-000	Type 1, Bronze	\$142.00
50-081-0-001	Type 1, Stainless Steel	\$189.00
50-082-1-001	Type 2, Bronze	\$142.00
50-082-0-001	Type 2, Stainless Steel	\$189.00
Sprinkler Wrench		
56-452-1-001	W-Type 11 Wrench	\$31.00

Technical Data Sheet: TFP830

Model A and Model B, 1/2" NPT, Exposure Nozzles

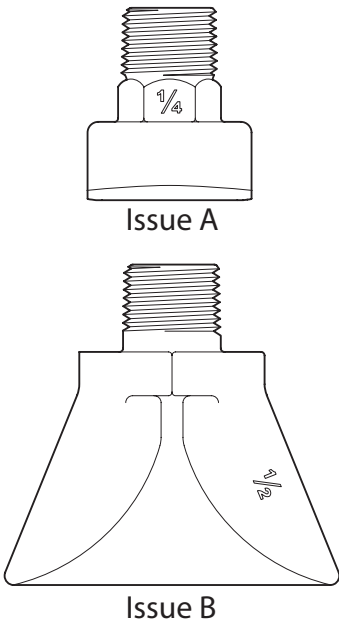

49 - XXX - X - XXX

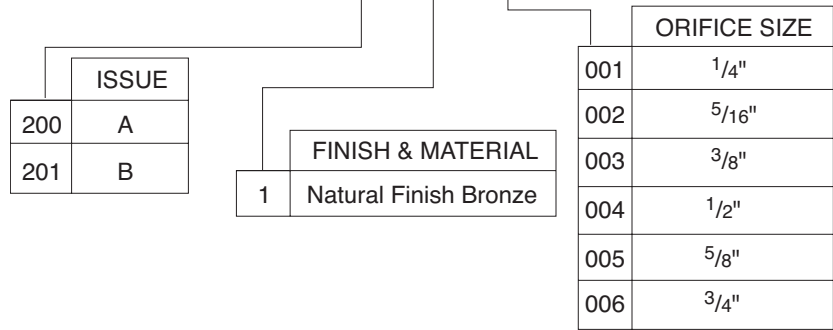

Exposure Sprinkler	Orifice, Finish	List Price
49-200-1-XXX	Issue A, Natural Bronze	\$165.00
49-201-1-XXX	Issue B, Natural Bronze	\$218.50

Technical Data Sheet: TFP 835

Items marked "C.O." are made to order and may require longer delivery times. Please contact customer service for availability.

See latest Technical Data Sheets for specific Approvals, Listings, Design Parameters & available finishes. Sprinkler heads & escutcheons are priced separately unless otherwise noted.

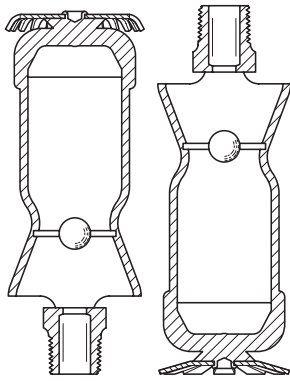
Model B-1, 1/2" Foam Water Sprinkler, 1/2" Male NPT			
	Nozzle	Orientation	List Price
	49-210-1-001	Upright	\$395.00
	49-211-1-001	Pendent	\$413.00
Technical Data Sheet: TFP 840			

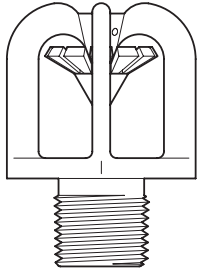
U.S. Navy Nozzle Type G, 1/2" NPT			
	Nozzle	Finish	List Price
	49-554-1-328	Bronze, Type G	\$423.50
<p>Note: All Nozzles are special ordered and are Non-Returnable. Please see "Terms & Conditions"</p>			
Technical Data Sheet: TFP 820			

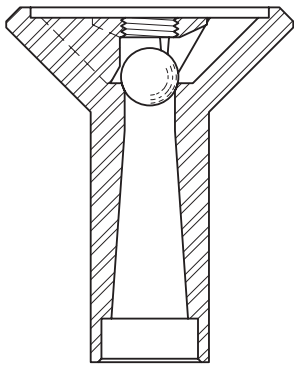
U.S. Navy Nozzle Type SB, 1/2" NPT			
	Nozzle	Finish	List Price
	49-556-1-012	Stainless Steel, Type SB	\$766.50
	Type SB Replacement Kits:		
	91-556-1-001	Stainless Steel Kit	\$362.00
	91-556-1-004	Threaded Insert Installation Tool	\$142.50
<p>Note: All Nozzles are special ordered and are Non-Returnable. Please see "Terms & Conditions"</p>			
Technical Data Sheet: TFP 825			

Section 1
Standard Spray Sprinklers

Section 2
Extended Coverage Sprinklers

Section 3
Storage Sprinklers

Section 4
Residential Products

Section 5
Dry Sprinklers

Section 6
Special Sprinklers

Section 7
Nozzles and Sprinkler Accessories

See latest Technical Data Sheets for specific Approvals, Listings, Design Parameters & available finishes. Sprinkler heads & escutcheons are priced separately unless otherwise noted.

Items marked "C.O." are made to order and may require longer delivery times. Please contact customer service for availability.

Section 1
Standard Spray Sprinklers

Section 2
Extended Coverage Sprinklers

Section 3
Storage Sprinklers

Section 4
Residential Products

Section 5
Dry Sprinklers

Section 6
Special Sprinklers

Section 7
Nozzles and Sprinkler Accessories

Protectospray Nozzle, Type D4-a, 1/2" NPT

49 - 4XX - X - XXX

ORIFICE		SPRAY ANGLE	
16	No. 16	065	65°
18	No. 18	080	80°
21	No. 21	095	95°
24	No. 24	110	110°
28	No. 28	125	125°
32	No. 32	140	140°
34	No. 34	160	160°
		180	180°

FINISH & MATERIAL	
1	Natural Finish Bronze
4	Teflon Coated Bronze

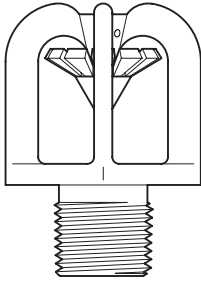

Nozzle	Finish	List Price
49-4XX-1-XXX	Natural Bronze	\$451.00
49-4XX-4-XXX	Teflon Coated Bronze *	\$643.00
Notes		
6012	*Special Order Teflon coating subject to set-up charge. (Net Price)	\$376.50
Note: All Nozzles are special ordered and are Non-Returnable. Please see "Terms & Conditions"		
Technical Data Sheet: TFP 806		

Type AM4 WaterMist Nozzles, Open Bulb Type, 1/2" NPT

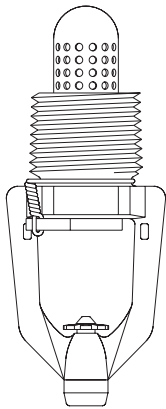

Nozzle	Finish	List Price
49-204-0-001	Stainless Steel	POA
49-204-0-011	Stainless Steel W/Dust Cap	POA
Replacement Parts		
56-885-0-001	Replacement Model F885 Dust Cap	\$69.00
Note: All Nozzles are special ordered and are Non-Returnable. Please see "Terms & Conditions"		
Technical Data Sheet: TFP 2204		

Items marked "C.O." are made to order and may require longer delivery times. Please contact customer service for availability.

See latest Technical Data Sheets for specific Approvals, Listings, Design Parameters & available finishes. Sprinkler heads & escutcheons are priced separately unless otherwise noted.

Type AM6, WaterMist Nozzles, Bulb Type, 1/2" NPT

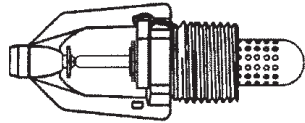

Note: All Nozzles are special ordered and are Non-Returnable. Please see "Terms & Conditions"

Nozzle	Finish	Temperature	List Price
49-206-1-135	Brass	135°F (57°C)	POA
49-206-4-135	White	135°F (57°C)	POA
49-206-9-135	Chrome	135°F (57°C)	POA
49-206-0-135	Stainless Steel	135°F (57°C)	POA
49-206-1-155	Brass	155°F (68°C)	POA
49-206-4-155	White	155°F (68°C)	POA
49-206-9-155	Chrome	155°F (68°C)	POA
49-206-0-155	Stainless Steel	155°F (68°C)	POA
49-206-1-175	Brass	175°F (79°C)	POA
49-206-4-175	White	175°F (79°C)	POA
49-206-9-175	Chrome	175°F (79°C)	POA
49-206-0-175	Stainless Steel	175°F (79°C)	POA
49-206-1-200	Brass	200°F (93°C)	POA
49-206-4-200	White	200°F (93°C)	POA
49-206-9-200	Chrome	200°F (93°C)	POA
49-206-0-200	Stainless Steel	200°F (93°C)	POA
Technical Data Sheet: GEM TD 1170			

Section 1
Standard Spray Sprinklers

Section 2
Extended Coverage Sprinklers

Section 3
Storage Sprinklers

Type AM10 WaterMist Nozzles, Open Type, 1/2" NPT

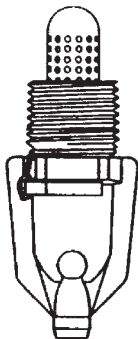

Nozzle	Finish	List Price
49-207-0-001	Stainless Steel	POA
49-207-0-011	Stainless Steel w/Dust Cap	POA
Replacement Parts		
56-885-0-001	Replacement Model F885 Dust Cap	\$69.00
Note: All Nozzles are special ordered and are Non-Returnable. Please see "Terms & Conditions"		
Technical Data Sheet: GEM TD1174		

Section 4
Residential Products

Section 5
Dry Sprinklers

Section 6
Special Sprinklers

Section 7
Nozzles and Sprinkler Accessories

See latest Technical Data Sheets for specific Approvals, Listings, Design Parameters & available finishes. Sprinkler heads & escutcheons are priced separately unless otherwise noted.

Items marked "C.O." are made to order and may require longer delivery times. Please contact customer service for availability.

Type AM11 WaterMist Nozzles, Bulb Type, 1/2" NPT

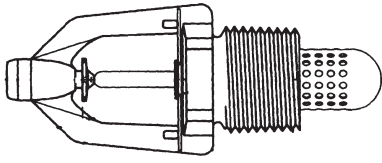

Note: All Nozzles are special ordered and are Non-Returnable. Please see "Terms & Conditions"

Nozzle	Finish	Temperature	List Price
49-208-1-135	Brass	135°F (57°C)	POA
49-208-4-135	White	135°F (57°C)	POA
49-208-9-135	Chrome	135°F (57°C)	POA
49-208-1-155	Brass	155°F (68°C)	POA
49-208-4-155	White	155°F (68°C)	POA
49-208-9-155	Chrome	155°F (68°C)	POA
49-208-1-175	Brass	175°F (79°C)	POA
49-208-4-175	White	175°F (79°C)	POA
49-208-9-175	Chrome	175°F (79°C)	POA
49-208-1-200	Brass	200°F (93°C)	POA
49-208-4-200	White	200°F (93°C)	POA
49-208-9-200	Chrome	200°F (93°C)	POA

Type AM22 WaterMist Nozzles, Bulb Type, 1/2" NPT

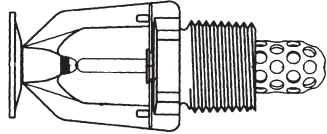

Note: All Nozzles are special ordered and are Non-Returnable. Please see "Terms & Conditions"

Nozzle	Finish	Temperature	List Price
49-209-1-135	Brass	135°F (57°C)	POA
49-209-4-135	White	135°F (57°C)	POA
49-209-9-135	Chrome	135°F (57°C)	POA
49-209-1-155	Brass	155°F (68°C)	POA
49-209-4-155	White	155°F (68°C)	POA
49-209-9-155	Chrome	155°F (68°C)	POA
49-209-1-175	Brass	175°F (79°C)	POA
49-209-4-175	White	175°F (79°C)	POA
49-209-9-175	Chrome	175°F (79°C)	POA
49-209-1-200	Brass	200°F (93°C)	POA
49-209-4-200	White	200°F (93°C)	POA
49-209-9-200	Chrome	200°F (93°C)	POA

Items marked "C.O." are made to order and may require longer delivery times. Please contact customer service for availability.

See latest Technical Data Sheets for specific Approvals, Listings, Design Parameters & available finishes. Sprinkler heads & escutcheons are priced separately unless otherwise noted.

Section 1
Standard Spray Sprinklers

Section 2
Extended Coverage Sprinklers

Section 3
Storage Sprinklers

Section 4
Residential Products

Section 5
Dry Sprinklers

Section 6
Special Sprinklers

Section 7
Nozzles and Sprinkler Accessories

Type AM24 WaterMist Nozzles, Bulb Type, 1/2" NPT

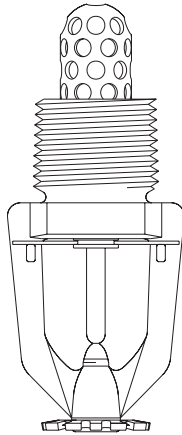

Note: All Nozzles are special ordered and are Non-Returnable. Please see "Terms & Conditions"

Nozzle	Finish	List Price
49-210-1-135	Brass	POA
49-210-4-135	White	POA
49-210-9-135	Chrome	POA
49-210-1-155	Brass	POA
49-210-4-155	White	POA
49-210-9-155	Chrome	POA
49-210-1-175	Brass	POA
49-210-4-175	White	POA
49-210-9-175	Chrome	POA
49-210-1-200	Brass	POA
49-210-4-200	White	POA
49-210-9-200	Chrome	POA

Technical Data Sheet: GEM TD 1172

Note: For ISO Connection, Replace (210) In Order Sequence With (220)

**Pilot Sprinkler Model FTR-1 Fixed Temperature Release, 1/2" NPT
For Deluge and Preaction Systems Wet or Dry Pilot Release Service
(SIN TY3030)**

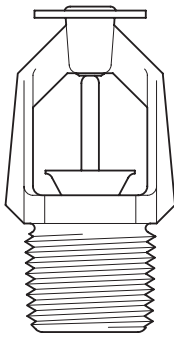

Nozzle	Finish	Temperature	List Price
51-041-1-135	Brass	135°F (57°C)	\$29.00
51-041-4-135	Signal White (RAL 9003)	135°F (57°C)	\$32.25
51-041-3-135	Teflon	135°F (57°C)	\$57.25
51-041-1-155	Brass	155°F (68°C)	\$29.00
51-041-4-155	Signal White (RAL 9003)	155°F (68°C)	\$32.25
51-041-3-155	Teflon	155°F (68°C)	\$57.25
51-041-1-175	Brass	175°F (79°C)	\$29.00
51-041-4-175	Signal White (RAL 9003)	175°F (79°C)	\$32.25
51-041-3-175	Teflon	175°F (79°C)	\$57.25
51-041-1-200	Brass	200°F (93°C)	\$29.00
51-041-4-200	Signal White (RAL 9003)	200°F (93°C)	\$32.25
51-041-3-200	Teflon	200°F (93°C)	\$57.25

Sprinkler Wrench

56-000-6-387	W-Type 6 Wrench	\$51.25
--------------	-----------------	---------

Technical Data Sheet: TFP1388

Nozzle Accessories - Blow-Off Caps and Dust Caps for Mulsifyre Projectors and Nozzles

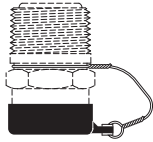

C.O.	Part No.	Description	List Price
	56-802-1-001	Blow-Off Caps for Models F822B through F834B	\$35.75
	56-880-1-001	Dust Caps for Models F822 through F834	\$22.00
	56-885-0-001	Blow-Off Dust Caps with Wire	\$69.00

Technical Data Sheet: TFP810

Blow-Off Plugs for Protectospray Nozzles Model D-3

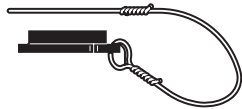

C.O.	Part Number	Description	List Price
	56-320-1-001	Blow Off Plug/Wire D-3 "A" (16)	\$28.50
	56-320-1-004	Blow Off Plug/Wire D-3 "D" (34)	\$28.50
	56-320-1-005	Blow Off Plug/Wire D-3 "E" (32) (1/2" for TY-B Sprinklers)	\$28.50
	56-320-1-006	Blow Off Plug/Wire D-3 "H" (28)	\$28.50
	56-320-1-007	Blow Off Plug/Wire D-3 "I" (24)	\$28.50
	56-320-1-008	Blow Off Plug/Wire D-3 "J" (21)	\$28.50
	56-320-1-009	Blow Off Plug/Wire D-3 "K" (18)	\$28.50
	56-320-1-010	Blow Off Plug/Wire "N" (17/32")	\$28.50

Technical Data Sheet: TFP890

Miscellaneous Flush Escutcheons



C.O.	Part Number	Description	List Price
Model 65 Flat Escutcheons			
▶	1150	1/2" Flat Escutcheon-Brass	\$5.50
▶	1184	3/4" Flat Escutcheon-Brass	\$5.50
	1153	1/2" Flat Escutcheon-Chrome	\$2.00
	1152	3/4" Flat Escutcheon-Chrome	\$2.00
	1174	1/2" Flat Escutcheon-White	\$4.60
	1175	3/4" Flat Escutcheon-White	\$4.60

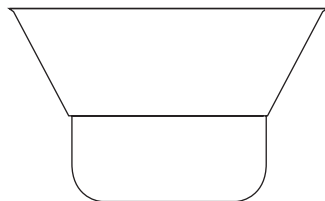

C.O.	Part Number	Description	List Price
Model 401 2-Piece Adjustable Extended Escutcheons			
	1192	1/2" Cup for 2 pc. Escutcheon-Chrome	\$2.70
	1193	3/4" Cup for 2 pc. Escutcheon-Chrome	\$2.70
	1198	Skirt for 2 pc. Escutcheon-Chrome	\$2.70
▶	1194	1/2" Cup for 2 pc. Escutcheon-Brass	\$3.05
▶	1195	3/4" Cup for 2 pc. Escutcheon-Brass	\$3.05
▶	1199	Skirt for 2 pc. Escutcheon-Brass	\$3.05
	1196	1/2" Cup for 2 pc. Escutcheon-White	\$3.05
	1197	3/4" Cup for 2 pc. Escutcheon-White	\$3.05
	1200	Skirt for 2 pc. Escutcheon-White	\$3.05

Technical Data Sheet: TFP777

Items marked "C.O." are made to order and may require longer delivery times. Please contact customer service for availability.

See latest Technical Data Sheets for specific Approvals, Listings, Design Parameters & available finishes. Sprinkler heads & escutcheons are priced separately unless otherwise noted.

Supersedes 1/20/2012

Typical Escutcheons

	C.O.	Part Number	Description	List Price
	Recessed Escutcheons Style 10, 1/2" NPT (Order Separately)			
	▶	56-701-2-010	1/2" Brass Plated (Style 10)	\$9.50
		56-701-9-010	1/2" Chrome Plated (Style 10)	\$6.55
		56-701-4-010	1/2" Signal White (RAL 9003) (Style 10)	\$6.55
		56-701-6-010	1/2" Jet Black (RAL 9005) (Style 10)	\$8.55
		56-701-0-010	1/2" Stainless Steel (Style 10) with White Paint Finish	\$18.50
	Recessed Escutcheons Style 15, 1/2" NPT (Order Separately)			
	▶	56-715-2-010	1/2" Brass Plated (Style 15)	\$9.50
		56-715-9-010	1/2" Chrome Plated (Style 15)	\$6.55
		56-715-4-010	1/2" Signal White (RAL 9003) (Style 15)	\$6.55
		56-715-6-010	1/2" Jet Black (RAL 9005) (Style 15)	\$8.55
		56-715-0-010	1/2" Stainless Steel (Style 15) with White Paint Finish	\$18.00
	Recessed Escutcheons Style 20, 1/2" NPT (Order Separately)			
	▶	56-705-2-010	1/2" Brass Plated (Style 20)	\$9.50
		56-705-9-010	1/2" Chrome Plated (Style 20)	\$6.55
		56-705-4-010	1/2" Signal White (RAL 9003) (Style 20)	\$6.55
		56-705-6-010	1/2" Jet Black (RAL 9005) (Style 20)	\$8.55
		56-705-0-010	1/2" Stainless Steel (Style 20) with White Paint Finish	\$17.00
	Recessed Escutcheons Style 30, 3/4" NPT (Order Separately)			
	▶	56-705-2-011	3/4" Brass Plated (Style 30)	\$9.50
		56-705-9-011	3/4" Chrome Plated (Style 30)	\$6.85
		56-705-4-011	3/4" Signal White (RAL 9003) Recessed (Style 30)	\$6.85
		56-705-6-011	3/4" Jet Black (RAL 9005) Recessed (Style 30)	\$8.70
		56-705-0-011	3/4" Stainless Steel (Style 30) with White Paint Finish	\$17.00
	Recessed Escutcheons Style 40, 3/4" NPT (Order Separately)			
	▶	56-700-2-010	3/4" Brass Plated (Style 40)	\$9.50
		56-700-9-010	3/4" Chrome Plated (Style 40)	\$6.85
		56-700-4-010	3/4" Signal White (RAL 9003) Recessed (Style 40)	\$6.85
	56-700-6-010	3/4" Jet Black (RAL 9005) Recessed (Style 40)	\$8.70	
	56-700-0-010	3/4" Stainless Steel (Style 40) with White Paint Finish	\$18.50	
Recessed Escutcheons Style 50, 1/2" NPT (Order Separately)				
	56-711-2-010	1/2" Brass Plated (Style 50)	\$9.50	
	56-711-9-010	1/2" Chrome Plated (Style 50)	\$6.55	
	56-711-4-010	1/2" Signal White (RAL 9003) Recessed (Style 50)	\$6.55	
	56-711-6-010	1/2" Jet Black (RAL 9005) Recessed (Style 50)	\$8.55	
	56-711-0-010	1/2" Stainless Steel (Style 50) with White Paint Finish	\$17.00	
Two-Piece Flush Escutcheons Style 60, 3/4" NPT (Order Separately)				
	208107	3/4" Brass Plated (Style 60)	\$9.50	
	208102	3/4" Chrome Plated (Style 60)	\$6.85	
	208104	3/4" White (Style 60)	\$6.85	
Protective Cover (Order Separately)				
	100-25-700	Plastic Cap Protective Cover for FR II Disposable Cover	\$2.65	
Technical Data Sheet: Style 10 thru 50 TFP770, Style 60 TFP778				

Section 1
Standard Spray Sprinklers

Section 2
Extended Coverage Sprinklers

Section 3
Storage Sprinklers

Section 4
Residential Products

Section 5
Dry Sprinklers

Section 6
Special Sprinklers

Section 7
Nozzles and Sprinkler Accessories

See latest Technical Data Sheets for specific Approvals, Listings, Design Parameters & available finishes. Sprinkler heads & escutcheons are priced separately unless otherwise noted.

Items marked "C.O." are made to order and may require longer delivery times. Please contact customer service for availability.

Section 1
Standard Spray Sprinklers

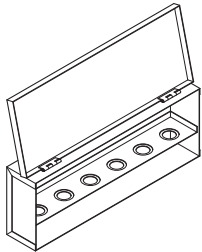
Sprinkler Head Cabinets				
	<i>C.O.</i>	<i>Part Number</i>	<i>Description</i>	<i>List Price</i>
		1177	3 - Head Cabinet	\$25.25
		1119	6 - Head Cabinet	\$42.50
		1124	12 - Head Cabinet	\$42.50
		1111	6 - ESFR Head Cabinet	\$64.00
Technical Data Sheet: TFP785				

Section 2
Extended Coverage Sprinklers

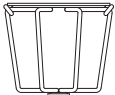
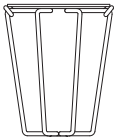
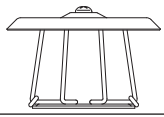
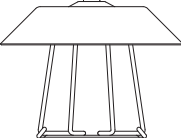
G1 and G4 Sprinkler Guards G1/S1 and G4/S3 Guards and Shields (For Series TY-B, TY-FRB, TY-L and TY-FRL Sprinklers)				
	<i>C.O.</i>	<i>Part Number</i>	<i>Description</i>	<i>List Price</i>
		56-938-1-001	G1 Guard, Red	\$8.85
		56-938-9-001	G1 Guard, Zinc	\$8.85
		56-937-1-001	G4 Guard, Red	\$10.50
		56-937-9-001	G4 Guard, Zinc	\$10.50
		56-938-1-066	G1/S1 Guard and Shield, Red	\$10.70
		56-938-9-066	G1/S1 Guard and Shield, Zinc	\$10.70
		56-937-1-066	G4/S3 Guard and Shield, Red	\$12.75
		56-937-9-066	G4/S3 Guard and Shield, Zinc	\$12.75
		56-000-8-597	Guard Installation Tool	\$2.05
Technical Data Sheet: TFP780				

Section 3
Storage Sprinklers

Section 4
Residential Products

Section 5
Dry Sprinklers

Section 6
Special Sprinklers

G5 Sprinkler Guard (For Series DS-1 Dry Sprinklers)				
	<i>C.O.</i>	<i>Part Number</i>	<i>Description</i>	<i>List Price</i>
		56-938-9-000	G5 Sprinkler Guard for Series DS 1 Sprinklers	\$20.75
Technical Data Sheet: TFP783				

Section 7
Nozzles and Sprinkler Accessories

Items marked "C.O." are made to order and may require longer delivery times. Please contact customer service for availability.

See latest Technical Data Sheets for specific Approvals, Listings, Design Parameters & available finishes. Sprinkler heads & escutcheons are priced separately unless otherwise noted.

**G2 Guard, WS-2 Shield and WSG-2 Guard & Shield
for ELO-231 Series**

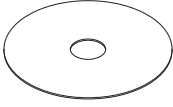
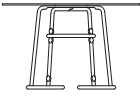
	<i>C.O.</i>	<i>Part Number</i>	<i>Description</i>	<i>List Price</i>
		56-000-1-087	G-2 Guard, Red	\$7.00
		56-000-1-086	G-2 Guard, Zinc	\$7.00
		56-000-1-081	WS-2 Shield (1/2), Red	\$7.70
		56-000-1-080	WS-2 Shield (1/2), Zinc	\$7.70
		56-000-1-083	WS-2 Shield (3/4), Red	\$7.70
		56-000-1-082	WS-2 Shield (3/4), Zinc	\$7.70
		56-000-1-098	WSG-2 Guard & Shield , Red	\$10.70
		56-000-1-097	WSG-2 Guard & Shield , Zinc	\$10.70

Technical Data Sheet: TFP782

Special Services

Clean Room Seal / Air, Dust Seal

<i>Description</i>	<i>Part Number</i>	<i>List Price</i>
ELOC Concealed Clean Room Seal	10908100	\$13.50
RFII Air and Dust Seal	56-908-1-001	\$12.50
Plastic Cap Protective Cover - LFII	92-000-0-412	\$0.30

**All Special Finishes and Coatings are special ordered and are Non-Returnable.
Please see "Terms & Conditions"**

Section 1
Standard Spray Sprinklers

Section 2
Extended Coverage Sprinklers

Section 3
Storage Sprinklers

Section 4
Residential Products

Section 5
Dry Sprinklers

Section 6
Special Sprinklers

Section 7
Nozzles and Sprinkler Accessories

See latest Technical Data Sheets for specific Approvals, Listings, Design Parameters & available finishes. Sprinkler heads & escutcheons are priced separately unless otherwise noted.

Items marked "C.O." are made to order and may require longer delivery times. Please contact customer service for availability.

Sprinkler Wrench List

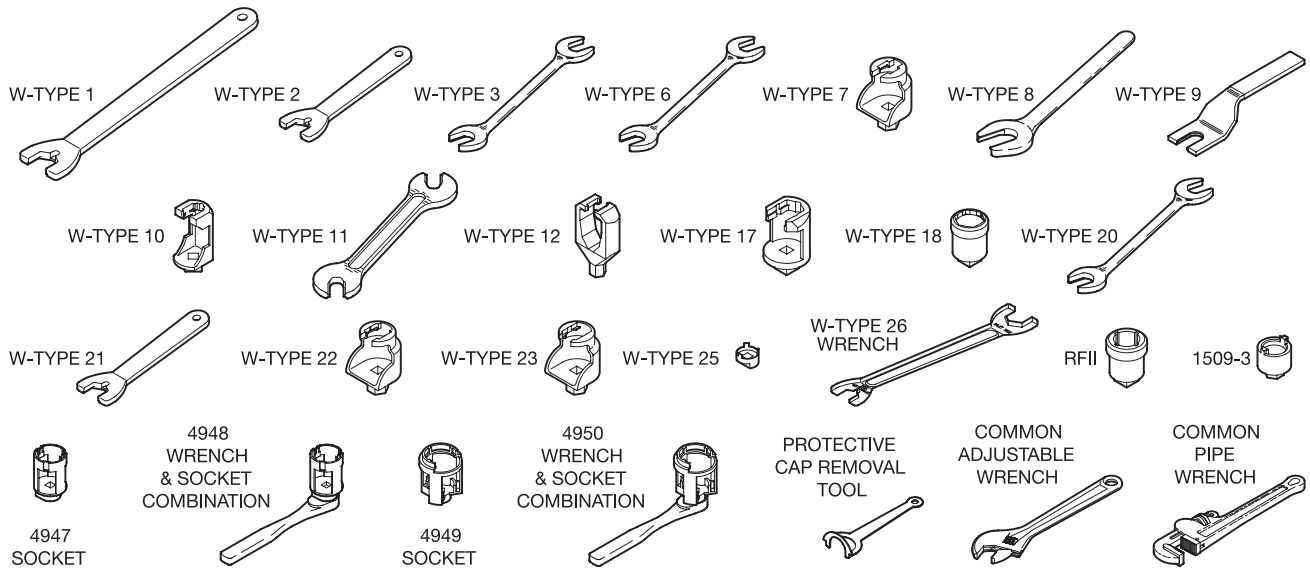

Wrench Type	Wrench used with the following Sprinkler Models:	Part No.	List Price
W-Type 1	EC-25, ESFR-25	56-872-1-025	\$64.75
W-Type 2	ESFR Pendent	56-872-1-001	\$51.25
W-Type 3	BB1 17/32, EPEC, EC-8, EC-11, EC-14, EC-17, ELO SW-20, ELO SW-24, ELO-231, ELO-231 B, ELO-231 FRB, LD	56-895-1-001	\$70.50
W-Type 6	CG2, EC-5, LFII, TY-B, TY-FRB	56-000-6-387	\$51.25
W-Type 7	CHEC, DS-1, EC-5, LFII, TY-B, TY-FRB, TY-FRFS, TY-FS, TY-FS Special	56-850-4-001	\$85.00
W-Type 8	DS-3, K17-231, Ultra K17	56-892-1-001	\$85.00
W-Type 9	TY-FRL, TY-L	56-000-1-849	\$45.75
W-Type 10	TY-FRFS, TY-FS, TY-FS Special, TY-L	56-000-1-948	\$70.50
W-Type 11	Issue D Quartzoid, Type EA-1, D3, D3S, Type 1 & 2	56-452-1-001	\$31.00
W-Type 12	TY-FRL	56-798-1-001	\$64.75
W-Type 17	DS-2	56-010-4-118	\$73.50
W-Type 18	ELOC, LFII	56-000-1-265	\$85.00
W-Type 20	CC1, HIP, WS	56-000-1-106	\$85.00
W-Type 21	ESFR-17	56-001-0-686	\$51.25
W-Type 22	EC-11, EC-14	56-665-7-001	\$85.00
W-Type 23	EC-8	56-000-6-838	\$85.00
W-Type 25	Tyco Raven Institutional	56-314-1-001	\$148.50
W-Type 26	ESFR-17 Dry-Type	56-341-1-001	\$64.75
RFII	DS-C, DS-ECC, RFII	56-000-1-075	\$85.00
1509-3	TFP MAX, TFP PH2, TFP PH5	56-001-5-093	\$148.50
4947 Socket	LFII, TY-QRF	56-000-4-947	\$90.75
4948 Wrench & Socket Combo	LFII, TY-QRF	56-000-4-948	\$135.00
4949 Socket	LFII	56-000-4-949	\$90.75
4950 Wrench & Socket Combo	LFII	56-000-4-950	\$135.00
Protective Cap Removal Tool	LFII	56-000-4-300	\$30.00
Pipe Wrench	DS-1, DS-2, DS-C, DS-ECC	N/A	-
Adjustable Wrench	BB1, BB2, BB3, SD1, SD2, SD3, Type D4a, F822 thru F834, HV-14 thru HV-60, Issue A & B, B-1	N/A	-

Items marked "C.O." are made to order and may require longer delivery times. Please contact customer service for availability.

See latest Technical Data Sheets for specific Approvals, Listings, Design Parameters & available finishes. Sprinkler heads & escutcheons are priced separately unless otherwise noted.

Model AV-1-300 Alarm Check Valve, 300 psi 2¹/₂" thru 8"

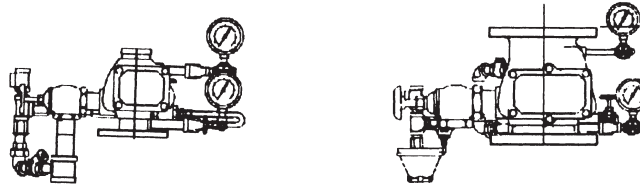

<i>Description</i>	<i>Part No.</i>	<i>List Price</i>
2 ¹ / ₂ " Model AV-1-300, Groove x Groove, Vertical	52-203-1-110	\$1,382.00
4" Model AV-1-300, Groove x Groove, Vertical/Horizontal	52-203-1-113	\$1,382.00
6" Model AV-1-300, Groove x Groove, Vertical/Horizontal	52-203-1-115	\$1,701.00
8" Model AV-1-300, Groove x Groove, Vertical/Horizontal	52-203-1-916	\$2,444.00
2 ¹ / ₂ " Model AV-1-300, Flange x Groove, Vertical	52-203-1-210	\$1,382.00
4" Model AV-1-300, Flange x Groove, Vertical/Horizontal	52-203-1-413	\$1,382.00
6" Model AV-1-300, Flange x Groove, Vertical/Horizontal	52-203-1-615	\$1,701.00
8" Model AV-1-300, Flange x Groove, Vertical/Horizontal	52-203-1-816	\$2,444.00
4" Model AV-1-300, Flange x Flange, Vertical/Horizontal	52-203-1-013	\$1,382.00
6" Model AV-1-300, Flange x Flange, Vertical/Horizontal	52-203-1-015	\$1,701.00
8" Model AV-1-300, Flange x Flange, Vertical/Horizontal	52-203-1-016	\$2,444.00
Preassembled Alarm Check Valves		
2 ¹ / ₂ " Model AV-1-300, Groove x Groove, Pre-Trimmed	52-203-2-110	\$3,256.00
4" Model AV-1-300, Flange x Groove, Pre-Trimmed	52-203-2-414	\$3,167.00
6" Model AV-1-300, Groove x Groove, Pre-Trimmed	52-203-2-115	\$3,964.00
6" Model AV-1-300, Flange x Groove, Pre-Trimmed	52-203-2-615	\$3,964.00
8" Model AV-1-300, Flange x Groove, Pre-Trimmed	52-203-2-816	\$4,713.00
Trim Assemblies for 2¹/₂", 4", 6" & 8" Alarm Check Valves Model AV-1-300		
2 ¹ / ₂ " Vertical Closed Drain, Basic Trim (Galvanized) AV-1-300	52-204-4-950	\$985.50
4" & 6" Vertical Closed Drain, Basic Trim (Galvanized) AV-1-300	52-204-4-951	\$1,213.00
4" & 6" Vertical Open Drain, Basic Trim (Galvanized) AV-1-300	52-204-4-954	\$1,066.50
4" & 6" Horizontal Closed Drain, Basic Trim (Galvanized) AV-1-300	52-204-4-057	\$1,293.00
8" Vertical Closed Drain, Basic Trim (Galvanized) AV-1-300	52-204-4-952	\$1,213.00
8" Vertical Open Drain, Basic Trim (Galvanized) AV-1-300	52-204-4-955	\$1,066.50
8" Horizontal Closed Drain, Basic Trim (Galvanized) AV-1-300	52-204-4-058	\$1,293.00
Pressure Relief Trim, 175 PSI	52-201-2-047	\$254.50
Pressure Relief Trim, 185 PSI	52-201-2-048	\$254.50
175 PSI Pressure Relief Valve	92-343-1-025	\$119.50
185 PSI Pressure Relief Valve	92-343-1-026	\$119.50
Main Drain	52-201-1-011	\$319.50
Trim, Alarm Vent	52-201-2-012	\$89.50
RC-1 Retard Chamber with Trim	52-211-1-002	\$555.50
Notes		
Other Options per TFP910; Pressure switch must be ordered separately, if required.		
(Replacement Parts are on the next page)		

Section 8	Wet System Valves
Section 9	Water Motor Alarms
Section 10	Dry Pipe Valves
Section 11	Quick Opening Devices
Section 12	Air Maintenance Devices
Section 13	Deluge Valves & Accessories
Section 14	Preaction Systems
Section 15	General Purpose Valves

Model AV-1-300 Alarm Check Valve, 300 psi 2 1/2" thru 8"

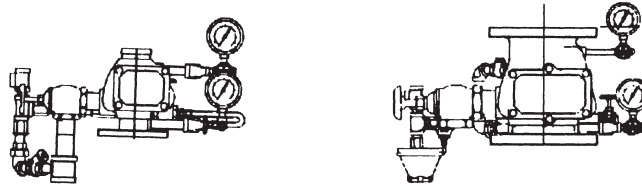

Replacement Parts for 2 1/2" Model AV-1-300 Alarm Check Valves

Repair Parts Kit Includes: 1-Handhole Cover Gasket & 1-Clapper Facing	92-200-1-216	\$98.00
Clapper Assembly Kit Includes: 1-Clapper, 1-Clapper Facing, 1-Clapper Washer, 1-Clapper Lock Nut, 1-Clapper Hinge Pin, 2-Clapper Hinge Pin Bushings & 1-Clapper Spring	92-200-1-218	\$346.50

Replacement Parts for 4" Model AV-1-300 Alarm Check Valves

Repair Parts Kit Includes: 1-Handhole Cover Gasket & 1-Clapper Facing	92-200-1-416	\$114.00
Clapper Assembly Kit Includes: 1-Clapper, 1-Clapper Facing, 1-Clapper Washer, 1-Hex Self-Locking Cap Screw, 1-Clapper Hinge Pin Bushing & 1-Clapper Spring	92-200-1-423	\$527.50

Replacement Parts for 6" Model AV-1-300 Alarm Check Valves

Repair Parts Kit Includes: 1-Handhole Cover Gasket & 1-Clapper Facing	92-200-1-620	\$132.50
Clapper Assembly Kit Includes: 1-Clapper, 1-Clapper Facing, 1-Clapper Washer, 1-Hex Self-Locking Cap Screw, 1-Clapper Hinge Pin Bushing & 1-Clapper Spring	92-200-1-623	\$665.50

Replacement Parts for 8" Model AV-1-300 Alarm Check Valves

Repair Parts Kit Includes: 1-Handhole Cover Gasket & 1-Clapper Facing	92-200-1-816	\$185.00
Clapper Assembly Kit Includes: 1-Clapper, 1-Clapper Facing, 1-Clapper Washer, 1-Hex Self-Locking Cap Screw, 1-Clapper Hinge Pin Bushing & 1-Clapper Spring	92-200-1-823	\$1,051.50

Technical Data Sheet - TFP910

Shotgun CV-1FR Riser Check Valve

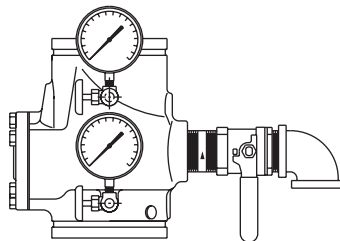

<i>Part Numbers</i>	<i>Description</i>	<i>List Price</i>
59-590-1-020	2" Shotgun Riser Check Valve	\$655.50
59-590-1-025	2 1/2" Shotgun Riser Check Valve	\$643.50
59-590-1-030	3" Shotgun Riser Check Valve	\$655.50
59-590-1-040	4" Shotgun Riser Check Valve	\$655.50
59-590-1-050	5" Shotgun Riser Check Valve	\$1,197.00
59-590-1-060	6" Shotgun Riser Check Valve	\$1,217.00
59-590-1-080	8" Shotgun Riser Check Valve	\$2,202.00
Trim Assemblies for 2" thru 8" CV-1FR Riser Check Valve		
59-591-1-020	2" Shotgun Check Trim (w/ gauges)	\$436.50
59-591-1-030	2 1/2" - 3" Shotgun Check Trim (w/ gauges)	\$436.50
59-591-1-080	4" - 8" Shotgun Check Trim (w/ gauges)	\$436.50

Technical Data Sheet: TFP950

See latest Technical Data Sheets for specific Approvals, Listings, Design Parameters & available finishes on www.tyco-fire.com.

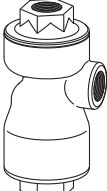
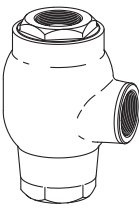
Residential Shutoff Valves			
	<i>Description</i>	<i>Part No.</i>	<i>List Price</i>
 <p>1" RSV-1</p>  <p>2" RSV-1</p>	1" Model RSV-1	52-540-1-001	\$1,098.00
	2" Model RSV-1	52-540-1-002	\$1,733.00
Technical Data Sheet - TFP980			

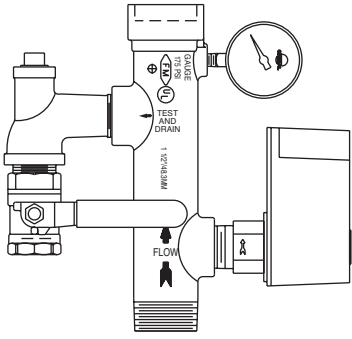
Riser Manifolds – Commercial & Residential							
	<i>Size</i>	<i>Description</i>	<i>Type</i>	<i>Part No.</i>	<i>Part No. Canada</i>	<i>List Price</i>	
	1"	Residential	Female Thread x Female Thread	4067	4085	\$726.00	
	1 1/2"	Residential	Male Thread x Female Thread	4057	4088	\$726.00	
	1 1/2"	Residential	Male Thread x Male Thread	4058	4089	\$726.00	
	2"	Residential	Groove x Groove	4059	4093	\$747.50	
	2"	Residential	Male Thread x Groove	4064	4094	\$810.00	
	1 1/2"	Commercial	Male Thread x Female Thread	4055	4086	\$810.00	
	1 1/2"	Commercial	Male Thread x Male Thread	4056	4087	\$810.00	
	2"	Commercial	Groove x Groove	4060	4090	\$810.00	
	2 1/2"	Commercial	Groove x Groove	4061	4091	\$904.50	
	3"	Commercial	Groove x Groove	4062	4092	\$947.50	
	4"	Commercial	Groove x Groove	4065	4095	\$1,162.00	
	6"	Commercial	Groove x Groove	4066	4096	\$1,285.00	
	Optional Pressure Relief Valve and Trim Kit						
		1 1/2" - 2"	Manifold Accessory Kit		4063	-	\$251.00
	2 1/2" - 3"	Manifold Accessory Kit		4072	-	\$251.00	
	4" - 6"	Manifold Accessory Kit		4073	-	\$251.00	
Technical Data Sheet - Residential - TFP960, Commercial - TFP962							

See latest Technical Data Sheets for specific Approvals, Listings, Design Parameters & available finishes on www.tyco-fire.com.

Section 8
Wet System Valves

 Section 9
Water Motor Alarms

 Section 10
Dry Pipe Valves

 Section 11
Quick Opening Devices

 Section 12
Air Maintenance Devices

 Section 13
Deluge Valves & Accessories

 Section 14
Preaction Systems

 Section 15
General Purpose Valves

Section 8
Wet System Valves

Section 9
Water Motor Alarms

Section 10
Dry Pipe Valves

Section 11
Quick Opening Devices

Section 12
Air Maintenance Devices

Section 13
Deluge Valves & Accessories

Section 14
Preaction Systems

Section 15
General Purpose Valves

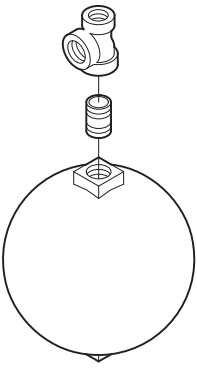
Model RC-1 Retard Chamber			
	<i>Part No.</i>	<i>Description</i>	<i>List Price</i>
	52-211-1-002	Retard Chamber, Model RC-1 w/trim	\$555.50
	Replacement Parts for Model RC-1 Retard Chamber		
92-210-2-005	Restriction Assembly	\$499.50	
Technical Data Sheet - TFP920			

Resi-Risers		
Resi-Risers w/Retard Feature on Flow Switch and Without Pressure Relief Valve		
<i>Description</i>	<i>Part No.</i>	<i>List Price</i>
1" Resi-Riser	54-360-1-011	\$832.00
1 1/4" Resi-Riser	54-360-1-012	\$940.00
1 1/2" Resi-Riser	54-360-1-013	\$996.50
2" Resi-Riser	54-360-1-014	\$1,140.00
Resi-Risers w/Pressure Relief Valve and Retard Feature		
1" Resi-Riser	54-360-1-111	\$874.00
1 1/4" Resi-Riser	54-360-1-112	\$973.00
1 1/2" Resi-Riser	54-360-1-113	\$1,027.50
2" Resi-Riser	54-360-1-114	\$1,175.00

See latest Technical Data Sheets for specific Approvals, Listings, Design Parameters & available finishes on www.tyco-fire.com.

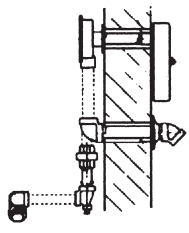
Water Motor Alarm Model WMA-1				
	<i>Description</i>	<i>Part No.</i>	<i>List Price</i>	
	WMA-1, (Aluminum), Complete with Trim	52-630-2-001P	\$769.00	
	WMA-1, (Red), Complete with Trim	52-630-1-001P	\$769.00	
	Optional Drain Trim	52-630-2-002	\$153.50	
	Replacement Components for Water Motor Alarms			
	Water Motor	92-630-1-012	\$440.00	
	Repair Kit: Striker, Gong (Red) and Cap Nut	92-630-1-025	\$440.00	
	Repair Kit: Striker, Gong (Aluminum) and Cap Nut	92-630-2-025	\$440.00	
	Replacement Trim Components			
	³ / ₄ " Strainer	52-271-1-001	\$225.50	
	³ / ₄ " Check Valve	52-403-1-005	\$183.00	
Technical Data Sheet - TFP 921				

Section 8
Wet System Valves

Section 9
Water Motor Alarms

Section 10
Dry Pipe Valves

Section 11
Quick Opening Devices

Section 12
Air Maintenance Devices

Section 13
Deluge Valves & Accessories

Section 14
Preaction Systems

Section 15
General Purpose Valves

See latest Technical Data Sheets for specific Approvals, Listings, Design Parameters & available finishes on www.tyco-fire.com.

Section 8 Wet System Valves
Section 9 Water Motor Alarms
Section 10 Dry Pipe Valves
Section 11 Quick Opening Devices
Section 12 Air Maintenance Devices
Section 13 Deluge Valves & Accessories
Section 14 Preaction Systems
Section 15 General Purpose Valves

See latest Technical Data Sheets for specific Approvals, Listings, Design Parameters & available finishes on www.tyco-fire.com.

DPV-1 Dry Pipe Valve

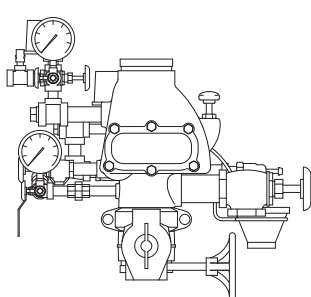
Description		Part No.	List Price
DPV-1 Pre-assembled Valve & Trim with Butterfly Valve			
	2½" DPV-1 Groove x Groove Pre-Trimmed with Butterfly Valve (Galvanized)	52-310-3-925	\$6,047.00
	3" DPV-1 Groove x Groove Pre-Trimmed with Butterfly Valve (Galvanized)	52-310-3-930	\$6,047.00
	4" DPV-1 Groove x Groove Pre-Trimmed with Butterfly Valve (Galvanized)	52-310-3-940	\$6,493.00
	6" DPV-1 Groove x Groove Pre-Trimmed with Butterfly Valve (Galvanized)	52-310-3-960	\$7,396.00
	4" DPV-1 Flange x Groove Pre-Trimmed with Butterfly Valve (Galvanized)	52-310-3-440	\$6,493.00
	6" DPV-1 Flange x Groove Pre-Trimmed with Butterfly Valve (Galvanized)	52-310-3-460	\$7,396.00
	4" DPV-1 Flange x Flange Pre-Trimmed with Butterfly Valve (Galvanized)	52-310-3-040	\$6,493.00
	6" DPV-1 Flange x Flange Pre-Trimmed with Butterfly Valve (Galvanized)	52-310-3-060	\$7,396.00
Note			
Pre-assembled includes alarm test valve and connections for gauges, priming, air supply, drains, pressure switches, couplings/flange adaptor and butterfly valve.			
DPV-1 Pre-assembled Valve & Trim, without Control Valve			
4" DPV-1 Flange x Groove Pre-Trimmed (Galvanized)	52-310-4-440	\$5,717.00	
6" DPV-1 Flange x Groove Pre-Trimmed (Galvanized)	52-310-4-460	\$6,286.00	
4" DPV-1 Flange x Flange Pre-Trimmed (Galvanized)	52-310-4-040	\$5,717.00	
6" DPV-1 Flange x Flange Pre-Trimmed (Galvanized)	52-310-4-060	\$6,286.00	
Note			
Pre-assembled includes alarm test valve and connections for gauges, priming, air supply, drains, and pressure switches.			
DPV-1 Bare Valve			
2½" Model DPV-1 Groove x Groove	52-310-1-925	\$3,179.00	
3" Model DPV-1 Groove x Groove	52-310-1-930	\$3,531.00	
4" Model DPV-1 Groove x Groove	52-310-1-940	\$3,765.00	
6" Model DPV-1 Groove x Groove	52-310-1-960	\$4,777.00	
4" Model DPV-1 Flange x Groove	52-310-1-440	\$3,765.00	
6" Model DPV-1 Flange x Groove	52-310-1-460	\$4,777.00	
4" Model DPV-1 Flange x Flange	52-310-1-040	\$3,765.00	
6" Model DPV-1 Flange x Flange	52-310-1-060	\$4,777.00	
DPV-1 Dry Pipe Valve Trim			
2½" and 3" DPV-1 Semi-Pre-assembled Trim (Galvanized)	52-309-2-005	\$1,215.00	
4" DPV-1 Semi-Pre-assembled Trim (Galvanized)	52-309-2-001	\$1,305.00	
6" DPV-1 Semi-Pre-assembled Trim (Galvanized)	52-309-2-002	\$1,305.00	
Replacement Parts for Model "DPV-1" Dry Pipe Valve			
2½" and 3" Clapper Assembly	92-310-2-203	\$1,180.00	
2½" and 3" Repair Parts Kit	92-310-1-204	\$202.50	
4" Clapper Assembly	92-310-2-403	\$1,180.00	
4" Repair Parts Kit	92-310-1-404	\$202.50	
Reset Plunger Parts Kit	92-310-1-405	\$871.00	
6" Clapper Assembly	92-310-2-603	\$2,148.00	
6" Repair Parts Kit	92-310-1-604	\$309.00	
Technical Data Sheet - TFP1020			

Note

Please refer to Section 11 - Quick Opening Devices for the optional Model QRS Electronic Dry Pipe Valve Accelerator and the Model ACC-1 Mechanical Dry Pipe Valve Accelerator.

Section 8
Wet System Valves

Section 9
Water Motor Alarms

Section 10
Dry Pipe Valves

Section 11
Quick Opening Devices

Section 12
Air Maintenance Devices

Section 13
Deluge Valves & Accessories

Section 14
Preaction Systems

Section 15
General Purpose Valves

Section 8 Wet System Valves
Section 9 Water Motor Alarms
Section 10 Dry Pipe Valves
Section 11 Quick Opening Devices
Section 12 Air Maintenance Devices
Section 13 Deluge Valves & Accessories
Section 14 Preaction Systems
Section 15 General Purpose Valves

See latest Technical Data Sheets for specific Approvals, Listings, Design Parameters & available finishes on www.tyco-fire.com.

**“VIZOR” Model EDPA - Electronic Dry Pipe Accelerator
(Quick Opening Device)**

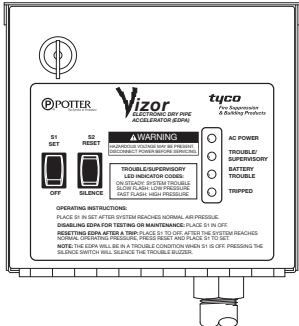
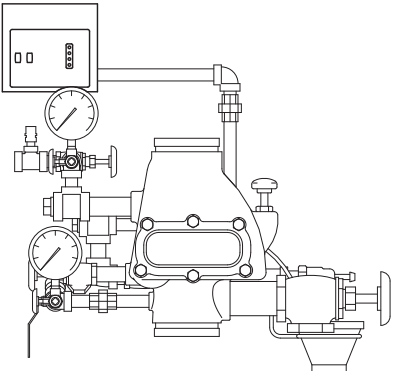
Description	Part No.	List Price Each
 <p>“VIZOR” - Electronic Dry Pipe Accelerator (EDPA) Switch (Note: Switch Only)</p>	52-312-3-000	\$2,821.00
 <p>“VIZOR” - Electronic Dry Pipe Accelerator (EDPA) with the Model EDPA Trim for use with 4 or 6 inch Model DPV-1 Dry Pipe Valve (Note: DPV-1 Dry Pipe Valve and Batteries are not included)</p>	52-312-3-001	\$2,880.00
VIZOR Battery Cabinet EDPA (For use with BT-40 only)	52-312-3-002	\$150.50
Replacement Battery BT-40 (5 Amp) (Requires 2)	2654	\$73.50
Replacement Battery BT-10 (1.3 Amp) (Requires 2)	2653	\$77.75
Fuse Holder EDPA	2655	\$29.50
Fuse 5 Amp EDPA	2657	\$4.70
Technical Data Sheet - TFP1105		

Section 8	Wet System Valves
Section 9	Water Motor Alarms
Section 10	Dry Pipe Valves
Section 11	Quick Opening Devices
Section 12	Air Maintenance Devices
Section 13	Deluge Valves & Accessories
Section 14	Preaction Systems
Section 15	General Purpose Valves

See latest Technical Data Sheets for specific Approvals, Listings, Design Parameters & available finishes on www.tyco-fire.com.

Section 8
Wet System Valves

Section 9
Water Motor Alarms

Section 10
Dry Pipe Valves

Section 11
Quick Opening Devices

Section 12
Air Maintenance Devices

Section 13
Deluge Valves & Accessories

Section 14
Preaction Systems

Section 15
General Purpose Valves

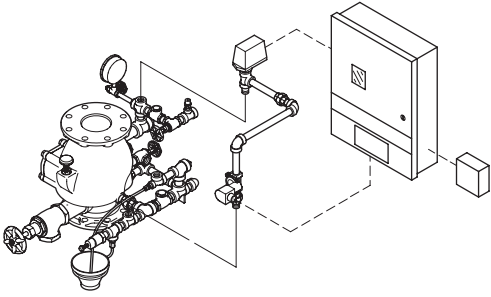
QRS Electronic Accelerator		
<i>Description</i>	<i>Part No.</i>	<i>List Price</i>
	QRS Electronic Dry Pipe Valve Accelerator Package for Double Interlock Systems Includes: 1-QRS Accelerator Trim, 1-24 VDC Solenoid Valve 1-PFC-4410 RC Releasing Panel, 2-BT-120 12.0 AH Battery	52-312-2-102 \$5,781.00
	QRS Electronic Dry Pipe Valve Accelerator Package for Dry Pipe Systems. (no Releasing Panel) Includes: 1-QRS Accelerator Trim, 1-24 VDC Solenoid Valve	52-312-2-001 \$3,001.00
QRS Switch Only	92-312-1-001	\$1,506.00
Replacement Battery (BT-120 12.0 AH Battery)	20128	\$141.00
Technical Data Sheet - TFP1100		

See latest Technical Data Sheets for specific Approvals, Listings, Design Parameters & available finishes on www.tyco-fire.com.

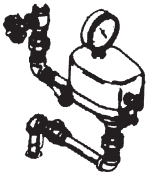
Dry Pipe Valve Accelerator, Model ACC-1			
<i>Description</i>		<i>Part No.</i>	<i>List Price</i>
	Accelerator Only	52-311-1-001P	\$1,738.00
	Accelerator Trim (Galvanized)	52-311-2-010	\$672.50
	Accelerator "Package"	52-311-2-002	\$2,495.00
Repair Parts for Dry Pipe Valve Accelerator, Model ACC-1			
Replacement Kit A (See Datasheet for Additional Information) Includes: 1-Plunger, 1-Exhaust Valve, 1-Cover Gasket, 1-O-Ring, 1-Restriction, 1-Latch, 1-O-Ring & 1.5 grams of FS3452 Fluorosilicone Grease		92-311-1-116P	\$715.50
Replacement Kit B (See Datasheet for Additional Information) Includes: 1-Pivot Plate Assembly, 4-Pan Head Machine Screws, 1-Cotter Pin, 1-Lever, 1-Retaining Ring, 1-Anti-Flood Valve, 1-Relief Valve, 1-Spring, 1-Relief Valve, 1-Spring, 1-Relief Valve Seat, 1-O-Ring, 1-Seal Washer, 1-Latch, 1-Anti-Flood Seat Assembly w/Ball Float & 1.5 grams of FS3452 Fluorosilicone Grease		92-311-1-117P	\$706.00
Replacement Kit C (See Datasheet for Additional Information) Includes: 1-Upper Diaphragm Plate, 6-Round Head Machine Screws, 1-Vent Plug, 1-Restriction Access Plate, 8-Fillerster Head Machine Screws, 1-Plug Seat, 1-O-Ring, 1-Reset Knob & 1.5 grams of FS3452 Fluorosilicone Grease		92-311-1-118	\$1,057.00
Technical Data Sheet - TFP1112			

Section 8	Wet System Valves
Section 9	Water Motor Alarms
Section 10	Dry Pipe Valves
Section 11	Quick Opening Devices
Section 12	Air Maintenance Devices
Section 13	Deluge Valves & Accessories
Section 14	Preaction Systems
Section 15	General Purpose Valves

See latest Technical Data Sheets for specific Approvals, Listings, Design Parameters & available finishes on www.tyco-fire.com.

Section 8 Wet System Valves
Section 9 Water Motor Alarms
Section 10 Dry Pipe Valves
Section 11 Quick Opening Devices
Section 12 Air Maintenance Devices
Section 13 Deluge Valves & Accessories
Section 14 Preaction Systems
Section 15 General Purpose Valves

See latest Technical Data Sheets for specific Approvals, Listings, Design Parameters & available finishes on www.tyco-fire.com.

Air Maintenance Devices

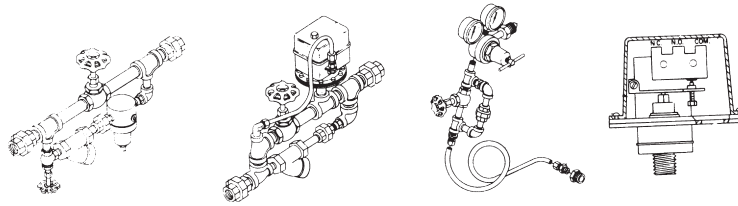

<i>Description</i>	<i>Part No.</i>	<i>List Price</i>
AMD-1 Air Maintenance Device	52-324-2-002	\$983.00
AMD-2 Air Maintenance Device	52-326-2-001	\$1,449.00
AMD-3 Nitrogen Maintenance Device	52-328-2-001	\$1,924.00
Replacement Parts for Air Supply Controls		
Pressure Regulator for Model AMD-1	92-324-1-012	\$752.00
Strainer 1/4", for Model AMD-1 and AMD-2	92-322-1-001	\$220.50
Pressure Switch for AMD-2 Device	92-326-1-001	\$1,418.00
Restrictor Check. Valve for AMD-1, AMD-2 and AMD-3 Device	92-326-1-003	\$190.50
Technical Data Sheet - (AMD-1 - TFP1221), (AMD-2 - TFP1231) and (AMD-3 - TFP1241)		

Accessories for Air Maintenance Devices

<i>Description</i>	<i>Part No.</i>	<i>List Price</i>
Low Pressure Alarm Switch PS40-1A	2572	\$194.00
Hi/Low Pressure Alarm Switch PS40-2A	2573	\$250.00

Section 8
Wet System Valves

Section 9
Water Motor Alarms

Section 10
Dry Pipe Valves

Section 11
Quick Opening Devices

Section 12
Air Maintenance Devices

Section 13
Deluge Valves & Accessories

Section 14
Preaction Systems

Section 15
General Purpose Valves

See latest Technical Data Sheets for specific Approvals, Listings, Design Parameters & available finishes on www.tyco-fire.com.

Section 8 Wet System Valves
Section 9 Water Motor Alarms
Section 10 Dry Pipe Valves
Section 11 Quick Opening Devices
Section 12 Air Maintenance Devices
Section 13 Deluge Valves & Accessories
Section 14 Preaction Systems
Section 15 General Purpose Valves

See latest Technical Data Sheets for specific Approvals, Listings, Design Parameters & available finishes on www.tyco-fire.com.

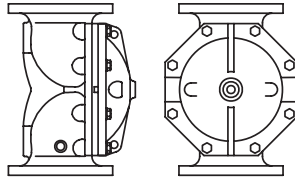
Model DV-5 Deluge Valves, Diaphragm Style		
<i>Description</i>	<i>Part No.</i>	<i>List Price</i>
	1 1/2" Model DV-5 Groove x Groove, 250 PSI	52-477-1-919 \$2,181.00
	2" Model DV-5 Groove x Groove, 250 PSI	52-477-1-910 \$2,280.00
	3" Model DV-5 Groove x Groove, 250 PSI	52-477-1-912 \$2,478.00
	4" Model DV-5 Groove x Groove, 250 PSI	52-477-1-913 \$4,270.00
	6" Model DV-5 Groove x Groove, 250 PSI	52-477-1-915 \$5,206.00
	8" Model DV-5 Groove x Groove, 250 PSI	52-477-1-916 \$14,899.00
	1 1/2" Model DV-5 Thread x Thread, 250 PSI	52-477-1-069 \$2,181.00
	2" Model DV-5 Thread x Thread, 250 PSI	52-477-1-060 \$2,280.00
	3" Model DV-5 Flange x Groove, 250 PSI	52-477-1-412 \$2,478.00
	4" Model DV-5 Flange x Groove, 250 PSI	52-477-4-613 \$4,270.00
	6" Model DV-5 Flange x Groove, 250 PSI	52-477-4-615 \$5,206.00
	8" Model DV-5 Flange x Groove, 250 PSI	52-477-1-416 \$14,899.00
	3" Model DV-5 Flange x Flange, 250 PSI	52-477-1-012 \$2,478.00
	4" Model DV-5 Flange x Flange, 250 PSI	52-477-1-013 \$4,270.00
	6" Model DV-5 Flange x Flange, 250 PSI	52-477-1-015 \$5,206.00
	8" Model DV-5 Flange x Flange, 250 PSI	52-477-1-016 \$14,899.00
Trim Kits for Model DV-5 Deluge Valves - 1 1/2" and 2"		
1 1/2" and 2" Wet Pilot Actuation (Galvanized) (Standard Order)	52-477-2-107	\$2,975.00
1 1/2" and 2" Wet Pilot Actuation (Black)	52-477-1-107	\$2,975.00
1 1/2" and 2" Wet Pilot Actuation (Brass)	52-477-3-107	POA
1 1/2" and 2" Wet Pilot Actuation (Stainless Steel)	52-477-4-107	POA
1 1/2" and 2" Dry Pilot Actuation (Galvanized) (Standard Order)	52-477-2-108	\$3,964.00
1 1/2" and 2" Dry Pilot Actuation (Black)	52-477-1-108	\$3,964.00
1 1/2" and 2" Dry Pilot Actuation (Brass)	52-477-3-108	POA
1 1/2" and 2" Dry Pilot Actuation (Stainless Steel)	52-477-4-108	POA
1 1/2" and 2" Electric Actuation (Galvanized) (Standard Order)(Solenoid Valve Not Included)	52-477-2-109	\$2,975.00
1 1/2" and 2" Electric Actuation (Black) (Solenoid Valve Not Included)	52-477-1-109	\$2,975.00
1 1/2" and 2" Electric Actuation (Brass) (Solenoid Valve Not Included)	52-477-3-109	POA
1 1/2" and 2" Electric Actuation (Stainless Steel) (Solenoid Valve Not Included)	52-477-4-109	POA
Trim Kits for Model DV-5 Deluge Valves - 3"		
3" Wet Pilot Actuation (Galvanized) (Standard Order)	52-477-2-104	\$2,975.00
3" Wet Pilot Actuation (Black)	52-477-1-104	\$2,975.00
3" Wet Pilot Actuation (Brass)	52-477-3-104	POA
3" Wet Pilot Actuation (Stainless Steel)	52-477-4-104	POA
3" Dry Pilot Actuation (Galvanized) (Standard Order)	52-477-2-105	\$3,964.00
3" Dry Pilot Actuation (Black)	52-477-1-105	\$3,964.00
3" Dry Pilot Actuation (Brass)	52-477-3-105	POA
3" Dry Pilot Actuation (Stainless Steel)	52-477-4-105	POA
3" Electric Actuation (Galvanized) (Standard Order) (Solenoid Valve Not Included)	52-477-2-106	\$2,975.00
3" Electric Actuation (Black) (Solenoid Valve Not Included)	52-477-1-106	\$2,975.00
3" Electric Actuation (Brass) (Solenoid Valve Not Included)	52-477-3-106	POA
3" Electric Actuation (Stainless Steel) (Solenoid Valve Not Included)	52-477-4-106	POA

Section 8
Wet System Valves

Section 9
Water Motor Alarms

Section 10
Dry Pipe Valves

Section 11
Quick Opening Devices

Section 12
Air Maintenance Devices

Section 13
Deluge Valves & Accessories

Section 14
Preaction Systems

Section 15
General Purpose Valves

Refer to the latest technical data sheets for specific approvals, listings, design parameters, and available options on www.tyco-fire.com.

Model DV-5 Deluge Valves, Diaphragm Style (cont.)			
	<i>Description</i>	<i>Part No.</i>	<i>List Price</i>
Section 8 Wet System Valves	Trim Kits for Model DV-5 Deluge Valves - 4", 6" and 8"		
	4", 6" & 8" Wet Pilot Actuation (Galvanized) (Standard Order)	52-477-2-101	\$2,975.00
Section 9 Water Motor Alarms	4", 6" & 8" Wet Pilot Actuation (Black)	52-477-1-101	\$2,975.00
	4", 6" & 8" Wet Pilot Actuation (Brass)	52-477-3-101	POA
	4", 6" & 8" Wet Pilot Actuation (Stainless Steel)	52-477-4-101	POA
	4", 6" & 8" Dry Pilot Actuation (Galvanized) (Standard Order)	52-477-2-102	\$4,023.00
Section 10 Dry Pipe Valves	4", 6" & 8" Dry Pilot Actuation (Black)	52-477-1-102	\$4,023.00
	4", 6" & 8" Dry Pilot Actuation (Brass)	52-477-3-102	POA
	4", 6" & 8" Dry Pilot Actuation (Stainless Steel)	52-477-4-102	POA
	4", 6" & 8" Electric Actuation (Galvanized) (Standard Order) (Solenoid Valve Not Included)	52-477-2-103	\$2,975.00
Section 11 Quick Opening Devices	4", 6" & 8" Electric Actuation (Black) (Solenoid Valve Not Included)	52-477-1-103	\$2,975.00
	4", 6" & 8" Electric Actuation (Brass) (Solenoid Valve Not Included)	52-477-3-103	POA
	4", 6" & 8" Electric Actuation (Stainless Steel) (Solenoid Valve Not Included)	52-477-4-103	POA
	Replacement Diaphragm Kits for the Model DV-5 Deluge Valve		
	1 1/2" DV-5 Deluge Valve Replacement Diaphragm	92-477-1-105	\$801.50
	2" DV-5 Deluge Valve Replacement Diaphragm	92-477-1-107	\$801.50
3" DV-5 Deluge Valve Replacement Diaphragm	92-477-1-109	\$822.00	
Section 12 Air Maintenance Devices	4" DV-5 Deluge Valve Replacement Diaphragm	92-477-1-101	\$2,197.00
	6" DV-5 Deluge Valve Replacement Diaphragm	92-477-1-103	\$3,193.00
	8" DV-5 Deluge Valve Replacement Diaphragm	92-477-1-111	\$6,488.00
	Technical Data Sheets: DV-5 Valve - TFP1305, Wet Pilot - TFP1310, Dry Pilot - TFP1315, Electric Actuation - TFP1320		
Section 13 Deluge Valves & Accessories			
Section 14 Preaction Systems			
Section 15 General Purpose Valves			

Refer to the latest technical data sheets for specific approvals, listings, design parameters, and available options on www.tyco-fire.com.

Model DP-1, Dry Pilot Actuator

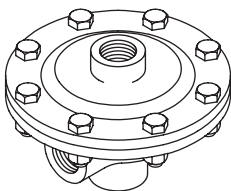
<i>Description</i>	<i>Part Number</i>	<i>List Price</i>
 Dry Pilot Actuator Model DP-1	52-280-1-001P	\$1,161.00
Replacement Parts for DP-1 Dry Pilot Actuator		
Diaphragm	92-280-1-008	\$51.25
Diaphragm, Plate, Sub Assembly	92-280-1-012	\$470.50
Technical Data Sheet - TFP1380		

Deluge Valve Accessories

<i>Description</i>	<i>Part No.</i>	<i>List Price</i>
24 VDC Solenoid Valve	52-287-1-024	\$1,147.00
DP-1 Dry Pilot Actuator	52-280-1-001P	\$1,161.00
PSI Alarm Switch Model PS40-2A	2573	\$250.00
Automatic Ball Drip Valve, Plunger Type (AD-1)	51-793-1-004	\$164.50
Manual Control Station (MC-1)	52-289-1-001	\$498.50
Model PS 10 - 2A Pressure Alarm Switch	2571	\$243.50
Model OSYSU-2 Monitor Switch	2412	\$198.50
Model WMA-1 Water Motor Alarm	52-630-1-001	\$769.00
Model PFC 4410 Fire Control Panel.	20125	\$2,666.00
Model ASV-1 Automatic Shut-Off Valve	92-343-1-021	\$386.50
Model ASV-1 Automatic Shut-Off Valve (Stainless Steel)	92-343-4-021	POA
Batteries - Two Batteries are required for Stand-by power for each Control Panel. Consult TD Sheets for ratings		
<i>Description</i>	<i>Part No.</i>	<i>List Price (each)</i>
Model BT-80 (8 amp) Stand by Batteries, (2 REQ'D)	2656	\$79.50
Model BT-120 (12 amp) Stand by Batteries, (2 REQ'D)	20128	\$141.00
Notes		
Heat Detectors, Manual Control Stations, Alarm Bells, Trouble Horns, Spray Nozzles, or Open Sprinklers are ordered separately. Contact your local TFP Distributor.		

Refer to the latest technical data sheets for specific approvals, listings, design parameters, and available options on www.tyco-fire.com.

Section 8
Wet System Valves

Section 9
Water Motor Alarms

Section 10
Dry Pipe Valves

Section 11
Quick Opening Devices

Section 12
Air Maintenance Devices

Section 13
Deluge Valves & Accessories

Section 14
Preaction Systems

Section 15
General Purpose Valves

Model DV-5 Deluge Valves With Remote-Resetting Trim

P/N XX-X80-00-261

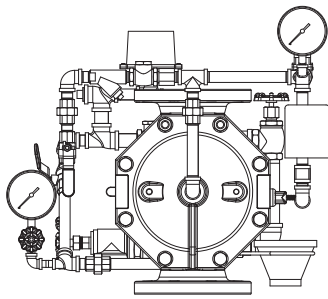
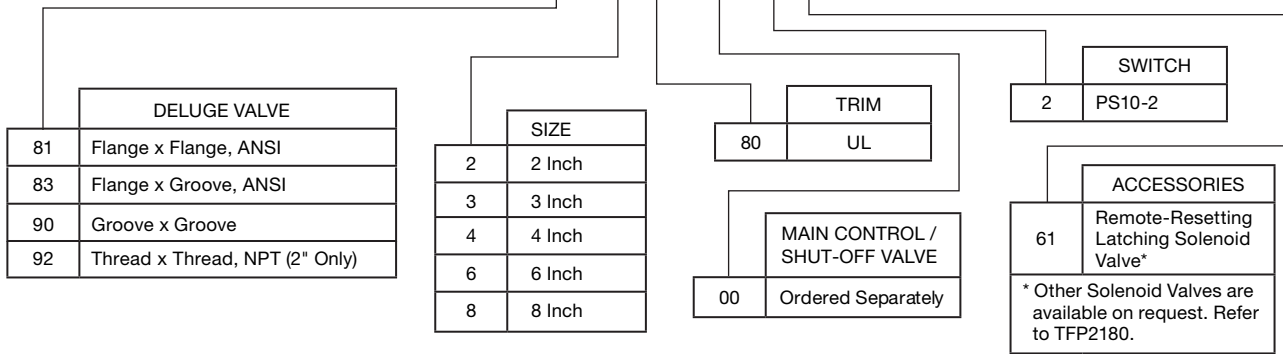

Note: All quotes are FOB manufacturer, considered "Special Order", are Non-Returnable. Refer to "Terms & Conditions" in this document

2" Model DV-5 Deluge Valves with Remote-Resetting Trim, Fully Assembled with UL Trim (Valve Included)

Description (All with Galvanized Trim)	Part No.	List Price
2" Groove x Groove, NPT Ports	90-280-00-261	\$8,757.00
2" Thread x Thread, NPT, NPT Ports	92-280-00-261	\$8,757.00

3" Model DV-5 Deluge Valves with Remote-Resetting Trim, Fully Assembled with UL Trim (Valve Included)

3" Flange x Groove, ANSI, NPT Ports	83-380-00-261	\$9,909.00
3" Groove x Groove, NPT Ports	90-380-00-261	\$9,909.00

4" Model DV-5 Deluge Valves with Remote-Resetting Trim, Fully Assembled with UL Trim (Valve Included)

4" Flange x Groove, ANSI, NPT Ports	83-480-00-261	\$11,944.00
4" Groove x Groove, NPT Ports	90-480-00-261	\$11,944.00

6" Model DV-5 Deluge Valves with Remote-Resetting Trim, Fully Assembled with UL Trim (Valve Included)

6" Flange x Groove, ANSI, NPT Ports	83-680-00-261	\$14,247.00
6" Groove x Groove, NPT Ports	90-680-00-261	\$14,247.00

8" Model DV-5 Deluge Valves with Remote-Resetting Trim, Fully Assembled with UL Trim (Valve Included)

8" Flange x Groove, ANSI, NPT Ports	83-880-00-261	\$19,924.00
8" Groove x Groove, NPT Ports	90-880-00-261	\$19,924.00

Refer to the latest technical data sheets for specific approvals, listings, design parameters, and available options on www.tyco-fire.com.

Model DV-5 Deluge Valves With Remote-Resetting Trim

Required Equipment for Model DV-5 Deluge Valves with Remote-Resetting Trim (Ordered Separately)

<i>Description</i>	<i>Part No.</i>	<i>List Price</i>
2", Semi-Preassembled Vertical Electric Actuation Trim Galvanized Trim (deluge valve, solenoid valve, pressure switch, and butterfly valves ordered separately)	52-477-2-111	\$2,892.00
3", Semi-Preassembled Vertical Electric Actuation Trim Galvanized Trim (deluge valve, solenoid valve, pressure switch, and butterfly valves ordered separately)	52-477-2-112	\$2,892.00
4", Semi-Preassembled Vertical Electric Actuation Trim Galvanized Trim (deluge valve, solenoid valve, pressure switch, and butterfly valves ordered separately)	52-477-2-114	\$2,892.00
6", Semi-Preassembled Vertical Electric Actuation Trim Galvanized Trim (deluge valve, solenoid valve, pressure switch, and butterfly valves ordered separately)	52-477-2-115	\$2,892.00
8", Semi-Preassembled Vertical Electric Actuation Trim Galvanized Trim (deluge valve, solenoid valve, pressure switch, and butterfly valves ordered separately)	52-477-2-116	\$2,892.00
24 VDC Latching Solenoid Valve	2460566	\$1,147.00
Model PS10-1 Waterflow Pressure Switch	25700	\$178.50
Model PS10-2 Dual-Contact Waterflow Pressure Switch	25710	\$186.50
Water Pressure Gauge, 600 psi	92-343-1-004	\$202.50
Accessories for Model DV-5 Deluge Valves with Remote-Resetting Trim		
Model AD-2 Automatic Drain Valve	52-789-1-004	\$80.75
Model WMA-1 Water Motor Alarm	52-630-1-001	\$769.00
Replacement Parts for Model DV-5 Deluge Valves with Remote-Resetting Trim		
2" Model DV-5 Deluge Valve with Remote-Resetting Trim, Replacement Diaphragm	92-477-1-107	\$801.50
3" Model DV-5 Deluge Valve with Remote-Resetting Trim, Replacement Diaphragm	92-477-1-109	\$822.00
4" Model DV-5 Deluge Valve with Remote-Resetting Trim, Replacement Diaphragm	92-477-1-101	\$2,197.00
6" Model DV-5 Deluge Valve with Remote-Resetting Trim, Replacement Diaphragm	92-477-1-103	\$3,193.00
8" Model DV-5 Deluge Valve with Remote-Resetting Trim, Replacement Diaphragm	92-477-1-111	\$6,488.00
Model AD-1 Automatic Drain Valve	52-793-2-004	\$164.50
Model MC-1 Manual Control Station (Galv. Ends) (TFP 1382)	52-289-2-001	\$498.50
24 VDC Impulse Solenoid Valve	2460566	\$1,147.00
Model PS10-1 Waterflow Pressure Switch	25700	\$178.50
Model PS10-2 Dual-Contact Waterflow Pressure Switch	25710	\$186.50
Water Pressure Gauge, 300 psi	92-343-1-005	\$88.75
½" Y Strainer	52-353-1-005	\$69.25

Technical Data Sheet - TFP1331

Section 8
Wet System Valves

Section 9
Water Motor Alarms

Section 10
Dry Pipe Valves

Section 11
Quick Opening Devices

Section 12
Air Maintenance Devices

Section 13
Deluge Valves & Accessories

Section 14
Preaction Systems

Section 15
General Purpose Valves

Model DV-5 Deluge Valves With Remote-Resetting, Pressure-Reducing Trim

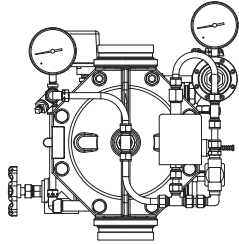
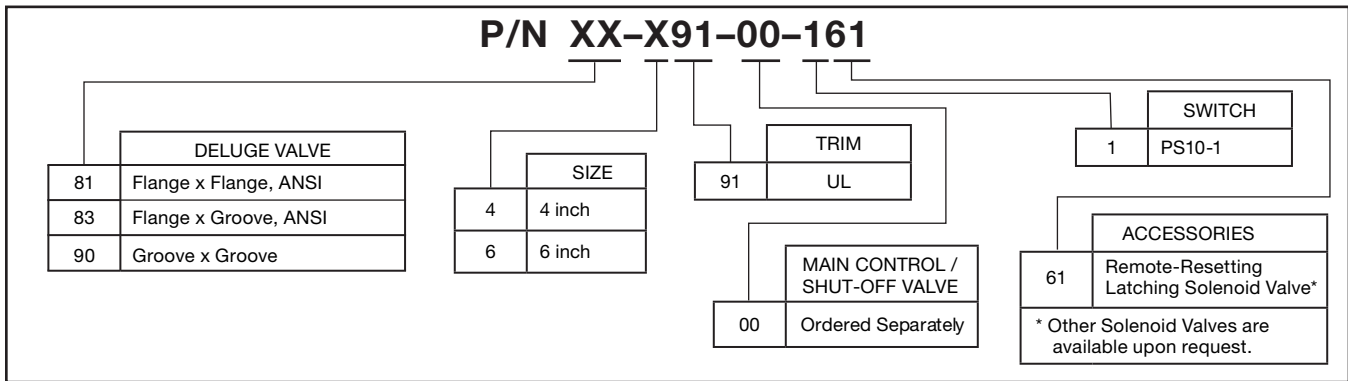

4" Model DV-5 Deluge Valves with Remote-Resetting, Pressure-Reducing Trim Fully Assembled with UL Trim (Valve Included)

<i>Description (All with Brass/Galvanized Trim)</i>	<i>Part No.</i>	<i>List Price</i>
4" Flange x Groove, ANSI, NPT Ports	83-491-00-161	\$12,437.00
4" Groove x Groove, NPT Ports	90-491-00-161	\$12,437.00

6" Model DV-5 Deluge Valves with Remote-Resetting, Pressure-Reducing Trim Fully Assembled with UL Trim (Valve Included)

6" Flange x Groove, ANSI, NPT Ports	83-691-00-161	\$14,871.00
6" Groove x Groove, NPT Ports	90-691-00-161	\$14,871.00

Note: All quotes are FOB manufacturer, considered "Special Order", are Non-Returnable. Refer to "Terms & Conditions" in this document

Refer to the latest technical data sheets for specific approvals, listings, design parameters, and available options on www.tyco-fire.com.

Model DV-5 Deluge Valves With Remote-Resetting, Pressure-Reducing Trim		
Required Equipment for Model DV-5 Deluge Valves with Remote-Resetting, Pressure-Reducing Trim (Ordered Separately)		
<i>Description</i>	<i>Part No.</i>	<i>List Price</i>
4", Semi-Preassembled Vertical Electric Actuation Trim, Brass/Galvanized Trim (deluge valve, solenoid valve, pressure switch, and butterfly valves ordered separately)	52-477-2-117	\$3,197.00
6", Semi-Preassembled Vertical Electric Actuation Trim, Brass/Galvanized Trim (deluge valve, solenoid valve, pressure switch, and butterfly valves ordered separately)	52-477-2-118	\$3,197.00
24 VDC Latching Solenoid Valve	2460566	\$1,147.00
Model PS10-1 Waterflow Pressure Switch	25700	\$178.50
Model PS10-2 Dual-Contact Waterflow Pressure Switch	25710	\$186.50
4" Model BFV-N Butterfly Valve (2 required)	59-300-F-040N	See Section 18 for Valve pricing.
6" Model BFV-N Butterfly Valve (2 required)	59-300-F-060N	
Accessories for Model DV-5 Deluge Valves with Remote-Resetting, Pressure-Reducing Trim		
Model AD-2 Automatic Drain Valve	52-789-1-004	\$80.75
Replacement Parts for Model DV-5 Deluge Valves with Remote-Resetting, Pressure-Reducing Trim		
4" Model DV-5 Deluge Valve with Remote-Resetting, Pressure-Reducing Trim, Replacement Diaphragm	92-477-1-101	\$2,197.00
6" Model DV-5 Deluge Valve with Remote-Resetting, Pressure-Reducing Trim, Replacement Diaphragm	92-477-1-103	\$3,193.00
Model AD-1 Automatic Drain Valve	52-793-2-004	\$164.50
Model MC-1 Manual Control Station (Galv. Ends) (TFP1382)	52-289-2-001	\$498.50
Water Pressure Gauge, 300 psi (2,000 kPa)	92-343-1-005	\$88.75
24 VDC Impulse Solenoid Valve	2460566	\$1,147.00
Model PS10-1 Waterflow Pressure Switch	25700	\$178.50
Model PS10-2 Dual-Contact Waterflow Pressure Switch	25710	\$186.50
Pilot Valve	92-570-2-200	\$1,633.00
½" Spring-Loaded Check Valve (Circle Seal)	92-322-1-002	\$183.00
½" Y Strainer	52-353-1-005	\$69.25
Technical Data Sheet - TFP1332		

Section 8	Wet System Valves
Section 9	Water Motor Alarms
Section 10	Dry Pipe Valves
Section 11	Quick Opening Devices
Section 12	Air Maintenance Devices
Section 13	Deluge Valves & Accessories
Section 14	Preaction Systems
Section 15	General Purpose Valves

Refer to the latest technical data sheets for specific approvals, listings, design parameters, and available options on www.tyco-fire.com.

Full Deluge Systems and Components

The following tables will provide information on equipment, required or optional, needed to complete various system packages. Please see the applicable Technical data pages for more information.

DV-5 Deluge, Wet Pilot Actuation, - 1 1/2" thru 8"

Description	Part No.	List Price
Required Equipment for Deluge Valve (Select One)		
1 1/2 Inch DV-5 Deluge Valve, Groove x Groove	52-477-1-919	\$2,181.00
1 1/2 Inch DV-5 Deluge Valve, Thread x Thread	52-477-1-069	\$2,181.00
2 Inch DV-5 Deluge Valve, Groove x Groove	52-477-1-910	\$2,280.00
2 Inch DV-5 Deluge Valve, Thread x Thread	52-477-1-060	\$2,280.00
3 Inch DV-5 Deluge Valve, Groove x Groove	52-477-1-912	\$2,478.00
3 Inch DV-5 Deluge Valve, Flange x Flange	52-477-1-012	\$2,478.00
3 Inch DV-5 Deluge Valve, Flange x Groove	52-477-1-412	\$2,478.00
4 Inch DV-5 Deluge Valve, Groove x Groove	52-477-1-913	\$4,270.00
4 Inch DV-5 Deluge Valve, Flange x Flange	52-477-1-013	\$4,270.00
4 Inch DV-5 Deluge Valve, Flange x Groove	52-477-4-613	\$4,270.00
6 Inch DV-5 Deluge Valve, Groove x Groove	52-477-1-915	\$5,206.00
6 Inch DV-5 Deluge Valve, Flange x Flange	52-477-1-015	\$5,206.00
6 Inch DV-5 Deluge Valve, Flange x Groove	52-477-4-615	\$5,206.00
8" Model DV-5 Groove x Groove, 250 PSI	52-477-1-916	\$14,899.00
8" Model DV-5 Flange x Groove, 250 PSI	52-477-1-416	\$14,899.00
8" Model DV-5 Flange x Flange, 250 PSI	52-477-1-016	\$14,899.00
Wet Pilot Deluge Trim (Select One) *Galvanized shown is standard		
1 1/2" & 2" Galvanized	52-477-2-107	\$2,975.00
3" Galvanized	52-477-2-104	\$2,975.00
4", 6" & 8" Galvanized	51-477-2-101	\$2,975.00
Water Flow Pressure Switch		
Model PS10-2A	2571	\$243.50
Optional Equipment for Deluge System, Wet Pilot Release		
600 psi Water Pressure Gauge	92-343-1-004	\$202.50
Model WMA-1 Water Motor Alarm	52-630-1-001	\$769.00
Model OSYSU - 2 Monitor Switch	2412	\$198.50
Model MC-1 Manual Control Station (Galv. Ends) (TFP 1382)	52-289-2-001	\$498.50
Note		
Note: Heat Detectors, Alarm Bells, Trouble Horns, Spray Nozzles, or, Open Sprinklers are ordered separately.		
Technical Data Sheet - TFP1310		

Refer to the latest technical data sheets for specific approvals, listings, design parameters, and available options on www.tyco-fire.com.

Full Deluge Systems and Components

The following tables will provide information on equipment, required or optional, needed to complete various system packages. Please see the applicable Technical data pages for more information.

DV-5 Deluge, Dry Pilot Actuation, - 1 1/2" thru 8"

Description	Part No.	List Price
Required Equipment for Deluge Valve (Select One)		
1-1/2 Inch DV-5 Deluge Valve, Groove x Groove	52-477-1-919	\$2,181.00
1-1/2 Inch DV-5 Deluge Valve, Thread x Thread	52-477-1-069	\$2,181.00
2 Inch DV-5 Deluge Valve, Groove x Groove	52-477-1-910	\$2,280.00
2 Inch DV-5 Deluge Valve, Thread x Thread	52-477-1-060	\$2,280.00
3 Inch DV-5 Deluge Valve, Groove x Groove	52-477-1-912	\$2,478.00
3 Inch DV-5 Deluge Valve, Flange x Flange	52-477-1-012	\$2,478.00
3 Inch DV-5 Deluge Valve, Flange x Groove	52-477-1-412	\$2,478.00
4 Inch DV-5 Deluge Valve, Groove x Groove	52-477-1-913	\$4,270.00
4 Inch DV-5 Deluge Valve, Flange x Flange	52-477-1-013	\$4,270.00
4 Inch DV-5 Deluge Valve, Flange x Groove	52-477-4-613	\$4,270.00
6 Inch DV-5 Deluge Valve, Groove x Groove	52-477-1-915	\$5,206.00
6 Inch DV-5 Deluge Valve, Flange x Flange	52-477-1-015	\$5,206.00
6 Inch DV-5 Deluge Valve, Flange x Groove	52-477-4-615	\$5,206.00
8" Model DV-5 Groove x Groove, 250 PSI	52-477-1-916	\$14,899.00
8" Model DV-5 Flange x Groove, 250 PSI	52-477-1-416	\$14,899.00
8" Model DV-5 Flange x Flange, 250 PSI	52-477-1-016	\$14,899.00
Dry Pilot Deluge Trim (Select One) *Galvanized shown is standard		
1 1/2" & 2" Galvanized	52-477-2-108	\$3,964.00
3" Galvanized	52-477-2-105	\$3,964.00
4", 6" & 8" Galvanized	52-477-2-102	\$4,023.00
Water Flow Pressure Switch		
Model PS10-2A	2571	\$243.50
Dry Pilot Low Air Pressure Switch		
Model PS40-2A	2573	\$250.00
Automatic System Air Supply (Select One)		
Model AMD-1 Air Maintenance Device (TFP 1221)	52-324-2-002	\$983.00
Model AMD-2 Air Maintenance Device (TFP 1231)	52-326-2-001	\$1,449.00
Model AMD-3 Nitrogen Air Maintenance Device (TFP 1241)	52-328-2-001	\$1,924.00
Optional Equipment for Deluge System, Dry Pilot Release		
600 psi Water Pressure Gauge	92-343-1-004	\$202.50
Model WMA-1 Water Motor Alarm	52-630-1-001	\$769.00
Model OSYSU - 2 Monitor Switch	2412	\$198.50
Model MC-1 Manual Control Station (Galv. Ends) (TFP 1382)	52-289-2-001	\$498.50
Note		
Note: Heat Detectors, Alarm Bells, Trouble Horns, Spray Nozzles, or, Open Sprinklers are ordered separately.		
Technical Data Sheet - TFP1315		

Section 8
Wet System Valves

Section 9
Water Motor Alarms

Section 10
Dry Pipe Valves

Section 11
Quick Opening Devices

Section 12
Air Maintenance Devices

Section 13
Deluge Valves & Accessories

Section 14
Preaction Systems

Section 15
General Purpose Valves

Refer to the latest technical data sheets for specific approvals, listings, design parameters, and available options on www.tyco-fire.com.

Full Deluge Systems and Components

The following tables will provide information on equipment, required or optional, needed to complete various system packages. Please see the applicable Technical data pages for more information.

DV-5 Deluge, Electric Actuation, - 1 1/2" thru 8"

Description	Part No.	List Price
Required Equipment for Deluge Valve (Select One)		
1 1/2 Inch DV-5 Deluge Valve, Groove x Groove	52-477-1-919	\$2,181.00
1 1/2 Inch DV-5 Deluge Valve, Thread x Thread	52-477-1-069	\$2,181.00
2 Inch DV-5 Deluge Valve, Groove x Groove	52-477-1-910	\$2,280.00
2 Inch DV-5 Deluge Valve, Thread x Thread	52-477-1-060	\$2,280.00
3 Inch DV-5 Deluge Valve, Groove x Groove	52-477-1-912	\$2,478.00
3 Inch DV-5 Deluge Valve, Flange x Flange	52-477-1-012	\$2,478.00
3 Inch DV-5 Deluge Valve, Flange x Groove	52-477-1-412	\$2,478.00
4 Inch DV-5 Deluge Valve, Groove x Groove	52-477-1-913	\$4,270.00
4 Inch DV-5 Deluge Valve, Flange x Flange	52-477-1-013	\$4,270.00
4 Inch DV-5 Deluge Valve, Flange x Groove	52-477-4-613	\$4,270.00
6 Inch DV-5 Deluge Valve, Groove x Groove	52-477-1-915	\$5,206.00
6 Inch DV-5 Deluge Valve, Flange x Flange	52-477-1-015	\$5,206.00
6 Inch DV-5 Deluge Valve, Flange x Groove	52-477-4-615	\$5,206.00
8" Model DV-5 Groove x Groove, 250 PSI	52-477-1-916	\$14,899.00
8" Model DV-5 Flange x Groove, 250 PSI	52-477-1-416	\$14,899.00
8" Model DV-5 Flange x Flange, 250 PSI	52-477-1-016	\$14,899.00
Electric Actuation Deluge Trim (Select One) *Galvanized shown is standard		
1 1/2" & 2" Galvanized	52-477-2-109	\$2,975.00
3" Galvanized	52-477-2-106	\$2,975.00
4", 6" & 8" Galvanized	51-477-2-103	\$2,975.00
Water Flow Pressure Switch		
Model PS10-2A	2571	\$243.50
Solenoid Valve 24VDC (Select One)		
175 psi 24VDC Solenoid Valve	52-287-1-024	\$1,147.00
250 psi 24VDC Solenoid Valve	52-287-1-124	POA
Optional Equipment for Deluge System, Electric Actuation		
600 psi Water Pressure Gauge	92-343-1-004	\$202.50
Model WMA-1 Water Motor Alarm	52-630-1-001	\$769.00
Model OSYSU - 2 Monitor Switch	2412	\$198.50
Model MC-1 Manual Control Station (Galv. Ends) (TFP 1382)	52-289-2-001	\$498.50
Note		
Note: Heat Detectors, Alarm Bells, Trouble Horns, Spray Nozzles, or, Open Sprinklers are ordered separately.		
Technical Data Sheet - TFP1320		

Refer to the latest technical data sheets for specific approvals, listings, design parameters, and available options on www.tyco-fire.com.

**Red-E-Cabinet With DV-5 Deluge Valve
Praction, Single Interlock, Double Interlock and Deluge Packages**

P/N 5 2 - 8 X X - X - X X X

Valve	DV-5 Style	Size	Actuation Device	Air Maintenance Device	Trim Type	US / Canada	Compressor
52	8	1 1/2" = 1	Deluge / Wet = 1	None = 0	Galvanized = 1	None = 0	None = 0
52	8	2" = 2	Deluge / Dry = 2	Please Note: All cabinets ordered with a riser mounted compressor will automatically come with an air maintenance device.	Black = 2	USA = A	1/3 hp 215 Gal = 2
52	8	3" = 3	Deluge / Elec = 3		Brass = 3	Canada = C	1/2 hp 335 Gal = 3
52	8	4" = 4	S/I Wet = 4		For Orders With No Control Panel, Deduct \$325 From The Price		1 hp 610 Gal = 5
52	8	6" = 6	S/I Dry = 5	1 hp 900 Gal = 6			
52	8		S/I Elec = 6	1-1/2 hp 1200 Gal = 7*			
52	8		D/I Elec / Pneu = 7	S/I Compressor = 8			
52	8		D/I Elec / Elec = 8				

* Requires 230V/60Hz

S/I = Single Interlock • D/I = Double Interlock

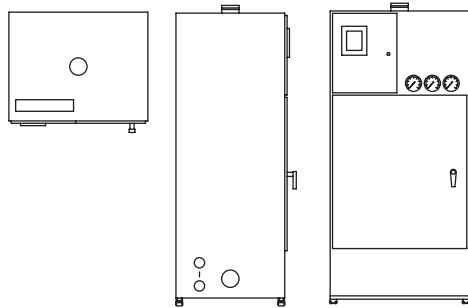

Note:
All quotes are FOB manufacturer and are considered "Special Order" and are Non-Returnable.

For orders with no Control Panel, deduct \$325 from the price

Please see "Terms & Conditions"

Deluge Valve

Description	Canadian Part No.	Canadian List Price	U.S. Part No.	U.S. List Price
Red-E DV-5 1 1/2" Deluge with Electric Actuation, Galvanized Trim, US or Canadian Control Panel	52-813-0-1C0	\$21,256.00	52-813-0-1A0	\$20,153.00
Red-E DV-5 2" Deluge with Electric Actuation, Galvanized Trim, US or Canadian Control Panel	52-823-0-1C0	\$21,507.00	52-823-0-1A0	\$20,393.00
Red-E DV-5 3" Deluge with Electric Actuation, Galvanized Trim, US or Canadian Control Panel	52-833-0-1C0	\$21,702.00	52-833-0-1A0	\$20,578.00
Red-E DV-5 4" Deluge with Electric Actuation, Galvanized Trim, US or Canadian Control Panel	52-843-0-1C0	\$24,052.00	52-843-0-1A0	\$22,846.00
Red-E DV-5 6" Deluge with Electric Actuation, Galvanized Trim, US or Canadian Control Panel	52-863-0-1C0	\$25,260.00	52-863-0-1A0	\$24,008.00

Single Interlock Praction

Red-E DV-5 1 1/2" Single Interlock Praction with Electric Actuation, Galvanized Trim, US or Canadian Control Panel, Single Interlock Compressor	52-816-0-1C8	\$26,094.00	52-816-0-1A8	\$24,812.00
Red-E DV-5 2" Single Interlock Praction with Electric Actuation, Galvanized Trim, US or Canadian Control Panel, Single Interlock Compressor	52-826-0-1C8	\$26,077.00	52-826-0-1A8	\$24,796.00
Red-E DV-5 3" Single Interlock Praction with Electric Actuation, Galvanized Trim, US or Canadian Control Panel, Single Interlock Compressor	52-836-0-1C8	\$26,344.00	52-836-0-1A8	\$25,055.00
Red-E DV-5 4" Single Interlock Praction with Electric Actuation, Galvanized Trim, US or Canadian Control Panel, Single Interlock Compressor	52-846-0-1C8	\$29,595.00	52-846-0-1A8	\$28,188.00
Red-E DV-5 6" Single Interlock Praction with Electric Actuation, Galvanized Trim, US or Canadian Control Panel, Single Interlock Compressor	52-866-0-1C8	\$31,230.00	52-866-0-1A8	\$29,764.00

Refer to the latest technical data sheets for specific approvals, listings, design parameters, and available options on www.tyco-fire.com.

Section 8
Wet System Valves

Section 9
Water Motor Alarms

Section 10
Dry Pipe Valves

Section 11
Quick Opening Devices

Section 12
Air Maintenance Devices

Section 13
Deluge Valves & Accessories

Section 14
Praction Systems

Section 15
General Purpose Valves

Red-E-Cabinet With DV-5 Deluge Valve Praction, Single Interlock, Double Interlock and Deluge Packages					
Double Interlock Praction Electric/Electric Actuation					
	<i>Description</i>	<i>Canadian Part No.</i>	<i>Canadian List Price</i>	<i>U.S. Part No.</i>	<i>U.S. List Price</i>
Section 8 Wet System Valves	Red-E DV-5 1 1/2" Double Interlock Praction Electric-Electric Actuation, Galvanized Trim, US or Canadian Control Panel, 1/6 Hp OL110 Compressor	52-818-0-1C1	\$26,236.00	52-818-0-1A1	\$24,949.00
Section 9 Water Motor Alarms	Red-E DV-5 1 1/2" Double Interlock Praction Electric-Electric Actuation, Galvanized Trim, US or Canadian Control Panel, 1/3 Hp OL215 Compressor	52-818-0-1C2	\$26,760.00	52-818-0-1A2	\$25,456.00
	Red-E DV-5 1 1/2" Double Interlock Praction Electric-Electric Actuation, Galvanized Trim, US or Canadian Control Panel, 1/2 Hp OL335 Compressor	52-818-0-1C3	\$27,278.00	52-818-0-1A3	\$25,954.00
Section 10 Dry Pipe Valves	Red-E DV-5 2" Double Interlock Praction Electric-Electric Actuation, Galvanized Trim, US or Canadian Control Panel, 1/6 Hp OL110 Compressor	52-828-0-1C1	\$26,220.00	52-828-0-1A1	\$24,934.00
	Red-E DV-5 2" Double Interlock Praction Electric-Electric Actuation, Galvanized Trim, US or Canadian Control Panel, 1/3 Hp OL215 Compressor	52-828-0-1C2	\$26,744.00	52-828-0-1A2	\$25,439.00
	Red-E DV-5 2" Double Interlock Praction Electric-Electric Actuation, Galvanized Trim, US or Canadian Control Panel, 1/2 Hp OL335 Compressor	52-828-0-1C3	\$27,260.00	52-828-0-1A3	\$25,937.00
Section 11 Quick Opening Devices	Red-E DV-5 3" Double Interlock Praction Electric-Electric Actuation, Galvanized Trim, US or Canadian Control Panel, 1/6 Hp OL110 Compressor	52-838-0-1C1	\$26,436.00	52-838-0-1A1	\$25,144.00
	Red-E DV-5 3" Double Interlock Praction Electric-Electric Actuation, Galvanized Trim, US or Canadian Control Panel, 1/3 Hp OL215 Compressor	52-838-0-1C2	\$26,963.00	52-838-0-1A2	\$25,648.00
	Red-E DV-5 3" Double Interlock Praction Electric-Electric Actuation, Galvanized Trim, US or Canadian Control Panel, 1/2 Hp OL335 Compressor	52-838-0-1C3	\$27,470.00	52-838-0-1A3	\$26,139.00
	Red-E DV-5 4" Double Interlock Praction Electric-Electric Actuation, Galvanized Trim, UUS or Canadian Control Panel, 1/6 Hp OL110 Compressor	52-848-0-1C1	\$29,689.00	52-848-0-1A1	\$28,277.00
Section 12 Air Maintenance Devices	Red-E DV-5 4" Double Interlock Praction Electric-Electric Actuation, Galvanized Trim, US or Canadian Control Panel, 1/3 Hp OL215 Compressor	52-848-0-1C2	\$30,212.00	52-848-0-1A2	\$28,782.00
	Red-E DV-5 4" Double Interlock Praction Electric-Electric Actuation, Galvanized Trim, US or Canadian Control Panel, 1/2 Hp OL335 Compressor	52-848-0-1C3	\$30,731.00	52-848-0-1A3	\$29,281.00
	Red-E DV-5 4" Double Interlock Praction Electric-Electric Actuation, Galvanized Trim, US or Canadian Control Panel, 3/4 Hp OL435 Compressor	52-848-0-1C4	\$31,456.00	52-848-0-1A4	\$29,981.00
	Red-E DV-5 4" Double Interlock Praction Electric-Electric Actuation, Galvanized Trim, US or Canadian Control Panel, 1 Hp OL610 Compressor	52-848-0-1C5	\$31,532.00	52-848-0-1A5	\$30,051.00
	Red-E DV-5 4" Double Interlock Praction Electric-Electric Actuation, Galvanized Trim, US or Canadian Control Panel, 1 Hp OL900 Compressor	52-848-0-1C6	\$33,399.00	52-848-0-1A6	\$31,852.00
Section 13 Deluge Valves & Accessories	Red-E DV-5 4" Double Interlock Praction Electric-Electric Actuation, Galvanized Trim, US or Canadian Control Panel, 2 Hp OL1200 Compressor	52-848-0-1C7	\$33,900.00	52-848-0-1A7	\$32,335.00
	Red-E DV-5 6" Double Interlock Praction Electric-Electric Actuation, Galvanized Trim, US or Canadian Control Panel, 1/6 Hp OL110 Compressor	52-868-0-1C1	\$31,331.00	52-868-0-1A1	\$29,858.00
	Red-E DV-5 6" Double Interlock Praction Electric-Electric Actuation, Galvanized Trim, US or Canadian Control Panel, 1/3 Hp OL215 Compressor	52-868-0-1C2	\$31,847.00	52-868-0-1A2	\$30,358.00
	Red-E DV-5 6" Double Interlock Praction Electric-Electric Actuation, Galvanized Trim, US or Canadian Control Panel, 1/2 Hp OL335 Compressor	52-868-0-1C3	\$32,365.00	52-868-0-1A3	\$30,856.00
	Red-E DV-5 6" Double Interlock Praction Electric-Electric Actuation, Galvanized Trim, US or Canadian Control Panel, 3/4 Hp OL435 Compressor	52-868-0-1C4	\$33,092.00	52-868-0-1A4	\$31,555.00
	Red-E DV-5 6" Double Interlock Praction Electric-Electric Actuation, Galvanized Trim, US or Canadian Control Panel, 1 Hp OL610 Compressor	52-868-0-1C5	\$33,166.00	52-868-0-1A5	\$31,626.00
	Red-E DV-5 6" Double Interlock Praction Electric-Electric Actuation, Galvanized Trim, US or Canadian Control Panel, 1 Hp OL900 Compressor	52-868-0-1C6	\$35,044.00	52-868-0-1A6	\$33,436.00
Section 14 Praction Systems	Red-E DV-5 6" Double Interlock Praction Electric-Electric Actuation, Galvanized Trim, US or Canadian Control Panel, 2 Hp OL1200 Compressor	52-868-0-1C7	\$35,533.00	52-868-0-1A7	\$33,909.00
Section 15 General Purpose Valves					

Refer to the latest technical data sheets for specific approvals, listings, design parameters, and available options on www.tyco-fire.com.

Red-E-Cabinet With DV-5 Deluge Valve
Precision, Single Interlock, Double Interlock and Deluge Packages

Double Interlock Precision Electric/Pneumatic Actuation

Description	Canadian Part No.	Canadian List Price	U.S. Part No.	U.S. List Price
Red-E DV-5 1-1/2" Double Interlock Precision Electric-Pneumatic Actuation, Galvanized Trim, US or Canadian Control Panel, 1/6 Hp OL110 Compressor	52-817-0-1C1	\$26,603.00	52-817-0-1A1	\$25,304.00
Red-E DV-5 1-1/2" Double Interlock Precision Electric-Pneumatic Actuation, Galvanized Trim, US or Canadian Control Panel, 1/3 Hp OL215 Compressor	52-817-0-1C2	\$27,127.00	52-817-0-1A2	\$25,811.00
Red-E DV-5 1-1/2" Double Interlock Precision Electric-Pneumatic Actuation, Galvanized Trim, US or Canadian Control Panel, 1/2 Hp OL335 Compressor	52-817-0-1C3	\$27,644.00	52-817-0-1A3	\$26,307.00
Red-E DV-5 2" Double Interlock Precision Electric-Pneumatic Actuation, Galvanized Trim, US or Canadian Control Panel, 1/6 Hp OL110 Compressor	52-827-0-1C1	\$26,595.00	52-827-0-1A1	\$25,295.00
Red-E DV-5 2" Double Interlock Precision Electric-Pneumatic Actuation, Galvanized Trim, US or Canadian Control Panel, 1/3 Hp OL215 Compressor	52-827-0-1C2	\$27,112.00	52-827-0-1A2	\$25,793.00
Red-E DV-5 2" Double Interlock Precision Electric-Pneumatic Actuation, Galvanized Trim, US or Canadian Control Panel, 1/2 Hp OL335 Compressor	52-827-0-1C3	\$27,629.00	52-827-0-1A3	\$26,293.00
Red-E DV-5 3" Double Interlock Precision Electric-Pneumatic Actuation, Galvanized Trim, US or Canadian Control Panel, 1/6 Hp OL110 Compressor	52-837-0-1C1	\$27,195.00	52-837-0-1A1	\$25,874.00
Red-E DV-5 3" Double Interlock Precision Electric-Pneumatic Actuation, Galvanized Trim, US or Canadian Control Panel, 1/3 Hp OL215 Compressor	52-837-0-1C2	\$27,720.00	52-837-0-1A2	\$26,379.00
Red-E DV-5 3" Double Interlock Precision Electric-Pneumatic Actuation, Galvanized Trim, US or Canadian Control Panel, 1/2 Hp OL335 Compressor	52-837-0-1C3	\$28,230.00	52-837-0-1A3	\$26,870.00
Red-E DV-5 4" Double Interlock Precision Electric-Pneumatic Actuation, Galvanized Trim, US or Canadian Control Panel, 1/6 Hp OL110 Compressor	52-847-0-1C1	\$30,446.00	52-847-0-1A1	\$29,007.00
Red-E DV-5 4" Double Interlock Precision Electric-Pneumatic Actuation, Galvanized Trim, US or Canadian Control Panel, 1/3 Hp OL215 Compressor	52-847-0-1C2	\$30,972.00	52-847-0-1A2	\$29,514.00
Red-E DV-5 4" Double Interlock Precision Electric-Pneumatic Actuation, Galvanized Trim, US or Canadian Control Panel, 1/2 Hp OL335 Compressor	52-847-0-1C3	\$31,489.00	52-847-0-1A3	\$30,013.00
Red-E DV-5 4" Double Interlock Precision Electric-Pneumatic Actuation, Galvanized Trim, US or Canadian Control Panel, 3/4 Hp OL435 Compressor	52-847-0-1C4	\$32,214.00	52-847-0-1A4	\$30,710.00
Red-E DV-5 4" Double Interlock Precision Electric-Pneumatic Actuation, Galvanized Trim, US or Canadian Control Panel, 1 Hp OL610 Compressor	52-847-0-1C5	\$32,291.00	52-847-0-1A5	\$30,784.00
Red-E DV-5 4" Double Interlock Precision Electric-Pneumatic Actuation, Galvanized Trim, US or Canadian Control Panel, 1 Hp OL900 Compressor	52-847-0-1C6	\$34,158.00	52-847-0-1A6	\$32,583.00
Red-E DV-5 4" Double Interlock Precision Electric-Pneumatic Actuation, Galvanized Trim, US or Canadian Control Panel, 2 Hp OL1200 Compressor	52-847-0-1C7	\$34,658.00	52-847-0-1A7	\$33,066.00
Red-E DV-5 6" Double Interlock Precision Electric-Pneumatic Actuation, Galvanized Trim, US or Canadian Control Panel, 1/6 Hp OL110 Compressor	52-867-0-1C1	\$31,079.00	52-867-0-1A1	\$29,617.00
Red-E DV-5 6" Double Interlock Precision Electric-Pneumatic Actuation, Galvanized Trim, US or Canadian Control Panel, 1/3 Hp OL215 Compressor	52-867-0-1C2	\$31,597.00	52-867-0-1A2	\$30,116.00
Red-E DV-5 6" Double Interlock Precision Electric-Pneumatic Actuation, Galvanized Trim, US or Canadian Control Panel, 1/2 Hp OL335 Compressor	52-867-0-1C3	\$32,114.00	52-867-0-1A3	\$30,614.00
Red-E DV-5 6" Double Interlock Precision Electric-Pneumatic Actuation, Galvanized Trim, US or Canadian Control Panel, 3/4 Hp OL435 Compressor	52-867-0-1C4	\$32,323.00	52-867-0-1A4	\$30,816.00
Red-E DV-5 6" Double Interlock Precision Electric-Pneumatic Actuation, Galvanized Trim, US or Canadian Control Panel, 1 Hp OL610 Compressor	52-867-0-1C5	\$32,915.00	52-867-0-1A5	\$31,385.00
Red-E DV-5 6" Double Interlock Precision Electric-Pneumatic Actuation, Galvanized Trim, US or Canadian Control Panel, 1 Hp OL900 Compressor	52-867-0-1C6	\$34,792.00	52-867-0-1A6	\$33,194.00
Red-E DV-5 6" Double Interlock Precision Electric-Pneumatic Actuation, Galvanized Trim, US or Canadian Control Panel, 2 Hp OL1200 Compressor	52-867-0-1C7	\$35,284.00	52-867-0-1A7	\$33,669.00

Technical Data Sheet Deluge-TFP1300, Precision-TFP1400

Section 8
Wet System Valves

Section 9
Water Motor Alarms

Section 10
Dry Pipe Valves

Section 11
Quick Opening Devices

Section 12
Air Maintenance Devices

Section 13
Deluge Valves & Accessories

Section 14
Precision Systems

Section 15
General Purpose Valves

Refer to the latest technical data sheets for specific approvals, listings, design parameters, and available options on www.tyco-fire.com.

**Red-E-Cabinet with "MCC" Mist Control Center
Preassembled Fire Pump, Controller, Deluge Valve Cabinet & Releasing Panel**

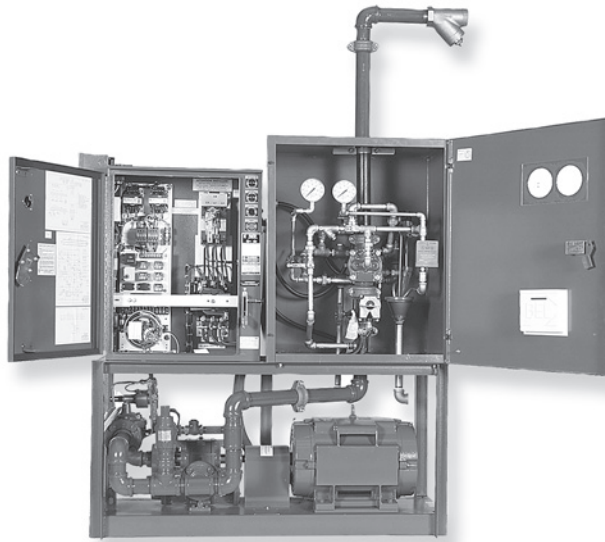

Aquamist Control Center

<i>Description</i>	<i>Part No.</i>	<i>List Price</i>
MCC-1 Mist Control Center, Provides 4-60 GPM	52-811-1-111	POA
MCC-2 Mist Control Center, Provides 60-120 GPM	52-811-1-112	POA

Section 8
Wet System Valves

Section 9
Water Motor Alarms

Section 10
Dry Pipe Valves

Section 11
Quick Opening Devices

Section 12
Air Maintenance Devices

Section 13
Deluge Valves & Accessories

Section 14
Preaction Systems

Section 15
General Purpose Valves

Refer to the latest technical data sheets for specific approvals, listings, design parameters, and available options on www.tyco-fire.com.

**DV-5 Pre-Trimmed Deluge & Preaction Systems,
Wet Pilot, Dry Pilot, or Electric Actuation**

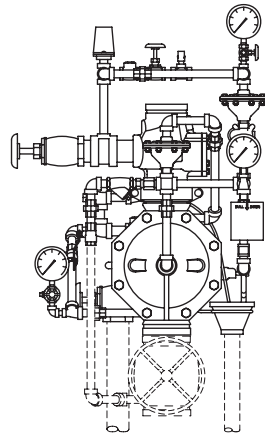

**Each Pre-Trimmed Valve
Contains:**

- Deluge Valve
- Riser Check Valve
- Actuation Trim with Solenoid Valve
- Pneumatic Actuator (if Applicable)
- Pressure Switch
- All Connection Fittings and Devices

Each Pre-Trimmed Valve System Is Individually Palletized and Packaged

Description	Part No.	Average Wt. Ea.	List Price
Pre-Trimmed, Deluge Wet Pilot Actuation, US Model, Groove x Groove			
1 1/2" Pre-Trimmed DV-5 Deluge Valve with Wet Pilot Actuation with Galvanized Trim	52-811-01A-P	-	\$6,187.00
2" Pre-Trimmed DV-5 Deluge Valve with Wet Pilot Actuation with Galvanized Trim	52-821-01A-P	-	\$6,286.00
3" Pre-Trimmed DV-5 Deluge Valve with Wet Pilot Actuation with Galvanized Trim	52-831-01A-P	-	\$6,484.00
4" Pre-Trimmed DV-5 Deluge Valve with Wet Pilot Actuation with Galvanized Trim	52-841-01A-P	-	\$8,275.00
6" Pre-Trimmed DV-5 Deluge Valve with Wet Pilot Actuation with Galvanized Trim	52-861-01A-P	-	\$9,211.00
8" Pre-Trimmed DV-5 Deluge Valve with Wet Pilot Actuation with Galvanized Trim	52-881-01A-P	-	\$18,905.00
Note: For a Complete List of System Components, Please Refer to Page:13-8 Control Valve is Sold Separately, Please Refer to Pages 15-2 & 15-3			
Pre-Trimmed, Deluge Dry Pilot Actuation, US Model, Groove x Groove			
1 1/2" Pre-Trimmed DV-5 Deluge Valve with Dry Pilot Actuation with Galvanized Trim	52-812-01A-P	-	\$7,189.00
2" Pre-Trimmed DV-5 Deluge Valve with Dry Pilot Actuation with Galvanized Trim	52-822-01A-P	-	\$7,288.00
3" Pre-Trimmed DV-5 Deluge Valve with Dry Pilot Actuation with Galvanized Trim	52-832-01A-P	-	\$7,486.00
4" Pre-Trimmed DV-5 Deluge Valve with Dry Pilot Actuation with Galvanized Trim	52-842-01A-P	-	\$9,277.00
6" Pre-Trimmed DV-5 Deluge Valve with Dry Pilot Actuation with Galvanized Trim	52-862-01A-P	-	\$10,213.00
8" Pre-Trimmed DV-5 Deluge Valve with Dry Pilot Actuation with Galvanized Trim	52-882-01A-P	-	\$19,907.00
Note: For a Complete List of System Components, Please Refer to Page:13-9 Control Valve is Sold Separately, Please Refer to Pages 15-2 & 15-3			
Pre-Trimmed, Deluge Electric Actuation, US Model, Groove x Groove			
1 1/2" Pre-Trimmed DV-5 Deluge Valve with Electric Actuation with Galvanized Trim	52-813-01A-P	75 Lbs	\$6,187.00
2" Pre-Trimmed DV-5 Deluge Valve with Electric with Galvanized Trim	52-823-01A-P	75 Lbs	\$6,286.00
3" Pre-Trimmed DV-5 Deluge Valve with Electric with Galvanized Trim	52-833-01A-P	120 Lbs	\$6,484.00
4" Pre-Trimmed DV-5 Deluge Valve with Electric with Galvanized Trim	52-843-01A-P	160 Lbs	\$8,275.00
6" Pre-Trimmed DV-5 Deluge Valve with Electric with Galvanized Trim	52-863-01A-P	220 Lbs	\$9,211.00
8" Pre-Trimmed DV-5 Deluge Valve with Electric with Galvanized Trim	52-883-01A-P	280 Lbs	\$18,905.00
Note: For a Complete List of System Components, Please Refer to Page:13-10 Control Valve is Sold Separately, Please Refer to Pages 15-2 & 15-3			

Section 8 Wet System Valves
 Section 9 Water Motor Alarms
 Section 10 Dry Pipe Valves
 Section 11 Quick Opening Devices
 Section 12 Air Maintenance Devices
 Section 13 Deluge Valves & Accessories
 Section 14 Preaction Systems
 Section 15 General Purpose Valves

Refer to the latest technical data sheets for specific approvals, listings, design parameters, and available options on www.tyco-fire.com.

**DV-5 Pre-Trimmed Deluge & Preaction Systems,
Single or Double Interlock**

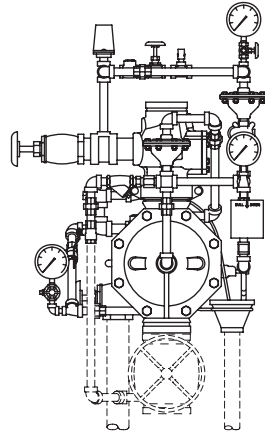

**Each Pre-Trimmed Valve
Contains:**

- Deluge Valve
- Riser Check Valve
- Actuation Trim with Solenoid Valve
- Pneumatic Actuator (if Applicable)
- Pressure Switch
- All Connection Fittings and Devices

Each Pre-Trimmed Valve System Is Individually Palletized and Packaged

Description	Part No.	Average Wt. Ea.	List Price
Pre-Trimmed, Double Interlock Electric-Pneumatic Actuation, US Model, Groove x Groove			
1 1/2" Pre-Trimmed DV-5 Double Interlock "Electric-Pneumatic" Actuation with Galvanized Trim	52-817-01A-P	75 Lbs	\$9,554.00
2" Pre-Trimmed DV-5 Double Interlock "Electric-Pneumatic" Actuation with Galvanized Trim	52-827-01A-P	75 Lbs	\$9,554.00
3" Pre-Trimmed DV-5 Double Interlock "Electric-Pneumatic" Actuation with Galvanized Trim	52-837-01A-P	120 Lbs	\$9,629.00
4" Pre-Trimmed DV-5 Double Interlock "Electric-Pneumatic" Actuation with Galvanized Trim	52-847-01A-P	160 Lbs	\$11,590.00
6" Pre-Trimmed DV-5 Double Interlock "Electric-Pneumatic" Actuation with Galvanized Trim	52-867-01A-P	220 Lbs	\$12,654.00
8" Pre-Trimmed DV-5 Double Interlock "Electric-Pneumatic" Actuation with Galvanized Trim	52-887-01A-P	280 Lbs	POA
Note: For a Complete List of System Components, Please Refer to Page:14-4 Control Valve is Sold Separately, Please Refer to Pages 15-2 & 15-3			
Pre-Trimmed, Double Interlock Electric-Electric Actuation, US Model, Groove x Groove			
1 1/2" Pre-Trimmed DV-5 Double Interlock "Electric-Electric" Actuation with Galvanized Trim	52-818-01A-P	75 Lbs	\$7,273.00
2" Pre-Trimmed DV-5 Double Interlock "Electric-Electric" Actuation with Galvanized Trim	52-828-01A-P	75 Lbs	\$7,273.00
3" Pre-Trimmed DV-5 Double Interlock "Electric-Electric" Actuation with Galvanized Trim	52-838-01A-P	120 Lbs	\$7,349.00
4" Pre-Trimmed DV-5 Double Interlock "Electric-Electric" Actuation with Galvanized Trim	52-848-01A-P	160 Lbs	\$9,171.00
6" Pre-Trimmed DV-5 Double Interlock "Electric-Electric" Actuation with Galvanized Trim	52-868-01A-P	220 Lbs	\$10,333.00
8" Pre-Trimmed DV-5 Double Interlock "Electric-Electric" Actuation with Galvanized Trim	52-888-01A-P	280 Lbs	POA
Note: For a Complete List of System Components, Please Refer to Page:14-5, Control Valve is Sold Separately, Please Refer to Pages 15-2 & 15-3			
Pre-Trimmed, Single Interlock Electric Actuation, US Model, Groove x Groove			
1 1/2" Pre-Trimmed DV-5 Single Interlock Electric Actuation with Galvanized Trim	52-816-01A-P	75 Lbs	\$7,471.00
2" Pre-Trimmed DV-5 Single Interlock Electric Actuation with Galvanized Trim	52-826-01A-P	75 Lbs	\$7,471.00
3" Pre-Trimmed DV-5 Single Interlock Electric Actuation with Galvanized Trim	52-836-01A-P	120 Lbs	\$7,549.00
4" Pre-Trimmed DV-5 Single Interlock Electric Actuation with Galvanized Trim	52-846-01A-P	160 Lbs	\$10,012.00
6" Pre-Trimmed DV-5 Single Interlock Electric Actuation with Galvanized Trim	52-866-01A-P	220 Lbs	\$11,083.00
8" Pre-Trimmed DV-5 Single Interlock Electric Actuation with Galvanized Trim	52-886-01A-P	280 Lbs	POA
Note: For a Complete List of System Components, Please Refer to Page:14-3, Control Valve is Sold Separately, Please Refer to Pages 15-2 & 15-3			

Refer to the latest technical data sheets for specific approvals, listings, design parameters, and available options on www.tyco-fire.com.

DV-5 Pre-Trimmed Deluge & Preaction Systems with Remote-Resetting or Remote-Resetting, Pressure Reducing Trim

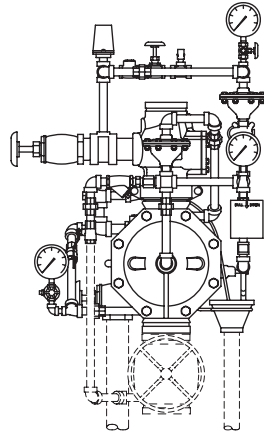

Each Pre-Trimmed Valve Contains:

- Deluge Valve
- Riser Check Valve
- Actuation Trim with Solenoid Valve
- Pneumatic Actuator (if Applicable)
- Pressure Switch
- All Connection Fittings and Devices

Each Pre-Trimmed Valve System Is Individually Palletized and Packaged

<i>Description</i>	<i>Part No.</i>	<i>List Price</i>
Pre-Trimmed with Remote-Resetting Trim, US Model, Groove x Groove		
2" Pre-Trimmed DV-5 Deluge Valve with Remote-Resetting Trim	90-280-00-261	\$8,757.00
3" Pre-Trimmed DV-5 Deluge Valve with Remote-Resetting Trim	90-380-00-261	\$9,909.00
4" Pre-Trimmed DV-5 Deluge Valve with Remote-Resetting Trim	90-480-00-261	\$11,944.00
6" Pre-Trimmed DV-5 Deluge Valve with Remote-Resetting Trim	90-680-00-261	\$14,247.00
8" Pre-Trimmed DV-5 Deluge Valve with Remote-Resetting Trim	90-880-00-261	\$19,924.00
Note: For a Complete List of System Components, Please Refer to Pages:13-4 & 13-5 Control Valve is Sold Separately, Please Refer to Pages 15-2 & 15-3		
Pre-Trimmed with Remote-Resetting, Pressure Reducing Trim, US Model, Groove x Groove		
4" Pre-Trimmed DV-5 Deluge Valve with Remote-Resetting, Pressure Reducing Trim	90-491-00-161	\$12,437.00
6" Pre-Trimmed DV-5 Deluge Valve with Remote-Resetting, Pressure Reducing Trim	90-691-00-161	\$14,871.00
Note: For a Complete List of System Components, Please Refer to Pages:13-6 & 13-7 Control Valve is Sold Separately, Please Refer to Pages 15-2 & 15-3		

Section 8	Wet System Valves
Section 9	Water Motor Alarms
Section 10	Dry Pipe Valves
Section 11	Quick Opening Devices
Section 12	Air Maintenance Devices
Section 13	Deluge Valves & Accessories
Section 14	Preaction Systems
Section 15	General Purpose Valves

Refer to the latest technical data sheets for specific approvals, listings, design parameters, and available options on www.tyco-fire.com.

Section 8 Wet System Valves
Section 9 Water Motor Alarms
Section 10 Dry Pipe Valves
Section 11 Quick Opening Devices
Section 12 Air Maintenance Devices
Section 13 Deluge Valves & Accessories
Section 14 Preaction Systems
Section 15 General Purpose Valves

Refer to the latest technical data sheets for specific approvals, listings, design parameters, and available options on www.tyco-fire.com.

Full Praction Systems and Components

The following tables will provide information on equipment, required or optional, needed to complete various system packages. Please see the applicable Technical data pages for more information.

DV-5 Single Interlock, Wet Pilot Actuation, - 1 1/2" thru 8"

Description	Part No.	List Price
Required Equipment for Deluge Valve (Select One) *P/N for GRXGR shown. (See data sheets for other end configurations)		
1 1/2" DV-5 Deluge Valve, Groove x Groove	52-477-1-919	\$2,181.00
2" DV-5 Deluge Valve, Groove x Groove	52-477-1-910	\$2,280.00
3" DV-5 Deluge Valve, Groove x Groove	52-477-1-912	\$2,478.00
4" DV-5 Deluge Valve, Groove x Groove	52-477-1-913	\$4,270.00
6" DV-5 Deluge Valve, Groove x Groove	52-477-1-915	\$5,206.00
8" DV-5 Deluge Valve, Groove x Groove	52-477-1-916	\$14,899.00
Riser Check Valve (Select One) *For 1 1/2" DV-5, use 2" Riser Check		
2" CV-1FR Riser Check Valve	59-590-1-020	\$655.50
3" CV-1FR Riser Check Valve	59-590-1-030	\$655.50
4" CV-1FR Riser Check Valve	59-590-1-040	\$655.50
6" CV-1FR Riser Check Valve	59-590-1-060	\$1,217.00
8" CV-1FR Riser Check Valve	59-590-1-080	\$2,202.00
Coupling (Select One)		
2 x 1 1/2" Figure 716 Reducing Coupling (for 1 1/2" DV-5)	7162015ES	See Section 18 for current list prices
2" Figure 577 Rigid Coupling	57720ASC	
3" Figure 577 Rigid Coupling	57730ASC	
4" Figure 577 Rigid Coupling	57740ASC	
6" Figure 577 Rigid Coupling	57760ASC	
8" Figure 577 Rigid Coupling	57780ASC	
Single Interlock Wet Pilot Praction Trim (Select One) *Galvanized shown is standard		
1 1/2" & 2" Galvanized	52-478-2-117	\$4,113.00
3" Galvanized	52-478-2-114	\$4,264.00
4", 6" and 8" Galvanized	52-478-2-111	\$4,560.00
Automatic System Air Supply (Select One)		
Model AMD-1 Air Maintenance Device (TFP 1221)	52-324-2-002	\$983.00
Model AMD-2 Air Maintenance Device (TFP 1231)	52-326-2-001	\$1,449.00
Model G16AC812 Supervisory Air Supply (TD126)	52-150-1-001	\$2,774.00
Optional Equipment for S/I Praction System, Wet Pilot Release		
600 psi Water Pressure Gauge	92-343-1-004	\$202.50
Model WMA-1 Water Motor Alarm	52-630-1-001	\$769.00
Model OSYSU - 2 Monitor Switch	2412	\$198.50
Model MC-1 Manual Control Station (Galv. Ends) (TFP 1382)	52-289-2-001	\$498.50
Note		
Note: Heat Detectors, Alarm Bells, Trouble Horns, Spray Nozzles, or, Open Sprinklers are ordered separately.		
Technical Data Sheet - TFP1410		

Section 8
Wet System Valves

Section 9
Water Motor Alarms

Section 10
Dry Pipe Valves

Section 11
Quick Opening Devices

Section 12
Air Maintenance Devices

Section 13
Deluge Valves & Accessories

Section 14
Praction Systems

Section 15
General Purpose Valves

Refer to the latest technical data sheets for specific approvals, listings, design parameters, and available options on www.tyco-fire.com.

Full Praction Systems and Components

The following tables will provide information on equipment, required or optional, needed to complete various system packages. Please see the applicable Technical data pages for more information.

DV-5 Single Interlock, Dry Pilot Actuation, - 1 1/2" thru 8"

<i>Description</i>	<i>Part No.</i>	<i>List Price</i>
Required Equipment for Deluge Valve (Select One) *P/N for GRXGR shown. See data sheets for other end configurations		
1 1/2" DV-5 Deluge Valve, Groove x Groove	52-477-1-919	\$2,181.00
2" DV-5 Deluge Valve, Groove x Groove	52-477-1-910	\$2,280.00
3" DV-5 Deluge Valve, Groove x Groove	52-477-1-912	\$2,478.00
4" DV-5 Deluge Valve, Groove x Groove	52-477-1-913	\$4,270.00
6" DV-5 Deluge Valve, Groove x Groove	52-477-1-915	\$5,206.00
8" DV-5 Deluge Valve, Groove x Groove	52-477-1-916	\$14,899.00
Riser Check Valve (Select One) *For 1 1/2" DV-5, use 2" Riser Check		
2" CV-1FR Riser Check Valve	59-590-1-020	\$655.50
3" CV-1FR Riser Check Valve	59-590-1-030	\$655.50
4" CV-1FR Riser Check Valve	59-590-1-040	\$655.50
6" CV-1FR Riser Check Valve	59-590-1-060	\$1,217.00
8" CV-1FR Riser Check Valve	59-590-1-080	\$2,202.00
Coupling (Select One)		
2" x 1 1/2" Inch Figure 716 Reducing Coupling (for 1 1/2" DV-5)	7162015ES	See Section 18 for current list prices
2" Figure 577 Rigid Coupling	57720ASC	
3" Figure 577 Rigid Coupling	57730ASC	
4" Figure 577 Rigid Coupling	57740ASC	
6" Figure 577 Rigid Coupling	57760ASC	
8" Figure 577 Rigid Coupling	57780ASC	
Single Interlock Dry Pilot Praction Trim (Select One) *Galvanized shown is standard		
1 1/2" & 2" Galvanized	52-478-2-118	\$5,403.00
3" Galvanized	52-478-2-115	\$5,552.00
4", 6" and 8" Galvanized	52-478-2-112	\$5,849.00
Automatic System Air Supply (Select One)		
Model AMD-1 Air Maintenance Device (TFP 1221)	52-324-2-002	\$983.00
Model AMD-3 Nitrogen Air Maintenance Device (TFP 1241)	52-328-2-001	\$1,924.00
Model G16AC812 Supervisory Air Supply (TD126)	52-150-1-001	\$2,774.00
Dry Pilot Line Air Supply (Select One) *Must be ordered separately from Automatic System Air Supply		
Model AMD-1 Air Maintenance Device (TFP 1221)	52-324-2-002	\$983.00
Model AMD-2 Air Maintenance Device (TFP 1231)	52-326-2-001	\$1,449.00
Model AMD-3 Nitrogen Air Maintenance Device (TFP 1241)	52-328-2-001	\$1,924.00
Optional Equipment for S/I Praction System, Dry Pilot Release		
600 psi Water Pressure Gauge	92-343-1-004	\$202.50
Model WMA-1 Water Motor Alarm	52-630-1-001	\$769.00
Model OSYSU - 2 Monitor Switch	2412	\$198.50
Model MC-1 Manual Control Station (Galv. Ends) (TFP 1382)	52-289-2-001	\$498.50
Note		
Note: Heat Detectors, Alarm Bells, Trouble Horns, Spray Nozzles, or, Open Sprinklers are ordered separately.		
Technical Data Sheet - TFP1415		

Refer to the latest technical data sheets for specific approvals, listings, design parameters, and available options on www.tyco-fire.com.

Full Praction Systems and Components

The following tables will provide information on equipment, required or optional, needed to complete various system packages. Please see the applicable Technical data pages for more information.

DV-5 Single Interlock, Electric Actuation, - 1 1/2" thru 8"

Description	Part No.	List Price
Required Equipment for Deluge Valve (Select One) *P/N for GRXGR shown. See data sheets for other end configurations		
1 1/2" DV-5 Deluge Valve, Groove x Groove	52-477-1-919	\$2,181.00
2" DV-5 Deluge Valve, Groove x Groove	52-477-1-910	\$2,280.00
3" DV-5 Deluge Valve, Groove x Groove	52-477-1-912	\$2,478.00
4" DV-5 Deluge Valve, Groove x Groove	52-477-1-913	\$4,270.00
6" DV-5 Deluge Valve, Groove x Groove	52-477-1-915	\$5,206.00
8" DV-5 Deluge Valve, Groove x Groove	52-477-1-916	\$14,899.00
Riser Check Valve (Select One) *For 1 1/2" DV-5, use 2" Riser Check		
2" CV-1FR Riser Check Valve	59-590-1-020	\$655.50
3" CV-1FR Riser Check Valve	59-590-1-030	\$655.50
4" CV-1FR Riser Check Valve	59-590-1-040	\$655.50
6" CV-1FR Riser Check Valve	59-590-1-060	\$1,217.00
8" CV-1FR Riser Check Valve	59-590-1-080	\$2,202.00
Coupling (Select One)		
2" x 1 1/2" Figure 716 Reducing Coupling (for 1 1/2" DV-5)	7162015ES	See Section 18 for current list prices
2" Figure 577 Rigid Coupling	57720ASC	
3" Figure 577 Rigid Coupling	57730ASC	
4" Figure 577 Rigid Coupling	57740ASC	
6" Figure 577 Rigid Coupling	57760ASC	
8" Figure 577 Rigid Coupling	57780ASC	
Single Interlock Electric Actuation Praction Trim (Select One) *Galvanized shown is standard		
1 1/2" & 2" Galvanized	52-478-2-119	\$4,215.00
3" Galvanized	52-478-2-116	\$4,362.00
4", 6" and 8" Galvanized	52-478-2-113	\$4,660.00
Automatic System Air Supply (Select One)		
Model AMD-1 Air Maintenance Device (TFP 1221)	52-324-2-002	\$983.00
Model AMD-3 Nitrogen Air Maintenance Device (TFP 1241)	52-328-2-001	\$1,924.00
Model G16AC812 Supervisory Air Supply (TD126)	52-150-1-001	\$2,774.00
Solenoid Valve 24VDC (Select One)		
175 psi 24VDC Solenoid Valve	52-287-1-024	\$1,147.00
250 psi 24VDC Solenoid Valve	52-287-1-124	POA
Optional Equipment for S/I Praction System, Electric Actuation		
600 psi Water Pressure Gauge	92-343-1-004	\$202.50
Model WMA-1 Water Motor Alarm	52-630-1-001	\$769.00
Model OSYSU - 2 Monitor Switch	2412	\$198.50
Model PFC 4410 Fire Control Panel	20135	\$2,635.00
Batteries - Two Batteries are required for Stand-by power for each Control Panel. Refer to TD sheets.		
Model BT - 80 Stand by Batteries, (2 Required, Price shown is Each)	2656	\$79.50
Model BT - 120 Stand by Batteries, (2 Required, Price shown is Each)	20128	\$141.00
Note		
Note: Heat Detectors, Manual Control Stations, Alarm Bells, Trouble Horns, Spray Nozzles, or, Open Sprinklers are ordered separately.		
Technical Data Sheet - TFP1420		

Section 8
Wet System Valves

Section 9
Water Motor Alarms

Section 10
Dry Pipe Valves

Section 11
Quick Opening Devices

Section 12
Air Maintenance Devices

Section 13
Deluge Valves & Accessories

Section 14
Praction Systems

Section 15
General Purpose Valves

Refer to the latest technical data sheets for specific approvals, listings, design parameters, and available options on www.tyco-fire.com.

Full Preaction Systems and Components

The following tables will provide information on equipment, required or optional, needed to complete various system packages. Please see the applicable Technical data pages for more information.

DV-5 Double Interlock, Electric/Pneumatic Actuation, - 1 1/2" thru 8"

Description	Part No.	List Price
Deluge Valve (Select One) *P/N for GRXGR shown. See data sheets for other end configurations		
1-1/2 Inch DV-5 Deluge Valve, Groove x Groove	52-477-1-919	\$2,181.00
2 Inch DV-5 Deluge Valve, Groove x Groove	52-477-1-910	\$2,280.00
3 Inch DV-5 Deluge Valve, Groove x Groove	52-477-1-912	\$2,478.00
4 Inch DV-5 Deluge Valve, Groove x Groove	52-477-1-913	\$4,270.00
6 Inch DV-5 Deluge Valve, Groove x Groove	52-477-1-915	\$5,206.00
8" DV-5 Deluge Valve, Groove x Groove	52-477-1-916	\$14,899.00
Riser Check Valve (Select One) *For 1 1/2" DV-5, use 2" Riser Check		
2" CV-1FR Riser Check Valve	59-590-1-020	\$655.50
3" CV-1FR Riser Check Valve	59-590-1-030	\$655.50
4" CV-1FR Riser Check Valve	59-590-1-040	\$655.50
6" CV-1FR Riser Check Valve	59-590-1-060	\$1,217.00
8" CV-1FR Riser Check Valve	59-590-1-080	\$2,202.00
Coupling (Select One)		
2" x 1 1/2" Figure 716 Reducing Coupling (for 1 1/2" DV-5)	7162015ES	See Section 18 for current list prices
2" Figure 577 Rigid Coupling	57720ASC	
3" Figure 577 Rigid Coupling	57730ASC	
4" Figure 577 Rigid Coupling	57740ASC	
6" Figure 577 Rigid Coupling	57760ASC	
8" Figure 577 Rigid Coupling	57780ASC	
Double Interlock E/P Preaction Trim (Select One) *Galvanized shown is standard		
1 1/2" & 2" Galvanized	52-478-2-127	\$5,470.00
3" Galvanized	52-478-2-124	\$5,728.00
4", 6" and 8" Galvanized	52-478-2-121	\$5,984.00
Automatic System Air Supply (Select One)		
Model AMD-1 Air Maintenance Device (TFP 1221)	52-324-2-002	\$983.00
Model AMD-2 Air Maintenance Device (TFP 1231)	52-326-2-001	\$1,449.00
Model AMD-3 Nitrogen Air Maintenance Device (TFP 1241)	52-328-2-001	\$1,924.00
Solenoid Valve 24VDC (Select One)		
175 psi 24VDC Solenoid Valve	52-287-1-024	\$1,147.00
250 psi 24VDC Solenoid Valve	52-287-1-124	POA
Optional Equipment for D/I Preaction System, Electric/Pneumatic Release		
600 psi Water Pressure Gauge	92-343-1-004	\$202.50
Model WMA-1 Water Motor Alarm	52-630-1-001	\$769.00
Model OSYSU - 2 Monitor Switch	2412	\$198.50
Model PFC 4410 Fire Control Panel	20135	\$2,635.00
Batteries - Two Batteries are required for Stand-by power for each Control Panel. Refer to TD sheets.		
Model BT - 80 Stand by Batteries, (2 Required, Price shown is Each)	2656	\$79.50
Model BT - 120 Stand by Batteries, (2 Required, Price shown is Each)	20128	\$141.00
Note		
Note: Heat Detectors, Manual Control Stations, Alarm Bells, Trouble Horns, Spray Nozzles, or, Open Sprinklers are ordered separately.		
Technical Data Sheet - TFP1460		

Refer to the latest technical data sheets for specific approvals, listings, design parameters, and available options on www.tyco-fire.com.

Full Praction Systems and Components

The following tables will provide information on equipment, required or optional, needed to complete various system packages. Please see the applicable Technical data pages for more information.

DV-5 Double Interlock, Electric/Electric Actuation, - 1 1/2" thru 8"

Description	Part No.	List Price
Required Equipment for Deluge Valve (Select One) *P/N for GRXGR shown. See data sheets for other end configurations		
1-1/2 Inch DV-5 Deluge Valve, Groove x Groove	52-477-1-919	\$2,181.00
2 Inch DV-5 Deluge Valve, Groove x Groove	52-477-1-910	\$2,280.00
3 Inch DV-5 Deluge Valve, Groove x Groove	52-477-1-912	\$2,478.00
4 Inch DV-5 Deluge Valve, Groove x Groove	52-477-1-913	\$4,270.00
6 Inch DV-5 Deluge Valve, Groove x Groove	52-477-1-915	\$5,206.00
8" DV-5 Deluge Valve, Groove x Groove	52-477-1-916	\$14,899.00
Riser Check Valve (Select One) *For 1 1/2" DV-5, use 2" Riser Check		
2" CV-1FR Riser Check Valve	59-590-1-020	\$655.50
3" CV-1FR Riser Check Valve	59-590-1-030	\$655.50
4" CV-1FR Riser Check Valve	59-590-1-040	\$655.50
6" CV-1FR Riser Check Valve	59-590-1-060	\$1,217.00
8" CV-1FR Riser Check Valve	59-590-1-080	\$2,202.00
Coupling (Select One)		
2" x 1 1/2" Figure 716 Reducing Coupling (for 1 1/2" DV-5)	7162015ES	See Section 18 for current list prices
2" Figure 577 Rigid Coupling	57720ASC	
3" Figure 577 Rigid Coupling	57730ASC	
4" Figure 577 Rigid Coupling	57740ASC	
6" Figure 577 Rigid Coupling	57760ASC	
8" Figure 577 Rigid Coupling	57780ASC	
Double Interlock E/E Praction Trim (Select One) *Galvanized shown is standard		
1 1/2" & 2" Galvanized	52-478-2-128	\$3,964.00
3" Galvanized	52-478-2-125	\$4,063.00
4", 6" and 8" Galvanized	52-478-2-122	\$4,362.00
Automatic System Air Supply (Select One)		
Model AMD-1 Air Maintenance Device (TFP 1221)	52-324-2-002	\$983.00
Model AMD-3 Nitrogen Air Maintenance Device (TFP 1241)	52-328-2-001	\$1,924.00
Solenoid Valve 24VDC (Select One)		
175 psi 24VDC Solenoid Valve	52-287-1-024	\$1,147.00
250 psi 24VDC Solenoid Valve	52-287-1-124	POA
Optional Equipment for D/I Praction System, Electric/Electric Release		
600 psi Water Pressure Gauge	92-343-1-004	\$202.50
Model WMA-1 Water Motor Alarm	52-630-1-001	\$769.00
Model OSYSU - 2 Monitor Switch	2412	\$198.50
Model PFC 4410 Fire Control Panel	20135	\$2,635.00
Batteries - Two Batteries are required for Stand-by power for each Control Panel. Refer to TD sheets.		
Model BT - 80 Stand by Batteries, (2 Required, Price shown is Each)	2656	\$79.50
Model BT - 120 Stand by Batteries, (2 Required, Price shown is Each)	20128	\$141.00
Note		
Note: Heat Detectors, Manual Control Stations, Alarm Bells, Trouble Horns, Spray Nozzles, or, Open Sprinklers are ordered separately.		
Technical Data Sheet - TFP1465		

Section 8
Wet System Valves

Section 9
Water Motor Alarms

Section 10
Dry Pipe Valves

Section 11
Quick Opening Devices

Section 12
Air Maintenance Devices

Section 13
Deluge Valves & Accessories

Section 14
Praction Systems

Section 15
General Purpose Valves

Refer to the latest technical data sheets for specific approvals, listings, design parameters, and available options on www.tyco-fire.com.

Section 8 Wet System Valves
Section 9 Water Motor Alarms
Section 10 Dry Pipe Valves
Section 11 Quick Opening Devices
Section 12 Air Maintenance Devices
Section 13 Deluge Valves & Accessories
Section 14 Preaction Systems
Section 15 General Purpose Valves

Optional Equipment for Single Interlock, Preaction Systems, Supervised		
<i>Description</i>	<i>Part No.</i>	<i>List Price (Each)</i>
Low Pressure Alarm Switch for Dry Pilot Actuation (PS402A)	2573	\$250.00
Pressure Alarm Switch Model PS10 - 2A	2571	\$243.50
Model WMA-1 Water Motor Alarm	52-630-1-001	\$769.00
Model OSYSU - 2 Monitor Switch	2412	\$198.50
Model PFC 4410 Fire Control Panel	20135	\$2,635.00
Batteries - Two Batteries are required for Stand-by power for each Control Panel. Consult TD Sheets for ratings		
<i>Description</i>	<i>Part No.</i>	<i>List Price (Each)</i>
Model BT-80 (8 amp) Stand by Batteries, (2 REQ'D)	2656	\$79.50
Model BT-120 (12 amp) Stand by Batteries, (2 REQ'D)	20128	\$141.00
Notes		
Heat Detectors, Manual Control Stations, Alarm Bells, Trouble Horns, Compressors, Spray Nozzles, or, Open Sprinklers are ordered separately.		

Refer to the latest technical data sheets for specific approvals, listings, design parameters, and available options on www.tyco-fire.com.

Preaction Trim for Model DV-5		
<i>Description</i>	<i>Part No.</i>	<i>List Price</i>
Preaction Trim Kits for Model DV-5 Deluge Valves - 1-1/2" and 2"		
1 1/2" and 2" Supervised Single Interlock Preaction Trim with Wet Pilot Actuation (Galvanized) (Standard Order)	52-478-2-117	\$4,113.00
1 1/2" and 2" Supervised Single Interlock Preaction Trim with Wet Pilot Actuation (Black)	52-478-1-117	\$4,113.00
1 1/2" and 2" Supervised Single Interlock Preaction Trim with Wet Pilot Actuation (Brass)	–	POA
1 1/2" and 2" Supervised Single Interlock Preaction Trim with Dry Pilot Actuation (Galvanized) (Standard Order)	52-478-2-118	\$5,403.00
1 1/2" and 2" Supervised Single Interlock Preaction Trim with Dry Pilot Actuation (Black)	52-478-1-118	\$5,403.00
1 1/2" and 2" Supervised Single Interlock Preaction Trim with Dry Pilot Actuation (Brass)	–	POA
1 1/2" and 2" Supervised Single Interlock Preaction Trim with Electric Actuation (Galvanized) (Standard Order) (Solenoid Valve Not Included)	52-478-2-119	\$4,215.00
1 1/2" and 2" Supervised Single Interlock Preaction Trim with Electric Actuation (Black) (Solenoid Valve Not Included)	52-478-1-119	\$4,215.00
1 1/2" and 2" Supervised Single Interlock Preaction Trim with Electric Actuation (Brass) (Solenoid Valve Not Included)	–	POA
1 1/2" and 2" Double Interlock Preaction Trim with Electric/Pneumatic Release (Galvanized) (Standard Order)	52-478-2-127	\$5,470.00
1 1/2" and 2" Double Interlock Preaction Trim with Electric/Pneumatic Release (Black)	52-478-1-127	\$6,641.00
1 1/2" and 2" Double Interlock Preaction Trim with Electric/Pneumatic Release (Brass)	–	POA
1 1/2" and 2" Double Interlock Preaction Trim with Electric/Electric Release (Galvanized) (Standard Order)	52-478-2-128	\$3,964.00
1 1/2" and 2" Double Interlock Preaction Trim with Electric/Electric Release (Black)	52-478-1-128	\$3,964.00
1 1/2" and 2" Double Interlock Preaction Trim with Electric/Electric Release (Brass)	–	POA
Trim Kits for Model DV-5 Deluge Valves - 3"		
3" Supervised Single Interlock Preaction Trim with Wet Pilot Actuation (Galvanized) (Standard Order)	52-478-2-114	\$4,264.00
3" Supervised Single Interlock Preaction Trim with Wet Pilot Actuation (Black)	52-478-1-114	\$4,264.00
3" Supervised Single Interlock Preaction Trim with Wet Pilot Actuation (Brass)	–	POA
3" Supervised Single Interlock Preaction Trim with Dry Pilot Actuation (Galvanized) (Standard Order)	52-478-2-115	\$5,552.00
3" Supervised Single Interlock Preaction Trim with Dry Pilot Actuation (Black)	52-478-1-115	\$5,552.00
3" Supervised Single Interlock Preaction Trim with Dry Pilot Actuation (Brass)	–	POA
3" Supervised Single Interlock Preaction Trim with Electric Actuation (Galvanized) (Standard Order) (Solenoid Valve Not Included)	52-478-2-116	\$4,362.00
3" Supervised Single Interlock Preaction Trim with Electric Actuation (Black) (Solenoid Valve Not Included)	52-478-1-116	\$4,362.00
3" Supervised Single Interlock Preaction Trim with Electric Actuation (Brass) (Solenoid Valve Not Included)	–	POA
3" Double Interlock Preaction Trim with Electric/Pneumatic Release (Galvanized) (Standard Order)	52-478-2-124	\$5,728.00
3" Double Interlock Preaction Trim with Electric/Pneumatic Release (Black)	52-478-1-124	\$7,138.00
3" Double Interlock Preaction Trim with Electric/Pneumatic Release (Brass)	–	POA
3" Double Interlock Preaction Trim with Electric/Electric Release (Galvanized) (Standard Order)	52-478-2-125	\$4,063.00
3" Double Interlock Preaction Trim with Electric/Electric Release (Black)	52-478-1-125	\$4,063.00
3" Double Interlock Preaction Trim with Electric/Electric Release (Brass)	–	POA

Section 8
Wet System Valves

Section 9
Water Motor Alarms

Section 10
Dry Pipe Valves

Section 11
Quick Opening Devices

Section 12
Air Maintenance Devices

Section 13
Deluge Valves & Accessories

Section 14
Preaction Systems

Section 15
General Purpose Valves

Refer to the latest technical data sheets for specific approvals, listings, design parameters, and available options on www.tyco-fire.com.

Section 8
Wet System Valves

Section 9
Water Motor Alarms

Section 10
Dry Pipe Valves

Section 11
Quick Opening Devices

Section 12
Air Maintenance Devices

Section 13
Deluge Valves & Accessories

Section 14
Praction Systems

Section 15
General Purpose Valves

Praction Trim for Model DV-5		
Trim Kits for Model DV-5 Deluge Valves - 4", 6" and 8"		
<i>Description</i>	<i>Part No.</i>	<i>List Price</i>
4", 6" and 8" Supervised Single Interlock Praction Trim with Wet Pilot Actuation (Galvanized) (Standard Order)	52-478-2-111	\$4,560.00
4", 6" and 8" Supervised Single Interlock Praction Trim with Wet Pilot Actuation (Black)	52-478-1-111	\$4,560.00
4" and 6" Supervised Single Interlock Praction Trim with Wet Pilot Actuation (Brass)	–	POA
4", 6" and 8" Supervised Single Interlock Praction Trim with Dry Pilot Actuation (Galvanized) (Standard Order)	52-478-2-112	\$5,849.00
4", 6" and 8" Supervised Single Interlock Praction Trim with Dry Pilot Actuation (Black)	52-478-1-112	\$5,849.00
4", 6" and 8" Supervised Single Interlock Praction Trim with Dry Pilot Actuation (Brass)	–	POA
4", 6" and 8" Supervised Single Interlock Praction Trim with Electric Actuation (Galvanized) (Standard Order) (Solenoid Valve Not Included)	52-478-2-113	\$4,660.00
4", 6" and 8" Supervised Single Interlock Praction Trim with Electric Actuation (Black) (Solenoid Valve Not Included)	52-478-1-113	\$4,660.00
4", 6" and 8" Supervised Single Interlock Praction Trim with Electric Actuation (Brass) (Solenoid Valve Not Included)	–	POA
4", 6" and 8" Double Interlock Praction Trim with Electric/Pneumatic Release (Galvanized) (Standard Order)	52-478-2-121	\$5,984.00
4", 6" and 8" Double Interlock Praction Trim with Electric/Pneumatic Release (Black)	52-478-1-121	\$7,436.00
4", 6" and 8" Double Interlock Praction Trim with Electric/Pneumatic Release (Brass)	–	POA
4", 6" and 8" Double Interlock Praction Trim with Electric/Electric Release (Galvanized) (Standard Order)	52-478-2-122	\$4,362.00
4", 6" and 8" Double Interlock Praction Trim with Electric/Electric Release (Black)	52-478-1-122	\$4,362.00
4", 6" and 8" Double Interlock Praction Trim with Electric/Electric Release (Brass)	–	POA
Technical Data Sheets: Single Interlock: Wet Pilot - TFP1410, Dry Pilot - TFP1415, Electric Actuation - TFP1420 Double Interlock: Electric/Pneumatic - TFP1460, Electric/Electric - TFP1465		

Refer to the latest technical data sheets for specific approvals, listings, design parameters, and available options on www.tyco-fire.com.

CV-1F Grooved Check Valve

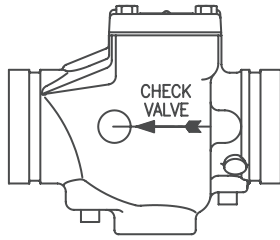

<i>Part Numbers</i> CV-1F	<i>Description</i>	<i>Price</i>
59-590-0-020	2" Grooved Check Valve	Refer to Section 18 for Valve pricing.
59-590-0-025	2½" Grooved Check Valve	
59-590-0-030	3" Grooved Check Valve	
59-590-0-040	4" Grooved Check Valve	
59-590-0-050	5" Grooved Check Valve	
59-590-0-060	6" Grooved Check Valve	
59-590-0-080	8" Grooved Check Valve	
59-590-0-100	10" Grooved Check Valve	
Replacement Parts for Model CV-1F Check Valve, 2½" Grooved End		
59-592-1-025	Maintenance Kit Includes: Cap, Gasket, Bolts, Warning Label and "Out of Service" Tag	\$794.50
59025EPDME	Clapper Gasket	\$139.00
Replacement Parts for Model CV-1F Check Valve, 3" Grooved End		
59-592-1-030	Maintenance Kit Includes: Cap, Gasket, Bolts, Warning Label and "Out of Service" Tag	\$794.50
59030EPDME	Clapper Gasket	\$139.00
Replacement Parts for Model CV-1F Check Valve, 4" Grooved End		
59-592-1-040	Maintenance Kit Includes: Cap, Gasket, Bolts, Warning Label and "Out of Service" Tag	\$794.50
59040EPDME	Clapper Gasket	\$139.00
Replacement Parts for Model CV-1F Check Valve, 5" Grooved End		
59-592-1-050	Maintenance Kit Includes: Cap, Gasket, Bolts, Warning Label and "Out of Service" Tag	\$794.50
59050EPDME	Clapper Gasket	\$139.00
Replacement Parts for Model CV-1F Check Valve, 6" Grooved End		
59-592-1-060	Maintenance Kit Includes: Cap, Gasket, Bolts, Warning Label and "Out of Service" Tag	\$794.50
59060EPDME	Clapper Gasket	\$139.00
Replacement Parts for Model CV-1F Check Valve, 8" Grooved End		
59-592-1-080	Maintenance Kit Includes: Cap, Gasket, Bolts, Warning Label and "Out of Service" Tag	\$794.50
59080EPDME	Clapper Gasket	\$139.00
Replacement Parts for Model CV-1F Check Valve, 10" Grooved End		
59-592-1-100	Maintenance Kit Includes: Cap, Gasket, Bolts, Warning Label and "Out of Service" Tag	\$794.50
59100EPDME	Clapper Gasket	\$139.00
Technical Data Sheet: Check Valve TFP1550 and Maintenance Kit TFP1555		

Section 8 Wet System Valves
 Section 9 Water Motor Alarms
 Section 10 Dry Pipe Valves
 Section 11 Quick Opening Devices
 Section 12 Air Maintenance Devices
 Section 13 Deluge Valves & Accessories
 Section 14 Preaction Systems
 Section 15 General Purpose Valves

Refer to the latest technical data sheets for specific approvals, listings, design parameters, and available options on www.tyco-fire.com.

Section 8
Wet System Valves

Section 9
Water Motor Alarms

Section 10
Dry Pipe Valves

Section 11
Quick Opening Devices

Section 12
Air Maintenance Devices

Section 13
Deluge Valves & Accessories

Section 14
Preaction Systems

Section 15
General Purpose Valves

**Model BFV-N Butterfly Valves - Wafer Style w/ Supervisory Switches - 250 psi
UL and C-UL Listed and FM Approved**

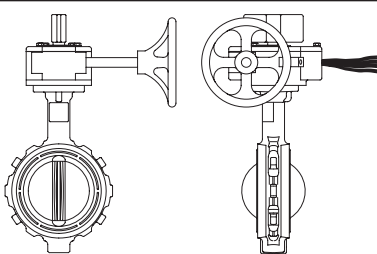
	<i>Nom. Size</i>	<i>Part Numbers</i>	<i>List Price</i>
	2" Model BFV-N Butterfly Valve - Wafer Style	59-801-1-020N	\$804.50
	2½" Model BFV-N Butterfly Valve - Wafer Style	59-801-1-025N	\$848.00
	3" Model BFV-N Butterfly Valve - Wafer Style	59-801-1-030N	\$950.00
	4" Model BFV-N Butterfly Valve - Wafer Style	59-801-1-040N	\$982.50
	5" Model BFV-N Butterfly Valve - Wafer Style	59-801-1-050N	\$1,272.00
	6" Model BFV-N Butterfly Valve - Wafer Style	59-801-1-060N	\$1,272.00
	8" Model BFV-N Butterfly Valve - Wafer Style	59-801-1-080N	\$1,884.00
	10" Model BFV-N Butterfly Valve - Wafer Style	59-801-1-100N	\$2,574.00
	12" Model BFV-N Butterfly Valve - Wafer Style	59-801-1-120N	\$3,127.00
Technical Data Sheet - TFP1515			

**Model BFV-N Butterfly Valves - Lug Style w/ Supervisory Switches - 250 psi
UL and C-UL Listed and FM Approved**

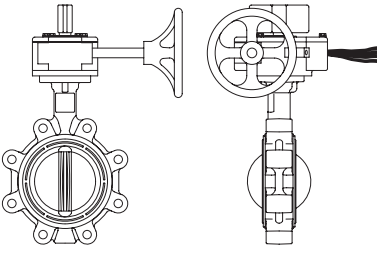
	<i>Nom. Size</i>	<i>Part Numbers</i>	<i>List Price</i>
	2" Model BFV-N Butterfly Valve - Lug Style	59-802-1-020N	\$925.50
	2½" Model BFV-N Butterfly Valve - Lug Style	59-802-1-025N	\$976.50
	3" Model BFV-N Butterfly Valve - Lug Style	59-802-1-030N	\$1,003.00
	4" Model BFV-N Butterfly Valve - Lug Style	59-802-1-040N	\$1,076.00
	5" Model BFV-N Butterfly Valve - Lug Style	59-802-1-050N	\$1,406.00
	6" Model BFV-N Butterfly Valve - Lug Style	59-802-1-060N	\$1,406.00
	8" Model BFV-N Butterfly Valve - Lug Style	59-802-1-080N	\$2,032.00
	10" Model BFV-N Butterfly Valve - Lug Style	59-802-1-100N	\$2,625.00
	12" Model BFV-N Butterfly Valve - Lug Style	59-802-1-120N	\$4,192.00
Technical Data Sheet - TFP1520			

Additional Wafer and Lug Lengths, w/PIVA

Wafer 12" thru 36" Length, w/PIVA		Lug 12" thru 36" Length, w/PIVA	
<i>Nom. Size</i>	<i>List Price</i>	<i>Nom. Size</i>	<i>List Price</i>
2"	\$2,615.00	2"	\$2,718.00
2½"	\$2,651.00	2½"	\$2,763.00
3"	\$2,754.00	3"	\$2,810.00
4"	\$2,788.00	4"	\$2,979.00
5"	\$3,071.00	5"	\$3,296.00
6"	\$3,071.00	6"	\$3,296.00
8"	\$3,907.00	8"	\$4,165.00
10"	\$4,525.00	10"	\$4,831.00
12"	\$5,400.00	12"	\$5,919.00

Notes

Wafer and Lug Lengths add . per foot increase in length after 36"

Refer to the latest technical data sheets for specific approvals, listings, design parameters, and available options on www.tyco-fire.com.

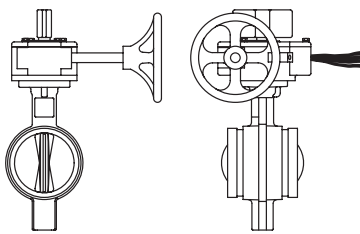
Model BFV-N Butterfly Valves - G x G, Gear Operated w/ Tamper Switches-300psi UL and C-UL Listed and FM Approved			
	<i>Nom. Size</i>	<i>Part Numbers</i>	<i>List Price</i>
	2" Butterfly Valve	Refer to page C-2 for 2" Valve Part Number and Pricing Information	
	2 1/2" Model BFV-N Butterfly Valve	59-300-F-025N	Refer to Section 18 for Valve pricing.
	3" Model BFV-N Butterfly Valve	59-300-F-030N	
	4" Model BFV-N Butterfly Valve	59-300-F-040N	
	5" Model BFV-N Butterfly Valve	59-300-F-050N	
	6" Model BFV-N Butterfly Valve	59-300-F-060N	
	8" Model BFV-N Butterfly Valve	59-300-F-080N	
	10" Model BFV-N Butterfly Valve	59-300-F-100N	
Technical Data Sheet - TFP1510			

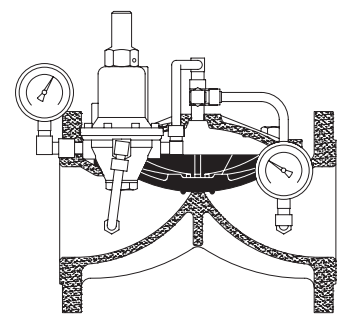
Model PRV-1 Pressure Regulating Valve 2" thru 8", 250 psi, Pilot Operated			
	<i>Nom. Size</i>	<i>UL & FM Part Numbers</i>	<i>List Price</i>
	2" Model PRV-1 Pressure Regulating Valve, Groove x Groove	52-570-8-920	\$1,816.00
	2" Model PRV-1 Pressure Regulating Valve, Thread x Thread	52-570-8-060	\$1,816.00
	3" Model PRV-1 Pressure Regulating Valve, Groove x Groove	52-570-8-922	\$2,808.00
	4" Model PRV-1 Pressure Regulating Valve, Groove x Groove	52-570-8-923	\$3,380.00
	4" Model PRV-1 Pressure Regulating Valve, Flange x Flange	52-570-8-023	\$3,380.00
	6" Model PRV-1 Pressure Regulating Valve, Groove x Groove	52-570-8-925	\$6,165.00
	6" Model PRV-1 Pressure Regulating Valve, Flange x Flange	52-570-8-025	\$6,165.00
	8" Model PRV-1 Pressure Regulating Valve, Flange x Flange	52-570-8-026	\$9,416.00
Technical Data Sheet - TFP1580			

Refer to the latest technical data sheets for specific approvals, listings, design parameters, and available options on www.tyco-fire.com.

Section 8
Wet System Valves

Section 9
Water Motor Alarms

Section 10
Dry Pipe Valves

Section 11
Quick Opening Devices

Section 12
Air Maintenance Devices

Section 13
Deluge Valves & Accessories

Section 14
Preaction Systems

Section 15
General Purpose Valves

**Model RV-1 Pressure Relief Valves
2" thru 8", 250 psi, Pilot Operated, Globe and Angle Body Styles**

Model RV-1 Pressure Relief Valve - Globe Body Style

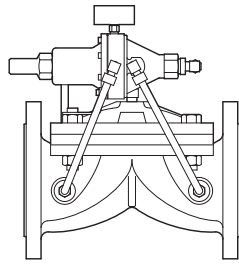

<i>Description</i>	<i>UL / FM Part Numbers</i>	<i>List Price</i>
2" Flange x Flange, ANSI	52-572-8-010	\$2,894.00
3" Flange x Flange, ANSI	52-572-8-022	\$3,144.00
4" Flange x Flange, ANSI	52-572-8-023	\$4,063.00
6" Flange x Flange, ANSI	52-572-8-025	\$6,957.00
8" Flange x Flange, ANSI	52-572-8-026	\$10,574.00

Model RV-1 Pressure Relief Valve - Angle Body Style

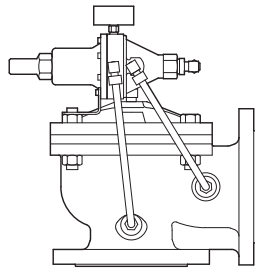

<i>Description</i>	<i>UL / FM Part Numbers</i>	<i>List Price</i>
2" Thread x Thread, NPT	52-573-8-060	\$2,894.00
3" Flange x Flange, ANSI	52-573-8-022	\$3,144.00
4" Flange x Flange, ANSI	52-573-8-023	\$4,063.00
6" Flange x Flange, ANSI	52-573-8-025	\$6,957.00
8" Flange x Flange, ANSI	52-573-8-026	\$10,574.00

Replacement Parts for Model RV-1 Pressure Relief Valves

<i>Description</i>	<i>Part Numbers</i>	<i>List Price</i>
2" Model RV-1 Pressure Relief Valve Replacement Diaphragm (Fits Either Body Style)	92-570-2-011	\$540.00
3" Model RV-1 Pressure Relief Valve Replacement Diaphragm (Fits Either Body Style)	92-570-2-012	\$553.50
4" Model RV-1 Pressure Relief Valve Replacement Diaphragm (Fits Either Body Style)	92-570-2-013	\$1,482.00
6" Model RV-1 Pressure Relief Valve Replacement Diaphragm (Fits Either Body Style)	92-570-2-014	\$2,155.00
8" Model RV-1 Pressure Relief Valve Replacement Diaphragm (Fits Either Body Style)	92-570-2-015	\$4,378.00
Pilot Valve	92-570-3-001	\$1,659.00
Water Pressure Gauge	92-572-2-200	\$134.00
2", 3" and 4" Valve Strainer	92-570-2-202	\$182.00
6" and 8" Valve Strainer	92-570-2-209	\$227.50
2" Tubing and Fitting Kit, Globe Body	92-572-3-001	\$635.00
2" Tubing and Fitting Kit, Angle Body	92-573-3-001	\$635.00
3" Tubing and Fitting Kit, Globe Body	92-572-3-002	\$635.00
3" Tubing and Fitting Kit, Angle Body	92-573-3-002	\$635.00
4" Tubing and Fitting Kit, Globe Body	92-572-3-003	\$635.00
4" Tubing and Fitting Kit, Angle Body	92-573-3-003	\$635.00
6" Tubing and Fitting Kit, Globe Body	92-572-3-004	\$746.00
6" Tubing and Fitting Kit, Angle Body	92-573-3-004	\$746.00
8" Tubing and Fitting Kit, Globe Body	92-572-3-005	\$746.00
8" Tubing and Fitting Kit, Angle Body	92-573-3-005	\$746.00

Technical Data Sheet - TFP1585

Refer to the latest technical data sheets for specific approvals, listings, design parameters, and available options on www.tyco-fire.com.

Valve System Accessories

Description	Part No.	List Price
1/2" Pressure Relief Valve	2283	\$206.00
1/4" Pressure Relief Valve	92-343-1-125	\$151.50
1/4" Air Pressure Regulator (Norgen)	12525000	\$280.00
1/4" Air Restrictor	2370	\$28.50
3/8" Furnas Pressure Switch	2433	\$483.00

F350 Sectional Control Accessories

Description	Part No.	List Price
1 1/4" Drain x 1/2" Test Orifice	54-350-1-001	\$687.00

Technical Data Sheet - TFP1650

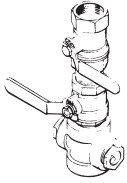

F1321 Sight Flow Connection

Description	Part No.	List Price
1" F1321 Sight Flow Connection	52-069-1-006	\$134.00
2" F1321 Sight Flow Connection	52-069-1-009	\$353.00

Technical Data Sheet - TFP1635

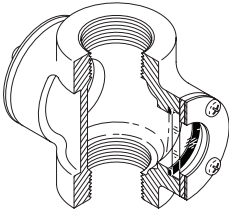

Ball Drip Valves

Description	Part Number	List Price
1/2" Ball Drip w/street ell	2282	\$53.00
1/2" AD-2 Automatic Drain Ball Drip (for FDC & Low Point Drains)	52-789-1-004	\$80.75
1/2" AD-1 Plunger Type, Automatic Drain Ball Drip	52-793-2-004	\$164.50

Technical Data Sheet - AD-1 TFP1630 & AD-2 TFP1632

Fill or Drip Cups

Description	Part No.	List Price
1/2" N.P.T.	1295	\$83.75
3/4" N.P.T.	129501	\$83.75

DD-1 (Drum Drip) Wiliag Drain

Description	Part No.	List Price
DD-1 (Drum Drip) Wiliag Drain Includes: Condensation Barrel, 2- 1" Shutoff Valves & 1-1" Plug	52-380-1-001	\$192.50

Refer to the latest technical data sheets for specific approvals, listings, design parameters, and available options on www.tyco-fire.com.

Section 16
Specialty Items

Section 18
Grooved Product

Section 19
CPVC Pipe & Fittings

Section 20
Miscellaneous

Section 21
Electrical

Section C
Valves & Hose Equipment

Section D
Backflow

Section F
Pipe & Accessories

Section H
Hangers

Section J
Lubricants

Section K
Misc.

Section 16
Specialty Items

Section 18
Grooved Product

Section 19
CPVC Pipe & Fittings

Section 20
Miscellaneous

Section 21
Electrical

Section C
Valves & Hose Equipment

Section D
Backflow

Section F
Pipe & Accessories

Section H
Hangers

Section J
Lubricants

Section K
Misc.

Manual Control Stations

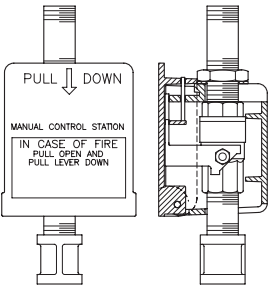
		<i>Description</i>	<i>Part No.</i>	<i>List Price</i>
		Hydraulic Break-Rod Station, Model MC-1	52-289-1-001	\$498.50
		Replacement Rod 1/8" x 1-3/16" Polystyrene	92-289-1-008	\$16.00
Technical Data Sheet - TFP1382				

Model G16AC812 Automatic Supervisory Air Supply

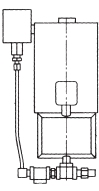
		<i>Description</i>	<i>Part No.</i>	<i>List Price</i>
		Automatic Air Supply Model G16AC812	52-150-1-001	\$2,774.00
		Universal Bracket Riser Mount	52-150-1-000	\$337.50
Technical Data Sheet - TFP1620				

Water and Air Gauges

<i>Description</i>	<i>Part No.</i>	<i>List Price</i>
Water Pressure Gauge.	92-343-1-005	\$88.75
Air Pressure Gauge. 250 psi	92-343-1-012	\$88.75
Air/Water Pressure Gauge. 0 - 300 psi, 1/4" NPT	92-343-1-013	\$88.75

Fusible Links/Fire Door Links, Type C

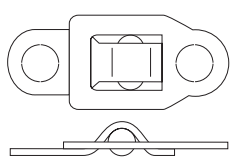
		<i>Description</i>	<i>Part Number</i>	<i>List Price</i>
		Fusible Link, Figure 1247B 135°F (57°C), Type C	56-125-9-135	\$20.75
		Fusible Link, Figure 1247B 165°F (74°C), Type C	56-125-9-165	\$20.75
		Fusible Link, Figure 1247B 212°F (100°C), Type C	56-125-9-212	\$20.75
		Fusible Link, Figure 1247B 286°F (141°C), Type C	56-125-9-286	\$20.75
		Fusible Link, Figure 1247B 360°F (182°C), Type C	56-125-9-360	\$22.50
		Fusible Link, Figure 1247B 500°F (260°C), Type C	56-125-9-500	\$28.75
Technical Data Sheet - TFP1610				

Refer to the latest technical data sheets for specific approvals, listings, design parameters, and available options on www.tyco-fire.com.

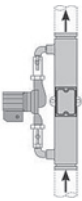
Zonecheck - Flow Switch Tester			
	<i>Description</i>	<i>Part Number</i>	<i>List Price</i>
 <p>Note: For Left Hand Option, Please add a "-L" to the part number and add \$175 to the price. (example 4320-L)</p>	2" Zonecheck Flow Tester	4320	\$4,618.00
	2½" Zonecheck Flow Tester	4325	\$4,623.00
	3" Zonecheck Flow Tester	4330	\$4,628.00
	4" Zonecheck Flow Tester	4340	\$4,636.00
	6" Zonecheck Flow Tester	4360	\$4,742.00
	8" Zonecheck Flow Tester	4380	\$4,988.00
	Retrofit Zonecheck Assembly	43RT	\$3,680.00
	Zonecheck Keyswitch	43100 ZCK-1	\$250.00

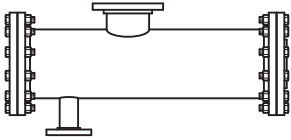
Model "A" Strainers and SS Baskets			
	<i>Description</i>	<i>Part No.</i>	<i>List Price</i>
	3" Model "A" Strainer, Fig. 1260, Galvanized Finish and SS Baskets	52-270-1-011	\$10,195.00
	4" Model "A" Strainer, Fig. 1260, Galvanized Finish and SS Baskets	52-270-1-013	\$12,380.00
	6" Model "A" Strainer, Fig. 1260, Galvanized Finish and SS Baskets	52-270-1-015	\$20,427.00
	8" Model "A" Strainer, Fig. 1260, Galvanized Finish and SS Baskets	52-270-1-016	\$26,760.00
	10" Model "A" Strainer, Fig. 1260, Galvanized Finish and SS Baskets	52-270-1-017	\$41,417.00
Replacement Parts for Model "A" Strainers			
	8" End Flange 19" Model A, Strainer	92-270-1-024	\$5,400.00
	End Flange 10" Model A, Strainer	92-270-1-046	\$6,126.00
	Stainless Steel Basket 4"	92-270-1-213	\$6,830.00
	Stainless Steel Basket 6"	92-270-1-215	\$7,772.00
	Stainless Steel Basket 8"	92-270-1-216	\$13,588.00
	Stainless Steel Basket 10"	92-270-1-217	\$15,588.00
Notes			
All Model "A" Strainers are special order and require 10 weeks for delivery.			
Technical Data Sheet - TFP1640			

Section 16
Specialty Items

Section 18
Grooved Product

Section 19
CPVC Pipe & Fittings

Section 20
Miscellaneous

Section 21
Electrical

Section C
Valves & Hose Equipment

Section D
Backflow

Section F
Pipe & Accessories

Section H
Hangers

Section J
Lubricants

Section K
Misc.

Refer to the latest technical data sheets for specific approvals, listings, design parameters, and available options on www.tyco-fire.com.

Section 16
Specialty Items

Section 18
Grooved Product

Section 19
CPVC Pipe & Fittings

Section 20
Miscellaneous

Section 21
Electrical

Section C
Valves & Hose Equipment

Section D
Backflow

Section F
Pipe & Accessories

Section H
Hangers

Section J
Lubricants

Section K
Misc.

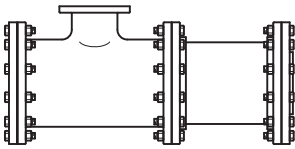
Model "B-1" Strainer, Painted Finish and SS Baskets			
	<i>Description</i>	<i>Part No.</i>	<i>List Price</i>
	3" No. 1	52-370-1-010	\$9,135.00
	3" No. 2*, No. 3	52-370-1-011	POA
	3" Galvanized Finish and SS Baskets	-	POA
	4" No. 6*	52-370-1-013	\$12,873.00
	4" Galvanized Finish and SS Baskets	-	POA
	6" No. 9*	52-370-1-015	\$19,592.00
	6" Galvanized Finish and SS Baskets	-	POA
	8" No. 14, No. 15, No. 19*, No. 20	52-370-1-016	\$34,774.00
	8" No. 16	52-370-1-017	POA
	8" Galvanized Finish and SS Baskets	-	POA
Replacement Parts for Model B-1, Strainer			
	3" Basket Assembly	92-370-1-102	\$2,142.00
	4" Basket Assembly	92-370-1-104	\$2,254.00
	6" Basket Assembly	92-370-1-106	\$2,421.00
	8" Basket Assembly	92-370-1-108	\$3,567.00
	8" End Flange Plain	92-370-1-007	POA
	8" End Flange Galvanized	92-370-2-007	POA
	6" End Flange Plain	92-370-1-005	POA
	6" End Flange Galvanized	92-370-2-005	POA
	3" Ring Gasket	92-370-1-015	POA
	4" Ring Gasket	92-370-1-016	POA
	6" & 8" Ring Gasket	92-370-1-018	POA
Notes			
* These Model "B1" Strainers are available from stock. All other "B1" Strainers require 5 weeks for delivery.			
1 – Model "B1" Galvanized Strainers are special order and required 10 weeks for delivery.			
2 – All extra heavy strainers both Model "A" and "B" are discontinued.			
3 – All strainers with monel or bronze baskets are special order and require 8 weeks for delivery P.O.A.			
Technical Data Sheet - TFP1642			

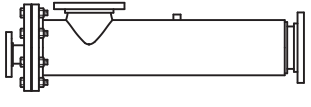
Model "C" Strainer, Heavy Duty, Welded Body			
	<i>Description</i>	<i>Part No.</i>	<i>List Price</i>
	6 x 6" Model "C" Strainer, Galvanized Finish and Stainless Steel Baskets	52-390-1-013	\$21,119.00
	8" x 8" Model "C" Strainer, Galvanized Finish and Stainless Steel Baskets	52-390-1-016	\$27,614.00
	8" with two 6" Outlets, Model "C" Strainer, Galvanized Finish and Stainless Steel Baskets	52-390-1-017	\$33,110.00
	10" with two 8" Outlets, Model "C" Strainer, Galvanized Finish and Stainless Steel Baskets	52-390-1-019	\$42,757.00
Technical Data Sheet - TFP1644			

Refer to the latest technical data sheets for specific approvals, listings, design parameters, and available options on www.tyco-fire.com.

Sprinkler Identification Signs			
	<i>Description</i>	<i>Part No.</i>	<i>List Price</i>
	Sign A - General Purpose, 9" x 7"	2300A	\$14.50
	Sign B "Alarm Test", 6" x 2"	2304A	\$7.40
	Sign B "Auxiliary Drain", 6" x 2"	2307	\$7.40
	Sign B "Control Valve", 6" x 2"	2310	\$7.40
	Sign B "Inspectors Test", 6" x 2"	2313	\$7.40
	Sign B "Main Control", 6" x 2"	2319	\$7.40
	Sign B "Main Drain", 6" x 2"	2320	\$7.40
	Sign B "Air Control", 6" x 2"	2328	\$7.40
	Sign B "Air Line", 6" x 2"	2302	\$7.40
	Sign B "Anti-Freeze System", 6" x 2"	2306	\$7.40
	Sign B "Drain", 6" x 2"	2311	\$7.40
	Sign B "Drain Valve", 6" x 2"	2327	\$7.40
	Sign D "When Bell Rings", 9" x 7"	2329	\$16.50
	Sign E - Hydraulic Calculations, 5" x 7"	2317	\$14.50
Technical Data Sheet - TFP1615			

Restriction Unions		
<i>Description</i>	<i>Part No.</i>	<i>List Price</i>
1/2" Brass Union 1/8" Orifice.	52-363-1-001	\$107.00
1/2" Brass Union 3/32" Orifice.	52-363-1-002	\$107.00
3/4" Brass Union K=5.6.	52-363-1-005	\$137.50
1" Brass Union K=5.6.	52-363-1-006	\$152.00
1" M.I. Union K=5.6.	52-363-1-106	\$87.50
1" Brass Union K=8.0.	52-363-1-256	\$152.00

Refer to the latest technical data sheets for specific approvals, listings, design parameters, and available options on www.tyco-fire.com.

Section 16
Specialty Items

Section 18
Grooved Product

Section 19
CPVC Pipe & Fittings

Section 20
Miscellaneous

Section 21
Electrical

Section C
Valves & Hose Equipment

Section D
Backflow

Section F
Pipe & Accessories

Section H
Hangers

Section J
Lubricants

Section K
Misc.

Section 16 Specialty Items
Section 18 Grooved Product
Section 19 CPVC Pipe & Fittings
Section 20 Miscellaneous
Section 21 Electrical
Section C Valves & Hose Equipment
Section D Backflow
Section F Pipe & Accessories
Section H Hangers
Section J Lubricants
Section K Misc.

Refer to the latest technical data sheets for specific approvals, listings, design parameters, and available options on www.tyco-fire.com.

**G-FIRE #577 Global and Domestic – Rigid Coupling
with Grade “A” EPDM Fire Protection Pre-Lubricated Gasket**

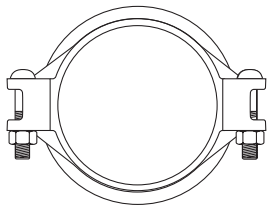
	Nom. Size	Painted			Galvanized		
		Global Part Number	Domestic Part Number	List Price	Global Part Number	Domestic Part Number	List Price
		1"	–	57701ASC	\$58.00	–	57701AGSC
1 1/4"	57713ACP	57713ASC	\$42.50	57713AGCP	57713AGSC	\$51.00	
1 1/2"	57715ACP	57715ASC	\$43.50	57715AGCP	57715AGSC	\$52.00	
2"	57720ACP	57720ASC	\$49.00	57720AGCP	57720AGSC	\$57.50	
2 1/2"	57725ACP	57725ASC	\$56.50	57725AGCP	57725AGSC	\$68.00	
3"	57730ACP	57730ASC	\$64.00	57730AGCP	57730AGSC	\$79.50	
4"	57740ACP	57740ASC	\$90.50	57740AGCP	57740AGSC	\$108.50	
5"	57750ACP	57750ASC	\$120.00	57750AGCP	57750AGSC	\$151.00	
6"	57760ACP	57760ASC	\$143.50	57760AGCP	57760AGSC	\$174.50	
8"	57780ACP	57780ASC	\$240.50	57780AGCP	57780AGSC	\$292.00	
10"	57710ACP	57710ASC	\$528.50	57710AGCP	57710AGSC	\$705.50	
12"	57712ACP	57712ASC	\$590.50	57712AGCP	57712AGSC	\$791.00	

Technical Data Sheet: TFP1854

**G-FIRE #577 Global – Rigid Tri-Seal Coupling
with Grade “E” EPDM Tri-Seal Gasket Recommended for
Dry Pipe Systems and Freezer Applications – Use Silicone Lubricant**

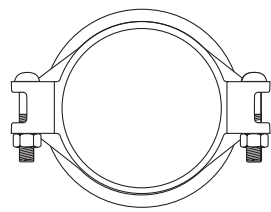
	Nom. Size	Painted		Galvanized	
		Global Part Number	List Price	Global Part Number	List Price
		1"	57701E3S	\$82.50	57701E3GS
1 1/4"	57713E3S	\$42.50	57713E3GS	\$51.00	
1 1/2"	57715E3S	\$43.50	57715E3GS	\$52.00	
2"	57720E3S	\$49.00	57720E3GS	\$57.50	
2 1/2"	57725E3S	\$56.50	57725E3GS	\$68.00	
3"	57730E3S	\$64.00	57730E3GS	\$79.50	
4"	57740E3S	\$90.50	57740E3GS	\$108.50	
5"	57750E3S	\$206.50	57750E3GS	\$237.50	
6"	57760E3S	\$227.50	57760E3GS	\$266.00	
8"	57780E3S	\$368.50	57780E3GS	\$427.00	
10"	57710E3S	\$635.50	57710E3GS	\$807.50	
12"	57712E3S	\$723.00	57712E3GS	\$929.50	

Technical Data Sheet: TFP1854

Section 16
Specialty Items

Section 18
Grooved Products

Section 19
CPVC Pipe & Fittings

Section 20
Miscellaneous

Section 21
Electrical

Section C
Valves & Hose Equipment

Section D
Backflow

Section F
Pipe & Accessories

Section H
Hangers

Section J
Lubricants

Section K
Misc.

**#705 Global and Domestic – Flexible Coupling
with Grade “A” EPDM Fire Protection Pre-Lubricated Gasket**

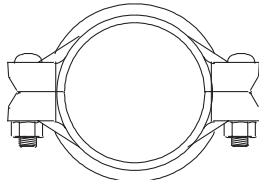

Nom. Size	Painted			Galvanized		
	Global Part Number	Domestic Part Number	List Price	Global Part Number	Domestic Part Number	List Price
1 1/4"	70513ACP	70513ASC	\$43.00	70513AGCP	70513AGSC	\$55.50
1 1/2"	70515ACP	70515ASC	\$52.50	70515AGCP	70515AGSC	\$65.00
2"	70520ACP	70520ASC	\$63.50	70520AGCP	70520AGSC	\$84.00
2 1/2"	70525ACP	70525ASC	\$74.00	70525AGCP	70525AGSC	\$103.50
3"	70530ACP	70530ASC	\$82.50	70530AGCP	70530AGSC	\$114.00
4"	70540ACP	70540ASC	\$118.50	70540AGCP	70540AGSC	\$167.50
5"	–	70550ESC	\$179.50	–	70550EGSC	\$258.00
6"	70560ACP	70560ASC	\$212.50	70560AGCP	70560AGSC	\$304.50
8"	70580ACP	70580ASC	\$345.00	70580AGCP	70580AGSC	\$513.00
10"	–	70510ESC	\$562.00	–	70510EGSC	\$805.50
12"	–	70512ESC	\$639.00	–	70512EGSC	\$915.00

Orders for items in shaded areas **cannot** be cancelled or returned.

Technical Data Sheet: TFP1820

**#705 Domestic – Flexible Tri-Seal Coupling
with Grade “E” EPDM Tri-Seal Gasket Recommended for
Dry Pipe Systems and Freezer Applications – Use Silicone Lubricant**

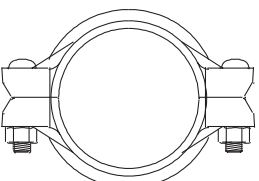

Nom. Size	Painted		Galvanized	
	Domestic Part Number	List Price	Domestic Part Number	List Price
1 1/4"	70513E3S	\$70.00	70513E3GS	\$83.50
1 1/2"	70515E3S	\$76.50	70515E3GS	\$91.50
2"	70520E3S	\$78.50	70520E3GS	\$94.00
2 1/2"	70525E3S	\$94.00	70525E3GS	\$110.50
3"	70530E3S	\$99.50	70530E3GS	\$119.50
4"	70540E3S	\$141.50	70540E3GS	\$173.50
5"	70550E3S	\$241.50	70550E3GS	\$287.50
6"	70560E3S	\$266.50	70560E3GS	\$323.50
8"	70580E3S	\$443.50	70580E3GS	\$531.50
10"	70510E3S	\$667.00	70510E3GS	\$896.50
12"	70512E3S	\$783.00	70512E3GS	\$1,031.00

Orders for items in shaded areas **cannot** be cancelled or returned.

Technical Data Sheet: TFP1820

See latest catalog or technical data sheets for specific approvals, listings, and design parameters.
POA = Price on availability. Prices subject to change without notice.

**#707 Domestic Heavy-Duty Flexible Coupling
with Grade "E" EPDM Gasket**

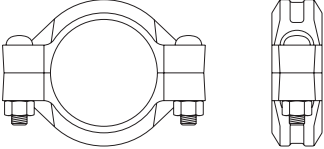
	Nominal Size	Painted		Galvanized	
		Domestic Part Number	List Price	Domestic Part Number	List Price
	1"	70701ES	\$41.50	70701EGS	\$55.50
	1 1/2"	70715ES	\$59.50	70715EGS	\$77.50
	2"	70720ES	\$63.50	70720EGS	\$84.00
	2 1/2"	70725ES	\$74.00	70725EGS	\$103.50
	3"	70730ES	\$82.50	70730EGS	\$114.00
	4"	70740ES	\$118.50	70740EGS	\$167.50
	5"	70750ES	\$179.50	70750EGS	\$258.00
	6"	70760ES	\$212.50	70760EGS	\$304.50
	8"	70780ES	\$345.00	70780EGS	\$513.00
	10"	70710ES	\$562.00	70710EGS	\$805.50
	12"	70712ES	\$639.00	70712EGS	\$915.00

Technical Data Sheet: TFP1840

**#707 Domestic Heavy-Duty Flexible Coupling
with Grade "E" EPDM Tri-Seal Gasket Recommended for
Dry Pipe Systems and Freezer Applications – Use Silicone Lubricant**

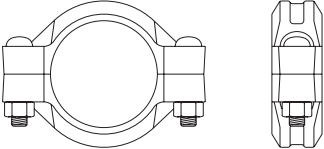
	Nominal Size	Painted		Galvanized	
		Domestic Part Number	List Price	Domestic Part Number	List Price
	1"	70701E3S	\$65.00	70701E3GS	\$80.00
	1 1/2"	70715E3S	\$83.50	70715E3GS	\$103.50
	2"	70720E3S	\$87.50	70720E3GS	\$109.50
	2 1/2"	70725E3S	\$106.50	70725E3GS	\$135.50
	3"	70730E3S	\$110.00	70730E3GS	\$142.50
	4"	70740E3S	\$159.00	70740E3GS	\$208.00
	5"	70750E3S	\$277.50	70750E3GS	\$360.50
	6"	70760E3S	\$308.00	70760E3GS	\$404.00
	8"	70780E3S	\$415.50	70780E3GS	\$569.50
	10"	70710E3S	\$667.00	70710E3GS	\$896.50
	12"	70712E3S	\$783.00	70712E3GS	\$1,031.00

Orders for items in shaded areas **cannot** be cancelled or returned.

Technical Data Sheet: TFP1840

Section 16
Specialty Items

Section 18
Grooved Product

Section 19
CPVC Pipe & Fittings

Section 20
Miscellaneous

Section 21
Electrical

Section C
Valves & Hose Equipment

Section D
Backflow

Section F
Pipe & Accessories

Section H
Hangers

Section J
Lubricants

Section K
Misc.

**#716 Domestic – Reducing Coupling
with Grade “E” EPDM Non-Lubricated Gasket**

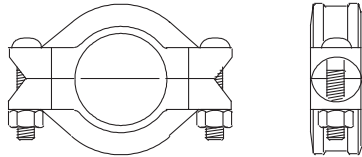

Nom. Size	Painted		Galvanized	
	Domestic Part Number	List Price	Domestic Part Number	List Price
2" x 1 1/2"	7162015ES	\$84.50	7162015EGS	\$102.00
2 1/2" x 2"	7162520ES	\$109.50	7162520EGS	\$137.00
3" x 2"	7163020ES	\$124.50	7163020EGS	\$157.00
3" x 2 1/2"	7163025ES	\$108.00	7163025EGS	\$137.00
4" x 2"	7164020ES	\$196.50	7164020EGS	\$247.50
4" x 2 1/2"	7164025ES	\$176.50	7164025EGS	\$232.00
4" x 3"	7164030ES	\$165.50	7164030EGS	\$213.50
5" x 4"	7165040ES	\$222.00	7165040EGS	\$291.00
6" x 4"	7166040ES	\$334.00	7166040EGS	\$421.00
6" x 5"	7166050ES	\$293.00	7166050EGS	\$379.50
8" x 6"	7168060ES	\$500.00	7168060EGS	\$632.00

Technical Data Sheet: TFP1830

#716 Reducing Coupling Plate

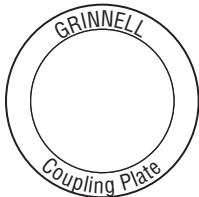

Nom. Size	Plate Part No.	List Price
2" x 1 1/2"	7162015W	POA
2 1/2" x 2"	7162520W	POA
3" x 2"	7163020W	POA
3" x 2 1/2"	7163025W	POA
4" x 2"	7164020W	POA
4" x 2 1/2"	7164025W	POA
4" x 3"	7164030W	POA
5" x 4"	7165040W	POA
6" x 4"	7166040W	POA
6" x 5"	7166050W	POA
8" x 6"	7168060W	POA

Orders for items in shaded areas **cannot** be cancelled or returned.

Replacement Gaskets, Grade “E” EPDM Gasket for #716 Reducing Coupling

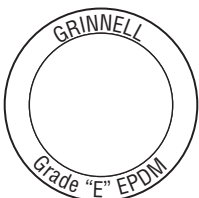

Nom. Size	Plate Part No.	List Price
2" x 1 1/2"	2015EPDME	\$32.00
2 1/2" x 2"	2520EPDME	\$41.50
3" x 2"	3020EPDME	\$47.00
3" x 2 1/2"	3025EPDME	\$47.00
4" x 2"	4020EPDME	\$54.50
4" x 2 1/2"	4025EPDME	\$55.00
4" x 3"	4030EPDME	\$57.00
5" x 4"	5040EPDME	\$66.50
6" x 4"	6040EPDME	\$75.50
6" x 5"	6050EPDME	\$82.50
8" x 6"	8060EPDME	\$91.50

Orders for items in shaded areas **cannot** be cancelled or returned.

See latest catalog or technical data sheets for specific approvals, listings, and design parameters.
POA = Price on availability. Prices subject to change without notice.

**#71 Domestic – Grooved Flange Adapter
with Grade “E” EPDM Non-Lubricated Gasket**

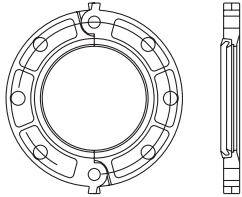
	Nom. Size	Painted		Galvanized	
		Domestic Part Number	List Price	Domestic Part Number	List Price
			2"	7120S	\$186.50
	2½"	7125S	\$217.00	7125GS	\$258.00
	3"	7130S	\$244.50	7130GS	\$293.00
	4"	7140S	\$318.00	7140GS	\$387.50
	5"	7150S	\$381.50	7150GS	\$465.00
	6"	7160S	\$416.00	7160GS	\$506.50
	8"	7180S	\$522.50	7180GS	\$653.50
	10"	7110S	\$1,004.00	7110GS	\$1,276.50
	12"	7112S	\$1,313.50	7112GS	\$1,687.50

Orders for items in shaded areas **cannot** be cancelled or returned.

Technical Data Sheet: TFP1880

#71 Flange Adapter – Metal Washer

	Nom. Size	Washer Part No.	List Price
	2"	7120FWC	\$88.00
	2½"	7125FWC	\$92.50
	3"	7130FWC	\$108.50
	4"	7140FWC	\$125.50
	5"	7150FWC	\$152.50
	6"	7160FWC	\$174.00
	8"	7180FWC	\$219.50
	10"	7110FWC	\$304.00
	12"	7112FWC	\$444.50

Orders for items in shaded areas **cannot** be cancelled or returned.

#71 Flange Adapter – Gaskets or Nut, Bolt, & Gasket Kit

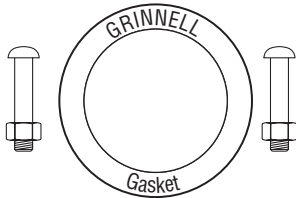
	Nom. Size	Gaskets		Nut, Bolt and Gasket Kit	
		Part Number	List Price	Part Number	List Price
	2"	7120EPDME	\$27.50	50240	POA
	2½"	7125EPDME	\$32.50	50241	POA
	3"	7130EPDME	\$35.00	50242	POA
	4"	7140EPDME	\$45.50	50243	POA
	5"	7150EPDME	\$54.50	50248	POA
	6"	7160EPDME	\$61.50	50244	POA
	8"	7180EPDME	\$82.50	50245	POA
	10"	7110EPDME	\$104.50	50246	POA
	12"	7112EPDME	\$122.00	50247	POA

Orders for items in shaded areas **cannot** be cancelled or returned.

#702 Global – Outlet Coupling Grade “E” Gasket, Female Threaded End, Painted*

Nominal Size	Coupling		Gasket Only	
	Global Part Number	List Price	Part Number	List Price
1½" x ½"	7021505FES	\$111.50	7021505EPDME	\$53.50
1½" x ¾"	7021575FES	\$111.50	7021575EPDME	\$53.50
1½" x 1"	7021501FES	\$111.50	7021501EPDME	\$53.50
2" x ½"	7022005FES	\$114.00	7022005EPDME	\$54.00
2" x ¾"	7022075FES	\$114.00	7022075EPDME	\$54.00
2" x 1"	7022001FES	\$114.00	7022001EPDME	\$54.00
2½" x ½"	7022505FES	\$175.50	7022505EPDME	\$110.50
2½" x ¾"	7022575FES	\$175.50	7022575EPDME	\$110.50
2½" x 1"	7022501FES	\$175.50	7022501EPDME	\$110.50
3" x ¾"	7023075FES	\$169.00	7023075EPDME	\$90.00
3" x 1"	7023001FES	\$223.50	7023001EPDME	\$127.50
4" x ¾"	7024075FES	\$247.50	7024075EPDME	\$127.50
4" x 1"	7024001FES	\$247.50	7024001EPDME	\$127.50
4" x 1½"	7024015FES	\$351.50	7024015EPDME	\$198.50
6" x 1"	7026001FES	\$496.00	7026001EPDME	\$259.00
6" x 1½"	7026015FES	\$496.00	7026015EPDME	\$259.00

Orders for items in shaded areas **cannot** be cancelled or returned.
* Galvanized available upon request.

#702 Global – Outlet Coupling Grade “E” Gasket, Male Threaded End, Painted*

Nominal Size	Coupling		Gasket Only	
	Global Part Number	List Price	Part Number	List Price
2" x 1"	7022001MES	\$114.00	7022001EPDME	\$54.00
2½" x 1¼"	7022513MES	\$197.50	7022513EPDME	\$124.00
2½" x 1½"	7022515MES	\$223.50	7022515EPDME	\$124.00
3" x 1"	7023001MES	\$223.50	7023001EPDME	\$127.50
3" x 1½"	7023015MES	\$256.00	7023015EPDME	\$127.50
4" x 1½"	7024015MES	\$351.50	7024015EPDME	\$198.50
4" x 2"	7024020MES	\$351.50	7024020EPDME	\$198.50
6" x 1½"	7026015MES	\$496.00	7026015EPDME	\$259.00
6" x 2"	7026020MES	\$496.00	7026020EPDME	\$259.00

Orders for items in shaded areas **cannot** be cancelled or returned.
* Galvanized available upon request.

#702 Global – Outlet Coupling Grade “E” Gasket, Grooved End, Painted*

Nominal Size	Coupling		Gasket Only	
	Global Part Number	List Price	Part Number	List Price
2" x 1"	7022001GRVES	\$114.00	7022001EPDME	\$54.00
2½" x 1¼"	7022513GRVES	\$197.50	7022513EPDME	\$124.00
2½" x 1½"	7022515GRVES	\$223.50	7022515EPDME	\$124.00
3" x 1"	7023001GRVES	\$223.50	7023001EPDME	\$127.50
3" x 1½"	7023015GRVES	\$256.00	7023015EPDME	\$127.50
4" x 1½"	7024015GRVES	\$351.50	7024015EPDME	\$198.50
4" x 2"	7024020GRVES	\$351.50	7024020EPDME	\$198.50
6" x 1½"	7026015GRVES	\$496.00	7026015EPDME	\$259.00
6" x 2"	7026020GRVES	\$496.00	7026020EPDME	\$259.00

Orders for items in shaded areas **cannot** be cancelled or returned.
* Galvanized available upon request.

See latest catalog or technical data sheets for specific approvals, listings, and design parameters.
POA = Price on availability. Prices subject to change without notice.

Replacement Gaskets

Nominal Size	Grade "A" Pre-Lube Fire Protection Gasket (for #577, #705,)		Tri-Seal Grade "E" EPDM Gasket (for #577, #705)		Grade "E" EPDM Gasket (for #71)	
1"	01EPDMAC	\$30.50	01EPDME3	\$57.00	—	—
1 1/4"	13EPDMAC	\$40.00	13EPDME3	\$56.00	—	—
1 1/2"	15EPDMAC	\$43.00	15EPDME3	\$61.50	—	—
2"	20EPDMAC	\$46.00	20EPDME3	\$67.00	7120EPDME	\$27.50
2 1/2"	25EPDMAC	\$50.00	25EPDME3	\$69.50	7125EPDME	\$32.50
3"	30EPDMAC	\$57.00	30EPDME3	\$82.50	7130EPDME	\$35.00
4"	40EPDMAC	\$76.00	40EPDME3	\$109.50	7140EPDME	\$45.50
5"	50EPDMAC	\$76.50	50EPDME3	\$153.00	7150EPDME	\$54.50
6"	60EPDMAC	\$84.50	60EPDME3	\$196.00	7160EPDME	\$61.50
8"	80EPDMAC	\$121.00	80EPDME3	\$215.00	7180EPDME	\$82.50
10"	10EPDMAC	\$128.50	10EPDME3	\$246.50	7110EPDME	\$104.50
12"	12EPDMAC	\$149.50	12EPDME3	\$293.50	7112EPDME	\$122.00

Orders for items in shaded areas **cannot** be cancelled or returned.

Technical Data Sheet: TFP1895

Coupling Nut and Bolt Kit

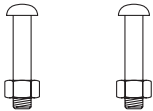
	Nominal Size	Qty/Kit	Part No.	List Price
	3/8" x 2 1/4"	2	NB37225	\$15.50
	1/2" x 3"	2	NB50300	\$16.00
	5/8" x 3 1/4"	2	NB62325	\$19.00
	5/8" x 4 3/4"	2	NB62475	\$32.00
	3/4" x 4 3/4"	2	NB75475	\$30.00
	7/8" x 6 1/2"	2	NB87650	\$49.50
	1" x 5 1/2"	3	NB10550	\$49.50
	1" x 6 1/2"	2	NB10650	\$52.50
	1 1/8" x 5 3/4"	4	NB12575	\$67.00

Orders for items in shaded areas **cannot** be cancelled or returned.

All standard couplings can be provided with stainless steel nuts and bolts upon request.

GRINNELL Gasket Lubricant

Size	Part Number	List Price
1 Quart	32005	\$36.00
GRINNELL Silicone Gasket Lubricant		
Recommended for use with Tri-Seal Gaskets. Dow Corning #DC No. 7. *		
Size	Part Number	List Price
5.30 oz. Tube	32037	\$118.25
8 lb. Can	32038	\$2,148.00

Orders for items in shaded areas **cannot** be cancelled or returned.

Silicone gasket lubricant is for use with Dry Pipe & Freezing Applications.

Pipe Tape Chrome Plated with GRINNELL Logo

Size	Part Number	List Price
1 Roll	PT1000	\$62.00

* Dow Corning is a trademark of Dow Corning Corporation.

See latest catalog or technical data sheets for specific approvals, listings, and design parameters.
POA = Price on availability. Prices subject to change without notice.

G-FIRE #510S Global and Domestic – Fire Protection Short Pattern Grooved 90° Elbow

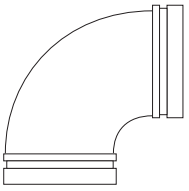
	Nom. Size	Painted			Galvanized		
		Global Part Number	Domestic Part Number	List Price	Global Part Number	Domestic Part Number	List Price
		2"	510S20P	510S20S	\$37.50	510S20GP	510S20GS
2 1/2"	510S25P	510S25S	\$50.00	510S25GP	510S25GS	\$68.00	
3"	510S30P	510S30S	\$65.50	510S30GP	510S30GS	\$87.50	
4"	510S40P	510S40S	\$94.00	510S40GP	510S40GS	\$130.50	
6"	510S60P	510S60S	\$261.00	510S60GP	510S60GS	\$359.00	
8"	510S80P	510S80S	\$509.50	510S80GP	510S80GS	\$726.00	

All elbows are cast fittings.

Technical Data Sheet: TFP1815

G-FIRE #519S Global and Domestic – Fire Protection Short Pattern Grooved Tee

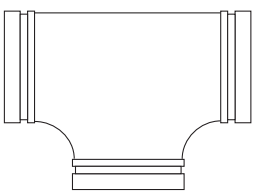
	Nom. Size	Painted			Galvanized		
		Global Part Number	Domestic Part Number	List Price	Global Part Number	Domestic Part Number	List Price
		2"	519S20P	519S20S	\$57.00	519S20GP	519S20GS
2 1/2"	519S25P	519S25S	\$75.00	519S25GP	519S25GS	\$96.00	
3"	519S30P	519S30S	\$104.50	519S30GP	519S30GS	\$134.00	
4"	519S40P	519S40S	\$158.00	519S40GP	519S40GS	\$206.00	
6"	519S60P	519S60S	\$421.00	519S60GP	519S60GS	\$549.50	
8"	519S80P	519S80S	\$895.00	519S80GP	519S80GS	\$1,182.00	

All tees are cast fittings.

Technical Data Sheet: TFP1815

G-FIRE #501 Global and Domestic – Fire Protection Standard Pattern Grooved 45° Elbow

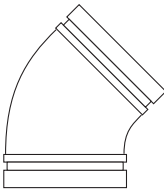
	Nom. Size	Painted			Galvanized		
		Global Part Number	Domestic Part Number	List Price	Global Part Number	Domestic Part Number	List Price
		1 1/4"	50113P	50113S	\$75.00	50113GP	50113GS
1 1/2"	50115P	50115S	\$75.00	50115GP	50115GS	\$94.50	
2"	50120P	50120S	\$37.50	50120GP	50120GS	\$48.00	
2 1/2"	50125P	50125S	\$50.00	50125GP	50125GS	\$62.50	
3"	50130P	50130S	\$65.50	50130GP	50130GS	\$83.00	
4"	50140P	50140S	\$94.00	50140GP	50140GS	\$125.50	
5"	–	20150S	\$343.50	–	20150GS	\$425.50	
6"	50160P	50160S	\$261.00	50160GP	50160GS	\$329.00	
8"	50180P	50180S	\$509.50	50180GP	50180GS	\$701.00	
10"	50110P	20110S	\$1,469.50	50110GP	20110GS	\$1,603.00	
12"	50112P	20112S	\$2,352.00	50112GP	20112GS	\$2,740.50	

All elbows are cast fittings.

Orders for items in shaded areas **cannot** be cancelled or returned.

Technical Data Sheet: TFP1815

G-FIRE #510 Global and Domestic – Fire Protection Standard Pattern Grooved 90° Elbow

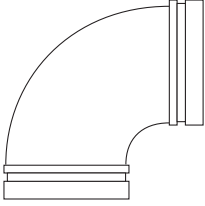
	Nom. Size	Painted			Galvanized		
		Global Part Number	Domestic Part Number	List Price	Global Part Number	Domestic Part Number	List Price
		1 1/4"	51013P	51013S	\$75.00	51013GP	51013GS
1 1/2"	51015P	51015S	\$75.00	51015GP	51015GS	\$99.50	
2"	51020P	51020S	\$75.00	51020GP	51020GS	\$99.50	
2 1/2"	51025P	51025S	\$75.00	51025GP	51025GS	\$99.50	
3"	51030P	51030S	\$132.50	51030GP	51030GS	\$165.50	
4"	51040P	51040S	\$144.00	51040GP	51040GS	\$201.50	
5"	–	21050S	\$343.50	–	21050GS	\$444.00	
6"	51060P	51060S	\$403.50	51060GP	51060GS	\$534.00	
8"	51080P	51080S	\$839.50	51080GP	51080GS	\$1,106.50	
10"	51010P	21010S	\$1,469.50	51010GP	21010GS	\$1,902.50	
12"	51012P	21012S	\$2,352.00	51012GP	21012GS	\$3,034.50	

All elbows are cast fittings.

Technical Data Sheet: TFP1815

G-FIRE #510DE Domestic – 90° Elbow with 1" Outlet

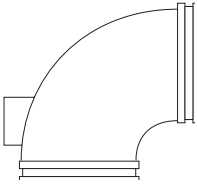
	Nom. Size	Painted		Galvanized	
		Domestic Part Number	List Price	Domestic Part Number	List Price
		2"	51020DS	\$175.50	51020DGS
2 1/2" *	51025DS	\$175.50	51025DGS	\$225.50	
3" *	51030DS	\$224.00	51030DGS	\$267.50	
4" *	51040DS	\$227.50	51040DGS	\$309.00	
6" *	51060DS	\$399.00	51060DGS	\$568.00	
8" *	51080DS	\$699.50	51080DGS	\$994.50	

Elbow is segmentally welded except where a * indicates it is available as a cast fitting.

Orders for items in shaded areas **cannot** be cancelled or returned.

Technical Data Sheet: TFP1815

G-FIRE #519 Global and Domestic – Fire Protection Standard Pattern Grooved Tee

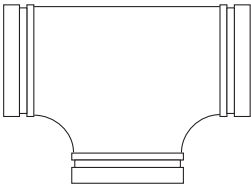
	Nom. Size	Painted			Galvanized		
		Global Part Number	Domestic Part Number	List Price	Global Part Number	Domestic Part Number	List Price
		1 1/4"	51913P	51913S	\$116.50	51913GP	51913GS
1 1/2"	51915P	51915S	\$116.50	51915GP	51915GS	\$152.00	
2"	51920P	51920S	\$116.50	51920GP	51920GS	\$152.00	
2 1/2"	51925P	51925S	\$116.50	51925GP	51925GS	\$152.00	
3"	51930P	51930S	\$159.50	51930GP	51930GS	\$218.00	
4"	51940P	51940S	\$242.50	51940GP	51940GS	\$329.50	
5"	–	21950S	\$565.50	–	21950GS	\$717.50	
6"	51960P	51960S	\$653.00	51960GP	51960GS	\$891.00	
8"	51980P	51980S	\$1,430.50	51980GP	51980GS	\$1,877.00	
10"	51910P	21910S	\$2,859.50	51910GP	21910GS	\$3,701.50	
12"	51912P	21912S	\$3,985.00	51912GP	21912GS	\$5,090.00	

All tees are cast fittings.

Orders for items in shaded areas **cannot** be cancelled or returned.

Technical Data Sheet: TFP1815

Section 16
Specialty Items

Section 18
Grooved Products

Section 19
CPVC Pipe & Fittings

Section 20
Miscellaneous

Section 21
Electrical

Section C
Valves & Hose Equipment

Section D
Backflow

Section F
Pipe & Accessories

Section H
Hangers

Section J
Lubricants

Section K
Misc.

#260 Domestic and Global – Grooved Cap

Nom. Size	Painted			Galvanized		
	Global Part Number	Domestic Part Number	List Price	Global Part Number	Domestic Part Number	List Price
1"	–	26001S	\$63.50	–	26001GS	\$76.00
1 1/4"	26013P	26013S	\$20.00	26013GP	26013GS	\$31.00
1 1/2"	26015P	26015S	\$21.00	26015GP	26015GS	\$31.00
2"	26020P	26020S	\$25.00	26020GP	26020GS	\$34.50
2 1/2"	26025P	26025S	\$29.50	26025GP	26025GS	\$37.50
3"	26030P	26030S	\$35.00	26030GP	26030GS	\$45.50
4"	26040P	26040S	\$51.50	26040GP	26040GS	\$70.50
5"	26050P	26050S	\$159.50	26050GP	26050GS	\$213.50
6"	26060P	26060S	\$116.50	26060GP	26060GS	\$161.00
8"	26080P	26080S	\$221.50	26080GP	26080GS	\$303.00
10"	26010P	26010S	\$615.00	26010GP	26010GS	\$801.00
12"	26012P	26012S	\$1,005.50	26012GP	26012GS	\$1,280.00

All caps are cast fittings.

Orders for items in shaded areas **cannot** be cancelled or returned.

Technical Data Sheet: TFP1815

#260 Domestic and Global – Grooved Cap with 1/2" Tap

Nom. Size	Painted		
	Global Part Number	Domestic Part Number	List Price
2"	26020TP	26020TS	\$328.00
2 1/2"	26025TP	26025TS	\$331.50
3"	26030TP	26030TS	\$331.50
4"	26040TP	26040TS	\$337.50
5"	–	26050TS	POA
6"	26060TP	26060TS	\$464.00
8"	26080TP	26080TS	\$684.00

All caps are cast fittings.

#260 Domestic and Global – Grooved Cap with 1" Tap

Nom. Size	Painted		
	Global Part Number	Domestic Part Number	List Price
2"	26020T1P	26020T1S	\$328.00
2 1/2"	26025T1P	26025T1S	\$331.50
3"	26030T1P	26030T1S	\$437.50
4"	26040T1P	26040T1S	\$421.50
5"	–	26050T1S	POA
6"	26060T1P	26060T1S	\$464.00
8"	26080T1P	26080T1S	\$554.50

All caps are cast fittings.

See latest catalog or technical data sheets for specific approvals, listings, and design parameters.
POA = Price on availability. Prices subject to change without notice.

#40-5 Domestic – Strap

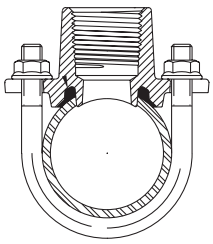
	Nom. Size	Domestic Part Number with "E" Gasket	List Price
	1 1/4" x 1/2"	STP1305ES	\$20.00
	1 1/4" x 3/4"	STP13075ES	\$20.00
	1 1/4" x 1"	STP1310ES	\$21.75
	1 1/2" x 1/2"	STP1505ES	\$21.75
	1 1/2" x 3/4"	STP15075ES	\$21.75
	1 1/2" x 1"	STP1510ES	\$22.75
	2" x 1/2"	STP2005ES	\$22.75
	2" x 3/4"	STP20075ES	\$22.75
	2" x 1"	STP2010ES	\$22.75
2 1/2" x 1/2"	STP2505ES	\$25.50	
2 1/2" x 3/4"	STP25075ES	\$25.50	
2 1/2" x 1"	STP2510ES	\$25.50	

ADACAP #750 Domestic

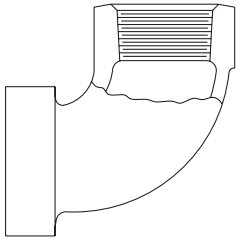
	Nom. Size	Domestic Part Number	List Price
	1 1/2" x 1/2"	7501505S	\$70.00
	1 1/2" x 3/4"	75015075S	\$70.00
	1 1/2" x 1"	7501510S	\$70.00
	2" x 1/2"	7502005S	\$75.00
	2" x 3/4"	75020075S	\$75.00
	2" x 1"	7502010S	\$75.00
	2 1/2" x 1/2"	7502505S	\$89.50
	2 1/2" x 3/4"	75025075S	\$89.50
	2 1/2" x 1"	7502510S	\$89.50

Technical Data Sheet: TFP1815

Section 16
Specialty Items

Section 18
Grooved Products

Section 19
CPVC Pipe & Fittings

Section 20
Miscellaneous

Section 21
Electrical

Section C
Valves & Hose Equipment

Section D
Backflow

Section F
Pipe & Accessories

Section H
Hangers

Section J
Lubricants

Section K
Misc.

Section 16
Specialty Items

Section 18
Grooved Product

Section 19
CPVC Pipe & Fittings

Section 20
Miscellaneous

Section 21
Electrical

Section C
Valves & Hose Equipment

Section D
Backflow

Section F
Pipe & Accessories

Section H
Hangers

Section J
Lubricants

Section K
Misc.

#512 Domestic – Grooved 22¹/₂° Elbow

Nom. Size	Painted		Galvanized	
	Domestic Part Number	List Price	Domestic Part Number	List Price
1 ¹ / ₄ "	51213S	\$82.00	51213GS	\$103.50
1 ¹ / ₂ "	51215S	\$82.00	51215GS	\$103.50
2"	51220S	\$82.00	51220GS	\$103.50
2 ¹ / ₂ "	51225S	\$82.00	51225GS	\$103.50
3"	51230S	\$117.50	51230GS	\$147.50
4"	51240S	\$155.50	51240GS	\$201.50
5"	51250S	\$476.00	51250GS	\$574.00
6"	51260S	\$435.50	51260GS	\$554.50
8"	51280S	\$907.50	51280GS	\$1,127.00
10" *	75559	\$1,197.00	75579	\$1,554.50
12" *	75560	\$1,617.50	75580	\$2,006.00

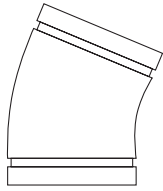

Elbow is Cast except where a * indicates it is segmentally welded.
Orders for items in shaded areas **cannot** be cancelled or returned.

Technical Data Sheet: TFP1810

#511 Domestic – Grooved 11¹/₄° Elbow

Nom. Size	Painted		Galvanized	
	Domestic Part Number	List Price	Domestic Part Number	List Price
1 ¹ / ₄ "	51113S	\$82.00	51113GS	\$103.50
1 ¹ / ₂ "	51115S	\$82.00	51115GS	\$103.50
2"	51120S	\$188.50	51120GS	\$220.00
2 ¹ / ₂ "	51125S	\$188.50	51125GS	\$220.00
3"	51130S	\$117.50	51130GS	\$146.50
4"	51140S	\$144.00	51140GS	\$191.00
5"	51150S	\$476.00	51150GS	\$560.00
6"	51160S	\$435.50	51160GS	\$526.00
8"	51180S	\$775.00	51180GS	\$921.50
10" *	75309	\$1,117.50	75315	\$1,334.00
12" *	75310	\$1,617.50	75323	\$1,959.00

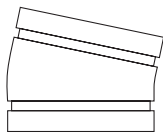

Elbow is Cast except where a * indicates it is segmentally welded.
Orders for items in shaded areas **cannot** be cancelled or returned.

Technical Data Sheet: TFP1810

See latest catalog or technical data sheets for specific approvals, listings, and design parameters.
POA = Price on availability. Prices subject to change without notice.

#321 Domestic – Grooved Reducing Tee

Nom. Size	Painted		Galvanized	
	Domestic Part Number	List Price	Domestic Part Number	List Price
2" x 1"	75410	\$245.50	75470	\$287.50
2" x 1 1/2"	75411	\$245.50	75471	\$292.00
2 1/2" x 1"	75412	\$245.50	3212510GS	\$287.50
2 1/2" x 1 1/4"	75413	\$369.50	73590	\$435.50
2 1/2" x 1 1/2"	75414	\$245.50	73591	\$292.00
2 1/2" x 2"	75415	\$245.50	75472	\$292.00
3" x 1"	75416	\$216.50	-	-
3" x 1 1/2"	75417	\$216.50	73592	\$279.50
3" x 2"	75418	\$216.50	75473	\$279.50
3" x 2 1/2"	75419	\$216.50	75474	\$279.50
4" x 1"	75420	\$292.00	3214010GS	\$364.50
4" x 1 1/2"	75421	\$292.00	73594	\$364.50
4" x 2"	75422	\$292.00	75475	\$383.00
4" x 2 1/2"	75423	\$292.00	75476	\$383.00
4" x 3"	75424	\$292.00	75477	\$383.00
5" x 2"	75425	\$707.50	73595	\$874.00
5" x 2 1/2"	75426	\$576.50	73596	\$725.50
5" x 3"	75427	\$576.50	75489	\$725.50
5" x 4"	75428	\$623.50	73597	\$788.00
6" x 2"	75429	\$686.50	75478	\$901.50
6" x 2 1/2"	75430	\$686.50	75479	\$901.50
6" x 3"	75431	\$686.50	75480	\$901.50
6" x 4"	75432	\$686.50	75481	\$901.50
6" x 5"	75433	\$686.50	3216050GS	\$907.50
8" x 3"	75435	\$1,066.00	75482	\$1,274.00
8" x 4"	75436	\$1,430.50	75483	\$1,848.00
8" x 5"	75437	\$1,430.50	75484	\$1,860.50
8" x 6"	75438	\$1,430.50	75485	\$1,868.50
10" x 3"	75439	\$1,659.00	73621	\$2,640.00
10" x 4"	75440	\$1,734.50	73622	\$2,217.00
10" x 5"	75441	\$1,773.00	73623	\$2,263.00
10" x 6"	75442	\$1,773.00	73624	\$2,878.50
10" x 8"	75443	\$1,805.50	73625	\$2,892.50
12" x 6"	75444	\$2,560.50	73629	\$3,756.00
12" x 8"	75445	\$2,631.50	73630	\$3,979.50
12" x 10"	75446	\$2,754.50	73631	\$4,283.00

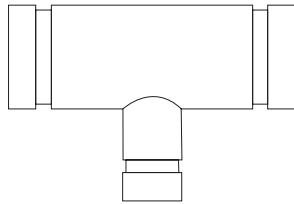

All adapters are segmentally welded.

Orders for items in shaded areas **cannot** be cancelled or returned.

Technical Data Sheet: TFP1810

Section 16
Specialty Items

Section 18
Grooved Products

Section 19
CPVC Pipe & Fittings

Section 20
Miscellaneous

Section 21
Electrical

Section C
Valves & Hose Equipment

Section D
Backflow

Section F
Pipe & Accessories

Section H
Hangers

Section J
Lubricants

Section K
Misc.

Section 16
Specialty Items

Section 18
Grooved Product

Section 19
CPVC Pipe & Fittings

Section 20
Miscellaneous

Section 21
Electrical

Section C
Valves & Hose Equipment

Section D
Backflow

Section F
Pipe & Accessories

Section H
Hangers

Section J
Lubricants

Section K
Misc.

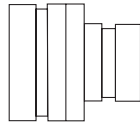

#550 and #350 Domestic – Concentric Reducer					
Nom. Size	Painted		Galvanized		
	Domestic Part Number	List Price	Domestic Part Number	List Price	
1 1/2" x 1"	74328	\$88.00	73400	\$103.00	
1 1/2" x 1 1/4"	5501513S *	\$88.00	5501513GS *	\$103.00	
2" x 1/2"	72850	POA	73392	POA	
2" x 3/4"	72851	\$88.00	73401	\$103.00	
2" x 1"	72852	\$88.00	73402	\$103.00	
* 2" x 1 1/4"	72853	\$95.50	73403	\$112.50	
* 2" x 1 1/2"	72854	\$88.00	73404	\$103.00	
2 1/2" x 1"	72855	\$119.00	73393	\$137.50	
2 1/2" x 1 1/4"	5502513S *	\$88.00	5502513GS *	\$103.00	
2 1/2" x 1 1/2"	5502515S *	\$88.00	5502515GS *	\$103.00	
* 2 1/2" x 2"	5502520S *	\$88.00	5502520GS *	\$103.00	
3" x 1"	72860	\$95.50	73406	\$117.00	
3" x 1 1/4"	72861	\$153.50	73396	\$177.00	
3" x 1 1/2"	5503015S *	\$105.50	5503015GS *	\$128.50	
3" x 2"	5503020S *	\$77.50	5503020GS *	\$94.50	
3" x 2 1/2"	5503025S *	\$105.50	5503025GS *	\$127.50	
4" x 1"	72867	\$116.50	73409	\$142.50	
4" x 1 1/4"	72868	\$889.50	73756	\$996.50	
4" x 1 1/2"	72869	\$160.50	73410	\$212.00	
4" x 2"	5504020S *	\$103.00	5504020GS *	\$126.50	
4" x 2 1/2"	5504025S *	\$127.50	5504025GS *	\$155.00	
4" x 3"	5504030S *	\$127.50	5504030GS *	\$155.00	
4" x 3 1/2"	72875	\$127.50	73398	\$155.00	
5" x 2"	72876	\$1,251.50	73399	\$1,382.00	
5" x 2 1/2"	72877	\$259.00	73758	\$316.00	
5" x 3"	5505030S *	\$147.50	5505030GS *	\$183.00	
5" x 4"	5505040S *	\$176.00	5505040GS *	\$220.00	
6" x 2"	5506020S *	\$233.00	5506020GS *	\$290.50	
6" x 2 1/2"	5506025S *	\$259.00	5506025GS *	\$318.50	
6" x 3"	5506030S *	\$233.00	5506030GS *	\$290.50	
6" x 4"	5506040S *	\$204.00	5506040GS *	\$263.50	
6" x 5"	5506050S *	\$300.50	5506050GS *	\$373.00	
8" x 3"	5508030S *	\$415.00	5508030GS *	\$516.50	
8" x 4"	5508040S *	\$415.00	5508040GS *	\$519.50	
8" x 5"	5508050S *	\$415.00	5508050GS *	\$523.00	
8" x 6"	5508060S *	\$526.50	5508060GS *	\$659.50	
10" x 4"	72889	\$945.00	73764	\$1,163.50	
10" x 6"	5501060S *	\$1,033.50	73425	\$1,288.50	
10" x 8"	72891	\$1,033.50	73422	\$1,310.50	
12" x 4"	5501240S *	\$4,524.50	73766	\$5,385.00	
12" x 6"	5501260S *	\$1,232.50	73767	\$1,523.50	
12" x 8"	5501280S *	\$1,849.00	73423	\$2,183.50	
12" x 10"	5501210S *	\$1,849.00	73424	\$2,289.00	

Reducer is segmentally welded except where a * indicates it is available as a cast fitting.

Orders for items in shaded areas **cannot** be cancelled or returned.

Technical Data Sheet: TFP1810

#341 Domestic – Grooved x Flanged Adapter 150 Lbs. – Schedule 40

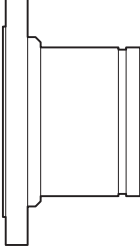
	Nom. Size	Painted		Galvanized	
		Domestic Part Number	List Price	Domestic Part Number	List Price
		2"	73230	\$316.50	73250
2 1/2"	73231	\$632.00	73251	\$744.50	
3"	73232	\$647.00	73252	\$769.00	
4"	73233	\$737.50	73253	\$1,075.00	
5"	73234	\$1,021.00	73254	\$1,414.00	
6"	73235	\$1,039.00	73255	\$1,433.50	
8"	73236	\$1,286.00	73256	\$1,914.50	
10"	73237	\$1,942.50	74265	\$2,912.00	
12"	73238	\$2,659.50	74254	\$3,839.50	

All adapters are segmentally welded.

Orders for items in shaded areas **cannot** be cancelled or returned.

Technical Data Sheet: TFP1810

#342 Domestic – Grooved x Flanged Adapter 300 Lbs. – Schedule 40

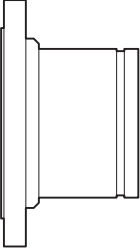
	Nom. Size	Painted		Galvanized	
		Domestic Part Number	List Price	Domestic Part Number	List Price
		4"	73260	\$1,015.00	73263
5"	73261	\$1,039.00	73264	POA	
6"	73262	\$1,039.00	74283	\$1,569.00	

All adapters are segmentally welded.

Orders for items in shaded areas **cannot** be cancelled or returned.

#320 Domestic – Grooved x Male Thread Tee, Painted

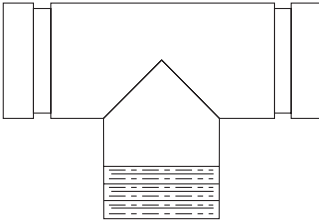
	Nom. Size	Painted		Galvanized	
		Domestic Part Number	List Price	Domestic Part Number	List Price
		1 1/2"	75490	\$379.50	73553
2"	75491	\$243.50	73554	\$286.00	
2 1/2"	75492	POA	73555	POA	
3"	75493	POA	32030GS	POA	
4"	75465	\$503.50	73557	\$692.50	
6"	75466	\$1,292.00	73559	\$1,520.50	

Adapter is segmentally welded.

Orders for items in shaded areas **cannot** be cancelled or returned.

Standpipe Domestic – Tee

Nom. Size	Painted		Galvanized	
	Domestic Part Number	List Price	Domestic Part Number	List Price
4" x 4" x 2 1/2"	76768	POA	76755	POA
6" x 6" x 2 1/2"	76769	POA	76771	POA

Orders for items in shaded areas **cannot** be cancelled or returned.

#507/#50L Domestic – Bullhead Tee

Nom. Size	Painted		Galvanized	
	Domestic Part Number	List Price	Domestic Part Number	List Price
5" x 5" x 8"	76772	POA	76774	POA
6" x 6" x 8"	76773	POA	76775	POA

Orders for items in shaded areas **cannot** be cancelled or returned.

#323 Domestic – Reducing Tee with Threaded Branch

Nom. Size	Painted		Galvanized	
	Domestic Part Number	List Price	Domestic Part Number	List Price
2" x 1"	75500	\$259.00	75520	\$304.00
2" x 1 1/2"	75501	\$259.00	75522	\$308.00
2 1/2" x 1 1/4"	75502	\$566.00	73608	\$582.00
2 1/2" x 1 1/2"	75503	\$259.00	73609	\$308.00
2 1/2" x 2"	75504	\$259.00	73610	\$310.50
3" x 1"	75505	\$259.00	75521	\$324.00
3" x 1 1/2"	75506	\$259.00	75546	\$326.00
3" x 2"	75507	\$259.00	75523	\$326.00
3" x 2 1/2"	75508	\$624.50	73611	\$676.00
4" x 1"	75509	\$324.00	75524	\$399.00
4" x 2"	75510	\$324.00	75525	\$406.00
4" x 2 1/2"	75511	\$324.00	73691	\$417.50
4" x 3"	75512	\$324.00	75526	\$419.00
5" x 2"	75513	\$693.00	75534	\$755.00
6" x 2"	75514	\$808.50	75527	\$1,007.00
6" x 2 1/2"	75590	\$808.50	75528	\$1,007.00
6" x 3"	75515	\$808.50	75529	\$1,007.00
6" x 4"	75516	\$1,022.00	73694	\$1,099.00
6" x 5"	75517	\$808.50	73695	\$1,007.00
8" x 2"	75518	\$989.50	73696	\$1,365.00
8" x 3"	75519	\$1,365.00	73697	\$1,770.00

All tees are segmentally welded.

Orders for items in shaded areas **cannot** be cancelled or returned.

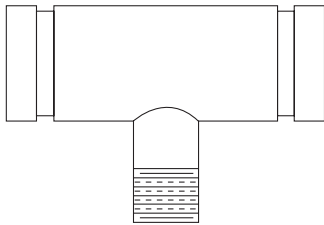

See latest catalog or technical data sheets for specific approvals, listings, and design parameters.
POA = Price on availability. Prices subject to change without notice.

#327 Domestic – Grooved Cross

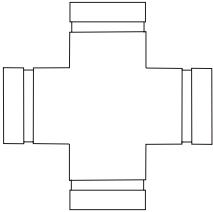
	Nom. Size	Painted		Galvanized	
		Domestic Part Number	List Price	Domestic Part Number	List Price
	2"	75840	\$207.50	75849	\$247.00
	2½"	75841	\$207.50	75850	\$247.00
	3"	75842	\$369.00	75851	\$452.00
	4"	75843	\$612.00	75852	\$753.00
	6"	75845	\$1,601.00	75853	\$1,943.50
	8"	75846	\$2,109.50	76757	\$2,609.50
	10"	75847	\$3,460.50	76758	\$4,280.50
	12"	75848	\$4,993.50	76759	\$6,221.00

Orders for items in shaded areas **cannot** be cancelled or returned.

Technical Data Sheet: TFP1815

#372 Domestic – Reducer Small End Threaded (Male)

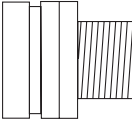
	Nom. Size	Painted		Galvanized	
		Domestic Part Number	List Price	Domestic Part Number	List Price
	1½" x 1"	76800	\$91.50	76825	\$112.00
	2" x ¾"	76801	\$91.50	76826	\$112.00
	2" x 1"	76802	\$91.50	76827	\$112.00
	2" x 1¼"	76815	\$91.50	73794	\$112.00
	2" x 1½"	76803	\$91.50	76828	\$112.00
	2½" x 1¼"	76816	\$129.50	73795	\$159.50
	2½" x 1½"	76817	\$135.50	73796	\$159.50
	2½" x 2"	76804	\$91.50	76829	\$112.00
	3" x 1"	76805	\$99.50	76830	\$119.50
	3" x 1¼"	76818	\$313.00	3723013GS	\$347.50
	3" x 1½"	76819	\$112.00	73797	\$134.00
	3" x 2"	76806	\$112.00	76831	\$134.00
	3" x 2½"	76807	\$135.50	76832	\$159.50
	4" x 1"	76808	\$128.00	76833	\$155.00
	4" x 1¼"	76820	POA	3724013GS	POA
	4" x 1½"	76821	\$299.50	73799	\$391.50
	4" x 2"	76809	\$136.50	76834	\$163.00
	4" x 2½"	76810	\$137.00	76835	\$168.00
	4" x 3"	76811	\$167.50	76836	\$198.00
	6" x 1"	76812	\$259.00	76837	\$318.50
6" x 2"	76813	\$259.00	76838	\$318.50	
6" x 3"	76814	\$259.00	76839	\$318.50	

All reducers are segmentally welded.

Orders for items in shaded areas **cannot** be cancelled or returned.

#391 Domestic – Groove x Male Thread Adapter Nipple

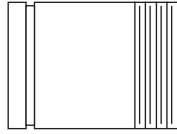

Nom. Size	Painted		Galvanized	
	Domestic Part Number	List Price	Domestic Part Number	List Price
1 1/4" x 4"	75121	\$45.50	74292	POA
1 1/2" x 4"	75122	\$45.50	74293	POA
2" x 4"	75123	\$45.50	74294	\$90.00
2 1/2" x 4"	75124	\$52.50	74295	\$153.50
3" x 4"	75125	\$63.50	74296	\$128.00
3" x 6"	74335	\$103.00	3913060GS	\$180.50
4" x 6"	75126	\$104.00	74297	\$252.50
5" x 6"	75129	\$215.00	74298	POA
6" x 6"	75130	\$275.50	74299	\$491.50
8" x 6"	75131	\$309.00	74336	POA
10" x 8"	75132	\$432.50	74337	POA
12" x 8"	75133	\$542.00	74338	POA

All adapter nipples are segmentally welded.

Orders for items in shaded areas **cannot** be cancelled or returned.

Technical Data Sheet: TFP1810

#392 Domestic – Groove x Groove Adapter Nipple

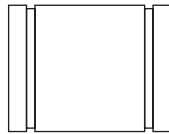

Nom. Size	Painted		Galvanized	
	Domestic Part Number	List Price	Domestic Part Number	List Price
1 1/4" x 4"	75098	\$45.50	74339	POA
1 1/2" x 4"	75099	\$45.50	74405	POA
2" x 4"	75100	\$45.50	74406	POA
2 1/2" x 4"	75101	\$52.50	74407	POA
3" x 4"	75102	\$63.50	74408	POA
4" x 6"	75103	\$104.00	74309	POA
5" x 6"	75104	\$215.00	74310	POA
6" x 6"	75105	\$275.50	74311	POA
8" x 6"	75106	\$309.00	74312	POA
10" x 8"	75107	\$432.50	74313	POA
12" x 8"	75108	\$542.00	74314	POA

All adapter nipples are segmentally welded.

Orders for items in shaded areas **cannot** be cancelled or returned.

Technical Data Sheet: TFP1810

#393 Domestic – Groove x Plain Adapter Nipple

Nom. Size	Painted		Galvanized	
	Domestic Part Number	List Price	Domestic Part Number	List Price
1 1/4" x 4"	75148	\$45.50	74316	POA
1 1/2" x 4"	74315	\$45.50	74317	POA
2" x 4"	75150	\$45.50	74318	POA
2 1/2" x 4"	75151	\$52.50	74319	POA
3" x 4"	75152	\$63.50	74330	POA
4" x 6"	75153	\$104.00	74331	POA
5" x 6"	75158	\$215.00	74322	POA
6" x 6"	75154	\$275.50	74323	POA
8" x 6"	75155	\$309.00	74324	POA
10" x 8"	75156	\$432.50	74325	POA
12" x 8"	75157	\$542.00	74326	POA

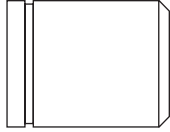

All adapter nipples are segmentally welded.

Orders for items in shaded areas **cannot** be cancelled or returned.

Technical Data Sheet: TFP1810

Section 16
Specialty Items

Section 18
Grooved Products

Section 19
CPVC Pipe & Fittings

Section 20
Miscellaneous

Section 21
Electrical

Section C
Valves & Hose Equipment

Section D
Backflow

Section F
Pipe & Accessories

Section H
Hangers

Section J
Lubricants

Section K
Misc.

**#730 Domestic – Female Threaded Mechanical Tee
with Grade “E” EPDM Gasket Threaded Outlet**

Nom. Size	Painted		Galvanized		Gasket Only	
	Domestic Part Number	List Price	Domestic Part Number	List Price	Domestic Part Number	List Price
2" x 1/2"	7302005ES	\$70.00	7302005EGS	\$88.50	730EGS-1	\$14.50
2" x 3/4"	73020075ES	\$70.00	73020075EGS	\$88.50	730EGS-1	\$14.50
2" x 1"	7302010ES	\$70.00	7302010EGS	\$88.50	730EGS-1	\$14.50
2" x 1 1/4"	7302013ES	\$81.00	7302013EGS	\$101.00	730EGS-2	\$16.50
2" x 1 1/2"	7302015ES	\$81.00	7302015EGS	\$101.00	730EGS-2	\$16.50
2 1/2" x 1/2"	7302505ES	\$70.00	7302505EGS	\$88.50	730EGS-1	\$14.50
2 1/2" x 3/4"	73025075ES	\$70.00	73025075EGS	\$88.50	730EGS-1	\$14.50
2 1/2" x 1"	7302510ES	\$70.00	7302510EGS	\$88.50	730EGS-1	\$14.50
2 1/2" x 1 1/4"	7302513ES	\$99.00	7302513EGS	\$120.50	730EGS-3	\$16.50
2 1/2" x 1 1/2"	7302515ES	\$99.00	7302515EGS	\$120.50	730EGS-3	\$16.50
2 1/2" x 2"	7302520EP *	\$99.00	7302520EGP *	POA	730EGS-4	\$16.50
3" x 1/2"	7303005ES	\$81.00	7303005EGS	\$99.00	730EGS-1	\$14.50
3" x 3/4"	73030075ES	\$81.00	73030075EGS	\$99.00	730EGS-1	\$14.50
3" x 1"	7303010ES	\$81.00	7303010EGS	\$99.00	730EGS-1	\$14.50
3" x 1 1/4"	7303013ES	\$102.50	7303013EGS	\$128.50	730EGS-2	\$16.50
3" x 1 1/2"	7303015ES	\$102.50	7303015EGS	\$128.50	730EGS-3	\$16.50
3" x 2"	7303020ES	\$118.00	7303020EGS	\$147.00	730EGS-4	\$16.50
4" x 1/2"	7304005ES	\$102.00	7304005EGS	\$122.00	730EGS-1	\$14.50
4" x 3/4"	73040075ES	\$102.00	73040075EGS	\$122.00	730EGS-1	\$14.50
4" x 1"	7304010ES	\$102.00	7304010EGS	\$122.00	730EGS-1	\$14.50
4" x 1 1/4"	7304013ES	\$119.50	7304013EGS	\$141.00	730EGS-2	\$16.50
4" x 1 1/2"	7304015ES	\$124.50	7304015EGS	\$156.50	730EGS-3	\$16.50
4" x 2"	7304020ES	\$124.50	7304020EGS	\$158.00	730EGS-4	\$16.50
4" x 2 1/2"	7304025ES	\$130.00	7304025EGS	\$168.50	730EGS-5	\$19.00
4" x 3"	7304030ES	\$138.50	7304030EGS	\$177.50	730EGS-7	\$21.00
5" x 1 1/2"	7305015EP *	\$152.00	7305015EGP *	\$192.50	730EGS-3	\$16.50
5" x 2"	7305020ES	\$152.00	7305020EGS	\$192.50	730EGS-4	\$16.50
5" x 2 1/2"	7305025ES	\$160.50	7305025EGS	\$204.50	730EGS-5	\$19.00
5" x 3"	7305030EP *	\$170.50	7305030EGP *	\$219.50	730EGS-7	\$21.00
6" x 1 1/4"	7306013EP *	POA	7306013EGP *	POA	730EGS-2	\$16.50
6" x 1 1/2"	7306015ES	\$156.00	7306015EGS	\$199.50	730EGS-3	\$16.50
6" x 2"	7306020ES	\$156.00	7306020EGS	\$199.50	730EGS-4	\$16.50
6" x 2 1/2"	7306025ES	\$168.00	7306025EGS	\$217.00	730EGS-6	\$19.00
6" x 3"	7306030ES	\$178.00	7306030EGS	\$229.50	730EGS-8	\$21.00
6" x 4"	7306040ES	\$197.50	7306040EGS	\$257.50	730EGS-9	\$28.00
8" x 2 1/2"	7308025ES	\$272.50	7308025EGS	\$344.00	730EGS-6	\$19.00
8" x 3"	7308030ES	\$287.50	7308030EGS	\$364.50	730EGS-8	\$21.00
8" x 4"	7308040ES	\$296.00	7308040EGS	\$382.50	730EGS-9	\$28.00

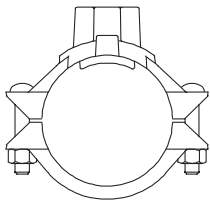

* Only available as Global.

Orders for items in shaded areas **cannot** be cancelled or returned.

Technical Data Sheet: TFP1860

**#730 Domestic – Grooved Mechanical Tee
with Grade “E” EPDM Gasket Grooved Outlet**

Nom. Size	Painted		Galvanized		Gasket Only	
	Domestic Part Number	List Price	Domestic Part Number	List Price	Domestic Part Number	List Price
2" x 1 1/4"	7302013ERS	\$81.00	7302013EGRS	\$101.00	730EGS-2	\$16.50
2" x 1 1/2"	7302015ERS	\$81.00	7302015EGRS	\$101.00	730EGS-2	\$16.50
2 1/2" x 1 1/4"	7302513ERS	\$99.00	7302513EGRS	\$120.50	730EGS-3	\$16.50
2 1/2" x 1 1/2"	7302515ERS	\$99.00	7302515EGRS	\$120.50	730EGS-3	\$16.50
2 1/2" x 2"	7302520ERP *	POA	7302520EGRP *	POA	730EGS-4	\$16.50
3" x 1 1/4"	7303013ERS	\$102.50	7303013EGRS	\$128.50	730EGS-2	\$16.50
3" x 1 1/2"	7303015ERS	\$102.50	7303015EGRS	\$128.50	730EGS-3	\$16.50
3" x 2"	7303020ERS	\$118.00	7303020EGRS	\$147.00	730EGS-4	\$16.50
4" x 1 1/4"	7304013ERS	\$119.50	7304013EGRS	\$141.00	730EGS-2	\$16.50
4" x 1 1/2"	7304015ERS	\$124.50	7304015EGRS	\$156.50	730EGS-3	\$16.50
4" x 2"	7304020ERS	\$124.50	7304020EGRS	\$158.00	730EGS-4	\$16.50
4" x 2 1/2"	7304025ERS	\$130.00	7304025EGRS	\$168.50	730EGS-5	\$19.00
4" x 3"	7304030ERS	\$138.50	7304030EGRS	\$177.50	730EGS-7	\$21.00
5" x 1 1/2"	7305015ERP *	\$152.00	7305015EGRP *	POA	730EGS-3	\$16.50
5" x 2"	7305020ERS	\$152.00	7305020EGRS	\$192.50	730EGS-4	\$16.50
5" x 2 1/2"	7305025ERS	\$160.50	7305025EGRS	POA	730EGS-5	\$19.00
5" x 3"	7305030ERP *	\$170.50	7305030EGRP *	\$219.50	730EGS-7	\$21.00
6" x 1 1/4"	7306013ERP *	\$156.00	7306013EGRP *	\$199.50	730EGS-2	\$16.50
6" x 1 1/2"	7306015ERS	\$156.00	7306015EGRS	\$199.50	730EGS-3	\$16.50
6" x 2"	7306020ERS	\$156.00	7306020EGRS	\$199.50	730EGS-4	\$16.50
6" x 2 1/2"	7306025ERS	\$170.50	7306025EGRS	\$217.00	730EGS-6	\$19.00
6" x 3"	7306030ERS	\$178.00	7306030EGRS	\$229.50	730EGS-8	\$21.00
6" x 4"	7306040ERS	\$197.50	7306040EGRS	\$257.50	730EGS-9	\$28.00
8" x 2 1/2"	7308025ERS	\$272.50	7308025EGRS	\$344.00	730EGS-6	\$19.00
8" x 3"	7308030ERS	\$287.50	7308030EGRS	\$364.50	730EGS-8	\$21.00
8" x 4"	7308040ERS	\$296.00	7308040EGRS	\$382.50	730EGS-9	\$28.00

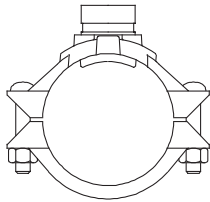

* Only available as Global.

Orders for items in shaded areas **cannot** be cancelled or returned.

Technical Data Sheet: TFP1860

Section 16
Specialty Items

Section 18
Grooved Products

Section 19
CPVC Pipe & Fittings

Section 20
Miscellaneous

Section 21
Electrical

Section C
Valves & Hose Equipment

Section D
Backflow

Section F
Pipe & Accessories

Section H
Hangers

Section J
Lubricants

Section K
Misc.

**#730 Domestic – Female Threaded Mechanical Cross
with Grade “E” EPDM Gasket Threaded Outlet**

Nom. Size	Painted		Galvanized		Gasket Only (2 required for Cross)	
	Domestic Part Number	List Price	Domestic Part Number	List Price	Domestic Part Number	List Price
2" x 1 1/4"	7302013ECS	\$127.00	7302013EGCS	\$163.00	730EGS-2	\$16.50
2" x 1 1/2"	7302015ECS	\$127.00	7302015EGCS	\$163.00	730EGS-2	\$16.50
2 1/2" x 1 1/4"	7302513ECS	\$152.50	7302513EGCS	\$197.00	730EGS-3	\$16.50
2 1/2" x 1 1/2"	7302515ECS	\$152.50	7302515EGCS	\$210.50	730EGS-3	\$16.50
3" x 1 1/4"	7303013ECS	\$152.50	7303013EGCS	\$190.50	730EGS-2	\$16.50
3" x 1 1/2"	7303015ECS	\$152.50	7303015EGCS	\$190.50	730EGS-3	\$16.50
3" x 2"	7303020ECS	\$176.50	7303020EGCS	\$218.50	730EGS-4	\$16.50
4" x 1 1/4"	7304013ECS	\$185.00	7304013EGCS	\$232.50	730EGS-2	\$16.50
4" x 1 1/2"	7304015ECS	\$185.00	7304015EGCS	\$232.50	730EGS-3	\$16.50
4" x 2"	7304020ECS	\$198.00	7304020EGCS	\$234.00	730EGS-4	\$16.50
4" x 2 1/2"	7304025ECS	\$198.00	7304025EGCS	\$252.00	730EGS-5	\$19.00
4" x 3"	7304030ECS	\$206.50	7304030EGCS	\$267.00	730EGS-7	\$21.00
5" x 2"	7305020ECS	\$226.50	7305020EGCS	\$287.50	730EGS-4	\$16.50
5" x 2 1/2"	7305025ECS	\$238.50	7305025EGCS	\$304.50	730EGS-5	\$19.00
6" x 1 1/2"	7306015ECS	\$232.00	7306015EGCS	\$298.50	730EGS-3	\$16.50
6" x 2"	7306020ECS	\$242.00	7306020EGCS	\$322.50	730EGS-4	\$16.50
6" x 2 1/2"	7306025ECS	\$249.00	7306025EGCS	\$322.50	730EGS-6	\$19.00
6" x 3"	7306030ECS	\$266.00	7306030EGCS	\$341.50	730EGS-8	\$21.00
6" x 4"	7306040ECS	\$294.50	7306040EGCS	\$382.50	730EGS-9	\$28.00
8" x 2 1/2"	7308025ECS	\$407.50	7308025EGCS	\$514.50	730EGS-6	\$19.00
8" x 3"	7308030ECS	\$429.00	7308030EGCS	\$545.50	730EGS-8	\$21.00
8" x 4"	7308040ECS	\$443.50	7308040EGCS	\$573.00	730EGS-9	\$28.00

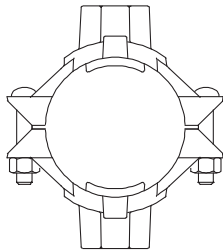

Orders for items in shaded areas **cannot** be cancelled or returned.

Technical Data Sheet: TFP1860

See latest catalog or technical data sheets for specific approvals, listings, and design parameters.
POA = Price on availability. Prices subject to change without notice.

**#730 Domestic – Grooved Mechanical Cross
with Grade “E” EPDM Gasket Grooved Outlet**

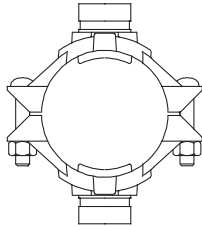

Nom. Size	Painted		Galvanized		Gasket Only (2 required for Cross)	
	Domestic Part Number	List Price	Domestic Part Number	List Price	Domestic Part Number	List Price
2" x 1 1/4"	7302013ERCS	\$127.00	7302013EGRCS	\$163.00	730EGS-2	\$16.50
2" x 1 1/2"	7302015ERCS	\$127.00	7302015EGRCS	\$163.00	730EGS-2	\$16.50
2 1/2" x 1 1/4"	7302513ERCS	\$152.50	7302513EGRCS	\$197.00	730EGS-3	\$16.50
2 1/2" x 1 1/2"	7302515ERCS	\$152.50	7302515EGRCS	\$163.00	730EGS-3	\$16.50
3" x 1 1/4"	7303013ERCS	\$152.50	7303013EGRCS	\$190.50	730EGS-2	\$16.50
3" x 1 1/2"	7303015ERCS	\$152.50	7303015EGRCS	\$190.50	730EGS-3	\$16.50
3" x 2"	7303020ERCS	\$176.50	7303020EGRCS	\$218.50	730EGS-4	\$16.50
4" x 1 1/4"	7304013ERCS	\$185.00	7304013EGRCS	\$232.50	730EGS-2	\$16.50
4" x 1 1/2"	7304015ERCS	\$185.00	7304015EGRCS	\$232.50	730EGS-3	\$16.50
4" x 2"	7304020ERCS	\$198.00	7304020EGRCS	\$234.00	730EGS-4	\$16.50
4" x 2 1/2"	7304025ERCS	\$198.00	7304025EGRCS	\$252.00	730EGS-5	\$19.00
4" x 3"	7304030ERCS	\$206.50	7304030EGRCS	\$267.00	730EGS-7	\$21.00
5" x 2"	7305020ERCS	\$226.50	7305020EGRCS	\$287.50	730EGS-4	\$16.50
5" x 2 1/2"	7305025ERCS	\$238.50	7305025EGRCS	\$304.50	730EGS-5	\$19.00
6" x 1 1/2"	7306015ERCS	\$232.00	7306015EGRCS	\$298.50	730EGS-3	\$16.50
6" x 2"	7306020ERCS	\$242.00	7306020EGRCS	\$322.50	730EGS-4	\$16.50
6" x 2 1/2"	7306025ERCS	\$249.00	7306025EGRCS	\$322.50	730EGS-6	\$19.00
6" x 3"	7306030ERCS	\$266.00	7306030EGRCS	\$341.50	730EGS-8	\$21.00
6" x 4"	7306040ERCS	\$294.50	7306040EGRCS	\$382.50	730EGS-9	\$28.00
8" x 2 1/2"	7308025ERCS	\$407.50	7308025EGRCS	\$514.50	730EGS-6	\$19.00
8" x 3"	7308030ERCS	\$429.00	7308030EGRCS	\$545.50	730EGS-8	\$21.00
8" x 4"	7308040ERCS	\$443.50	7308040EGRCS	\$573.00	730EGS-9	\$28.00

Orders for items in shaded areas **cannot** be cancelled or returned.

Technical Data Sheet: TFP1860

Section 16
Specialty Items

Section 18
Grooved Products

Section 19
CPVC Pipe & Fittings

Section 20
Miscellaneous

Section 21
Electrical

Section C
Valves & Hose Equipment

Section D
Backflow

Section F
Pipe & Accessories

Section H
Hangers

Section J
Lubricants

Section K
Misc.

G-FIRE #BFV-N Domestic – Grooved Butterfly Valves Fire Protection

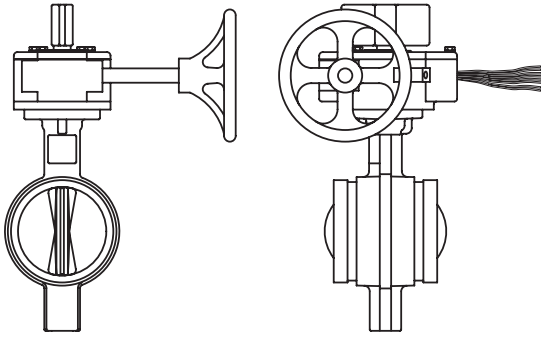

**Model BFV-N Grv x Grv, Gear Operated
with Tamper Switches – 300psi**

<i>Nom. Size</i>	<i>Domestic Part Number - UL, FM & ULC</i>	<i>List Price</i>
2 1/2"	59-300-F-025N	\$636.50
3"	59-300-F-030N	\$688.50
4"	59-300-F-040N	\$722.00
5"	59-300-F-050N	\$1,081.50
6"	59-300-F-060N	\$1,025.50
8"	59-300-F-080N	\$1,571.00
10"	59-300-F-100N	\$3,803.50

Orders for items in shaded areas **cannot** be cancelled or returned.

Technical Data Sheet: TFP1510

G-FIRE #CV-1F Global – Grooved Check Valve

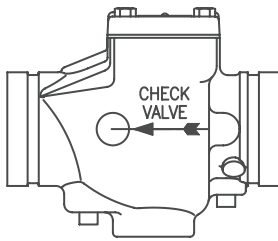

<i>Nom. Size</i>	<i>Global Part Number</i>	<i>List Price</i>
2"	59-590-0-020	\$345.50
2 1/2"	59-590-0-025	\$365.00
3"	59-590-0-030	\$365.00
4"	59-590-0-040	\$379.50
5"	59-590-0-050	\$923.00
6"	59-590-0-060	\$945.50
8"	59-590-0-080	\$1,642.00
10"	59-590-0-100	\$3,128.50

Technical Data Sheet: TFP1550

Section 16 Specialty Items
Section 18 Grooved Product
Section 19 CPVC Pipe & Fittings
Section 20 Miscellaneous
Section 21 Electrical
Section C Valves & Hose Equipment
Section D Backflow
Section F Pipe & Accessories
Section H Hangers
Section J Lubricants
Section K Misc.

See latest catalog or technical data sheets for specific approvals, listings, and design parameters.
POA = Price on availability. Prices subject to change without notice.

Roll Grooving Machine Selection Chart

Machine Type	Pace Model	Size Range				Drive	Rolls Supplied			Part No.	List Price **
		Sch. 40	Sch. 10	Std. Wall	Copper		Size	Steel	Copper		
Portable with Electric Motor	1112	1" - 12"	-	-	2" - 8"	1 1/2 HP, 110V	1" - 12"	■		41048	\$6,943.00
	1023	1 1/4" - 12"	-	12" - 24"	2" - 8"	1 1/2 HP, 110V	1 1/4" - 12"	■		41029	\$10,268.00
							2" - 12"	■		41250	\$9,772.00
							1 1/4" - 24"	■		41251	\$11,439.00
2" - 24"	■		41252	\$10,939.00							
Portable for Ridgid® 300	1012	1" - 12"	-	-	2" - 8"	Ridgid® 300	1" - 12"	■		41041	\$3,853.00
	1022	1 1/4" - 12"	-	12" - 16"	2" - 8"	Ridgid® 300	1 1/4" - 16"	■		41027	\$8,674.00
	1041	1" - 6"	1" - 12"	-	2" - 8"	Ridgid® 300	1" - 12"	■		41018	\$2,699.00
	1039	1 1/4" - 6"	-	-	2" - 8"	Ridgid® 300, Hand Crank	1 1/4" - 6" IPS	■		41017	\$767.00
	1034	1 1/4" - 6"	-	-	-	Ridgid® 300	1 1/4" - 6" IPS	■		41015	\$571.00
Automated	2021	1 1/4" - 12"	-	12" - 24"	2" - 8"	3 HP, 220V	1 1/4" - 12"	■		41257	\$18,046.00
							2" - 12"	■		41258	\$17,550.00
							1 1/4" - 24"	■		41032	\$18,671.00
							2" - 24"	■		41259	\$18,671.00
2050	4" - 12"	4" - 30"	12" - 30"	-	5 HP, 220V	4" - 6"	■		41033	\$34,044.00	
2112	1" - 12"	-	-	2" - 8"	1/2 HP, 110V	1" - 12"	■		41210	POA	
Portable Cut Groover	1000	2" - 8"	-	-	-	1 HP, 115V	2" - 8"			41260	\$8,083.00
		2" - 12"	-	-	-		2" - 12"			41261	\$8,843.00

** Accessories not included, refer to Accessory Table Below.

Accessories

Item	Pace Model	Size Range	Capacity	Part No.	List Price
Pipe Stands	4031	1" - 4"	600 Lbs.	41037	\$412.00
	4000	2" - 8"	900 Lbs.	41038	\$509.00
	4033	2" - 14"	1,200 Lbs.	41039	\$638.00
	4040	12" - 24"	4,000 Lbs.	41040	\$1,618.00
Nipple Bracket	4037	Fits Model 1021 / 22 / 23 / 2021	-	41035	\$515.00
	4045	4" - 12" Fits Model 1012 / 1112	-	41512	\$428.00
Mounting Feet	4039	Fits Portable Roll Groovers and Model 1000	-	41034	\$130.00
	4046	PA Mounting Feet	-	41013	\$130.00
Porta-Bore	3013	Up to 4 1/4" Holes in Pipe 1 1/4" - 12"	-	41049	\$2,066.00

Section 16
Specialty Items

Section 18
Grooved Products

Section 19
CPVC Pipe & Fittings

Section 20
Miscellaneous

Section 21
Electrical

Section C
Valves & Hose Equipment

Section D
Backflow

Section F
Pipe & Accessories

Section H
Hangers

Section J
Lubricants

Section K
Misc.

Roll Selection Chart

Machine	Pipe	Size	Top		Size	Bottom		Parts	Part Number	List Price
			Part No.	List Price		Part No.	List Price			
1021, 1023, 2021	Sch. 40	1 ¹ / ₄ " - 1 ¹ / ₂ "	41262	\$288.00	1 ¹ / ₄ " - 1 ¹ / ₂ "	41281	\$209.00			
		2" - 3 ¹ / ₂ "	41263	\$251.00	2" - 3 ¹ / ₂ "	41282	\$194.00			
		4" - 6"	41264	\$224.00	4" - 6"	41283	\$294.00			
		8" - 12"	41265	\$224.00	8" - 12"	41284	\$350.00			
	Std. Wall	14" - 16"	41266	\$210.00	14" - 16"	41285	\$385.00			
		18" - 24"	41267	\$210.00	18" - 24"	41286	\$385.00			
Copper Tube	2" - 8"	41268	\$251.00	2" - 8"	41287	\$194.00	Depth Gauge 4043	41509	\$28.75	
1010, 2010	Sch. 10, Sch. 40	1 ¹ / ₂ " - 6"	41269	\$210.00	1 ¹ / ₂ "	41288	\$194.00			
			-	-	2" - 3 ¹ / ₂ "	41289	\$194.00			
			-	-	4" - 6"	41290	\$282.00			
	Sch. 10	8" - 12"	41270	\$210.00	8" - 12"	41291	\$282.00			
1040, 2040	Sch. 40	1" - 1 ¹ / ₂ "	41271	\$172.00	1" - 1 ¹ / ₂ "	41292	\$172.00			
		1" - 6"	41272	\$152.00	1" - 6"	41293	\$144.00			
		2" - 6"	41273	\$172.00	-	-				
	Sch. 10	8" - 12"	41274	\$152.00	8" - 12"	41294	\$238.00			
	Copper Tube	2" - 8"	41275	\$153.00	2" - 8"	41295	\$147.00	Depth Gauge 4021	41510	\$28.75
1012, 1112, 2112	Sch. 40	1" - 1 ¹ / ₂ "	41276	\$172.00	1" - 1 ¹ / ₂ "	41296	\$172.00			
		2" - 6"	41277	\$172.00	2" - 6"	41297	\$144.00			
		8" - 12"	41278	\$172.00	8" - 12"	41298	\$240.00			
	Copper Tube	2" - 8"	41506	\$172.00	2" - 8"	41507	\$147.00	Depth Gauge 4021	41510	\$28.75
1021, 1022, 1023, 2021	SS 10 Ga.				2" - 3 ¹ / ₂ "	41299	\$212.00			
					4" - 6"	41500	\$323.00			
					8" - 12"	41501	\$385.00			
					14" - 16"	41504	\$423.00			
					18" - 24"	41505	\$423.00			
1040, 1041, 1112, 2112	SS 10 Ga.				2" - 6"	41502	\$160.00			
					8" - 12"	41503	\$285.00			
1034, 1039	Sch. 40	1 ¹ / ₄ " - 6", w/ brg.	41279	\$39.00				1034 Drive Shaft 1 ¹ / ₄ " - 6"	41511	POA
								1039 Drive Shaft 1 ¹ / ₄ " - 6"	41513	POA
								Depth Gauge 4021	41510	\$28.75
1039	Copper Tube	2" - 8", w/ brg.	41280	\$52.00				Depth Gauge 4021	41510	\$28.75
1066	Copper Tube	2" - 8", w/ brg.	41508	\$52.00				Drive Shaft 2" - 8"	41514	POA
								Depth Gauge 4021	41510	\$28.75

See latest catalog or technical data sheets for specific approvals, listings, and design parameters.
POA = Price on availability. Prices subject to change without notice.

Domestic Grooved Couplings – Packaging Quantity
(Including Std. and Pre-Lubricated Gaskets)

Nom. Size	#577 Painted		#577 Galvanized & #577 Tri-Seal		#705 Painted		#705 Galvanized & Tri-Seal		#71 Flange Adapter		Size Range	#716 Reducing Coupling	
	Pieces / Carton	Pieces / Crate	Pieces / Carton	Pieces / Crate	Pieces / Carton	Pieces / Crate	Pieces / Carton	Pieces / Crate	Pieces / Carton	Pieces / Crate		Pieces / Carton	Pieces / Crate
1 1/4"	32	384	32	–	32	–	32	–	–	–	2" x 1 1/2"	20	–
1 1/2"	32	384	32	–	32	–	32	–	–	–	2 1/2" x 2"	36	–
2"	–	385	24	–	–	480	28	–	–	210	3" x 2"	12	–
2 1/2"	–	350	20	–	–	350	20	–	–	210	3" x 2 1/2"	9	–
3"	–	240	28	–	–	270	35	–	–	124	4" x 2"	6	–
4"	–	150	20	–	–	175	20	–	–	124	4" x 2 1/2"	6	–
5"	–	120	–	–	–	96	–	96	–	30	4" x 3"	6	–
6"	–	100	–	80	–	80	–	80	–	30	5" x 4"	–	80
8"	–	48	–	48	–	48	–	48	–	30	6" x 4"	–	64
10"	–	24	–	24	–	24	–	24	–	24	6" x 5"	–	64
12"	–	24	–	24	–	20	–	20	–	24	8" x 6"	–	36

Domestic Grooved Fittings – Packaging Quantity

Nom. Size	#510 90° Elbow		#501 45° Elbow		#519 Tee		#260 Cap		Nom. Size Range	ADACAP		#40-5 Strap	
	Pieces / Carton	Pieces / Crate	Pieces / Carton	Pieces / Crate	Pieces / Carton	Pieces / Crate	Pieces / Carton	Pieces / Crate		Pieces / Carton	Pieces / Crate	Pieces / Carton	Pieces / Crate
1 1/4"	40	–	45	–	28	–	287	–	1 1/4" x 1 1/2"	–	–	45	–
1 1/2"	27	–	39	–	28	–	210	–	1 1/4" x 3/4"	–	–	45	–
2"	18	–	24	–	24	–	140	–	1 1/4" x 1"	–	–	45	–
2 1/2"	8	–	15	–	10	–	84	–	1 1/2" x 1 1/2"	50	–	45	–
3"	12	–	18	–	12	–	56	–	1 1/2" x 3/4"	50	–	45	–
4"	–	168	–	96	–	46	30	–	1 1/2" x 1"	50	–	45	–
5"	–	105	–	140	–	75	–	392	2" x 1 1/2"	50	–	45	–
6"	–	63	–	90	–	48	–	288	2" x 3/4"	50	–	45	–
8"	–	28	–	48	–	24	–	160	2" x 1"	50	–	45	–
10"	–	15	–	–	–	–	–	96	2 1/2" x 1 1/2"	40	–	40	–
12"	–	8	–	–	–	–	–	63	2 1/2" x 3/4"	40	–	40	–
–	–	–	–	–	–	–	–	–	2 1/2" x 1"	40	–	40	–

Section 16
Specialty Items

Section 18
Grooved Products

Section 19
CPVC Pipe & Fittings

Section 20
Miscellaneous

Section 21
Electrical

Section C
Valves & Hose Equipment

Section D
Backflow

Section F
Pipe & Accessories

Section H
Hangers

Section J
Lubricants

Section K
Misc.

Section 16
Specialty Items

Section 18
Grooved Product

Section 19
CPVC Pipe & Fittings

Section 20
Miscellaneous

Section 21
Electrical

Section C
Valves & Hose Equipment

Section D
Backflow

Section F
Pipe & Accessories

Section H
Hangers

Section J
Lubricants

Section K
Misc.

Domestic Grooved Fittings – Packaging Quantity				
Nom. Size	#510S Short Pattern 90° Elbow	#519S Short Pattern Tee	Nom. Size Range	#550 Concentric Reducer
	Pieces/Carton	Pieces/Crate		Pieces/Carton
2"	18	30	2 1/2" x 1 1/4"	36
2 1/2"	8	20	2 1/2" x 1 1/2"	36
3"	12	12	2 1/2" x 2"	36
4"	210	46	3" x 1 1/2"	45
6"	78	48	3" x 2"	60
8"	28	24	3" x 2 1/2"	30
-	-	-	4" x 2"	243
-	-	-	4" x 2 1/2"	243
-	-	-	4" x 3"	243
-	-	-	5" x 3"	147
-	-	-	5" x 4"	147
-	-	-	6" x 2"	72
-	-	-	6" x 2 1/2"	72
-	-	-	6" x 3"	72
-	-	-	6" x 4"	216
-	-	-	6" x 5"	216
-	-	-	8" x 3"	80
-	-	-	8" x 4"	80
-	-	-	8" x 5"	1
-	-	-	8" x 6"	1

Grooved Fittings – Pieces Per Carton/Case			
Nom Size	#730 Mechanical Tee	Nom Size	#730 Mechanical Tee (cont.)
2" x 1 1/2"	15	4" x 1 1/2"	12
2" x 3/4"	15	4" x 3/4"	12
2" x 1"	15	4" x 1 1/2"	12
2" x 1 1/4"	26	4" x 1 1/4"	12
2" x 1 1/2"	12	4" x 1 1/2"	12
2 1/2" x 1 1/2"	14	4" x 2"	10
2 1/2" x 3/4"	14	4" x 2 1/2"	10
2 1/2" x 1"	14	4" x 3"	8
2 1/2" x 1 1/4"	32	5" x 2"	8
2 1/2" x 1 1/2"	20	5" x 2 1/2"	8
3" x 1 1/2"	16	6" x 1 1/2"	8
3" x 3/4"	16	6" x 2"	7
3" x 1"	16	6" x 2 1/2"	7
3" x 1 1/4"	18	6" x 3"	6
3" x 1 1/2"	16	6" x 4"	6
3" x 2"	12	8" x 2 1/2"	4
-	-	8" x 3"	4
-	-	8" x 4"	4

See latest catalog or technical data sheets for specific approvals, listings, and design parameters.
POA = Price on availability. Prices subject to change without notice.

Global Grooved Couplings – Packaging Quantity

Nom. Size	#577				#705			
	Pieces / Carton	Cartons / Pallet	Pieces / Pallet	Crate Qty	Pieces / Carton	Pieces / Crate	Pieces / Carton	Pieces / Crate
1 1/4"	26	48	1,248	–	24	48	1,152	–
1 1/2"	32	12	–	384	20	48	960	–
2"	20	48	960	–	16	48	768	–
2 1/2"	16	48	768	–	12	48	576	–
3"	–	–	–	819	–	–	–	520
4"	–	–	–	546	–	–	–	324
5"	–	–	–	120	–	–	–	–
6"	–	–	–	100	–	–	–	165
8"	–	–	–	108	–	–	–	80
10"	–	–	–	24	–	–	–	–
12"	–	–	–	24	–	–	–	–

Global Grooved Fittings – Packaging Quantity

Nom. Size	#510 90° Elbow				#501 45° Elbow				#519 Tee				#260 Cap			
	Pieces / Carton	Cartons / Pallet	Pieces / Pallet	Crate Qty	Pieces / Carton	Cartons / Pallet	Pieces / Pallet	Crate Qty	Pieces / Carton	Cartons / Pallet	Pieces / Pallet	Crate Qty	Pieces / Carton	Cartons / Pallet	Pieces / Pallet	Crate Qty
1 1/4"	28	48	1,344	–	54	48	2,592	–	22	48	1,056	–	132	48	6,336	–
1 1/2"	24	48	1,152	–	40	48	1,920	–	18	48	864	–	100	48	4,800	–
2"	13	48	624	–	18	48	864	–	12	48	576	–	64	48	3,072	–
2 1/2"	6	48	288	–	12	48	576	–	4	48	192	–	42	48	2,016	–
3"	4	48	192	–	8	48	384	–	3	48	144	–	24	48	1,152	–
4"	–	–	–	195	–	–	–	315	–	–	–	120	12	48	576	–
6"	–	–	–	68	–	–	–	100	–	–	–	42	3	48	144	–
8"	–	–	–	32	–	–	–	44	–	–	–	18	3	48	144	–
10"	–	–	–	16	–	–	–	18	–	–	–	10	–	–	–	–
12"	–	–	–	8	–	–	–	15	–	–	–	–	–	–	–	–

Global Grooved Fittings – Packaging Quantity

Nom. Size	#510S Short Pattern 90° Elbow				#501 45° Elbow				#519S Short Pattern Tee			
	Pieces / Carton	Cartons / Pallet	Pieces / Pallet	Crate Qty	Pieces / Carton	Cartons / Pallet	Pieces / Pallet	Crate Qty	Pieces / Carton	Cartons / Pallet	Pieces / Pallet	Crate Qty
2"	15	48	720	–	12	48	576	–	33	48	1,584	–
2 1/2"	10	48	480	–	6	48	288	–	30	48	1,440	–
3"	8	48	288	–	4	48	192	–	24	48	1,152	–
4"	–	–	–	234	–	–	–	150	10	48	480	–
6"	–	–	–	72	–	–	–	56	3	48	144	–
8"	–	–	–	33	–	–	–	21	2	48	96	–

Section 16
Specialty Items

Section 18
Grooved Products

Section 19
CPVC Pipe & Fittings

Section 20
Miscellaneous

Section 21
Electrical

Section C
Valves & Hose Equipment

Section D
Backflow

Section F
Pipe & Accessories

Section H
Hangers

Section J
Lubricants

Section K
Misc.

Section 16 Specialty Items
Section 18 Grooved Product
Section 19 CPVC Pipe & Fittings
Section 20 Miscellaneous
Section 21 Electrical
Section C Valves & Hose Equipment
Section D Backflow
Section F Pipe & Accessories
Section H Hangers
Section J Lubricants
Section K Misc.

See latest catalog or technical data sheets for specific approvals, listings, and design parameters.
POA = Price on availability. Prices subject to change without notice.

Customer Service: (800) 558-5236
www.tyco-fire.com & www.grinnell.com

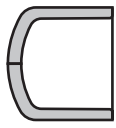
Cap (Slip)				
	box/bag	size	part no.	list price
	225/25	3/4"	80100	\$5.10
	300/20	1"	80101	\$6.45
	60/10	1 1/4"	80102	\$13.90
	30/10	1 1/2"	80103	\$19.00
	20/5	2"	80104	\$23.55
	10/5	2 1/2"	80105	\$64.20
	8/4	3"	80106	\$82.40

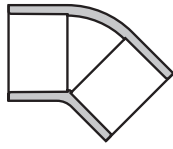
45° Elbow (Slip x Slip)				
	box/bag	size	part no.	list price
	100/25	3/4"	80050	\$10.55
	180/20	1"	80051	\$15.00
	90/15	1 1/4"	80052	\$18.45
	56/7	1 1/2"	80053	\$25.40
	28/4	2"	80054	\$90.40
		2 1/2"	90055	\$93.10
		3"	90056	\$120.90

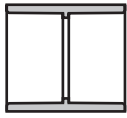
Coupling (Slip x Slip)				
	box/bag	size	part no.	list price
	300/25	3/4"	80075	\$7.60
	160/20	1"	80076	\$9.85
	150/10	1 1/4"	80077	\$14.70
	70/10	1 1/2"	80078	\$20.85
	40/5	2"	80079	\$34.25
	24/4	2 1/2"	80080	\$70.10
	14/2	3"	80081	\$73.85

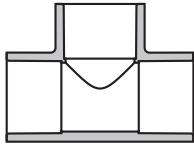
Tee (Slip x Slip x Slip)				
	box/bag	size	part no.	list price
	180/20	3/4"	80000	\$10.95
	100/10	1"	80001	\$21.40
	55/5	1 1/4"	80002	\$33.70
	30/5	1 1/2"	80003	\$46.55
	18/3	2"	80004	\$69.00
	12/na	2 1/2"	80005	\$128.95
	8/na	3"	80006	\$156.20

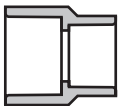
Reducing Coupling (Slip x Slip)				
	box/bag	size	part no.	list price
	280/20	1" x 3/4"	80220	\$32.10

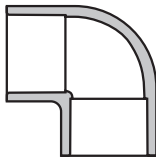
90° Elbow and Reducing Elbow (Slip x Slip)				
	box/bag	size	part no.	list price
	250/25	3/4"	80025	\$7.80
	140/20	1"	80026	\$17.65
	90/10	1 1/4"	80027	\$22.20
	45/5	1 1/2"	80028	\$31.05
	24/4	2"	80029	\$45.20
	15/3	2 1/2"	80030	\$113.40
	9/na	3"	80031	\$133.20
	40/20	1" x 3/4"	80032	\$19.25

Section 16
Specialty Items

Section 18
Grooved Product

Section 19
CPVC Pipe & Fittings

Section 20
Miscellaneous

Section 21
Electrical

Section C
Valves & Hose Equipment

Section D
Backflow

Section F
Pipe & Accessories

Section H
Hangers

Section J
Lubricants

Section K
Misc.

Refer to IH-1900 for installation instructions for all CPVC products.

Items shown on this sheet may not be stocked at all Tyco Fire Protection Products warehouses. Ask your local TFP representative for availability. Freight terms may vary for non commonly stocked items. Refer to latest Technical Data Sheets for specific Approvals and Listings, design parameters and available finishes. Prices subject to change without notice.

Section 16
Specialty Items

Section 18
Grooved Product

Section 19
CPVC Pipe & Fittings

Section 20
Miscellaneous

Section 21
Electrical

Section C
Valves & Hose Equipment

Section D
Backflow

Section F
Pipe & Accessories

Section H
Hangers

Section J
Lubricants

Section K
Misc.

Reducing Tee (Slip x Slip x Slip)				
box/bag	size	part no.	list price	
40/10	3/4" x 3/4" x 1"	80132	\$18.20	
40/10	1 x 3/4" x 3/4"	80133	\$18.20	
30/10	1 x 3/4" x 1"	80134	\$18.20	
110/10	1" x 1" x 3/4"	80260	\$20.85	
24/8	1 1/4" x 1" x 3/4"	80135	\$33.15	
80/10	1 1/4" x 1" x 1"	80136	\$33.15	
64/8	1 1/4" x 1" x 1 1/4"	80137	\$33.15	
75/5	1 1/4" x 1 1/4" x 3/4"	80261	\$33.15	
60/10	1 1/4" x 1 1/4" x 1"	80262	\$33.15	
12/6	1 1/4" x 1 1/4" x 1 1/2"	80138	\$40.15	
49/7	1 1/2" x 1 1/2" x 3/4"	80263	\$51.35	
45/5	1 1/2" x 1 1/2" x 1"	80264	\$40.15	
30/6	1 1/2" x 1 1/2" x 1 1/4"	80275	\$40.15	
14/7	1 1/2" x 1 1/4" x 3/4"	80140	\$40.15	
42/7	1 1/2" x 1 1/4" x 1"	80141	\$40.15	
24/3	2" x 2" x 3/4"	80265	\$63.40	
24/3	2" x 2" x 1"	80266	\$63.40	
24/3	2" x 2" x 1 1/4"	80274	\$63.40	
21/3	2" x 2" x 1 1/2"	80267	\$63.40	
13/na	2 1/2" x 2 1/2" x 1"	80271	\$123.05	
13/na	2 1/2" x 2 1/2" x 1 1/4"	80272	\$123.05	
13/na	2 1/2" x 2 1/2" x 1 1/2"	80273	\$123.05	
13/na	2 1/2" x 2 1/2" x 2"	80276	\$123.05	
8/na	3" x 3" x 1 1/2"	80270	\$148.75	
8/na	3" x 3" x 2"	80268	\$136.95	
8/na	3" x 3" x 2 1/2"	80269	\$136.95	

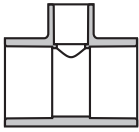

Cross (Slip x Slip x Slip x Slip)				
box/bag	size	part no.	list price	
40/10	3/4"	80009	\$22.75	
70/10	1"	80010	\$27.80	
40/4	1 1/4"	80011	\$35.30	
20/4	1 1/2"	80012	\$59.90	
12/3	2"	80013	\$73.55	
8/na	2 1/2"	80014	\$142.30	
70/10	1" x 1" x 3/4" x 3/4"	80015	\$30.75	

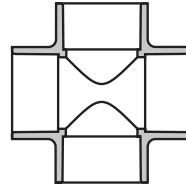

Reducer Bushing (Slip x Slip)				
box/bag	size	part no.	list price	
150/25	1" x 3/4"	80200	\$5.95	
80/10	1 1/4" x 3/4"	80201	\$10.95	
200/20	1 1/4" x 1"	80202	\$11.75	
50/10	1 1/2" x 3/4"	80203	\$16.30	
200/20	1 1/2" x 1"	80204	\$10.55	
60/10	1 1/2" x 1 1/4"	80205	\$10.55	
30/10	2" x 3/4"	80206	\$27.30	
100/10	2" x 1"	80207	\$37.20	
100/10	2" x 1 1/4"	80208	\$42.80	
30/10	2" x 1 1/2"	80209	\$29.70	
16/4	2 1/2" x 1"	80215	\$62.05	
20/5	2 1/2" x 1 1/4"	80214	\$53.75	
15/5	2 1/2" x 1 1/2"	80213	\$66.90	
20/5	2 1/2" x 2"	80211	\$40.95	
36/4	3" x 2"	80210	\$78.65	
12/6	3" x 2 1/2"	80212	\$58.60	

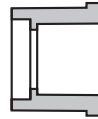

Refer to IH-1900 for installation instructions for all CPVC products.

Items shown on this sheet may not be stocked at all Tyco Fire Protection Products warehouses. Ask your local TFP representative for availability. Freight terms may vary for non commonly stocked items. Refer to latest Technical Data Sheets for specific Approvals and Listings, design parameters and available finishes. Prices subject to change without notice.

Supersedes 1/20/2012

Female Sprinkler Head Adapter (Slip x FIPT) with Brass Threaded Insert				
	box/bag	size	part no.	list price
East	80/16	3/4" x 1/2" EAST	80175E	\$19.50
	80/16	3/4" x 1/2" WEST	80175W	\$19.50
	96/16	3/4" x 1/2" WEST LITE	80175WL	\$19.50
West	64/16	1" x 1/2" EAST	80176E	\$20.50
	80/16	1" x 1/2" WEST	80176W	\$20.50
	40/8	1" x 3/4"	80179	\$43.50

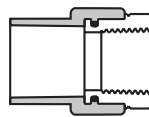
Spigot Sprinkler Head Adapter (Slip x FIPT) with Brass Threaded Insert				
	box/bag	size	part no.	list price
	112/16	3/4" x 1/2" LITE	80177L	\$18.75
	80/16	1" x 1/2"	80178	\$18.75
	56/8	1" x 3/4"	80180	\$42.75

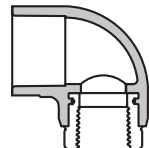
Sprinkler Head 90° Elbow (Slip x FIPT) with Brass Threaded Insert				
	box/bag	size	part no.	list price
	80/10	3/4" x 1/2"	80199	\$20.25
	50/10	1" x 1/2"	80198	\$27.00
	25/5	1" x 3/4"	80196	\$65.75

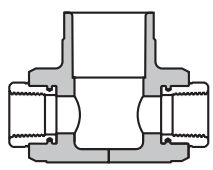
Back-to-Back Tee, Sprinkler Head Adapter (FIPT x FIPT x Slip) with Brass Threaded Inserts				
	box/bag	size	part no.	list price
	30/6	Back-to-back, Tee, 1/2" x 1/2" x 1" 3-3/8" Takeout	80460	\$82.75
	30/6	Back-to-back, Tee, 1/2" x 1/2" x 1" 3-5/8" Takeout	80459	\$82.75

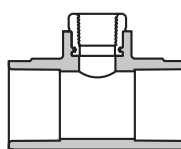
Sprinkler Head Tee (Slip x Female) with Brass Threaded Insert				
	box/bag	size	part no.	list price
	60/10	3/4" x 3/4" x 1/2"	80250	\$27.25
	30/10	1" x 1" x 1/2"	80251	\$36.00
	28/7	1 1/4" x 1 1/4" x 1/2"	80252	\$45.25
	28/7	1 1/4" x 1" x 1/2"	80256	\$46.00
	21/3	1" x 1" x 1"	80249	\$92.00
	24/3	1" x 1" x 1" - Used for Dry Sprinklers	80259	\$83.75
	15/5	1 1/2" x 1 1/4" x 1/2"	80257	\$60.50
	15/5	1 1/2" x 1 1/2" x 1/2"	80254	\$60.50
	12/4	2" x 1 1/2" x 1/2"	80258	\$82.50
	8/4	2" x 2" x 1/2"	80253	\$82.50

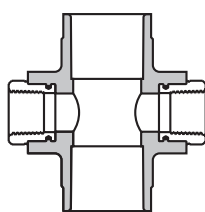
Back-to-Back Cross Sprinkler Head Adapter (Slip x FIPT) with Brass Threaded Inserts				
	box/bag	size	part no.	list price
	20/5	Back-to-back, Cross, 1" Slip x 1/2" FIPT 3-3/8" Takeout	80462	\$82.75
	20/5	Back-to-back, Cross, 1" Slip x 1/2" FIPT 3-5/8" Takeout	80463	\$82.75

Section 16
Specialty Items

Section 18
Grooved Product

Section 19
CPVC Pipe & Fittings

Section 20
Miscellaneous

Section 21
Electrical

Section C
Valves & Hose Equipment

Section D
Backflow

Section F
Pipe & Accessories

Section H
Hangers

Section J
Lubricants

Section K
Misc.

Refer to IH-1900 for installation instructions for all CPVC products.

Items shown on this sheet may not be stocked at all Tyco Fire Protection Products warehouses. Ask your local TFP representative for availability. Freight terms may vary for non commonly stocked items. Refer to latest Technical Data Sheets for specific Approvals and Listings, design parameters and available finishes. Prices subject to change without notice.

Section 16
Specialty Items

Section 18
Grooved Product

Section 19
CPVC Pipe & Fittings

Section 20
Miscellaneous

Section 21
Electrical

Section C
Valves & Hose Equipment

Section D
Backflow

Section F
Pipe & Accessories

Section H
Hangers

Section J
Lubricants

Section K
Misc.

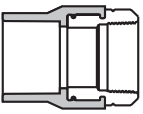
CPVC to Female Adapter (slip x female) with Brass Threaded Insert				
	<i>box/bag</i>	<i>size</i>	<i>part no.</i>	<i>list price</i>
	64/8	3/4"	80142	\$46.25
	30/6	1"	80145	\$70.50
	21/3	1 1/4"	80146	\$112.00
	18/3	1 1/2"	80147	\$145.00
	10/2	2"	80148	POA

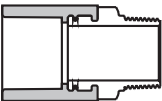
Male Adapter (Slip x Male) with Brass Threaded Insert				
	<i>box/bag</i>	<i>size</i>	<i>part no.</i>	<i>list price</i>
	80/10	3/4"	80157	\$46.00
	40/10	1"	80158	\$54.50

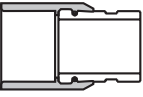
Grooved Coupling Adapter (Groove x Slip)				
	<i>box/bag</i>	<i>size</i>	<i>part no.</i>	<i>list price</i>
	28/4	1 1/4"	80160	\$132.50
	24/3	1 1/2"	80161	\$170.50
	15/3	2"	80162	\$205.50
	9/n/a	2 1/2"	80163	POA
	5/n/a	3"	80164	POA

Refer to IH-1900 for installation instructions for all CPVC products.

Items shown on this sheet may not be stocked at all Tyco Fire Protection Products warehouses. Ask your local TFP representative for availability. Freight terms may vary for non commonly stocked items. Refer to latest Technical Data Sheets for specific Approvals and Listings, design parameters and available finishes. Prices subject to change without notice.

Supersedes 1/20/2012

CPVC Pipe						
<i>ft./bundle</i>	<i>size</i>	<i>part no.</i>	<i>length</i>	<i>lift qty. (ft.)</i>	<i>lift wt. (lbs.)</i>	<i>list price/ft.</i>
375	3/4"	80300	15'	7875	1418	\$2.35
250	3/4"	80300T	10'*	5250	945	\$2.35
200	3/4"	80307	8'*	4200	756	\$2.35
240	1"	80301	15'	5040	1320	\$3.65
160	1"	80301T	10'*	3360	880	\$3.65
128	1"	80308	8'*	2688	705	\$3.65
135	1 1/4"	80302	15'	2835	1191	\$5.60
90	1 1/4"	80302T	10'*	1890	794	\$5.60
105	1 1/2"	80303	15'	2205	1186	\$7.80
70	1 1/2"	80303T	10'*	1470	791	\$7.80
60	2"	80304	15'	1260	1063	\$11.50
40	2"	80304T	10'*	840	709	\$11.50
45	2 1/2"	80305	15'	1215	1531	\$17.90
30	2 1/2"	80305T	10' *	810	1020	\$17.90
30	3"	80306	15'	720	1344	\$27.30
20	3"	80306T	10' *	480	896	\$27.30
Technical Data Sheet - TFP1915						

Section 16	Specialty Items
Section 18	Grooved Product
Section 19	CPVC Pipe & Fittings
Section 20	Miscellaneous
Section 21	Electrical
Section C	Valves & Hose Equipment
Section D	Backflow
Section F	Pipe & Accessories
Section H	Hangers
Section J	Lubricants
Section K	Misc.

Refer to IH-1900 for installation instructions for all CPVC products.

Items shown on this sheet may not be stocked at all Tyco Fire Protection Products warehouses. Ask your local TFP representative for availability. Freight terms may vary for non commonly stocked items. Refer to latest Technical Data Sheets for specific Approvals and Listings, design parameters and available finishes. Prices subject to change without notice.

Section 16
Specialty Items

Section 18
Grooved Product

Section 19
CPVC Pipe & Fittings

Section 20
Miscellaneous

Section 21
Electrical

Section C
Valves & Hose Equipment

Section D
Backflow

Section F
Pipe & Accessories

Section H
Hangers

Section J
Lubricants

Section K
Misc.

Primers & Cements		
<i>description</i>	<i>part no.</i>	<i>list price</i>
TFP-500 Cement Pt. (one-step)	90740	\$30.00
TFP-500 Cement Pt. (one-step) - Canada	90744C	\$30.00
TFP-500 Cement Qt. (one-step)	90741	\$50.00
TFP-500 Cement Qt. (one-step) - Canada	90743	\$50.00

Accessories		
<i>description</i>	<i>part no.</i>	<i>list price</i>
CPVC Dauber ³ / ₄ "	90401	\$1.85
CPVC Dauber 1 ¹ / ₂ "	90400	\$1.65

Fire Stop		
<i>description</i>	<i>part no.</i>	<i>list price</i>
BlazeMaster™ Caulk & Walk (10.5 oz. tube)	61126	\$37.00

Rothenberger Tools			
<i>description</i>	<i>size</i>	<i>part no.</i>	<i>list price</i>
Plastic Wheel Cutter	¹ / ₄ " - 2 ⁵ / ₈ "	52040	\$255.50
Plastic Wheel Cutter	2" - 5"	52041	\$403.00
Replacement Cutter Wheel	¹ / ₂ " - 2 ⁵ / ₈ "	52042	\$62.75
Ratchet Hand Cutter	¹ / ₂ " - 2"	52045	\$531.00
Replacement Blade	¹ / ₂ " - 2"	52047	\$130.00

Tyco Fire Products CPVC Tools		
<i>description</i>	<i>part no.</i>	<i>list price</i>
Sprinkler Head Adapter Hold-Back Wrench (with two additional chains)	3002	\$198.00
Chain Kit for SHA Hold-Back Wrench (5 chains in Kit)	3011	\$90.25

McNulty Tools		
<i>description</i>	<i>part no.</i>	<i>list price</i>
CPVC Retrofit Pipe Cutting Tool	2667	\$828.50
CPVC Retrofit Deburring Tool	2665	\$314.50
CPVC Retrofit Deburring Tool	2666	\$320.50
CPVC Retrofit Cutting Head	19071100	\$342.00

Reed Tool Manufacturing		
<i>description</i>	<i>part no.</i>	<i>list price</i>
CPVC Tube Cutter, Up to 2" - Model #TC2QPVC	90355	\$293.50
Replacement Blades for CPVC Tube Cutter #TC2QPVC - Model #04184	90356	\$36.00
Deburring Tool, Up to 4" - Model #DEB4	90357	\$192.50
Deburring Tool, Up to 2" - Model #DEB2	91346	\$61.50

Refer to IH-1900 for installation instructions for all CPVC products.

Items shown on this sheet may not be stocked at all Tyco Fire Protection Products warehouses. Ask your local TFP representative for availability. Freight terms may vary for non commonly stocked items. Refer to latest Technical Data Sheets for specific Approvals and Listings, design parameters and available finishes. Prices subject to change without notice.

Supersedes 1/20/2012

Discontinued Valve Replacement Parts

The following repair parts are applicable to items that have been discontinued and are no longer available. Although the parts are shown in this catalog, TFPP does not guarantee the availability of the items. The parts shown in this section will be sold as long as they are available. TFPP does not have any plans to continue the production of these discontinued parts.

Note: All Items Are Non-Returnable

Central - 4" Dry Pipe Valve Model "AF" or "AG" (2002)

<i>Description</i>	<i>Part No.</i>	<i>List Price (each)</i>
Valve Cover	40002000	\$598.50
Cover Bolts (Purchase 6 Units Each)	60003000	\$16.50
Cover Gasket	40004000	\$147.50
Clapper Assembly	40018600	\$2,197.00
Clapper	40018200	\$1,016.50
Clapper Bushings (Purchase 2 Units Each)	80100800	\$40.75
Clapper Gasket	97602401	\$236.00
Latch	30010000	\$264.50
Latch Spring	30021000	\$46.50
Latch Pin	30023000	\$54.75
Retaining Rings (Purchase 2 Units Each)	30022000	\$40.75
Hex Head Clapper Bolts (Purchase 5 Units Each)	60080000	\$99.00
Hinge Pin	80101020	\$90.25
Clapper Bushings (Purchase 2 Units Each)	81808000	\$40.75
Retaining Plate	97602501	\$183.00

Central - 6" Dry Pipe Valves Model "AF" or "AG" (2002)

<i>Description</i>	<i>Part No.</i>	<i>List Price (each)</i>
Valve Cover	60002000	\$658.50
Cover Bolts (Purchase 8 Units Each)	60003000	\$16.50
Cover Gasket	60004000	\$147.50
Clapper	60018200	\$1,194.00
Clapper Bushings (Purchase 2 Units Each)	80100800	\$40.75
Clapper Gasket	60018000	\$257.00
Latch	30010000	\$264.50
Latch Spring	30021000	\$46.50
Latch Pin	30023000	\$54.75
Retaining Rings (Purchase 2 Units Each)	30022000	\$40.75
Hex Head Clapper Bolts (Purchase 6 Units Each)	60080000	\$99.00
Hinge Pin	80101010	\$90.25
Retaining Plate	60018100	\$329.50

Central - 4" Dry Pipe Valve, Model "H & K" (1988)

<i>Description</i>	<i>Part No.</i>	<i>List Price</i>
Clapper Gasket	40058000	\$270.00
Cover Gasket	40004000	\$147.50

Central - 6" Dry Pipe Valve, Model "H & K" (1988)

<i>Description</i>	<i>Part No.</i>	<i>List Price</i>
Clapper Gasket	60058000	\$270.00
Cover Gasket	60004000	\$147.50

Section 16
Specialty Items

Section 18
Grooved Product

Section 19
CPVC Pipe & Fittings

Section 20
Miscellaneous

Section 21
Electrical

Section C
Valves & Hose Equipment

Section D
Backflow

Section F
Pipe & Accessories

Section H
Hangers

Section J
Lubricants

Section K
Misc.

See latest Technical Data Sheets for specific Approvals, Listings, Design Parameters & available finishes.

Section 16
Specialty Items

Section 18
Grooved Product

Section 19
CPVC Pipe & Fittings

Section 20
Miscellaneous

Section 21
Electrical

Section C
Valves & Hose Equipment

Section D
Backflow

Section F
Pipe & Accessories

Section H
Hangers

Section J
Lubricants

Section K
Misc.

Discontinued Valve Replacement Parts

The following repair parts are applicable to items that have been discontinued and are no longer available. Although the parts are shown in this catalog, TFPP does not guarantee the availability of the items. The parts shown in this section will be sold as long as they are available. TFPP does not have any plans to continue the production of these discontinued parts.

Note: All Items Are Non-Returnable

Central - 2" & 2¹/₂" Dry Pipe Valve, Model "D" (1988)

Description	Part No.	List Price
Clapper Gasket	25058000	\$270.00
Cover Gasket	25004000	\$116.00

Central - 3" Dry Pipe Valve, Model "D" (1988)

Description	Part No.	List Price
Clapper Gasket	30058000	\$270.00
Cover Gasket	30004000	\$116.00

Central - 4" Dry Pipe Valve, Model "D" (1988)

Description	Part No.	List Price
Clapper Gasket	40058000	\$270.00
Cover Gasket	40004000	\$147.50

Central - 4" Deluge Valve Model "A" (2001)

Description	Part No.	List Price
Diaphragm	82401500	\$87.75
Clapper Seal	82402600	\$94.00
Cover Gasket	82400300	\$46.50
Clapper Pin	82402700	\$42.50
Nose Pin	82401200	\$40.00
Clapper Spring	82602400	\$30.50
Lever Spring	82403100	\$28.75
Cap Screw	81611000	\$27.75
Diaphragm Cover	82401600	\$231.50
Diaphragm Piston	82401400	\$217.50
Water Restrictor	82403300	\$667.50

Central - 6" Deluge Valve Model "A" (2001)

Description	Part No.	List Price
Diaphragm	82601200	\$90.25
Clapper Seal	82601500	\$94.00
Cover Gasket	82600300	\$46.50
Nose Pin	82600900	\$42.50
Clapper Spring	82602400	\$30.50
Cap Screw	81611000	\$27.75
Diaphragm Cover	82601300	\$231.50
Retaining Ring	82602500	\$135.50
Clapper	82600700	\$985.50
Diaphragm Piston	82601100	\$217.50

See latest Technical Data Sheets for specific Approvals, Listings, Design Parameters & available finishes.

Discontinued Valve Replacement Parts

The following repair parts are applicable to items that have been discontinued and are no longer available. Although the parts are shown in this catalog, TFPP does not guarantee the availability of the items. The parts shown in this section will be sold as long as they are available. TFPP does not have any plans to continue the production of these discontinued parts.

Note: All Items Are Non-Returnable

Model DV-3 Deluge Valve (2007)

Description	Part No.	List Price
Replacement Parts for Model DV-3		
Repair Parts Kit Includes: 1-Diaphragm & 1-Facing	92-445-1-020	\$127.00
Center Valve Assembly Includes: 1-Diaphragm, 1-Diaphragm Ring, 4-Hex Cap Screws, 1-Center Valve, 1-Facing, 1-Facing Retainer & 1-Retainer Screw	92-445-1-021	\$1,462.00
Technical Data Sheet - TFP1350		

Central - Model F & G Alarm Valve (2003)

Description	Flanged x Flanged	List Price (each)
Replacement Parts for Model "F" & "G" 2 1/2" and 3" Alarm Valves		
Cover Gasket	81303000	\$46.50
Hinge Pin	81610200	\$90.25
Clapper Assembly	81304001	\$688.00
Clapper	81304000	\$451.00
Clapper Bushings (Purchase 2 Units Each)	81608000	\$35.50
Clapper Gasket	81305000	\$219.00
Inner Retaining Washer	25059000	\$67.00
Replacement Parts for Model "F" & "G" 6" Alarm Valves		
Description	Flanged x Flanged	List Price (each)
Valve Cover	81602000	\$346.00
Cover Gasket	81603000	\$46.50
Clapper Assembly	81604001	\$1,045.50
Clapper	81604000	\$688.00
Clapper Bushings (Purchase 2 Units Each)	81608000	\$35.50
Clapper Gasket	81605000	\$191.50
Retaining Ring	81606000	\$152.00
Hex Head Cap Screw	81611000	\$27.75
Replacement Parts for Model "F" & "G" 8" Alarm Valves		
Cover Gasket	81803000	\$46.50
Clapper	81804000	\$851.50
Clapper Bushings (Purchase 2 Units Each)	81808000	\$40.75
Clapper Gasket	81805000	\$191.50
Retaining Ring	81806000	\$152.00
Hex Head Cap Screws (Purchase 5 Units Each)	81811000	\$123.00
Technical Data Sheet: Central 7-2.0 (2 1/2", 3"), Central 7-3.0 (4", 6", 8")		

See latest Technical Data Sheets for specific Approvals, Listings, Design Parameters & available finishes.

Section 16
Specialty Items

Section 18
Grooved Product

Section 19
CPVC Pipe & Fittings

Section 20
Miscellaneous

Section 21
Electrical

Section C
Valves & Hose Equipment

Section D
Backflow

Section F
Pipe & Accessories

Section H
Hangers

Section J
Lubricants

Section K
Misc.

Discontinued Valve Replacement Parts

The following repair parts are applicable to items that have been discontinued and are no longer available. Although the parts are shown in this catalog, TFPP does not guarantee the availability of the items. The parts shown in this section will be sold as long as they are available. TFPP does not have any plans to continue the production of these discontinued parts.

Note: All Items Are Non-Returnable

Model "AF" 2", 2 1/2" and 3" Dry Pipe Valves/Trim (2007)

Part Number	Size/Model	List Price
Replacement Parts for Model "AF" Dry Pipe Valve		
30004000	Cover Gasket	\$116.00
30018600	3" Clapper Assembly Replacement Kit Including: Clapper, Clapper Bushings (4 Units), Rubber Seal, Retaining Plate, Hex Head Clapper Bolts (5 Units), Latch, Latch Pin, Retaining Rings (2 Units), Latch Spring	\$2,152.00
Technical Data Sheet - Central 10-2.0 (2", 2 1/2"), Central 10-3.2 (3")		

Gem - Model F-302 & F-3021, 4" Dry Pipe Valve Replacement Parts (2002)

Description	Part Number	List Price
Auxiliary Clapper Assembly	52-302-1-103	\$835.50
Repair Parts Kit, Including: Clapper Facing, O-Ring #016, O-Ring #111, Auxiliary Clapper Facing, Auxiliary Clapper Spring, Auxiliary Clapper, Chamber Gasket, Handhole Cover Gasket, 1.5 gms of FS3452	92-302-1-416	\$411.00

Gem - Model F-302 & F-3021, 6" Dry Pipe Valve Replacement Parts (2002)

Description	Part Number	List Price
Auxiliary Clapper Assembly	52-302-1-103	\$835.50
Repair Parts Kit, Including Clapper Facing, O-Ring #016, O-Ring #111, Auxiliary Clapper Facing, Auxiliary Clapper Spring, Auxiliary Clapper Chamber Gasket, Handhole Cover Gasket, 1.5 gms of FS3452	92-302-1-617	\$439.00

Gem - Model A-2, 2" Dry Pipe Valve Replacement Parts (1999)

Description	Part Number	List Price
2" Center Valve Assembly	92-414-1-218	\$2,870.00
Cover O-Ring and Diaphragm Kit	92-414-1-216	\$147.50

See latest Technical Data Sheets for specific Approvals, Listings, Design Parameters & available finishes.

Section 16
Specialty Items

Section 18
Grooved Product

Section 19
CPVC Pipe & Fittings

Section 20
Miscellaneous

Section 21
Electrical

Section C
Valves & Hose Equipment

Section D
Backflow

Section F
Pipe & Accessories

Section H
Hangers

Section J
Lubricants

Section K
Misc.

Discontinued Valve Replacement Parts

The following repair parts are applicable to items that have been discontinued and are no longer available. Although the parts are shown in this catalog, TFPP does not guarantee the availability of the items. The parts shown in this section will be sold as long as they are available. TFPP does not have any plans to continue the production of these discontinued parts.

Note: All Items Are Non-Returnable

Model B Deluge Valve (2004)

Description	Part No.	List Price
Replacement Parts for Model "B" Deluge Valve		
Cover	92-020-1-002	\$1,229.00
Center Valve Assembly	92-020-1-014	\$1,458.00
Guide Rod	92-020-1-005	\$175.50
Priming Supply Res. 1/2" w/.125	92-020-1-009	\$228.00
Repair Parts Kit Includes: 1-Body Gasket, 1-Diaphragm & 1-Facing	92-020-1-116	\$186.00
Technical Data Sheet - Gem TD 117A		

Model DV-1 Deluge Valves (2007)

Description	Part No.	List Price
Replacement Part Kits for the 4" Model DV-1 Deluge Valve		
(a) Repair Parts Kit Includes: 1-Clapper Facing, 1-Diaphragm, 1-Handhole Cover Gasket	92-470-1-101	\$123.00
(b) Clapper Assembly Includes: 1-Clapper, 1-Clapper Facing, 1-Clapper Facing Retainer, 1-Clapper Hex Bolt, 1-Clapper Hinge Pin	92-470-1-103	\$742.50
(c) Reset Plunger Parts Includes: 1-Reset Bushing O-Ring, 1-Reset Bushing, 1-Reset Plunger O-Ring, 1-Reset Plunger, 1-Reset Knob & 1.5 grams Dow Corning FS3452 Fluorosilicone Grease	92-470-1-105	\$210.50
(d) Diaphragm & Latch Parts Kit Includes: 1-Clapper Latch, 1-Diaphragm Housing Hex Bolt, 1-Diaphragm Retainer, 1-Flange/Push Rod Assembly, 1-Diaphragm, 1-Diaphragm Housing & 1-Latch Hinge Pin	92-470-1-106	\$1,472.00
Replacement Part Kits for the 6" Model DV-1 Deluge Valve		
(a) Repair Parts Kit Includes: 1-Clapper Facing, 1-Diaphragm, 1-Handhole Cover Gasket	92-470-1-102	\$132.50
(b) Clapper Assembly Includes: 1-Clapper, 1-Clapper Facing, 1-Clapper Facing Retainer, 1-Clapper Hex Bolt, 1-Clapper Hinge Pin	92-470-1-104	\$823.50
(c) Reset Plunger Parts Includes: 1-Reset Bushing O-Ring, 1-Reset Bushing, 1-Reset Plunger O-Ring, 1-Reset Plunger, 1-Reset Knob & 1.5 grams Dow Corning FS3452 Fluorosilicone Grease	92-470-1-105	\$210.50
(d) Diaphragm & Latch Parts Kit Includes: 1-Clapper Latch, 1-Diaphragm Housing Hex Bolt, 1-Diaphragm Retainer, 1-Flange/Push Rod Assembly, 1-Diaphragm, 1-Diaphragm Housing & 1-Latch Hinge Pin	92-470-1-107	\$1,520.00
Technical Data Sheet - TFP1330		

Section 16
Specialty Items

Section 18
Grooved Product

Section 19
CPVC Pipe & Fittings

Section 20
Miscellaneous

Section 21
Electrical

Section C
Valves & Hose Equipment

Section D
Backflow

Section F
Pipe & Accessories

Section H
Hangers

Section J
Lubricants

Section K
Misc.

See latest Technical Data Sheets for specific Approvals, Listings, Design Parameters & available finishes.

Section 16
Specialty Items

Section 18
Grooved Product

Section 19
CPVC Pipe & Fittings

Section 20
Miscellaneous

Section 21
Electrical

Section C
Valves & Hose Equipment

Section D
Backflow

Section F
Pipe & Accessories

Section H
Hangers

Section J
Lubricants

Section K
Misc.

Discontinued Valve Replacement Parts

The following repair parts are applicable to items that have been discontinued and are no longer available. Although the parts are shown in this catalog, TFPP does not guarantee the availability of the items. The parts shown in this section will be sold as long as they are available. TFPP does not have any plans to continue the production of these discontinued parts.

Note: All Items Are Non-Returnable

Star - Model E Alarm Check Valve - (1999)

Description	Part Number	List Price
Star 8" Model E Check Valve Replacement Parts		
Complete Gasket Kit: Including: Cover Gasket (Face Plate Gasket), Rubber Facing (Diaphragm Gasket)	5809	\$249.00

Star - Model F Alarm Check Valves - (1999)

Description	Part Number	List Price
Star 4" Model F Check Valve Replacement Parts		
Complete Gasket Kit: Including: Cover Gasket (Face Plate Gasket), Rubber Facing (Diaphragm Gasket), Seal Disc	5807	\$99.00
Star 6" Model F Check Valve Replacement Parts		
Complete Gasket Kit: Including: Cover Gasket (Face Plate Gasket), Rubber Facing (Diaphragm Gasket), Seal Disc	5808	\$249.00

Star - Model A-1, Dry Pipe Valves (2002)

Description	Part Number	List Price
4" Model A-1 Dry Pipe Valve Replacement Parts, Flange x Flange		
Complete Gasket Kit: Including: Cover Gasket, Clapper Diaphragm, Seat Ring Gasket	1667-4	\$477.00
6" Model A Dry Pipe Valve Replacement Parts, Flange x Flange		
Complete Gasket Kit: Including: Cover Gasket, Clapper Diaphragm, Seat Ring Gasket	1667-6	\$706.00
Star 4" Model A-1 Dry Pipe Valve Replacement Parts, Flange x Groove		
Complete Kit: Including: Cover Gasket, Clapper Diaphragm, Seat O-Ring (Inner), Seat O-Ring (Outer)	1667-41	\$477.00
Star 6" Model A Dry Pipe Valve Replacement Parts, Flange x Groove		
Complete Kit: Including: Cover Gasket, Clapper Diaphragm, Seat O-Ring (Inner), Seat O-Ring (Outer)	1667-61	\$706.00

See latest Technical Data Sheets for specific Approvals, Listings, Design Parameters & available finishes.

Discontinued Valve Replacement Parts

The following repair parts are applicable to items that have been discontinued and are no longer available. Although the parts are shown in this catalog, TFPP does not guarantee the availability of the items. The parts shown in this section will be sold as long as they are available. TFPP does not have any plans to continue the production of these discontinued parts.

Note: All Items Are Non-Returnable

Star - Model F and Model G Dry Pipe Valves -(1985)

Description	Part Number	List Price
Star 3" Model F and Model G Dry Pipe Valve Replacement Parts		
Complete Gasket Kit: Including: Cover Gasket, Air Seat Disc, Water Seat Disc, Differential Valve Spring, Housing Gaskets (2 Required), Disc Retaining Ring, Differential Valve Disc, O Ring Seal	5801	\$446.50
Star 4" Model F and Model G Dry Pipe Valve Replacement Parts		
Complete Gasket Kit: Including: Cover Gasket, Air Seat Disc, Water Seat Disc, Differential Valve Spring, Housing Gaskets (2 Required), Disc Retaining Ring, Differential Valve Disc, O Ring Seal	5802	\$526.50
Star 6" Model F and Model G Dry Pipe Valve Replacement Parts		
Complete Gasket Kit: Including: Cover Gasket, Air Seat Disc, Water Seat Disc, Differential Valve Spring, Housing Gaskets (2 Required), Disc Retaining Ring, Differential Valve Disc, O-Ring Seal	5803	\$672.00

Star - Model "A-1" Preaction Valve (2003)

Description	Part Number	List Price
Replacement Parts - (3" Model "A-1" Preaction/ Water Control Valve)		
Complete Gasket Kit: Including: Cover Gasket, Air Seat Disc, Water Seat Disc, Housing Gasket, Disc Retaining Ring, Differential Valve Disc, O Ring Seal	5971	\$380.00
Differential Plunger Spring	5576	\$32.00
Replacement Parts - (4" Model "A-1" Preaction/ Water Control Valve)		
Complete Gasket Kit: Including: Cover Gasket, Air Seat Disc, Water Seat Disc, Housing Gasket, Disc Retaining Ring, Differential Valve Disc, O Ring Seal	5839	\$487.50
Differential Plunger Spring	5576	\$32.00
Replacement Parts - (6" Model "A-1" Preaction/ Water Control Valve)		
Complete Gasket Kit: Including: Cover Gasket, Air Seat Disc, Water Seat Disc, Housing Gasket, Disc Retaining Ring, Differential Valve Disc, O Ring Seal	5972	\$586.00
Differential Plunger Spring	5576	\$32.00

Section 16
Specialty Items

Section 18
Grooved Product

Section 19
CPVC Pipe & Fittings

Section 20
Miscellaneous

Section 21
Electrical

Section C
Valves & Hose Equipment

Section D
Backflow

Section F
Pipe & Accessories

Section H
Hangers

Section J
Lubricants

Section K
Misc.

See latest Technical Data Sheets for specific Approvals, Listings, Design Parameters & available finishes.

Section 16
Specialty Items

Section 18
Grooved Product

Section 19
CPVC Pipe & Fittings

Section 20
Miscellaneous

Section 21
Electrical

Section C
Valves & Hose Equipment

Section D
Backflow

Section F
Pipe & Accessories

Section H
Hangers

Section J
Lubricants

Section K
Misc.

Discontinued Valve Replacement Parts

The following repair parts are applicable to items that have been discontinued and are no longer available. Although the parts are shown in this catalog, TFPP does not guarantee the availability of the items. The parts shown in this section will be sold as long as they are available. TFPP does not have any plans to continue the production of these discontinued parts.

Note: All Items Are Non-Returnable

Star - Deluge Valve - (Electromatic Model "D") (2002)

<i>Description</i>	<i>Part Number</i>	<i>List Price</i>
Replacement Parts - (3" Electromatic Model D Deluge Valve)		
Complete Gasket Kit: Including: Water Seat Disc, Cover Plate Gasket	5785	\$147.50
Replacement Parts - (6" Electromatic Model D Deluge Valve)		
Complete Gasket Kit: Including: Water Seat Disc, Cover Plate Gasket	5786	\$346.00

Exhauster - Model BB (2006)

<i>Description</i>	<i>Part Number</i>	<i>List Price</i>
Replacement Parts - Model BB Exhauster		
Complete Gasket Kit Including: Cover Plate Gasket, Clean-Out Plate Gasket, Upper Valve O Ring, Auxiliary Valve Nozzle Gasket, Auxiliary Valve Clapper Disc, Restriction Tube Holder, O Ring, Restriction Tube Diaphragm, Exhauster Valve Disc, Restriction Tube O Ring	5792-01	\$1,402.00
Technical Data Sheet: Star 2-5.2.10		

See latest Technical Data Sheets for specific Approvals, Listings, Design Parameters & available finishes.

Discontinued Sprinkler Accessories

The following repair parts are applicable to items that have been discontinued and are no longer available. Although the parts are shown in this catalog, TFPP does not guarantee the availability of the items. The parts shown in this section will be sold as long as they are available. TFPP does not have any plans to continue the production of these discontinued parts.

Note: All Items Are Non-Returnable

Central - A Royal Flush Concealed Ceiling Plate Assembly (2002)

Description	Part No.	Finish	List Price
135°F or 165°F	833	Brass	\$52.00
135°F or 165°F	831	Chrome	\$52.00
135°F or 165°F	832	Grey White (RAL9002)	\$52.00
135°F or 165°F	836	Signal (Bright) White	\$52.00

Star - Starmist Escutcheons (2002)

Part Number	Description	List Price
Recessed Starmist Escutcheons, 3/4" NPT (Order Separately)		
1954-02	Chrome	\$9.70
1954-04	White	\$9.70
Recessed Starmist Escutcheons, 1/2" NPT (Order Separately)		
2954-02	Chrome	\$9.70

Section 16
Specialty Items

Section 18
Grooved Product

Section 19
CPVC Pipe & Fittings

Section 20
Miscellaneous

Section 21
Electrical

Section C
Valves & Hose Equipment

Section D
Backflow

Section F
Pipe & Accessories

Section H
Hangers

Section J
Lubricants

Section K
Misc.

See latest Technical Data Sheets for specific Approvals, Listings, Design Parameters & available finishes.

Section 16 Specialty Items
Section 18 Grooved Product
Section 19 CPVC Pipe & Fittings
Section 20 Miscellaneous
Section 21 Electrical
Section C Valves & Hose Equipment
Section D Backflow
Section F Pipe & Accessories
Section H Hangers
Section J Lubricants
Section K Misc.

Discontinued Sprinkler Accessories

The following repair parts are applicable to items that have been discontinued and are no longer available. Although the parts are shown in this catalog, TFPP does not guarantee the availability of the items. The parts shown in this section will be sold as long as they are available. TFPP does not have any plans to continue the production of these discontinued parts.

Note: All Items Are Non-Returnable

See latest Technical Data Sheets for specific Approvals, Listings, Design Parameters & available finishes.

Potter Electric		
Description	Part Number	List Price
Waterflow Switches		
VS-SP 1"-1-1/2" WFD (without retard)	2447	\$204.00
VSR-S 1"-2" WFS	24148	\$229.00
VSR-SG	26144	\$269.50
VSR-ST	26145	\$269.50
VSR-F 2" WFD	24110	\$240.00
VSR-F 2 1/2" WFD	24111	\$240.00
VSR-F 3" WFD	24112	\$240.00
VSR-F 3 1/2" WFD	24113	\$240.00
VSR-F 4" WFD	24114	\$240.00
VSR-F 5" WFD	24115	\$240.00
VSR-F 6" WFD	24116	\$240.00
VSR-F 8" WFD	24117	\$271.50
Tamper Switches - OS&Y		
OSYSU-1	2414	\$149.00
OSYSU-2	2412	\$198.50
PTS-C (Plug type)	24100	\$300.00
RBVS Retrofit Ball Valve Switch less Tamper	24882	\$273.50
RBVS Retrofit Ball Valve Switch with Tamper	24883	\$295.50
Tamper Switches - Butterfly/PIV		
PCVS-2 Sets DPDT	2419	\$150.50
Pressure Switches		
PS10-1	25700	\$178.50
PS10-2	25710	\$186.50
PS40-1	25720	\$178.50
PS40-2	25730	\$186.50
Explosion Proof Switches		
VSRF-EX 2"	2489	\$3,210.00
VSRF-EX 2 1/2"	2426	\$3,210.00
VSRF-EX 3"	2396	\$3,210.00
VSRF-EX 4"	2472	\$3,210.00
VSRF-EX 6"	2477	\$3,210.00
VSRF-EX 8"	2478	\$3,472.00
PS10-2A-EX	2471	\$942.00
PS40-2A-EX	2473	\$956.50
OSYSU-EX	2486	\$1,122.00
PIVSU-EX	2487	\$1,122.00
Switches for Copper Systems		
2" VSR-CF	2458	\$398.50
2 1/2" VSR-CF	2459	\$398.50
3" VSR-CF	2394	\$398.50
4" VSR-CF	2484	\$398.50
Electric Bells - 120 Volts A.C.		
6" 120 Volts A.C.	2440	\$64.50
8" 120 Volts A.C.	2441	\$84.50
10" 120 Volts A.C.	2442	\$96.75
Electric Bells - 24 Volts A.C.		
6" 24 Volts A.C.	2387	\$64.50
10" 24 Volts A.C.	2382	\$96.75

Potter Electric		
Description	Part Number	List Price
Weatherproof Back Box		
Weather-proof Back Box	2443	\$36.75
Electric Bells - 12 Volts D.C.		
6" 12 Volts D.C.	2428	\$64.50
10" 12 Volts D.C.	2445	\$96.75
Electric Bells - 24 Volts D.C.		
6" 24 Volts D.C.	2446	\$64.50
10" 24 Volts D.C.	2444	\$96.75
Horns		
120 VAC Strobe Horn, 6117-L	2373	\$218.00
120 VAC, 60 Hz Horn 31T-115-R	2587	\$114.50
Outdoor Back (Box WBB-R); 4	2374	\$30.00
MH-120R 120VAC Mini-Horn Red	25870	\$72.50
MH-120W 120VAC Mini-Horn White	25880	\$72.50
Release Panel		
PFC 4410RC Red	20135	\$2,635.00
PFC 4410RC White	21126	\$1,708.00
Batteries for Release Panel		
8.0 Amp Hour Batteries BT-80	2656	\$79.50
12.0 Amp Hour Batteries BT-120	20128	\$141.00
Corrosion Inhibiting Device		
PAAR (Potter Automatic Air Release)	25100	\$1,889.00

Solenoid Valves		
Description	Part Number	List Price
Ordinary Location		
1/2" Solenoid Valve 110 VAC	52-287-1-110	\$741.50
1/2" Solenoid Valve 24 VDC	52-287-1-024	\$1,147.00
1/2" Solenoid Valve 125 VDC	52-287-1-125	\$770.50
Hazardous Location		
1/2" Explosion-proof Solenoid Valve 110 VAC	52-287-1-210	\$1,092.00
1/2" Explosion-proof Solenoid Valve 24 VDC	52-287-1-224	\$922.50

Potter Heat Detectors		
Description	Part Number	List Price
CR-200W Heat Detector	26590	\$34.25
CF-135W Heat Detector	26600	\$34.25

Horn Strobes		
Description	Part Number	List Price
12V/DC Horn Strobe	2344	\$191.00
120V/AC Horn Strobe	2373	\$218.00
120V/AC Red Mini-Horn Strobe	25870	\$72.50
24V/DC White Mini-Horn Strobe	25880	\$72.50

Section 16
Specialty Items

Section 18
Grooved Product

Section 19
CPVC Pipe & Fittings

Section 20
Miscellaneous

Section 21
Electrical

Section C
Valves & Hose Equipment

Section D
Backflow

Section F
Pipe & Accessories

Section H
Hangers

Section J
Lubricants

Section K
Misc.

Section 16
Specialty Items

Section 18
Grooved Product

Section 19
CPVC Pipe & Fittings

Section 20
Miscellaneous

Section 21
Electrical

Section C
Valves & Hose Equipment

Section D
Backflow

Section F
Pipe & Accessories

Section H
Hangers

Section J
Lubricants

Section K
Misc.

General Air Products		
Description	Part Number	List Price
Air Compressors: Base Mount – Single Phase		
L200-33-A	50024	\$1,473.00
L290-50-A	50232	\$1,526.00
L365-75-A	50233	\$1,641.00
L425-100-A	50027	\$1,685.00
L620-100-A	50234	\$1,977.00
L900-150-A	50235	\$2,045.00
L1300-300-A	60232	\$2,366.00
L1600-300-A	60234	\$3,724.00
L2000-500-A	60027	\$4,500.00
L2500-500-A	50238	\$4,828.00
Air Compressors: Base Mount – Three Phase		
L200-33-B	50034	\$1,457.00
L290-50-B	50237	\$1,515.00
L365-75-B	50036	\$1,570.00
L425-100-B	50037	\$1,593.00
L620-100-B	50038	\$1,854.00
L900-150-B	50239	\$1,912.00
L1300-300-B	60233	\$2,180.00
L1600-300-B	60235	\$3,879.00
L2000-500-B	60028	\$3,834.00
L2500-500-B	50043	\$4,324.00
Air Compressors: Riser Mounted Oil-Less (Includes Stop - Start)		
OL125-16AC 60HZ (125 Gallon)	60001P	\$1,213.00
OL250-33AC 60HZ (250 Gallon)	60002P	\$1,558.00
OL365-50AC 60HZ (365 Gallon)	60003P	\$1,914.00
OL430-75AC 60HZ (430 Gallon)	60004P	\$2,124.00
OL615-100AC 60HZ (615 Gallon)	60281P	\$2,803.00
OL915-150AC 60HZ (915 Gallon)	60282P	\$3,749.00
OL1225-200AC 60HZ (1,225 Gallon)	60283P	\$4,093.00
Air Compressors: Tank Mounted Oil-Less (Includes Stop - Start)		
OL125-16ACT 60HZ (125 Gallon)	60236P	\$2,183.00
OL250-33ACT 60HZ (250 Gallon)	60237P	\$2,535.00
OL365-50ACT 60HZ (365 Gallon)	60238P	\$2,963.00
OL430-75ACT 60HZ (430 Gallon)	60239P	\$3,183.00
OL615-100ACT 60HZ (615 Gallon)	60285P	\$3,520.00
OL915-150ACT 60HZ (915 Gallon)	60287P	\$5,043.00
OL1225-200ACT 60HZ (1,225 Gallon)	60288P	\$5,437.00
Air Compressors: Tank Mounted Single Phase (Includes Stop - Start)		
LT200-33-A	50047	\$2,492.00
LT290-50-A	50251	\$2,642.00
LT365-75-A	50252	\$2,702.00
LT425-100-A	50050	\$2,738.00
LT620-100-A	50253	\$3,069.00
LT900-150-A	50254	\$3,268.00
LT1300-300-A	60251	\$3,552.00
LT1600-300-A	60253	\$5,537.00
LT2000-500-A	60029	\$5,754.00
LT-2500-500-A	50056	\$6,023.00

General Air Products		
Description	Part Number	List Price
Air Compressors: Tank Mounted Three Phase (Includes Stop - Start)		
LT200-33-B	50057	\$2,691.00
LT290-50-B	50258	\$2,702.00
LT365-75-B	50059	\$2,730.00
LT425-100-B	50060	\$2,724.00
LT620-100-B	50259	\$3,018.00
LT900-150-B	50260	\$3,182.00
LT1300-300-B	60252	\$3,279.00
LT1600-300-B	60254	\$5,410.00
LT2000-500-B	60038	\$5,484.00
LT2500-500-B	50261	\$5,718.00
Magnetic Line Starter - Single Phase (Need HP and Voltage to Order)		
MGOOA	50084	\$551.50
MGXOA	50086	\$618.50
MGO1A	50085	\$702.00
MG15A	50092	\$903.50
Magnetic Line Starter - Three Phase (Need HP and Voltage to Order)		
MGOOB	50075	\$611.50
MGXOB	50093	\$732.00
MGO1B	50094	\$823.50
Riser Mount Kits - Universal Bracket		
RMK 16150	50082	\$99.00
Dry Air Pacs - F.O.B. Factory Direct (Need Voltage to Order)		
DAP500A	50264	\$18,278.00
DAP500B	50265	\$18,051.00
DAP1000B	50267	\$19,641.00
DAP2000B	50269	\$21,116.00
Dry Air Pacs - Maintenance Kits F.O.B. Factory Direct (Need Voltage to Order)		
KSMB01	60243	\$349.50
KAMA01	60244	\$943.50
Accessories		
AD3400 Desiccant Dryer	50076	\$594.50
34006 Desiccant Replacement	60010	\$161.00
F3500 Coalescing Filter	50077	\$374.50
Vibration Pad (4 Pack)	50078	\$127.00
SWP60302 Pressure Switch	60245	\$201.00
DVA-2T Electric Drain Valve	60246	\$457.00
P1202MP Flex Hose	60247	\$153.00
VR3P25080 Relief Valve	60248	\$93.25
APC01Q Air Comp. Oil	60249	\$17.50

See latest Technical Data Sheets for specific Approvals, Listings, Design Parameters & available finishes.



**Thermocable LHD - Linear Heat Detection Wire
PVC Jacket (Vinyl)**

Description	Part Number	List Price			
		100 -499 ft	500-4,999 ft ft	5,000-9,999	10,000
155°F / 68°C Red	TC155	\$3.95/ft	\$3.50/ft	\$3.35/ft	\$3.15/ft
155°F / 68°C Red with GuideWire*	TC155G	\$4.00/ft	\$3.90/ft	\$3.75/ft	\$3.40/ft
172°F / 78°C Red	TC172	\$3.95/ft	\$3.50/ft	\$3.35/ft	\$3.15/ft
172°F / 78°C Red with GuideWire*	TC172G	\$4.20/ft	\$3.90/ft	\$3.75/ft	\$3.40/ft

Notes:

*GuideWire should be installed using eyebolts for support every 15 feet (4.5m) to 20 feet (6.0m).
ThermoCable with GuideWire is only available in 500' spool lengths.

**Mounting Straps
Temperatures -40°F to 185°F (-40°C to 85°C)**

Description	Part Number	List Price	Qty.
Single Loop	TC1018C	\$126.50	pack (100)
For use with Surface Mount TC1017C	TC1018M	\$882.50	pack (1000)
Single Loop , Fits 4" to 6" (10cm to 15cm) Sprinkler Pipe	TC1029L	\$158.00	pack (50)
Double Loop , Fits 3/4" to 2" (2cm to 5cm) Sprinkler Pipe	TC1027C	\$151.50	pack (100)
	TC1027M	\$945.50	pack (1000)
Double Loop , Fits 2-1/2" to 3-1/2" (6cm to 8.9cm) Sprinkler Pipe	TC1028M	\$1,260.00	pack (1000)

Notes:

ThermoCable must be secured every 3 to 5 feet (1 to 1.5m), or 15 to 20 feet (4.5 to 6m) for installations using GuideWire

Section 16
Specialty Items

Section 18
Grooved Product

Section 19
CPVC Pipe & Fittings

Section 20
Miscellaneous

Section 21
Electrical

Section C
Valves & Hose Equipment

Section D
Backflow

Section F
Pipe & Accessories

Section H
Hangers

Section J
Lubricants

Section K
Misc.

Section 16
Specialty Items

Section 18
Grooved Product

Section 19
CPVC Pipe & Fittings

Section 20
Miscellaneous

Section 21
Electrical

Section C
Valves & Hose Equipment

Section D
Backflow

Section F
Pipe & Accessories

Section H
Hangers

Section J
Lubricants

Section K
Misc.

Mounting Clips and Clamps Temperatures -40°F to 185°F (-40°C to 85°C)			
<i>Description</i>	<i>Part Number</i>	<i>List Price</i>	<i>Qty.</i>
Cable Clip, Nylon 6.6 -3/16" (4.8mm) mounting hole	TC1012C	\$100.75	pack(100)
	TC1012M	\$756.50	pack(1000)
Push Pin -Secures through 3/16" (4.8mm) mounting hole Secures Cable Clip TC1012 to Beam Clamps and Cable Tray Mounting Clips	TC1034Q	\$31.50	pack(25)
Cable Clip, Zinc Plated , 1/4"± (6.4mm) mounting hole	TC1013C	\$31.50	pack(100)
Beam Clamp, Spring Steel Designed for material thickness up to 1/2" (12.7mm) TC1012 Cable Clip and TC1030 Push Pin required for installation	TC1014C	\$315.50	pack(100)
Beam Clamp, Zinc Plated Steel Designed for material thickness up to 7/8" (22mm) TC1012 Cable Clip and TC1030 Push Pin required for installation	TC1015L	\$189.50	pack(50)
L-Bracket Designed for floating roof tank applications TC1012 Cable Clip and TC1030 Push Pin required for installation	TC1016	\$8.80	each
Cable Tray Mounting Clip , For mounting to 3/16" (4.8mm) thick material	TC1020C	\$239.50	pack(100)
Cable Tray Mounting Clip For material thickness of 1/16" to 5/32" (1.6mm to 4mm) For material thickness of 5/32" to 1/4" (4mm to 6.4mm) TC1012 Cable Clip and TC1030 Push Pin required for installation	TC1021C TC1022C	\$252.50 \$252.50	pack(100) pack(100)
Universal Mounting Clip For material thickness 1/8" to 1/4" thick (3.2mm to 6.4mm) For material thickness 5/16" to 1/2" thick (7.9mm to 12.7mm) TC1012 Cable Clip and TC1030 Push Pin required for installation	TC1023C TC1024C	\$315.50 \$315.50	pack(100) pack(100)

GuideWire Mounting Accessories			
<i>Description</i>	<i>Part Number</i>	<i>List Price</i>	<i>Qty.</i>
Threaded Eyebolt - Zinc Plated Steel , 1/4"-20, with one nut (6.4mm) Use to support ThermoCable every 15 to 20 feet (4.5m to 6m) -250 ft. maximum TC1031ZC Lock Nut and TC1032C Insulated Grommet required for installation	TC1030ZX	\$25.25	pack(10)
Zinc Plated Lock Nut	TC1031ZC	\$19.00	pack(100)
Threaded Eyebolt - Stainless Steel , 1/4"-20 with one nut (6.4mm) Use to support ThermoCable every 15 to 20 feet (4.5m to 6m) -250 ft. maximum TC1031SSC Lock Nut and TC1032C Insulated Grommet required for installation	TC1030SS	\$6.30	each
Stainless Steel Lock Nut	TC1031SSC	\$50.50	pack(100)
Insulating Grommet , Black Rubber	TC1032C	\$40.50	pack(100)
Turnbuckle - Zinc For GuideWire installations	TC1033Z	\$6.95	each
Turnbuckle - Stainless Steel (Aluminum Body) For GuideWire installations	TC1033SS	\$15.25	each

See latest Technical Data Sheets for specific Approvals, Listings, Design Parameters & available finishes.

Surface Mounting			
DESCRIPTION	Part Number	List Price	Qty.
Surface Mount For use with TC1018 Cable Tie and TC1019 Adhesive	TC1017C	\$126.50	pack(100)
Surface Mount Adhesive For use with Surface Mount TC1017C	TC1019	\$25.25	each

Installation			
DESCRIPTION	Part Number	List Price	Qty.
Spare Installation Spool, 500' (150m)	TC1100S	\$15.25	each
Spare Installation Spool, 1500' (450m)	TC1100L	\$19.00	each
Cable Dispensing Reel	TC1011	\$252.50	each

Cable Connecting Accessories			
DESCRIPTION	Part Number	List Price	Qty.
J -Box / ELR -Box , Dim. 4" x 4" x 2" (10cm x 10cm x 5cm) NEMA 4X Moisture Proof Standard Junction Box End of line resistor supplied with panel by manufacturer Requires Screw Terminal (TC1005X)	TC1000	\$37.75	each
HDJ -Box / HDEL R -Box , Dim. 6" x 6" x 4" (15cm x 15cm x 10cm) NEMA 4X Moisture Proof Heavy Duty Junction Box End of line resistor supplied with panel by manufacturer Requires Screw Terminal (TC1005X)	TC1002	\$176.50	each
Screw Terminal , 2 Point, Must be used for all connections in TC1000 and TC1002	TC1005X	\$15.25	pack (10)
Backplate -Fits HDJ-Box / HDEL R-Box For mounting Test Switch and Screw Terminal.	TC1003	\$25.25	each
Test Switch -Attaches to Backplate (TC1003) in HDJ-Box/HDEL R-Box (TC1002) For end of line testing of linear heat detection systems.	TC1004	\$19.00	each
Cable Strain Relief Connector Required for securing ThermoCable penetrations through wall of J-Box/ELR-Box and HDJ-Box/HDEL R-Box.	TC100	\$12.75	each

Section 16	Specialty Items
Section 18	Grooved Product
Section 19	CPVC Pipe & Fittings
Section 20	Miscellaneous
Section 21	Electrical
Section C	Valves & Hose Equipment
Section D	Backflow
Section F	Pipe & Accessories
Section H	Hangers
Section J	Lubricants
Section K	Misc.

See latest Technical Data Sheets for specific Approvals, Listings, Design Parameters & available finishes.

Section 16 Specialty Items
Section 18 Grooved Product
Section 19 CPVC Pipe & Fittings
Section 20 Miscellaneous
Section 21 Electrical
Section C Valves & Hose Equipment
Section D Backflow
Section F Pipe & Accessories
Section H Hangers
Section J Lubricants
Section K Misc.

Cable Splicing Accessories			
<i>DESCRIPTION</i>	<i>Part Number</i>	<i>List Price</i>	<i>Qty.</i>
Screw Terminal, 2 Point, Must be used for all splices	TC1005X	\$15.25	pack (10)
Sealant Tape, Must be used for all splices	TC1006	\$22.75	Roll
Splicing Tape, White	TC1007	\$12.75	Roll
Splicing Tape, Red	TC1008	\$12.75	Roll
Splicing Tape, Blue	TC1009	\$12.75	Roll
Low Temperature Splicing Tape, Black	TC1010	\$12.75	Roll

Fire Alarm Control / Releasing Panel - Modules			
<i>DESCRIPTION</i>	<i>Part Number</i>	<i>List Price</i>	<i>Qty.</i>
Class A Initiating Device Module	TC4402	\$63.00	each
Converts 2 Class B Initiating Circuits to 2 Class A Initiating Circuits			
Class A Indicating Appliance Circuit Module	TC4401	\$139.00	each
Converts 1 Class B Annunciating Circuit to 1 Class A Annunciating Circuits			
Auxiliary Relay Module (24 VDC, DPST)	TC4403	\$170.50	each
Auxiliary Relay Module (24 VDC, DPDT)	TC4404	\$227.00	each
Intrinsic Safety Barrier , Special Hazard Applications 1 per Zone, 35mm DIN Rail Mounting	TC4406	\$731.00	each

See latest Technical Data Sheets for specific Approvals, Listings, Design Parameters & available finishes.

Kennedy Valves		
Description	Part Number	List Price
O.S.&Y. Gate Valve UL/FM Resilient Wedge w/3/4" Tap and Plug - Model #4068A		
2 1/2"	2265	\$889.00
3"	2266	\$1,027.50
4"	2267	\$1,192.00
6"	2269	\$1,734.00
8"	2268	\$2,848.00
10"	2264	\$4,655.00
12"	2259	\$6,024.00
O.S.&Y. Valve Flanged x Grooved - Model #7092A		
2 1/2"	22650	\$889.00
3"	22660	\$1,027.50
4"	22670	\$1,192.00
6"	22690	\$1,734.00
8"	22680	\$2,844.00
O.S.&Y. Valve Grooved x Grooved - Model #7093A		
2 1/2"	22651	\$889.00
3"	22661	\$1,027.50
4"	22671	\$1,192.00
6"	22691	\$1,734.00
8"	22681	\$2,844.00
Grooved Check Valve - Model #426		
2 1/2"	21215	\$732.50
3"	21216	\$804.00
4"	21218	\$979.50
6"	21217	\$1,432.00
8"	20592	\$2,033.00
Iron Body Swing Check Valves UL/FM Flanged 175 PSI - Model 126A		
2 1/2"	21221	\$1,294.00
3"	21223	\$1,460.00
4"	21224	\$1,937.00
6"	21226	\$3,096.00
8"	21227	\$5,162.00
10"	21228	\$8,513.00
12"	21229	\$12,216.00
Wafer Check Valves UL/FM 300 PSI - Model 706		
4"	21000	\$739.50
6"	21020	\$1,294.00
8"	21040	\$2,105.00
Flanged PIV Non Rising Stem Gate Valve Resilient Wedge - Model 4701		
4"	20504	\$928.00
6"	20506	\$1,446.00
8"	20508	\$2,349.00
10"	20509	\$3,996.00
#01G - Grooved BFV		
2 1/2"	322260	\$831.00
3"	322310	\$890.00
4"	322410	\$952.00
6"	322610	\$1,423.00
8"	322810	\$2,074.00

Kennedy Valves		
Description	Part Number	List Price
#01G - Wafer BFV		
2 1/2"	322110	\$780.00
3"	322130	\$861.50
4"	322140	\$959.50
6"	322160	\$1,261.00
8"	322180	\$1,857.00
PIV, NRS Gate Valve UL/FM Mechanical Joint w/Accessories Resilient Wedge - Model 4071		
4"	20514	\$1,015.50
6"	20516	\$1,495.00
8"	20518	\$3,137.00
10"	20520	\$4,065.00
12"	20521	\$6,697.00
Wall Post Indicator Model 641-13 Includes Stem and Coupling		
Wall Post Indicator	20810	\$1,220.00
Wall Post Handwheel	20809	\$475.00
Vertical Post Indicator (Formerly Model #741)		
Model #2945B	20811	\$1,815.00
Model #2945C	20820	\$1,815.00
P.I. Wrench	20510	\$215.00

Babbitt Valve Chainwheels			
Cast Iron Standard Chainwheel			
Item No.	Hand Wheel Size	Part Number	List Price
0	2" to 4"	5036	\$203.00
1	4 1/4" to 5 3/4"	5037	\$294.50
1.5	6" to 7 1/2"	5031	\$357.00
2	7 3/4" to 9"	5038	\$471.50
2.5	9 1/4" to 12 1/2"	5039	\$676.50
3	12 3/4" to 15 1/2"	5040	\$786.00
3.5	15 3/4" to 19"	5041A	\$1,190.00
Epoxy Coated Corrosion Resistant Chainwheel			
0	2" to 4"	5025	\$440.00
1	4 1/4" to 5 3/4"	5026	\$706.50
1.5	6" to 7 1/2"	5027	\$903.00
2	7 3/4" to 9"	5028	\$1,108.00
2.5	9 1/4" to 12 1/2"	5033	\$1,434.00
3	12 3/4" to 15 1/2"	5034	\$1,768.50
3.5	15 3/4" to 19"	5035	\$2,181.50
Hot Dipped Galvanized Standard Chain			
Item No.	Part Number	List Price Per Foot	
0	5029	\$6.55	
1 to 2	5030	\$8.75	
2.5 to 3.5	5032	\$12.00	

Section 16
Specialty Items

Section 18
Grooved Product

Section 19
CPVC Pipe & Fittings

Section 20
Miscellaneous

Section 21
Electrical

Section C
Valves & Hose Equipment

Section D
Backflow

Section F
Pipe & Accessories

Section H
Hangers

Section J
Lubricants

Section K
Misc.

See latest Technical Data Sheets for specific Approvals, Listings, Design Parameters & available finishes. Sprinkler heads & escutcheons are priced separately unless otherwise noted. Items marked "C.O." are made to order and may require longer delivery times.

Section 16
Specialty Items

Section 18
Grooved Product

Section 19
CPVC Pipe & Fittings

Section 20
Miscellaneous

Section 21
Electrical

Section C
Valves & Hose Equipment

Section D
Backflow

Section F
Pipe & Accessories

Section H
Hangers

Section J
Lubricants

Section K
Misc.

United Brass Bronze Valves		
Description	Part Number	List Price
Globe Valves		
3-Way 1/4"	2228	\$21.25
1/2" Globe	2222	\$31.75
3/4" Globe	2223	\$40.25
1" Globe	2224	\$54.00
1 1/4" Globe	2225	\$87.00
1 1/2" Globe	2226	\$125.00
2" Globe	2227	\$178.00
Swing Checks		
1/2"	2240	\$35.00
3/4"	2241	\$40.25
1"	2242	\$55.00
1 1/4"	2243	\$78.50
1 1/2"	2244	\$117.50
2"	2245	\$132.50
Ball Valves		
1/2"	2280	\$39.25
3/4"	2281	\$59.25
1"	2284	\$75.25
1 1/4"	2296	\$123.00
1 1/2"	2276	\$153.50
2"	2262	\$203.50
Angle Valves		
1/2"	2202	\$34.00
3/4"	2203A	\$38.25
1"	2204A	\$57.25
1 1/4"	2205A	\$93.25
1 1/2"	2206A	\$126.00
2"	2207	\$151.50
OS&Y Valves		
1"	2272	\$240.50
1 1/4"	2273	\$273.50
1 1/2"	2274	\$355.00
2"	2275	\$464.50

Lansdale Powerball 300 Valves		
Description	Part Number	List Price
Slow Close Valve with Integral Tamper Switch (300psi)		
1" LPBT	51009A	\$328.00
1 1/4" LPBT	51010A	\$349.00
1 1/4" LPBG Grooved	51027A	\$379.00
1 1/2" LPBT	51011A	\$417.00
1 1/2" LPBG Grooved	51024A	\$447.00
2" LPBT	51012A	\$500.00
2" LPBG Grooved	51021A	\$536.00
2 1/2" LPBT	51013A	\$649.00
2 1/2" LPBG Grooved	51018A	\$667.00

Trim Valves		
Description	Part Number	List Price
Globe Valves		
3-Way 1/4"	41320	\$15.00
1/2" Globe	41321	\$21.25
3/4" Globe	41322	\$25.50
1" Globe	41323	\$37.00
1 1/4" Globe	41324	\$55.00
1 1/2" Globe	41325	\$82.75
2" Globe	41326	\$122.00
Swing Checks		
1/2"	41333	\$26.50
3/4"	41334	\$31.75
1"	41335	\$53.00
1 1/4"	41336	\$76.25
1 1/2"	41337	\$108.00
2"	41338	\$131.50
Ball Valves		
1/2"	41302	\$12.75
3/4"	41303	\$19.00
1"	41304	\$30.75
1 1/4"	41305	\$51.00
1 1/2"	41306	\$69.00
2"	41307	\$96.50
Angle Valves		
1/2"	41327	\$26.50
3/4"	41328	\$31.75
1"	41329	\$56.25
1 1/4"	41330	\$79.50
1 1/2"	41331	\$104.00
2"	41332	\$143.00

*See latest Technical Data Sheets for specific Approvals, Listings, Design Parameters & available finishes. Sprinkler heads & escutcheons are priced separately unless otherwise noted. Items marked "C.O." are made to order and may require longer delivery times.

Hose Valves & FDC's		
Description	Part Number	List Price
Hose Valves		
1 1/2" FT X FT Angle	22450	\$106.50
1 1/2" FT X MT Angle	22460	\$106.50
2 1/2" FT X FT Angle	22451	\$233.50
2 1/2" FT X MT Angle	22461	\$230.50
1 1/2" Cap with Brass Chain	41205	\$24.00
2 1/2" Cap with Brass Chain	41204	\$34.50
2 1/2"x1 1/2" Brass Reducing Adapter	41206	\$44.00
STORZ Equipment		
STORZ 4" x 4" Straight FDC (import)	61232	\$215.50
STORZ 4" x 5" Straight FDC (import)	61242	\$370.00
STORZ 4" x 4" w/ 30-degree Elbow (import)	61233	\$336.00
STORZ 4" x 5" w/ 30-degree Elbow (import)	61243	\$448.00
STORZ 4" Cap with Chain (import)	61234	\$192.50
STORZ 5" Cap with Chain (import)	61244	\$260.50
STORZ 4" x 4" Straight Connection Kit (import)	61231	\$582.00
STORZ 4" x 5" Straight Connection Kit (import)	61241	\$685.50
STORZ 4" x 4" 30-degree Connection Kit (import)	61251	\$651.50
STORZ 4" x 5" 30-degree Connection Kit (import)	61261	\$795.00
Fire Department Connections		
Fire Dept (Alum.) Sign Round	2503	\$16.25
Fire Dept (Alum.) Sign Rect. 8" x 4" (straight) 4" x 2 1/2"	22441	\$17.75
(90° Angle) 4" x 2 1/2"	2501	\$214.50
Red Plastic Caps w/ Bolt & Nut (pair)	2505	\$228.50
Aluminum Caps w/ Bolt & Nut (pair)	2502A	\$18.50
	2504	\$10.30
Residential Fire Dept Connections		
1 1/2" Residential Fire Dept Connection	2509	\$87.00

Croker Standpipe and Hose Equipment		
Description	Part Number	List Price
Hose Rack Units		
#3010 1 1/2" x 100' Less Nozzle	51290	\$695.50
Adjustable Fog Nozzles		
#3460 1 1/2" Brass	2745	\$72.50
#3464 2 1/2" Brass	27450	\$248.00

Croker Standpipe and Hose Equipment		
Description	Part Number	List Price
Fire Hose		
#3401, 1 1/2" 500 PSI Rack Hose Coupled		
100'	2760	\$265.00
#3405, 1 1/2" 300 PSI Single Jacket Coupled		
75'	27610	\$336.50
100'	27620	\$407.50
Fire Hose Reel		POA
Hose Valves		
#5020 1 1/2" Angle Valve, Female x Female	27910	POA
#5010 1 1/2" Angle Valve, Female x Male	27920	POA
#5025 2 1/2" Angle Valve, Female x Female	27930	POA
#5015 2 1/2" Angle Valve, Female x Male	27940	POA
#5709 1 1/2" Cap & Chain	27550	\$16.50
#5713 2 1/2" Cap & Chain	27560	\$22.00
#7245 2 1/2" Female x 1 1/2" Male Reducer	2755	\$35.25
Pressure Restricting Hose Valves		
#5060 1 1/2" Angle, Female x Female	27950	POA
#5050 1 1/2" Angle, Female x Male	27960	\$212.00
#5055 2 1/2" Angle, Female x Male	27980	\$454.00
Pressure Regulating Hose Valves (Factory Set)		
#5580 2 1/2" Angle, Female x Male	28030	\$1,132.00
Tamper Switch Bracket Available		
Field Adjustable Pressure Regulating Valves		POA
Note: All valves listed with rough brass finish. Other finishes available.		

Section 16
Specialty Items

Section 18
Grooved Product

Section 19
CPVC Pipe & Fittings

Section 20
Miscellaneous

Section 21
Electrical

Section C
Valves & Hose Equipment

Section D
Backflow

Section F
Pipe & Accessories

Section H
Hangers

Section J
Lubricants

Section K
Misc.

See latest Technical Data Sheets for specific Approvals, Listings, Design Parameters & available finishes. Sprinkler heads & escutcheons are priced separately unless otherwise noted. Items marked "C.O." are made to order and may require longer delivery times.

Section 16	Specialty Items
Section 18	Grooved Product
Section 19	CPVC Pipe & Fittings
Section 20	Miscellaneous
Section 21	Electrical
Section C	Valves & Hose Equipment
Section D	Backflow
Section F	Pipe & Accessories
Section H	Hangers
Section J	Lubricants
Section K	Misc.

Crocker Standpipe and Hose Equipment		
Description	Part Number	List Price
Fire Department Inlet Connections – Single Inlet		
#6341 2 1/2" w/Plate & Plug		
Rough Brass	28155	\$171.50
Polished Brass	28160	\$319.50
Polished Chrome	28165	\$385.50
#6342 3" x 2 1/2" w/Plate & Plug		
Rough Brass	28170	\$275.50
Fire Department Inlet Connections – Free Standing Type		
(Complete with 18" sleeve, Plate & Plugs)		
#6510 4" x 2 1/2" x 2 1/2"		
Rough Brass	28330	\$1,157.00

Crocker Standpipe and Hose Equipment		
Description	Part Number	List Price
Fire Department Inlet Connections – Projecting Type		
#6407, 4"x 2 1/2"x 2 1/2", Single Clapper, Angle		
Rough Brass	28190	\$209.50
#6410, 4"x 2 1/2"x 2 1/2" Double Clapper, Straight		
Rough Brass	28195	\$496.00
Polished Chrome	28205	\$860.50
#6420 4"x 2 1/2"x 2 1/2" Double Clapper, Angle		
Rough Brass	28225	\$1,351.00
#6422 6"x 2 1/2"x 2 1/2" Double Clapper, Angle		
Polished Chrome	28250	POA
#6760 4" Round Wall Plate		
Rough Brass	28255	\$175.00
Polished Chrome	28265	\$571.00
#6764 6" Round Wall Plate,		
#6766 4" Round Wall Plate, Aluminum	28285	\$27.75
Note: Plates lettered Automatic Sprinkler, Standpipe, or Automatic Sprinkler and Standpipe.		
#6747 2 1/2" Plug & Chain,		
Rough Brass	28295	\$49.75
Polished Brass	28300	\$66.25
Polished Chrome	28305	\$77.25
#6780 1/2" Auto Ball Drip, Straight	28320	\$30.75

*See latest Technical Data Sheets for specific Approvals, Listings, Design Parameters & available finishes. Sprinkler heads & escutcheons are priced separately unless otherwise noted. Items marked "C.O." are made to order and may require longer delivery times.

Croker Standpipe and Hose Equipment		
<i>Description</i>	<i>Part Number</i>	<i>List Price</i>
Fire Department Inlet Connections – Flush Wall Type		
#6010 4"x 2 1/2" x 2 1/2", Straight Body		
Rough Brass	28050	\$1,047.00
Polished Brass	28055	\$1,299.00
Check Valves		
#8470-G 4" Groove x Groove, Brass	28360	\$394.00
#8470-T 4" Thread x Thread, Brass	28370	\$394.00
Storz Connections (with Plate & Cap)		
#6360 4" x 4" Aluminum, Straight	28375	\$2,233.00
#6363 6" x 4" Aluminum, 30°	28400	\$1,355.00

Croker Standpipe and Hose Equipment		
<i>Description</i>	<i>Part Number</i>	<i>List Price</i>
Cabinets		
#2700-A Fire department valve cabinet, Recessed, 18X18X8, Steel, Full glass door	28415	\$476.50
Complete line of cabinets available. Specify size, mounting style, finish, and door style. All hose threads shown are NST. Special threads available upon request.		

Section 16	Specialty Items
Section 18	Grooved Product
Section 19	CPVC Pipe & Fittings
Section 20	Miscellaneous
Section 21	Electrical
Section C	Valves & Hose Equipment
Section D	Backflow
Section F	Pipe & Accessories
Section H	Hangers
Section J	Lubricants
Section K	Misc.

See latest Technical Data Sheets for specific Approvals, Listings, Design Parameters & available finishes. Sprinkler heads & escutcheons are priced separately unless otherwise noted. Items marked "C.O." are made to order and may require longer delivery times.

Section 16
Specialty Items

Section 18
Grooved Product

Section 19
CPVC Pipe & Fittings

Section 20
Miscellaneous

Section 21
Electrical

Section C
Valves & Hose Equipment

Section D
Backflow

Section F
Pipe & Accessories

Section H
Hangers

Section J
Lubricants

Section K
Misc.

Guardian Standpipe and Hose Equipment		
Description	Part Number	List Price
Hose Rack Units		
#3007-LN 1 1/2" x 75' Fire Hose less Nozzle	6128	\$494.00
#3010-LN 1 1/2" x 100' Fire Hose less Nozzle	6129	\$546.50
#3107-LN 2 1/2" x 75' Fire Hose less Nozzle	61280	\$1,086.00
#3110-LN 2 1/2" x 100' Fire Hose less Nozzle	61290	\$1,242.00
Adjustable Fog Nozzles		
#3714 1 1/2" Polycarbonate Fog Nozzle	61320	\$29.75
#3704 1 1/2" Brass Fog Nozzle	6132	\$72.50
#3726 2 1/2" Brass Fog Nozzle	61325	\$232.50
Fire Hose		
500 PSI Rack Hose Coupled		
#3402-50 1 1/2" x 50' Coupled Fire Hose	61330	\$210.50
#3402-75 1 1/2" x 75' Coupled Fire Hose	6134	\$274.50
#3402-100 1 1/2" x 100' Coupled Fire Hose	6133	\$296.50
300 PSI Single Jacket Coupled		
#3412-50 1 1/2" x 50' Coupled Fire Hose	61335	\$216.50
#3412-75 1 1/2" x 75' Coupled Fire Hose	61340	\$304.00
#3412-100 1 1/2" x 100' Coupled Fire Hose	61345	\$378.50
300 PSI Single Jacket Coupled		
#3414-50 2 1/2" x 50' Coupled Fire Hose	61350	\$399.50
#3414-75 2 1/2" x 75' Coupled Fire Hose	61355	\$536.50
#3414-100 2 1/2" x 100' Coupled Fire Hose	61360	\$668.00
600 PSI Double Jacket Coupled		
#3442-50 1 1/2" x 50' Coupled Fire Hose	61365	\$416.50
#3442-75 1 1/2" x 75' Coupled Fire Hose	61370	\$572.00
#3442-100 1 1/2" x 100' Coupled Fire Hose	61375	\$586.00
600 PSI Double Jacket Coupled		
#3444-50 2 1/2" x 50' Coupled Fire Hose	61380	\$595.00
#3444-75 2 1/2" x 75' Coupled Fire Hose	61385	\$743.50
#3444-100 2 1/2" x 100' Coupled Fire Hose	61390	\$1,113.00
Fire Hose Reels		POA
Hose Valves		
#5020 1 1/2" FxF Angle Hose Valve	6109	\$108.00
#5010 1 1/2" FxM Angle Hose Valve	6106	\$108.00
#5025 2 1/2" FxF Angle Hose Valve	6110	\$201.00
#5015 2 1/2" FxM Angle Hose Valve	6107	\$172.50
#5515 1 1/2" Cap & Chain	6111	\$17.50
#5525 2 1/2" Cap & Chain	6112	\$28.75
Reducer		
#3315 2 1/2" Female x 1 1/2" Male Reducer	6163	\$33.25

Guardian Standpipe and Hose Equipment		
Description	Part Number	List Price
Pressure Restricting Hose Valves		
#5040 1 1/2" FxF Angle Press Restrict Valve	61395	\$175.50
#5030 1 1/2" FxM Angle Press Restrict Valve	61405	\$206.00
#5045 2 1/2" FxF Angle Press Restrict Valve	61400	\$376.00
#5035 2 1/2" FxM Angle Press Restrict Valve	61410	\$364.50
Pressure Regulating Hose Valves (Factory Set)		
#5250 1 1/2" FxF Angle Press Regul. Valve	61415	POA
#5240 1 1/2" FxM Angle Press Regul. Valve	61425	POA
#5255 2 1/2" FxF Angle Press Regul. Valve	61420	POA
#5245 2 1/2" FxM Angle Press Regul. Valve	61430	POA
#5260 2 1/2" FxF Inline Press Regul. Valve	61435	POA
Tamper Switch Bracket Available		
Field Adjustable Pressure Regulating Valves		POA
Note: All valves listed with rough brass finish. Other finishes available.		
Fire Department Inlet Connections – Single Inlet		
#6002 1 1/2" RB FDC w/ Plate & Plug	61535	\$79.50
#6002-B 1 1/2" PB FDC w/ Plate & Plug	61540	\$120.00
#6002-D 1 1/2" PC FDC w/ Plate & Plug	61545	\$183.50
#6014 2 1/2" RB FDC w/ Plate & Plug	61550	\$197.50
#6014-B 2 1/2" PB FDC w/ Plate & Plug	61555	\$311.00
#6014-D 2 1/2" PC FDC w/ Plate & Plug	61560	\$383.50
#6015 3" x 2 1/2" RB FDC w/ Plate & Plug	61565	\$275.50
#6015-B 3" x 2 1/2" PB FDC w/ Plate & Plug	61570	\$336.50
#6015-D 3" x 2 1/2" PC FDC w/ Plate & Plug	61575	\$549.50
Fire Department Inlet Connections – Projecting Type		
#6314 4" x 2 1/2" x 2 1/2" SC FDC Straight	6153	\$193.50
#6315 4" x 2 1/2" x 2 1/2" SC FDC Angle	6154	\$306.00
#6324 4" x 2 1/2" x 2 1/2" RB DC FDC Straight	6155	\$682.00
#6324-B 4" x 2 1/2" x 2 1/2" PB DC FDC Straight	6157	\$800.50
#6324-D 4" x 2 1/2" x 2 1/2" PC DC FDC Straight	6158	\$702.50
#6326 6" x 2 1/2" x 2 1/2" RB DC FDC Straight	61580	\$853.00
#6326-B 6" x 2 1/2" x 2 1/2" PB DC FDC Straight	61585	\$1,128.00
#6326-D 6" x 2 1/2" x 2 1/2" PC DC FDC Straight	61590	\$1,141.00

*See latest Technical Data Sheets for specific Approvals, Listings, Design Parameters & available finishes. Sprinkler heads & escutcheons are priced separately unless otherwise noted. Items marked "C.O." are made to order and may require longer delivery times.

Guardian Standpipe and Hose Equipment		
Description	Part Number	List Price
#6325 4" x 2 1/2" x 2 1/2" RB DC FDC Angle	6156	\$527.50
#6325-B 4" x 2 1/2" x 2 1/2" PB DC FDC Angle	6170	\$820.00
#6325-D 4" x 2 1/2" x 2 1/2" PC DC FDC Angle	6171	\$1,040.00
#6327 6" x 2 1/2" x 2 1/2" RB DC FDC Angle	61595	\$897.00
#6327-B 6" x 2 1/2" x 2 1/2" PB DC FDC Angle	61600	\$2,107.00
#6327-D 6" x 2 1/2" x 2 1/2" PC DC FDC Angle	61605	\$1,451.00
#6464 RB 4" Round Wall Plate	6137	\$150.50
#6464-B PB 4" Round Wall Plate	6138	\$181.00
#6464-D PC 4" Round Wall Plate	6150	\$216.50
#6466 RB 6" Round Wall Plate	61610	\$175.50
#6466-B PB 6" Round Wall Plate	61615	\$306.00
#6466-D PC 6" Round Wall Plate	61620	\$337.50
#6454 Aluminum 4" Round Wall Plate	61625	\$31.50
Note: Plates lettered Automatic Sprinkler, Standpipe, or Automatic Sprinkler and Standpipe.		
#6404 2 1/2" RB Plug & Chain	6115	\$37.50
#6404-B 2 1/2" PB Plug & Chain	6116	\$57.50
#6404-D 2 1/2" PC Plug & Chain	6117	\$74.50
#6406-PR 2 1/2" Aluminum Breakable Cap	61635	\$9.85/Pair
#6407-PR 2 1/2" Plastic Breakable Cap	61636	\$3.30/Pair
#6430 1/2" Straight Auto Ball Drip	6104	\$25.50
#6431 1/2" Angle Auto Ball Drip	61640	\$47.75
Fire Department Inlet Connections – Free Standing Type (Complete with 18" sleeve, Plate & Plugs)		
#6224 4" x 2 1/2" x 2 1/2" RB FDC w/Plt, Plug, Slv	61645	\$1,046.00
#6224-B 4" x 2 1/2" x 2 1/2" PB FDC w/Plt, Plug, Slv	61650	\$1,611.00
#6224-D 4" x 2 1/2" x 2 1/2" PC FDC w/Plt, Plug, Slv	61655	\$1,457.00
#6226 6" x 2 1/2" x 2 1/2" RB FDC w/Plt, Plug, Slv	61660	\$2,062.00
#6226-B 6" x 2 1/2" x 2 1/2" PB FDC w/Plt, Plug, Slv	61665	\$2,343.00
#6226-D 6" x 2 1/2" x 2 1/2" PC FDC w/Plt, Plug, Slv	61670	\$2,875.00

Guardian Standpipe and Hose Equipment		
Description	Part Number	List Price
Fire Department Inlet Connections – Flush Wall Type		
#6024 4" x 2 1/2" x 2 1/2" RB FDC FL Straight	61445	\$1,279.00
#6024-B 4" x 2 1/2" x 2 1/2" PB FDC FL Straight	61450	\$2,573.00
#6024-D 4" x 2 1/2" x 2 1/2" PC FDC FL Straight	61455	\$1,579.00
#6025 4" x 2 1/2" x 2 1/2" RB FDC FL Angle	61475	\$1,479.00
#6025-B 4" x 2 1/2" x 2 1/2" PB FDC FL Angle	61480	\$1,631.00
#6025-D 4" x 2 1/2" x 2 1/2" PC FDC FL Angle	61485	\$1,605.00
#6026 4" x 2 1/2" x 2 1/2" RB FDC Top Feed	61505	\$1,756.00
#6026-B 4" x 2 1/2" x 2 1/2" PB FDC Top Feed	61510	\$1,881.00
#6026-D 4" x 2 1/2" x 2 1/2" PC FDC Top Feed	61515	\$2,056.00
#6027 6" x 2 1/2" x 2 1/2" RB FDC FL Straight	61460	\$1,826.00
#6027-B 6" x 2 1/2" x 2 1/2" PB FDC FL Straight	61465	\$1,977.00
#6027-D 6" x 2 1/2" x 2 1/2" PC FDC FL Straight	61470	\$1,855.00
#6028 6" x 2 1/2" x 2 1/2" RB FDC FL Angle	61490	\$2,424.00
#6028-B 6" x 2 1/2" x 2 1/2" PB FDC FL Angle	61495	\$2,187.00
#6028-D 6" x 2 1/2" x 2 1/2" PC FDC FL Angle	61500	\$2,897.00
#6029 6" x 2 1/2" x 2 1/2" RB FDC Top Feed	61520	\$2,860.00
#6029-B 6" x 2 1/2" x 2 1/2" PB FDC Top Feed	61525	\$3,010.00
#6029-D 6" x 2 1/2" x 2 1/2" PC FDC Top Feed	61530	\$3,290.00
Check Valves		
#6420 GxG Check Valve 4" Brass	61675	\$336.50
#6421 GxT Check Valve 4" Brass	61680	\$336.50
#6422 TxT Check Valve 4" Brass	61685	\$1,111.00
Storz Connections (with Plate & Cap)		
#6614-KIT 4"x4" Straight Aluminum Storz Conn.	6123	\$532.50
#6624-KIT 4"x4" 30-degree Aluminum Storz Conn.	6125	\$709.00
#6615-KIT 4"x5" Straight Aluminum Storz Conn.	6124	\$677.50
#6625-KIT 4"x5" 30-degree Aluminum Storz Conn.	6126	\$798.50
#6617-KIT 6"x4" Straight Aluminum Storz Conn.	61230	\$715.00
#6627-KIT 6"x4" 30-degree Aluminum Storz Conn.	61250	\$941.00
#6618-KIT 6"x5" Straight Aluminum Storz Conn.	61240	\$834.00
#6628-KIT 6"x5" 30-degree Aluminum Storz Conn.	61260	\$1,029.00

Section 16
Specialty Items

Section 18
Grooved Product

Section 19
CPVC Pipe & Fittings

Section 20
Miscellaneous

Section 21
Electrical

Section C
Valves & Hose Equipment

Section D
Backflow

Section F
Pipe & Accessories

Section H
Hangers

Section J
Lubricants

Section K
Misc.

See latest Technical Data Sheets for specific Approvals, Listings, Design Parameters & available finishes. Sprinkler heads & escutcheons are priced separately unless otherwise noted. Items marked "C.O." are made to order and may require longer delivery times.

Section 16
Specialty Items

Section 18
Grooved Product

Section 19
CPVC Pipe & Fittings

Section 20
Miscellaneous

Section 21
Electrical

Section C
Valves & Hose Equipment

Section D
Backflow

Section F
Pipe & Accessories

Section H
Hangers

Section J
Lubricants

Section K
Misc.

Guardian Standpipe and Hose Equipment		
<i>Description</i>	<i>Part Number</i>	<i>List Price</i>
Roof Manifolds (Body Only)		
#6924 4" x 2 1/2" x 2 1/2" Straight Manifold Body	6143	\$186.00
#6925 4" x 2 1/2" x 2 1/2" Angle Manifold Body	6145	\$222.00
#6926 6" x 2 1/2" x 2 1/2" Straight Manifold Body	6144	\$450.50
#6927 6" x 2 1/2" x 2 1/2" Angle Manifold Body	6146	\$684.50
Note: Refer to page C-6 for appropriate valves, caps and chains		
Cabinets		
#2020-A Recessed Valve Cabinet Full Glass	61690	\$236.50
#2050-A Flush Valve Cabinet Full Glass	61695	\$317.50
Complete line of cabinets available. Specify size, mounting style, finish, and door style. All hose threads shown are NST. Special threads available upon request.		

*See latest Technical Data Sheets for specific Approvals, Listings, Design Parameters & available finishes. Sprinkler heads & escutcheons are priced separately unless otherwise noted. Items marked "C.O." are made to order and may require longer delivery times.

Ames		
Description	Part Number	List Price
Model Maxim M200 With FxG OS&Y Valve		
2 1/2"	205500	\$3,148.00
3"	205510	\$3,257.00
4"	205520	\$4,201.00
6"	205530	\$6,756.00
8"	207190	\$11,502.00
Model Maxim M200 With Grooved Butterfly Valve		
2 1/2"	205501	\$3,923.00
3"	205511	\$3,839.00
4"	205521	\$4,949.00
6"	205531	\$7,981.00
8"	207191	\$13,585.00
Model Maxim M300 DCDA With FxG OS&Y Valve (GPM Meter)		
2 1/2"	205490	\$4,361.00
3"	205480	\$4,636.00
4"	205580	\$5,036.00
6"	205590	\$7,872.00
8"	205390	\$14,190.00
Model Maxim M300 DCDA With FxG OS&Y Valve (CFM Meter)		
2 1/2"	205495	\$4,361.00
3"	205485	\$4,636.00
4"	205585	\$5,036.00
6"	205595	\$7,872.00
8"	205395	\$14,190.00
Model Maxim M300 DCDA With Grooved Butterfly Valve (GPM Meter)		
2 1/2"	205491	\$5,112.00
3"	205481	\$5,470.00
4"	205581	\$5,915.00
6"	205591	\$9,006.00
8"	205391	\$15,966.00
Model Maxim M300 DCDA With Grooved Butterfly Valve (CFM Meter)		
2 1/2"	205496	\$5,112.00
3"	205486	\$5,470.00
4"	205586	\$5,915.00
6"	205596	\$9,006.00
8"	205396	\$15,966.00
Model Maxim M400 With FxG OS&Y Valve		
2 1/2"	207670	\$3,865.00
3"	207680	\$4,275.00
4"	207690	\$5,435.00
6"	207700	\$8,626.00
8"	207710	\$16,438.00
Model Maxim M400N With Grooved Butterfly Valve		
2 1/2"	207671	\$4,914.00
3"	207681	\$5,351.00
4"	207691	\$6,778.00
6"	207701	\$10,663.00

Ames		
Description	Part Number	List Price
Model Maxim M500 RPDA With FxG OS&Y Valve (GPM Meter)		
2 1/2"	208320	\$6,418.00
3"	208330	\$6,601.00
4"	208340	\$6,706.00
6"	208360	\$10,577.00
8"	208380	\$18,731.00
Model Maxim M500 RPDA With FxG OS&Y Valve (CFM Meter)		
2 1/2"	208325	\$6,418.00
3"	208335	\$6,601.00
4"	208345	\$6,706.00
6"	208365	\$10,577.00
8"	208385	\$20,450.00
Model Maxim M500 RPDA With Grooved BFV's Valve (GPM Meter)		
2 1/2"	208321	\$7,780.00
3"	208331	\$8,017.00
4"	208341	\$8,234.00
6"	208361	\$12,905.00
Model Maxim M500 RPDA With Grooved BFV's Valve (CFM Meter)		
2 1/2"	208326	\$7,780.00
3"	208336	\$8,017.00
4"	208346	\$8,234.00
6"	208366	\$12,905.00
Model 1000 DCV Detector Check F x F (Less By-Pass)		
4"	20849	\$1,917.00
6"	20851	\$2,740.00
8"	20853	\$4,591.00
10"	20855	\$8,385.00
Model 1005 DCV Detector Check F x G (Less By-Pass)		
4"	20858	\$1,838.00
6"	20854	\$2,621.00
Model 2000B Brass Double Check Assembly (With Ball Valve)		
1/2"	21010	\$315.50
3/4"	21011	\$288.50
1"	21012	\$353.00
1 1/4"	21013	\$611.50
1 1/2"	21014	\$684.50
2"	21015	\$807.00
Model 2000B Brass Double Check Assembly (Less Ball Valve)		
1/2"	21023	\$300.00
3/4"	21024	\$356.00
1"	21025	\$488.50
1 1/4"	21026	\$537.00
1 1/2"	21027	\$574.00
2"	21028A	\$617.50

Section 16
Specialty Items

Section 18
Grooved Product

Section 19
CPVC Pipe & Fittings

Section 20
Miscellaneous

Section 21
Electrical

Section C
Valves & Hose Equipment

Section D
Backflow

Section F
Pipe & Accessories

Section H
Hangers

Section J
Lubricants

Section K
Misc.

Items shown on this sheet may not be stocked at all Tyco Fire Products warehouses. Please ask your local Tyco Fire Products location for availability. Freight terms may vary for non commonly stocked items. See latest Technical Data Sheets for specific Approvals, Listings, Design Parameters & available finishes. Prices subject to change without notice.

Section 16 Specialty Items
Section 18 Grooved Product
Section 19 CPVC Pipe & Fittings
Section 20 Miscellaneous
Section 21 Electrical
Section C Valves & Hose Equipment
Section D Backflow
Section F Pipe & Accessories
Section H Hangers
Section J Lubricants
Section K Misc.

Ames		
Description	Part Number	List Price
Model 300B Brass Assembly (w/O.S.&Y. Valve)		
2"	21549	\$5,514.00
Model 400B Brass Reduced Pressure Backflow Assembly (With Ball Valve)		
1/2"	21016	\$521.50
3/4"	21017	\$548.50
1"	21018	\$579.00
1 1/4"	21019	\$1,050.00
1 1/2"	21021	\$1,111.00
2"	21022	\$1,209.00
Model 400B Brass Reduced Pressure Backflow Assembly (Less Ball Valve)		
1/2"	21029	\$499.00
3/4"	21030	\$511.00
1"	21031	\$530.50
1 1/4"	21032	\$868.50
1 1/2"	21033	\$1,014.00
2"	21034	\$1,069.00
Model 2000 SS Double Check Backflow Assembly (Less Gate Valves)		
2 1/2"	20700	\$1,675.00
3"	20701	\$1,915.00
4"	20702	\$2,683.00
6"	20703	\$4,354.00
8"	20897	\$8,952.00
10"	20705	\$12,673.00
Model 2000 SS Double Check Backflow Assembly (w/O.S.&Y. Valves)		
2 1/2"	20550	\$2,990.00
3"	20551	\$3,126.00
4"	20552	\$3,707.00
6"	20553	\$5,961.00
8"	20719	\$10,704.00
10"	20555	\$16,222.00
Model 3000 SS Double Check Detector Backflow Assembly (Less Gate Valves)		
2 1/2"	20729	\$3,451.00
3"	20730	\$3,624.00
4"	20731	\$3,698.00
6"	20732	\$5,782.00
8"	20898	\$10,974.00
10"	20734	\$13,394.00

Ames		
Description	Part Number	List Price
Model 3000 SS Double Check Detector Backflow Assembly (w/O.S.&Y. Valves)		
2 1/2"	20549	\$3,971.00
3"	20548	\$4,224.00
4"	20558	\$4,543.00
6"	20559	\$6,911.00
8"	20539	\$12,733.00
10"	20561	\$18,382.00
Model 4000 SS Reduced Pressure Backflow Prevention Assembly (Less Gate Valves)		
2 1/2"	20757	\$2,976.00
3"	20758	\$3,091.00
4"	20759	\$4,027.00
6"	20760	\$6,527.00
8"	20761	\$12,516.00
10"	20762	\$18,681.00
Model 4000 SS Reduced Pressure Backflow Prevention Assembly (w/O.S.&Y. Valves)		
2 1/2"	20767	\$3,771.00
3"	20768	\$3,998.00
4"	20769	\$4,798.00
6"	20770	\$7,744.00
8"	20771	\$15,183.00
10"	20772	\$22,040.00
Model 5000 SS Reduced Pressure Detector Assembly (Less Gate Valves)		
2 1/2"	20822	\$4,218.00
3"	20823	\$4,318.00
4"	20824	\$5,260.00
6"	20826	\$7,577.00
Model 5000 SS Reduced Pressure Detector Assembly (w/O.S.&Y. Valves)		
2 1/2"	20832	\$5,633.00
3"	20833	\$5,813.00
4"	20834	\$6,165.00
6"	20836	\$9,193.00
Air Gap Drains		
Horiz.Air Gap Drain (A113-960)	20788	\$371.50
Silver Bullet Vertical (A113-963)	20839	\$1,230.00
Old Style (Non S.S) (3-1039)	20787	\$1,923.00
Maxim/Colt Air Gap Drain		
2 1/2" - 10"	207880	\$404.00

*See latest Technical Data Sheets for specific Approvals, Listings, Design Parameters & available finishes. Sprinkler heads & escutcheons are priced separately unless otherwise noted. Items marked "C.O." are made to order and may require longer delivery times.

Colt		
Description	Part Number	List Price
Model C200 Double Check Assembly (w/ FxG O.S.&Y. Valves)		
2 1/2"	205502	\$2,726.00
3"	205512	\$2,994.00
4"	205522	\$3,470.00
6"	205532	\$5,579.00
8"	207192	\$10,102.00
Model C200 Double Check Assembly (w/ Grooved Butterfly Valves)		
2 1/2"	205503	\$3,364.00
3"	205513	\$3,614.00
4"	205523	\$4,177.00
6"	205533	\$6,727.00
8"	207193	\$12,204.00
Model C300 Double Check Detector Assembly (w/ FxG O.S.&Y. Valves)		
2 1/2"	205492	\$3,779.00
3"	205482	\$3,890.00
4"	205582	\$4,178.00
6"	205592	\$6,229.00
8"	205392	\$12,288.00
Model C300 Double Check Detector Assembly (w/ Grooved Butterfly Valves)		
2 1/2"	205493	\$4,651.00
3"	205483	\$4,752.00
4"	205583	\$5,150.00
6"	205593	\$7,822.00
8"	205393	\$15,177.00
Model C400 Reduced Pressure Assembly (w/ FxG O.S.&Y. Valves)		
2 1/2"	207672	\$3,396.00
3"	207682	\$3,601.00
4"	207692	\$4,308.00
6"	207702	\$7,011.00
8"	207712	\$13,629.00
Model C500 Reduced Pressure Detector Assembly (w/ FxG O.S.&Y. Valves)		
2 1/2"	208322	\$4,869.00
3"	208332	\$5,179.00
4"	208342	\$5,606.00
6"	208362	\$8,325.00
8"	208382	\$15,025.00

Febco		
Description	Part Number	List Price
Model 850 Double Check Assembly (w/ O.S.&Y. Valves)		
2 1/2"	90610	\$3,677.00
3"	90611	\$3,737.00
4"	90612	\$4,806.00
6"	90613	\$6,888.00
8"	90614	\$12,855.00
Model 870V (Vertical) Double Check Assembly (w/ O.S.&Y. Valves)		
2 1/2"	90620	\$4,098.00
3"	90621	\$4,219.00
4"	90622	\$5,526.00
6"	90623	\$7,871.00
8"	90624	\$14,151.00
10"	90625	\$20,980.00
Model 856 Double Check Detector Assembly (w/ O.S.&Y. Valves)		
2 1/2"	90641	\$4,923.00
3"	90642	\$4,908.00
4"	90643	\$5,054.00
6"	90644	\$7,758.00
8"	90645	\$12,628.00

Section 16	Specialty Items
Section 18	Grooved Product
Section 19	CPVC Pipe & Fittings
Section 20	Miscellaneous
Section 21	Electrical
Section C	Valves & Hose Equipment
Section D	Backflow
Section F	Pipe & Accessories
Section H	Hangers
Section J	Lubricants
Section K	Misc.

Items shown on this sheet may not be stocked at all Tyco Fire Products warehouses. Please ask your local Tyco Fire Products location for availability. Freight terms may vary for non commonly stocked items. See latest Technical Data Sheets for specific Approvals, Listings, Design Parameters & available finishes. Prices subject to change without notice.

Section 16
Specialty Items

Section 18
Grooved Product

Section 19
CPVC Pipe & Fittings

Section 20
Miscellaneous

Section 21
Electrical

Section C
Valves & Hose Equipment

Section D
Backflow

Section F
Pipe & Accessories

Section H
Hangers

Section J
Lubricants

Section K
Misc.

Febco		
Description	Part Number	List Price
Model 876V (Vertical) Double Check Detector Assembly (w/ O.S.&Y. Valves)		
2 1/2"	90650	\$5,552.00
3"	90651	\$5,778.00
4"	90652	\$6,139.00
6"	90653	\$9,145.00
8"	90654	\$16,387.00
10"	90655	\$23,019.00
Model 860 Reduced Pressure Assembly (w/ O.S.&Y. Valves)		
2 1/2"	90671	\$4,116.00
3"	90672	\$4,422.00
4"	90673	\$6,073.00
6"	90674	\$8,711.00
8"	90675	\$15,608.00
Model 880V Reduced Pressure Assembly (w/ O.S.&Y. Valves)		
2 1/2"	90680	\$4,708.00
3"	90681	\$5,000.00
4"	90682	\$6,596.00
6"	90683	\$10,083.00
8"	90684	\$18,563.00
10"	90685	\$25,874.00
Model 826 Reduced Pressure Detector Assembly (w/ O.S.&Y. Valves)		
2 1/2"	90695	\$5,950.00
3"	90696	\$6,302.00
4"	90697	\$7,735.00
6"	90698	\$10,839.00
8"	90699	\$18,309.00
10"	90701	\$24,417.00
Model 850U Double Check Assembly (w/ Union End - Ball Valves)		
1"	90733	\$381.50
1 1/4"	90734	\$761.50
1 1/2"	90735	\$800.00
2"	90736	\$917.50

Febco		
Description	Part Number	List Price
Model 850 Double Check Assembly (w/ Ball Valves)		
1"	92733	\$306.50
1 1/4"	92734	\$597.00
1 1/2"	92735	\$627.50
2"	92736	\$749.00
Model 860 Reduced Pressure Assembly (w/ Union End - Ball Valves)		
1"	91733	\$746.50
1 1/4"	91734	\$1,211.00
1 1/2"	91735	\$1,374.00
2"	91736	\$1,463.00
Model 825Y Reduced Pressure Assembly		
2"	90765	\$1,243.00
Air Gap Drains		
M 2 1/2"-10"	90725	\$644.50
AGD 2 1/2"-10"	90726	\$483.50
601 1 1/4"-2"	91725	\$74.50

*See latest Technical Data Sheets for specific Approvals, Listings, Design Parameters & available finishes. Sprinkler heads & escutcheons are priced separately unless otherwise noted. Items marked "C.O." are made to order and may require longer delivery times.

Wilkins		
Description	Part Number	List Price
Model 310 Single Check Valve Assembly (FxF)		
310 DCV FxF 4"	3104000	\$1,237.00
310 DCV FxF 6"	3106000	\$1,757.00
310 DCV FxF 8"	3108000	\$3,414.00
Model 310A Single Check Valve Assembly (w/ Metered Bypass Assembly)		
310DA DCV W/BYPASS 4"	3104001	\$2,178.00
310DA DCV W/BYPASS 6"	3106001	\$2,801.00
310DA DCV W/BYPASS 8"	3108001	\$4,732.00
Model 350AB Double Check Valve (w/ Grooved Butterfly Valves)		
350AB DCV W/GR BFV 2-1/2"	3501250	\$3,194.00
350AB DCV W/GR BFV 3"	3501300	\$3,148.00
350AB DCV W/GR BFV 4"	3501400	\$3,747.00
350AB DCV W/GR BFV 6"	3501600	\$5,851.00
350AB DCV W/GR BFV 8"	3501800	\$10,958.00
Model 350A Double Check Valve (w/ O.S.&Y. Valves, FxF)		
350A DC W/ OSY FxF 2-1/2"	350250	\$2,792.00
350A DC W/OSY FxF 3"	350300	\$2,909.00
350A DC W/OSY FxF 4"	350400	\$3,438.00
350A DC W/OSY FxF 6"	350600	\$5,372.00
350A DC W/OSY FxF 8"	350800	\$10,093.00
350A DC W/OSY FxF 10"	350100	\$15,249.00
Model 350ADA Double Check Detector (w/ O.S.&Y. Valves, FxG)		
350ADAG DCDA W/FXG OSY 2.5 (CFM)	3501251	\$3,719.00
350ADAG DCDA W/FXG OSY 3(CFM)	3501301	\$3,932.00
350ADAG DCDA W/FXG OSY 4(CFM)	3501401	\$4,257.00
350ADAG DCDA W/FXG OSY 6(CFM)	3501601	\$6,374.00
350ADAG DCDA W/FXG OSY 8(CFM)	3501801	\$11,854.00
Model 350ADA Double Check Detector (w/ Grooved Butterfly Valves)		
350ADA DCDA W/BFV 2-1/2" (GPM)	3501252	\$4,055.00
350ADA DCDA W/BFV 3" (GPM)	3501302	\$4,291.00
350ADA DCDA W/BFV 4" (GPM)	3501402	\$4,604.00
350ADA DCDA W/BFV 6" (GPM)	3501602	\$6,922.00
350ADA DCDA W/BFV 8" (GPM)	3501802	\$13,291.00

Wilkins		
Description	Part Number	List Price
Model 350ADA Double Check Detector (w/ Grooved Butterfly Valves)		
350ADA DCDA W/BFV 2-1/2 (CFM)	3501253	\$4,055.00
350ADA DCDA W/BFV 3" (CFM)	3501303	\$4,291.00
350ADA DCDA W/BFV 4" (CFM)	3501403	\$4,604.00
350ADA DCDA W/BFV 6" (CFM)	3501603	\$6,922.00
350ADA DCDA W/BFV 8" (CFM)	3501803	\$13,291.00
Model 350ADA Double Check Detector (w/ O.S.&Y. Valves, FxF)		
350ADA DCDA W/OSY FxF 2-1/2"	3501254	\$3,719.00
350ADA DCDA W/OSY FxF 3"	3501304	\$3,932.00
350ADA DCDA W/OSY FxF 4"	3501404	\$4,257.00
350ADA DCDA W/OSY FxF 6"	3501604	\$6,374.00
350ADA DCDA W/OSY FxF 8"	3501804	\$11,854.00
350ADA DCDA W/OSY FxF 10"	3501104	\$17,319.00
Model 375 Reduced Pressure Principle (w/ O.S.&Y. Valves, FxG)		
375A RPA W/FXG OSY VLV 2-1/2"	3751250	\$3,465.00
375A RPA W/FXG OSY VLV 3"	3751300	\$3,604.00
375A RPA W/FXG OSY VLV 4"	3751400	\$4,396.00
375A RPA W/FXG OSY VLV 6"	3751600	\$7,114.00
375A RPA W/FXG OSY VLV 8"	3751800	\$13,951.00
Model 375ADA Reduced Pressure Detector Assembly (w/ O.S.&Y. Valves, FxG)		
375ADA RPDA W/FXG OSY 2-1/2 (GPM)	3751251	\$4,929.00
375ADA RPDA W/FXG OSY 3 (GPM)	3751301	\$5,257.00
375ADA RPDA W/FXG OSY 4 (GPM)	3751401	\$5,651.00
375ADA RPDA W/FXG OSY 6 (GPM)	3751601	\$8,069.00
375ADA RPDA W/FXG OSY 8 (GPM)	3751801	\$15,342.00
Model 375ADA Reduced Pressure Detector Assembly (w/ O.S.&Y. Valves, FxG)		
375ADA RPDA W/FXG OSY 2-1/2 (CFM)	3751252	\$4,929.00
375ADA RPDA W/FXG OSY 3 (CFM)	3751302	\$5,257.00
375ADA RPDA W/FXG OSY 4 (CFM)	3751402	\$5,651.00
375ADA RPDA W/FXG OSY 6 (CFM)	3751602	\$8,069.00
375ADA RPDA W/FXG OSY 8 (CFM)	3751802	\$15,342.00
Model 375ADA Reduced Pressure Detector Assembly (w/ Grooved Butterfly Valves)		
375ADA RPDA W/BFV 2-1/2 (GPM)	3751253	\$5,361.00
375ADA RPDA W/BFV 3 (GPM)	3751303	\$5,694.00
375ADA RPDA W/BFV 4 (GPM)	3751403	\$6,091.00
375ADA RPDA W/BFV 6 (GPM)	3751603	\$8,628.00
375ADA RPDA W/BFV 8 (GPM)	3751803	\$16,663.00

Section 16	Specialty Items
Section 18	Grooved Product
Section 19	CPVC Pipe & Fittings
Section 20	Miscellaneous
Section 21	Electrical
Section C	Valves & Hose Equipment
Section D	Backflow
Section F	Pipe & Accessories
Section H	Hangers
Section J	Lubricants
Section K	Misc.

Items shown on this sheet may not be stocked at all Tyco Fire Products warehouses. Please ask your local Tyco Fire Products location for availability. Freight terms may vary for non commonly stocked items. See latest Technical Data Sheets for specific Approvals, Listings, Design Parameters & available finishes. Prices subject to change without notice.

Section 16
Specialty Items

Section 18
Grooved Product

Section 19
CPVC Pipe & Fittings

Section 20
Miscellaneous

Section 21
Electrical

Section C
Valves & Hose Equipment

Section D
Backflow

Section F
Pipe & Accessories

Section H
Hangers

Section J
Lubricants

Section K
Misc.

Wilkins		
<i>Description</i>	<i>Part Number</i>	<i>List Price</i>
Model 375ADA Reduced Pressure Detector Assembly (w/ Grooved Butterfly Valves)		
375ADA RPDA W/BFV 2-1/2" (CFM)	3751254	\$5,361.00
375ADA RPDA W/BFV 3" (CFM)	3751304	\$5,694.00
375ADA RPDA W/BFV 4" (CFM)	3751404	\$6,091.00
375ADA RPDA W/BFV 6" (CFM)	3751604	\$8,628.00
375ADA RPDA W/BFV 8" (CFM)	3751804	\$16,663.00
Model 375ADA Reduced Pressure Detector Assembly (w/ O.S.&Y. Valves, FxF)		
375ADA RPDA W/OSY FxF 2-1/2"	3751256	\$4,929.00
375ADA RPDA W/OSY FxF 3"	3751306	\$5,257.00
375ADA RPDA W/OSY FxF 4"	3751406	\$5,651.00
375ADA RPDA W/OSY FxF 6"	3751606	\$8,069.00
375ADA RPDA W/OSY FxF 8"	3751806	\$15,342.00
375ADA RPDA W/OSY FxF 10"	3751106	\$19,061.00
Model 375DAL Reduced Pressure Detector Assembly (w/ O.S.&Y. Valves, Flanged Body)		
375DAL RPDA L/OSY 2-1/2"	3751255	\$3,836.00
375DAL RPDA L/OSY 3"	3751305	\$3,905.00
375DAL RPDA L/OSY 4"	3751405	\$4,674.00
375DAL RPDA L/OSY 6"	3751605	\$6,648.00
375DAL RPDA L/OSY 8"	3751805	\$12,349.00
375DAL RPDA L/OSY 10"	3751105	\$17,478.00
Model 475 Reduced Pressure Principle (w/ Grooved Butterfly Valves)		
475 RPA W/BFV 4	475140	\$5,518.00
475 RPA W/BFV 6	475160	\$8,887.00
475 RPA W;/BFV 8	475180	\$17,720.00

Wilkins		
Model 950XL Double Check Valve Assembly (FNPT x FNPT Ends)		
950XL DCV L/BV 3/4"	73072	\$263.50
950XL DCV L/BV 1"	73073	\$302.00
950XL DCV L/BV 1-1/4"	73074	\$510.00
950XL DCV L/BV 1-1/2"	73075	\$595.00
950XL DCV L/BV 2"	73076	\$637.50
Model 975 Reduced Pressure Principle (FNPT x FNPT Ends)		
975XL RP L/BV 1/2"	73077	POA
975XL RP L/BV 3/4"	73078	\$493.50
975XL RP L/BV 1"	73079	\$552.50
975XL RP L/BV 1-1/4"	73080	\$905.50
975XL RP L/BV 1-1/2"	73081	\$1,050.00
975XL RP L/BV 2"	73082	\$1,100.00

*See latest Technical Data Sheets for specific Approvals, Listings, Design Parameters & available finishes. Sprinkler heads & escutcheons are priced separately unless otherwise noted. Items marked "C.O." are made to order and may require longer delivery times.

Watts Regulator		
Description	Part Number	List Price
Small Backflow Preventors		
Model 007 LF Double Check Backflow (Less Ball Valve)		
3/4"	20610	\$372.00
1"	20611	\$478.50
1 1/4"	206115	\$537.00
1 1/2"	20612	\$569.50
2"	20613	\$604.00
Model 007 QT Double Check Backflow (w/Ball Valve)		
3/4"	20614	\$323.00
1"	20615	\$363.50
1 1/4"	206155	\$582.50
1 1/2"	20616	\$681.50
2"	20617	\$803.00
Model 009 LF Reduced Pressure Backflow (Less Ball Valve)		
3/4"	20618	\$505.50
1"	20619	\$528.00
1 1/2"	20485	\$994.50
2"	20620	\$1,044.00
Model 009 QT Reduced Pressure Backflow (w/Ball Valve)		
3/4"	20621	\$540.00
1"	20449	\$579.00
1 1/4"	20450	\$882.50
1 1/2"	20451	\$1,095.00
2"	20452	\$1,184.00
Air Gap Drains		
909AGC	20473	\$121.00
909AGF	20438	\$672.50
Backflow Repair Kits		
RK009RT, 3/4" - 1	20478	\$119.00
RK009RT, 1 1/4" - 2"	20479	\$176.00
RK709RT, 3/4" - 1	20480	\$133.00
RK709RT, 1 1/2" - 3	20481	\$87.50
RK709RT, 2 1/2" - 3	20457	\$265.00
RK709RT, 6"	20430	\$505.00
RK709RT, 8"	20459	\$510.00
RK909RT, 2 1/2" - 3"	20460	\$709.50
RK909RT, 4"	20461	\$761.50
RK909RT, 6"	20813	\$2,187.00
RK909RT, 8"	20462	\$1,003.00

Watts Regulator		
Description	Part Number	List Price
Model 709 Double Check Valve Backflow Assembly (Less Gates)		
2 1/2"	20412	\$3,039.00
3"	20472	\$3,220.00
4"	20405	\$3,565.00
6"	20407	\$6,033.00
8"	20409	\$13,339.00
10"	20411A	\$15,297.00
Model 709 Double Check Valve Backflow Assembly (w/ OS&Y's)		
2 1/2"	20427	\$5,284.00
3"	20428	\$5,697.00
4"	20404	\$5,330.00
6"	20406	\$8,525.00
8"	20408	\$15,899.00
10"	20410	\$21,156.00
Model 007/709 Double Check Detector Assembly Backflow Preventor (Less Gates)		
2 1/2"	20698	\$4,131.00
3"	20634	\$5,552.00
3"	20636	\$4,521.00
4"	20490	\$5,731.00
6"	20491	\$10,104.00
8"	20492	\$14,711.00
10"	20635	\$17,616.00
Model 007/709 Double Check Detector Assembly Backflow Preventor (w/ OS&Y's)		
2 1/2"	20663	\$6,369.00
3"	20661	\$6,568.00
3"	20664	\$6,416.00
4"	20431	\$5,332.00
6"	20444	\$8,662.00
8"	20445	\$16,960.00
10"	20662	\$21,777.00
Model 009/909 Reduced Pressure Zone Backflow Preventor (Less Gates)		
2 1/2"	20641	\$4,028.00
2 1/2"	20471	\$4,792.00
3"	20642	\$4,218.00
3"	20470	\$5,252.00
4"	20415	\$5,732.00
6"	20417	\$7,995.00
8"	20419	\$14,109.00
10"	20422	\$21,350.00

Section 16	Specialty Items
Section 18	Grooved Product
Section 19	CPVC Pipe & Fittings
Section 20	Miscellaneous
Section 21	Electrical
Section C	Valves & Hose Equipment
Section D	Backflow
Section F	Pipe & Accessories
Section H	Hangers
Section J	Lubricants
Section K	Misc.

Items shown on this sheet may not be stocked at all Tyco Fire Products warehouses. Please ask your local Tyco Fire Products location for availability. Freight terms may vary for non commonly stocked items. See latest Technical Data Sheets for specific Approvals, Listings, Design Parameters & available finishes. Prices subject to change without notice.

Section 16	Specialty Items
Section 18	Grooved Product
Section 19	CPVC Pipe & Fittings
Section 20	Miscellaneous
Section 21	Electrical
Section C	Valves & Hose Equipment
Section D	Backflow
Section F	Pipe & Accessories
Section H	Hangers
Section J	Lubricants
Section K	Misc.

Watts Regulator		
<i>Description</i>	<i>Part Number</i>	<i>List Price</i>
Model 009/909 Reduced Pressure Zone Backflow Preventor (w/ OS&Y's)		
2 ¹ / ₂ "	20670	\$5,051.00
2 ¹ / ₂ "	20669	\$6,183.00
3"	20671	\$5,291.00
3"	20432	\$6,785.00
4"	20414	\$6,046.00
6"	20416	\$9,732.00
8"	20418	\$18,542.00
10"	20420	\$26,224.00
Model 909 Reduced Pressure Zone Backflow Detector Assembly (Less Gates)		
2 ¹ / ₂ "	206761	\$4,916.00
3"	20647	\$5,808.00
4"	20475	\$6,272.00
6"	20476	\$9,091.00
8"	20477	\$17,021.00
10"	20648	\$21,697.00
Model 909 Reduced Pressure Zone Backflow Detector Assembly (w/ OS&Y's)		
3"	20676	\$7,636.00
4"	20677	\$8,024.00
6"	20678	\$12,275.00
8"	20679	\$17,554.00
10"	20680	\$24,155.00

*See latest Technical Data Sheets for specific Approvals, Listings, Design Parameters & available finishes. Sprinkler heads & escutcheons are priced separately unless otherwise noted. Items marked "C.O." are made to order and may require longer delivery times.

SCI Coop-Let F.T.		
<i>Part No.</i>	<i>Size / Description</i>	<i>List Price</i>
251100	SCI Coop-Let F.T. 1/2" x 1"-1 1/2	\$8.20
251120	SCI Coop-Let F.T. 1/2" x 2"-2 1/2	\$8.20
251130	SCI Coop-Let F.T. 1/2" x 3" - 8	\$8.20
251140	SCI Coop-Let F.T. 3/4" x 1"-1 1/2	\$8.20
251150	SCI Coop-Let F.T. 3/4" x 2"-2 1/2	\$8.20
251160	SCI Coop-Let F.T. 3/4" x 2 1/2	\$8.20
251170	SCI Coop-Let F.T. 3/4" x 3" - 8	\$8.20
251180	SCI Coop-Let F.T. 1" x 1 1/4"-1 1/2	\$11.50
251190	SCI Coop-Let F.T. 1" x 2"-2 1/2	\$11.50
251200	SCI Coop-Let F.T. 1" x 2 1/2	\$11.50
251210	SCI Coop-Let F.T. 1" x 3" - 4	\$11.50
251220	SCI Coop-Let F.T. 1" x 5" - 8	\$11.50
251230	SCI Coop-Let F.T. 1 1/4" x 1 1/2	\$18.00
251240	SCI Coop-Let F.T. 1 1/4" x 2	\$18.00
251250	SCI Coop-Let F.T. 1 1/4" x 2 1/2	\$18.00
251260	SCI Coop-Let F.T. 1 1/4" x 3" - 4	\$18.00
251270	SCI Coop-Let F.T. 1 1/4" x 5" - 8	\$18.00
251280	SCI Coop-Let F.T. 1 1/2" x 2	\$23.25
251290	SCI Coop-Let F.T. 1 1/2" x 2 1/2	\$23.25
251300	SCI Coop-Let F.T. 1 1/2" x 3	\$23.25
251310	SCI Coop-Let F.T. 1 1/2" x 4"- 5	\$23.25
251320	SCI Coop-Let F.T. 1 1/2" x 6"- 8	\$23.25
251330	SCI Coop-Let F.T. 2" x 2 1/2	\$31.25
251340	SCI Coop-Let F.T. 2" x 3	\$31.25
251350	SCI Coop-Let F.T. 2" x 4"- 5	\$31.25
251360	SCI Coop-Let F.T. 2" x 6"- 8	\$31.25
251370	SCI Coop-Let F.T. 2 1/2" x 3	\$53.00
251380	SCI Coop-Let F.T. 2 1/2" x 4	\$53.00
251390	SCI Coop-Let F.T. 2 1/2" x 6	\$53.00
251400	SCI Coop-Let F.T. 2 1/2" x 8	\$53.00
251410	SCI Coop-Let F.T. 3" x 4	\$102.50
251420	SCI Coop-Let F.T. 3" x 6	\$102.50
251430	SCI Coop-Let F.T. 3" x 8	\$102.50
251440	SCI Coop-Let F.T. 4" x 6	\$162.00
251450	SCI Coop-Let F.T. 4" x 8	\$162.00

SCI Coop-Let Grooved		
<i>Part No.</i>	<i>Size / Description</i>	<i>List Price</i>
251460	SCI Coop-Let Grvd 1 1/4" x 1 1/2	\$20.50
251470	SCI Coop-Let Grvd 1 1/4" x 2	\$20.50
251480	SCI Coop-Let Grvd 1 1/4" x 2 1/2	\$20.50
251490	SCI Coop-Let Grvd 1 1/4" x 3	\$20.50
251500	SCI Coop-Let Grvd 1 1/4" x 4"- 5	\$20.50
251510	SCI Coop-Let Grvd 1 1/4" x 6	\$20.50
251520	SCI Coop-Let Grvd 1 1/4" x 8	\$20.50
251530	SCI Coop-Let Grvd 1 1/2" x 2	\$23.50
251540	SCI Coop-Let Grvd 1 1/2" x 2 1/2	\$23.50
251550	SCI Coop-Let Grvd 1 1/2" x 3	\$23.50
251560	SCI Coop-Let Grvd 1 1/2" x 4"- 5	\$23.50
251570	SCI Coop-Let Grvd 1 1/2" x 6	\$23.50
251580	SCI Coop-Let Grvd 1 1/2" x 8	\$23.50
251590	SCI Coop-Let Grvd 2" x 2 1/2	\$25.50
251600	SCI Coop-Let Grvd 2" x 3	\$25.50
251610	SCI Coop-Let Grvd 2" x 4"- 5	\$25.50
251620	SCI Coop-Let Grvd 2" x 6	\$25.50
251630	SCI Coop-Let Grvd 2" x 8	\$25.50
251640	SCI Coop-Let Grvd 2 1/2" x 3	\$29.50
251650	SCI Coop-Let Grvd 2 1/2" x 4	\$29.50
251660	SCI Coop-Let Grvd 2 1/2" x 6	\$29.50
251670	SCI Coop-Let Grvd 2 1/2" x 8	\$29.50
251680	SCI Coop-Let Grvd 3" x 4	\$39.50
251690	SCI Coop-Let Grvd 3" x 6	\$39.50
251700	SCI Coop-Let Grvd 3" x 8	\$39.50
251710	SCI Coop-Let Grvd 4" x 6	\$70.50
251720	SCI Coop-Let Grvd 4" x 8	\$70.50
251730	SCI Coop-Let Grvd 6" x 8	\$164.00

Section 16	Specialty Items
Section 18	Grooved Product
Section 19	CPVC Pipe & Fittings
Section 20	Miscellaneous
Section 21	Electrical
Section C	Valves & Hose Equipment
Section D	Backflow
Section F	Pipe & Accessories
Section H	Hangers
Section J	Lubricants
Section K	Misc.

Items shown on this sheet may not be stocked at all Tyco Fire Products warehouses. Please ask your local Tyco Fire Products location for availability. Freight terms may vary for non commonly stocked items. See latest Technical Data Sheets for specific Approvals, Listings, Design Parameters & available finishes. Prices subject to change without notice.

Section 16
Specialty Items

Section 18
Grooved Product

Section 19
CPVC Pipe & Fittings

Section 20
Miscellaneous

Section 21
Electrical

Section C
Valves & Hose Equipment

Section D
Backflow

Section F
Pipe & Accessories

Section H
Hangers

Section J
Lubricants

Section K
Misc.

Merit		
<i>Size/Description</i>	<i>Part No.</i>	<i>List Price</i>
Grooved Outlets – Sch. 40		
Tee-Let 1 ¹ / ₄ " x 1 ¹ / ₄ "	15250	\$22.00
Tee-Let 1 ¹ / ₂ " x 1 ¹ / ₂ "	15500	\$23.75
Tee-Let 2" x 2"	15750	\$26.00
Tee-Let 2 ¹ / ₂ " x 2 ¹ / ₂ "	16100	\$36.75
Tee-Let 3" x 3"	16400	\$48.00
Tee-Let 4" x 4"	16700	\$75.00
Tee-Let 6" x 6"	16900	\$151.50
Tee-Let 8" x 8"	17000	\$191.50
Grooved Outlets – Sch. 10		
Tee-Let 2 ¹ / ₂ " x 2 ¹ / ₂ ", Sch. 10	17025	\$32.00
Tee-Let 3" x 3", Sch. 10	17031	\$42.50
Tee-Let 4" x 4", Sch. 10	17037	\$63.00
Tee-Let 6" x 6", Sch. 10	17044	\$125.50
Adjustable Drop Nipples		
<i>Size/Description</i>	<i>Part No.</i>	<i>List Price</i>
1" x ¹ / ₂ ", 4.1" – 5.1", Model #M1.150	3201	\$30.75
1" x ¹ / ₂ ", 6.1" – 9.1", Model #M3.150	3202	\$40.50
1" x ¹ / ₂ ", 3.5" – 4.5", Model #F1.150	3204	\$31.50
1" x ¹ / ₂ ", 4.5" – 6.5", Model #F2.150	3205	\$31.50
1" x ¹ / ₂ ", 5.5" – 8.5", Model #F3.150	3206	\$35.25
1" x ³ / ₄ ", 6.82" – 10", Model #F3.175	3207	\$40.50
Welded Flange		
<i>Size</i>	<i>Part No.</i>	<i>List Price</i>
2"	41001	\$74.00
2 ¹ / ₂ "	41002	\$101.50
3"	41003	\$124.00
4"	41004	\$150.00
6"	41006	\$224.00
8"	41008	\$345.00
10"	41010	\$587.00
12"	41011	\$804.00

Flexhead		
Flexible Drop Nipples		
<i>Size/Description</i>	<i>Part No.</i>	<i>Net Price</i>
#2024 1 ¹ / ₂ " x 24"	88100	\$28.25
#2024 3 ³ / ₄ " x 24"	88105	\$28.25
#2036 1 ¹ / ₂ " x 36"	88101	\$32.50
#2036 3 ³ / ₄ " x 36"	88106	\$32.50
#2048 1 ¹ / ₂ " x 48"	88102	\$36.75
#2048 3 ³ / ₄ " x 48"	88107	\$36.75
#2060 1 ¹ / ₂ " x 60"	88103	\$40.75
#2060 3 ³ / ₄ " x 60"	88108	\$40.75
#2072 1 ¹ / ₂ " x 72"	88104	\$45.25
#2072 3 ³ / ₄ " x 72"	88109	\$45.25

SprinkFlex		
Flexible Drop Nipples		
<i>Size/Description</i>	<i>Part No.</i>	<i>Net Price</i>
SFN28H 1/2" NPT x 28" Unbraided	88111N	\$24.50
SFN28T 3/4" NPT x 28" Unbraided	88112N	\$24.50
SFN40H 1/2" NPT x 40" Unbraided	88113N	\$26.00
SFN40T 3/4" NPT x 40" Unbraided	88114N	\$26.00
SFN48H 1/2" NPT x 48" Unbraided	88115N	\$27.75
SFN48T 3/4" NPT x 48" Unbraided	88116N	\$27.75
SFN59H 1/2" NPT x 59" Unbraided	88117N	\$30.00
SFN59T 3/4" NPT x 59" Unbraided	88118N	\$30.00
SFN71H 1/2" NPT x 71" Unbraided	88119N	\$32.75
SFN71T 3/4" NPT x 71" Unbraided	88120N	\$32.75
SFB28H 1/2" NPT x 28 Braided	88121B	\$30.75
SFB28T 3/4" NPT x 28 Braided	88122B	\$30.75
SFB40H 1/2" NPT x 40" Braided	88123B	\$34.25
SFB40T 3/4" NPT x 40" Braided	88124B	\$34.25
SFB48H 1/2" NPT x 48 Braided	88125B	\$37.00
SFB48T 3/4" NPT x 48 Braided	88126B	\$37.00
SFB59H 1/2" NPT x 59" Braided	88127B	\$40.50
SFB59T 3/4" NPT x 59" Braided	88128B	\$40.50
SFB71H 1/2" NPT x 71" Braided	88129B	\$44.00
SFB71T 3/4" NPT x 71 Braided	88130B	\$44.00

*See latest Technical Data Sheets for specific Approvals, Listings, Design Parameters & available finishes. Sprinkler heads & escutcheons are priced separately unless otherwise noted. Items marked "C.O." are made to order and may require longer delivery times.

Test/Drain Assemblies		
<i>Size/Description</i>	<i>Part No.</i>	<i>List Price</i>
1" "Sure Test"	2391	\$335.50
1 1/4" "Sure Test"	2399	\$404.00
1" #132 Inspection Test w/ Prv	21232	\$166.00

Sight Drains		
<i>Size/Description</i>	<i>Part No.</i>	<i>List Price</i>
1" Sight Drain	2285	\$76.50
1 1/4" Sight Drain	2286	\$92.50
1 1/2" Sight Drain	2287	\$74.25
2" Sight Drain	2288	\$132.50
1" Sight Drain w/ 1/2" orifice	2292	\$60.25
1" x 1/2" Orifice Union	2293	\$42.25

#71 Flange Adapter - Bolt, Nut, Gasket Kits		
<i>Size</i>	<i>Part No.</i>	<i>List Price</i>
2"	50240	See Section 18 for current list prices
2 1/2"	50241	
3"	50242	
4"	50243	
5"	50248	
6"	50244	
8"	50245	
10"	50246	
12"	50247	

Red Rubber Gaskets		
<i>Size</i>	<i>Part No.</i>	<i>List Price</i>
2"	50220	\$1.15
2 1/2"	50208	\$1.55
3"	50209	\$1.85
4"	50210	\$2.60
5"	50225	\$3.30
6"	50211	\$4.25
8"	50212	\$5.15
10"	50217	\$6.40
12"	50219	\$9.35

Split One			
Split Rings Plastic Floor and Ceiling Plates Chrome (Plastic)			
<i>box qty.</i>	<i>Size</i>	<i>Part No.</i>	<i>List Price</i>
12	1/2"	1430	\$1.30
12	1"	1432	\$1.35
12	1 1/4"	1433	\$2.00
12	1 1/2"	1434	\$2.15
12	2"	1435	\$2.35
12	2 1/2"	1436	\$5.35
12	3"	1437	\$5.50
6	6"	1440	\$12.00
6	8"	1441	\$22.50
Split Rings Plastic Floor and Ceiling Plates White (Plastic)			
<i>box qty.</i>	<i>Size</i>	<i>Part No.</i>	<i>List Price</i>
12	1"	1420	\$0.90
12	1 1/4"	1421	\$0.90
12	1 1/2"	1422	\$1.00
12	2"	1423	\$1.05
12	2 1/2"	1424	\$2.10
12	3"	1425	\$2.20
12	4"	1426A	\$2.30
6	6"	1428	\$7.30

Section 16	Specialty Items
Section 18	Grooved Product
Section 19	CPVC Pipe & Fittings
Section 20	Miscellaneous
Section 21	Electrical
Section C	Valves & Hose Equipment
Section D	Backflow
Section F	Pipe & Accessories
Section H	Hangers
Section J	Lubricants
Section K	Misc.

Items shown on this sheet may not be stocked at all Tyco Fire Products warehouses. Please ask your local Tyco Fire Products location for availability. Freight terms may vary for non commonly stocked items. See latest Technical Data Sheets for specific Approvals, Listings, Design Parameters & available finishes. Prices subject to change without notice.

Section 16
Specialty Items

Section 18
Grooved Product

Section 19
CPVC Pipe & Fittings

Section 20
Miscellaneous

Section 21
Electrical

Section C
Valves & Hose Equipment

Section D
Backflow

Section F
Pipe & Accessories

Section H
Hangers

Section J
Lubricants

Section K
Misc.

Flanged Fittings		
Flanged 90° Elbow		
Size	Part No.	List Price
2 1/2"	500000	\$319.50
3"	500001A	\$298.00
4"	500002A	\$393.00
6"	500003A	\$628.50
8"	500004A	\$931.00
10"	500005A	\$1,797.00
12"	500006	\$2,584.00
Flanged 45° Elbow		
Size	Part No.	List Price
2 1/2"	500007	\$357.00
3"	500008	\$566.00
4"	500009	\$594.00
6"	500010A	\$679.50
8"	500011A	\$1,459.00
10"	500012A	\$3,064.00
12"	500013A	\$4,683.00
Flanged Straight Tee		
Size	Part No.	List Price
2 1/2"	500014A	\$472.50
3"	500015A	\$466.00
4"	500016A	\$803.00
6"	500017	\$972.50
8"	500018	\$1,408.00
10"	500019	\$4,066.00
12"	500020	\$6,404.00
Flanged Reducing Tee		
Size	Part No.	List Price
4" x 2 1/2"	500083	\$731.00
4" x 3"	500036	\$823.00
6" x 3"	500037	\$1,125.00
6" x 4"	500038	\$1,047.50
8" x 4"	500041	\$1,764.00
8" x 6"	500042A	\$1,642.00
6" x 4" x 4"	500039	\$1,675.00
6" x 4" x 6"	500040	\$1,675.00
8" x 6" x 6"	500043A	\$2,655.00
8" x 6" x 8"	500044	\$2,695.00
10" x 4"	500045	\$2,489.00
10" x 6"	500046	\$4,970.00
10" x 8"	500047	\$2,715.00
12" x 4"	500048	\$4,148.00
12" x 6"	500049	\$4,148.00
12" x 8"	500050	\$4,148.00
12" x 10"	500051	\$7,483.00

Flanged Fittings		
Cast Iron Companion Flange		
Size	Part No.	List Price
2" x 6"	86710	\$45.75
2 1/2" x 7"	86711	\$66.50
3" x 7 1/2"	86712	\$85.00
4" x 9"	86713	\$126.00
6" x 11"	86714	\$180.50
8" x 13 1/2"	86715	\$285.00
Flanged Concentric Reducer		
Size	Part No.	List Price
4" x 2 1/2"	500086	\$657.00
4" x 2"	500126	\$657.00
4" x 3"	500052	\$666.00
6" x 3"	500053	\$1,215.00
6" x 4"	500054	\$1,012.50
8" x 4"	500055	\$1,259.00
8" x 6"	500056	\$1,104.00
10" x 4"	500057	\$1,215.00
10" x 6"	500058	\$1,184.00
10" x 8"	500059	\$2,807.00
12" x 4"	500060	\$6,207.00
12" x 6"	500061	\$5,599.00
12" x 8"	500062	\$5,411.00
12" x 10"	500063	\$4,884.00
Blind Flange		
Size	Part No.	List Price
2 1/2"	500021	\$90.75
3"	500022A	\$94.00
4"	500023A	\$139.00
6"	500024A	\$345.00
8"	500025A	\$537.50
10"	500026A	\$595.50
12"	500027A	\$832.00
Long Radius Flanged 90° Elbow		
Size	Part No.	List Price
4"	500028	\$580.50
6"	500029	\$973.00
8"	500030	\$2,619.00
10"	500031	\$4,187.00
12"	500032A	\$3,844.00
Floor Flange		
Size	Part No.	List Price
1"	500110	\$41.25
1 1/4"	500111A	\$49.50
1 1/2"	500112A	\$63.00
2"	500113A	\$64.50

*See latest Technical Data Sheets for specific Approvals, Listings, Design Parameters & available finishes. Sprinkler heads & escutcheons are priced separately unless otherwise noted. Items marked "C.O." are made to order and may require longer delivery times.

Flanged Fittings		
Flanged Reducing 90° Elbow		
Size	Part No.	List Price
4" x 2 1/2"	500125A	\$1,058.50
4" x 3"	500064	\$895.00
6" x 4"	500065	\$1,031.50
8" x 6"	500066	\$1,520.00
Flanged Bull Tee		
4" x 4" x 6"	500067	\$2,674.00
Flanged Eccentric Reducer		
6" x 4"	500069	\$995.00
6" x 5"	500090	\$1,019.00
8" x 4"	500091	\$1,174.00
8" x 5"	500092	\$2,115.00
8" x 6"	500070	\$1,593.00

Ductile Iron Fittings			
#811 Ductile Iron 90° Elbows			
Size	Part No.	List Price	Box Qty.
1/2"	86206	\$4.65	240
3/4"	86205	\$4.75	120
1"	86200	\$6.05	70
1 1/4"	86201	\$8.35	40
1 1/2"	86202	\$12.75	30
2"	86203	\$20.50	20
2 1/2"	86204	\$40.75	10
#813 Ductile Iron 45° Elbows			
1/2"	86780	\$6.95	250
3/4"	86781	\$6.85	150
1"	86280	\$8.15	90
1 1/4"	86281	\$11.00	50
1 1/2"	86282	\$18.25	35
2"	86283	\$21.00	18
2 1/2"	86782	\$52.00	12
#814 Ductile Iron Tees			
1/2"	86340	\$6.90	150
3/4"	86341	\$8.25	90
1"	86230	\$7.60	60
1 1/4"	86231	\$14.00	35
1 1/2"	86232	\$18.00	24
2"	86233	\$24.75	12
2 1/2"	86234	\$61.25	8

Ductile Iron Fittings			
#818 Ductile Iron Couplings			
Size	Part No.	List Price	Box Qty.
1/2"	72779	\$3.15	360
3/4"	72778	\$3.80	200
1"	72755	\$4.95	110
1 1/4"	72754	\$7.35	75
1 1/2"	72753	\$10.35	60
2"	72752	\$15.50	30
2 1/2"	72758	\$29.75	18
#820 Ductile Iron Caps			
1/2"	72776	\$3.40	500
3/4"	72777	\$4.10	300
1"	72824	\$6.25	180
1 1/4"	72756	\$8.00	110
1 1/2"	72822	\$10.60	80
2"	72823	\$15.00	45
2 1/2"	72825	\$42.00	25
#817 Ductile Iron Crosses			
1"	86284	\$22.75	45
1 1/4"	86285	\$31.25	25
1 1/2"	86286	\$40.75	20
2"	86287	\$57.50	10
#719 Ductile Iron Plugs			
1/2"	86292	\$1.80	500
3/4"	86293	\$2.20	300
1"	86294	\$3.20	200
1 1/4"	86295	\$4.55	110
1 1/2"	86296	\$5.50	80
2"	86297	\$7.35	45
#825 Ductile Iron Extension Pieces			
1/2" x 1 1/2"	72751	\$7.40	300
1/2" x 2"	72980	\$7.35	250
3/4" x 1 1/2"	72981	\$10.80	250
3/4" x 2"	72982	\$11.00	200
#817 Ductile Iron Reducing Crosses			
1 1/4" x 1 1/4" x 1" x 1"	86289	\$31.25	30
1 1/2" x 1 1/2" x 1" x 1"	86322	\$40.75	24
2" x 2" x 1" x 1"	86291	\$59.25	10
#827 Ductile Iron Hex Bushings			
1" x 1 1/2"	72726	\$5.60	280
1" x 3/4"	72762	\$5.50	280
1 1/4" x 1"	72763	\$6.10	150
1 1/2" x 1"	72757	\$7.20	100
1 1/2" x 1 1/4"	72764	\$7.20	100
2" x 1"	72759	\$8.90	80
2" x 1 1/4"	72761	\$8.90	80
2" x 1 1/2"	72775	\$9.00	80

Section 16	Specialty Items
Section 18	Grooved Product
Section 19	CPVC Pipe & Fittings
Section 20	Miscellaneous
Section 21	Electrical
Section C	Valves & Hose Equipment
Section D	Backflow
Section F	Pipe & Accessories
Section H	Hangers
Section J	Lubricants
Section K	Misc.

Items shown on this sheet may not be stocked at all Tyco Fire Products warehouses. Please ask your local Tyco Fire Products location for availability. Freight terms may vary for non commonly stocked items. See latest Technical Data Sheets for specific Approvals, Listings, Design Parameters & available finishes. Prices subject to change without notice.

Section 16	Specialty Items
Section 18	Grooved Product
Section 19	CPVC Pipe & Fittings
Section 20	Miscellaneous
Section 21	Electrical
Section C	Valves & Hose Equipment
Section D	Backflow
Section F	Pipe & Accessories
Section H	Hangers
Section J	Lubricants
Section K	Misc.

Ductile Iron Fittings			
#816 Ductile Iron Reducing Couplings			
Size	Part No.	List Price	Box Qty.
3/4" x 1/2"	86772	\$4.30	150
1" x 1/2"	86228	\$6.35	140
1" x 3/4"	86229	\$8.70	120
#830 Ductile Iron Unions			
1/2"	86207	\$22.50	110
3/4"	86275	\$26.75	80
1"	86276	\$37.75	50
1 1/4"	86277	\$45.75	35
1 1/2"	86278	\$60.50	25
2"	86279	\$84.75	18
#812 Ductile Iron Reducing 90° Elbows			
3/4" x 1/2"	86342	\$4.80	160
1" x 1/2"	86210	\$6.60	110
1" x 3/4"	86211	\$6.50	90
1 1/4" x 1/2"	86212	\$13.50	75
1 1/4" x 3/4"	86213	\$11.50	60
1 1/4" x 1"	86214	\$10.30	55
1 1/2" x 3/4"	86221	\$16.50	45
1 1/2" x 1"	86215	\$14.50	40
1 1/2" x 1 1/4"	86216	\$14.50	35
2" x 3/4"	86217	\$24.00	30
2" x 1"	86218	\$24.00	25
2" x 1 1/2"	86220	\$25.00	20
2 1/2" x 2"	86762	\$57.50	15

Ductile Iron Fittings			
#815 Ductile Iron Reducing Tees			
Size	Part No.	List Price	Box Qty.
3/4" x 3/4" x 1/2"	86235	\$11.50	95
3/4" x 3/4" x 1"	86755	\$13.00	65
1" x 1/2" x 1"	86236	\$9.25	55
1" x 3/4" x 1/2"	86756	\$14.00	80
1" x 3/4" x 3/4"	86757	\$13.00	65
1" x 3/4" x 1"	86237	\$10.85	55
1" x 1" x 1/2"	86238	\$8.50	65
1" x 1" x 3/4"	86239	\$10.30	60
1" x 1" x 1 1/4"	86240	\$14.00	45
1" x 1" x 1 1/2"	86241	\$24.25	35
1 1/4" x 1" x 1/2"	86242	\$13.75	50
1 1/4" x 1" x 3/4"	86243	\$16.00	50
1 1/4" x 1" x 1"	86244	\$14.00	45
1 1/4" x 1" x 1 1/4"	86245	\$13.75	40
1 1/4" x 1" x 1 1/2"	86246	\$18.00	30
1 1/4" x 1 1/4" x 1/2"	86247	\$14.00	45
1 1/4" x 1 1/4" x 3/4"	86248	\$14.75	45
1 1/4" x 1 1/4" x 1"	86249	\$13.75	40
1 1/4" x 1 1/4" x 1 1/2"	86250	\$24.00	30
1 1/4" x 1 1/4" x 2"	86251	\$37.25	24
1 1/2" x 1" x 1/2"	86252	\$27.75	40
1 1/2" x 1" x 3/4"	86253	\$26.25	40
1 1/2" x 1" x 1"	86254	\$24.00	30
1 1/2" x 1" x 1 1/2"	86256	\$18.00	30
1 1/2" x 1 1/4" x 1/2"	86257	\$19.25	40
1 1/2" x 1 1/4" x 3/4"	86258	\$20.25	40
1 1/2" x 1 1/4" x 1"	86259	\$18.00	30
1 1/2" x 1 1/4" x 2"	86260	\$37.00	20
1 1/2" x 1 1/2" x 1/2"	86261	\$17.75	35
1 1/2" x 1 1/2" x 3/4"	86262	\$19.25	35
1 1/2" x 1 1/2" x 1"	86263	\$18.00	30
1 1/2" x 1 1/2" x 1 1/4"	86264	\$24.25	30
1 1/2" x 1 1/2" x 2"	86265	\$36.75	20
2" x 1" x 2"	86266	\$25.50	15
2" x 1 1/4" x 2"	86267	\$27.25	15
2" x 1 1/2" x 1/2"	86268	\$29.00	30
2" x 1 1/2" x 3/4"	86269	\$29.25	25
2" x 1 1/2" x 1"	86270	\$25.50	20
2" x 1 1/2" x 1 1/2"	86272	\$36.50	20
2" x 1 1/2" x 2"	86273	\$29.00	15
2" x 2" x 1/2"	86222	\$25.00	20
2" x 2" x 3/4"	86223	\$25.00	20
2" x 2" x 1"	86224	\$25.50	20
2" x 2" x 1 1/4"	86225	\$27.25	20
2" x 2" x 1 1/2"	86226	\$29.25	15
2" x 2" x 2 1/2"	86227	\$70.00	10
2 1/2" x 2" x 3/4"	86274	\$68.00	15

*See latest Technical Data Sheets for specific Approvals, Listings, Design Parameters & available finishes. Sprinkler heads & escutcheons are priced separately unless otherwise noted. Items marked "C.O." are made to order and may require longer delivery times.

Ductile Iron Fittings			
Central Sprinkler California Fittings			
<i>Size</i>	<i>Part No.</i>	<i>List Price</i>	<i>Box Qty.</i>
Male Outlet Red. Tee			
1" x 1/2" x 1"	42000	\$14.50	50
Male 90° Street Elbow			
1" x 1"	42002	\$14.00	80
1" x 1/2"	42003	\$14.25	60

Standard Black Nipple		
<i>Size</i>	<i>Part No.</i>	<i>List Price</i>
1/4" x Close	60103	\$1.95
1/4" x 2"	60271	\$2.05
1/4" x 2 1/2"	60272	\$2.60
1/4" x 3"	60270	\$2.60
1/4" x 3 1/2"	60267	\$3.00
1/4" x 4"	60143	\$3.00
1/4" x 4 1/2"	60268	\$4.65
1/4" x 5"	60266	\$4.65
1/4" x 5 1/2"	60265	\$5.50
1/4" x 6"	60144	\$5.50
1/2" x Close	60145	\$1.75
1/2" x 1 1/2"	60146	\$1.75
1/2" x 2"	60147	\$1.75
1/2" x 2 1/2"	60148	\$2.05
1/2" x 3"	60175	\$2.05
1/2" x 3 1/2"	60176	\$2.45
1/2" x 4"	60149	\$2.45
1/2" x 4 1/2"	60177	\$2.80
1/2" x 5"	60178	\$2.80
1/2" x 5 1/2"	60179	\$3.15
1/2" x 6"	60180	\$3.15
3/4" x Close	60181	\$1.95
3/4" x 2"	60150	\$2.00
3/4" x 2 1/2"	60151	\$2.30
3/4" x 3"	60152	\$2.30
3/4" x 3 1/2"	60182	\$2.90
3/4" x 4"	60183	\$3.80
3/4" x 4 1/2"	60184	\$3.55
3/4" x 5"	60185	\$3.55
3/4" x 5 1/2"	60186	\$4.15
3/4" x 6"	60187	\$5.65
1" x Close	60104	\$2.80
1" x 2"	60105	\$3.00
1" x 2 1/2"	60106	\$3.25
1" x 3"	60107	\$3.25
1" x 3 1/2"	60108	\$4.05
1" x 4"	60109	\$4.05
1" x 4 1/2"	60110	\$4.75
1" x 5"	60111	\$4.75
1" x 5 1/2"	60112	\$5.65
1" x 6"	60113	\$5.65
1" x 7"	60196	\$9.15
1" x 8"	60198	\$9.15
1" x 9"	60200	\$10.85
1" x 10"	60202	\$10.85
1" x 11"	60204	\$12.50
1" x 12"	60206	\$12.50
1 1/4" x Close	60114	\$3.55
1 1/4" x 2"	60115	\$3.95
1 1/4" x 2 1/2"	60116	\$4.25
1 1/4" x 3"	60117	\$4.25

Section 16	Specialty Items
Section 18	Grooved Product
Section 19	CPVC Pipe & Fittings
Section 20	Miscellaneous
Section 21	Electrical
Section C	Valves & Hose Equipment
Section D	Backflow
Section F	Pipe & Accessories
Section H	Hangers
Section J	Lubricants
Section K	Misc.

Items shown on this sheet may not be stocked at all Tyco Fire Products warehouses. Please ask your local Tyco Fire Products location for availability. Freight terms may vary for non commonly stocked items. See latest Technical Data Sheets for specific Approvals, Listings, Design Parameters & available finishes. Prices subject to change without notice.

Section 16	Specialty Items
Section 18	Grooved Product
Section 19	CPVC Pipe & Fittings
Section 20	Miscellaneous
Section 21	Electrical
Section C	Valves & Hose Equipment
Section D	Backflow
Section F	Pipe & Accessories
Section H	Hangers
Section J	Lubricants
Section K	Misc.

Standard Black Nipple		
Size	Part No.	List Price
1 ¹ / ₄ " x 3 ¹ / ₂ "	60118	\$4.90
1 ¹ / ₄ " x 4"	60119	\$4.90
1 ¹ / ₄ " x 4 ¹ / ₂ "	60120	\$6.05
1 ¹ / ₄ " x 5"	60121	\$6.05
1 ¹ / ₄ " x 5 ¹ / ₂ "	60122	\$7.20
1 ¹ / ₄ " x 6"	60123	\$7.20
1 ¹ / ₄ " x 7"	60216	\$11.50
1 ¹ / ₄ " x 8"	60291	\$11.50
1 ¹ / ₄ " x 9"	60293	\$14.00
1 ¹ / ₄ " x 10"	60294	\$14.00
1 ¹ / ₄ " x 11"	60295	\$16.25
1 ¹ / ₄ " x 12"	60296	\$16.00
1 ¹ / ₂ " x Close	60124	\$4.45
1 ¹ / ₂ " x 2"	60125	\$4.80
1 ¹ / ₂ " x 2 ¹ / ₂ "	60126	\$5.35
1 ¹ / ₂ " x 3"	60127	\$5.35
1 ¹ / ₂ " x 3 ¹ / ₂ "	60128	\$6.00
1 ¹ / ₂ " x 4"	60129	\$6.00
1 ¹ / ₂ " x 4 ¹ / ₂ "	60130	\$7.35
1 ¹ / ₂ " x 5"	60131	\$7.35
1 ¹ / ₂ " x 5 ¹ / ₂ "	60132	\$8.35
1 ¹ / ₂ " x 6"	60133	\$8.35
1 ¹ / ₂ " x 7"	60157	\$13.50
1 ¹ / ₂ " x 8"	60159	\$13.50
1 ¹ / ₂ " x 9"	60170	\$15.75
1 ¹ / ₂ " x 10"	60171	\$15.75
2" x Close	60134	\$6.00
2" x 2 ¹ / ₂ "	60135	\$6.90
2" x 3"	60136	\$6.90
2" x 3 ¹ / ₂ "	60137	\$8.20
2" x 4"	60138	\$8.25
2" x 4 ¹ / ₂ "	60160	\$9.60
2" x 5"	60139	\$9.60
2" x 5 ¹ / ₂ "	60140	\$11.25
2" x 6"	60141	\$11.25
2" x 7"	60173	\$17.50
2" x 8"	60207	\$19.00
2" x 9"	60208	\$22.25
2" x 10"	60209	\$22.75
2" x 11"	60210	\$26.00
2" x 12"	60168	\$23.75
2 ¹ / ₂ " x Close	60142	\$18.75
2 ¹ / ₂ " x 3"	60161	\$19.25
2 ¹ / ₂ " x 3 ¹ / ₂ "	60162	\$22.25
2 ¹ / ₂ " x 4"	60163	\$22.25
2 ¹ / ₂ " x 4 ¹ / ₂ "	60164	\$24.25
2 ¹ / ₂ " x 5"	60165	\$24.25
2 ¹ / ₂ " x 5 ¹ / ₂ "	60166	\$26.00
2 ¹ / ₂ " x 6"	60167	\$26.00
4" x Close	60299	\$34.25

Extra Heavy Black Nipple		
Size	Part No.	List Price
1/2" x Close	60153	\$2.80
1/2" x 2"	60154	\$2.80
1/2" x 2 ¹ / ₂ "	60211	\$3.35
1/2" x 3"	60212	\$3.35
1/2" x 4"	60194	\$4.10
3/4" x Close	60213	\$3.25
3/4" x 1 ¹ / ₂ "	60192	\$3.25
3/4" x 2"	60286	\$3.00
3/4" x 2 ¹ / ₂ "	60190	\$3.95
3/4" x 3"	60191	\$3.95

Galvanized Nipple		
Size	Part No.	List Price
1/4" x 2 ¹ / ₂ "	60223	\$3.35
1/2" x Close	60226	\$1.95
1/2" x 2"	60227	\$2.05
1/2" x 3"	60228	\$2.45
1/2" x 4"	60229	\$3.00
1/2" x 5"	60230	\$3.55
1/2" x 6"	86323	\$4.05
3/4" x Close	86324	\$2.40
3/4" x 2"	60260	\$2.85
3/4" x 3"	60261	\$2.90
3/4" x 4"	86326	\$3.55
3/4" x 5"	60262	\$4.50
3/4" x 6"	60219	\$5.25
1" x Close	50142	\$3.55
1" x 2"	50143	\$3.80
1" x 2 ¹ / ₂ "	50144	\$4.55
1" x 3"	50145	\$4.15
1" x 4"	60221	\$4.95
1" x 5"	50149	\$6.75
1" x 6"	60222	\$6.80
1 ¹ / ₂ " x Close	50168	\$5.35
1 ¹ / ₂ " x 2"	50169	\$6.15
1 ¹ / ₂ " x 4"	50173	\$9.65
2" x 2 ¹ / ₂ "	50179	\$8.75
2" x 3"	50180	\$9.40
2 ¹ / ₂ " x 3"	50188	\$21.75

*See latest Technical Data Sheets for specific Approvals, Listings, Design Parameters & available finishes. Sprinkler heads & escutcheons are priced separately unless otherwise noted. Items marked "C.O." are made to order and may require longer delivery times.

CPVC Hanger - Head-Set Bracket		
100	HS-2	\$3.70

Erico Hangers			
CPVC Hanger - One Hole Strap - #107			
box qty.	Size	Part No.	List Price (ea.)
100	3/4"	90360	\$1.20
100	1"	90361	\$1.30
100	1 1/4"	90362	\$1.45
100	1 1/2"	90363	\$1.60
100	2"	90364	\$1.85
CPVC Hanger - Two Hole Strap - #108			
100	3/4"	90365	\$1.30
100	1"	90366	\$1.40
100	1 1/4"	90367	\$1.55
100	1 1/2"	90368	\$1.55
100	2"	90369	\$1.70
CPVC Hanger - Side Mount Strap - #109			
100	3/4"	90370	\$1.90
100	1"	90371	\$1.90
100	1 1/4"	90372	\$2.05
100	1 1/2"	90373	\$2.15
100	2"	90374	\$2.35
CPVC Hanger - No-Block Hangers			
100	3/4"	NB 75	\$2.30
100	1"	NB 1	\$2.40
100	1 1/4"	NB 125	\$2.60
100	1 1/2"	NB 15	\$2.80
100	2"	NB 2	\$3.30
CPVC Surge Restraint			
100	90375		\$2.55
Heavy Duty Swivel Hanger - Model 115			
100	1"	150100	\$0.80
100	1 1/4"	150125	\$0.70
100	1 1/2"	150150	\$0.70
100	2"	150200	\$0.90
50	2 1/2"	150250	\$1.95
50	3"	115300	\$1.95
25	4"	115400	\$2.95
25	5"	115500	\$6.15
20	6"	115600	\$5.25
15	8"	115800	\$6.35

Erico Hangers			
Beam Clamps Universal/Reversible Double Rod Hole - Model 300			
box qty.	Size	Part No.	List Price (ea.)
100	3/8"	300038	\$2.25
50	1/2"	300050	\$5.50
Heavy Duty Beam Clamps - Model 547			
-	3/8"	494470	\$9.95
Beam Clamps Big Mouth Double Rod Hole - Model 310			
5"	3/8"	310038	\$6.95
50	1/2"	310050	\$8.65
Steel C-Clamp - Model 200			
100	3/8"	200038	\$5.25
Eye Sockets - Model 37			
500	3/8"	370038	\$1.90
100	1/2"	370050	\$3.30
300-C Retaining Strap (Bulk Units)			
Size		Part No.	List Price (ea.)
3/8" or x 6"		302001	\$5.65
3/8" or x 8"		302002	\$3.90
3/8" x 10		302003	\$4.50
1/2" x 6		302005	\$3.45
1/2" x 8		302006	\$4.50
1/2" x 10		302007	\$5.20
Eye Socket Offset - Model 38			
box qty.	Size	Part No.	List Price (ea.)
250	3/8"	380038	\$2.65
Wide Flange Purlin Clamp - Model 315			
25	3/8"	315438	\$27.25
Steel Wood Drive Screw - Model 43			
100	16" x 2"	430162	\$5.20
100	14" x 2"	430142	\$4.50

Section 16	Specialty Items
Section 18	Grooved Product
Section 19	CPVC Pipe & Fittings
Section 20	Miscellaneous
Section 21	Electrical
Section C	Valves & Hose Equipment
Section D	Backflow
Section F	Pipe & Accessories
Section H	Hangers
Section J	Lubricants
Section K	Misc.

Items shown on this sheet may not be stocked at all Tyco Fire Products warehouses. Please ask your local Tyco Fire Products location for availability. Freight terms may vary for non commonly stocked items. See latest Technical Data Sheets for specific Approvals, Listings, Design Parameters & available finishes. Prices subject to change without notice.

Section 16
Specialty Items

Section 18
Grooved Product

Section 19
CPVC Pipe & Fittings

Section 20
Miscellaneous

Section 21
Electrical

Section C
Valves & Hose Equipment

Section D
Backflow

Section F
Pipe & Accessories

Section H
Hangers

Section J
Lubricants

Section K
Misc.

Erico Hangers			
Steel Rod Coupling - Model 25			
box qty.	Size	Part No.	List Price (ea.)
100	3/8"	250038	\$2.45
100	1/2"	250050	\$5.35
100	5/8"	250055A	\$6.40
100	3/4"	250051A	\$13.25
50	7/8"	250060	\$36.00
Steel Short Rod Coupling - Model 25S			
Size	Part No.	List Price (ea.)	
3/8"	250039	\$2.95	
1/2"	250049	\$2.95	
Knurled Hanger Inserts - Model 100A			
box qty.	Size	Part No.	List Price (ea.)
Bulk	3/8"	200036	\$0.90
Bulk	1/2"	200037	\$2.35
Coach Screw Rod Machine Thread - Model 41			
100	3/8" x 4	414038	\$2.55
100	3/8" x 6	416038	\$1.65
100	3/8" x 8	418038	\$2.25
100	3/8" x 10	419038	\$3.40
100	1/2" x 6	414039	\$6.75
Lag Screw - Model 42			
100	3/8" x 1 1/2"	420050	\$0.90
100	3/8" x 2"	420020	\$0.95
100	3/8" x 2 1/2"	420025	\$1.70
50	1/2" x 2 1/2"	420027	\$1.70
50	1/2" x 3	420028	\$1.90
50	1/2" x 4	420029	\$2.05
Clevis Hanger Standard Model 400			
50	1"	450188	\$3.30
50	1 1/4"	450189	\$4.50
50	1 1/2"	450190	\$4.35
50	2"	450191	\$5.35
50	2 1/2"	450192	\$7.40
50	3"	450195	\$6.65
50	3 1/2"	450202	\$9.40
30	4"	450197	\$12.50
25	5"	450203	\$16.25
20	6"	450199	\$18.75
10"	8"	450196	\$39.00
Bulk	10"	450194	\$63.25
Bulk	12"	450204	\$74.25

Erico Hangers			
Steel Concrete Insert - Model 355			
box qty.	Size	Part No.	List Price (ea.)
150		355000	\$4.85
Concrete Insert Nut - Model 355N			
100	3/8"	355038	\$2.50
100	1/2"	355050	\$3.70
Nail Plate - Model 30482			
100		304001	\$11.50
Plastic Rod Button - Model 15			
Size	Part No.	List Price (ea.)	
3/8"	492150	\$2.80	
Toggle - Model 148			
3/8"	492990	\$3.70	
Pipe Clamp Standard - Model 450			
box qty.	Size	Part No.	List Price (ea.)
50	1"	450126	\$14.25
50	1 1/4"	450125	\$16.25
25	1 1/2"	450150	\$16.25
25	2"	450200	\$14.50
25	2 1/2"	450250	\$17.50
25	3"	450300	\$19.50
25	4"	450400	\$25.00
10	5"	450500	\$45.00
Bulk	6"	450600	\$50.75
Bulk	8"	450800	\$60.00
Riser Clamp Galvanized - Model 510			
25	1"	510101	\$8.75
25	1 1/4"	510126	\$10.80
25	1 1/2"	510151	\$11.25
25	2"	510201	\$12.00
25	2 1/2"	510251	\$12.50
20	3"	510301	\$16.25
15	4"	510401	\$19.00
Bulk	6"	510601	\$31.25
Bulk	8"	510801	\$86.00

*See latest Technical Data Sheets for specific Approvals, Listings, Design Parameters & available finishes. Sprinkler heads & escutcheons are priced separately unless otherwise noted. Items marked "C.O." are made to order and may require longer delivery times.

Erico Hangers			
Steel Side Beam Attachment - Model 325			
<i>box qty.</i>	<i>Size</i>	<i>Part No.</i>	<i>List Price (ea.)</i>
100	3/8"	325038	\$5.35
	1/2"	325050	\$6.30
Tapped Side Beam Steel Connector - Model 328			
100	3/8"	327038	\$7.75
Steel Wall Plate - Model 365			
250	3/8"	365038	\$2.40
Yook U Type Hanger - Model 135 (Fits 1" & 1 1/4" Pipe)			
50	6"	13506A	\$2.40
50	8"	13508	\$6.20
Strut Clamp - Model RIGD			
100	1/2"	450172	\$3.45
100	3/4"	450173	\$3.65
100	1"	450174	\$4.20
50	1 1/4"	450151	\$3.15
50	1 1/2"	450152	\$4.05
50	2"	450153	\$4.25
25	2 1/2"	450154	\$4.70
25	3"	450155	\$4.95
25	4"	450156	\$6.45
25	5"	450175	\$16.25
25	6"	450176	\$18.50
25	8"	450177	\$22.50

Erico Hangers			
Multi-Flange Rod Hanger			
<i>box qty.</i>	<i>Size</i>	<i>Part No.</i>	<i>List Price (ea.)</i>
25	3/8" - PHSW6FP	327040	\$17.75
25	3/8" - PH6FP	327041	\$7.75
	3/8" - PHSW6	327042	\$19.00

Section 16
Specialty Items

Section 18
Grooved Product

Section 19
CPVC Pipe & Fittings

Section 20
Miscellaneous

Section 21
Electrical

Section C
Valves & Hose Equipment

Section D
Backflow

Section F
Pipe & Accessories

Section H
Hangers

Section J
Lubricants

Section K
Misc.

Items shown on this sheet may not be stocked at all Tyco Fire Products warehouses. Please ask your local Tyco Fire Products location for availability. Freight terms may vary for non commonly stocked items. See latest Technical Data Sheets for specific Approvals, Listings, Design Parameters & available finishes. Prices subject to change without notice.

Section 16
Specialty Items

Section 18
Grooved Product

Section 19
CPVC Pipe & Fittings

Section 20
Miscellaneous

Section 21
Electrical

Section C
Valves & Hose Equipment

Section D
Backflow

Section F
Pipe & Accessories

Section H
Hangers

Section J
Lubricants

Section K
Misc.

Tolco for CPVC			
Hangers for CPVC Plastic Pipe Single Fastener Strap Type - Model 22			
<i>box qty.</i>	<i>Size</i>	<i>Part No.</i>	<i>List Price (ea.)</i>
100	3/4"	90180	\$1.30
100	1"	90181	\$1.35
100	1 1/4"	90182	\$1.40
100	1 1/2"	90183	\$1.45
100	2"	90184	\$1.70
Hangers for CPVC Plastic Pipe Double Fastener Strap Type - Model 23			
100	3/4"	90185	\$1.40
100	1"	90186	\$1.45
100	1 1/4"	90187	\$1.50
100	1 1/2"	90188	\$1.55
100	2"	90189	\$1.85
100	2-1/2"	91189	\$5.40
Hangers for CPVC Plastic Pipe Double Fastener Strap Type Side Mount - Model 24			
100	3/4"	90191	\$1.85
100	1"	90192	\$2.10
100	1 1/4"	90193	\$2.15
100	1 1/2"	90194	\$2.45
100	2"	90195	\$2.65
Ring Hangers - Model 200			
100	3/4"	80190	\$0.95
100	1"	80191	\$1.00
100	1 1/4"	80192	\$1.00
100	1 1/2"	80193	\$1.00
100	2"	80194	\$1.10
100	2 1/2"	80195	\$2.15
75	3"	81300	\$2.30

Tolco Earthquake Bracing			
Fast Clamp Sway Brace Attachment - #1000			
<i>box qty.</i>	<i>Size</i>	<i>Part No.</i>	<i>List Price (ea.)</i>
25	1 x 1"	200100	\$16.50
25	1 x 1 1/4"	200101	\$19.75
25	1 1/4 x 1"	200102	\$16.50
25	1 1/4 x 1 1/4"	200103	\$19.75
25	1 1/2 x 1"	200104	\$16.50
25	1 1/2 x 1 1/4"	200105	\$19.75
25	2 x 1"	200106	\$16.50
25	2 x 1 1/4"	200107	\$19.75
20	2 1/2 x 1"	200108	\$31.50
25	2 1/2 x 1 1/4"	200109	\$20.50
20	3 x 1"	200110	\$17.50
20	3 x 1 1/4"	200111	\$20.50
20	4 x 1"	200112	\$20.75
20	4 x 1 1/4"	200113	\$25.25
20	6 x 1"	200114	\$28.75
20	6 x 1 1/4"	200115	\$47.00
20	8 x 1"	200116	\$31.00
Fast Clamp Sway Brace Attachment - #1001			
10"	8 x 1 1/4"	201117	\$55.00
Longitudinal 4-way Brace Attachment - #907			
<i>Size</i>		<i>Part No.</i>	<i>List Price (ea.)</i>
1 x 1"		200120	\$19.50
1 1/4 x 1"		200121	\$20.00
1 1/4 x 1 1/4"		200122	\$20.25
Non-Threaded Structural Attachment - #909			
1"		200126	\$19.75
Threaded Structural Attachment - #910			
1"		200128	\$18.25
1 1/4"		200129	\$20.75
Threaded Straight Fittings - #975			
1"		200130	\$18.50
Pipe Clamp for Sway Bracing - #4A			
4"		200135	\$15.75
6"		200136	\$38.75
8"		200137	\$49.00
Beam Clamp Retaining Straps - #69			
3/8 x 4		200140	\$2.05
3/8 x 6		200141	\$2.05
3/8 x 8		200142	\$2.05
3/8 x 10		200143	\$2.30
3/8 x 12"		200144	\$2.50
1/2 x 4		200150	\$2.05
1/2 x 6		200151	\$2.05
1/2 x 8		200152	\$2.05
1/2 x 10		200153	\$2.30

*See latest Technical Data Sheets for specific Approvals, Listings, Design Parameters & available finishes. Sprinkler heads & escutcheons are priced separately unless otherwise noted. Items marked "C.O." are made to order and may require longer delivery times.

Threaded Rod Company		
Black All Thread Rod		
<i>Size</i>	<i>Part No.</i>	<i>List Price/Foot</i>
3/8" x 6'	41050	\$0.75
3/8" x 10'	41052	\$0.75
3/8" x 12'	41053	\$0.75
1/2" x 6'	41060	\$1.40
1/2" x 10'	41061	\$1.40
1/2" x 12'	41062	\$1.40
5/8" x 6'	41064	\$2.40
5/8" x 10'	41063	\$2.40
3/4" x 10'	41065	\$3.65
7/8" x 10'	41066	\$6.05
Galv All Thread Rod		
3/8" x 6'	41058	\$0.90
3/8" x 10'	41056	\$0.90
1/2" x 6'	41059	\$1.75
1/2" x 10'	41057	\$1.75
All Thread Stud		
3/8" x 2"	41080	\$0.35
3/8" x 3"	41081	\$0.35
3/8" x 4"	41082	\$0.40
3/8" x 5"	41083	\$0.45
3/8" x 6"	41084	\$0.65
3/8" x 7"	41085	\$0.75
3/8" x 8"	41086	\$0.80
3/8" x 9"	41087	\$0.90
3/8" x 10"	41088	\$1.05
3/8" x 11"	41089	\$1.10
3/8" x 12"	41090	\$1.20
3/8" x 13"	41091	\$1.30
3/8" x 14"	41092	\$1.35
3/8" x 15"	41093	\$1.50
3/8" x 16"	41094	\$1.70
3/8" x 17"	41095	\$1.75
3/8" x 18"	41096	\$1.85
3/8" x 20"	41099	\$2.00
3/8" x 21"	41124	\$2.10
3/8" x 23"	41098	\$2.30
3/8" x 24"	41097	\$2.35

Elco Ind. - Hanger Mate		
Wood Screw		
<i>Size</i>	<i>Part No.</i>	<i>List Price (ea.)</i>
ZG650	21112	\$1.75
EZH665	21145	\$1.90
Steel Screw		
EZG550	21113	\$28.00
EZG510	21148	\$2.10
Steel Screw w/Nuts		
EZH476	21149	\$2.05
EZG471	21140	\$1.85
Concrete Screw		
EZG730	21114	\$1.60
Drill Bit Adapter		
EZE240	21116	\$25.75
Masonry Bit		
EZE340	21117	\$6.85
Drive Sockets		
Wood/Metal	20113	\$42.75
Concrete	20114	\$51.00

Section 16	Specialty Items
Section 18	Grooved Product
Section 19	CPVC Pipe & Fittings
Section 20	Miscellaneous
Section 21	Electrical
Section C	Valves & Hose Equipment
Section D	Backflow
Section F	Pipe & Accessories
Section H	Hangers
Section J	Lubricants
Section K	Misc.

Items shown on this sheet may not be stocked at all Tyco Fire Products warehouses. Please ask your local Tyco Fire Products location for availability. Freight terms may vary for non commonly stocked items. See latest Technical Data Sheets for specific Approvals, Listings, Design Parameters & available finishes. Prices subject to change without notice.

Section 16	Specialty Items
Section 18	Grooved Product
Section 19	CPVC Pipe & Fittings
Section 20	Miscellaneous
Section 21	Electrical
Section C	Valves & Hose Equipment
Section D	Backflow
Section F	Pipe & Accessories
Section H	Hangers
Section J	Lubricants
Section K	Misc.

Sammy Super Screw		
Steel		
Size	Part No.	List Price (ea.)
DST 10 Sam Screw 3/8" x 1"	20081	\$2.10
DST 15 Sam Screw 3/8" x 1 1/2"	20082	\$2.15
DST 20 Sam Screw 3/8" x 2"	20083	\$2.20
DST 25 Sam Screw 3/8" x 2 1/2"	20084	\$2.20
DST 30 Sam Screw 3/8" x 3"	20085	\$2.35
DSTR 1 Sam Screw 1 1/4" X 1"	21189	\$2.10
DSTR 516 Sam Screw 5/16" x 1 1/4"	21190	\$2.45
Concrete		
SWC 20 Sam Screw 3/8" x 2"	21192	\$3.15
Wood		
GST .75 Sam Screw 3/8" x 1"	20193	\$3.15
GST 10 Sam Screw 3/8" x 1"	20089	\$2.10
GST 20 Sam Screw 3/8" x 2"	20090	\$2.00
GST 30 Sam Screw 3/8" x 3"	20091	\$2.10
SST 30 Sam Screw 3/8" x 3"	20092	\$2.60
Sammy Screw 1/4" x 1 1/2"	21191	\$2.85
Sidewinder Screw 1/4" x 1"	21181	\$2.70
Sidewinder Screw 5/16" x 1 1/4"	21182	\$3.10
Sidewinder Screw 1/4" x 1"	21183	\$3.50
Sidewinder Screw 1/4" x 1 1/2"	21184	\$2.60
Sidewinder Screw 5/16" x 1 1/4"	21185	\$3.20
Sidewinder Screw 1/4" x 1 1/2"	21186	\$3.15
Sidewinder Screw 1/4" x 1"	21187	\$2.90
Sidewinder Screw 1/4" x 2"	21188	\$2.90
Sidewinder Screw 3/8" x 2 1/2"	21195	\$2.70
Nut Drivers		
Description	Part No.	List Price (ea.)
Sammy Screw Nut Driver	20086	\$29.75
Sammy Screw Sidewinder		
Nut Driver 16mm	20087	\$29.75
Sammy Screw X-Press Anchor		
XP-20 X-Press Anchor 20	21196	\$10.05
XP-35 X-Press Anchor 35	21197	\$10.05
Sammy Screw X-Press Install Tool		
XPIT X-Press Install tool	21198	\$358.50
X-Press Drill Bit		
X-Press Drill bit	21199	\$31.50

Sammy Super Screw		
Swivel-Head Wood Sammy Screw		
Description	Part No.	List Price (ea.)
SH-GST 20	20190	\$2.20
SH-GST 30	20191	\$2.40
Swivel-Head Steel Sammy Screw		
SH-DSTR1	21289	\$3.40

*See latest Technical Data Sheets for specific Approvals, Listings, Design Parameters & available finishes. Sprinkler heads & escutcheons are priced separately unless otherwise noted. Items marked "C.O." are made to order and may require longer delivery times.

Afcon for CPVC		
Description	Part No.	List Price (ea.)
Model #509 CPVC Nail Plate Protector [Stud Guards]	81301	\$1.50

Afcon			
Sway Brace Clamp Model E-001			
box qty.	Size	Part No.	List Price (ea.)
25	1"	150014	\$21.25
25	1 1/4"	150018	\$21.25
25	1 1/2"	150013	\$21.25
25	2"	150001	\$21.25
10"	2 1/2"	150002	\$21.75
10"	3"	150003	\$22.00
10"	4"	150004	\$26.75
Sway Brace Clamp Model 410			
10"	4"	150174	\$17.00
	6"	150175	\$33.00
1 1/4" Pipe Sway Brace Clamp Model E-020			
25	1 1/4"	150020	\$25.25
25	1 1/2"	150121	\$25.25
25	2"	150007	\$25.25
10"	2 1/2"	150008	\$26.00
10"	3"	150009	\$26.50
10"	4"	150010	\$28.25
Threaded Attachment End - Model-070			
50	1"	150015	\$34.25
Locking Attachment - Model 077			
50	1"	150021	\$20.25
50	1 1/4"	150022	\$25.75

Afcon			
Surge Restrainer - Model 310			
box qty.	Size	Part No.	List Price (ea.)
	1" - 2"	302026	\$1.10
CPVC Offset Hanger - Model 514			
	3/4"	90235	\$2.15
	1"	90236	\$2.10
	1 1/4"	90237	\$2.35
	1 1/2"	90238	\$2.35
	2"	90239	\$3.15
Double Offset CPVC Hanger - Model 515			
	3/4"	90245	\$4.65
	1"	90246	\$4.65

Section 16	Specialty Items
Section 18	Grooved Product
Section 19	CPVC Pipe & Fittings
Section 20	Miscellaneous
Section 21	Electrical
Section C	Valves & Hose Equipment
Section D	Backflow
Section F	Pipe & Accessories
Section H	Hangers
Section J	Lubricants
Section K	Misc.

Items shown on this sheet may not be stocked at all Tyco Fire Products warehouses. Please ask your local Tyco Fire Products location for availability. Freight terms may vary for non commonly stocked items. See latest Technical Data Sheets for specific Approvals, Listings, Design Parameters & available finishes. Prices subject to change without notice.

Section 16 Specialty Items
Section 18 Grooved Product
Section 19 CPVC Pipe & Fittings
Section 20 Miscellaneous
Section 21 Electrical
Section C Valves & Hose Equipment
Section D Backflow
Section F Pipe & Accessories
Section H Hangers
Section J Lubricants
Section K Misc.

**See latest Technical Data Sheets for specific Approvals, Listings, Design Parameters & available finishes. Sprinkler heads & escutcheons are priced separately unless otherwise noted. Items marked "C.O." are made to order and may require longer delivery times.*

Supersedes 3/4/2011

LA-CO Industries		
Thread Sealant Paste		
<i>Description</i>	<i>Part No.</i>	<i>List Price</i>
Slic-Tite Qt	32004	\$57.25
Slic-Tite Qt BIC*	32025	\$66.50
* BIC - Brush In Can		
Gasket Lubricant		
Lubri-Joint Qt	32005	See Section 18 for list prices
Tape		
Tefl-Tape 1/2 x 520	32014	\$1.00
Tefl-Tape 3/4 x 520	32015	\$1.80
Acid Brush 1/2"	32016	\$0.60
Pipe Markers (Valve Action)		
White	32017	\$4.60
Yellow	32018	\$4.60
Red	32019	\$4.60
Blue	32020	\$4.60

Noble Company "Fire Fighter"		
Anti-Freeze - Glycol for Steel Pipe (pre-mix)		
<i>Description</i>	<i>Part No.</i>	<i>List Price</i>
1 Gallon	54010	\$26.25
5 Gallon	54011	\$132.00
55 Gallon	54012	\$1,390.00
Anti-Freeze - Glycol for Steel Pipe (concentrate)		
5 Gallon	54014	\$269.00
55 Gallon	54015	\$2,941.00

Gasket Lubricant		
Silicone Gasket Lubricant		
(for use with Dry Pipe & Freezer Applications)		
Dow Corning * #DC No. 7		
Recommended for Tri-Seal Gaskets		
<i>Description</i>	<i>Part No.</i>	<i>List Price</i>
5.30 oz. Tube	32037	See Section 18 for current list prices
8 lb Can	32038	

Section 16	Specialty Items
Section 18	Grooved Product
Section 19	CPVC Pipe & Fittings
Section 20	Miscellaneous
Section 21	Electrical
Section C	Valves & Hose Equipment
Section D	Backflow
Section F	Pipe & Accessories
Section H	Hangers
Section J	Lubricants
Section K	Misc.

* Dow Corning is a trademark of Dow Corning Corporation.

Items shown on this sheet may not be stocked at all Tyco Fire Products warehouses. Please ask your local Tyco Fire Products location for availability. Freight terms may vary for non commonly stocked items. See latest Technical Data Sheets for specific Approvals, Listings, Design Parameters & available finishes. Prices subject to change without notice.

Section 16 Specialty Items
Section 18 Grooved Product
Section 19 CPVC Pipe & Fittings
Section 20 Miscellaneous
Section 21 Electrical
Section C Valves & Hose Equipment
Section D Backflow
Section F Pipe & Accessories
Section H Hangers
Section J Lubricants
Section K Misc.

Sealant		
FPPI Thread-Fit Cutting Oil		
<i>Description</i>	<i>Part No.</i>	<i>List Price</i>
1-gallon	320040	\$42.50
5-gallon	320041	\$202.50
55-gallon	320042	\$2,036.00
FPPI PipeFit Thread Sealant		
1-pint Can BIC	320030	\$18.00
1-quart Can	320031	\$29.25
1-gallon Can	320032	\$120.00
5-gallon Can	320033	\$442.50
Oatey Great White Thread Sealant		
4-ounce	31230	\$5.85
8-ounce	31231	\$9.30
1-pint	31232	\$16.50
1-quart	31233	\$29.75
FPPI LubeFit Gasket Lubricant		
2-Lb	320043	\$11.25

*See latest Technical Data Sheets for specific Approvals, Listings, Design Parameters & available finishes. Sprinkler heads & escutcheons are priced separately unless otherwise noted. Items marked "C.O." are made to order and may require longer delivery times.

MIFAB / PMR		
Access Doors		
<i>Description</i>	<i>Part No.</i>	<i>List Price</i>
VA, 12" x 24" - Drywall	21070	\$94.50
VA, 14" x 14" - Drywall	21071	\$46.25
VA, 16" x 16" - Drywall	21072	\$50.50
UA, 12" x 12" - Drywall	21075	\$69.25
UA, 24" x 24" - Drywall	21076	\$146.00
UA 8" x 8" Drywall	21078	\$39.00
UA 16" x 20" Drywall	21083	\$68.25
UA 16" x 24" Drywall	21084	\$75.75
UA 18" x 18" Drywall	21085	\$99.75

Acudor Products		
Access Door, Flush, Prime coated steel, UF5000		
<i>Description</i>	<i>Part No.</i>	<i>List Price</i>
6" x 6"	22100	\$50.50
8" x 8"	22101	\$51.50
12" x 12"	22102	\$60.00
12" x 18"	22103	\$94.00
16" x 16"	22104	\$94.00
18" x 18"	22105	\$95.50
18" x 24"	22106	\$126.50
18" x 24" with drip edge	22107	\$179.00
24" x 36"	22108	\$234.00

Section 16	Specialty Items
Section 18	Grooved Product
Section 19	CPVC Pipe & Fittings
Section 20	Miscellaneous
Section 21	Electrical
Section C	Valves & Hose Equipment
Section D	Backflow
Section F	Pipe & Accessories
Section H	Hangers
Section J	Lubricants
Section K	Misc.

Items shown on this sheet may not be stocked at all Tyco Fire Products warehouses. Please ask your local Tyco Fire Products location for availability. Freight terms may vary for non commonly stocked items. See latest Technical Data Sheets for specific Approvals, Listings, Design Parameters & available finishes. Prices subject to change without notice.

Section 16 Specialty Items
Section 18 Grooved Product
Section 19 CPVC Pipe & Fittings
Section 20 Miscellaneous
Section 21 Electrical
Section C Valves & Hose Equipment
Section D Backflow
Section F Pipe & Accessories
Section H Hangers
Section J Lubricants
Section K Misc.

**See latest Technical Data Sheets for specific Approvals, Listings, Design Parameters & available finishes. Sprinkler heads & escutcheons are priced separately unless otherwise noted. Items marked "C.O." are made to order and may require longer delivery times.*

Supersedes 3/4/2011

Price Book Part Number Index

01EPDMAC.....18-7	150018.....H-7	200144.....H-4	20449.....D-7	205521.....D-1	207191.....D-1
01EPDME3.....18-7	150020.....H-7	200150.....H-4	20450.....D-7	205522.....D-3	207192.....D-3
100-25-700.....7-11	150021.....H-7	200151.....H-4	20451.....D-7	205523.....D-3	207193.....D-3
10908100.....7-13	150022.....H-7	200152.....H-4	20452.....D-7	20553.....D-2	20729.....D-2
10EPDMAC.....18-7	150100.....H-1	200153.....H-4	20457.....D-7	205530.....D-1	20730.....D-2
10EPDME3.....18-7	150121.....H-7	20081.....H-6	20459.....D-7	205531.....D-1	20731.....D-2
1111.....7-12	150125.....H-1	20082.....H-6	20460.....D-7	205532.....D-3	20732.....D-2
1119.....7-12	150150.....H-1	20083.....H-6	20461.....D-7	205533.....D-3	20734.....D-2
1124.....7-12	150174.....H-7	20084.....H-6	20462.....D-7	20555.....D-2	20757.....D-2
1150.....7-10	150175.....H-7	20085.....H-6	20470.....D-7	20558.....D-2	20758.....D-2
1152.....7-10	150200.....H-1	20086.....H-6	20471.....D-7	205580.....D-1	20759.....D-2
1153.....7-10	150250.....H-1	20087.....H-6	20472.....D-7	205581.....D-1	20760.....D-2
115300.....H-1	15250.....F-2	20089.....H-6	20473.....D-7	205582.....D-3	20761.....D-2
115400.....H-1	15500.....F-2	20090.....H-6	20475.....D-8	205583.....D-3	20762.....D-2
115500.....H-1	15750.....F-2	20091.....H-6	20476.....D-8	205585.....D-1	20767.....D-2
115600.....H-1	15EPDMAC.....18-7	20092.....H-6	20477.....D-8	205586.....D-1	207670.....D-1
115800.....H-1	15EPDME3.....18-7	20110GS.....18-8	20478.....D-7	20559.....D-2	207671.....D-1
1174.....7-10	16100.....F-2	20110S.....18-8	20479.....D-7	205590.....D-1	207672.....D-3
1175.....7-10	16400.....F-2	201117.....H-4	20480.....D-7	205591.....D-1	20768.....D-2
1177.....7-12	1667-4.....20-6	20112GS.....18-8	20481.....D-7	205592.....D-3	207680.....D-1
1184.....7-10	1667-41.....20-6	20112S.....18-8	20485.....D-7	205593.....D-3	207681.....D-1
1192.....7-10	1667-6.....20-6	20113.....H-5	20490.....D-7	205595.....D-1	207682.....D-3
1193.....7-10	1667-61.....20-6	20114.....H-5	20491.....D-7	205596.....D-1	20769.....D-2
1194.....7-10	16700.....F-2	20125.....13-3	20492.....D-7	20561.....D-2	207690.....D-1
1195.....7-10	16900.....F-2	20128.....11-2	20504.....C-1	20592.....C-1	207691.....D-1
1196.....7-10	17000.....F-2	20128.....13-3	20506.....C-1	20610.....D-7	207692.....D-3
1197.....7-10	17025.....F-2	20128.....14-3	20508.....C-1	20611.....D-7	20770.....D-2
1198.....7-10	17031.....F-2	20128.....14-4	20509.....C-1	206115.....D-7	207700.....D-1
1199.....7-10	17037.....F-2	20128.....14-5	20510.....C-1	20612.....D-7	207701.....D-1
1200.....7-10	17044.....F-2	20128.....14-6	20514.....C-1	20613.....D-7	207702.....D-3
12525000.....16-1	19071100.....19-6	20128.....21-1	20516.....C-1	20614.....D-7	20771.....D-2
1295.....16-1	1954-02.....20-9	20135.....14-3	20518.....C-1	20615.....D-7	207710.....D-1
129501.....16-1	1954-04.....20-9	20135.....14-4	20520.....C-1	206155.....D-7	207712.....D-3
12EPDMAC.....18-7	200036.....H-2	20135.....14-5	20521.....C-1	20616.....D-7	20772.....D-2
12EPDME3.....18-7	200037.....H-2	20135.....14-6	20539.....D-2	20617.....D-7	20787.....D-2
13506A.....H-3	200038.....H-1	20135.....21-1	205390.....D-1	20618.....D-7	20788.....D-2
13508.....H-3	200100.....H-4	20150GS.....18-8	205391.....D-1	20619.....D-7	207880.....D-2
13EPDMAC.....18-7	200101.....H-4	20150S.....18-8	205392.....D-3	20620.....D-7	20809.....C-1
13EPDME3.....18-7	200102.....H-4	2015EPDME.....18-4	205393.....D-3	20621.....D-7	20810.....C-1
1420.....F-3	200103.....H-4	20190.....H-6	205395.....D-1	20634.....D-7	208102.....2-2
1421.....F-3	200104.....H-4	20191.....H-6	205396.....D-1	20635.....D-7	208102.....2-3
1422.....F-3	200105.....H-4	20193.....H-6	20548.....D-2	20636.....D-7	208102.....7-11
1423.....F-3	200106.....H-4	20404.....D-7	205480.....D-1	20641.....D-7	208104.....2-2
1424.....F-3	200107.....H-4	20405.....D-7	205481.....D-1	20642.....D-7	208104.....2-3
1425.....F-3	200108.....H-4	20406.....D-7	205482.....D-3	20647.....D-8	208104.....7-11
1426A.....F-3	200109.....H-4	20407.....D-7	205483.....D-3	20648.....D-8	208107.....2-2
1428.....F-3	200110.....H-4	20408.....D-7	205485.....D-1	20661.....D-7	208107.....2-3
1430.....F-3	200111.....H-4	20409.....D-7	205486.....D-1	20662.....D-7	208107.....7-11
1432.....F-3	200112.....H-4	20410.....D-7	20549.....D-2	20663.....D-7	20811.....C-1
1433.....F-3	200113.....H-4	20411A.....D-7	205490.....D-1	20664.....D-7	20813.....D-7
1434.....F-3	200114.....H-4	20412.....D-7	205491.....D-1	20669.....D-8	20820.....C-1
1435.....F-3	200115.....H-4	20414.....D-8	205492.....D-3	20670.....D-8	20822.....D-2
1436.....F-3	200116.....H-4	20415.....D-7	205493.....D-3	20671.....D-8	20823.....D-2
1437.....F-3	200120.....H-4	20416.....D-8	205495.....D-1	20676.....D-8	20824.....D-2
1440.....F-3	200121.....H-4	20417.....D-7	205496.....D-1	206761.....D-8	20826.....D-2
1441.....F-3	200122.....H-4	20418.....D-8	20550.....D-2	20677.....D-8	20832.....D-2
150001.....H-7	200126.....H-4	20419.....D-7	205500.....D-1	20678.....D-8	208320.....D-1
150002.....H-7	200128.....H-4	20420.....D-8	205501.....D-1	20679.....D-8	208321.....D-1
150003.....H-7	200129.....H-4	20422.....D-7	205502.....D-3	20680.....D-8	208322.....D-3
150004.....H-7	200130.....H-4	20427.....D-7	205503.....D-3	20698.....D-7	208325.....D-1
150007.....H-7	200135.....H-4	20428.....D-7	20551.....D-2	20700.....D-2	208326.....D-1
150008.....H-7	200136.....H-4	20430.....D-7	205510.....D-1	20701.....D-2	20833.....D-2
150009.....H-7	200137.....H-4	20431.....D-7	205511.....D-1	20702.....D-2	208330.....D-1
150010.....H-7	200140.....H-4	20432.....D-8	205512.....D-3	20703.....D-2	208331.....D-1
150013.....H-7	200141.....H-4	20438.....D-7	205513.....D-3	20705.....D-2	208332.....D-3
150014.....H-7	200142.....H-4	20444.....D-7	20552.....D-2	20719.....D-2	208335.....D-1
150015.....H-7	200143.....H-4	20445.....D-7	205520.....D-1	207190.....D-1	208336.....D-1

20834.....	D-2	21085.....	K-1	2226.....	C-2	2382.....	21-1	2505.....	C-3	251730.....	F-1
208340.....	D-1	21112.....	H-5	2227.....	C-2	2387.....	21-1	25058000.....	20-2	2520EPDME.....	18-4
208341.....	D-1	21113.....	H-5	2228.....	C-2	2391.....	F-3	25059000.....	20-3	25700.....	13-5
208342.....	D-3	21114.....	H-5	2240.....	C-2	2394.....	21-1	2509.....	C-3	25700.....	13-7
208345.....	D-1	21116.....	H-5	2241.....	C-2	2396.....	21-1	25100.....	21-1	25700.....	21-1
208346.....	D-1	21117.....	H-5	2242.....	C-2	2399.....	F-3	251100.....	F-1	2571.....	13-10
20836.....	D-2	21126.....	21-1	2243.....	C-2	24100.....	21-1	251120.....	F-1	2571.....	13-3
208360.....	D-1	21140.....	H-5	2244.....	C-2	24110.....	21-1	251130.....	F-1	2571.....	13-8
208361.....	D-1	21145.....	H-5	22441.....	C-3	24111.....	21-1	251140.....	F-1	2571.....	13-9
208362.....	D-3	21148.....	H-5	2245.....	C-2	24112.....	21-1	251150.....	F-1	2571.....	14-6
208365.....	D-1	21149.....	H-5	22450.....	C-3	24113.....	21-1	251160.....	F-1	25710.....	13-5
208366.....	D-1	21181.....	H-6	22451.....	C-3	24114.....	21-1	251170.....	F-1	25710.....	13-7
208380.....	D-1	21182.....	H-6	22460.....	C-3	24115.....	21-1	251180.....	F-1	25710.....	21-1
208382.....	D-3	21183.....	H-6	22461.....	C-3	24116.....	21-1	251190.....	F-1	2572.....	12-1
208385.....	D-1	21184.....	H-6	2259.....	C-1	24117.....	21-1	251200.....	F-1	25720.....	21-1
20839.....	D-2	21185.....	H-6	2262.....	C-2	2412.....	13-10	251210.....	F-1	2573.....	12-1
20849.....	D-1	21186.....	H-6	2264.....	C-1	2412.....	13-3	251220.....	F-1	2573.....	13-3
20851.....	D-1	21187.....	H-6	2265.....	C-1	2412.....	13-8	251230.....	F-1	2573.....	13-9
20853.....	D-1	21188.....	H-6	22650.....	C-1	2412.....	13-9	251240.....	F-1	2573.....	14-6
20854.....	D-1	21189.....	H-6	22651.....	C-1	2412.....	14-1	251250.....	F-1	25730.....	21-1
20855.....	D-1	21190.....	H-6	2266.....	C-1	2412.....	14-2	251260.....	F-1	2587.....	21-1
20858.....	D-1	21191.....	H-6	22660.....	C-1	2412.....	14-3	251270.....	F-1	25870.....	21-1
20897.....	D-2	21192.....	H-6	22661.....	C-1	2412.....	14-4	251280.....	F-1	25880.....	21-1
20898.....	D-2	21195.....	H-6	2267.....	C-1	2412.....	14-5	251290.....	F-1	25EPDMAC.....	18-7
20EPDMAC.....	18-7	21196.....	H-6	22670.....	C-1	2412.....	14-6	251300.....	F-1	25EPDME3.....	18-7
20EPDME3.....	18-7	21197.....	H-6	22671.....	C-1	2412.....	21-1	251310.....	F-1	26001GS.....	18-10
21000.....	C-1	21198.....	H-6	2268.....	C-1	2414.....	21-1	251320.....	F-1	26001S.....	18-10
21010.....	D-1	21199.....	H-6	22680.....	C-1	24148.....	21-1	251330.....	F-1	26010GP.....	18-10
21010GS.....	18-9	21215.....	C-1	22681.....	C-1	2419.....	21-1	251340.....	F-1	26010GS.....	18-10
21010S.....	18-9	21216.....	C-1	2269.....	C-1	2426.....	21-1	251350.....	F-1	26010P.....	18-10
21011.....	D-1	21217.....	C-1	22690.....	C-1	2428.....	21-1	251360.....	F-1	26010S.....	18-10
21012.....	D-1	21218.....	C-1	22691.....	C-1	2433.....	16-1	251370.....	F-1	26012GP.....	18-10
21012GS.....	18-9	21221.....	C-1	2272.....	C-2	2440.....	21-1	251380.....	F-1	26012GS.....	18-10
21012S.....	18-9	21223.....	C-1	2273.....	C-2	2441.....	21-1	251390.....	F-1	26012P.....	18-10
21013.....	D-1	21224.....	C-1	2274.....	C-2	2442.....	21-1	251400.....	F-1	26012S.....	18-10
21014.....	D-1	21226.....	C-1	2275.....	C-2	2443.....	21-1	251410.....	F-1	26013GP.....	18-10
21015.....	D-1	21227.....	C-1	2276.....	C-2	2444.....	21-1	251420.....	F-1	26013GS.....	18-10
21016.....	D-2	21228.....	C-1	2280.....	C-2	2445.....	21-1	251430.....	F-1	26013P.....	18-10
21017.....	D-2	21229.....	C-1	2281.....	C-2	2446.....	21-1	251440.....	F-1	26013S.....	18-10
21018.....	D-2	21232.....	F-3	2282.....	16-1	2447.....	21-1	251450.....	F-1	26015GP.....	18-10
21019.....	D-2	21289.....	H-6	2283.....	16-1	2458.....	21-1	251460.....	F-1	26015GS.....	18-10
21020.....	C-1	21549.....	D-2	2284.....	C-2	2459.....	21-1	251470.....	F-1	26015P.....	18-10
21021.....	D-2	21910GS.....	18-9	2285.....	F-3	2460566.....	13-5	251480.....	F-1	26015S.....	18-10
21022.....	D-2	21910S.....	18-9	2286.....	F-3	2460566.....	13-7	251490.....	F-1	26020GP.....	18-10
21023.....	D-1	21912GS.....	18-9	2287.....	F-3	2471.....	21-1	251500.....	F-1	26020GS.....	18-10
21024.....	D-1	21912S.....	18-9	2288.....	F-3	2472.....	21-1	251510.....	F-1	26020P.....	18-10
21025.....	D-1	21950GS.....	18-9	2292.....	F-3	2473.....	21-1	251520.....	F-1	26020S.....	18-10
21026.....	D-1	21950S.....	18-9	2293.....	F-3	2477.....	21-1	251530.....	F-1	26020T1P.....	18-10
21027.....	D-1	2202.....	C-2	2296.....	C-2	2478.....	21-1	251540.....	F-1	26020T1S.....	18-10
21028A.....	D-1	2203A.....	C-2	2300A.....	16-5	2484.....	21-1	251550.....	F-1	26020TP.....	18-10
21029.....	D-2	2204A.....	C-2	2302.....	16-5	2486.....	21-1	251560.....	F-1	26020TS.....	18-10
21030.....	D-2	2205A.....	C-2	2304A.....	16-5	2487.....	21-1	251570.....	F-1	26025GP.....	18-10
21031.....	D-2	2206A.....	C-2	2306.....	16-5	24882.....	21-1	251580.....	F-1	26025GS.....	18-10
21032.....	D-2	2207.....	C-2	2307.....	16-5	24883.....	21-1	251590.....	F-1	26025P.....	18-10
21033.....	D-2	22100.....	K-1	2310.....	16-5	2489.....	21-1	251600.....	F-1	26025S.....	18-10
21034.....	D-2	22101.....	K-1	2311.....	16-5	250038.....	H-2	251610.....	F-1	26025T1P.....	18-10
21040.....	C-1	22102.....	K-1	2313.....	16-5	250039.....	H-2	251620.....	F-1	26025T1S.....	18-10
21050GS.....	18-9	22103.....	K-1	2317.....	16-5	25004000.....	20-2	251630.....	F-1	26025TP.....	18-10
21050S.....	18-9	22104.....	K-1	2319.....	16-5	250049.....	H-2	251640.....	F-1	26025TS.....	18-10
21070.....	K-1	22105.....	K-1	2320.....	16-5	250050.....	H-2	251650.....	F-1	26030GP.....	18-10
21071.....	K-1	22106.....	K-1	2327.....	16-5	250051A.....	H-2	251660.....	F-1	26030GS.....	18-10
21072.....	K-1	22107.....	K-1	2328.....	16-5	250055A.....	H-2	251670.....	F-1	26030P.....	18-10
21075.....	K-1	22108.....	K-1	2329.....	16-5	250060.....	H-2	251680.....	F-1	26030S.....	18-10
21076.....	K-1	2222.....	C-2	2344.....	21-1	2501.....	C-3	251690.....	F-1	26030T1P.....	18-10
21078.....	K-1	2223.....	C-2	2370.....	16-1	2502A.....	C-3	251700.....	F-1	26030T1S.....	18-10
21083.....	K-1	2224.....	C-2	2373.....	21-1	2503.....	C-3	251710.....	F-1	26030TP.....	18-10
21084.....	K-1	2225.....	C-2	2374.....	21-1	2504.....	C-3	251720.....	F-1	26030TS.....	18-10

Price Book
Part Number Index

26040GP.....	18-10	28160.....	C-4	320043.....	J-2	3501804.....	D-5	4059.....	8-3	41081.....	H-5
26040GS.....	18-10	28165.....	C-4	32005.....	18-7	350250.....	D-5	4060.....	8-3	41082.....	H-5
26040P.....	18-10	28170.....	C-4	32005.....	J-1	350300.....	D-5	4061.....	8-3	41083.....	H-5
26040S.....	18-10	28190.....	C-4	3201.....	F-2	350400.....	D-5	4062.....	8-3	41084.....	H-5
26040T1P.....	18-10	28195.....	C-4	32014.....	J-1	350600.....	D-5	4063.....	8-3	41085.....	H-5
26040T1S.....	18-10	28205.....	C-4	32015.....	J-1	350800.....	D-5	4064.....	8-3	41086.....	H-5
26040TP.....	18-10	28225.....	C-4	32016.....	J-1	355000.....	H-2	4065.....	8-3	41087.....	H-5
26040TS.....	18-10	28250.....	C-4	32017.....	J-1	355038.....	H-2	4066.....	8-3	41088.....	H-5
26050GP.....	18-10	28255.....	C-4	32018.....	J-1	355050.....	H-2	4067.....	8-3	41089.....	H-5
26050GS.....	18-10	28265.....	C-4	32019.....	J-1	365038.....	H-3	4072.....	8-3	41090.....	H-5
26050P.....	18-10	28285.....	C-4	3202.....	F-2	370038.....	H-1	4073.....	8-3	41091.....	H-5
26050S.....	18-10	28295.....	C-4	32020.....	J-1	370050.....	H-1	4085.....	8-3	41092.....	H-5
26050T1S.....	18-10	28300.....	C-4	32025.....	J-1	3723013GS.....	18-17	4086.....	8-3	41093.....	H-5
26050TS.....	18-10	28305.....	C-4	32030GS.....	18-15	3724013GS.....	18-17	4087.....	8-3	41094.....	H-5
26060GP.....	18-10	28320.....	C-4	32037.....	18-7	3751105.....	D-6	4088.....	8-3	41095.....	H-5
26060GS.....	18-10	28330.....	C-4	32037.....	J-1	3751106.....	D-6	4089.....	8-3	41096.....	H-5
26060P.....	18-10	28360.....	C-5	32038.....	18-7	3751250.....	D-5	4090.....	8-3	41097.....	H-5
26060S.....	18-10	28370.....	C-5	32038.....	J-1	3751251.....	D-5	4091.....	8-3	41098.....	H-5
26060T1P.....	18-10	28375.....	C-5	3204.....	F-2	3751252.....	D-5	4092.....	8-3	41099.....	H-5
26060T1S.....	18-10	28400.....	C-5	3205.....	F-2	3751253.....	D-5	4093.....	8-3	41124.....	H-5
26060TP.....	18-10	28415.....	C-5	3206.....	F-2	3751254.....	D-6	4094.....	8-3	41204.....	C-3
26060TS.....	18-10	2954-02.....	20-9	3207.....	F-2	3751255.....	D-6	4095.....	8-3	41205.....	C-3
26080GP.....	18-10	300038.....	H-1	3212510GS.....	18-13	3751256.....	D-6	4096.....	8-3	41206.....	C-3
26080GS.....	18-10	30004000.....	20-2	3214010GS.....	18-13	3751300.....	D-5	40EPDMAC.....	18-7	41210.....	18-25
26080P.....	18-10	30004000.....	20-4	3216050GS.....	18-13	3751301.....	D-5	40EPDME3.....	18-7	41250.....	18-25
26080S.....	18-10	300050.....	H-1	322110.....	C-1	3751302.....	D-5	41001.....	F-2	41251.....	18-25
26080T1P.....	18-10	30010000.....	20-1	322130.....	C-1	3751303.....	D-5	41002.....	F-2	41252.....	18-25
26080T1S.....	18-10	30018600.....	20-4	322140.....	C-1	3751304.....	D-6	41003.....	F-2	41257.....	18-25
26080TP.....	18-10	3002.....	19-6	322160.....	C-1	3751305.....	D-6	41004.....	F-2	41258.....	18-25
26080TS.....	18-10	30021000.....	20-1	322180.....	C-1	3751306.....	D-6	41006.....	F-2	41259.....	18-25
26144.....	21-1	30022000.....	20-1	322260.....	C-1	3751400.....	D-5	41008.....	F-2	41260.....	18-25
26145.....	21-1	30023000.....	20-1	322310.....	C-1	3751401.....	D-5	41010.....	F-2	41261.....	18-25
2653.....	11-1	30058000.....	20-2	322410.....	C-1	3751402.....	D-5	41011.....	F-2	41262.....	18-26
2654.....	11-1	3011.....	19-6	322610.....	C-1	3751403.....	D-5	41013.....	18-25	41263.....	18-26
2655.....	11-1	302001.....	H-1	322810.....	C-1	3751404.....	D-6	41014.....	18-25	41264.....	18-26
2656.....	13-3	302002.....	H-1	325038.....	H-3	3751405.....	D-6	41015.....	18-25	41265.....	18-26
2656.....	14-3	302003.....	H-1	325050.....	H-3	3751406.....	D-6	41017.....	18-25	41266.....	18-26
2656.....	14-4	302005.....	H-1	327038.....	H-3	3751600.....	D-5	41018.....	18-25	41267.....	18-26
2656.....	14-5	302006.....	H-1	327040.....	H-3	3751601.....	D-5	41027.....	18-25	41268.....	18-26
2656.....	14-6	302007.....	H-1	327041.....	H-3	3751602.....	D-5	41029.....	18-25	41269.....	18-26
2656.....	21-1	302026.....	H-7	327042.....	H-3	3751603.....	D-5	41032.....	18-25	41270.....	18-26
2656.....	4-8	3020EPDME.....	18-4	350100.....	D-5	3751604.....	D-6	41033.....	18-25	41271.....	18-26
2657.....	11-1	3025EPDME.....	18-4	3501104.....	D-5	3751605.....	D-6	41034.....	18-25	41272.....	18-26
26590.....	21-1	304001.....	H-2	3501250.....	D-5	3751606.....	D-6	41035.....	18-25	41273.....	18-26
26600.....	21-1	30EPDMAC.....	18-7	3501251.....	D-5	3751800.....	D-5	41037.....	18-25	41274.....	18-26
2665.....	19-6	30EPDME3.....	18-7	3501252.....	D-5	3751801.....	D-5	41038.....	18-25	41275.....	18-26
2666.....	19-6	310038.....	H-1	3501253.....	D-5	3751802.....	D-5	41039.....	18-25	41276.....	18-26
2667.....	19-6	310050.....	H-1	3501254.....	D-5	3751803.....	D-5	41040.....	18-25	41277.....	18-26
2745.....	C-3	3104000.....	D-5	3501300.....	D-5	3751804.....	D-6	41041.....	18-25	41278.....	18-26
27450.....	C-3	3104001.....	D-5	3501301.....	D-5	3751805.....	D-6	41047.....	18-25	41279.....	18-26
2755.....	C-3	3106000.....	D-5	3501302.....	D-5	3751806.....	D-6	41048.....	18-25	41280.....	18-26
27550.....	C-3	3106001.....	D-5	3501303.....	D-5	380038.....	H-1	41049.....	18-25	41281.....	18-26
27560.....	C-3	3108000.....	D-5	3501304.....	D-5	3913060GS.....	18-18	41050.....	H-5	41282.....	18-26
2760.....	C-3	3108001.....	D-5	3501400.....	D-5	40002000.....	20-1	41052.....	H-5	41283.....	18-26
27610.....	C-3	31230.....	J-2	3501401.....	D-5	40004000.....	20-1	41053.....	H-5	41284.....	18-26
27620.....	C-3	31231.....	J-2	3501402.....	D-5	40004000.....	20-2	41056.....	H-5	41285.....	18-26
27910.....	C-3	31232.....	J-2	3501403.....	D-5	40018200.....	20-1	41057.....	H-5	41286.....	18-26
27920.....	C-3	31233.....	J-2	3501404.....	D-5	40018600.....	20-1	41058.....	H-5	41287.....	18-26
27930.....	C-3	315438.....	H-1	3501600.....	D-5	40058000.....	20-1	41059.....	H-5	41288.....	18-26
27940.....	C-3	320030.....	J-2	3501601.....	D-5	40058000.....	20-2	41060.....	H-5	41289.....	18-26
27950.....	C-3	320031.....	J-2	3501602.....	D-5	4020EPDME.....	18-4	41061.....	H-5	41290.....	18-26
27960.....	C-3	320032.....	J-2	3501603.....	D-5	4025EPDME.....	18-4	41062.....	H-5	41291.....	18-26
27980.....	C-3	320033.....	J-2	3501604.....	D-5	4030EPDME.....	18-4	41063.....	H-5	41292.....	18-26
28030.....	C-3	32004.....	J-1	3501800.....	D-5	4055.....	8-3	41064.....	H-5	41293.....	18-26
28050.....	C-5	320040.....	J-2	3501801.....	D-5	4056.....	8-3	41065.....	H-5	41294.....	18-26
28055.....	C-5	320041.....	J-2	3501802.....	D-5	4057.....	8-3	41066.....	H-5	41295.....	18-26
28155.....	C-4	320042.....	J-2	3501803.....	D-5	4058.....	8-3	41080.....	H-5	41296.....	18-26

41297.....	18-26	43400.....	16-3	49-9XX.....	7-2	500031.....	F-4	50086.....	21-2	50240.....	18-5
41298.....	18-26	4360.....	16-3	492150.....	H-2	500032A.....	F-4	50092.....	21-2	50240.....	F-3
41299.....	18-26	43RT.....	16-3	492990.....	H-2	500036.....	F-4	50093.....	21-2	50241.....	18-5
41302.....	C-2	43RTC.....	16-3	494470.....	H-1	500037.....	F-4	50094.....	21-2	50241.....	F-3
41303.....	C-2	450125.....	H-2	50-081.....	7-4	500038.....	F-4	50110GP.....	18-8	50242.....	18-5
41304.....	C-2	450126.....	H-2	50-082.....	7-4	500039.....	F-4	50110P.....	18-8	50242.....	F-3
41305.....	C-2	450150.....	H-2	50-110.....	3-5	500040.....	F-4	50112GP.....	18-8	50243.....	18-5
41306.....	C-2	450151.....	H-3	50-112.....	3-5	500041.....	F-4	50112P.....	18-8	50243.....	F-3
41307.....	C-2	450152.....	H-3	50-210.....	3-5	500042A.....	F-4	50113GP.....	18-8	50244.....	18-5
41320.....	C-2	450153.....	H-3	50-300.....	6-2	500043A.....	F-4	50113GS.....	18-8	50244.....	F-3
41321.....	C-2	450154.....	H-3	50-304.....	6-2	500044.....	F-4	50113P.....	18-8	50245.....	18-5
41322.....	C-2	450155.....	H-3	50-305.....	6-2	500045.....	F-4	50113S.....	18-8	50245.....	F-3
41323.....	C-2	450156.....	H-3	50-314.....	6-8	500046.....	F-4	50115GP.....	18-8	50246.....	18-5
41324.....	C-2	450172.....	H-3	50-315.....	6-8	500047.....	F-4	50115GS.....	18-8	50246.....	F-3
41325.....	C-2	450173.....	H-3	50-316.....	6-8	500048.....	F-4	50115P.....	18-8	50247.....	18-5
41326.....	C-2	450174.....	H-3	50-317.....	6-8	500049.....	F-4	50115S.....	18-8	50247.....	F-3
41327.....	C-2	450175.....	H-3	50-400.....	3-7	500050.....	F-4	50120GP.....	18-8	50248.....	18-5
41328.....	C-2	450176.....	H-3	50-500.....	3-7	500051.....	F-4	50120GS.....	18-8	50248.....	F-3
41329.....	C-2	450177.....	H-3	50-501.....	3-6	500052.....	F-4	50120P.....	18-8	5025.....	C-1
41330.....	C-2	450188.....	H-2	50-502.....	3-7	500053.....	F-4	50120S.....	18-8	50251.....	21-2
41331.....	C-2	450189.....	H-2	50-510.....	3-6	500054.....	F-4	50125GP.....	18-8	50252.....	21-2
41332.....	C-2	450190.....	H-2	50-512.....	3-6	500055.....	F-4	50125GS.....	18-8	50253.....	21-2
41333.....	C-2	450191.....	H-2	50-601.....	6-3	500056.....	F-4	50125P.....	18-8	50254.....	21-2
41334.....	C-2	450192.....	H-2	50-602.....	6-3	500057.....	F-4	50125S.....	18-8	50258.....	21-2
41335.....	C-2	450194.....	H-2	50-603.....	6-3	500058.....	F-4	50130GP.....	18-8	50259.....	21-2
41336.....	C-2	450195.....	H-2	50-611.....	6-3	500059.....	F-4	50130GS.....	18-8	5026.....	C-1
41337.....	C-2	450196.....	H-2	50-612.....	6-3	500060.....	F-4	50130P.....	18-8	50260.....	21-2
41338.....	C-2	450197.....	H-2	50-613.....	6-3	500061.....	F-4	50130S.....	18-8	50261.....	21-2
414038.....	H-2	450199.....	H-2	50-620.....	6-3	500062.....	F-4	50140GP.....	18-8	50264.....	21-2
414039.....	H-2	450200.....	H-2	50-621.....	6-3	500063.....	F-4	50140GS.....	18-8	50265.....	21-2
41500.....	18-26	450202.....	H-2	50-622.....	6-3	500064.....	F-5	50140P.....	18-8	50267.....	21-2
41501.....	18-26	450203.....	H-2	50-624.....	6-3	500065.....	F-5	50140S.....	18-8	50269.....	21-2
41502.....	18-26	450204.....	H-2	50-625.....	6-3	500066.....	F-5	50142.....	F-8	5027.....	C-1
41503.....	18-26	450250.....	H-2	50-701.....	2-6	500067.....	F-5	50143.....	F-8	5028.....	C-1
41504.....	18-26	450300.....	H-2	50-711.....	6-1	500069.....	F-5	50144.....	F-8	5029.....	C-1
41505.....	18-26	450400.....	H-2	50-801.....	2-9	500070.....	F-5	50145.....	F-8	5030.....	C-1
41506.....	18-26	450500.....	H-2	500000.....	F-4	500083.....	F-4	50149.....	F-8	5031.....	C-1
41507.....	18-26	450600.....	H-2	500001A.....	F-4	500086.....	F-4	50160GP.....	18-8	5032.....	C-1
41508.....	18-26	450800.....	H-2	500002A.....	F-4	500090.....	F-5	50160GS.....	18-8	5033.....	C-1
41509.....	18-26	475140.....	D-6	500003A.....	F-4	500091.....	F-5	50160P.....	18-8	5034.....	C-1
41510.....	18-26	475160.....	D-6	500004A.....	F-4	500092.....	F-5	50160S.....	18-8	5035.....	C-1
41511.....	18-26	475180.....	D-6	500005A.....	F-4	500110.....	F-4	50168.....	F-8	5036.....	C-1
41512.....	18-25	49-014.....	7-3	500006.....	F-4	500111A.....	F-4	50169.....	F-8	5037.....	C-1
41513.....	18-26	49-017.....	7-3	500007.....	F-4	500112A.....	F-4	50173.....	F-8	5038.....	C-1
41514.....	18-26	49-026.....	7-3	500008.....	F-4	500113A.....	F-4	50179.....	F-8	5039.....	C-1
416038.....	H-2	49-037.....	7-3	500009.....	F-4	500125A.....	F-5	50180.....	F-8	5040.....	C-1
418038.....	H-2	49-045.....	7-3	500010A.....	F-4	500126.....	F-4	50180GP.....	18-8	5040EPDME.....	18-4
419038.....	H-2	49-060.....	7-3	500011A.....	F-4	50024.....	21-2	50180GS.....	18-8	5041A.....	C-1
42000.....	F-7	49-200.....	7-4	500012A.....	F-4	50027.....	21-2	50180P.....	18-8	50EPDMAC.....	18-7
42002.....	F-7	49-201.....	7-4	500013A.....	F-4	50034.....	21-2	50180S.....	18-8	50EPDME3.....	18-7
420020.....	H-2	49-204.....	7-6	500014A.....	F-4	50036.....	21-2	50188.....	F-8	51-010.....	4-1
420025.....	H-2	49-206.....	7-7	500015A.....	F-4	50037.....	21-2	50208.....	F-3	51-036.....	6-15
420027.....	H-2	49-207.....	7-7	500016A.....	F-4	50038.....	21-2	50209.....	F-3	51-040.....	6-15
420028.....	H-2	49-208.....	7-8	500017.....	F-4	50043.....	21-2	50210.....	F-3	51-041.....	7-9
420029.....	H-2	49-209.....	7-8	500018.....	F-4	50047.....	21-2	50211.....	F-3	51-051.....	2-10
42003.....	F-7	49-210.....	7-5	500019.....	F-4	50050.....	21-2	50212.....	F-3	51-053.....	2-10
420050.....	H-2	49-210.....	7-9	500020.....	F-4	50056.....	21-2	50217.....	F-3	51-068.....	4-6
430142.....	H-1	49-211.....	7-5	500021.....	F-4	50057.....	21-2	50219.....	F-3	51-069.....	4-6
430162.....	H-1	49-3XX.....	7-1	500022A.....	F-4	50059.....	21-2	50220.....	F-3	51-072.....	2-6
43100ZCK-1.....	16-3	49-4XX.....	7-6	500023A.....	F-4	50060.....	21-2	50225.....	F-3	51-073.....	2-6
4320.....	16-3	49-554.....	7-5	500024A.....	F-4	50075.....	21-2	50232.....	21-2	51-104.....	6-9
43200.....	16-3	49-556.....	7-5	500025A.....	F-4	50076.....	21-2	50233.....	21-2	51-106.....	6-10
4325.....	16-3	49-7XX.....	7-2	500026A.....	F-4	50077.....	21-2	50234.....	21-2	51-112.....	20-10
43250.....	16-3	49-800.....	7-3	500027A.....	F-4	50078.....	21-2	50235.....	21-2	51-112.....	4-3
4330.....	16-3	49-801.....	7-3	500028.....	F-4	50082.....	21-2	50237.....	21-2	51-122.....	20-10
43300.....	16-3	49-802.....	7-3	500029.....	F-4	50084.....	21-2	50238.....	21-2	51-123.....	4-4
4340.....	16-3	49-8XX.....	7-2	500030.....	F-4	50085.....	21-2	50239.....	21-2	51-124.....	4-4

51-136.....	6-16	51030DS.....	18-9	51180S.....	18-12	519S30S.....	18-8	52-353.....	13-7	52-828.....	13-12
51-140.....	6-16	51030GP.....	18-9	51213GS.....	18-12	519S40GP.....	18-8	52-363.....	16-5	52-828.....	13-16
51-201.....	4-2	51030GS.....	18-9	51213S.....	18-12	519S40GS.....	18-8	52-370.....	16-4	52-831.....	13-15
51-211.....	4-1	51030P.....	18-9	51215GS.....	18-12	519S40P.....	18-8	52-380.....	16-1	52-832.....	13-15
51-215.....	4-2	51030S.....	18-9	51215S.....	18-12	519S40S.....	18-8	52-390.....	16-4	52-833.....	13-11
51-301.....	6-1	510401.....	H-2	51220GS.....	18-12	519S60GP.....	18-8	52-403.....	9-1	52-833.....	13-15
51-311.....	6-2	51040DGS.....	18-9	51220S.....	18-12	519S60GS.....	18-8	52-477.....	14-1	52-836.....	13-11
51-396.....	2-8	51040DS.....	18-9	51225GS.....	18-12	519S60P.....	18-8	52-477.....	14-2	52-836.....	13-16
51-477.....	13-8	51040GP.....	18-9	51225S.....	18-12	519S60S.....	18-8	52-477.....	14-3	52-837.....	13-13
51-477.....	13-10	51040GS.....	18-9	51230GS.....	18-12	519S80GP.....	18-8	52-477.....	14-4	52-837.....	13-16
51-524.....	4-5	51040P.....	18-9	51230S.....	18-12	519S80GS.....	18-8	52-477.....	14-5	52-838.....	13-12
51-534.....	4-5	51040S.....	18-9	51240GS.....	18-12	519S80P.....	18-8	52-477.....	13-5	52-838.....	13-16
51-620.....	6-3	510601.....	H-2	51240S.....	18-12	519S80S.....	18-8	52-477.....	13-7	52-841.....	13-15
51-621.....	6-3	51060DGS.....	18-9	51250GS.....	18-12	52-069.....	16-1	52-477.....	13-2	52-842.....	13-15
51-622.....	6-3	51060DS.....	18-9	51250S.....	18-12	52-150.....	14-1	52-477.....	13-1	52-843.....	13-11
51-623.....	6-3	51060GP.....	18-9	51260GS.....	18-12	52-150.....	14-2	52-477.....	13-10	52-843.....	13-15
51-790.....	1-16	51060GS.....	18-9	51260S.....	18-12	52-150.....	14-3	52-477.....	13-8	52-846.....	13-11
51-792.....	1-17	51060P.....	18-9	51280GS.....	18-12	52-150.....	16-2	52-477.....	13-9	52-846.....	13-16
51-793.....	13-3	51060S.....	18-9	51280S.....	18-12	52-201.....	8-1	52-478.....	14-1	52-847.....	13-13
51-794.....	2-7	510801.....	H-2	51290.....	C-3	52-203.....	8-1	52-478.....	14-2	52-847.....	13-16
51-873.....	4-3	51080DGS.....	18-9	51910GP.....	18-9	52-204.....	8-1	52-478.....	14-3	52-848.....	13-12
51-887.....	3-3	51080DS.....	18-9	51910P.....	18-9	52-211.....	8-1	52-478.....	14-8	52-848.....	13-16
51-889.....	3-4	51080GP.....	18-9	51912GP.....	18-9	52-211.....	8-4	52-478.....	14-4	52-861.....	13-15
51-893.....	2-3	51080GS.....	18-9	51912P.....	18-9	52-270.....	16-3	52-478.....	14-5	52-862.....	13-15
51-894.....	2-3	51080P.....	18-9	51913GP.....	18-9	52-271.....	9-1	52-478.....	14-7	52-863.....	13-11
51-895.....	2-2	51080S.....	18-9	51913GS.....	18-9	52-280.....	13-3	52-540.....	4-9	52-863.....	13-15
51-896.....	2-1	510S20GP.....	18-8	51913P.....	18-9	52-287.....	13-3	52-540.....	8-3	52-866.....	13-11
51009A.....	C-2	510S20GS.....	18-8	51913S.....	18-9	52-287.....	13-10	52-570.....	15-3	52-866.....	13-16
510101.....	H-2	510S20P.....	18-8	51915GP.....	18-9	52-287.....	14-3	52-572.....	15-4	52-867.....	13-13
51010A.....	C-2	510S20S.....	18-8	51915GS.....	18-9	52-287.....	14-4	52-573.....	15-4	52-867.....	13-16
51010GP.....	18-9	510S25GP.....	18-8	51915P.....	18-9	52-287.....	14-5	52-630.....	13-10	52-868.....	13-12
51010P.....	18-9	510S25GS.....	18-8	51915S.....	18-9	52-287.....	21-1	52-630.....	13-3	52-868.....	13-16
51011A.....	C-2	510S25P.....	18-8	51920GP.....	18-9	52-289.....	13-3	52-630.....	13-5	52-881.....	13-15
510126.....	H-2	510S25S.....	18-8	51920GS.....	18-9	52-289.....	16-2	52-630.....	13-8	52-882.....	13-15
51012A.....	C-2	510S30GP.....	18-8	51920P.....	18-9	52-289.....	13-10	52-630.....	13-9	52-883.....	13-15
51012GP.....	18-9	510S30GS.....	18-8	51920S.....	18-9	52-289.....	13-5	52-630.....	14-1	52-886.....	13-16
51012P.....	18-9	510S30P.....	18-8	51925GP.....	18-9	52-289.....	13-7	52-630.....	14-2	52-887.....	13-16
51013A.....	C-2	510S30S.....	18-8	51925GS.....	18-9	52-289.....	13-8	52-630.....	14-3	52-888.....	13-16
51013GP.....	18-9	510S40GP.....	18-8	51925P.....	18-9	52-289.....	13-9	52-630.....	14-4	52040.....	19-6
51013GS.....	18-9	510S40GS.....	18-8	51925S.....	18-9	52-289.....	14-1	52-630.....	14-5	52041.....	19-6
51013P.....	18-9	510S40P.....	18-8	51930GP.....	18-9	52-289.....	14-2	52-630.....	14-6	52042.....	19-6
51013S.....	18-9	510S40S.....	18-8	51930GS.....	18-9	52-302.....	20-4	52-630.....	9-1	52045.....	19-6
510151.....	H-2	510S60GP.....	18-8	51930P.....	18-9	52-309.....	10-1	52-789.....	13-5	52047.....	19-6
51015GP.....	18-9	510S60GS.....	18-8	51930S.....	18-9	52-310.....	4-8	52-789.....	13-7	53-101.....	1-2
51015GS.....	18-9	510S60P.....	18-8	51940GP.....	18-9	52-310.....	10-1	52-789.....	16-1	53-102.....	1-2
51015P.....	18-9	510S60S.....	18-8	51940GS.....	18-9	52-311.....	11-3	52-793.....	13-5	53-106.....	1-3
51015S.....	18-9	510S80GP.....	18-8	51940P.....	18-9	52-312.....	11-2	52-793.....	13-7	53-107.....	1-3
51018A.....	C-2	510S80GS.....	18-8	51940S.....	18-9	52-312.....	11-1	52-793.....	16-1	53-111.....	1-1
510201.....	H-2	510S80P.....	18-8	51960GP.....	18-9	52-324.....	12-1	52-811.....	13-15	53-112.....	1-1
51020DGS.....	18-9	510S80S.....	18-8	51960GS.....	18-9	52-324.....	13-9	52-811.....	13-14	53-113.....	1-3
51020DS.....	18-9	51113GS.....	18-12	51960P.....	18-9	52-324.....	14-1	52-812.....	13-15	53-153.....	3-13
51020GP.....	18-9	51113S.....	18-12	51960S.....	18-9	52-324.....	14-2	52-813.....	13-11	53-253.....	3-12
51020GS.....	18-9	51115GS.....	18-12	51980GP.....	18-9	52-324.....	14-3	52-813.....	13-15	53-261.....	1-18
51020P.....	18-9	51115S.....	18-12	51980GS.....	18-9	52-324.....	14-4	52-816.....	13-11	54-350.....	16-1
51020S.....	18-9	51120GS.....	18-12	51980P.....	18-9	52-324.....	14-5	52-816.....	13-16	54-360.....	8-4
51021A.....	C-2	51120S.....	18-12	51980S.....	18-9	52-326.....	12-1	52-817.....	13-13	54010.....	J-1
51024A.....	C-2	51125GS.....	18-12	519S20GP.....	18-8	52-326.....	13-9	52-817.....	13-16	54011.....	J-1
510251.....	H-2	51125S.....	18-12	519S20GS.....	18-8	52-326.....	14-1	52-818.....	13-12	54012.....	J-1
51025DGS.....	18-9	51130GS.....	18-12	519S20P.....	18-8	52-326.....	14-2	52-818.....	13-16	54014.....	J-1
51025DS.....	18-9	51130S.....	18-12	519S20S.....	18-8	52-326.....	14-4	52-821.....	13-15	54015.....	J-1
51025GP.....	18-9	51140GS.....	18-12	519S25GP.....	18-8	52-328.....	12-1	52-822.....	13-15	5501060S.....	18-14
51025GS.....	18-9	51140S.....	18-12	519S25GS.....	18-8	52-328.....	13-9	52-823.....	13-11	5501210S.....	18-14
51025P.....	18-9	51150GS.....	18-12	519S25P.....	18-8	52-328.....	14-2	52-823.....	13-15	5501240S.....	18-14
51025S.....	18-9	51150S.....	18-12	519S25S.....	18-8	52-328.....	14-3	52-826.....	13-11	5501260S.....	18-14
51027A.....	C-2	51160GS.....	18-12	519S30GP.....	18-8	52-328.....	14-4	52-826.....	13-16	5501280S.....	18-14
510301.....	H-2	51160S.....	18-12	519S30GS.....	18-8	52-328.....	14-5	52-827.....	13-13	5501513GS.....	18-14
51030DGS.....	18-9	51180GS.....	18-12	519S30P.....	18-8	52-353.....	13-5	52-827.....	13-16	5501513S.....	18-14

5502513GS.....	18-14	56-000.....	1-10	56-341.....	3-2	56-792.....	5-12	56-908.....	6-1	57713ASC.....	18-1
5502513S.....	18-14	56-000.....	1-11	56-341.....	5-14	56-792.....	5-13	56-908.....	7-13	57713E3GS.....	18-1
5502515GS.....	18-14	56-000.....	1-12	56-341.....	7-14	56-792.....	1-16	56-937.....	7-12	57713E3S.....	18-1
5502515S.....	18-14	56-000.....	1-13	56-396.....	2-8	56-792.....	1-17	56-938.....	7-12	57715ACP.....	18-1
5502520GS.....	18-14	56-000.....	1-14	56-452.....	6-15	56-798.....	1-4	56-952.....	3-14	57715AGCP.....	18-1
5502520S.....	18-14	56-000.....	1-15	56-452.....	6-16	56-798.....	1-5	57-331.....	1-11	57715AGSC.....	18-1
5503015GS.....	18-14	56-000.....	1-19	56-452.....	7-1	56-798.....	7-14	57-333.....	3-10	57715ASC.....	18-1
5503015S.....	18-14	56-000.....	1-20	56-452.....	7-14	56-802.....	7-10	57-340.....	1-12	57715E3GS.....	18-1
5503020GS.....	18-14	56-000.....	1-7	56-452.....	7-2	56-850.....	1-10	57-341.....	1-12	57715E3S.....	18-1
5503020S.....	18-14	56-000.....	1-8	56-452.....	7-4	56-850.....	1-11	57-343.....	3-11	57720ACP.....	18-1
5503025GS.....	18-14	56-000.....	1-9	56-665.....	2-2	56-850.....	1-12	57-370.....	6-6	57720AGCP.....	18-1
5503025S.....	18-14	56-000.....	2-10	56-665.....	2-3	56-850.....	1-13	57-370.....	1-13	57720AGSC.....	18-1
5504020GS.....	18-14	56-000.....	2-4	56-665.....	7-14	56-850.....	1-14	57-371.....	6-6	57720ASC.....	14-1
5504020S.....	18-14	56-000.....	2-5	56-700.....	6-4	56-850.....	1-15	57-371.....	1-13	57720ASC.....	14-2
5504025GS.....	18-14	56-000.....	3-10	56-700.....	6-6	56-850.....	1-19	57-373.....	6-6	57720ASC.....	14-3
5504025S.....	18-14	56-000.....	3-11	56-700.....	1-14	56-850.....	1-20	57-373.....	6-13	57720ASC.....	14-4
5504030GS.....	18-14	56-000.....	3-8	56-700.....	1-9	56-850.....	1-7	57-375.....	1-15	57720ASC.....	14-5
5504030S.....	18-14	56-000.....	3-9	56-700.....	2-2	56-850.....	1-9	57-376.....	2-4	57720ASC.....	18-1
5505030GS.....	18-14	56-000.....	4-1	56-700.....	2-3	56-850.....	2-10	57-378.....	6-7	57720E3GS.....	18-1
5505030S.....	18-14	56-000.....	4-2	56-700.....	2-5	56-850.....	2-4	57-378.....	1-15	57720E3S.....	18-1
5505040GS.....	18-14	56-000.....	4-5	56-700.....	2-9	56-850.....	2-5	57-390.....	6-6	57725ACP.....	18-1
5505040S.....	18-14	56-000.....	4-6	56-700.....	7-11	56-850.....	2-8	57-390.....	1-14	57725AGCP.....	18-1
5506020GS.....	18-14	56-000.....	4-7	56-701.....	5-5	56-850.....	4-1	57-391.....	6-6	57725AGSC.....	18-1
5506020S.....	18-14	56-000.....	6-1	56-701.....	5-6	56-850.....	4-2	57-391.....	1-14	57725ASC.....	18-1
5506025GS.....	18-14	56-000.....	6-11	56-701.....	6-4	56-850.....	4-3	57-393.....	6-6	57725E3GS.....	18-1
5506025S.....	18-14	56-000.....	6-12	56-701.....	6-5	56-850.....	4-5	57-393.....	6-14	57725E3S.....	18-1
5506030GS.....	18-14	56-000.....	6-13	56-701.....	6-6	56-850.....	4-6	57-396.....	2-5	57730ACP.....	18-1
5506030S.....	18-14	56-000.....	6-14	56-701.....	6-7	56-850.....	4-7	57-533.....	3-8	57730AGCP.....	18-1
5506040GS.....	18-14	56-000.....	6-17	56-701.....	1-10	56-850.....	5-2	57-543.....	3-9	57730AGSC.....	18-1
5506040S.....	18-14	56-000.....	6-18	56-701.....	1-11	56-850.....	5-3	57-560.....	1-8	57730ASC.....	14-1
5506050GS.....	18-14	56-000.....	6-2	56-701.....	1-12	56-850.....	5-4	57-561.....	1-8	57730ASC.....	14-2
5506050S.....	18-14	56-000.....	6-3	56-701.....	1-13	56-850.....	5-5	57-570.....	6-4	57730ASC.....	14-3
5508030GS.....	18-14	56-000.....	6-4	56-701.....	1-15	56-850.....	5-6	57-570.....	1-7	57730ASC.....	14-4
5508030S.....	18-14	56-000.....	6-5	56-701.....	1-7	56-850.....	6-4	57-571.....	6-4	57730ASC.....	14-5
5508040GS.....	18-14	56-000.....	6-6	56-701.....	2-4	56-850.....	6-5	57-571.....	1-7	57730ASC.....	18-1
5508040S.....	18-14	56-000.....	6-7	56-701.....	5-1	56-850.....	6-6	57-573.....	6-4	57730E3GS.....	18-1
5508050GS.....	18-14	56-000.....	7-9	56-701.....	5-2	56-850.....	6-7	57-573.....	6-11	57730E3S.....	18-1
5508050S.....	18-14	56-000.....	2-9	56-701.....	5-3	56-850.....	7-14	57-575.....	1-10	57740ACP.....	18-1
5508060GS.....	18-14	56-000.....	7-14	56-701.....	7-11	56-872.....	3-3	57-578.....	6-5	57740AGCP.....	18-1
5508060S.....	18-14	56-000.....	7-12	56-705.....	1-1	56-872.....	3-1	57-578.....	1-10	57740AGSC.....	18-1
5576.....	20-7	56-001.....	3-1	56-705.....	1-11	56-872.....	7-14	57-590.....	6-4	57740ASC.....	14-1
56-000.....	1-16	56-001.....	3-2	56-705.....	1-12	56-873.....	4-3	57-590.....	1-9	57740ASC.....	14-2
56-000.....	1-17	56-001.....	7-14	56-705.....	1-13	56-873.....	4-6	57-591.....	6-4	57740ASC.....	14-3
56-000.....	5-11	56-001.....	6-10	56-705.....	1-15	56-880.....	7-10	57-591.....	1-9	57740ASC.....	14-4
56-000.....	5-12	56-001.....	6-9	56-705.....	1-19	56-885.....	7-10	57-593.....	6-4	57740ASC.....	14-5
56-000.....	5-13	56-010.....	5-7	56-705.....	1-20	56-885.....	7-6	57-593.....	6-12	57740ASC.....	18-1
56-000.....	7-13	56-010.....	5-8	56-705.....	1-3	56-885.....	7-7	57-XXX.....	6-4	57740E3GS.....	18-1
56-000.....	2-6	56-010.....	5-9	56-705.....	1-4	56-892.....	6-1	57-XXX.....	6-6	57740E3S.....	18-1
56-000.....	20-10	56-010.....	7-14	56-705.....	1-5	56-892.....	3-3	57701AGSC.....	18-1	57750ACP.....	18-1
56-000.....	4-3	56-012.....	6-9	56-705.....	2-4	56-892.....	3-4	57701ASC.....	18-1	57750AGCP.....	18-1
56-000.....	6-10	56-015.....	3-12	56-705.....	4-1	56-892.....	5-10	57701E3GS.....	18-1	57750AGSC.....	18-1
56-000.....	6-8	56-015.....	3-13	56-705.....	4-2	56-892.....	7-14	57701E3S.....	18-1	57750ASC.....	18-1
56-000.....	6-9	56-070.....	3-10	56-705.....	4-5	56-892.....	2-6	57710ACP.....	18-1	57750E3GS.....	18-1
56-000.....	1-4	56-070.....	3-8	56-705.....	4-7	56-895.....	2-1	57710AGCP.....	18-1	57750E3S.....	18-1
56-000.....	1-5	56-070.....	3-11	56-705.....	1-14	56-895.....	2-2	57710AGSC.....	18-1	57760ACP.....	18-1
56-000.....	1-6	56-070.....	3-9	56-705.....	1-2	56-895.....	2-3	57710ASC.....	18-1	57760AGCP.....	18-1
56-000.....	2-7	56-122.....	20-10	56-705.....	2-2	56-895.....	2-6	57710E3GS.....	18-1	57760AGSC.....	18-1
56-000.....	2-8	56-123.....	1-18	56-705.....	2-3	56-895.....	2-9	57710E3S.....	18-1	57760ASC.....	14-1
56-000.....	3-12	56-123.....	4-4	56-705.....	2-5	56-895.....	3-5	57712ACP.....	18-1	57760ASC.....	14-2
56-000.....	3-13	56-124.....	4-4	56-705.....	2-9	56-895.....	3-6	57712AGCP.....	18-1	57760ASC.....	14-3
56-000.....	3-14	56-125.....	16-2	56-705.....	4-6	56-895.....	3-7	57712AGSC.....	18-1	57760ASC.....	14-4
56-000.....	3-15	56-152.....	3-15	56-705.....	7-11	56-895.....	6-3	57712ASC.....	18-1	57760ASC.....	14-5
56-000.....	1-1	56-202.....	4-3	56-715.....	1-19	56-895.....	7-14	57712E3GS.....	18-1	57760ASC.....	18-1
56-000.....	1-2	56-312.....	6-8	56-715.....	1-20	56-908.....	1-16	57712E3S.....	18-1	57760E3GS.....	18-1
56-000.....	1-3	56-314.....	7-14	56-715.....	7-11	56-908.....	1-17	57713ACP.....	18-1	57760E3S.....	18-1
56-000.....	1-18	56-314.....	6-8	56-792.....	2-7	56-908.....	2-6	57713AGCP.....	18-1	57780ACP.....	18-1
56-000.....	4-4	56-320.....	7-10	56-792.....	5-11	56-908.....	2-7	57713AGSC.....	18-1	57780AGCP.....	18-1

57780AGSC.....	18-1	60018000.....	20-1	60146.....	F-7	60236.....	21-2	61243.....	C-3	61540.....	C-6
57780ASC.....	14-1	60018100.....	20-1	60147.....	F-7	60237.....	21-2	61244.....	C-3	61545.....	C-6
57780ASC.....	14-2	60018200.....	20-1	60148.....	F-7	60238.....	21-2	6125.....	C-7	6155.....	C-6
57780ASC.....	14-3	60027.....	21-2	60149.....	F-7	60239.....	21-2	61250.....	C-7	61550.....	C-6
57780ASC.....	14-4	60028.....	21-2	60150.....	F-7	60243.....	21-2	61251.....	C-3	61555.....	C-6
57780ASC.....	14-5	60029.....	21-2	60151.....	F-7	60244.....	21-2	6126.....	C-7	6156.....	C-7
57780ASC.....	18-1	60038.....	21-2	60152.....	F-7	60245.....	21-2	61260.....	C-7	61560.....	C-6
57780E3GS.....	18-1	60058000.....	20-1	60153.....	F-8	60246.....	21-2	61261.....	C-3	61565.....	C-6
57780E3S.....	18-1	60080000.....	20-1	60154.....	F-8	60247.....	21-2	6128.....	C-6	6157.....	C-6
5785.....	20-8	60103.....	F-7	60157.....	F-8	60248.....	21-2	61280.....	C-6	61570.....	C-6
5786.....	20-8	60104.....	F-7	60159.....	F-8	60249.....	21-2	6129.....	C-6	61575.....	C-6
5792-01.....	20-8	60105.....	F-7	60160.....	F-8	60251.....	21-2	61290.....	C-6	6158.....	C-6
58-153.....	3-15	60106.....	F-7	60161.....	F-8	60252.....	21-2	6132.....	C-6	61580.....	C-6
58-170.....	2-8	60107.....	F-7	60162.....	F-8	60253.....	21-2	61320.....	C-6	61585.....	C-6
58-172.....	1-6	60108.....	F-7	60163.....	F-8	60254.....	21-2	61325.....	C-6	61590.....	C-6
58-174.....	1-6	60109.....	F-7	60164.....	F-8	60260.....	F-8	6133.....	C-6	61595.....	C-7
58-440.....	3-3	60110.....	F-7	60165.....	F-8	60261.....	F-8	61330.....	C-6	61600.....	C-7
58-441.....	3-1	60111.....	F-7	60166.....	F-8	60262.....	F-8	61335.....	C-6	61605.....	C-7
58-445.....	3-2	60112.....	F-7	60167.....	F-8	60265.....	F-7	6134.....	C-6	61610.....	C-7
58-447.....	3-1	60113.....	F-7	60168.....	F-8	60266.....	F-7	61340.....	C-6	61615.....	C-7
58-450.....	3-1	60114.....	F-7	60170.....	F-8	60267.....	F-7	61345.....	C-6	61620.....	C-7
58-946.....	1-6	60115.....	F-7	60171.....	F-8	60268.....	F-7	61350.....	C-6	61625.....	C-7
58-970.....	2-7	60116.....	F-7	60173.....	F-8	60270.....	F-7	61355.....	C-6	6163.....	C-6
58-973.....	1-4	60117.....	F-7	60175.....	F-7	60271.....	F-7	61360.....	C-6	61635.....	C-7
58-974.....	1-5	60118.....	F-8	60176.....	F-7	60272.....	F-7	61365.....	C-6	61636.....	C-7
58-981.....	1-4	60119.....	F-8	60177.....	F-7	60281.....	21-2	6137.....	C-7	61640.....	C-7
58-982.....	1-5	6012.....	1-16	60178.....	F-7	60282.....	21-2	61370.....	C-6	61645.....	C-7
58-986.....	3-14	6012.....	1-17	60179.....	F-7	60283.....	21-2	61375.....	C-6	61650.....	C-7
5801.....	20-7	6012.....	2-6	60180.....	F-7	60285.....	21-2	6138.....	C-7	61655.....	C-7
5802.....	20-7	6012.....	2-7	60181.....	F-7	60286.....	F-8	61380.....	C-6	61660.....	C-7
5803.....	20-7	6012.....	2-8	60182.....	F-7	60287.....	21-2	61385.....	C-6	61665.....	C-7
5807.....	20-6	6012.....	20-10	60183.....	F-7	60288.....	21-2	61390.....	C-6	61670.....	C-7
5808.....	20-6	6012.....	4-3	60184.....	F-7	60291.....	F-8	61395.....	C-6	61675.....	C-7
5809.....	20-6	6012.....	4-6	60185.....	F-7	60293.....	F-8	61400.....	C-6	61680.....	C-7
5839.....	20-7	6012.....	5-11	60186.....	F-7	60294.....	F-8	61405.....	C-6	61685.....	C-7
59-300.....	13-7	6012.....	5-12	60187.....	F-7	60295.....	F-8	61410.....	C-6	61690.....	C-8
59-300.....	15-3	6012.....	5-13	60190.....	F-8	60296.....	F-8	61415.....	C-6	61695.....	C-8
59-300.....	18-24	6012.....	6-1	60191.....	F-8	60299.....	F-8	61420.....	C-6	6170.....	C-7
59-590.....	15-1	6012.....	7-1	60192.....	F-8	6040EPDME.....	18-4	61425.....	C-6	6171.....	C-7
59-590.....	18-24	6012.....	7-2	60194.....	F-8	6050EPDME.....	18-4	6143.....	C-8	63-000.....	5-13
59-590.....	14-1	6012.....	7-6	60196.....	F-7	60EPDMAC.....	18-7	61430.....	C-6	7021501EPDME.....	18-6
59-590.....	14-2	60120.....	F-8	60198.....	F-7	60EPDME3.....	18-7	61435.....	C-6	7021501FES.....	18-6
59-590.....	14-3	60121.....	F-8	60200.....	F-7	61-441.....	3-2	6144.....	C-8	7021505EPDME.....	18-6
59-590.....	14-4	60122.....	F-8	60202.....	F-7	61-441.....	5-14	61445.....	C-7	7021505FES.....	18-6
59-590.....	14-5	60123.....	F-8	60204.....	F-7	61-442.....	3-2	6145.....	C-8	7021575EPDME.....	18-6
59-590.....	8-2	60124.....	F-8	60206.....	F-7	61-442.....	5-14	61450.....	C-7	7021575FES.....	18-6
59-591.....	8-2	60125.....	F-8	60207.....	F-8	6104.....	C-7	61455.....	C-7	7022001EPDME.....	18-6
59-592.....	15-1	60126.....	F-8	60208.....	F-8	6106.....	C-6	6146.....	C-8	7022001FES.....	18-6
59-801.....	15-2	60127.....	F-8	60209.....	F-8	6107.....	C-6	61460.....	C-7	7022001GRVES.....	18-6
59-802.....	15-2	60128.....	F-8	60210.....	F-8	6109.....	C-6	61465.....	C-7	7022001MES.....	18-6
59025EPDME.....	15-1	60129.....	F-8	60211.....	F-8	6110.....	C-6	61470.....	C-7	7022005EPDME.....	18-6
59030EPDME.....	15-1	60130.....	F-8	60212.....	F-8	6111.....	C-6	61475.....	C-7	7022005FES.....	18-6
59040EPDME.....	15-1	60131.....	F-8	60213.....	F-8	6112.....	C-6	61480.....	C-7	7022075EPDME.....	18-6
59050EPDME.....	15-1	60132.....	F-8	60216.....	F-8	61126.....	19-6	61485.....	C-7	7022075FES.....	18-6
59060EPDME.....	15-1	60133.....	F-8	60219.....	F-8	6115.....	C-7	61490.....	C-7	7022501EPDME.....	18-6
59080EPDME.....	15-1	60134.....	F-8	60221.....	F-8	6116.....	C-7	61495.....	C-7	7022501FES.....	18-6
59100EPDME.....	15-1	60135.....	F-8	60222.....	F-8	6117.....	C-7	6150.....	C-7	7022505EPDME.....	18-6
5971.....	20-7	60136.....	F-8	60223.....	F-8	6123.....	C-7	61500.....	C-7	7022505FES.....	18-6
5972.....	20-7	60137.....	F-8	60226.....	F-8	61230.....	C-7	61505.....	C-7	7022513EPDME.....	18-6
60001.....	21-2	60138.....	F-8	60227.....	F-8	61231.....	C-3	61510.....	C-7	7022513GRVES.....	18-6
60002.....	21-2	60139.....	F-8	60228.....	F-8	61232.....	C-3	61515.....	C-7	7022513MES.....	18-6
60002000.....	20-1	60140.....	F-8	60229.....	F-8	61233.....	C-3	61520.....	C-7	7022515EPDME.....	18-6
60003.....	21-2	60141.....	F-8	60230.....	F-8	61234.....	C-3	61525.....	C-7	7022515GRVES.....	18-6
60003000.....	20-1	60142.....	F-8	60232.....	21-2	6124.....	C-7	6153.....	C-6	7022515MES.....	18-6
60004.....	21-2	60143.....	F-7	60233.....	21-2	61240.....	C-7	61530.....	C-7	7022575EPDME.....	18-6
60004000.....	20-1	60144.....	F-7	60234.....	21-2	61241.....	C-3	61535.....	C-6	7022575FES.....	18-6
60010.....	21-2	60145.....	F-7	60235.....	21-2	61242.....	C-3	6154.....	C-6	7023001EPDME.....	18-6



Fire Protection Products

Price Book
Part Number Index

Effective Date
March 1, 2013

Table with 8 columns listing part numbers and their corresponding prices. The table is organized in a grid format with 8 columns and approximately 100 rows of data.

Price Book Part Number Index

7305030ERP.....	18-21	7308030ERCS.....	18-23	73392.....	18-14	74309.....	18-18	75157.....	18-19	75502.....	18-16
7306013EGP.....	18-20	7308030ERS.....	18-21	73393.....	18-14	74310.....	18-18	75158.....	18-19	75503.....	18-16
7306013EGRP.....	18-21	7308030ES.....	18-20	73396.....	18-14	74311.....	18-18	75309.....	18-12	75504.....	18-16
7306013EP.....	18-20	7308040ECS.....	18-22	73398.....	18-14	74312.....	18-18	75310.....	18-12	75505.....	18-16
7306013ERP.....	18-21	7308040EGCS.....	18-22	73399.....	18-14	74313.....	18-18	75315.....	18-12	75506.....	18-16
7306015ECS.....	18-22	7308040EGRCS.....	18-23	73400.....	18-14	74314.....	18-18	75323.....	18-12	75507.....	18-16
7306015EGCS.....	18-22	7308040EGRS.....	18-21	73401.....	18-14	74315.....	18-19	75410.....	18-13	75508.....	18-16
7306015EGRCS.....	18-23	7308040EGS.....	18-20	73402.....	18-14	74316.....	18-19	75411.....	18-13	75509.....	18-16
7306015EGRS.....	18-21	7308040ERCS.....	18-23	73403.....	18-14	74317.....	18-19	75412.....	18-13	75510.....	18-16
7306015EGS.....	18-20	7308040ERS.....	18-21	73404.....	18-14	74318.....	18-19	75413.....	18-13	75511.....	18-16
7306015ERCS.....	18-23	7308040ES.....	18-20	73406.....	18-14	74319.....	18-19	75414.....	18-13	75512.....	18-16
7306015ERS.....	18-21	73081.....	D-6	73409.....	18-14	74322.....	18-19	75415.....	18-13	75513.....	18-16
7306015ES.....	18-20	73082.....	D-6	73410.....	18-14	74323.....	18-19	75416.....	18-13	75514.....	18-16
7306020ECS.....	18-22	730EGS-1.....	18-20	73422.....	18-14	74324.....	18-19	75417.....	18-13	75515.....	18-16
7306020EGCS.....	18-22	730EGS-2.....	18-20	73423.....	18-14	74325.....	18-19	75418.....	18-13	75516.....	18-16
7306020EGRCS.....	18-23	730EGS-2.....	18-21	73424.....	18-14	74326.....	18-19	75419.....	18-13	75517.....	18-16
7306020EGRS.....	18-21	730EGS-2.....	18-22	73425.....	18-14	74328.....	18-14	75420.....	18-13	75518.....	18-16
7306020EGS.....	18-20	730EGS-2.....	18-23	73553.....	18-15	74330.....	18-19	75421.....	18-13	75519.....	18-16
7306020ERCS.....	18-23	730EGS-3.....	18-20	73554.....	18-15	74331.....	18-19	75422.....	18-13	75520.....	18-16
7306020ERS.....	18-21	730EGS-3.....	18-21	73555.....	18-15	74335.....	18-18	75423.....	18-13	75521.....	18-16
7306020ES.....	18-20	730EGS-3.....	18-22	73557.....	18-15	74336.....	18-18	75424.....	18-13	75522.....	18-16
7306025ECS.....	18-22	730EGS-3.....	18-23	73559.....	18-15	74337.....	18-18	75425.....	18-13	75523.....	18-16
7306025EGCS.....	18-22	730EGS-4.....	18-20	73590.....	18-13	74338.....	18-18	75426.....	18-13	75524.....	18-16
7306025EGRCS.....	18-23	730EGS-4.....	18-21	73591.....	18-13	74339.....	18-18	75427.....	18-13	75525.....	18-16
7306025EGRS.....	18-21	730EGS-4.....	18-22	73592.....	18-13	74405.....	18-18	75428.....	18-13	75526.....	18-16
7306025EGS.....	18-20	730EGS-4.....	18-23	73594.....	18-13	74406.....	18-18	75429.....	18-13	75527.....	18-16
7306025ERCS.....	18-23	730EGS-5.....	18-20	73595.....	18-13	74407.....	18-18	75430.....	18-13	75528.....	18-16
7306025ERS.....	18-21	730EGS-5.....	18-21	73596.....	18-13	74408.....	18-18	75431.....	18-13	75529.....	18-16
7306025ES.....	18-20	730EGS-5.....	18-22	73597.....	18-13	7501505S.....	18-11	75432.....	18-13	75534.....	18-16
7306030ECS.....	18-22	730EGS-5.....	18-23	73608.....	18-16	75015075S.....	18-11	75433.....	18-13	75546.....	18-16
7306030EGCS.....	18-22	730EGS-6.....	18-20	73609.....	18-16	7501510S.....	18-11	75435.....	18-13	75559.....	18-12
7306030EGRCS.....	18-23	730EGS-6.....	18-21	73610.....	18-16	7502005S.....	18-11	75436.....	18-13	75560.....	18-12
7306030EGRS.....	18-21	730EGS-6.....	18-22	73611.....	18-16	75020075S.....	18-11	75437.....	18-13	75579.....	18-12
7306030EGS.....	18-20	730EGS-6.....	18-23	73621.....	18-13	7502010S.....	18-11	75438.....	18-13	75580.....	18-12
7306030ERCS.....	18-23	730EGS-7.....	18-20	73622.....	18-13	7502505S.....	18-11	75439.....	18-13	75590.....	18-16
7306030ERS.....	18-21	730EGS-7.....	18-21	73623.....	18-13	75025075S.....	18-11	75440.....	18-13	75840.....	18-17
7306030ES.....	18-20	730EGS-7.....	18-22	73624.....	18-13	7502510S.....	18-11	75441.....	18-13	75841.....	18-17
7306040ECS.....	18-22	730EGS-7.....	18-23	73625.....	18-13	75098.....	18-18	75442.....	18-13	75842.....	18-17
7306040EGCS.....	18-22	730EGS-8.....	18-20	73629.....	18-13	75099.....	18-18	75443.....	18-13	75843.....	18-17
7306040EGRCS.....	18-23	730EGS-8.....	18-21	73630.....	18-13	75100.....	18-18	75444.....	18-13	75845.....	18-17
7306040EGRS.....	18-21	730EGS-8.....	18-22	73631.....	18-13	75101.....	18-18	75445.....	18-13	75846.....	18-17
7306040EGS.....	18-20	730EGS-8.....	18-23	73691.....	18-16	75102.....	18-18	75446.....	18-13	75847.....	18-17
7306040ERCS.....	18-23	730EGS-9.....	18-20	73694.....	18-16	75103.....	18-18	75465.....	18-15	75848.....	18-17
7306040ERS.....	18-21	730EGS-9.....	18-21	73695.....	18-16	75104.....	18-18	75466.....	18-15	75849.....	18-17
7306040ES.....	18-20	730EGS-9.....	18-22	73696.....	18-16	75105.....	18-18	75470.....	18-13	75850.....	18-17
73072.....	D-6	730EGS-9.....	18-23	73697.....	18-16	75106.....	18-18	75471.....	18-13	75851.....	18-17
73073.....	D-6	73230.....	18-15	73756.....	18-14	75107.....	18-18	75472.....	18-13	75852.....	18-17
73074.....	D-6	73231.....	18-15	73758.....	18-14	75108.....	18-18	75473.....	18-13	75853.....	18-17
73075.....	D-6	73232.....	18-15	73764.....	18-14	75121.....	18-18	75474.....	18-13	76755.....	18-16
73076.....	D-6	73233.....	18-15	73766.....	18-14	75122.....	18-18	75475.....	18-13	76757.....	18-17
73077.....	D-6	73234.....	18-15	73767.....	18-14	75123.....	18-18	75476.....	18-13	76758.....	18-17
73078.....	D-6	73235.....	18-15	73794.....	18-17	75124.....	18-18	75477.....	18-13	76759.....	18-17
73079.....	D-6	73236.....	18-15	73795.....	18-17	75125.....	18-18	75478.....	18-13	76768.....	18-16
73080.....	D-6	73237.....	18-15	73796.....	18-17	75126.....	18-18	75479.....	18-13	76769.....	18-16
7308025ECS.....	18-22	73238.....	18-15	73797.....	18-17	75129.....	18-18	75480.....	18-13	76771.....	18-16
7308025EGCS.....	18-22	73250.....	18-15	73799.....	18-17	75130.....	18-18	75481.....	18-13	76772.....	18-16
7308025EGRCS.....	18-23	73251.....	18-15	74254.....	18-15	75131.....	18-18	75482.....	18-13	76773.....	18-16
7308025EGRS.....	18-21	73252.....	18-15	74265.....	18-15	75132.....	18-18	75483.....	18-13	76774.....	18-16
7308025EGS.....	18-20	73253.....	18-15	74283.....	18-15	75133.....	18-18	75484.....	18-13	76775.....	18-16
7308025ERCS.....	18-23	73254.....	18-15	74292.....	18-18	75148.....	18-19	75485.....	18-13	76800.....	18-17
7308025ERS.....	18-21	73255.....	18-15	74293.....	18-18	75150.....	18-19	75489.....	18-13	76801.....	18-17
7308025ES.....	18-20	73256.....	18-15	74294.....	18-18	75151.....	18-19	75490.....	18-15	76802.....	18-17
7308030ECS.....	18-22	73260.....	18-15	74295.....	18-18	75152.....	18-19	75491.....	18-15	76803.....	18-17
7308030EGCS.....	18-22	73261.....	18-15	74296.....	18-18	75153.....	18-19	75492.....	18-15	76804.....	18-17
7308030EGRCS.....	18-23	73262.....	18-15	74297.....	18-18	75154.....	18-19	75493.....	18-15	76805.....	18-17
7308030EGRS.....	18-21	73263.....	18-15	74298.....	18-18	75155.....	18-19	75500.....	18-16	76806.....	18-17
7308030EGS.....	18-20	73264.....	18-15	74299.....	18-18	75156.....	18-19	75501.....	18-16	76807.....	18-17



Price Book
Part Number Index

Table with 5 columns of part numbers and their corresponding specifications. The table lists various fire protection products such as 76808, 80080, 80220, 81803000, and 86214, along with their respective part numbers and specifications.

86284.....	F-5	90-480.....	13-17	90642.....	D-3	92-322.....	13-7	TC1004.....	21-5
86285.....	F-5	90-480.....	13-4	90643.....	D-3	92-324.....	12-1	TC1005X.....	21-5
86286.....	F-5	90-491.....	13-17	90644.....	D-3	92-326.....	12-1	TC1005X.....	21-6
86287.....	F-5	90-491.....	13-6	90645.....	D-3	92-343.....	13-10	TC1006.....	21-6
86289.....	F-5	90-680.....	13-17	90650.....	D-4	92-343.....	13-8	TC1007.....	21-6
86291.....	F-5	90-680.....	13-4	90651.....	D-4	92-343.....	13-9	TC1008.....	21-6
86292.....	F-5	90-691.....	13-17	90652.....	D-4	92-343.....	14-1	TC1009.....	21-6
86293.....	F-5	90-691.....	13-6	90653.....	D-4	92-343.....	14-2	TC1010.....	21-6
86294.....	F-5	90-880.....	13-17	90654.....	D-4	92-343.....	14-3	TC1011.....	21-5
86295.....	F-5	90-880.....	13-4	90655.....	D-4	92-343.....	14-4	TC1012C.....	21-4
86296.....	F-5	90055.....	19-1	90671.....	D-4	92-343.....	14-5	TC1012M.....	21-4
86297.....	F-5	90056.....	19-1	90672.....	D-4	92-343.....	13-5	TC1013C.....	21-4
86322.....	F-5	90180.....	H-4	90673.....	D-4	92-343.....	13-7	TC1014C.....	21-4
86323.....	F-8	90181.....	H-4	90674.....	D-4	92-343.....	16-2	TC1015L.....	21-4
86324.....	F-8	90182.....	H-4	90675.....	D-4	92-343.....	8-1	TC1016.....	21-4
86326.....	F-8	90183.....	H-4	90680.....	D-4	92-343.....	16-1	TC1017C.....	21-5
86340.....	F-5	90184.....	H-4	90681.....	D-4	92-343.....	13-3	TC1018C.....	21-3
86341.....	F-5	90185.....	H-4	90682.....	D-4	92-370.....	16-4	TC1018M.....	21-3
86342.....	F-6	90186.....	H-4	90683.....	D-4	92-414.....	20-4	TC1019.....	21-5
86710.....	F-4	90187.....	H-4	90684.....	D-4	92-445.....	20-3	TC1020C.....	21-4
86711.....	F-4	90188.....	H-4	90685.....	D-4	92-470.....	20-5	TC1021C.....	21-4
86712.....	F-4	90189.....	H-4	90695.....	D-4	92-477.....	13-2	TC1022C.....	21-4
86713.....	F-4	90191.....	H-4	90696.....	D-4	92-570.....	15-4	TC1023C.....	21-4
86714.....	F-4	90192.....	H-4	90697.....	D-4	92-572.....	15-4	TC1024C.....	21-4
86715.....	F-4	90193.....	H-4	90698.....	D-4	92-630.....	9-1	TC1027C.....	21-3
86755.....	F-6	90194.....	H-4	90699.....	D-4	92733.....	D-4	TC1027M.....	21-3
86756.....	F-6	90195.....	H-4	90701.....	D-4	92734.....	D-4	TC1028M.....	21-3
86757.....	F-6	90235.....	H-7	90725.....	D-4	92735.....	D-4	TC1029L.....	21-3
86762.....	F-6	90236.....	H-7	90726.....	D-4	92736.....	D-4	TC1030SS.....	21-4
86772.....	F-6	90237.....	H-7	90733.....	D-4	97602401.....	20-1	TC1030ZX.....	21-4
86780.....	F-5	90238.....	H-7	90734.....	D-4	97602501.....	20-1	TC1031SSC.....	21-4
86781.....	F-5	90239.....	H-7	90735.....	D-4	HS1.....	H-1	TC1031ZC.....	21-4
86782.....	F-5	90245.....	H-7	90736.....	D-4	I61-441-1-360.....	3-2	TC1032C.....	21-4
88100.....	F-2	90246.....	H-7	90740.....	19-6	I61-441-1-360.....	5-14	TC1033SS.....	21-4
88101.....	F-2	90355.....	19-6	90741.....	19-6	I61-442-1-360.....	3-2	TC1033Z.....	21-4
88102.....	F-2	90356.....	19-6	90743.....	19-6	I61-442-1-360.....	5-14	TC1034Q.....	21-4
88103.....	F-2	90357.....	19-6	90744C.....	19-6	NB1.....	H-1	TC1100L.....	21-5
88104.....	F-2	90360.....	H-1	90765.....	D-4	NB10550.....	18-7	TC1100S.....	21-5
88105.....	F-2	90361.....	H-1	91-106.....	5-1	NB10650.....	18-7	TC155.....	21-3
88106.....	F-2	90362.....	H-1	91-106.....	5-2	NB125.....	H-1	TC155G.....	21-3
88107.....	F-2	90363.....	H-1	91-106.....	5-3	NB12575.....	18-7	TC172.....	21-3
88108.....	F-2	90364.....	H-1	91-106.....	5-4	NB15.....	H-1	TC172G.....	21-3
88109.....	F-2	90365.....	H-1	91-106.....	3-2	NB2.....	H-1	TC4401.....	21-6
88111N.....	F-2	90366.....	H-1	91-106.....	5-14	NB37225.....	18-7	TC4402.....	21-6
88112N.....	F-2	90367.....	H-1	91-556.....	7-5	NB50300.....	18-7	TC4403.....	21-6
88113N.....	F-2	90368.....	H-1	91189.....	H-4	NB62325.....	18-7	TC4404.....	21-6
88114N.....	F-2	90369.....	H-1	91346.....	19-6	NB62475.....	18-7	TC4406.....	21-6
88115N.....	F-2	90370.....	H-1	91725.....	D-4	NB75.....	H-1		
88116N.....	F-2	90371.....	H-1	91733.....	D-4	NB75475.....	18-7		
88117N.....	F-2	90372.....	H-1	91734.....	D-4	NB87650.....	18-7		
88118N.....	F-2	90373.....	H-1	91735.....	D-4	PT1000.....	18-7		
88119N.....	F-2	90374.....	H-1	91736.....	D-4	STP1305ES.....	18-11		
88120N.....	F-2	90375.....	H-1	92-000.....	4-1	STP13075ES.....	18-11		
88121B.....	F-2	90400.....	19-6	92-000.....	4-2	STP1310ES.....	18-11		
88122B.....	F-2	90401.....	19-6	92-000.....	7-13	STP1505ES.....	18-11		
88123B.....	F-2	90610.....	D-3	92-020.....	20-5	STP15075ES.....	18-11		
88124B.....	F-2	90611.....	D-3	92-200.....	8-2	STP1510ES.....	18-11		
88125B.....	F-2	90612.....	D-3	92-210.....	8-4	STP2005ES.....	18-11		
88126B.....	F-2	90613.....	D-3	92-270.....	16-3	STP20075ES.....	18-11		
88127B.....	F-2	90614.....	D-3	92-280.....	13-4	STP2010ES.....	18-11		
88128B.....	F-2	90620.....	D-3	92-280.....	13-3	STP2505ES.....	18-11		
88129B.....	F-2	90621.....	D-3	92-289.....	16-2	STP25075ES.....	18-11		
88130B.....	F-2	90622.....	D-3	92-302.....	20-4	STP2510ES.....	18-11		
90-280.....	13-17	90623.....	D-3	92-310.....	10-1	TC100.....	21-5		
90-280.....	13-4	90624.....	D-3	92-311.....	11-3	TC1000.....	21-5		
90-380.....	13-17	90625.....	D-3	92-312.....	11-2	TC1002.....	21-5		
90-380.....	13-4	90641.....	D-3	92-322.....	12-1	TC1003.....	21-5		

tyco

Fire Protection Products



WORLDWIDE HEADQUARTERS

Tyco Fire & Building Products
1400 Pennbrook Parkway
Lansdale, PA 19446
Tel: 215-362-0700, 800-523-6512
Fax: 215-362-5385
www.Tyco-Fire.com

UNITED STATES

Central Sprinkler Company
1400 Pennbrook Parkway
Lansdale, PA 19446
Tel: 215-362-0700, Fax: 215-362-5385

Brea, CA:

Tel: (800) 310-3366, Fax: 714-993-6043

Decatur, GA:

Tel: (800) 241-9370, Fax: 404-244-7375

Norristown, PA:

Tel: (800) 523-2753, Fax: 610-239-9936

Jessup, MD:

Tel: (800) 950-9233, Fax: 301-604-7138

Carol Stream, IL:

Tel: (800) 323-9485, Fax: 630-871-7464

Coppell, TX:

Tel: (800) 442-3541, (972) 745-0043,
Fax: 972-745-8594

Kent, WA:

Tel: (800) 843-2919, Fax: 253-872-6547

Avon, MA:

Tel: (800) 333-7775, Fax: 508-583-0034

Pompano Beach, FL:

Tel: (877) 320-1818, (954) 781-0866,
Fax: 954-781-1475

Murray UT:

Tel: (800) 486-2767, Fax: 801-269-0733

Tigard, OR:

Tel: 503-620-4203, Fax: 503-620-3817

Parma, OH:

Tel: (800) 741-5833, Fax: 216-265-8354

Kansas City, MO:

Tel: (800) 245-9178, Fax: 816-842-4433

UNITED STATES (cont.)

Gem Sprinkler & Star Sprinkler
7071 S. 13th Street, Ste. 103
Oak Creek, WI 53154
Tel: 877-436-8926, Fax: 877-866-9250

CANADA

Regional Headquarters
12-16715 Yonge Street, Suite 316
Newmarket, Ontario L3X 1X4
Tel: 866-688-9707, 705-422-0010
Fax 705-422-1396

EUROPE & MIDDLE EAST

Regional Headquarters
Kopersteden 1, NL-7547 TJ Enschede
P.O. Box 198, 7500 AD
Enschede, The Netherlands
Tel: 31-53-428-4444, Fax: 31-53-428-3377

Stockport, UK:

Tel: 44-161-477-1886, Fax 44-161-477-6729

Paris Nord II, France:

Tel: 33-1-48-178-727, Fax 33-1-48-178-720

Rodgau Germany:

Tel: 49-6106-84455, Fax 49-6106-18177

Coslada Madrid, Spain:

Tel: 34-1-669-3906, Fax 34-1-669-2018

Lørenskog, Norway:

Tel: 47-67-91-77-00, Fax 47-67-91-77-15

Lammhult, Sweden:

Tel: 46-472-269-980, Fax 46-472-269-989

Dublin, Ireland:

Tel: 353-166-839-82, Fax 353-166-822-54

Bolzano, Italy:

Tel: 39-0471-252-091, Fax 39-0471-254-058

Milano, Italy:

Tel: 39-0293-548-736, Fax 39-0293-548-690

Dubai, United Arab Emirates:

Tel: 971-488-38689, Fax 971-488-38674

Budapest, Hungary:

Tel: 36-148-11-383, Fax 36-120-34-427

Wels/Thalheim, Austria:

Tel: 43-072-42-65-054, Fax 43-072-42-74-393

LATIN AMERICA

Regional Headquarters
South America, Central America & Caribbean
1802 S.W. 2nd St.
Pompano Beach, FL 33069
Tel: 954-781-0866, Fax 954-781-9330

Regional Headquarters - Mexico

Hamburgo 231A Piso 2
Colonia Juarez
Mexico, D.F. 06600 Mexico
Tel: 525-55-2075766, Fax: 525-55-2077566

ASIA

Regional Headquarters

No.45 Tuas Avenue 9,
Singapore 639189

Central Sprinkler Company

Singapore:

Tel: 65-6743-3212, Fax 65-6743-9181

Shanghai, China:

Tel: 86-21-5868-3300, Fax 86-21-5868-1160

Beijing, China:

Tel: 86-10-6515-6191, Fax 86-10-6515-6157

Chengdu, China:

Tel: 86-28-689-9440, Fax 86-28-666-2538

Gem Sprinkler Company & Star Sprinkler Inc.

Singapore:

Tel: 65-6861-1655, Fax 65-6861-1312

Kuala Lumpur, Malaysia:

Tel: 60-3-8024-6773, Fax 60-3-8024-2180

Hong Kong:

Tel: 852-2595-0686, Fax 852-2505-5826

www.tyco-fire.com

Distributed by:

