



Features

- End drain.
- Integral lumbar support and armrests for comfort.
- Textured bottom surface.
- 66" 1676 mm) x 35-7/8" (911 mm) x 20" (508 mm)

Material

- Acrylic

Installation

- Drop-in

Recommended Accessories

- K- 1234 Apron
- K- 1491 Bath/Whirlpool Pillow
- K- 7161-AF Bath Drain
- K- 24916 Wireless Music Kit



Codes/Standards





- CSA B45.5/IAPMO Z124
- ASTM E162
- ASTM E662
- Greenguard UL 2818 - Gold

KOHLER® One-Year Limited Warranty

See website for detailed warranty information.

Available Color/Finishes

Color tiles intended for reference only.

Color	Code	Description
	0	White
	96	Biscuit
	47	Almond
	NY	Dune
	G9	Sandbar

No change in measurements if connected with drain illustrated. (K-7161-AF)

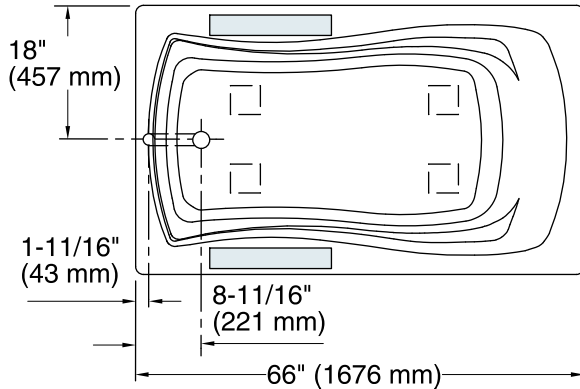

Recommended faucet area.

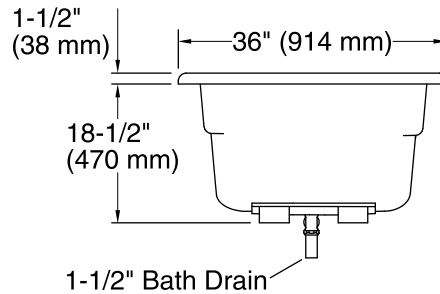
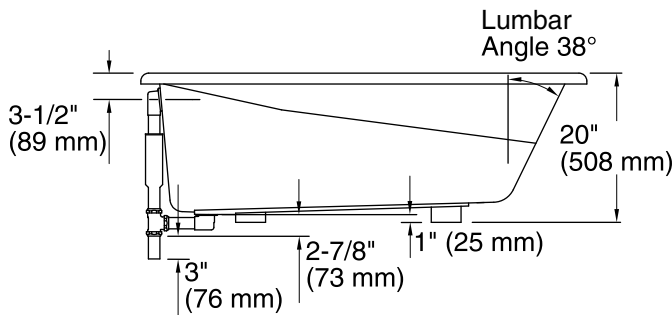
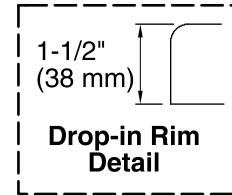

Technical Information

All product dimensions are nominal.

Installation:	Drop-in
Drain location:	End
Basin area, bottom:	48" x 24" (1219 mm x 610 mm)
Basin area, top:	59" x 30" (1499 mm x 762 mm)
Weight:	65 lbs (29.5 kg)
Minimum floor load:	39 lbs/ft ² (190.4 kg/m ²)
Water depth:	14" (356 mm)
Water capacity:	67 gal (253.6 L)
Cutout:	Drop-in, 64" x 34" (1626 mm x 864 mm)

Notes

Measure your actual product for rough-in details.

Install this product according to the installation instructions.

The hot water supply should be 70% of the capacity of the bath or greater. Installations will vary.