

Features

- 36-inch minimum base cabinet width.
- Offset double bowl.
- Three oversized faucet holes with one oversized accessory hole to the right and one oversized accessory hole to the left.
- 9 inch depth.
- Includes cutout templates.

Material

- KOHLER® enameled cast iron.

Installation

- Under-mount.
- Strainer not included.

Recommended Accessories

- K-9000 P-Trap
- K-9234 Left-Bowl Sink Rack
- K-6377 Sponge Caddy
- K-6378 Kitchen Brush Caddy
- K-6379 Kitchen Squeegee
- K-6382 Disinfecting Wipes Dispenser
- K-6383 Soap Dispenser
- K-8618 Paper Towel Holder
- K-8619 Flexible Kitchen Mat
- K-8624 Dish Scraper
- K-8801 Sink Strainer
- K-8799 Sink Strainer

Components

Product includes:

- K-6239 Colander with Cutting Board
- K-9234 Left-Bowl Sink Rack
- K-6194 Utility Rack With Soaking Cup



Codes/Standards















ASME A112.19.1/CSA B45.2

KOHLER® Enameled Cast Iron Kitchen Sink Lifetime Limited Warranty

See website for detailed warranty information.

Available Color/Finishes

Color tiles intended for reference only.

Color	Code	Description
	0	White
	FF	Sea Salt™
	96	Biscuit
	47	Almond
	FD	Cane Sugar™
	NY	Dune
	95	Ice™ Grey
	G9	Sandbar
	K4	Cashmere
	FT	Basalt
	58	Thunder™ Grey
	KA	Black 'n Tan
	FP	Caviar
	7	Black Black™

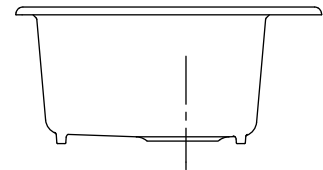
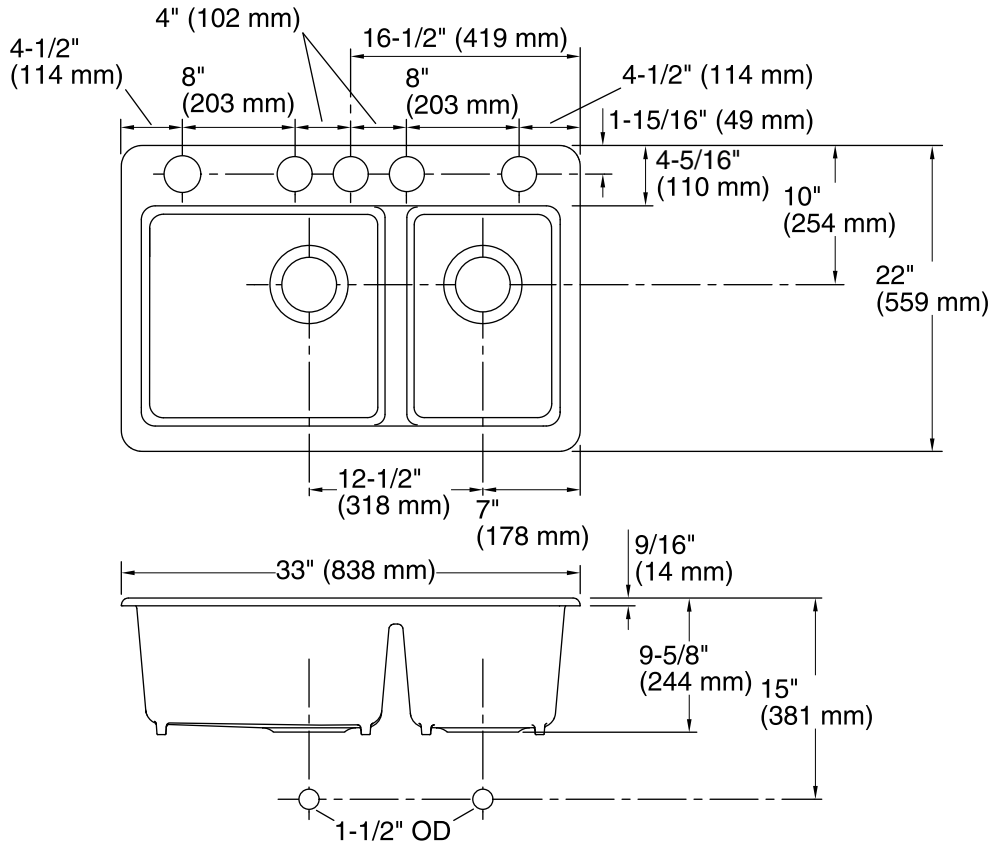

Technical Information

All product dimensions are nominal.

Installation: Under-mount

Min. base cabinet width: 36" (914 mm)

Bowl area (Left): Length: 17-9/16" (446 mm)
Width: 17-1/4" (438 mm)
Bowl depth: 9" (229 mm)
Water depth: 9" (229 mm)

Bowl area (Right): Length: 11-1/16" (281 mm)
Width: 17-1/4" (438 mm)
Bowl depth: 9" (229 mm)
Water depth: 9" (229 mm)

Number of deck holes: 5

Template: 1166727-7, required, included

Notes

Install this product according to the installation instructions.