

GENERAL INFORMATION

TRAK-IT® C5

Gas Fastening System

PRODUCT DESCRIPTION

The Trak-It C5 gas fastening system was developed for use in light-duty applications, including attaching drywall track to concrete, lightweight concrete, block or steel. Also can be considered for fastening lath to concrete or block, furring strips to concrete or block, and plywood to concrete or block base materials. The system is designed for speed, efficiency and consistency. Operation of a gas fastening system does not require licensing.

Stick-E assemblies are specially designed components for various fastening attachments into concrete, concrete masonry block and steel.

GENERAL APPLICATIONS AND USES

- Attaching light gauge steel track to concrete, concrete masonry block (CMU) or steel
- Attaching plywood to concrete or concrete masonry block (CMU)
- Attaching lath to concrete, concrete masonry block (CMU) or steel
- Attaching furring strips to concrete or concrete masonry block (CMU)
- Attaching Stick-E assemblies to concrete and concrete masonry block (CMU)

FEATURES AND BENEFITS

- + No licensing requirements
- + Each fuel cell contains enough gas to install up to 800 fasteners
- + Available for use with Stick-E™ accessories
- + Tracks are easily removed and exchanged on tool
- + Adjustable depth control on tool nose piece
- + Maintenance counter and LED indicator
- + Dust and corrosion resistant tool manifolds
- + Ergonomic handle with light trigger pull load
- + Can be used with a C5 pole tool

APPROVALS AND LISTINGS

- International Code Council, Evaluation Service (ICC-ES), ESR-3275
- Code compliant with the 2018 IBC/IRC, 2015 IBC/IRC, 2012 IBC/IRC, and 2009 IBC/IRC
- Tested in accordance with ASTM E1190 and ICC-ES AC70 for use in concrete, CMU block and steel

GUIDE SPECIFICATIONS

CSI Divisions: 03 15 00 - Concrete Accessories, 05 05 23 - Metal Fastenings, 06 05 23 - Wood, Plastic and Composite Fastenings, 09 22 16.23 - Fasteners. Power-driven fasteners shall be Trak-It C5 as supplied by DEWALT / Powers, Towson, MD.

TOOL SPECIFICATIONS

Trak-It C5 Tool

Tool Body	Precision Moulded Aluminum and Plastic
Tool Length	17.25"
Tool Weight	7.9 lbs
Pin Length (Maximum)	1-1/4" for deep track; 1-1/2" for short track & long track
Pin Capacity	42 pins for deep track & long track; 22 pins for short track
Power Capacity	105 joules
Approximate Shots per Fuel Cell	800 pins
Approximate Shots per Battery Charge	5,700

SECTION CONTENTS

General Information..... 1
Performance Data..... 2
Stick-E Assemblies 5
Ordering Information..... 6



TRAK-IT C5 TOOL (SHOWN WITH DEEP TRACK) FOR 1-1/4" PIN LENGTH



SHORT TRACK & LONG TRACK FOR 1-1/2" PIN LENGTH



FASTENERS FOR CONCRETE AND MASONRY



FASTENERS FOR STEEL



SPECIALTY FASTENERS



STICK-E ASSEMBLIES

SUITABLE BASE MATERIALS

- Normal-Weight Concrete
- Lightweight Concrete
- Grouted Concrete Masonry (CMU)
- Hollow Concrete Masonry (CMU)
- Steel

PERFORMANCE DATA

Allowable Loads for Trak-It C5 Fasteners Installed in Normal Weight Concrete^{1,2,3,9,10}

Shank Type (inch)	Shank Diameter (inch)	Minimum Embedment (inch)	Minimum Fastener Length ¹ (inch)	Minimum Spacing ⁶ (inch)	Minimum Edge Distance ⁶ (inch)	Minimum Concrete Compressive Strength (f'c)					
						2,500 psi		3,000 psi		4,000 psi	
						Tension (lbs)	Shear (lbs)	Tension (lbs)	Shear (lbs)	Tension (lbs)	Shear (lbs)
Straight	0.102	5/8	3/4	4	3-1/4	120	135	120	140	120	145
		7/8	1	4	3-1/4	180	185	180	195	180 ⁷	215 ⁷
		1-1/8	1-1/4	4	3-1/4	240	225	240	255	245	310
	0.145	5/8	3/4	4	3-1/4	105	75	110	95	120	135
		7/8	1	4	3	125	105	135	110	-	-
		-	-	-	-	-	-	-	-	-	-
Step	0.120/0.102	0.600 ⁵	0.680 ⁵	4	3	-	-	-	-	90	65
		5/8	0.730	4	3	-	-	-	-	115 ⁸	80 ⁸
	0.145/0.102	3/4	1-1/4	4	3	80	215	85	235	85	235
		1	1-1/4	4	3	125	245	135	265	-	-
		1-1/8	1-1/4	4	1-3/4	215	250	250	250	-	-
		3/4	7/8	4	3-1/4	145	180	155	185	170	190
Tapered	0.120	5/8	3/4	3-1/4	3-1/4	150	120	170	135	170	145
				2-3/4		150	120	170	135	165	135
				2		150	90	170	100	160	100

For SI: 1 lbf = 4.48 N, 1 inch = 25.4mm, 1 psi = 6.895 kPa

- Fasteners must not be driven until the concrete has reached the tabulated compressive strength.
- Concrete thickness must be a minimum of 3 times the embedment depth of the fastener or 2 inches, whichever is greater.
- The tabulated allowable load values are for the fastener only. Wood or steel members connected to the steel substrate must be investigated in accordance with accepted design criteria.
- Based upon attachment of 16 gauge sheet metal or thinner, except as noted.
- Based upon attachment of 25 gauge sheet metal or thinner.
- Installing fasteners less than the minimum spacing and edge distance values in this table can result in a reduction in capacity. Such conditions are outside the scope of this published information.
- For installations in 6,000 psi concrete, the tabulated tension and shear loads may be increased to 200 lbs and 220 lbs, respectively.
- For installations in 6,000 psi concrete, the tabulated shear load may be increased to 125 lbs. The tabulated tension load must not be increased.
- Allowable load capacities are calculated using minimum required safety factors in accordance with ICC-ES AC70; the applied safety factor for the tabulated allowable loads is 5.0.
- Multiple fasteners are recommended for any attachment for increased reliability.

Allowable Loads for Trak-It C5 Fasteners Driven into Concrete Masonry Units^{1,2,3,7,8,9}

Shank Type	Shank Diameter (inch)	Min. Embed. Depth (inch)	Min. End and Edge Distance (inches)	Allowable Loads (lbf)									
				Hollow CMU				Grouted CMU					
				Face Shell ⁶		Horizontal Mortar Joint		Face Shell ⁶		Horizontal Mortar Joint		Top and Center of Grouted Cell	
				Tension	Shear ⁴	Tension	Shear ⁵	Tension	Shear ⁴	Tension	Shear ⁴	Tension	Shear ⁴
Straight	0.102	7/8	3-3/4	65	80	55	65	65	80	55	65	-	-
	0.145	3/4	3-3/4	-	-	-	-	80	90	-	-	-	-
Step	0.145/0.120	3/4	3-3/4	-	-	-	-	85	100	-	-	-	-
	0.145/0.102	1-1/8	3-3/4	-	-	-	-	180	215	-	-	-	-
Tapered	0.120	5/8	3-3/4	45	65	60	80	60	70	60	80	135	100
			2			-	-			-	-	-	-

For SI: 1 lbf = 4.4 N, 1 inch = 25.4 mm.

- Concrete masonry units must be normalweight units conforming to ASTM C90. The minimum allowable nominal size of the CMU must be 8 inches high by 8 inches wide by 16 inches long, with a minimum, 1-1/4-inch-thick face shell thickness.
- Straight shank and step shank fasteners must only be placed into the unit face, including ends of masonry units. Only one straight shank or step shank fastener may be installed in each cell, and it must be a minimum of 1-1/2 inches from the mortar joints and 1-1/2 inches from the CMU web.
- For tapered shank fasteners, minimum fastener spacing is 2 inches center-to-center.
- Shear loads for straight shank and step shank fasteners installed in the face shell (including ends of masonry units) may be applied in any direction. Shear loads for tapered shank fasteners installed in the face shell (including ends of masonry units) or in the top of grouted cells may be applied in any direction.
- Shear loads for tapered shank fasteners installed into the horizontal mortar joint may be applied in any direction along the CMU wall plane.
- Installations in the face shell of the wall are applicable for fasteners in the ends of masonry units where the minimum edge and end distances are maintained.
- Fasteners must not be installed into vertical mortar joints, including the intersection of the head joint and bed joint. Fasteners with a straight shank and step shank must be installed a minimum of 3-3/4 inches from the vertical mortar joints. Fasteners with a tapered shank must be installed a minimum of 1-1/4 inches from the vertical mortar joints.
- Allowable load capacities are calculated using minimum required safety factors in accordance with ICC-ES AC70; the applied safety factor for the tabulated allowable loads is 5.0.
- Multiple fasteners are recommended for any attachment for increased reliability.

Fasteners Installed into Hollow or Grout-Filled Concrete Masonry Units

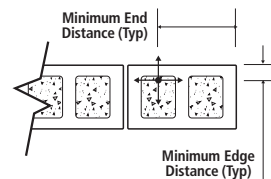
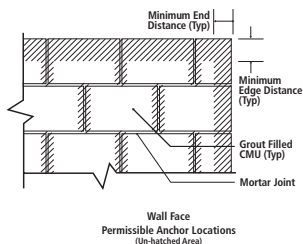

Top of Wall

Allowable Loads for Trak-It C5 Fasteners Installed in ASTM A36 Steel^{1,2,7,8}

Shank Type	Shank Diameter (inch)	Minimum Spacing (inch)	Minimum Edge Distance (inch)	Steel Thickness (inch)									
				1/8		3/16		1/4		3/8		1/2	
				Tension (lbs)	Shear (lbs)	Tension (lbs)	Shear (lbs)	Tension (lbs)	Shear (lbs)	Tension (lbs)	Shear (lbs)	Tension (lbs)	Shear (lbs)
Step	0.120/0.102	1	1/2	115	280	230	280	250	240	165 ³	125 ³	220 ⁴	205 ⁴
	0.145/0.120	1	1/2	95	300	285	300	225	190	-	-	-	-
Tapered	0.120	1	1/2	-	-	-	-	130	230	215 ⁵	325 ⁵	185 ⁶	325 ⁶

For St: 1 lbf = 4.48 N, 1 inch = 25.4mm, 1 psi = 6.895 kPa

1. Steel base material must have minimum yield and tensile strengths (F_y and F_u) equal to 36 ksi and 58 ksi, respectively.
2. Unless otherwise noted, fasteners must be driven to where the point of the fastener penetrates through the steel base material.
3. An embedment depth of 0.350-inch is required for the tabulated value. Allowable load value applies to steel base material with a thickness of 3/8-inch and thickness up to but not including 1/2-inch. For cases where the embedment depth is less than 0.350-inch but at least 0.250-inch, the allowable tension load is 115 lbs and the allowable shear is 120 lbs.
4. An embedment depth of 0.375-inch is required for the tabulated value. Allowable load value applies to steel base material with a thickness of 1/2-inch or greater. For cases where the embedment depth is less than 0.375-inch, but is at least 0.350-inch, the allowable tension load is 165 lbs and the allowable shear load is 125 lbs. For cases where the embedment depth is less than 0.350-inch but at least 0.250-inch, the allowable tension load is 110 lbs and the allowable shear is 120 lbs.
5. An embedment depth of 0.350 inch is required. Allowable load value applies to steel base material with thickness of 3/8 inch and thicknesses up to but not including 1/2 inch.
6. An embedment depth of 0.340 inch is required for the tabulated value. Allowable load value applies to steel base material with thickness of 1/2 inch and greater.
7. Allowable load capacities are calculated using minimum required safety factors in accordance with ICC-ES AC70; the applied safety factor for the tabulated allowable loads is 5.0.
8. Multiple fasteners are recommended for any attachment for increased reliability.

Allowable Loads for Trak-It C5 Fasteners Installed in ASTM A572 Grade 50 or ASTM A992 Steel^{1,2,7,8}

Shank Type	Shank Diameter (inch)	Minimum Spacing (inch)	Minimum Edge Distance (inch)	Steel Thickness (inch)									
				1/8		3/16		1/4		3/8		1/2	
				Tension (lbs)	Shear (lbs)	Tension (lbs)	Shear (lbs)	Tension (lbs)	Shear (lbs)	Tension (lbs)	Shear (lbs)	Tension (lbs)	Shear (lbs)
Step	0.120/0.102	1	1/2	120	290	245	290	270	255	175 ³	135 ³	240 ⁴	220 ⁴
	0.145/0.120	1	1/2	100	320	305	320	245	205	-	-	-	-
Tapered	0.120	1	1/2	-	-	-	-	140	250	215 ⁵	325 ⁵	195 ⁶	340 ⁶

For St: 1 lbf = 4.48 N, 1 inch = 25.4mm, 1 psi = 6.895 kPa

1. Steel base material must have minimum yield and tensile strengths (F_y and F_u) equal to 50 ksi and 65 ksi, respectively.
2. Unless otherwise noted, fasteners must be driven to where the point of the fastener penetrates through the steel base material.
3. An embedment depth of 0.350-inch is required for the tabulated value. Allowable load value applies to steel base material with a thickness of 3/8-inch and thickness up to but not including 1/2-inch. For cases where the embedment depth is less than 0.350-inch but at least 0.188-inch, the allowable tension load is 65 lbs and the allowable shear is 90 lbs.
4. An embedment depth of 0.375-inch is required for the tabulated value. Allowable load value applies to steel base material with a thickness of 1/2-inch or greater. For cases where the embedment depth is less than 0.375-inch, but is at least 0.350-inch, allowable tension load is 175 lbs and the allowable shear load is 135 lbs. For cases where the embedment depth is less than 0.350-inch but at least 0.125-inch, the allowable tension load is 25 lbs and the allowable shear is 55 lbs.
5. An embedment depth of 0.350 inch is required. Allowable load value applies to steel base material with thickness of 3/8 inch and thicknesses up to but not including 1/2 inch.
6. An embedment depth of 0.340 inch is required for the tabulated value. Allowable load value applies to steel base material with thickness of 1/2 inch and greater.
7. Allowable load capacities are calculated using minimum required safety factors in accordance with ICC-ES AC70; the applied safety factor for the tabulated allowable loads is 5.0.
8. Multiple fasteners are recommended for any attachment for increased reliability.

Allowable Loads for Trak-It C5 Spiral Knurl Pin Installed into Steel^{1,2,3}

Fastener Type (Style)	Shank Diameter (inch)	16 Gauge Steel		18 Gauge Steel		20 Gauge Steel	
		Tension (lbs)	Shear (lbs)	Tension (lbs)	Shear (lbs)	Tension (lbs)	Shear (lbs)
Spiral Knurl Pin	0.108 (K)	45	140	30	90	20	60

1. Tested in accordance with general provisions of ASTM E1190 / ICC-ES AC70 and with steel members meeting ASTM C955/A653. Allowable loads are calculated using an applied safety factor of 5.0. Consideration of safety factors of 10 or higher may be necessary depending on the application, such as life safety.
2. The tabulated allowable load values are for the fastener pullout capacity in the steel member. Wood members and/or proprietary materials (e.g. sheathing) connected to the steel must be investigated in accordance with the applicable code(s).
3. Multiple fasteners are recommended for any attachment for increased reliability.

Allowable Tensile Pull-Over Strengths for Light Gauge Steel Framing with Trak-It C5 Fasteners^{1,2,3}

Shank Type	Shank Diameter (inch)	Head Diameter (inch)	16 Gauge	18 Gauge	20 Gauge	22 Gauge	25 Gauge
			Allowable (lbs)	Allowable (lbs)	Allowable (lbs)	Allowable (lbs)	Allowable (lbs)
Straight	0.102	0.25	335	270	200	170	120
	0.145	0.25	335	270	200	170	120
Tapered	0.120	0.25	335	270	200	170	120

1. Tabulated pull-over strengths were calculated in accordance with ICC-ES AC70 and AISI S100-12. Allowable load values are based on a safety factor of 3.0.
2. Allowable pullover capacities of sheet steel or framing member should be compared to the fastener tensile capacity in concrete, masonry or steel to determine the controlling resistance load.
3. Sheet steel or framing member with tensile strength of 45 ksi assumed for calculating tabulated values.

Allowable Loads for Trak-It C5 Fasteners Driven into Minimum 3,000 psi Sand-Lightweight Concrete and Sand-Lightweight Concrete-Filled Steel Deck^{1,5,8,9}

Shank Type	Shank Diameter (inch)	Min. Embed. Depth (inch)	Allowable Loads (lbf)										Top Cover (inches)
			Installed Directly into Concrete ²		Installed through 3" Deep Steel Deck Panel into Concrete ³				Installed through 1-1/2" Deep Steel Deck Panel into Concrete ⁴				
					Upper Flute	Lower Flute	Upper Flute	Lower Flute	Upper Flute	Lower Flute	Upper Flute	Lower Flute	
			Tension	Shear	Tension		Shear		Tension		Shear		
Straight	0.102	5/8	115 ⁶	135 ⁶	110 ⁶	85 ⁶	225 ⁶	195 ⁶	50 ⁶	105 ⁶	125 ⁶	195 ⁶	2
		3/4	120	150	120	105	225	195	115	105	225	195	2-1/4
		7/8	120	205	–	105	–	255	–	–	110	–	245
	0.145	3/4	70	80	110	80	220	200	–	60	–	200	2-1/4
Step	0.145/0.102	1-1/8	280	230	–	160	–	300	–	150	–	300	3-1/4
Tapered	0.120	5/8	120 ⁶	140 ⁶	95 ⁶	80 ⁶	205 ⁶	185 ⁶	100 ⁶	90 ⁶	205 ⁶	200 ⁶	2

For SI: 1 lbf = 4.4 N, 1 inch = 25.4 mm, 1 psi = 6.895 kPa.

- Fasteners must not be driven until the concrete has reached the tabulated compressive strength.
- For straight shank and step shank fasteners installed directly into concrete (e.g. top of concrete-filled steel deck), fastener edge distance must be 3 inches minimum and fastener spacing must be 4 inches minimum. For tapered shank fasteners installed directly into concrete (e.g. top of concrete-filled steel deck), fastener edge distance must be 3 inches minimum and fastener spacing must be 3.25 inches minimum. Shear loads may be applied in any direction.
- The steel deck must have a minimum base material thickness of 0.035 inch, minimum yield strength, F_y , of 33 ksi, a minimum tensile strength of 45 ksi, and conform to the profile requirements as shown in Figure 1. Fastener edge distance (lower flute locations) must be a minimum of 1-1/8 inches. Fastener spacing must be a minimum of 4 inches for straight shank fasteners and a minimum of 3.25 inches for tapered shank fasteners. Shear loads may be applied in any direction.
- The steel deck must have a minimum base material thickness of 0.035 inch, minimum yield strength, F_y , of 33 ksi, a minimum tensile strength of 45 ksi, and conform to the profile requirements as shown in Figure 1. Fastener edge distance (lower flute locations) must be a minimum of 7/8 inches. Fastener spacing must be a minimum of 4 inches for straight shank fasteners and a minimum of 3.25 inches for tapered shank fasteners.
- Unless otherwise noted, for installation into lightweight concrete with $f'c = 3,500$ psi, multiply the tabulated values by 1.05 to determine the applicable allowable load value.
- For installation of 0.102-inch-diameter straight shank fasteners and 0.120-inch-diameter tapered shank fasteners into lightweight concrete with $f'c = 3,500$ psi, no increase in tabulated values is allowed. For installation into lightweight concrete with $f'c = 2,500$ psi, multiply the tabulated values by 0.87 to determine the applicable allowable load value.
- For fastener installations into the lower flute, the minimum required topping thickness above the deck panel is 2 inches.
- Allowable load capacities are calculated using minimum required safety factors in accordance with ICC-ES AC70; the applied safety factor for the tabulated allowable loads is 5.0.
- Multiple fasteners are recommended for any attachment for increased reliability.

Figure 1 - Fastener Installation Through Soffit of 3-inch Deep Concrete-filled Composite Steel Deck Floor and Roof Assemblies.

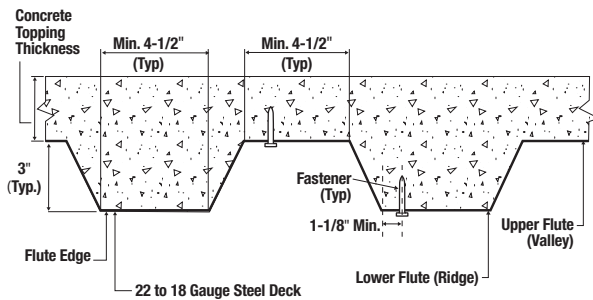
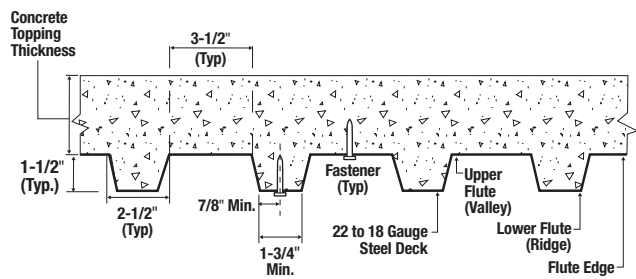

Figure 2 - Fastener Installation Through the Soffit of 1-1/2 inch Deep Concrete-filled Composite Steel Deck Floor and Roof Assemblies.



STICK-E™ DIRECT FASTENING ASSEMBLIES - SELECTION GUIDE AND PERFORMANCE DATA^{1,2,3,4,5,6,7,8}

Trade / Contractor	Application	Stick-E Accessory		Stick-E and Fastener			Fastener	
		Cat. No.	Description	Suitable Base Material	Allowable Load lbs.	Min. Pin Embed. in.	Shank Dia. x Length in.	Trak-It C5 System Pin Cat. No.
Plasterer & Insulator	Installing wire lath for stucco or surfacing applications	DFD405101	Lathing Washer 1"	Concrete	60	5/8	0.102" x 3/4" or 0.102" x 0.780" (K)	55310 or 55341
				Hollow/Grouted Block (CMU)	55	5/8		
	Attaching rigid exterior foam insulation	DFD405716	Insulation Washer 1-7/16"	Concrete	30	5/8	0.102" x 1-1/4"	55341
	Attaching DensGlass® board	DFD405901	Denz Glass Washer 1-1/4"	Light Gauge Steel Framing	15 20	18 gauge 16 gauge	0.108" x 1-3/8" (K)	55340
Electrical	Attaching 3/8" Dia. flexible BX cable	DFD405338	BX Clip 3/8"	Concrete	10	5/8	0.102" x 3/4" or 0.102" x 0.780" (K)	55310 or 55341
	Attaching 1/2" diameter conduit	DFD405312R	Conduit Clip 1/2"	Hollow/Grouted Block (CMU)	10	5/8		
				Concrete	10	5/8		
	Attaching 3/4" diameter conduit	DFD405334R	Conduit Clip 3/4"	Concrete	10	5/8		
				Hollow/Grouted Block (CMU)	10	5/8		
	Attaching 1" diameter conduit	DFD405310R	Conduit Clip 1"	Concrete	10	5/8		
				Hollow/Grouted Block (CMU)	10	5/8		
	Hanging 1/2" diameter conduit	DFD405412	Mini Conduit Clamp 1/2"	Concrete	10	5/8		
Hanging 3/4" diameter conduit	DFD405434	Mini Conduit Clamp 3/4"	Concrete	10	5/8			
Hanging 1" diameter conduit	DFD405410	Mini Conduit Clamp 1"	Concrete	10	5/8			
For temporary lighting or wire strapping (using zip-tie or velcro)	DFD405902	Cable Tie Donut 1-1/4"	Concrete	10	5/8			
Mechanical & Electrical	Attaching pencil rod, hooks & wire assemblies	DFD405550	Right Angle Clip 90°	Concrete	75	5/8	0.102" x 3/4" or 0.102" x 0.780" (K)	55310 or 55341
	Attaching pencil rod, hooks & wire assemblies	DFD405530	Angle Clip 60°	Concrete	75	5/8		
	Hanging 1/4" threaded rod	DFD405214	Rod Hanger 1/4"	Concrete	75	5/8		
	Hanging 3/8" threaded rod	DFD405238	Rod Hanger 3/8"	Concrete	75	5/8		
	Hanging 1/4" threaded rod	DFD405215	Post Nut Rod Hanger 1/4"	Concrete	75	5/8		
	Hanging 3/8" threaded rod	DFD405239	Post Nut Rod Hanger 3/8"	Concrete	75	5/8		
Sheet Metal	Attach duct straps to suspend HVAC	DFD405112	Strap Mtl Washer 1/2"	Concrete	50	5/8	0.102" x 3/4" or 0.102" x 0.780" (K)	55310 or 55341
Concrete	Attaching #3 rebar/dowels or wire baskets	DFD405300	Rebar/Dowel Basket Clip	Concrete	50	5/8	0.102" x 3/4" or 0.102" x 0.780" (K)	55310 or 55341

DensGlass is a registered trademark of Georgia-Pacific.

K = Knurled

- Fasteners installed into concrete or concrete masonry block must not be driven until the base material has reached the minimum specified compressive strength. Embedment is measured from the surface of the base material to the end of the fastener.
- For fasteners installed into concrete, the member thickness must be a minimum of 3 times the embedment depth of the fastener or 2 inches, whichever is greater.
- For installations into concrete or concrete masonry block, minimum fastener edge and end distance is 3-3/4 inches; minimum fastener spacing is 4 inches center-to-center.
- For installations into concrete masonry block, fasteners may be installed into the face shell or horizontal mortar joint. The face shell thickness of hollow concrete masonry block must be 1-1/4 inch minimum. Fasteners must be installed a minimum of 1-1/4 inch from the vertical mortar joints; allowable loads for fasteners installed in vertical mortar joints is outside the scope of this data.
- Allowable load capacities for concrete are based on a minimum concrete compressive strength of 3000 psi; allowable load capacities in concrete may be increased by 15 percent for installations into 4000 psi concrete and allowable load capacities must be reduced by 10 percent for installations into 2500 psi concrete. Allowable load capacities for concrete masonry block are based on a minimum masonry compressive strength of 2000 psi.
- Allowable load capacities for concrete and concrete masonry block are calculated using minimum required safety factors in accordance with ICC-ES AC70; the applied safety factor for the tabulated allowable loads is 5.0. Consideration of additional safety factors may be necessary depending on application such as life safety.
- Allowable loads for light gauge steel framing are calculated using minimum required safety factors in accordance ICC-ES AC259 using light gauge steel framed panels sheathed with DensGlass; the applied safety factor for the tabulated allowable loads is 3.0. Light gauge steel framing members must be minimum 18 gauge thickness. Allowable negative (outward) transverse pressure on the panels must not exceed 15 psf for the specified sheathing thickness, maximum steel stud spacing and fastener spacing. Consideration of additional safety factors may be necessary depending on the applicable design method and/or the application such as life safety. Wood members and/or other proprietary materials connected to the light gauge steel substrate must be investigated for compliance with the applicable codes.
- Multiple fasteners are recommended for any attachment for increased reliability.

GAS FASTENING

TRAK-IT® C5

ORDERING INFORMATION

Pins for Concrete and Concrete Masonry (CMU)

Cat. No.	Shank Dia.	Step Dia.	Length	Shank Type	Finish	Box	Ctn.	Typical Applications
55310	0.102"	-	3/4"	Straight, smooth	Zinc	800	4000	Metal track to concrete
55312	0.102"	-	1"	Straight, smooth	Zinc	800	4000	Metal track to concrete
55314	0.102"	-	1-1/4"	Straight, smooth	Zinc	800	4000	Fixture to concrete or block (CMU)
55316	0.102"	-	1-1/2"	Straight, smooth	Zinc	800	4000	Fixture to concrete or block (CMU)
55318	0.145"	-	3/4"	Straight, smooth	Zinc	800	4000	Metal track to concrete
55320	0.145"	-	1"	Straight, smooth	Zinc	800	4000	Light gauge metal track to concrete, 1/4" & 3/8" plywood to concrete/block, rubber membrane to concrete or block (CMU)
55322	0.145"	0.102"	1-1/4"	Step, smooth	Zinc	800	4000	Fixture to concrete or block (CMU)
55324	0.145"	0.102"	1-1/2"	Step, smooth	Zinc	800	4000	Fixture to concrete or block (CMU)
55343	0.120"	-	3/4"	Tapered, smooth	Zinc	800	4000	Metal track to concrete or block (CMU)

Fasteners have a head diameter of 0.25-inch and zinc plated according to ASTM B695, Class 5.

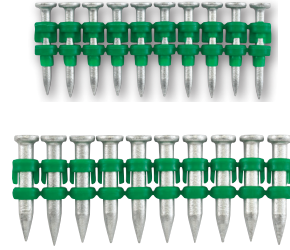

Pins for Steel

Cat. No.	Shank Dia.	Step Dia.	Length	Shank Type	Finish	Box	Ctn.	Typical Applications
55325	0.120"	-	1/2"	Straight, smooth	Zinc	800	4000	Metal track to steel
55343	0.120"	-	3/4"	Tapered, smooth	Zinc	800	4000	Metal track to steel

Fasteners have a head diameter of 0.25-inch and zinc plated according to ASTM B695, Class 5.

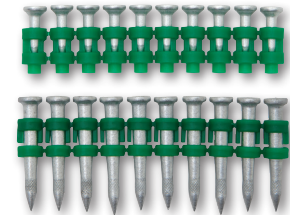

Specialty Pins

Cat. No.	Shank Dia.	Step Dia.	Length	Shank Type	Finish	Box	Ctn.	Typical Applications
55328	0.120"	0.102"	0.680"	Step, knurled	Zinc	800	4000	Metal track to steel or concrete
55330	0.120"	0.102"	0.730"	Step, knurled	Zinc	800	4000	1/4" plywood to steel or hard concrete
55340	0.108"	-	1-3/8"	Spiral, knurled	Zinc	800	4000	Plywood and sheathing board (with Denz Glass washer) to light gauge steel stud
55342	0.102"	0.088"	0.780"	Step, knurled	Zinc	800	4000	Steel, stud, precast concrete, block (CMU) and steel
55336	0.145"	0.120"	7/8"	Step, knurled	Zinc	800	4000	1/2" & 5/8" plywood to steel
55338	0.145"	0.120"	1-1/8"	Step, knurled	Zinc	800	4000	3/4" plywood to steel, 1" furring strip to steel

Fasteners have a head diameter of 0.25-inch and zinc plated according to ASTM B695, Class 5.

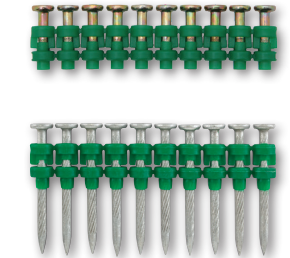

Tools and Accessories

Cat. No.	Description	Box Qty.	Ctn Qty.
55142	Trak-It C5 Tool w/ Deep Track (1-1/4" Pin) - 42 Pin Capacity	1	-
55144	Trak-It C5 Tool w/ Short Track (1-1/2" Pin) - 22 Pin Capacity	1	-
55148	Trak-It C5 Tool w/ Long Track (1-1/2" Pin) - 42 Pin Capacity	1	-
55302	Trak-It C5 Fuel Cell	20	80
55583	Trak-It C5 Battery	1	-
55618	Trak-It C5 Charger Base	1	-
55619	Trak-It C5 110V Adapter Cord	1	-
56347	Trak-It C5 Pole Tool Full System	1	3
56348	Trak-It C5 Pole Tool 3' Extension	1	20
56342	Accessory Deep Track for Trak-It C5 (Up to 1-1/4" Pins - 42 Pin Capacity)	1	-
55346	Accessory Short Track for Trak-It C5 (Up to 1-1/2" Pins - 22 Pin Capacity)	1	-
56344	Accessory Long Track for Trak-It C5 (Up to 1-1/2" Pins - 42 Pin Capacity)	1	-



Stick-E Assemblies

Cat. No.	Description	Ctn Qty.	Mstr Qty.
DFD405101	Stick-E Lathing Washer 1"	100	1000
DFD405100	Lathing Washer (No Stick-E)	100	1000
DFD405716	Stick-E Insulation Washer 1-7/16"	100	1000
DFD405901	Stick-E Denz Glass Washer 1-1/4"	250	1000
DFD405338	Stick-E BX Clip 3/8"	100	1000
DFD405412	Stick-E Conduit Clamp 1/2"	50	200
DFD405434	Stick-E Conduit Clamp 3/4"	50	200
DFD405410	Stick-E Conduit Clamp 1"	50	100
DFD405312R	Stick-E Mini Conduit Clip 1/2"	100	1000
DFD405334R	Stick-E Mini Conduit Clip 3/4"	100	1000
DFD405310R	Stick-E Mini Conduit Clip 1"	100	1000
DFD405902	Stick-E Cable Tie Donut 1-1/4"	100	1000
DFD405550	Stick-E Right Angle Clip 90°	100	1000
DFD405530	Stick-E Angle Clip 60°	100	1000
DFD405214	Stick-E Rod Hanger 1/4"-20	100	1000
DFD405238	Stick-E Rod Hanger 3/8"-16	100	1000
DFD405215	Stick-E Post Nut Rod Hanger 1/4"-20	100	1000
DFD405239	Stick-E Post Nut Rod Hanger 3/8"-16	100	1000
DFD405112	Stick-E Strap Mtl Washer 1/2"	100	1000
DFD405300	Stick-E Rebar/Dowel Basket Clip	100	1000
DFD405610	Stick-E Square Washer 1"	100	1000
DFD405102	Stick-E SS Sealing Washer 3/4"	100	1000



Angle clips are 3/4-inch wide and 2mm thick with a 5/16-inch wire hole.
Rebar/dowel basket clips are sized to accept #3 rebar and 3/8-inch dowels.