

# ROOFING *Accessories*

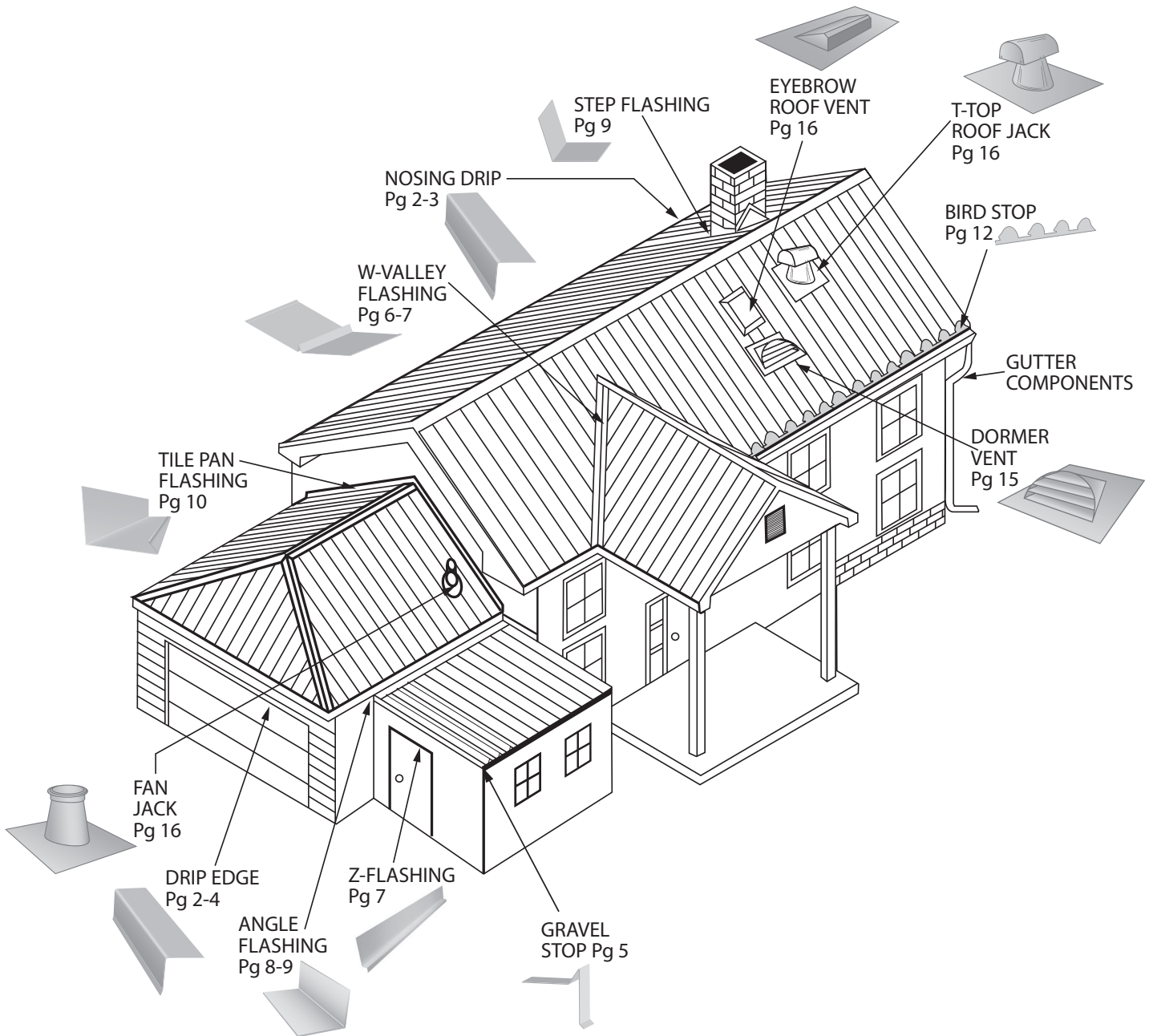

## *2019 Lodi Plant* **PRODUCT CATALOG**

[www.acm-metals.com](http://www.acm-metals.com)



**Table of Contents**

<b>Nosing Drip Edge .....</b>	<b>2-3</b>	<b>Tile Riser .....</b>	<b>11</b>
<b>Nosing Grip Edge .....</b>	<b>4</b>	<b>Scupper .....</b>	<b>11</b>
<b>Gravel Stop .....</b>	<b>5</b>	<b>Bird Stop .....</b>	<b>12</b>
<b>Rain Diverter .....</b>	<b>6</b>	Capistrano/Espana .....	12
<b>Peak Flashing .....</b>	<b>6</b>	Mission .....	12
<b>Roll Valley .....</b>	<b>6</b>	Malibu .....	12
<b>W-Valley .....</b>	<b>7</b>	Villa .....	12
<b>Roof to Wall Flashing .....</b>	<b>7</b>	<b>Pipe Flashing .....</b>	<b>13</b>
<b>Z-Bar .....</b>	<b>8</b>	<b>Plumber Flashing .....</b>	<b>14</b>
<b>Flat Sheet .....</b>	<b>8</b>	<b>Storm Collar .....</b>	<b>15</b>
<b>Flat Shingle .....</b>	<b>8</b>	<b>Sub Flashing .....</b>	<b>15</b>
<b>Angle Flashing .....</b>	<b>9</b>	<b>Dormer Vent .....</b>	<b>15</b>
<b>Pre-Bent Step Flashing .....</b>	<b>9</b>	<b>Eyebrow Vent .....</b>	<b>15</b>
<b>Counter Flashing .....</b>	<b>10</b>	<b>Fan Jack .....</b>	<b>16</b>
<b>Reglet Flashing .....</b>	<b>10</b>	<b>T-Top .....</b>	<b>16</b>
<b>Saddle Stock .....</b>	<b>10</b>	<b>Parapet / Coping Cap .....</b>	<b>16</b>
<b>Tile Pan Flashing .....</b>	<b>10</b>	<b>Ventilation Products .....</b>	<b>17-18</b>

PROUDLY FINISHED WITH  
**SHERWIN-WILLIAMS.**  
*Coil Coatings*

*We reserve the right to change the content of product offerings at any time. Please consult the online catalog at [www.acm-metals.com](http://www.acm-metals.com) for the most update product offering.*

**Contact Information:**

**CUSTOMER SERVICE: Ph 877-213-5962 • Fax 608-362-0599**  
**[www.acm-metals.com](http://www.acm-metals.com)**



## Nosing Drip Edge

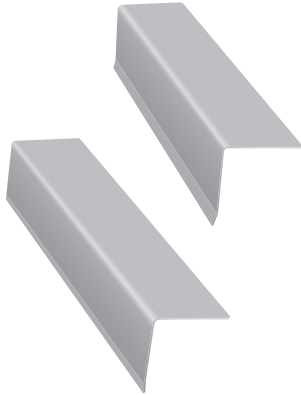

Part #	Description	Colors	Nom. Gauge/ Thickness	Pieces/ Box	Piece Length
AND9121 - -	Alum. 1 x 2 Nosing Drip, 3" Stretchout 110°	BK, RB, WH	0.019	10	10'
AND9221 - -	Alum. 2 x 2 Nosing Drip, 3" Stretchout 110°	BK, RB, WH	0.019	10	10'
G3WE28 - -	Galv. Steel 3-Way Edging	BR, C3, WH	28 ga	10	10'
GND612ML	Galv. 1 x 2 Nosing Drip	Mill	26 ga	10	10'
GND61515 - -	Galv. 1-1/2 x 1-1/2 Nosing Drip	BR, C3, WH	26 ga	10	10'
GND61515ML	Galv. 1-1/2 x 1-1/2 Nosing Drip	Mill	26 ga	10	10'
GND6153 - -	Galv. 1-1/2 x 3 Nosing Drip	BR, C3, WH	26 ga	10	10'
GND622 - -	Galv. 2 x 2 Nosing Drip	BR, C3, WH	26 ga	10	10'
GND622ML	Galv. 2 x 2 Nosing Drip	Mill	26 ga	10	10'
GND62211 - -	Galv. 2 x 2 Nosing Drip 110°	BR, C3, WH	26 ga	10	10'
GND62211ML	Galv. 2 x 2 Nosing Drip 110°	Mill	26 ga	10	10'
GND623 - -	Galv. 2 x 3 Nosing Drip	BR, C3, WH	26 ga	10	10'
GND623ML	Galv. 2 x 3 Nosing Drip	Mill	26 ga	10	10'
GND624 - -	Galv. 2 x 4 Nosing Drip	BR, C3, WH	26 ga	10	10'
GND624ML	Galv. 2 x 4 Nosing Drip	Mill	26 ga	10	10'
GND62411 - -	Galv. 2 x 4 Nosing Drip 110°	BR, C3, WH	26 ga	10	10'
GND62411ML	Galv. 2 x 4 Nosing Drip 110°	Mill	26 ga	10	10'
GND626 - -	Galv. 2 x 6 Nosing Drip	BR, C3, WH	26 ga	10	10'
GND626ML	Galv. 2 x 6 Nosing Drip	Mill	26 ga	10	10'
GND62611 - -	Galv. 2 x 6 Nosing Drip 110°	BR, C3, WH	26 ga	10	10'
GND62611ML	Galv. 2 x 6 Nosing Drip 110°	Mill	26 ga	10	10'
GND628 - -	Galv. 2 x 8 Nosing Drip	BR, C3, WH	26 ga	10	10'
GND628ML	Galv. 2 x 8 Nosing Drip	Mill	26 ga	10	10'
GND6287 - -	Galv. 2 x 8 Nosing Drip 75°	BR, C3, WH	26 ga	10	10'
GND6287ML	Galv. 2 x 8 Nosing Drip 75°	Mill	26 ga	10	10'
GND62811 - -	Galv. 2 x 8 Nosing Drip 110°	BR, C3, WH	26 ga	10	10'
GND633 - -	Galv. 3 x 3 Nosing Drip	BR, C3, WH	26 ga	10	10'
GND633ML	Galv. 3 x 3 Nosing Drip	Mill	26 ga	10	10'
GND63311 - -	Galv. 3 x 3 Nosing Drip 110°	BR, C3, WH	26 ga	10	10'
GND644 - -	Galv. 4 x 4 Nosing Drip	BR, C3, WH	26 ga	10	10'
GND644ML	Galv. 4 x 4 Nosing Drip	Mill	26 ga	10	10'
GND6452 - -	Galv. 4 x 5 Nosing Drip 5/12 Pitch	BR, C3, WH	26 ga	10	10'

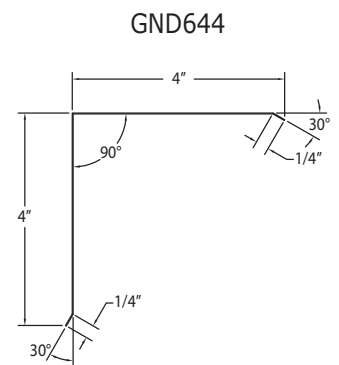
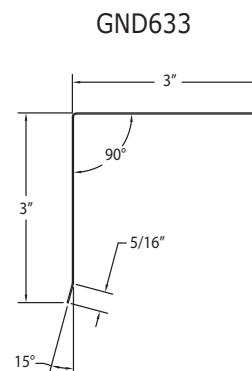
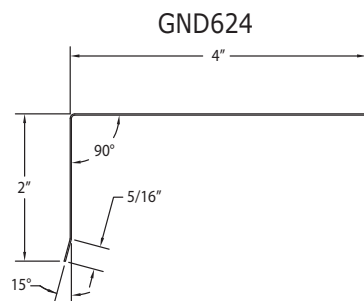
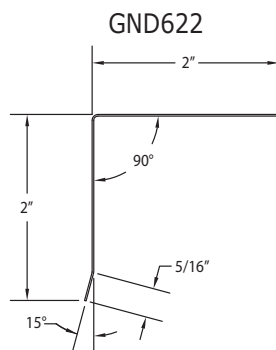
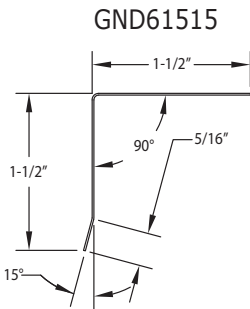

## Roofing Accessories Colors:





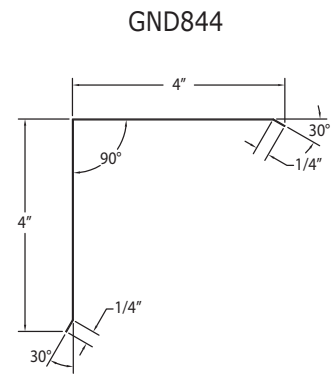
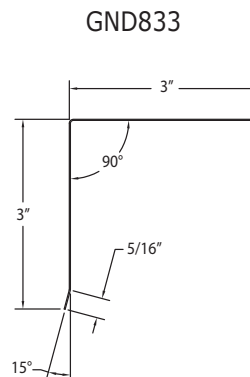
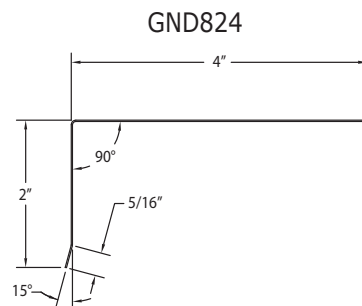
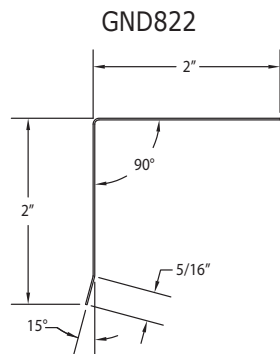
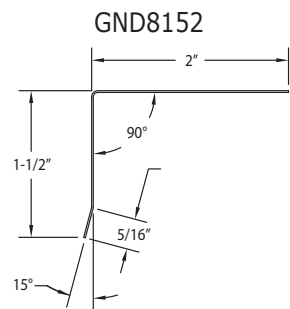
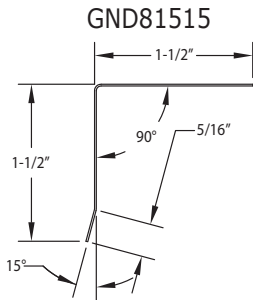
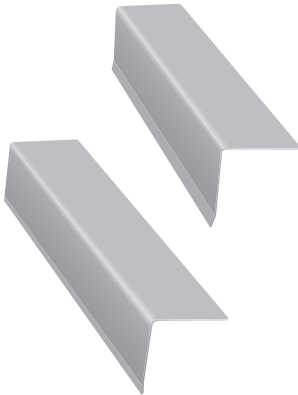

COLOR	CODE	COLOR	CODE	COLOR	CODE	COLOR	CODE
BROWN	BR	CHARCOAL	C3	ROYAL BROWN	RB	WHITE	WH

**Nosing Drip Edge *cont.***

Part #	Description	Colors	Nom. Gauge/ Thickness	Pieces/ Box	Piece Length
GND812 - -	Galv. 1 x 2 Nosing Drip	BR, C3, WH	28 ga	10	10'
GND812ML	Galv. 1 x 2 Nosing Drip	Mill	28 ga	10	10'
GND81515 - -	Galv. 1-1/2 x 1-1/2 Nosing Drip	BR, C3, WH	28 ga	10	10'
GND81515ML	Galv. 1-1/2 x 1-1/2 Nosing Drip	Mill	28 ga	10	10'
GND8152 - -	Galv. 1-1/2 x 2 Nosing Drip	BR, C3, WH	28 ga	10	10'
GND8152ML	Galv. 1-1/2 x 2 Nosing Drip	Mill	28 ga	10	10'
GND822 - -	Galv. 2 x 2 Nosing Drip	BR, C3, WH	28 ga	10	10'
GND822ML	Galv. 2 x 2 Nosing Drip	Mill	28 ga	10	10'
GND823 - -	Galv. 2 x 3 Nosing Drip	BR, C3, WH	28 ga	10	10'
GND823ML	Galv. 2 x 3 Nosing Drip	Mill	28 ga	10	10'
GND824 - -	Galv. 2 x 4 Nosing Drip	BR, C3, WH	28 ga	10	10'
GND824ML	Galv. 2 x 4 Nosing Drip	Mill	28 ga	10	10'
GND8244 - -	Galv. 2 x 4 Nosing Drip 4/12 Pitch	BR, C3, WH	28 ga	10	10'
GND826 - -	Galv. 2 x 6 Nosing Drip	BR, C3, WH	28 ga	10	10'
GND833 - -	Galv. 3 x 3 Nosing Drip	BR, C3, WH	28 ga	10	10'
GND833ML	Galv. 3 x 3 Nosing Drip	Mill	28 ga	10	10'
GND844ML	Galv. 4 x 4 Nosing Drip	Mill	28 ga	10	10'
PND622	Bond. 2 x 2 Nosing Drip	Bond	26 ga	10	10'
PND624	Bond. 2 x 4 Nosing Drip	Bond	26 ga	10	10'
CND115	Copper 1 x 1-1/2 Nosing Drip	Copper	16 oz	Order by the pc.	10'
CND138	Copper 1-3/8 x 1-3/8 Nosing Drip	Copper	16 oz	Order by the pc.	10'
CND1515	Copper 1-1/2 x 1-1/2 Nosing Drip	Copper	16 oz	Order by the pc.	10'
CND152	Copper 1-1/2 x 2 Nosing Drip	Copper	16 oz	Order by the pc.	10'
CND22	Copper 2 x 2 Nosing Drip	Copper	16 oz	Order by the pc.	10'
CND225	Copper 2 x 2-1/2 Nosing Drip	Copper	16 oz	Order by the pc.	10'
CND24	Copper 2 x 4 Nosing Drip	Copper	16 oz	Order by the pc.	10'
CND253104	Copper 2-1/2 x 3 Nosing Drip 110°	Copper	16 oz	Order by the pc.	10'
CND258	Copper 2-5/8 x 2-5/8 Nosing Drip	Copper	16 oz	Order by the pc.	10'
CND33	Copper 3 x 3 Nosing Drip	Copper	16 oz	Order by the pc.	10'
CND44	Copper 4 x 4 Nosing Drip	Copper	16 oz	Order by the pc.	10'
CLDT13WH	TPO Clad 1 x 3 x 10 Drip Edge	WH	26 ga	1	10'
CLDT22WH	TPO Clad 2 x 2 x 10 Drip Edge	WH	26 ga	1	10'
CLDT24WH	TPO Clad 2 x 4 x 10 Drip Edge	WH	26 ga	1	10'
CLDT33WH	TPO Clad 3 x 3 x 10 Drip Edge	WH	26 ga	1	10'
CLDT34WH	TPO Clad 3 x 4 x 10 Drip Edge	WH	26 ga	1	10'
CLDT44WH	TPO Clad 4 x 4 x 10 Drip Edge	WH	26 ga	1	10'
CLDT73WH	TPO Clad 7 x 3 x 10 Drip Edge	WH	26 ga	1	10'
CLDTH24WH	TPO Clad 2 x 4 x 10 Drip Edge with Hem	WH	26 ga	1	10'
CLDTH33WH	TPO Clad 3 X 3 x 10 Drip Edge with 3/8" Hem	WH	26 ga	1	10'

**Roofing Accessories Colors:**

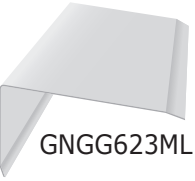
COLOR	CODE	COLOR	CODE	COLOR	CODE
BROWN	BR	CHARCOAL	C3	WHITE	WH

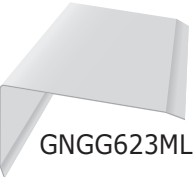
Nosing Grip Edge	Part #	Description	Colors	Nom. Gauge/ Thickness	Pieces/ Box	Piece Length
	GNG61515 - -	Galv. 1-1/2 x 1-1/2 Nosing Grip	BR, C3, WH	26 ga	10	10'
	GNG61515ML	Galv. 1-1/2 x 1-1/2 Nosing Grip	Mill	26 ga	10	10'
	GNG6152ML	Galv. 1-1/2 x 2 Nosing Grip	Mill	26 ga	10	10'
	GNG622 - -	Galv. 2 x 2 Nosing Grip	BR, C3, WH	26 ga	10	10'
	GNG622ML	Galv. 2 x 2 Nosing Grip	Mill	26 ga	10	10'
	GNG623 - -	Galv. 2 x 3 Nosing Grip	BR, C3, WH	26 ga	10	10'
	GNG623ML	Galv. 2 x 3 Nosing Grip	Mill	26 ga	10	10'
	GNG624ML	Galv. 2 x 4 Nosing Grip	Mill	26 ga	10	10'
	GNG62411ML	Galv. 2 x 4 Nosing Grip 110°	Mill	26 ga	10	10'
	GNG8115 - -	Galv. 1 x 1-1/2 Nosing Grip	BR, C3, WH	28 ga	10	10'
	GNG8115ML	Galv. 1 x 1-1/2 Nosing Grip	Mill	28 ga	10	10'
	GNG812 - -	Galv. 1 x 2 Nosing Grip	BR, C3, WH	28 ga	10	10'
	GNG812ML	Galv. 1 x 2 Nosing Grip	Mill	28 ga	10	10'
	GNG81515 - -	Galv. 1-1/2 x 1-1/2 Nosing Grip	BR, C3, WH	28 ga	10	10'
	GNG81515ML	Galv. 1-1/2 x 1-1/2 Nosing Grip	Mill	28 ga	10	10'
	GNG8152 - -	Galv. 1-1/2 x 2 Nosing Grip	BR, C3, WH	28 ga	10	10'
	GNG8152ML	Galv. 1-1/2 x 2 Nosing Grip	Mill	28 ga	10	10'
	GNG822 - -	Galv. 2 x 2 Nosing Grip	BR, C3, WH	28 ga	10	10'
	GNG822ML	Galv. 2 x 2 Nosing Grip	Mill	28 ga	10	10'
	GNG823 - -	Galv. 2 x 3 Nosing Grip	BR, C3, WH	28 ga	10	10'
	GNG823ML	Galv. 2 x 3 Nosing Grip	Mill	28 ga	10	10'
	GNG824 - -	Galv. 2 x 4 Nosing Grip	BR, C3, WH	28 ga	10	10'
	GNG824ML	Galv. 2 x 4 Nosing Grip	Mill	28 ga	10	10'
	GNG833 - -	Galv. 3 x 3 Nosing Grip	BR, C3, WH	28 ga	10	10'
	GNG833ML	Galv. 3 x 3 Nosing Grip	Mill	28 ga	10	10'
	GNG844ML	Galv. 4 x 4 Nosing Grip	Mill	28 ga	10	10'
	GNGG61515M	Galv. 1-1/2 x 1-1/2 Double Nose Grip	Mill	26 ga	10	10'
	GNGG61521M	Galv. 1-1/2 x 2 Double Nose Grip 110°	Mill	26 ga	10	10'
	GNGG622ML	Galv. 2 x 2 Double Nose Grip	Mill	26 ga	10	10'
	GNGG623ML	Galv. 2 x 3 Double Nose Grip	Mill	26 ga	10	10'
	CNG22	Copper 2 x 2 Nosing Grip	Copper	16 oz	Order by the pc.	10'
	CLGT22	TPO Clad 2 x 2 x 10 Grip Edge	WH	26 ga	Order by the pc.	10'
	CLGT24	TPO Clad 2 x 4 x 10 Grip Edge	WH	26 ga	Order by the pc.	10'
	CLGT33	TPO Clad 3 x 3 x 10 Grip Edge	WH	26 ga	Order by the pc.	10'

GNG822

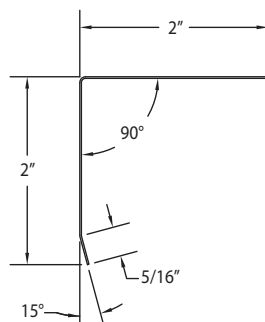

## Roofing Accessories Colors:

COLOR	CODE	COLOR	CODE	COLOR	CODE
BROWN	BR	CHARCOAL	C3	WHITE	WH

**Gravel Stop**



Part #	Description	Colors	Nom. Gauge/ Thickness	Pieces/ Box	Piece Length
GG624 - -	Galv. 2 x 4 Gravel Stop Drip	BR, C3, WH	26 ga	10	10'
GG624ML	Galv. 2 x 4 Gravel Stop Drip	Mill	26 ga	10	10'
GG633 - -	Galv. 3 x 3 Gravel Stop Drip	BR, C3, WH	26 ga	10	10'
GG633ML	Galv. 3 x 3 Gravel Stop Drip	Mill	26 ga	10	10'
GG644 - -	Galv. 4 x 4 Gravel Stop Drip	BR, C3, WH	26 ga	10	10'
GG644ML	Galv. 4 x 4 Gravel Stop Drip	Mill	26 ga	10	10'
GG822ML	Galv. 2 x 2 Gravel Stop Drip	Mill	28 ga	10	10'
GG824 - -	Galv. 2 x 4 Gravel Stop Drip	BR, C3, WH	28 ga	10	10'
GG824ML	Galv. 2 x 4 Gravel Stop Drip	Mill	28 ga	10	10'
GG833 - -	Galv. 3 x 3 Gravel Stop Drip	BR, C3, WH	28 ga	10	10'
GG833ML	Galv. 3 x 3 Gravel Stop Drip	Mill	28 ga	10	10'
GG844 - -	Galv. 4 x 4 Gravel Stop Drip	BR, C3, WH	28 ga	10	10'
GG844ML	Galv. 4 x 4 Gravel Stop Drip	Mill	28 ga	10	10'
GGSG822ML	Galv. 2 x 2 Gravel Stop Grip	Mill	28 ga	10	10'
GGSG82525M	Galv. 2-1/2 x 2-1/2 Gravel Stop Grip	Mill	28 ga	10	10'
GGSG824ML	Galv. 2 x 4 Gravel Stop Grip	Mill	28 ga	10	10'
GGSG833ML	Galv. 3 x 3 Gravel Stop Grip	Mill	28 ga	10	10'
GGSG844ML	Galv. 4 x 4 Gravel Stop Grip	Mill	28 ga	10	10'
GGSH622F - -	Galv. 2 x 2 Gravel Stop FHA 3/4 Rise	BR, C3, WH	26 ga	10	10'
GGSH622FML	Galv. 2 x 2 Gravel Stop FHA 3/4 Rise	Mill	26 ga	10	10'
GGSH633F - -	Galv. 3 x 3 Gravel Stop FHA 3/4 Rise	BR, C3	26 ga	10	10'
GGSL622 - -	Galv. 2 x 2 Gravel Stop Drip Low	BR, C3, WH	26 ga	10	10'
GGSL622ML	Galv. 2 x 2 Gravel Stop Drip Low	Mill	26 ga	10	10'
GGSL624 - -	Galv. 2 x 4 Gravel Stop Drip Low	BR, C3, WH	26 ga	10	10'
GGSL624ML	Galv. 2 x 4 Gravel Stop Drip Low	Mill	26 ga	10	10'
GGSL633 - -	Galv. 3 x 3 Gravel Stop Drip Low	BR, C3, WH	26 ga	10	10'
GGSL633ML	Galv. 3 x 3 Gravel Stop Drip Low	ML	26 ga	10	10'
GGSL644ML	Galv. 4 x 4 Gravel Stop Drip Low	Mill	26 ga	10	10'
GGSL834ML	Galv. 3 x 4 Gravel Stop Drip Low	Mill	28 ga	10	10'
GGSL844ML	Galv. 4 x 4 Gravel Stop Drip Low	Mill	28 ga	10	10'
GGSL824 - -	Galv. 2 x 4 Gravel Stop Drip Low	BR, C3, WH	28 ga	10	10'
GGSL824ML	Galv. 2 x 4 Gravel Stop Drip Low	Mill	28 ga	10	10'
GGSL833 - -	Galv. 3 x 3 Gravel Stop Drip Low	BR, C3, WH	28 ga	10	10'
GGSL833ML	Galv. 3 x 3 Gravel Stop Drip Low	Mill	28 ga	10	10'
PGS624	Bond. 2 x 4 Gravel Drip	Bond	26 ga	10	10'
PGS633	Bond. 3 x 3 Gravel Drip	Bond	26 ga	10	10'
PGS634	Bond. 3 x 4 Gravel Drip	Bond	26 ga	10	10'
PGSL624	Bond. 2 x 4 Gravel Drip Low	Bond	26 ga	10	10'
PGSL633	Bond. 3 x 3 Gravel Drip Low	Bond	26 ga	10	10'
PGSL634	Bond. 3 x 4 Gravel Drip Low	Bond	26 ga	10	10'
CLGS2254WH	TPO Clad 2 x 1/4 x 4 Gravel Stop	WH	26 ga	1	10'
CLGS3253WH	TPO Clad 3 x 1/4 x 3 Gravel Stop	WH	26 ga	1	10'

**\*NOTE:** Rise available in 1/8, 1/4, & 1/2

**Roofing Accessories Colors:**

COLOR	CODE	COLOR	CODE	COLOR	CODE
BROWN	BR	CHARCOAL	C3	WHITE	WH

### Rain Diverter

Part #	Description	Colors	Nom. Gauge/ Thickness	Pieces/ Box	Piece Length
GRD62135ML	Galv. 2 x 13-1/2 x 1/2 Rain Diverter	Mill	26 ga	Order by the Pc.	10'

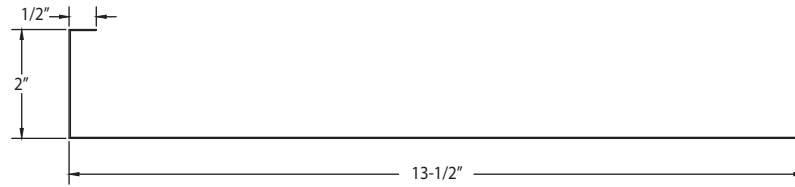
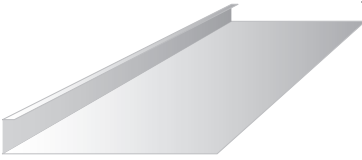

### Peak Flashing

Part #	Description	Colors	Nom. Gauge/ Thickness	Pieces/ Box
GPH6644ML	Galv. 6 x 4 Dual Hem Peak Flashing 4/12	Mill	26 ga	25

### Roll Valley

Part #	Description	Colors	Nom. Gauge/ Thickness	Pieces/ Box	Piece Length
ARV11085ML	Alum. 8" x 50' Roll Valley	Mill	0.011	1	50'
ARV11145ML	Alum. 14" x 50' Roll Valley	Mill	0.011	1	50'
ARV20ML	Alum. 20" x 50' Roll Valley	Mill	0.011	1	50'
GRV26145ML	Galv. 14" x 50' Roll Valley	Mill	26 ga	1	50'
GRV26205ML	Galv. 20" x 50' Roll Valley	Mill	26 ga	1	50'
GRV30365ML	Galv. 36" x 50' Roll Valley Econo.	Mill	30 ga	1	50'
GRV6ML	Galv. 6" x 50' Roll Valley Econo.	Mill	32 ga	1	50'
GRV8ML	Galv. 8" x 50' Roll Valley Econo.	Mill	32 ga	1	50'
GRV20ML	Galv. 20" x 50' Roll Valley Econo.	Mill	32 ga	1	50'
GRV14ML	Galv. 14" x 50' Roll Valley Econo.	Mill	32 ga	1	50'



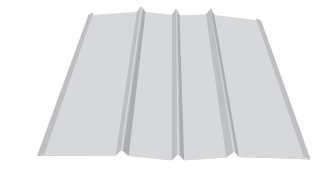
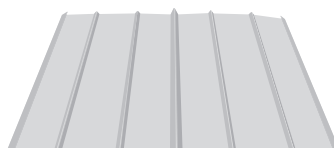

<b>W-Valley</b>	<b>Part #</b>	<b>Description</b>	<b>Colors</b>	<b>Nom. Gauge/ Thickness</b>	<b>Pieces/ Box</b>	<b>Piece Length</b>
  	GTV3C624ML	Galv. 24" 3 Crown Tile Valley	Mill	26 ga	10	10'
	GTV5CL624 - -	Galv. 24" 5 Crown Tile Valley Low	BR, C3, WH	26 ga	10	10'
	GTV5CL624ML	Galv. 24" 5 Crown Tile Valley Low	Mill	26 ga	10	10'
	GTV624ML	Galv. 24" Tile Valley	Mill	26 ga	10	10'
	GTV5C630ML	Galv. 30" 5 Crown Tile Valley	Mill	26 ga	10	10'
	GTV5CL630M	Galv. 30" 5 Crown Tile Valley Low	Mill	26 ga	10	10'
	GWVH2618 - -	Galv. 18" W-Valley Hem	BR, C3, WH	26 ga	10	10'
	GWVH2618ML	Galv. 18" W-Valley Hem	Mill	26 ga	10	10'
	GWV3CH624M	Galv. 24" 3 Crown W-Valley Hem	Mill	26 ga	10	10'
	GWVH2624 - -	Galv. 24" W-Valley Hem	BR, C3, WH	26 ga	10	10'
	GWVH2624ML	Galv. 24" W-Valley Hem	Mill	26 ga	10	10'
	GWVH2818 - -	Galv. 18" W-Valley Hem	BR, C3, WH	28 ga	10	10'
	GWVH2818ML	Galv. 18" W-Valley Hem	Mill	28 ga	10	10'
	GWVH2824 - -	Galv. 24" W-Valley Hem	BR, C3, WH	28 ga	10	10'
	GWVH2824ML	Galv. 24" W-Valley Hem	Mill	28 ga	10	10'
	CWVH18	Copper 18" W-Valley Hem	Copper	20 oz	Order by the pc.	10'
	CWVH24	Copper 24" W-Valley Hem	Copper	20 oz	Order by the pc.	10'

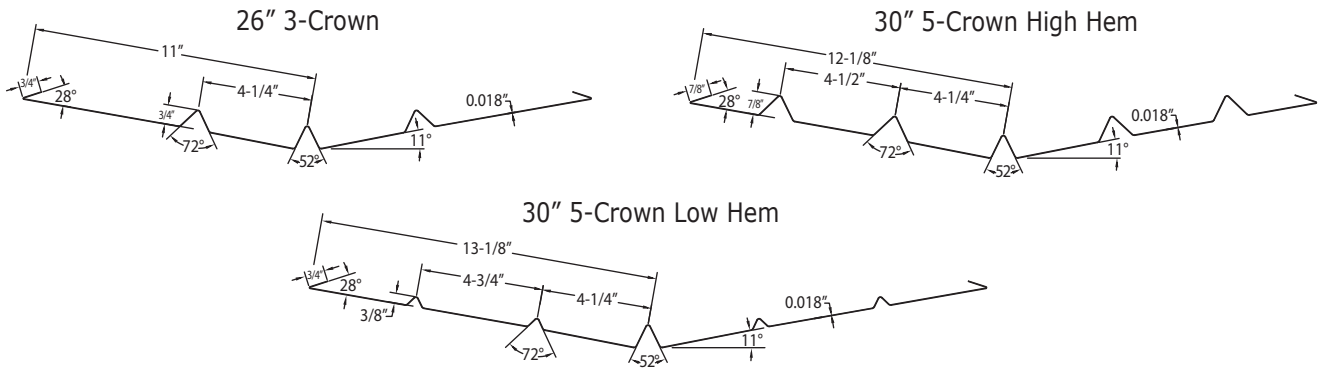



<b>Roof to Wall</b>	<b>Part #</b>	<b>Description</b>	<b>Colors</b>	<b>Nom. Gauge/ Thickness</b>	<b>Pieces/ Box</b>	<b>Piece Length</b>
	GRTW6235ML	Galv. 2 x 3-1/2 Roof to Wall 105°	Mill	26 ga	10	10'
	GRTW6241ML	Galv. 2 x 4 Roof to Wall 110°	Mill	26 ga	10	10'
	GRTW6261ML	Galv. 2 x 6 Roof to Wall 110°	Mill	26 ga	10	10'
	GRTW6351ML	Galv. 3 x 5 Roof to Wall 110°	Mill	26 ga	10	10'
	GRTW6441ML	Galv. 4 x 4 Roof to Wall 110°	Mill	26 ga	10	10'
	GRTW6444ML	Galv. 4 x 4 Roof to Wall 4/12	Mill	26 ga	10	10'
	GRTW6451ML	Galv. 4 x 5 Roof to Wall 110°	Mill	26 ga	10	10'
	GRTW6461ML	Galv. 4 x 6 Roof to Wall 110°	Mill	26 ga	10	10'
	GRTW6561ML	Galv. 5 x 6 Roof to Wall 110°	Mill	26 ga	10	10'
	GRTW6681ML	Galv. 6 x 8 Roof to Wall 110°	Mill	26 ga	10	10'
	GRTW8241ML	Galv. 2 x 4 Roof to Wall 110°	Mill	28 ga	10	10'
	GRTW8261ML	Galv. 2 x 6 Roof to Wall 110°	Mill	28 ga	10	10'
	GRTW8461ML	Galv. 4 x 6 Roof to Wall 110°	Mill	28 ga	10	10'
	PRTW6681	Bond. 6 x 8 Roof to Wall 110°	Bond	26 ga	10	10'
	CRTW26	Copper 2 x 6 Roof to Wall	Copper	16 oz	Order by the pc.	10'
CRTW46	Copper 4 x 6 Roof to Wall	Copper	16 oz	Order by the pc.	10'	
CRTW66	Copper 6 x 6 Roof to Wall	Copper	16 oz	Order by the pc.	10'	

**Roofing Accessories Colors:**

<b>COLOR</b>	<b>CODE</b>	<b>COLOR</b>	<b>CODE</b>	<b>COLOR</b>	<b>CODE</b>
BROWN	BR	CHARCOAL	C3	WHITE	WH

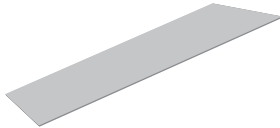
Z-Bar	Part #	Description	Colors	Nom. Gauge/ Thickness	Pieces/ Box	Piece Length
	GZB6203805	Galv. 2 x 3/8 x 1/2 Z-Bar	Mill	26 ga	10	10'
	GZB6200505	Galv. 2 x 1/2 x 1/2 Z-Bar	Mill	26 ga	10	10'
	GZB6205805	Galv. 2 x 5/8 x 1/2 Z-Bar	Mill	26 ga	10	10'
	GZB6201020	Galv. 2 x 1 x 2 Z-Bar	Mill	26 ga	10	10'
	GZB6201030	Galv. 2 x 1 x 3 Z-Bar	Mill	26 ga	10	10'
	GZB64051	Galv. 2 x 1-1/4 x 1/2 100° Z-Bar	Mill	26 ga	10	10'
	GZB6215515	Galv. 2 x 1-1/2 x 1/2 15° Z-Bar	Mill	26 ga	10	10'
	GZB6220510	Galv. 2 x 2 x 1/2 100° Z-Bar	Mill	26 ga	10	10'
	GZB6220515	Galv. 2 x 2 x 1/2 15° Z-Bar	Mill	26 ga	10	10'
	GZB6224058	Galv. 2 x 2-1/4 x 1/2 80° Z-Bar	Mill	26 ga	10	10'
	GZB6301515	Galv. 3 x 1-1/2 x 1-1/2 Z-Bar	Mill	26 ga	10	10'
	GZB6302405	Galv. 3 x 2-1/4 x 1/2 Z-Bar	Mill	26 ga	10	10'
	GZB8201030	Galv. 2 x 1 x 3 Z-Bar	Mill	28 ga	10	10'

Flat Sheet	Part #	Description	Colors	Nom. Gauge/ Thickness	Lbs/Full Pallet	Lbs/Half Pallet	Piece Length
	GFS16410ML	Galv. 4 x 10 Flat Sheet	Mill	16 ga	4,000 Lbs.	n/a	10'
	GFS18410ML	Galv. 4 x 10 Flat Sheet	Mill	18 ga	4,000 Lbs.	n/a	10'
	GFS22410ML	Galv. 4 x 10 Flat Sheet	Mill	22 ga	4,000 Lbs.	2,000 Lbs.	10'
	GFS24310ML	Galv. 3 x 10 Flat Sheet	Mill	24 ga	4,000 Lbs.	2,000 Lbs.	10'
	GFS24410ML	Galv. 4 x 10 Flat Sheet	Mill	24 ga	4,000 Lbs.	2,000 Lbs.	10'
	GFS26310ML	Galv. 3 x 10 Flat Sheet	Mill	26 ga	4,000 Lbs.	2,000 Lbs.	10'
	GFS26410ML	Galv. 4 x 10 Flat Sheet	Mill	26 ga	4,000 Lbs.	2,000 Lbs.	10'
	GFS83510ML	Galv. 5 x 10 Flat Sheet	Mill	28 ga	4,000 Lbs.	2,000 Lbs.	10'
	BFS24410	Bond. 4 x 10 Flat Sheet	Bond	24 ga	4,000 Lbs.	2,000 Lbs.	10'
	BFS26410	Bond. 4 x 10 Flat Sheet	Bond	26 ga	4,000 Lbs.	2,000 Lbs.	10'
	CLFS410WH	TPO Clad 4 x 10 Flat Sheet	WH	26 ga	-	-	-

Flat Shingle	Part #	Description	Colors	Nom. Gauge/ Thickness	Pieces/ Bundle	Piece Length
	GSF657ML	Galv. 5 x 7 Flat Shingles	Mill	26 ga	100	7"
	GSF658 - -	Galv. 5 x 8 Flat Shingles	BR, C3, WH	26 ga	100	8"
	GSF668 - -	Galv. 6 x 8 Flat Shingles	BR, C3, WH	26 ga	100	8"
	GSF668ML	Galv. 6 x 8 Flat Shingles	Mill	26 ga	100	8"
	GSF66850 - -	Galv. 6 x 8 Flat Shingles	BR, C3, WH	26 ga	50	8"
	GSF66850ML	Galv. 6 x 8 Flat Shingles	Mill	26 ga	50	8"
	GSF6812 - -	Galv. 8 x 12 Flat Shingles	BR, C3, WH	26 ga	50	12"
	GSF6812ML	Galv. 8 x 12 Flat Shingles	Mill	26 ga	50	12"
	GSF857ML	Galv. 5 x 7 Flat Shingles	Mill	28 ga	100	7"
	GSF85750BR	Galv. 5 x 7 Flat Shingles	BR	28 ga	50	7"
	GSF85750ML	Galv. 5 x 7 Flat Shingles	Mill	28 ga	50	7"
	GSF868 - -	Galv. 6 x 8 Flat Shingles	BR, C3, WH	28 ga	100	8"
	GSF868ML	Galv. 6 x 8 Flat Shingles	Mill	28 ga	100	8"
	GSF86850 - -	Galv. 6 x 8 Flat Shingles	BR, C3, WH	28 ga	50	8"
	GSF86850ML	Galv. 6 x 8 Flat Shingles	Mill	28 ga	50	8"
	GSF8812 - -	Galv. 8 x 12 Flat Shingles	BR, C3, WH	28 ga	50	12"
	GSF8812ML	Galv. 8 x 12 Flat Shingles	Mill	28 ga	50	12"

## Roofing Accessories Colors:

COLOR	CODE	COLOR	CODE	COLOR	CODE	COLOR	CODE
BROWN	BR	CHARCOAL	C3	ROYAL BROWN	RB	WHITE	WH

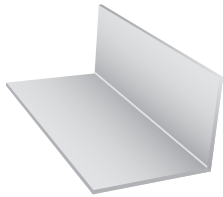
**Angle Flashing**

Part #	Description	Colors	Nom. Gauge/ Thickness	Pieces/ Box	Piece Length
AAF9121 - -	Alum. 1 x 2 Angle Flashing 110°	MB, RB, WH	0.019	10	10'
AAF9221 - -	Alum. 2 x 2 Angle Flashing 110°	MB, RB, WH	0.019	10	10'
GAF6115ML	Galv. 1 x 1-1/2 Angle Flashing	Mill	26 ga	10	10'
GAF6124ML	Galv. 1 x 2 4/12 Angle Flashing	Mill	26 ga	10	10'
GAF61515ML	Galv. 1-1/2 x 1-1/2 Angle Flashing	Mill	26 ga	10	10'
GAF6214ML	Galv. 1 x 14 Angle Flashing	Mill	26 ga	10	10'
GAF6215ML	Galv. 1 x 15 Angle Flashing	Mill	26 ga	10	10'
GAF623ML	Galv. 2 x 3 Angle Flashing	Mill	26 ga	10	10'
GAF624ML	Galv. 2 x 4 Angle Flashing	Mill	26 ga	10	10'
GAF633ML	Galv. 3 x 3 Angle Flashing	Mill	26 ga	10	10'
GAF635ML	Galv. 3 x 5 Angle Flashing	Mill	26 ga	10	10'
GAF644ML	Galv. 4 x 4 Angle Flashing	Mill	26 ga	10	10'
GAF646ML	Galv. 4 x 6 Angle Flashing	Mill	26 ga	10	10'
GAF6410ML	Galv. 4 x 10 Angle Flashing	Mill	26 ga	10	10'
GAF666RB	Galv. 6 x 6 Angle Flashing	RB	26 ga	10	10'
GAF666ML	Galv. 6 x 6 Angle Flashing	Mill	26 ga	10	10'
GTUF6355ML	Galv. 3-1/2 x 1/2 x 1/2 x 1/2 Tucker Flashing	Mill	26 ga	10	10'
GAF824ML	Galv. 2 x 4 Angle Flashing	Mill	28 ga	10	10'
GAF844ML	Galv. 4 x 4 Angle Flashing	Mill	28 ga	10	10'
GAF846ML	Galv. 4 x 6 Angle Flashing	Mill	28 ga	10	10'
GAF866ML	Galv. 6 x 6 Angle Flashing	Mill	28 ga	10	10'
GTUF8355ML	Galv. 3-1/2 x 1/2 x 1/2 x 1/2 Tucker Flashing	Mill	28 ga	10	10'
CLAFT66WH	TPO Clad 6 x 6 Angle Flashing	WH	24 ga	1	6'
CLAFT612WH	TPO Clad 6 x 12 Angle Flashing	WH	24 ga	1	12'

**Pre-Bent  
Step Flashing**

Part #	Description	Colors	Nom. Gauge/ Thickness	Pieces/ Box	Piece Length
GPSF6338ML	Galv. 3 x 3 x 8 Step Shingles	Mill	26 ga	50	8"
GPSF6357 - -	Galv. 3 x 5 x 7 Step Shingles	BR, WH	26 ga	50	7"
GPSF6357ML	Galv. 3 x 5 x 7 Step Shingles	Mill	26 ga	50	7"
GPSF6358 - -	Galv. 3 x 5 x 8 Step Shingles	BR, C3	26 ga	50	8"
GPSF6358ML	Galv. 3 x 5 x 8 Step Shingles	Mill	26 ga	50	8"
GPSF6448ML	Galv. 4 x 4 x 8 Step Shingles	Mill	26 ga	50	8"
GPSF64412M	Galv. 4 x 4 x 12 Step Shingles	Mill	26 ga	50	12"
GPSF64585B	Galv. 4 x 5 x 8 Step Shingles	BR	26 ga	50	8"
GPSF6458ML	Galv. 4 x 5 x 8 Step Shingles	Mill	26 ga	50	8"
GPSF64614M	Galv. 4 x 6 x 14 Step Shingles	Mill	26 ga	50	14"
GPSF6464BR	Galv. 4 x 6 x 14 Step Shingles	BR	26 ga	50	14"
GPSF6558BR	Galv. 5 x 5 x 8 Step Shingles	BR	26 ga	50	8"
GPSF6558ML	Galv. 5 x 5 x 8 Step Shingles	Mill	26 ga	50	8"
GPSF6668 - -	Galv. 6 x 6 x 8 Step Shingles	BR, C3	26 ga	50	8"
GPSF6668ML	Galv. 6 x 6 x 8 Step Shingles	Mill	26 ga	50	8"
GPSF6746BR	Galv. 7 x 4 x 6 Step Shingles	BR	26 ga	50	6"
GPSF8357ML	Galv. 3 x 5 x 7 Step Shingles	Mill	28 ga	50	7"
GPSF8358C3	Galv. 3 x 5 x 8 Step Shingles	C3	28 ga	50	8"
GPSF8358ML	Galv. 3 x 5 x 8 Step Shingles	Mill	28 ga	50	8"
GPSF84614M	Galv. 4 x 6 x 14 Step Shingles	Mill	28 ga	50	14"
GPSF8558ML	Galv. 5 x 5 x 8 Step Shingles	Mill	28 ga	50	8"
GPSF8555ML	Galv. 5 x 5 x 10 Step Shingles	Mill	28 ga	50	10"
GPSF8668ML	Galv. 6 x 6 x 8 Step Shingles	Mill	28 ga	50	8"
CPSF357	Copper 3 x 5 x 7 Step Shingles	Copper	16 oz	Order by the pc.	7"
CPSF88	Copper 8 x 8 Step Shingles	Copper	10 oz	Order by the pc.	8"
CPSF558	Copper 5 x 5 x 8 Step Shingles	Copper	10 oz	Order by the pc.	8"

**Roofing Accessories Colors:**

COLOR	CODE	COLOR	CODE	COLOR	CODE
BROWN	BR	CHARCOAL	C3	WHITE	WH

## Counter Flashing



Part #	Description	Colors	Nom. Gauge/ Thickness	Pieces/ Box	Piece Length
GCF2653ML	Galv. 1/2 x 3 Counter Flashing	Mill	26 ga	10	10'
GCF264ML	Galv. 4" Counter Flashing	Mill	26 ga	10	10'
GCF2655ML	Galv. 5" Counter Flashing	Mill	26 ga	10	10'
GCF266ML	Galv. 6" Counter Flashing	Mill	26 ga	10	10'
GCF268ML	Galv. 8" Counter Flashing	Mill	26 ga	10	10'
GCF2853ML	Galv. 1/2 x 3 Counter Flashing	Mill	28 ga	10	10'
GCF2855ML	Galv. 1/2 x 5 Counter Flashing	Mill	28 ga	10	10'
CCF55	Copper 1/2 x 5 Counter Flashing	Copper	16 oz	Order by the pc.	10'

## Reglet Flashing



Part #	Description	Colors	Nom. Gauge/ Thickness	Pieces/ Box	Boxes/ Pallet	Pieces/ Pallet	Piece Length
GRF2653ML	Galv. 1/2 x 3 Reglet Flashing	Mill	26 ga	10	25	250	10'
GRF264ML	Galv. 1/2 x 4 Reglet Flashing	Mill	26 ga	10	25	250	10'
GRF2655ML	Galv. 1/2 x 5 Reglet Flashing	Mill	26 ga	10	25	250	10'
GRF266ML	Galv. 1/2 x 6 Reglet Flashing	Mill	26 ga	10	25	250	10'
GRF268ML	Galv. 1/2 x 8 Reglet Flashing	Mill	26 ga	10	25	250	10'
GRF2853ML	Galv. 1/2 x 3 Reglet Flashing	Mill	28 ga	10	25	250	10'
GRF2855ML	Galv. 1/2 x 5 Reglet Flashing	Mill	28 ga	10	25	250	10'

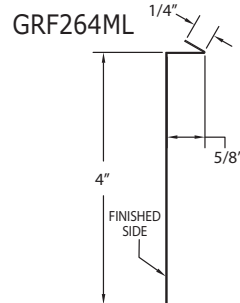
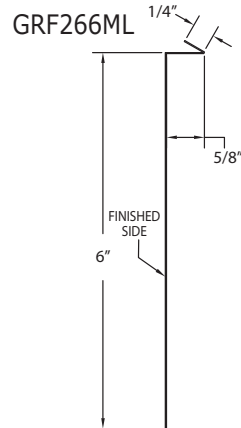

## Saddle Stock

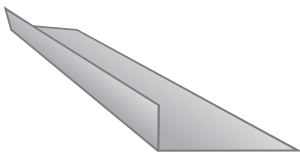

Part #	Description	Colors	Nom. Gauge/ Thickness	Pieces/ Box	Piece Length
GSA6414ML	Galv. 4 x 14 Saddle Stock 90°	Mill	26 ga	10	14"
GSA6614ML	Galv. 6 x 14 Saddle Stock 90°	Mill	26 ga	10	14"
GSA84149ML	Galv. 4 x 14 Saddle Stock 90°	Mill	28 ga	10	14"
GSA86149ML	Galv. 6 x 14 Saddle Stock 90°	Mill	28 ga	10	14"
CSA414	Copper 4 x 14 Saddle Stock 90°	Copper	16 oz	Order by the pc.	14"

## Tile Pan

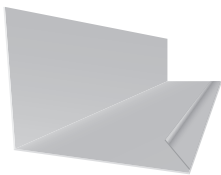

Part #	Description	Colors	Nom. Gauge/ Thickness	Pieces/ Box	Piece Length
GTP63545ML	Galv. 3-1/2 x 4 x 1/2 Tile Pan	Mill	26 ga	10	10'
GTP63565ML	Galv. 3-1/2 x 6 x 1/2 Tile Pan	Mill	26 ga	10	10'
GTP63585ML	Galv. 3-1/2 x 8 x 1/2 Tile Pan	Mill	26 ga	10	10'
GTP6461ML	Galv. 4 x 6 x 1 Tile Pan	Mill	26 ga	10	10'
GTP64611ML	Galv. 4 x 6 x 1 Tile Pan 110°	Mill	26 ga	10	10'
GTP6471ML	Galv. 4 x 7 x 1 Tile Pan	Mill	26 ga	10	10'
GTP64711ML	Galv. 4 x 7 x 1 Tile Pan 110°	Mill	26 ga	10	10'
GTP6681ML	Galv. 6 x 8 x 1 Tile Pan	Mill	26 ga	10	10'
GTPR6881ML	Galv. 8 x 8 x 1 Ribbed Tile Pan	Mill	26 ga	10	10'
GTP83545ML	Galv. 3-1/2 x 4 x 1/2 Tile Pan	Mill	28 ga	10	10'
GTP83565ML	Galv. 3-1/2 x 6 x 1/2 Tile Pan	Mill	28 ga	10	10'
PTPR26681	Bond. 6 x 8 x 1 Ribbed Tile Pan	Bond	26 ga	10	10'

**Tile Riser**

Part #	Description	Colors	Nom. Gauge/ Thickness	Pieces/ Box	Piece Length
GTRFL78 - -	Galv. Tile Riser Flat 7/8	BK, BR, C3, WH	28 ga	1	10'
GTRFLV - -	Galv. Tile Riser Flat Vent	BK, BR, C3, WH	28 ga	1	10'
GTRFL - -	Galv. 1-1/2 x 2-1/4 Eave Riser	BK, BR, C3, WH	28 ga	1	10'

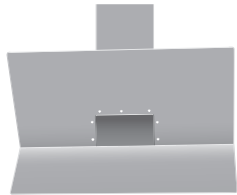
**Scupper**

Part #	Description	Colors	Nom. Gauge/ Thickness	Pieces/ Box
GSCC23ML	Galv. 2 x 3 Scupper Center	Mill	26 ga	1
GSCC33ML	Galv. 3 x 3 Scupper Center	Mill	26 ga	1
GSCC34ML	Galv. 3 x 4 Scupper Center	Mill	26 ga	1
GSCC46ML	Galv. 4 x 6 Scupper Center	Mill	26 ga	1
GSCC55ML	Galv. 5 x 5 Scupper Center	Mill	26 ga	1
GSCL23ML	Galv. 2 x 3 Scupper Left Corner	Mill	26 ga	1
GSCL34ML	Galv. 3 x 4 Scupper Left Corner	Mill	26 ga	1
GSCL46ML	Galv. 4 x 6 Scupper Left Corner	Mill	26 ga	1
GSCR23ML	Galv. 2 x 3 Scupper Right Corner	Mill	26 ga	1
GSCR34ML	Galv. 3 x 4 Scupper Right Corner	Mill	26 ga	1
GSCR46ML	Galv. 4 x 6 Scupper Right Corner	Mill	26 ga	1

**Roofing Accessories Colors:**

COLOR	CODE	COLOR	CODE	COLOR	CODE	COLOR	CODE
BLACK	BK	BROWN	BR	CHARCOAL	C3	WHITE	WH

Bird Stop	Part #	Description	Colors	Nom. Gauge/ Thickness	Pieces/ Box	Piece Length
	GBSES - -	Bird Stop Capistrano/Espana (So. Cal./Boral, AZ/Eagle)	BK, BR, C3, RD	28 ga	1	10'
	GBSMS - -	Bird Stop Mission (No. Cal./AZ, Boral)	BK, C3, RD	28 ga	1	10'
	GBSMU - -	Bird Stop Malibu (Eagle)	BK, BR, C3, RD	28 ga	1	10'
	GBSV9 - -	Bird Stop Villa (Boral)	BK, BR, C3, RD	28 ga	1	10'

**BIRD STOP DIMENSIONS**

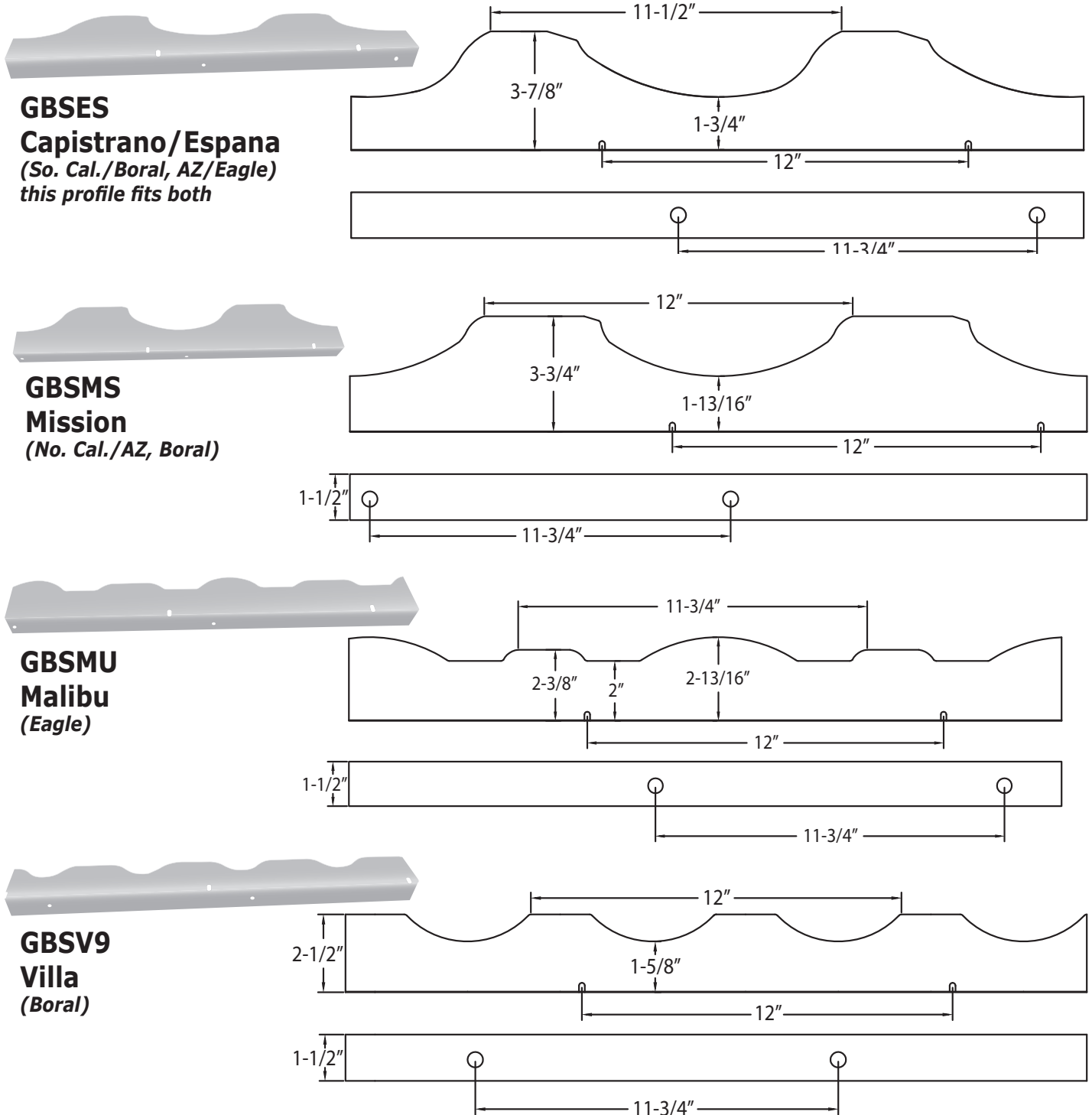

**Roofing Accessories Colors:**

COLOR	CODE	COLOR	CODE	COLOR	CODE	COLOR	CODE
BLACK	BK	BROWN	BR	CHARCOAL	C3	RED	RD

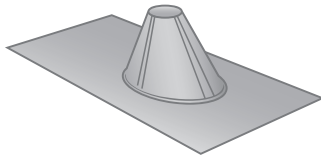
**Pipe Flashing**

Part #	Description	Colors	Nom. Gauge/ Thickness	Pieces/ Bundle
GPF12ML	Galv. 1/2" Pipe Flashing Regular BASE	Mill	26 ga	25
GPF34ML	Galv. 3/4" Pipe Flashing	Mill	26 ga	25
GPF1ML	Galv. 1" Pipe Flashing	Mill	26 ga	25
GPF15ML	Galv. 1-1/2" Pipe Flashing	Mill	26 ga	25
GPF2ML	Galv. 2" Pipe Flashing	Mill	26 ga	25
GPF3DML	Galv. 3" Pipe Flashing Double Wall	Mill	26 ga	25
GPF3ML	Galv. 3" Pipe Flashing	Mill	26 ga	25
GPF4DML	Galv. 4" Pipe Flashing Double Wall	Mill	26 ga	15
GPF4ML	Galv. 4" Pipe Flashing	Mill	26 ga	25
GPF5ML	Galv. 5" Pipe Flashing	Mill	26 ga	12
GPF6ML	Galv. 6" Pipe Flashing	Mill	26 ga	12
GPF7ML	Galv. 7" Pipe Flashing	Mill	26 ga	1
GPF8ML	Galv. 8" Pipe Flashing	Mill	26 ga	1
GPF12ML	Galv. 1/2" Pipe Flashing FHA	Mill	26 ga	25
GPF34ML	Galv. 3/4" Pipe Flashing FHA	Mill	26 ga	25
GPF1ML	Galv. 1" Pipe Flashing FHA	Mill	26 ga	25
GPF15ML	Galv. 1-1/2" Pipe Flashing FHA	Mill	26 ga	25
GPF2ML	Galv. 2" Pipe Flashing FHA	Mill	26 ga	25
GPF3ML	Galv. 3" Pipe Flashing FHA	Mill	26 ga	25
GPF4ML	Galv. 4" Pipe Flashing FHA	Mill	26 ga	25
GPF5ML	Galv. 5" Pipe Flashing FHA	Mill	26 ga	12
GPF6ML	Galv. 6" Pipe Flashing FHA	Mill	26 ga	12
GPF7ML	Galv. 7" Pipe Flashing FHA	Mill	26 ga	1
GPF8ML	Galv. 8" Pipe Flashing FHA	Mill	26 ga	1
GPF10ML	Galv. 10" Pipe Flashing FHA	Mill	26 ga	1
GPF3ML	Galv. 3" Pipe Flashing FHA Soil	Mill	26 ga	25
GPF4ML	Galv. 4" Pipe Flashing FHA Soil	Mill	26 ga	25
GPF5ML	Galv. 5" Pipe Flashing FHA Soil	Mill	26 ga	12
GPF6ML	Galv. 6" Pipe Flashing FHA Soil	Mill	26 ga	12
GPF3DML	Galv. 3" Pipe Flashing Double Wall FHA	Mill	26 ga	25
GPF4DML	Galv. 4" Pipe Flashing Double Wall FHA	Mill	26 ga	1
GPF6DML	Galv. 6" Pipe Flashing Double Wall FHA	Mill	26 ga	1
GPF4ML	Galv. 4" Oval Pipe Flashing FHA	Mill	26 ga	25

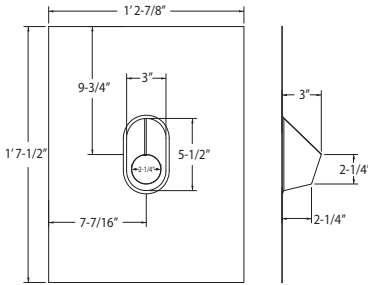
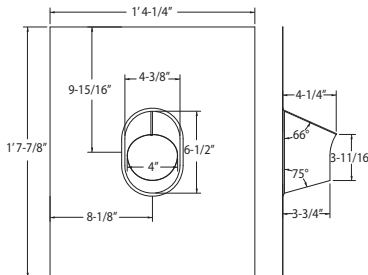
**GPF2ML**

**GPF4ML**

**ROUND PIPE FLASHINGS**

*Outside diameter of pipe determines the opening of the flashing.*

**3" PIPE**

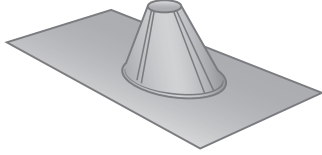
**4" PIPE**



## Plumber Flashing



Part #	Description	Colors	Nom. Gauge/ Thickness	Pieces/ Box
ADPRF12ML	Alum. 1/2" Plumbers Roof Flashing Alds.	Mill	0.019	20
ADPRF34ML	Alum. 3/4" Plumbers Roof Flashing Alds.	Mill	0.019	20
ADPRF1ML	Alum. 1" Plumbers Roof Flashing Alds.	Mill	0.019	20
ADPRF15ML	Alum. 1-1/2" Plumbers Roof Flashing Alds.	Mill	0.019	20
ADPRF2ML	Alum. 2" Plumbers Roof Flashing DS	Mill	0.019	20
ADPRF3ML	Alum. 3" Plumbers Roof Flashing Alds.	Mill	0.019	25
ADPRF4ML	Alum. 4" Plumbers Roof Flashing Alds.	Mill	0.019	20
ADPRF5ML	Alum. 5" Plumbers Roof Flashing Alds.	Mill	0.019	10
ADPRF6ML	Alum. 6" Plumbers Roof Flashing Alds.	Mill	0.019	10
ADPRF7ML	Alum. 7" Plumbers Roof Flashing DS	Mill	0.019	10
ADPRF8ML	Alum. 8" Plumbers Roof Flashing DS	Mill	0.019	10
ADPRF3DML	Alum. 3" Pipe Flashing Double Wall, Alds.	Mill	0.019	25
ADPRF4DML	Alum. 4" Pipe Flashing Double Wall, Alds.	Mill	0.019	25
ADPRFS3ML	Alum. 3" Plumbers Roof Flashing Soil, Alds.	Mill	0.019	25
ADPRFS4ML	Alum. 4" Plumbers Roof Flashing Soil, Alds.	Mill	0.019	25
ADPRFO4ML	Alum. 4" Plumbers Roof Flashing Oval Alds.	Mill	0.019	10
GPRF12ML	Galv. 1/2" Plumbers Roof Flashing	Mill	26 ga	25
GPRF34ML	Galv. 3/4" Plumbers Roof Flashing	Mill	26 ga	25
GPRF1ML	Galv. 1" Plumbers Roof Flashing	Mill	26 ga	25
GPRF15ML	Galv. 1-1/2" Plumbers Roof Flashing	Mill	26 ga	25
GPRF2ML	Galv. 2" Plumbers Roof Flashing	Mill	26 ga	25
GPRF3ML	Galv. 3" Plumbers Roof Flashing	Mill	26 ga	12
GPRF4ML	Galv. 4" Plumbers Roof Flashing	Mill	26 ga	12
GPRFS12ML	Galv. 1/2" Plumbers Roof Flashing Shingle	Mill	26 ga	25
GPRFS34ML	Galv. 3/4" Plumbers Roof Flashing Shingle	Mill	26 ga	25
GPRFS1ML	Galv. 1" Plumbers Roof Flashing Shingle	Mill	26 ga	25
GPRFS15ML	Galv. 1-1/2" Plumbers Roof Flashing Shingle	Mill	26 ga	25
GPRFS2ML	Galv. 2" Plumbers Roof Flashing Shingle	Mill	26 ga	25
GPRFS3ML	Galv. 3" Plumbers Roof Flashing Shingle	Mill	26 ga	12
GPRFS4ML	Galv. 4" Plumbers Roof Flashing Shingle	Mill	26 ga	12
GPRFSK34ML	Galv. 3/4" Plumbers Roof Flashing Shake	Mill	26 ga	25
GPRFSK1ML	Galv. 1" Plumbers Roof Flashing Shake	Mill	26 ga	25
GPRFSK15ML	Galv. 1-1/2" Plumbers Roof Flashing Shake	Mill	26 ga	25
GPRFSK2ML	Galv. 2" Plumbers Roof Flashing Shake	Mill	26 ga	25
GPRFSK3ML	Galv. 3" Plumbers Roof Flashing Shake	Mill	26 ga	12
GPRFSK15ML	Galv. 1-1/2" Plumbers Roof Flashing Shake	Mill	26 ga	25
GPRF2ML	Galv. 2" Plumbers Roof Flashing	Mill	26 ga	25
GPRFSK4ML	Galv. 4" Plumbers Roof Flashing Shake	Mill	26 ga	12
GPRFSK5ML	Galv. 5" Plumbers Roof Flashing Shake	Mill	26 ga	1
GPRFSK6ML	Galv. 6" Plumbers Roof Flashing Shake	Mill	26 ga	1
GPRFSK7ML	Galv. 7" Plumbers Roof Flashing Shake	Mill	26 ga	1
GPRFSK8ML	Galv. 8" Plumbers Roof Flashing Shake	Mill	26 ga	1
GPRFSK10ML	Galv. 10" Plumbers Roof Flashing Shake	Mill	26 ga	1
CPRF15	Copper 1-1/2" Plumbers Roof Flashing	Copper	26 ga	25

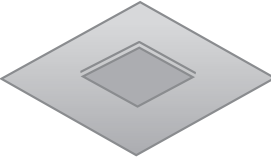

<b>Storm Collar</b>		<b>Part #</b>	<b>Description</b>	<b>Colors</b>	<b>Nom. Gauge/ Thickness</b>	<b>Pieces/ Box</b>
	GSTC3ML	Galv. 3" Storm Collar	Mill	26 ga	1	
	GSTC4ML	Galv. 4" Storm Collar	Mill	26 ga	1	
	GSTC5ML	Galv. 5" Storm Collar	Mill	26 ga	1	
	GSTC6ML	Galv. 6" Storm Collar	Mill	26 ga	1	
	GSTCA3ML	Galv. 3" Storm Collar Adj.	Mill	26 ga	1	
	GSTCA4ML	Galv. 4" Storm Collar Adj.	Mill	26 ga	1	
	GSTCA5ML	Galv. 5" Storm Collar Adj.	Mill	26 ga	1	
	GSTCA6ML	Galv. 6" Storm Collar Adj.	Mill	26 ga	1	
	GSTCA8ML	Galv. 8" Storm Collar Adj.	Mill	26 ga	1	
	GSTCO4ML	Galv. 4" Storm Collar Oval	Mill	26 ga	1	

<b>Sub Flashing</b>		<b>Part #</b>	<b>Description</b>	<b>Colors</b>	<b>Nom. Gauge/ Thickness</b>	<b>Pieces/ Box</b>
	GSBF78ML	Galv. 7 x 8 Sub Flashing	Mill	26 ga	1	
	GSBF1010ML	Galv. 10 x 10 Sub Flashing	Mill	26 ga	1	
	GSBF1414ML	Galv. 14 x 14 Sub Flashing	Mill	26 ga	1	

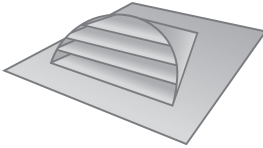
<b>Dormer Vent</b>		<b>Part #</b>	<b>Description</b>	<b>Colors</b>	<b>Nom. Gauge/ Thickness</b>	<b>Pieces/ Box</b>
	ADVS918ML	Alum. 9 x 18 Shake Dormer Vent, 75 NFA sq. in.	Mill	25 ga	1	
	ADVS1224ML	Alum. 12 x 24 Shake Dormer Vent, 100 NFA sq. in.	Mill	25 ga	1	
	GDVH918ML	Galv. 9 x 18 Half Round Dormer Vent, 75 NFA sq. in.	Mill	26 ga	1	
	GDVH1224ML	Galv. 12 x 24 Half Round Dormer Vent, 100 NFA sq. in.	Mill	26 ga	1	
	GDVHT918ML	Galv. 9 x 18 Half Round Dormer Vent w/Tile Hook, 75 NFA sq. in.	Mill	26 ga	1	
	GDVHT1224M	Galv. 12 x 24 Half Round Dormer Vent w/Tile Hook, 100 NFA sq. in.	Mill	26 ga	1	

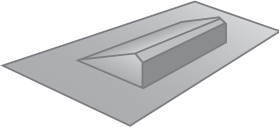
<b>Eyebrow Vent</b>		<b>Part #</b>	<b>Description</b>	<b>Colors</b>	<b>Nom. Gauge/ Thickness</b>	<b>Pieces/ Box</b>
	GEVRML	Galv. 22 x 31 Eyebrow Vents Regular 37 NFA sq. in.	Mill	26 ga	24	
	GEVSML	Galv. 31 x 28 Eyebrow Vents Shake 37 NFA sq. in.	Mill	26 ga	24	

## Fan Jack

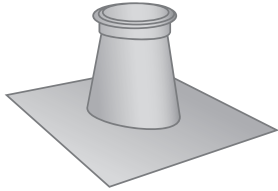

Part #	Description	Colors	Nom. Gauge/ Thickness	Pieces/ Box
GFNJ4ML	Galv. 4" Fan Jack Regular	Mill	26 ga	1
GFNJ6ML	Galv. 6" Fan Jack Regular	Mill	26 ga	1
GFNJ8ML	Galv. 8" Fan Jack Regular	Mill	26 ga	1
GFNJS6ML	Galv. 6" Fan Jack Shake	Mill	26 ga	1
GFNJS8ML	Galv. 8" Fan Jack Shake	Mill	26 ga	1
CFNJ4212	Copper 4" Fan Jack Regular, 2 Pc. 12/12		16 oz	Order by the pc.

## T-Top

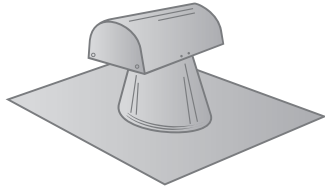

GTTF411

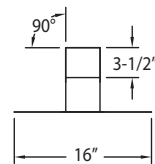
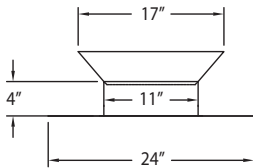
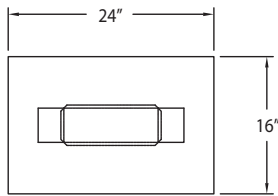

Part #	Description	Colors	Nom. Gauge/ Thickness	Pieces/ Box
ADTTRS4ML	Alum. 4" T-Tops DS Soil	Mill	0.025	25
ADTTR7ML	Alum. 7" T-Tops DS Cond.	Mill	0.025	25
GTTF4ML	Galv. 4" T-Tops Cond. FHA	Mill	26 ga	25
GTTF7ML	Galv. 7" T-Tops FHA	Mill	26 ga	25
GTTFS4ML	Galv. 4" T-Tops Soil FHA	Mill	26 ga	25
GTTR4ML	Galv. 4" T-Tops Regular	Mill	26 ga	25
GTTR7ML	Galv. 7" T-Tops Regular	Mill	26 ga	25
GTTRE4ML	Galv. 4" T-Tops Regular with Ends	Mill	26 ga	25
GTTRE7ML	Galv. 7" T-Tops Regular with Ends	Mill	26 ga	25
GTTS4ML	Galv. 4" T-Tops Shake	Mill	26 ga	25
GTTST4ML	Galv. 4" T-Tops Shake with Tile	Mill	26 ga	25
GTTST7ML	Galv. 7" T-Tops Shake with Tile	Mill	26 ga	25
GTTSTE4ML	Galv. 4" T-Tops Shake Tile with Ends	Mill	26 ga	25
GTTSTE7ML	Galv. 7" T-Tops Shake Tile with Ends	Mill	26 ga	25
GTTSF6ML	Galv. 6" T-Tops Square FHA	Mill	26 ga	25
GTTSSE4ML	Galv. 4" T-Tops Shake with Ends	Mill	26 ga	25
GTTSSE7ML	Galv. 7" T-Tops Shake with Ends	Mill	26 ga	25

## Parapet/Coping Cap

Part #	Description	Colors	Nom. Gauge/ Thickness	Pieces/ Box
GCCD6373ML	Galv. 3 x 7 x 3 Coping Cap	Mill	26 ga	1
GPCD6262ML	Galv. 2 x 6 x 2 Parapet Cap Drip	Mill	26 ga	10
GPCD6272WH	Galv. 2 x 7 x 2 Coping with Drip	WH	26 ga	1
GPCD6282WH	Galv. 2 x 8 x 2 Cap Drip	WH	26 ga	1
GPCD6282ML	Galv. 2 x 8 x 2 Cap Drip	Mill	26 ga	1
GPCD6292WH	Galv. 2 x 9 x 2 Coping with Drip	WH	26 ga	1
GPCD641012	Galv. 4 x 10 x 12 Cap Drip	Mill	26 ga	1
CLCD2318WH	TPO Clad 2 x 3-1/8 x 2 Cap Drip	WH	24 ga	1
CLCD2378WH	TPO Clad 2 x 3-7/8 x 2 Cap Drip	WH	24 ga	1
CLCD2425WH	TPO Clad 2 x 4-1/4 x 2 Cap Drip	WH	24 ga	1
CLC334ML	TPO Clad 3 x 3 x 4 Coping	Mill	24 ga	1

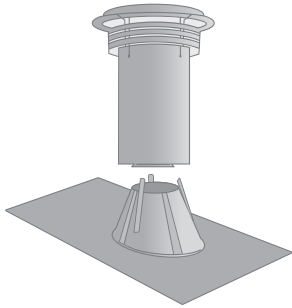
**Ventilation Products**

Part #	Description	Colors	Nom. Gauge/ Thickness	Pieces/ Box
ACCA3ML	Alum. 3" Code Cap Assembly Regular	Mill	N/A	1
ACCA4ML	Alum. 4" Code Cap Assembly Regular	Mill	N/A	1
ACCA5ML	Alum. 5" Code Cap Assembly Regular	Mill	N/A	1
ACCA6ML	Alum. 6" Code Cap Assembly Regular	Mill	N/A	1
ACCA7ML	Alum. 7" Code Cap Assembly Regular	Mill	N/A	1
ACCA8ML	Alum. 8" Code Cap Assembly Regular	Mill	0.250	1
ACCA10ML	Alum. 10" Code Cap Assembly Regular	Mill	0.250	1
ACCAOH4ML	Alum. 4" Code Cap Assy. Oval Horiz. Regular	Mill	N/A	1
ACCAOV4ML	Alum. 4" Code Cap Assy. Oval Vert. Regular	Mill	N/A	1
ACCAS3ML	Alum. 3" Code Cap Assembly Shake	Mill	N/A	1
ACCAS4ML	Alum. 4" Code Cap Assembly Shake	Mill	N/A	1
ACCAS5ML	Alum. 5" Code Cap Assembly Shake	Mill	N/A	1
ACCAS6ML	Alum. 6" Code Cap Assembly Shake	Mill	N/A	1
ACCAS7ML	Alum. 7" Code Cap Assembly Shake	Mill	N/A	1
ACCAS8ML	Alum. 8" Code Cap Assembly Shake	Mill	N/A	1
ACCASOH4ML	Alum. 4" Code Cap Assembly Shake Oval Horiz.	Mill	N/A	1
ACCASOV4ML	Alum. 4" Code Cap Assembly Shake Oval Vert.	Mill	N/A	1
ACCB3ML	Alum. 3" Code Cap Base Only Regular	Mill	N/A	1
ACCB4ML	Alum. 4" Code Cap Base Only Regular	Mill	N/A	1
ACCB5ML	Alum. 5" Code Cap Base Only Regular	Mill	N/A	1
ACCB6ML	Alum. 6" Code Cap Base Only Regular	Mill	N/A	1
ACCB7ML	Alum. 7" Code Cap Base Only Regular	Mill	N/A	1
ACCB8ML	Alum. 8" Code Cap Base Only Regular	Mill	N/A	1
ACCB10ML	Alum. 10" Code Cap Base Only Regular	Mill	N/A	1
ACCB12ML	Alum. 12" Code Cap Base Only Regular	Mill	N/A	1
ACCB0H4ML	Alum. 4" Code Cap Oval Horizontal Base Regular	Mill	N/A	1
ACCB0V4ML	Alum. 4" Code Cap Oval Vertical Base Regular	Mill	N/A	1
ACCBS3ML	Alum. 3" Code Cap Shake Base Only	Mill	N/A	1
ACCBS4ML	Alum. 4" Code Cap Shake Base Only	Mill	N/A	1
ACCBS5ML	Alum. 5" Code Cap Shake Base Only	Mill	N/A	1
ACCBS6ML	Alum. 6" Code Cap Shake Base Only	Mill	N/A	1
ACCBS6TML	Alum. 6" Code Cap Shake Base Only T	Mill	N/A	1
ACCBS7ML	Alum. 7" Code Cap Shake Base Only	Mill	N/A	1
ACCBS8ML	Alum. 8" Code Cap Shake Base Only	Mill	N/A	1
ACCBSOH4ML	Alum. 4" Oval Shake Base Only Horizontal	Mill	N/A	1
ACCBSOV4ML	Alum. 4" Oval Shake Base Only Vertical	Mill	N/A	1
ACCT3ML	Alum. 3" Code Cap Tops Only	Mill	N/A	1
ACCT4ML	Alum. 4" Code Cap Tops Only	Mill	N/A	1
ACCT5ML	Alum. 5" Code Cap Tops Only	Mill	N/A	1
ACCT6ML	Alum. 6" Code Cap Tops Only	Mill	N/A	1
ACCT7ML	Alum. 7" Code Cap Tops Only	Mill	N/A	1
ACCT8ML	Alum. 8" Code Cap Tops Only	Mill	N/A	1
ACCT10ML	Alum. 10" Code Cap Tops Only	Mill	N/A	1
ACCT12ML	Alum. 12" Code Cap Tops Only	Mill	N/A	1
ACCTO4ML	Alum. 4" Code Cap Oval Tops Only	Mill	N/A	1
ARVC3ML	Alum. 3" Round Vent Cap	Mill	N/A	1
ARVC4ML	Alum. 4" Round Vent Cap	Mill	N/A	1
ARVC5ML	Alum. 5" Round Vent Cap	Mill	N/A	1
ARVC6ML	Alum. 6" Round Vent Cap	Mill	N/A	1
ARVC7ML	Alum. 7" Round Vent Cap	Mill	N/A	1
ARVC8ML	Alum. 8" Round Vent Cap	Mill	N/A	1
AOVC4ML	Alum. 4" Oval Vent Cap	Mill	N/A	1

Ventilation Products *cont.*

Part #	Description	Colors	Nom. Gauge/ Thickness	Pieces/ Box
GGRV1414ML	Galv. 14 x 14 Gravity Roof Vent	Mill	26 ga	1
GGRV1818ML	Galv. 18 x 18 Gravity Roof Vent	Mill	26 ga	1
GGLR1424ML	Galv. 14 x 24 Gable Vent	Mill	28 ga	1
CCCA4	Copper 4" Code Cap Assembly Reg.	Copper	16 oz	Order by the pc.
CCCA6	Copper 6" Code Cap Assembly Reg.	Copper	16 oz	Order by the pc.
CCCAS6	Copper 6" Code Cap Assembly Shake	Copper	16 oz	Order by the pc.
CCCAB4	Copper 4" Code Cap Base Only	Copper	16 oz	Order by the pc.
CCCAB6	Copper 6" Code Cap Base Only	Copper	16 oz	Order by the pc.
CCCAT4	Copper 4" Code Cap Tops	Copper	16 oz	Order by the pc.
CCCAT6	Copper 6" Code Cap Tops	Copper	16 oz	Order by the pc.

Gravity  
Roof Vent

GGLR1424ML





# ROOFING & SIDING Accessories



## Many homes don't have the proper ventilation... Why?

- The same number of vents from the last roof are installed or repeating improper venting from a previous roof.
- Improper balance between the intake from the eaves and the outtake on the roof.
- Confusion regarding ventilation needed to properly vent the roof.

## Homeowners are more likely to buy from a contractor who educates the homeowner. Proper ventilation is important because...

- The roof will last longer and be properly covered by manufacturer warranties.
- It lowers cooling costs.
- It reduces risk for mildew and mold.

## More jobs and higher roofing sales come from doing the math!

1. Determine attic square footage:  
Length \_\_\_\_\_ x Width \_\_\_\_\_ = Attic Square Footage \_\_\_\_\_.
2. Determine NFA (Net Free Area) requirements:  
Attic Square Footage \_\_\_\_\_ ÷ 300 = NFA \_\_\_\_\_.
3. Convert square feet NFA to square inches:  
NFA Square Feet \_\_\_\_\_ x 144 = NFA Square Inches \_\_\_\_\_.
4. Split between intake\* (eaves) and outtake (roof):  
NFA Square Inches \_\_\_\_\_ ÷ 2 = NFA Inches Needed \_\_\_\_\_.
5. Calculate number of vents needed:  
NFA Inches Needed \_\_\_\_\_ ÷ Vent NFA \_\_\_\_\_ = # Amount of Vents \_\_\_\_\_.
6. Always round up number of vents to err on the side of caution so that roof material warranty is not voided.

**\*Don't forget to look at the ventilation in the eaves. You may have to make adjustments there as well!**

### 9 x 18 Shake or Half Round Dormer Vent

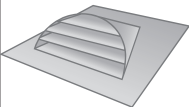
	Total Attic Sq. Ft.	Number of Vents	NFA Sq. In.
	0-1000	5	250
	1001-1500	7	350
	1501-2000	10	500
	2001-2500	12	600
	2501-3000	15	750

### 12 x 24 Shake or Half Round Vent

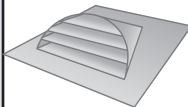
	Total Attic Sq. Ft.	Number of Vents	NFA Sq. In.
	0-1000	3	300
	1001-1500	4	400
	1501-2000	5	500
	2001-2500	6	600
	2501-3000	8	800

### Eyebrow Vent

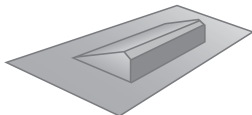
	Total Attic Sq. Ft.	Number of Vents	NFA Sq. In.
	0-1000	8	300
	1001-1500	11	400
	1501-2000	14	500
	2001-2500	16	600
	2501-3000	22	800

