

Installation Support • Soporte de instalación • Support d'installation

Personal Assistance, Product Specs, & "How-to" Questions:

Asistencia personal, especificaciones del producto y preguntas sobre "cómo hacerlo":

Aide personnelle, spécifications du produit et questions « pratico-pratiques » :

1-800-PFAUCET (732-8238)

pfisterfaucets.com/support

Installation Videos Available
Videos de instalación a disposición
Vidéos d'installation disponibles



pfisterfaucets.com/videos

▲ WARNING / AVERTENCIA / AVERTISSEMENT

To reduce the risk of injury or property damage, read all instructions before installing product. Wear safety goggles. Product must be installed in accordance with all state & local plumbing & building codes. Call a professional if you are uncertain about installing this product.

Para disminuir el riesgo de lesiones o daños a la propiedad, lea todas las instrucciones antes de instalar el producto. Utilice gafas de seguridad. El producto deberá instalarse de acuerdo con la normativa de plomería y construcción estatal y local. Llame a un profesional si no está seguro sobre cómo instalar este producto.

Pour réduire le risque de blessures ou de dommages, lisez toutes les instructions avant d'installer l'appareil. Porter des lunettes de sécurité. Il faut installer l'appareil en respectant tous les codes de construction et de plomberie locaux et d'État. Appelez un professionnel si vous n'êtes pas certain de la façon d'installer cet appareil.

Required Tools
Herramientas necesarias
Outils nécessaires

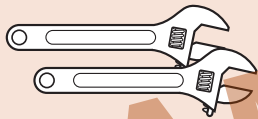

Adjustable Wrenches
Llaves ajustables
Clés à mollette



Plumber's Putty
Masilla para plomería
Mastic de plombier



Safety Goggles
Anteojos de seguridad
Lunettes de sûreté

Additional Helpful Tools
Otras herramientas útiles
Outils supplémentaires utiles

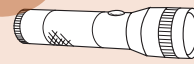

Flashlight
Linterna
Lampe De Poche



Cloth
Paño de limpieza
Chiffon

Parts in the Box • Piezas en la caja • Pieces dans la boîte

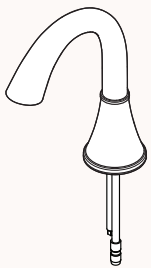

A



B

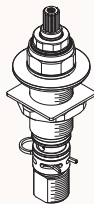

C (x2)



D (x2)



E (x2)



F



G

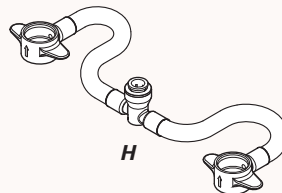

H

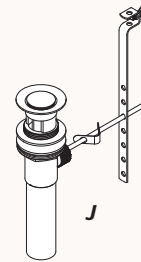

J



K



Aerator Tool
Herramienta para el aireador
Outil d'aérateur

1 Turn Off Water Supply • Cierre el suministro de agua • Couper l'alimentation en eau



Locate water supply inlets and shut off the water supply valves. These are usually found under the sink or near the water meter. If you are replacing an existing faucet, remove the old faucet from the sink and clean the sink surface thoroughly.

Ubique las entradas del suministro de agua y cierre las válvulas de suministro de agua. Generalmente se encuentran debajo del fregadero o cerca del medidor de agua. Si se trata de un reemplazo de grifo, quite el grifo viejo y limpie completamente la superficie del fregadero.

Repérer les arrivées d'eau et fermer leurs robinets. Ces robinets se trouvent généralement sous le lavabo ou à côté du compteur d'eau. En cas de remplacement d'un robinet existant, le déposer du lavabo et nettoyer soigneusement la surface de ce dernier.

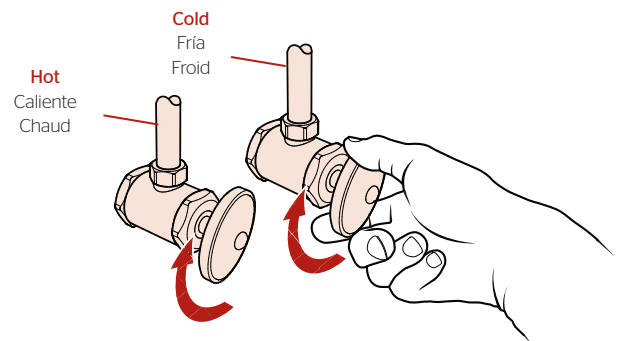

2 Prepare & Install Valve Bodies

Prepare e instale los cuerpos de la válvula

Préparez et installez les vannes

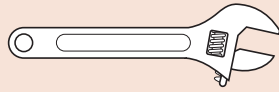

Adjustable Wrench
Llave ajustable
Clé réglable

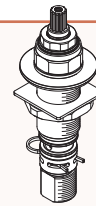

C (x2)

2A

Disassemble Valves Desensamble las válvulas Démontez les valves

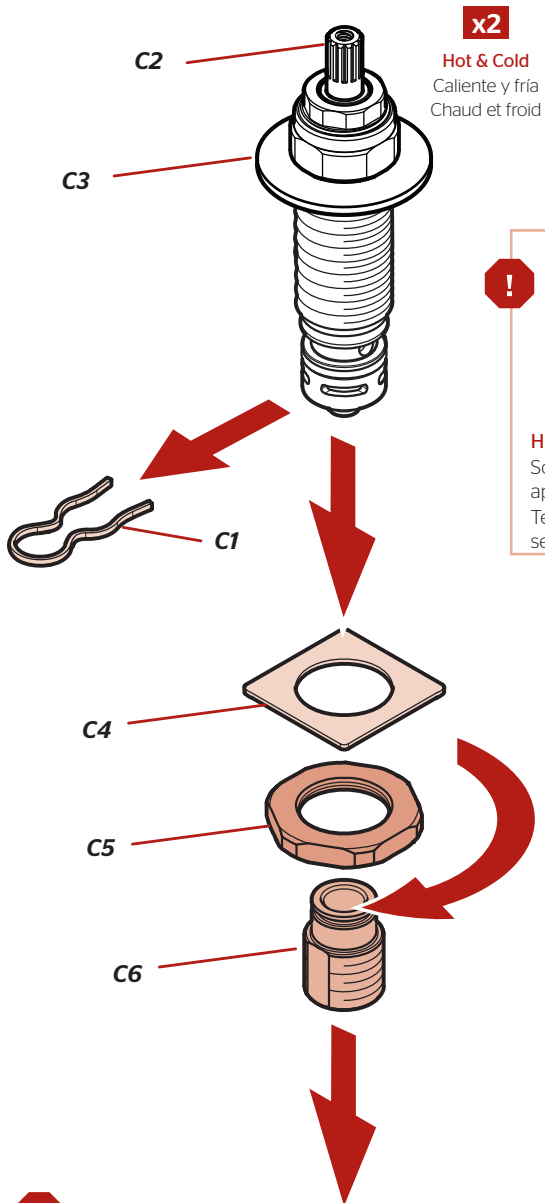

x2

Hot & Cold
Caliente y fría
Chaud et froid

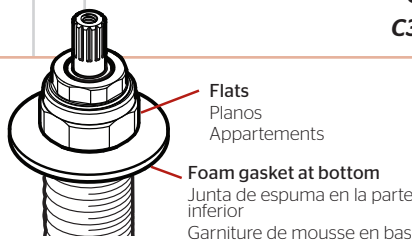

Hold flats while tightening with a wrench.
Sostenga las arandelas herméticas mientras aprieta con una llave.
Tenez les parties plates pendant que vous serrez avec une clé.

2B

Temporarily place handles onto stems to align the levers. **DO NOT** use handles to tighten valve.

Coloque temporalmente las manijas en los vástagos para alinear las palancas. **NO** utilice las manijas para apretar la válvula.

Placer temporairement les poignées sur les tiges pour aligner les leviers. **NE PAS** utiliser les poignées pour serrer la valve.

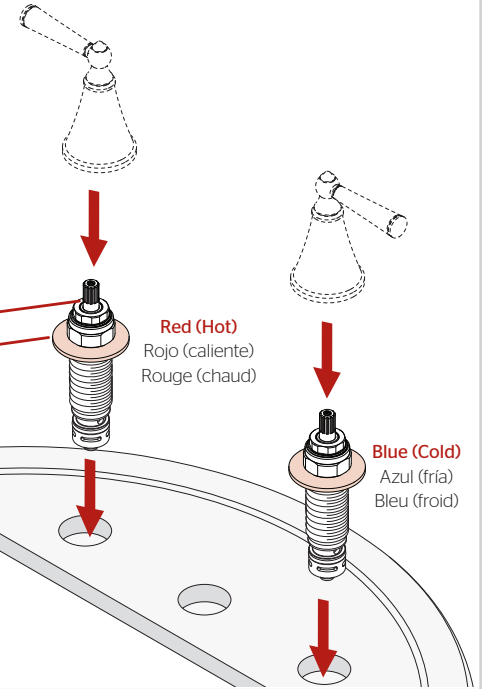

2C

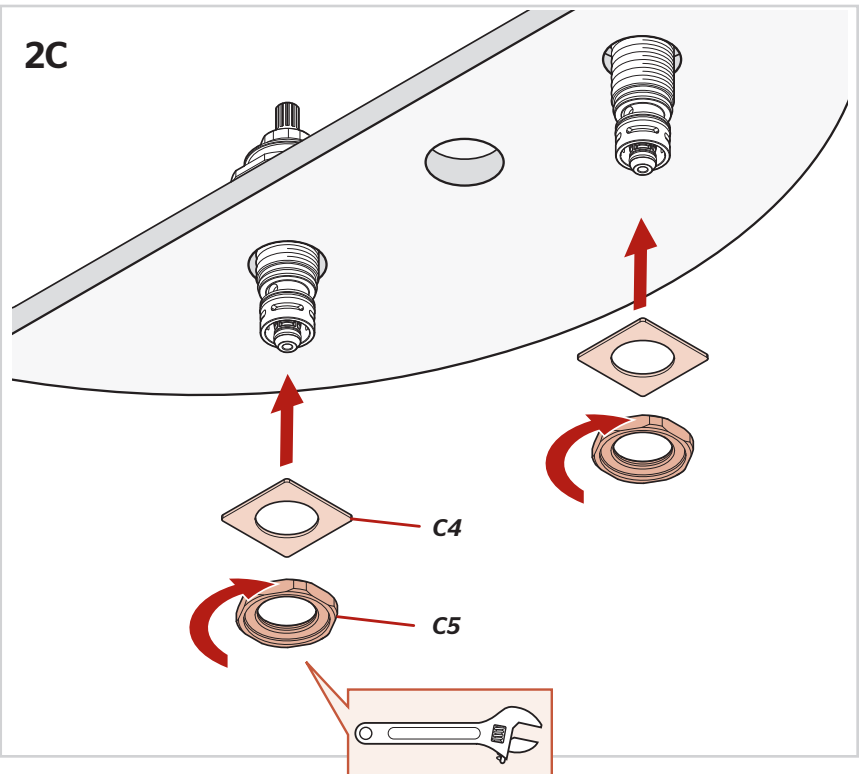

Save for Step 5.

Reserve para el paso 5.

Conservez pour l'étape 5.



C1 (x2)



C6 (x2)

3

Install Handles & Spout

Instale las manijas y el surtidor

Installez les poignées et le bec

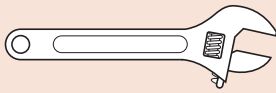

Adjustable Wrench
Llave ajustable
Clé réglable



Plumber's Putty
Masilla para plomería
Mastic de plombier

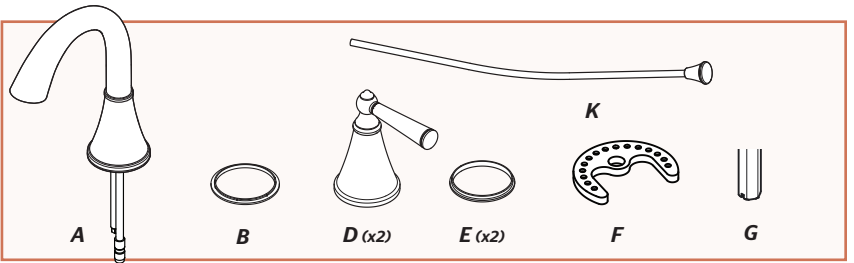

3A

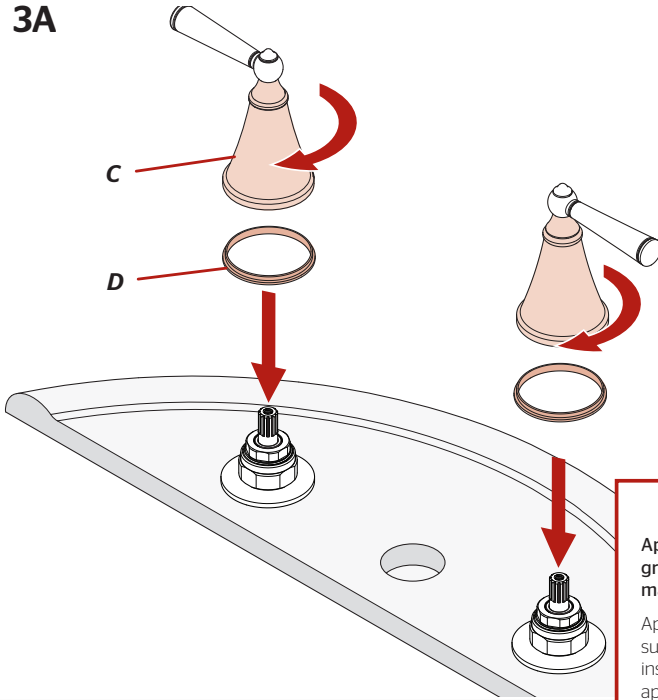

3B

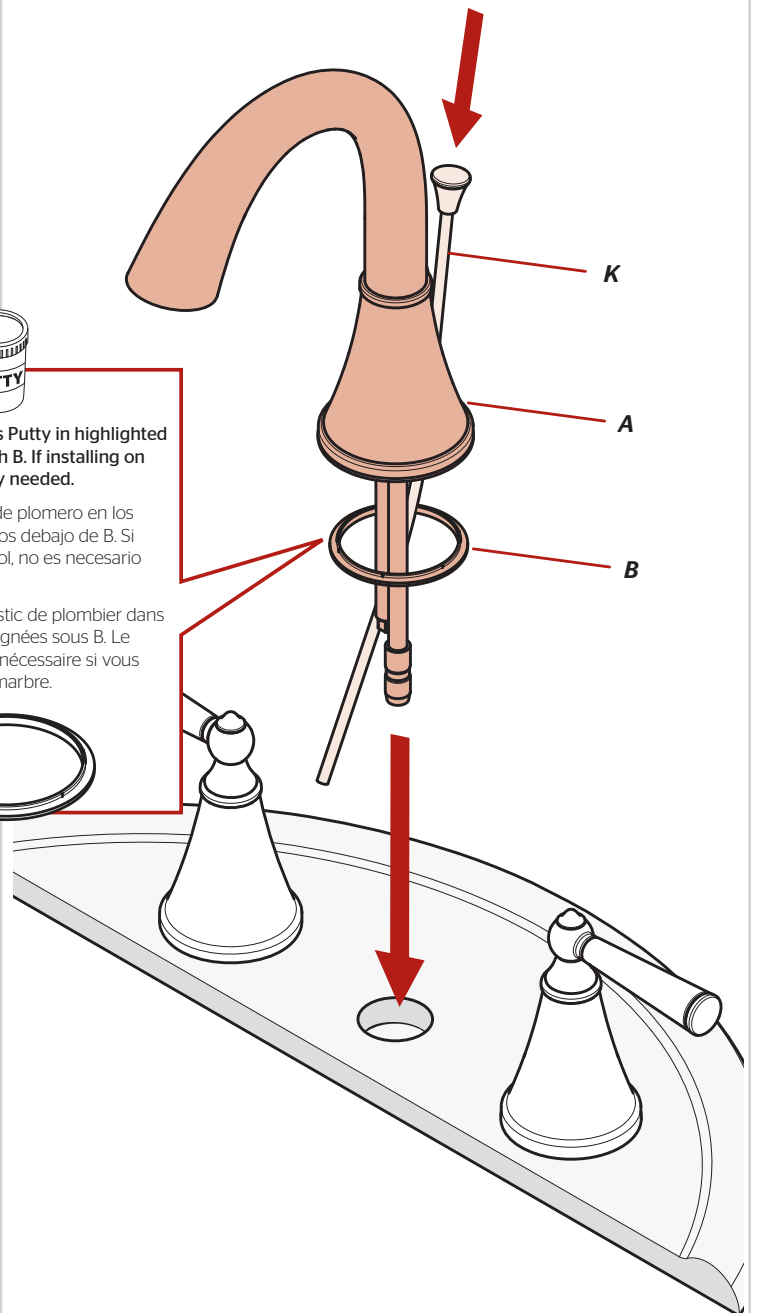

3C

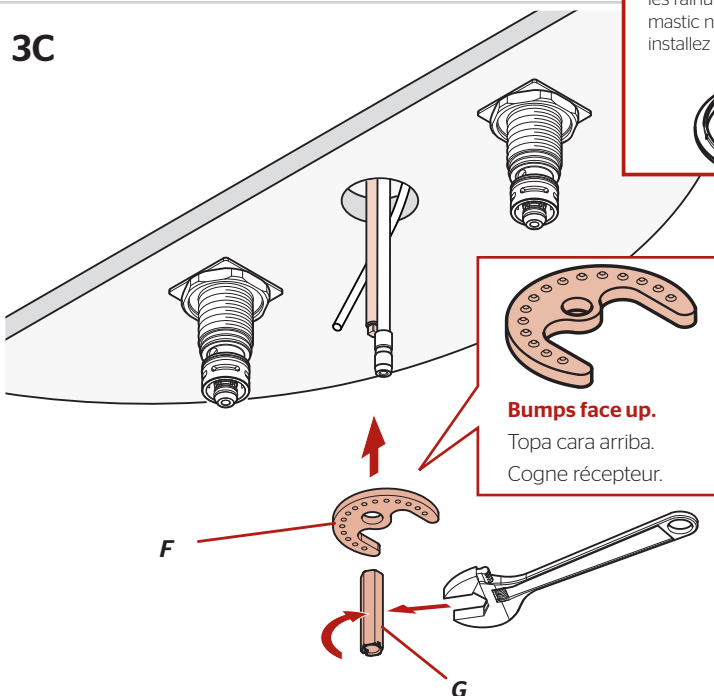

4

Install Hose

Instale la manguera

Posez le tuyau

No Tools Required for This Step
No se necesitan herramientas para este paso
Aucun outil n'est nécessaire pour cette étape

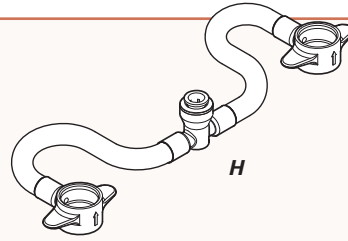

4A

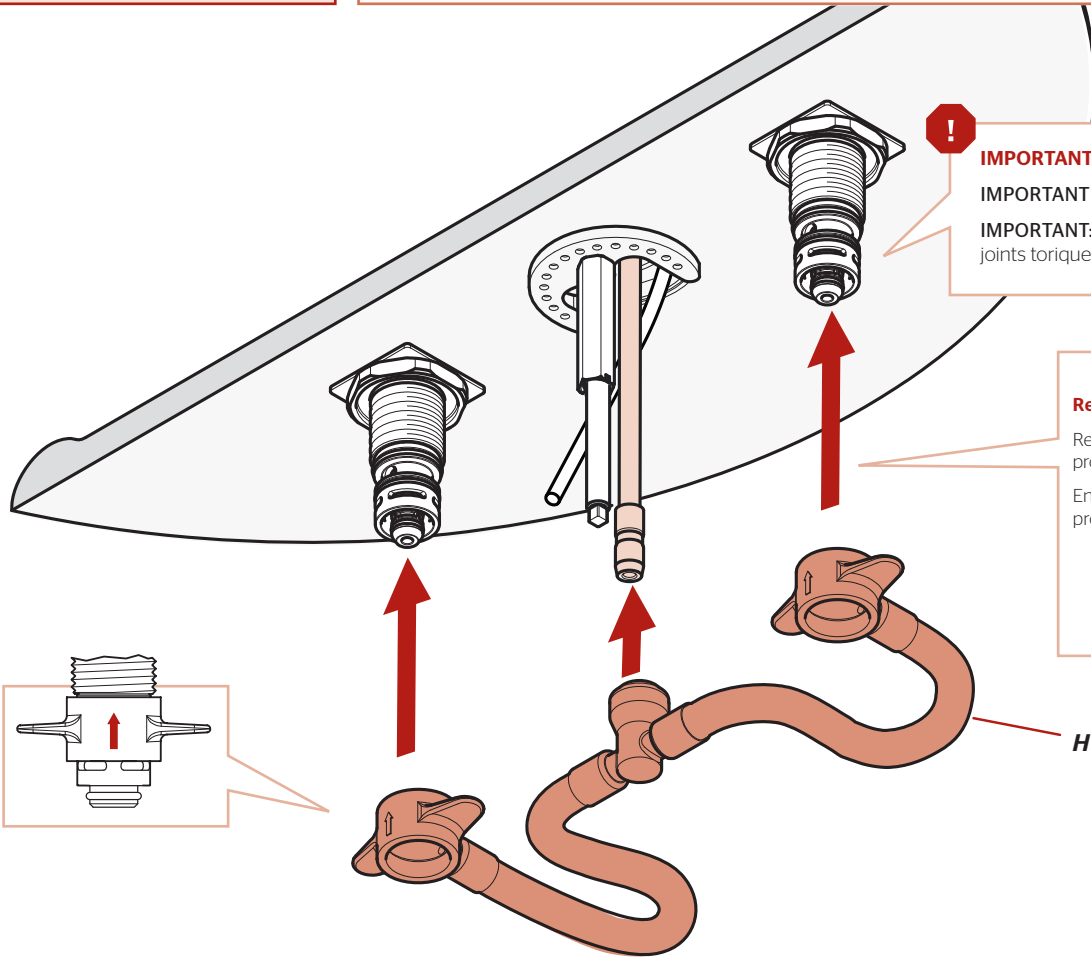

Check to see if the connection is secure by pulling down the Center Connector. If the Inner Colet separates slightly but does not pull off the Receiving Tube, connection is secure.

Revise si la conexión es segura halando hacia abajo el Quick Connector™. Si la anilla interna se separa ligeramente pero no se desprende del tubo receptor, la conexión está segura.

Vérifiez que le raccord est bien serré en tirant sur le Quick Connector™. Si le collet interne se sépare légèrement mais ne se détache pas du tube de réception, le raccord est bien serré.

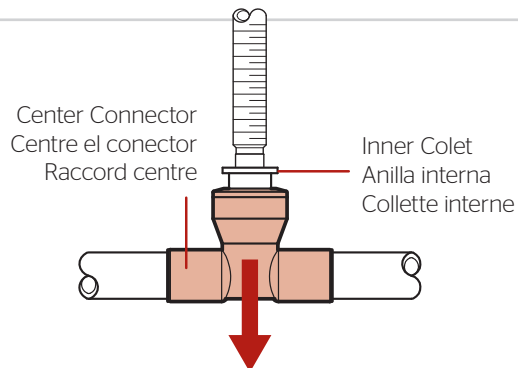

5

Connect Water Supply Lines

Conecte las tuberías de suministro de agua

Raccorder les conduites d'alimentation en eau

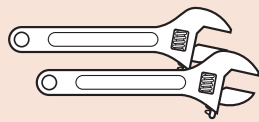

Adjustable Wrenches
Llaves ajustables
Clés à mollette



C1 (x2)



C6 (x2)

From Step 2.

Desde el paso 2.

De l'étape 2.



Water Supply Lines not included. Please consult manufacturer and/or its instructions for the correct method of installation of supply lines & fittings.

IMPORTANT: Incorrect application of supply lines and fittings may result in the failure or leak of the supply lines and fitting.

Las tuberías de suministro de agua no están incluidas. Consulte por favor el fabricante y/o sus instrucciones para el método correcto de instalación de líneas de suministro y de guarniciones.

IMPORTANTE: El uso incorrecto de líneas de suministro y de guarniciones puede dar lugar a la falta o al escape de las líneas de suministro y de la guarnición.

Les tuyaux d'arrivée d'eau ne sont pas fournis. Veuillez consulter le fabricant et/ou ses instructions pour la méthode correcte d'installation des canalisations et des garnitures d'alimentation.

IMPORTANT: L'application incorrecte des canalisations et des garnitures d'alimentation peut avoir comme conséquence l'échec ou la fuite des canalisations et de l'ajustage de précision d'alimentation.

5A

x2

Hot & Cold
Caliente y fría
Chaud et froid

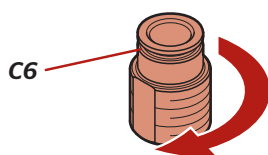
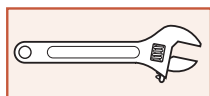

C6

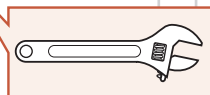

5B

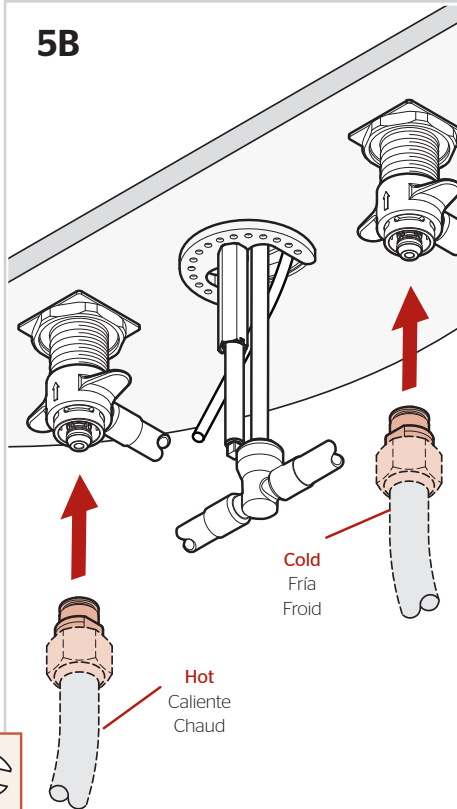

Cold
Fría
Froid

Hot
Caliente
Chaud

5C

x2

Hot & Cold
Caliente y fría
Chaud et froid

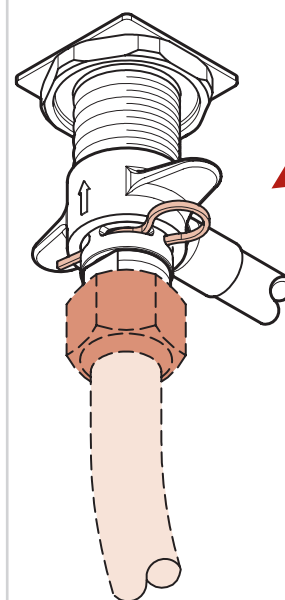

C1

6

Prepare & Install Pop-Up

Prepare e instale el tapón retráctil

Préparez & installez le bouchon à clapet

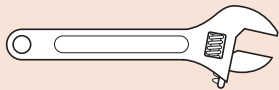

Adjustable Wrench
Llave ajustable
Clé réglable

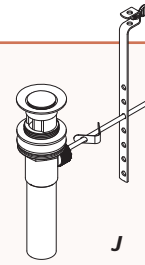

6A

Disassemble Pop-up Assembly

Desensamble el ensamble del tapón retráctil

Démontez l'ensemble bouchon à clapet

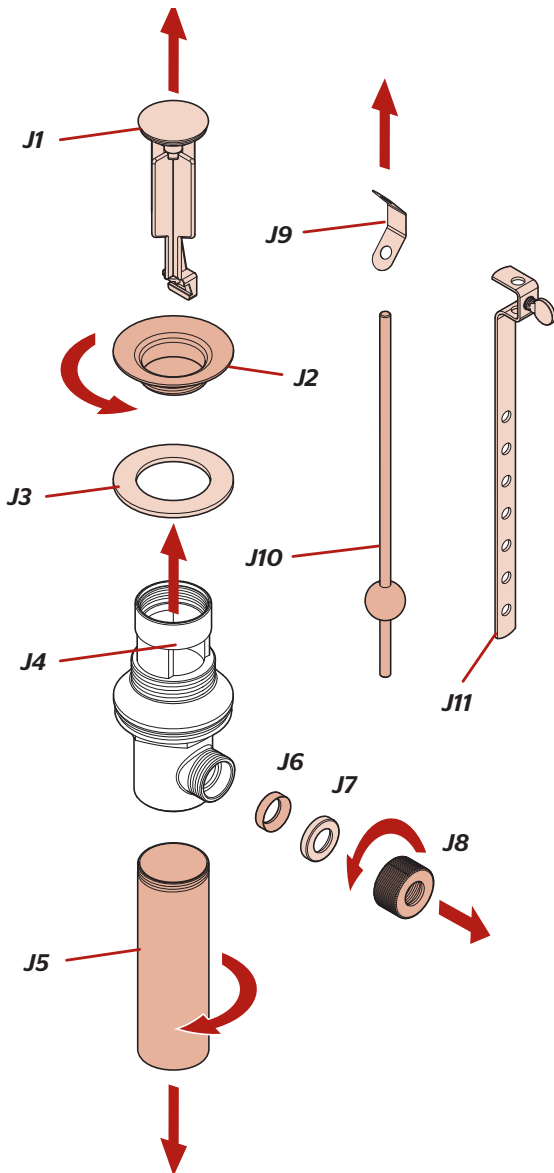

6B

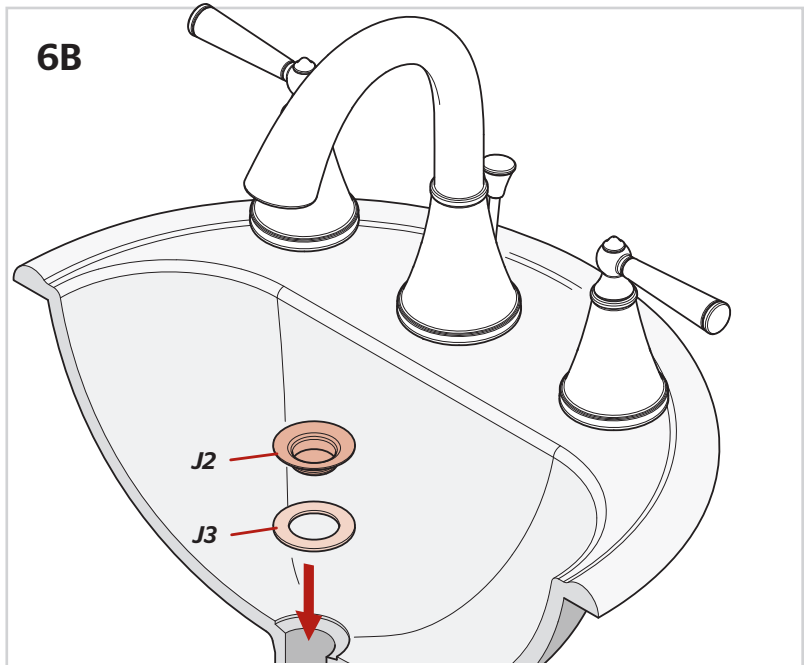

6C

Thread Drain Body (J4) to bottom of Flange (J2) and adjust so that Ball Rod opening faces rear.

Enrosque la estructura de desagüe (J4) a la parte inferior de la pestaña (J2) y ajuste de modo que la abertura de la varilla con glóbulo esté orientada hacia la parte posterior.

Vissez le corps du renvoi (J4) au bas de la bride (J2) et réglez de façon à ce que l'ouverture de la tige soit tournée vers l'arrière.

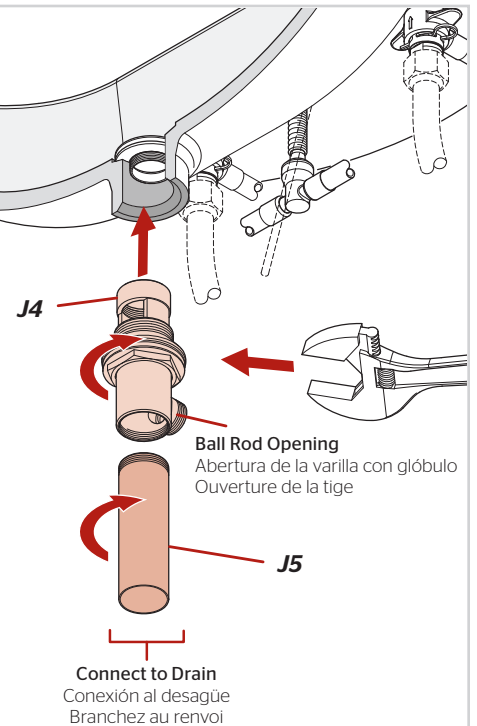

Connect to Drain
Conexión al desagüe
Branchez au renvoi

7 Prepare & Connect Lift Rod

Prepare y conecte la varilla de elevación

Préparez & connectez la tige levier

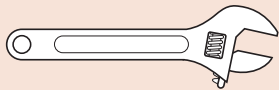

Adjustable Wrench
Llave ajustable
Clé réglable

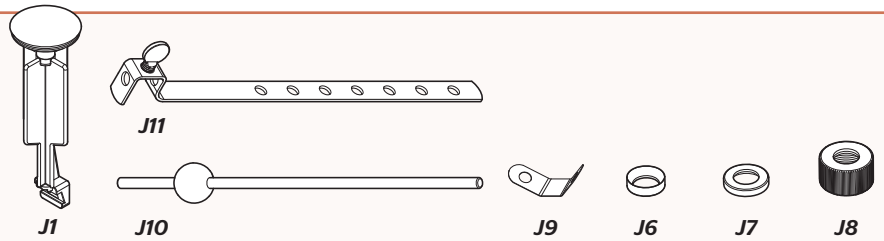

7A

Option 1
Opción 1
Option 1

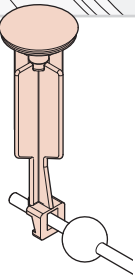

Option 2
Opción 2
Option 2

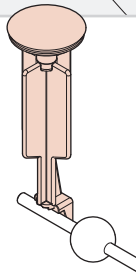

J1 can be installed in two ways: Fixed Position (Option 1) or a Removable Position (Option 2)

J1 puede instalarse de dos formas: posición fija (Opción 1) o posición removible (Opción 2).

On peut installer J1 de deux façons : Position fixe (Option 1) ou position amovible (Option 2).

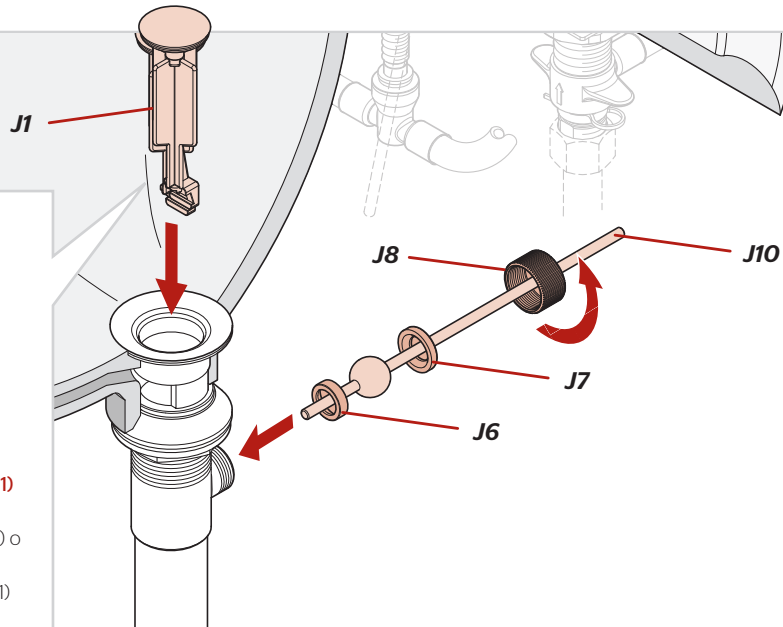

7B Assemble Lift Rod Connection

Ensamble de la conexión de varilla de elevación

Assemblez la connexion de la tige levier

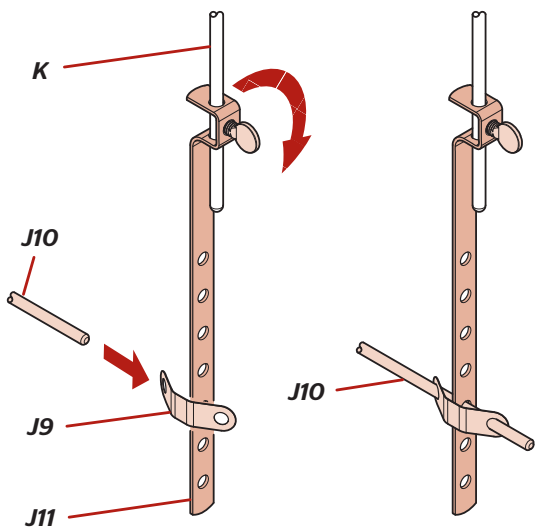

7C Pop-Up Completion

Terminer le bouchon à clapet

Finalización de la instalación del tapón retráctil

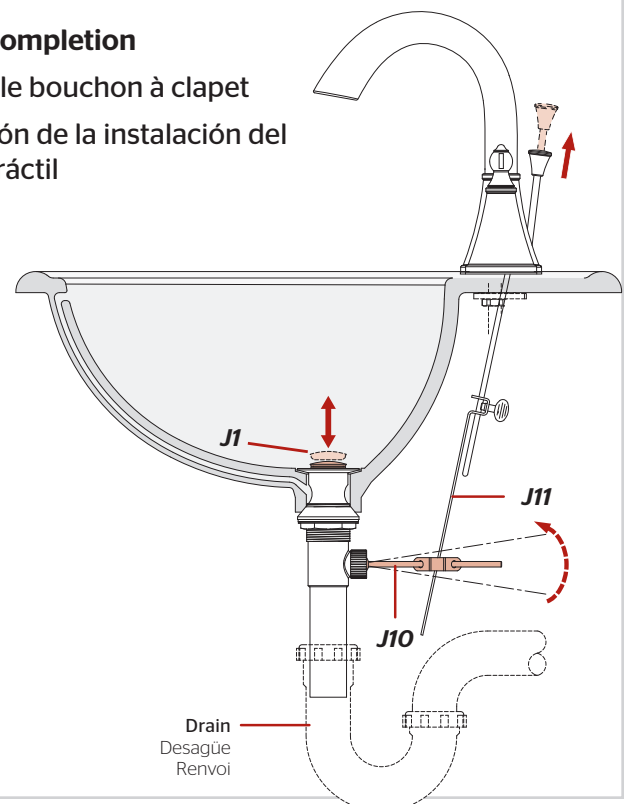

8 Turn On Water & Confirm Proper Installation

Active el suministro de agua y confirme que la instalación está adecuadamente efectuada

Ouvrez l'eau et confirmez que l'installation est adéquate

8A

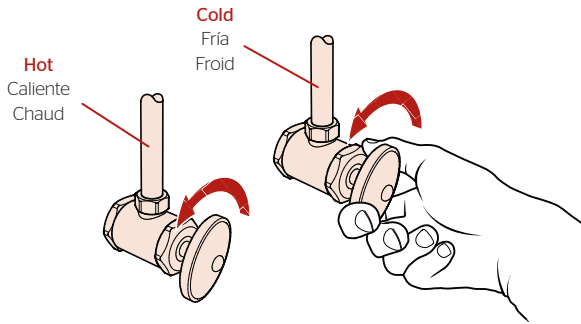

Faucet Functions • Funciones del grifo • Fonctions du robinet

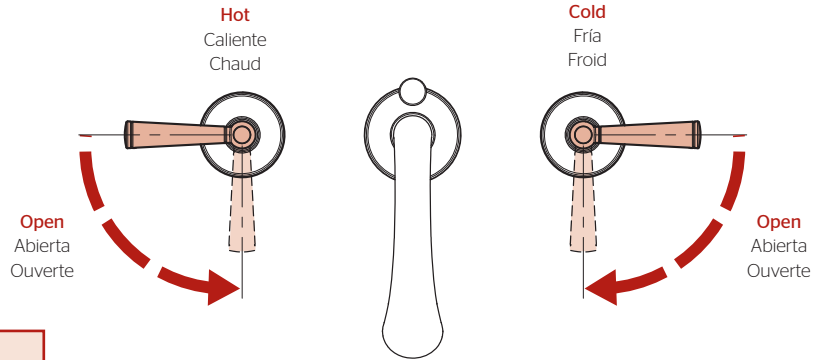

Check for leaks above and below the sink.

Revise si hay fugas encima y debajo del fregadero

Assurez-vous qu'il n'y a pas de fuite au dessus ou au dessous du lavabo

9 Flush the Faucet

Enjuague el grifo

Vidanger l'robinet

9A Remove Aerator Retire el aereador Retirez l'aérateur

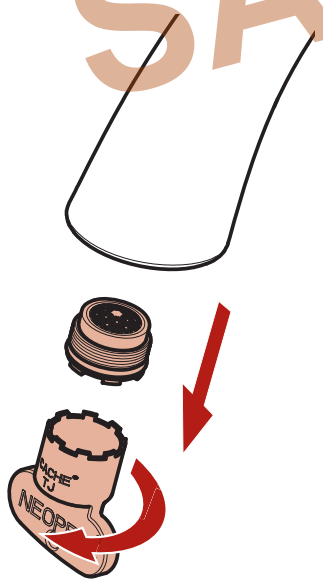

9B

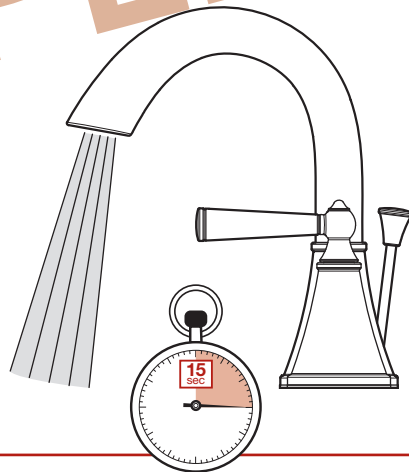

Allow full hot & full cold water to run for at least 15 seconds each.

Deje correr el agua caliente y fría durante al menos 15 segundos cada una.

Permettez à l'eau chaude et l'eau froide de couler au moins 15 secondes chacun.

9C Reinstall Aerator Reinstale el aereador Réinstallez l'aérateur

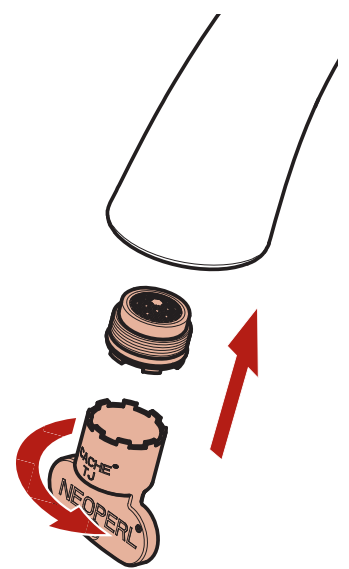

For Additional Installation Help:

Para la instalación adicionales de ayuda:

Pour aider à l'installation supplémentaires:

Pfister

1-800-PFAUCET (732-8238)

pfisterfaucets.com