

Features

- 36-inch minimum base cabinet width.
- Single bowl.
- Three oversized faucet holes with one oversized accessory hole to the right and one oversized accessory hole to the left.
- 5-1/4-inch depth.
- Includes cutout templates.

Material

- KOHLER® enameled cast iron.

Installation

- Under-mount.

Recommended Accessories

K-9000 P-Trap

Optional Accessories

K-8801 Sink Strainer



ADA

Codes/Standards















ASME A112.19.1/CSA B45.2
ADA
ICC/ANSI A117.1

KOHLER® Enameled Cast Iron Kitchen Sink - Lifetime Limited Warranty

See website for detailed warranty information.

Available Color/Finishes

Color tiles intended for reference only.

| Color | Code | Description |
|--|------|---------------|
|  | 0 | White |
|  | FF | Sea Salt™ |
|  | 96 | Biscuit |
|  | 47 | Almond |
|  | FD | Cane Sugar™ |
|  | NY | Dune |
|  | 95 | Ice™ Grey |
|  | G9 | Sandbar |
|  | 33 | Mexican Sand™ |
|  | K4 | Cashmere |
|  | FT | Basalt |
|  | 58 | Thunder™ Grey |
|  | 20 | Suede |
|  | KA | Black 'n Tan |
|  | FP | Caviar |

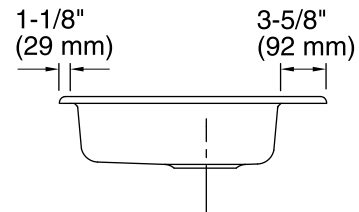
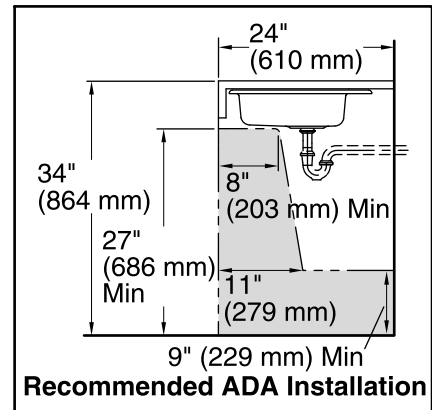
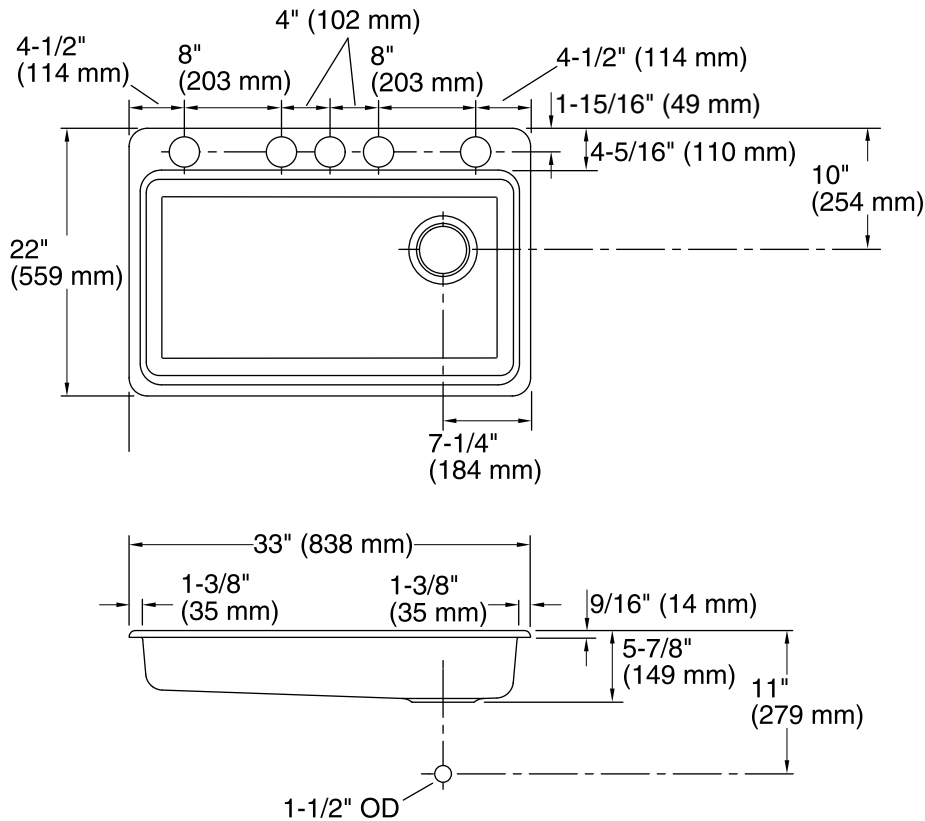

Technical Information

All product dimensions are nominal.

Bowl configuration: Single

Installation: Under-mount

Bowl area (Only) Length: 30-1/4" (769 mm)

Width: 17-1/4" (438 mm)

Bowl depth: 5-1/4" (133 mm)

Water depth: 5-1/4" (133 mm)

Template: 1166727-7, required, included

Notes

Install this product according to the installation instructions.

NOTICE: The countertop manufacturer or cutter must use the cut-out template provided with the product, or a current one provided by Kohler Co. (call 1-800-4KOHLER). Kohler Co. is not responsible for cut-out errors when the incorrect cut-out template is used.

ADA compliant when installed to the specific requirements of these regulations.