

Features

- 36-inch minimum base cabinet width.
- Single bowl.
- Three oversized faucet holes with one oversized accessory hole to the right and one oversized accessory hole to the left.
- 5-1/4-inch depth.
- Includes cutout templates.

Material

- KOHLER® enameled cast iron.

Installation

- Under-mount.

Recommended Accessories

- K-9000 P-Trap
- K-6237 Left-Bowl Sink Rack
- K-6255 Right-Bowl Sink Rack
- K-6377 Sponge Caddy
- K-6378 Kitchen Brush Caddy
- K-6379 Kitchen Squeegee
- K-6382 Disinfecting Wipes Dispenser
- K-6383 Soap Dispenser
- K-8618 Paper Towel Holder
- K-8619 Flexible Kitchen Mat
- K-8624 Dish Scraper

Optional Accessories

- K-8801 Sink Strainer



ADA

Codes/Standards















ASME A112.19.1/CSA B45.2
ADA
ICC/ANSI A117.1

KOHLER® Enameled Cast Iron Kitchen Sink Lifetime Limited Warranty

See website for detailed warranty information.

Available Color/Finishes

Color tiles intended for reference only.

Color	Code	Description
	0	White
	FF	Sea Salt™
	96	Biscuit
	47	Almond
	FD	Cane Sugar™
	NY	Dune
	95	Ice™ Grey
	G9	Sandbar
	33	Mexican Sand™
	K4	Cashmere
	FT	Basalt
	58	Thunder™ Grey
	20	Suede
	KA	Black 'n Tan
	FP	Caviar

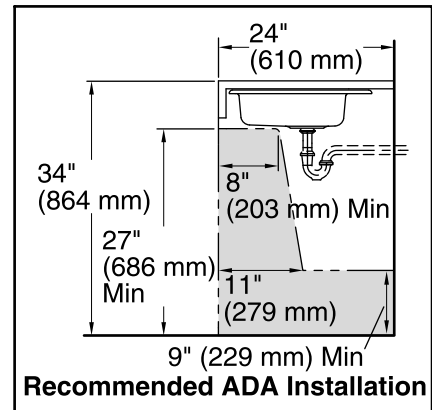
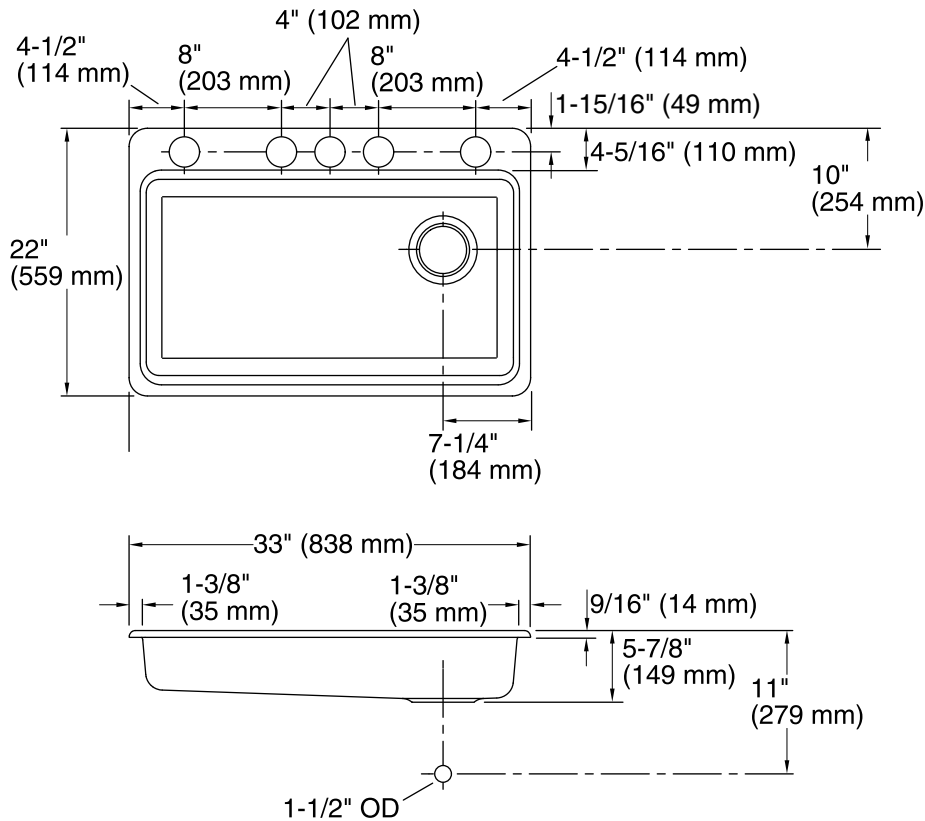

Recommended ADA Installation

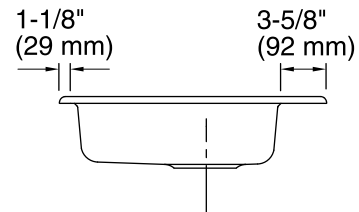

Technical Information

All product dimensions are nominal.

Bowl configuration: Single

Installation: Under-mount

Bowl area (Only): Length: 30-1/4" (769 mm)
Width: 17-1/4" (438 mm)
Bowl depth: 5-1/4" (133 mm)
Water depth: 5-1/4" (133 mm)

Template: 1166727-7, required, included

Notes

Install this product according to the installation instructions.

NOTICE: The countertop manufacturer or cutter must use the cut-out template provided with the product, or a current one provided by Kohler Co. (call 1-800-4KOHLER). Kohler Co. is not responsible for cut-out errors when the incorrect cut-out template is used.

ADA compliant when installed to the specific requirements of these regulations.