

# KRAFT

Quality "Hand Crafted" Tools for the Construction Trades



Series 0108



**Concrete Masonry Plaster Drywall Tile**

KRAFT TOOL CO.®

Elite Series  
Five Star Power™  
KRAFT TOOL CO.  
Plymouth, Minnesota USA

# TABLE OF CONTENTS

## Concrete Tools

*Elite Series, Trowels, Floats, Fresnos, Edgers, Groovers, Screeds*

*Pages 4-57*

## Hi-Craft™

*Value Priced Trade Tools*

*Pages 58-59*

## Sands Levels and Tools

*Levels, Squares, Rulers, T-Squares*

*Pages 60-71*

## W.Rose™ Tools

*World's Finest Bricklayers Tools*

*Pages 72-77*

## Masonry Tools

*Trowels, Jointers, Nylon Line, Mortar Boxes, Brushes*

*Pages 78-94*

## Plaster Tools

*Rubber Floats, Hawks, Trowels, Slickers, Darbies*

*Pages 95-99*

## EIFS Tools

*Notch Trowels, Sanding Rasps, Corner Tools*

*Pages 100*

## Drywall Tools

*Texture Gun, Taping Knives, Mud Pans, T-Squares, Sanders*

*Pages 101-112*

## Superior Tile Cutters

*Tile Cutters, Carbide Nippers, Floats, Chisels*

*Pages 113-119*

## Carpet Tools

*Carpet Stretcher, Knee Kicker, Carpet Trimmer*

*Pages 120-121*

## General Contractor

*Tool Bags, Nail Bags, Tool Aprons, Belts*

*Pages 122-123*

## Miscellaneous

*Apprentice Kits, Order Forms*

*Pages 124-126*

## Index

*Pages 127-131*

**NEW**

# FEATURED PRODUCTS '08

*Elite Series*

★★★★★ Five Star Concrete Finishing Trowels™  
Page 4-5



*Elite Series*

★★★★★ Five Star Pool Trowels™  
Page 5



*Elite Series*

★★★★★ Five Star Plaster Trowels™  
Page 5



**Mini Pool Trowel**  
Page 10



**Hi-Craft™ Joint Knives**  
Page 59

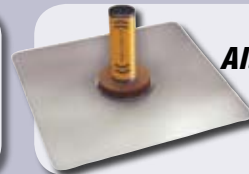

**Aluminum Hawks w/ ProForm® Handle**  
Page 96



**Cast Magnesium Drain Float**  
Page 20

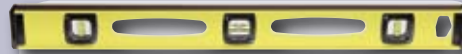

**Magnetic Extruded Aluminum Levels**  
Page 65



**Venetian Trowel**  
Page 98



**Buckaroo™ Straightedge**  
Page 23



**Variable Convex Jointer**  
Page 78



**Flex Neck for Gun & Hopper**  
Page 103



**BuckEye™ Straightedge**  
Page 29



**Leather & ProForm® Handles on Selected Masonry Products**  
Page 78-80



**Round Bottom EZ-Grip Mud Pan**  
Page 104



**Redwood Striker™**  
Page 29



**Heavy-Duty Acid Brush w/ Scraper**  
Page 82



**All Stainless Steel Joint Knives**  
Page 107



**Hi-Craft™ Econo Mag Float**  
Page 58



**Neptune Nylon Bonded-Braided Mason's Line**  
Page 85



**Joint Knives & Wall Scrapers w/ Rosewood Handles**  
Page 107



**Hi-Craft™ Texture Gun & Hopper**  
Page 59



**Mash & Sledge Hammers w/ Fiberglass Handles**  
Page 88



**High Visibility Drywall T-Square**  
Page 111

  
NEW

# Elite Series

Engineered for the Professional  
★★★★★ Five Star Trowel™

Kraft Tool Co.® proudly introduces a revolutionary new line of trowels. The *Elite Series Five Star Trowel™* is designed & engineered for the professional finisher. These professional trowels are manufactured with state of the art machinery that precisely finish grinds the working surface of each individual trowel. The innovating procedure enables these trowels to possess a truly "broken in" blade ready for immediate use.

The *Elite Series Five Star Trowel™* is available in 3 **NEW** handle styles that make these tools a finisher's favorite trowel: soft ProForm®, Hardwood and Leather.

*Elite Series Five Star Trowel™*  
Patent Pending

★ Unique, Lightweight No Turn Handle

★ Greater Flexibility & Durability to Reduce Fatigue

★ Power Pin Rivets for Exceptional Strength

★★★★★  
New Precision  
Ground Edge  
Ready for  
Immediate Use  
★★★★★

★ Each *Elite Series Five Star Trowel™* comes with a special edge protector to protect the trowel blade. Protector can also be used to hang trowels in storage.

*Elite Series*  
★★★★★ Five Star Concrete  
Finishing Trowels™

  
NEW

  
NEW

## Carbon Steel

### ProForm® Handle

No.	Size
CFE211PF	12"X3"
CFE212PF	12"X4"
CFE216PF	14"X3"
CFE217PF	14"X4"
CFE534PF	14"X5"
CFE222PF	16"X4"
CFE535PF	16"X5"
CFE227PF	18"X4"
CFE546PF	18"X5"
CFE231PF	20"X4"
CFE232PF	20"X5"

## Carbon Steel

### Wood Handle

No.	Size
CFE211	12"X3"
CFE212	12"X4"
CFE216	14"X3"
CFE217	14"X4"
CFE534	14"X5"
CFE222	16"X4"
CFE535	16"X5"
CFE227	18"X4"
CFE546	18"X5"
CFE231	20"X4"
CFE232	20"X5"

## Carbon Steel

### Leather Handle

No.	Size
CFE211L	12"X3"
CFE212L	12"X4"
CFE216L	14"X3"
CFE217L	14"X4"
CFE534L	14"X5"
CFE222L	16"X4"
CFE535L	16"X5"
CFE227L	18"X4"
CFE546L	18"X5"
CFE231L	20"X4"
CFE232L	20"X5"

*Elite Series*



★★★★★ Five Star Concrete Finishing Trowels™



**Golden Stainless Steel**

**ProForm® Handle**

No.	Size
CFE543PF	14"x5"
CFE545PF	16"x5"

**Wood Handle**

No.	Size
CFE543	14"x5"
CFE545	16"x5"

**Leather Handle**

No.	Size
CFE543L	14"x5"
CFE545L	16"x5"

*Elite Series*



★★★★★ Five Star Pool Trowels™



**Blue Steel**

**ProForm® Handle**

No.	Size	Shank
CFE292BPF	18"x5"	9-5/8"-short
CFE295BPF	20"x5"	11-5/8"-short
CFE738BPF	18"x4"	15-5/8"-long

**Wood Handle**

No.	Size	Shank
CFE292B	18"x5"	9-5/8"-short
CFE295B	20"x5"	11-5/8"-short
CFE738B	18"x4"	15-5/8"-long

**Leather Handle**

No.	Size	Shank
CFE292BL	18"x5"	9-5/8"-short
CFE295BL	20"x5"	11-5/8"-short
CFE738BL	18"x4"	15-5/8"-long

*Elite Series*



★★★★★ Five Star Plaster Trowels™



**Golden Stainless Steel**

**ProForm® Handle**

No.	Size
PLE454PF	11"x4-1/2"
PLE457PF	11-1/2"x4-3/4"
PLE459PF	12"x5"
PLE460PF	13"x5"

**Wood Handle**

No.	Size
PLE454	11"x4-1/2"
PLE457	11-1/2"x4-3/4"
PLE459	12"x5"
PLE460	13"x5"

**Leather Handle**

No.	Size
PLE454L	11"x4-1/2"
PLE457L	11-1/2"x4-3/4"
PLE459L	12"x5"
PLE460L	13"x5"

**NEW Clear View Trowel Carton**



**3 Handle Styles:  
ProForm®, Wood  
or Leather**



# Concrete FINISH TROWELS

*Professional Quality*

## Precision Balanced! Broken-in & Ready to Use!

Guaranteed "NO TURN" handle design locks handle to mounting.

Each blade is cross ground to just the right dimension for that perfect "Broken-in" feel.

High strength, light weight aluminum mounting.

Compression fit stainless steel rivets.

Oversized toe rivet for extra strength.

"Broken-in" edge for professional finish.

ProForm®  
Trowel Handle  
(US PATENT  
#6,247,204 B1)

Comfortable ProForm® Handle with a special textured ribbing for that "Great Grip".

ProForm® handled trowel packaging.. with unique "Open View" design and colorful graphics



## Carbon Steel



### ProForm® Handle

No.	Size
CF201PF	10"x3"
CF202PF	10"x4"
CF207PF	11"x4"
CF211PF	12"x3"
CF212PF	12"x4"
CF216PF	14"x3"
CF215PF	14"x3-1/2"
CF217PF	14"x4"
CF218PF	14"x4-1/2"
CF219PF	14"x4-3/4"
CF534PF	14"x5"
CF221PF	16"x3"
CF220PF	16"x3-1/2"
CF222PF	16"x4"
CF223PF	16"x4-1/2"
CF224PF	16"x4-3/4"
CF535PF	16"x5"
CF226PF	18"x3"
CF225PF	18"x3-1/2"
CF227PF	18"x4"
CF228PF	18"x4-1/2"
CF229PF	18"x4-3/4"
CF546PF	18"x5"
CF231PF	20"x4"
CF232PF	20"x5"
CF550PF	22"x5"
CF233PF	24"x4"
CF234PF	24"x5"

### Camelback Wood Handle

No.	Size
CF201C	10"x3"
CF202C	10"x4"
CF207C	11"x4"
CF211C	12"x3"
CF212C	12"x4"
CF216C	14"x3"
CF215C	14"x3-1/2"
CF217C	14"x4"
CF218C	14"x4-1/2"
CF219C	14"x4-3/4"
CF534C	14"x5"
CF220C	16"x3-1/2"
CF222C	16"x4"
CF223C	16"x4-1/2"
CF224C	16"x4-3/4"
CF535C	16"x5"
CF221C	16"x3"
CF226C	18"x3"
CF225C	18"x3-1/2"
CF227C	18"x4"
CF228C	18"x4-1/2"
CF229C	18"x4-3/4"
CF546C	18"x5"
CF231C	20"x4"
CF232C	20"x5"
CF550C	22"x5"
CF233C	24"x4"
CF234C	24"x5"

### Straight Wood Handle

No.	Size
CF201	10"x3"
CF202	10"x4"
CF207	11"x4"
CF211	12"x3"
CF212	12"x4"
CF216	14"x3"
CF215	14"x3-1/2"
CF217	14"x4"
CF218	14"x4-1/2"
CF219	14"x4-3/4"
CF221	16"x3"
CF220	16"x3-1/2"
CF222	16"x4"
CF223	16"x4-1/2"
CF224	16"x4-3/4"
CF226	18"x3"
CF225	18"x3-1/2"
CF227	18"x4"
CF228	18"x4-1/2"
CF229	18"x4-3/4"
CF231	20"x4"
CF232	20"x5"

**Precision Balanced!  
Broken-in & Ready to Use!**

# Concrete FINISH TROWELS

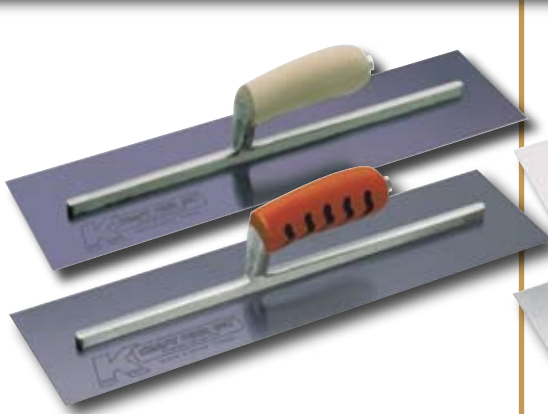

## Blue Steel

- High quality blue steel with additional flexibility
- Forged aluminum shank

### Camel Back Handle

No.	Size
CF726B	12"x3"
CF730B	12"x4"
CF727B	14"x3"
CF731B	14"x4"
CF732B	16"x4"
CF729B	18"x4"
CF733B	18"x5"
CF728B	20"x4"
CF734B	20"x5"
CF743B	24"x4"
CF735B	24"x5"

### ProForm® Handle

No.	Size
CF726BPF	12"x3"
CF730BPF	12"x4"
CF727BPF	14"x3"
CF731BPF	14"x4"
CF732BPF	16"x4"
CF729BPF	18"x4"
CF733BPF	18"x5"
CF728BPF	20"x4"
CF734BPF	20"x5"
CF743BPF	24"x4"
CF735BPF	24"x5"



## Swedish Stainless Steel

- High quality heat treated Swedish stainless steel
- Special alloy will not rust, pit, or stain
- Forged aluminum shank

### Camel Back Handle

No.	Size
CF742	12"x4"
CF744	14"x4"
CF747	16"x4"

### ProForm® Handle

No.	Size
CF742PF	12"x4"
CF744PF	14"x4"
CF747PF	16"x4"

### Replacement ProForm® Handle



No. CF053 ProForm® Camel Back Handle

### Replacement Woods Handles

Straight



No. CF052 Straight Handle

No. CF051 Camel Back Handle

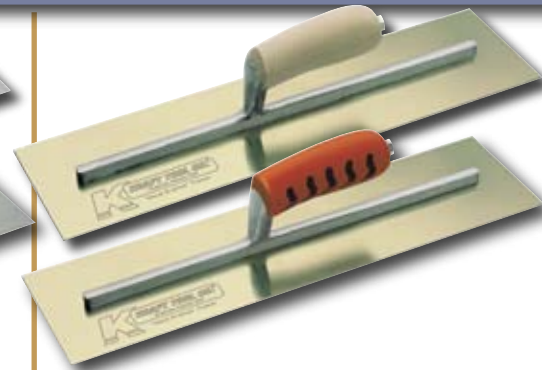

## Golden Stainless Steel

- Heat treated golden stainless steel
- Special alloy will not rust, pit, or stain
- Forged aluminum shank

### Camel Back Handle

No.	Size
CF536	12"x4"
CF541	14"x4"
CF540	14"x4-3/4"
CF543	14"x5"
CF533	16"x4"
CF542	16"x4-1/2"
CF545	16"x5"
CF547	18"x4"
CF548	18"x5"
CF549	20"x5"

### ProForm® Handle

No.	Size
CF536PF	12"x4"
CF541PF	14"x4"
CF540PF	14"x4-3/4"
CF543PF	14"x5"
CF533PF	16"x4"
CF542PF	16"x4-1/2"
CF545PF	16"x5"
CF547PF	18"x4"
CF548PF	18"x5"
CF549PF	20"x5"

## Carbon Steel Rounded Corner Silo Trowel



Choice of Handle

Finish hard to get places. Special rounded ends (1/2" radius) prevents digging on slab.

### Camel Back Wood Handle

No.	Size
CF332	14"x4"
CF333	16"x4"



### ProForm® handle

No.	Size
CF332PF	14"x4"
CF333PF	16"x4"



## Trowel Sharpener

Keeps edges sharp. Ideal tool for eliminating small nicks and dull edges of finishing trowels.

No. CF200



Professional Quality

# Pool Trowels

## Blue Steel Short Shanks

- Short shank more flexible blade

### Camel Back Wood Handle

No.	Size	Shank
CF274B	10"x3"	3"
CF271B	12"x3"	4-3/8"
CF276B	12"x3-1/2"	4-3/8"
CF272B	14"x3"	6"
CF277B	14"x4"	6"
CF273B	16"x3"	7-5/8"
CF279B	16"x4"	7-5/8"
CF292B	18"x5"	9-5/8"
CF295B	20"x5"	11-5/8"
CF296B	22"x5"	13-5/8"
CF297B	24"x5"	13-5/8"

### ProForm® Handle

No.	Size	Shank
CF274BPF	10"x3"	3"
CF271BPF	12"x3"	4-3/8"
CF276BPF	12"x3-1/2"	4-3/8"
CF272BPF	14"x3"	6"
CF277BPF	14"x4"	6"
CF273BPF	16"x3"	7-5/8"
CF279BPF	16"x4"	7-5/8"
CF292BPF	18"x5"	9-5/8"
CF295BPF	20"x5"	11-5/8"
CF296BPF	22"x5"	13-5/8"
CF297BPF	24"x5"	13-5/8"

## Short Shanks

## Golden Stainless Steel

### Camel Back Wood Handle

No.	Size	Shank
CF274	10"x3"	3"
CF276	12"x3-1/2"	4-3/8"
CF277	14"x4"	6"
CF279	16"x4"	7-5/8"

### ProForm® Handle

No.	Size	Shank
CF274PF	10"x3"	3"
CF276PF	12"x3-1/2"	4-3/8"
CF277PF	14"x4"	6"
CF279PF	16"x4"	7-5/8"

## Blue Steel Long Shanks

- Long shank less flexible blade

### Camel Back Wood Handle

No.	Size	Shank
CF736B	14"x4"	11-5/8"
CF737B	16"x4"	13-5/8"
CF738B	18"x4"	15-5/8"
CF739B	20"x4"	15-5/8"
CF740B	20"x5"	15-5/8"
CF741B	22"x4"	15-5/8"
CF745B	24"x4"	15-5/8"
CF746B	24"x5"	15-5/8"

### ProForm® Handle

No.	Size	Shank
CF736BPF	14"x4"	11-5/8"
CF737BPF	16"x4"	13-5/8"
CF738BPF	18"x4"	15-5/8"
CF739BPF	20"x4"	15-5/8"
CF740BPF	20"x5"	15-5/8"
CF741BPF	22"x4"	15-5/8"
CF745BPF	24"x4"	15-5/8"
CF746BPF	24"x5"	15-5/8"

## Swedish Stainless Steel

### Camel Back Wood Handle

No.	Size	Shank
CF325	10"x3"	3"
CF326	12"x3-1/2"	4-3/8"
CF329	14"x3"	6"
CF327	14"x4"	6"
CF330	16"x3"	7-5/8"
CF328	16"x4"	7-5/8"

### ProForm® Handle

No.	Size	Shank
CF325PF	10"x3"	3"
CF326PF	12"x3-1/2"	5-3/8"
CF329PF	14"x3"	6"
CF327PF	14"x4"	6"
CF330PF	16"x3"	7-5/8"
CF328PF	16"x4"	7-5/8"

## Carbon Steel Short Shanks

- Flexible high carbon steel
- Forged aluminum shanks

### Camel Back Wood Handle

No.	Size	Shank
CF435	10"x3"	3"
CF436	12"x3-1/2"	4-3/8"
CF437	14"x4"	6"
CF438	16"x4"	7-5/8"
CF439	18"x5"	9-5/8"
CF440	20"x5"	11-5/8"
CF441	22"x4"	13-5/8"
CF442	24"x4"	13-5/8"
CF445	24"x5"	13-5/8"

### ProForm® Handle

No.	Size	Shank
CF435PF	10"x3"	3"
CF436PF	12"x3-1/2"	4-3/8"
CF437PF	14"x4"	6"
CF438PF	16"x4"	7-5/8"
CF439PF	18"x5"	9-5/8"
CF440PF	20"x5"	11-5/8"
CF441PF	22"x4"	13-5/8"
CF442PF	24"x4"	13-5/8"
CF445PF	24"x5"	13-5/8"

## Carbon Steel Long Shanks

## Long Shanks

### Camel Back Wood Handle

No.	Size	Shank
CF446	14"x4"	11-5/8"
CF447	16"x4"	13-5/8"
CF448	18"x4"	15-5/8"
CF449	20"x4"	15-5/8"
CF450	18"x5"	15-5/8"
CF451	20"x5"	15-5/8"

### ProForm® Handle

No.	Size	Shank
CF446PF	14"x4"	11-5/8"
CF447PF	16"x4"	13-5/8"
CF448PF	18"x4"	15-5/8"
CF449PF	20"x4"	15-5/8"
CF450PF	18"x5"	15-5/8"
CF451PF	20"x5"	15-5/8"



Professional Quality

# Plaster Trowels

## Carbon Steel

### Camel Back Wood Handle

No.	Size
PL425	10-1/2"x4-1/2"
PL451	11"x4-1/2"
PL456	11-1/2"x4-1/2"
PL447	11"x4-3/4"
PL448	11-1/2"x4-3/4"
PL468	12"x5"
PL470	13"x5"

### ProForm® Handle

PL425PF	10-1/2"x4-1/2"
PL451PF	11"x4-1/2"
PL456PF	11-1/2"x4-1/2"
PL447PF	11"x4-3/4"
PL448PF	11-1/2"x4-3/4"
PL468PF	12"x5"
PL470PF	13"x5"

## Carbon Steel

### Round Front Square Back

- Round front leaves less trowel marks
- Square back allows trowel to get close to forms

### Camel Back Handle

No.	Size
CF284	14"x4"
CF285	16"x4"
CF286	18"x4"
CF287	20"x4"
CF288	20"x5"
CF340	22"x4"
CF341	22"x5"
CF342	24"x5"

### ProForm® Handle

CF284PF	14"x4"
CF285PF	16"x4"
CF286PF	18"x4"
CF287PF	20"x4"
CF288PF	20"x5"
CF340PF	22"x4"
CF341PF	22"x5"
CF342PF	24"x5"

## Swedish Stainless Steel

- Made of heat treated swedish stainless steel
- Special alloy will not rust, pit, or stain
- Forged aluminum shanks

### Camel Back Wood Handle

No.	Size
PL525	10-1/2"x4-1/2"
PL551	11"x4-1/2"
PL556	11-1/2"x4-1/2"
PL547	11"x4-3/4"
PL548	11-1/2"x4-3/4"
PL568	12"x5"
PL570	13"x5"

### ProForm® Handle

PL525PF	10-1/2"x4-1/2"
PL551PF	11"x4-1/2"
PL556PF	11-1/2"x4-1/2"
PL547PF	11"x4-3/4"
PL548PF	11-1/2"x4-3/4"
PL568PF	12"x5"
PL570PF	13"x5"

Larger Stainless Steel Trowels See Page 5

## Golden Stainless Steel

- Made of heat treated golden stainless steel
- Special alloy will not rust, pit, or stain
- Forged aluminum shanks

### Camel Back Wood Handle

No.	Size
PL452	10-1/2"x4-1/2"
PL454	11"x4-1/2"
PL455	11"x4-3/4"
PL453	11-1/2"x4-1/2"
PL457	11-1/2"x4-3/4"
PL459	12"x5"
PL460	13"x5"

### ProForm® Handle

PL452PF	10-1/2"x4-1/2"
PL454PF	11"x4-1/2"
PL455PF	11"x4-3/4"
PL453PF	11-1/2"x4-1/2"
PL457PF	11-1/2"x4-3/4"
PL459PF	12"x5"
PL460PF	13"x5"

Larger Golden Stainless Steel Trowels See Page 5

## Chrome (No Burn)

- Extra hard troweling blade for long wear
- Hardened chrome surface great for pool work
- Eliminates burn marks

### Camel Back Handle

No.	Size	Shank
CF490	10"x3"	3-1/2"
CF491	12"x3-1/2"	5-1/2"
CF492	14"x3"	6"
CF493	14"x4"	8"
CF494	16"x3"	9-1/2"
CF495	16"x4"	11-1/2"

### ProForm® Handle

No.	Size	Shank
CF490PF	10"x3"	3-1/2"
CF491PF	12"x3-1/2"	5-1/2"
CF492PF	14"x3"	6"
CF493PF	14"x4"	8"
CF494PF	16"x3"	9-1/2"
CF495PF	16"x4"	11-1/2"

- Exposed rivets for extra strength
- Forged aluminum shanks



## Funny Trowel

Blue steel blade with handle bracket. Ideal for extra reach or finishing under overhangs or obstructions.

No. Size  
CC624F 24"x5"

CC661 Funny trowel bracket

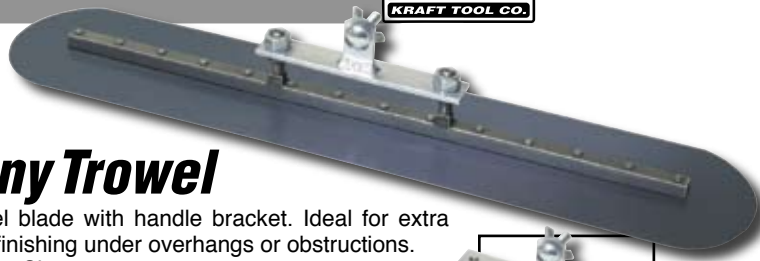

Funny Trowel Bracket



## Mini Pool Trowel



Finish hard to get places wall forms, window sills and small area.

No. Size  
**Straight Wood Handle**  
CF724 7-1/2"x4" **NEW**  
**ProForm® handle**  
CF724PF 7-1/2"x4" **NEW**

## Trowel Bracket

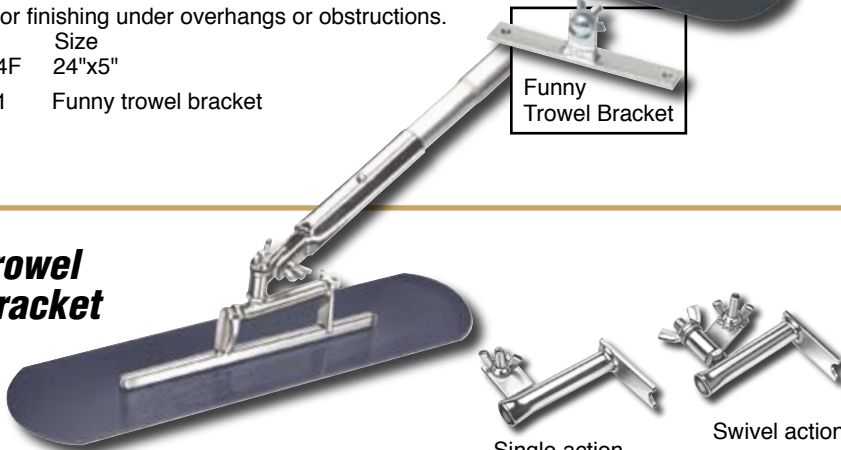

Single action

Swivel action

When used with a standard fresno handle this device turns a normal concrete steel finishing trowel into a small fresno. Just remove handle and add bracket to trowel.  
Fits on all Kraft finishing trowels.

No.  
CC657 Single action bracket  
CC658 Swivel action bracket



## Carbon Steel Pipe Trowel

Finish hard to get places in half the time, with half the effort. The offset handle lets you slip the trowel between pipes: the long nose makes it easy to get behind fixtures.

**Straight Wood Handle**  
No. Size  
PL501 10-1/2"x3"  
**ProForm® handle**  
PL501PF 10-1/2"x3"

Choice of Handle

## Plexi-Plastic Trowels

Plexi-plastic trowel has an aluminum mounting and is made from a special plastic for better wear. It is used on white portland, interior stucco, swimming pools, and on special projects requiring trowels that won't blacken material.

### ROUND END...Camel Back Wood Handle

PL610 10"x3"  
PL612 12"x3-1/2"  
PL614 14"x4"  
PL616 16"x4"  
PL618 18"x4"



### ROUND END...ProForm® Handle

PL610PF 10"x3"  
PL612PF 12"x3-1/2"  
PL614PF 14"x4"  
PL616PF 16"x4"  
PL618PF 18"x4"



### SQUARE END...Camel Back Wood Handle

PL658 11"x4-1/2"

### SQUARE END...ProForm® handle

PL658PF 11"x4-1/2"

## Float & Fresno Brackets

### Button Handle Float Brackets

Quick and easy coupling of 1-3/4" or 1-3/8" button handles. Handle sockets adjust to desired angle.

No.  
CC696 (A) Complete 4-hole bracket  
CC697 (B) Complete 2-hole bracket  
CC698 Button handle socket (only)

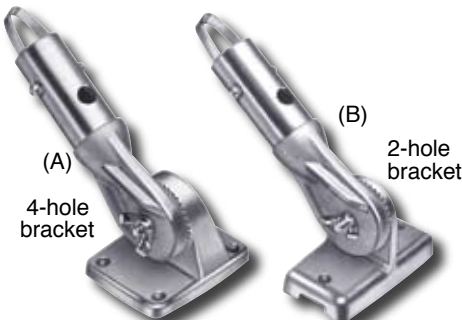

(A) 4-hole bracket

(B) 2-hole bracket

### Threaded Handle Float Brackets

Handle socket fits all 1-1/4", 1-1/2" or 1-3/4" threaded extension handles.

No. (A)  
CC676 Complete 2-hole bracket  
CC678 Handle socket (only)  
CC681 Bracket base (only)

2-hole bracket

Handle socket adjusts to the desired angle

No. (B)  
CC800 Complete 4-hole bracket  
CC678 Handle socket (only)  
CC679 Bracket base (only)

4-hole bracket



### (A) Fresno or Broom Bracket

Attach to single action fresno or broom to lock the handle at the best angle. Use with 1-3/4" and 1-1/4" threaded handles.

No.  
CC665

### (B) Button Fresno / Broom Bracket

Attach to single action fresno or broom to lock the handle at the best angle. Use with 1-3/4" and 1-3/8" button handles.

No.  
CC666

## Knucklehead® II Bull Float Bracket

*New and Improved design!*

**Lighter design helps to eliminate concrete build up!**

US PATENT #4,335,485

**"The Original"**



No. CC296 Knucklehead® II brkt

*Fits all 2 or 4 hole metal bull floats. No adapter needed.*

- Made of rugged lightweight aluminum
- One to one turning ratio of handle and pitch of blade
- Protected grease reservoir for longer wear
- Turning handle eliminates bending and lifting

Fits 1-3/4" or 1-3/8" button handles

**Knucklehead® II Rebuild Kit**  
Includes plastic bushing and snap rings.  
No. CC296K

## Bronco™ Tilt

Patent #4,856,932

- Made of rugged lightweight aluminum
- Pitch of blade controlled by turning handle
- Eliminates bending and lifting
- Designed to fit all 2 or 4 hole metal bull floats
- No adapter needed

No. CC280



## Converter Plate

Converter must be used with EZY-Tilt® (CC290) when mounting to a 4 hole metal bull float.  
No. CC287



See page 15 for the "Big D" Bull Float

## Double Tilt Action.... Button Handle Float Brackets

### EZY-Tilt® II

- Made of rugged lightweight aluminum
- One to one turning ratio of handle and pitch of blade
- Eliminates bending and lifting
- Designed to fit all (2) or (4) hole metal bull floats

No. CC294

- Pitch of blade controlled by turning handle.
- Eliminates bending, lifting.
- Quick easy coupling for either 1-3/4" or 1-3/8" button handles.

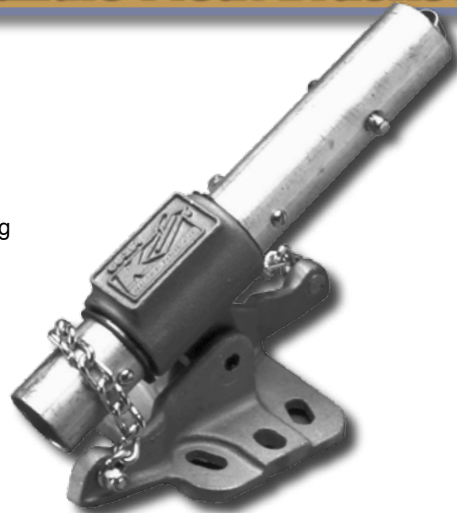

**All Double Action Tilt Brackets... accept handles inside or out.**

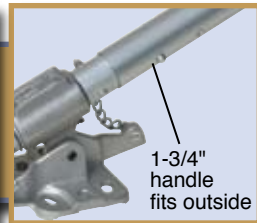
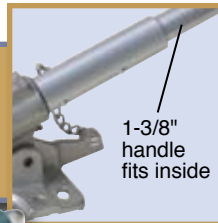

## Orbit-er™ Tilt Bracket

- Quick & easy turning action
  - Pitch of float blade controlled by turning handle
  - Use 1-3/8 or 1-3/4 button extension handles
  - Fits ALL 2 or 4 hole floats
- No. CC270\*



### EZY-Tilt®

- Made of rugged lightweight aluminum
- Pitch of blade controlled by turning handle
- Eliminates bending and lifting
- Fits only 2 hole metal bull floats
- Converter plate (CC287) required when mounting to 4 hole metal bull float.

No. CC290

### Fresnos Weight

Fits snugly over the 1/2" bar on your fresno and most bull floats. At 5 lbs., this weight can achieve just the right amount of blade tension.

No. CC911 (Each) Iron

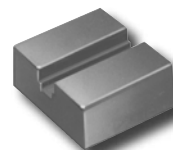

**CAUTION:** Metal Extension Handles / Adapters should not be used near electrical wiring.

\*See page 130



# Threaded Extension Handles

## Magnesium Threaded

**Lightest Handle**

6 Sizes!

30% lighter than aluminum!

Magnesium prevents hands from turning black caused by oxidation!

## 1-3/4" Diam.

No.	Size
CC224	4'
CC225	5'
CC226	6'
CC227	8'
CC228	10'
CC229	12'



- Threaded handles are lightweight, extra strong
- Magnesium does not turn hands black from oxidation
- Fits bull float/fresno threaded brackets and can be combined with 1-3/4" float handles made by other manufacturers
- Molded thread plugs in each end join handles together

## 1-3/4" Diam. Aluminum Threaded Button Handle Adapters

- Adapters allow finisher to use lightweight button handles with threaded type bracket assemblies
- Also can be used to adapt other bracket and handle connections

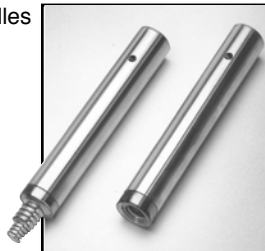

No.	
CC286	(Male)
CC285	(Female)

### Clevis Adapter

- Clevis Adapter 1-3/4"
  - Adapts clevis style tools to 1-3/4" snap style handles
- No.  
CC284



## Aluminum Threaded

## 1-3/4" or 1-1/4" Diam.

1-3/4" Diam.		1-1/4" Diam.	
No.	Size	No.	Size
CC236	6'	CC668	4'
CC238	8'	CC670	6'
CC239	10'		

- Molded thread plugs in each end join handles together
- Fits bull float/fresno threaded brackets and can be combined with 1-3/4" float handles made by other manufacturers

## Fiberglass Threaded

## Fiberglass Button

## 1-1/2" Diam. Fiberglass

### Threaded Handles

No.	Size
CC672	6' Handle

### Button Handles

CC674	6' Handle
CC675	Adapter - enables button fiberglass handle to attach to EZY-Tilt® Bracket

1-1/2" Diameter fiberglass threaded handle for use with bull floats and brackets. Don't take unnecessary chances...always use fiberglass handles around electrical power lines.



## Handle Cleaning Brush

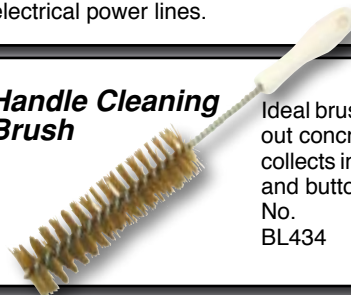

Ideal brush for cleaning out concrete that collects inside threaded and button handles.  
No.  
BL434 15" Length

CAUTION: Metal Extension Handles / Adapters should not be used near electrical wiring.

# Button Extension Handles



**Aluminum Button**

Silver anodized

Blue anodized

**NEW**

Red anodized

## 1-3/4" Diam.

No.	Size	Swaged Handle
CC289S	6'	Swaged Handle - Silver anodized
CC293S	8'	Swaged Handle - Silver anodized <b>NEW</b>
CC291S	10'	Swaged Handle - Silver anodized <b>NEW</b>
CC289SB	6'	Swaged Handle - Blue anodized
CC293SB	8'	Swaged Handle - Blue anodized
CC291SB	10'	Swaged Handle - Blue anodized
CC289SR	6'	Swaged Handle - Red anodized <b>NEW</b>
CC293SR	8'	Swaged Handle - Red anodized <b>NEW</b>
CC291SR	10'	Swaged Handle - Red anodized <b>NEW</b>
CC289-01		Double button clip

Swaged handles are *aluminum anodized*... prevents hands from turning black caused by oxidation!

### Aluminum Button Handles w/ Insert

Lightweight aluminum button handles for use with Kraft Double Tilt Action float brackets. Available either swaged or with insert.

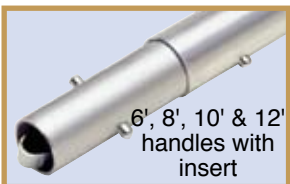

No.	Size
CC289	6' Handle with insert
CC293	8' Handle with insert
CC291	10' Handle with insert
CC292	12' Handle with insert
CC289-01	Double button clip
CC289-02	Insert w/ button clip

## 1-3/8" Button Handle Style Adapters

(A) This adapter is for use with western type long handled tools. It is used with walking edgers, walking groovers, longhandled trowels, fresnos, and other tools with post type or angle connectors.

No.	Size
CC332	8" Long
CC332L	12" Long

(B) This adapter converts western style handle trowels, fresnos, walking edgers, long handle groovers and brooms for use with threaded handles.

No.	Size
CC335	Prong & Female
CC337	Prong & Male

(C) This adapter can be used with CC336 button handles and other similar handles. It is used to convert threaded float brackets for use with button handles.

No.	Size
CC333	Female
CC334	Male

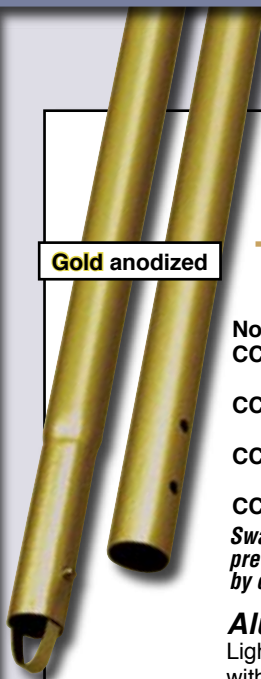
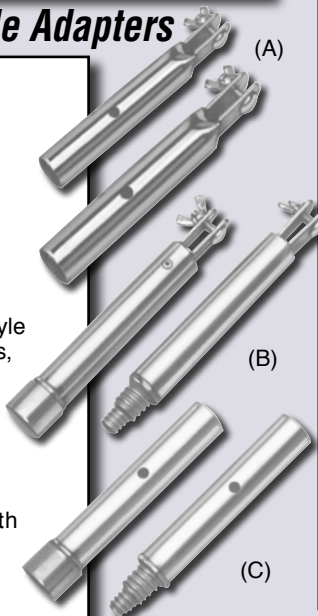

Gold anodized

## 1-3/4" Diam.

Swaged Handle

**GOLD STANDARD™**  
**Aluminum BUTTON**

No.	Size
CC289SG	6' Swaged Handle - Gold anodized
CC293SG	8' Swaged Handle - Gold anodized
CC291SG	10' Swaged Handle - Gold anodized
CC289-01	Double button clip

Swaged handles are *aluminum anodized*... prevents hands from turning black caused by oxidation!

### Aluminum Button Handles

Lightweight aluminum button handles for use with all Kraft double action tilt brackets.

## 1-3/8" Diam.

**Aluminum Button**



Silver anodized

Blue anodized

### Aluminum Button Handles

- 6' long by 1-3/8" diameter
- Popular western style
- Handles can be adapted for use on bull floats, fresnos, and all long handle type construction tools
- Swaged ends nest and snap together with spring lock buttons

Swaged handles are *aluminum anodized*... prevents hands from turning black caused by oxidation!

No.	Size
CC336	6' Swaged Handle - Silver anodized
CC331	8' Swaged Handle - Silver anodized
CC336-01	Single button clip

### Blue Button Handles

No.	Size
CC336B	6'(Blue)Swaged Handle - Blue anodized
CC331B	8' (Blue) Swaged Handle - Blue anodized

CAUTION: Metal Extension Handles / Adapters should not be used near electrical wiring.

# Bull Floats

**GENUINE** EXTRU-LITE™  
**MAGNESIUM**

- Lightweight and longer lasting than aluminum alloy
- Float blade is "broken-in", curved and balanced to prevent digging
- Use with threaded handles. Floats will accept any 4-hole adjustable tilting handle bracket
- Complete with 4 hole bracket assembly (CC800)

## Square End

No.	Size
CC735	36"x8"
CC801	42"x8"
CC745	45"x8"
CC802	48"x8"
CC754	54"x8"
CC760	60"x8"
CC802NP	48"x8" (NO PAINT)

Add "01" after part number for float less bracket

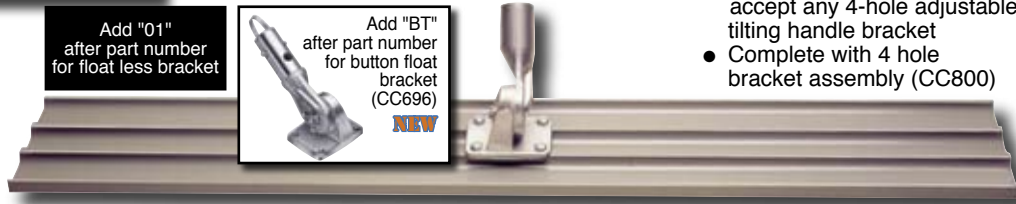

**Square End**

## Round End

No.	Size
CC736	36"x8"
CC742	42"x8"
CC803	48"x8"
CC804	60"x8"
CC808	72"x8"

**Multi-Ribbed for Extra Strength!**



Add "01" after part number for float less bracket

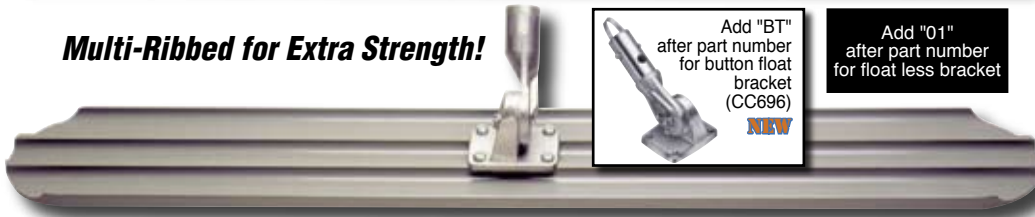

**Round End**

## Aluminum

**Bull Floats (4-Hole Bracket)**

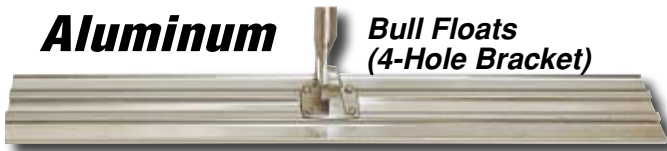

- Multi-ribbed for extra strength
- Lightweight but strong; engineered for proper balance and long wear
- Complete with 4 hole bracket assembly
- Use with threaded handles

No.	Size
CC771	42"x7-1/4"
CC773	48"x7-1/4"

Add "01" after part number for float less bracket



**GENUINE** EXTRU-LITE™  
**MAGNESIUM**

**Bull Floats (2-Hole Bracket)**

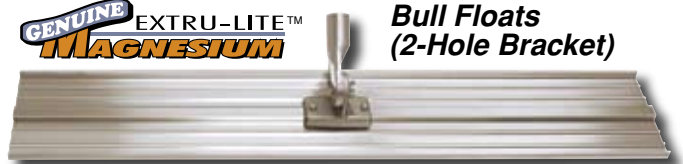

- Multi-ribbed top extra strength
- Provides a smooth finish on all concrete jobs
- Complete with 2 hole bracket assembly. Use with threaded handles.

No.	Size
CC805	42"x8"
CC806	48"x8"
CC807	60"x8"

Add "01" after part number for float less bracket



## Laminated Wood

**Bull Floats (4-Hole Bracket)**

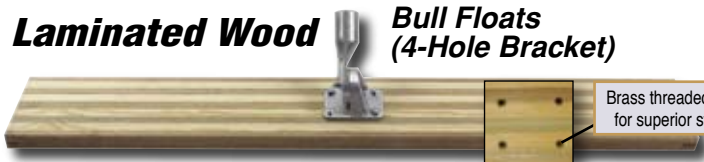

- Long lasting, laminated float with bracket
- 1-3/4" thick; with stiffener embedded in ends of float
- Complete with 4 hole bracket or EZY-Tilt® II Bracket

No.	Size
CC781	36"x7-1/4"
CC782	48"x7-1/4"
CC783	60"x7-1/4"
CC784	48"x7-1/4" (With EZY-Tilt® II Bracket)

Add "01" after part number for float less bracket



## Cali Mahogany Bull Float (with "H" Bracket)



- Made of Asian Mahogany wood
- Float 7-1/4" wide by 3/4" thick
- Handle bracket will accept either (CC295) Fresno/Broom adapter for 1-3/4" diameter button handles, (CC332) adapter for 1-3/8" diameter button handles or (CC662) Fresno Trowel adapter for threaded handles
- Float can also be fitted with a 5 or 6 foot clevis wood handle

No.	Size
CC982	24"x7-1/4"
CC983	36"x7-1/4"
CC984	48"x7-1/4"

## Laminated Wood (with "H" Bracket)



- 1-3/4" thick; with stiffener embedded in ends of float
- Handle bracket will accept either (CC295) Fresno/Broom adapter for 1-3/4" diameter button handles or (CC332) adapter for 1-3/8" diameter button handles or (CC662) Fresno Trowel adapter for threaded handles
- Float can also be fitted with a 5 or 6 foot clevis wood handle

No.	Size
CC782H	48"x7-1/4"

## Bronze Bull Float Groover Bits

Attaches with two thumbscrews. Use bull float as groover. Mount as many groovers as needed. Works on 8" wide bull floats.

No.	Bit Depth	Radius	Width
CC940	3/4"	1/4"	1/2"
CC941	1"	1/4"	1/2"
CC942	1-1/2"	1/4"	1/2"
CC943	2"	1/4"	1/2"

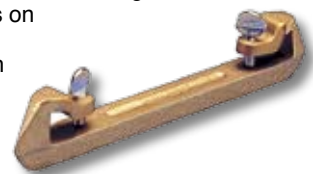

**CAUTION:** Metal extension handles should not be used near electrical wiring.

# BIG "D" BULL FLOATS

- Carbon blue steel blade with rounded ends for producing a super smooth finish
- Heavy-duty 4" C-Channel design for extra rigidity and flatness
- Fitted with Kraft EZY-Tilt® II bracket. Use button handle (1 3/8" or 1 3/4")
- 4 sizes to choose from

Available in 4 sizes

No.	Size
CC748	36"x12"
CC750	48"x12"
CC749	60"x12"
CC751	72"x12"

Add "01" after part number for float less bracket

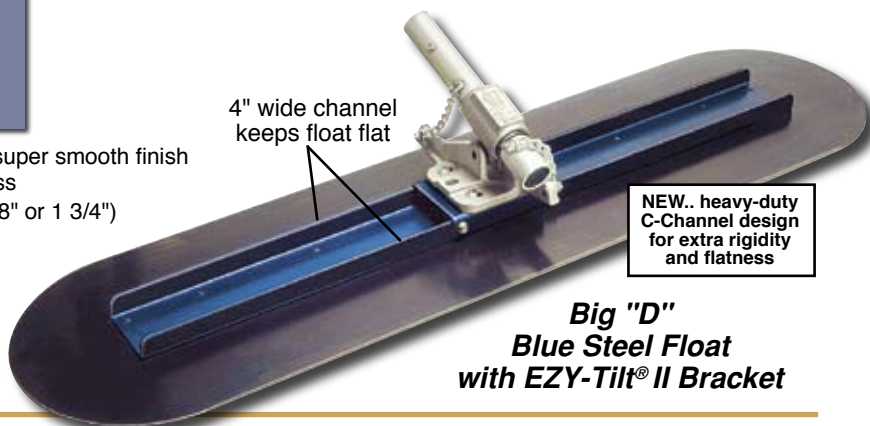

4" wide channel keeps float flat

NEW.. heavy-duty C-Channel design for extra rigidity and flatness

**Big "D" Blue Steel Float with EZY-Tilt® II Bracket**

GENUINE EXTRU-LITE™  
**MAGNESIUM**

## CHANNEL FLOATS



Special design improves flatness

Unique design - 5 sizes

Broken-in rounded edges

- Great finishing tool - extra strong
- Ideal for many jobs, flatwork, paving, etc.
- Broken-in rounded edges with EZY-Tilt® II bracket
- 8' and 10' include support braces and bearing collar for easy float adjustment. All with 2" high sides.

Shipping CC050 must ship via truck

No.	Size
CC044	48"x6"
CC045	60"x6"
CC046	72"x6"
CC048	96"x6"
CC050	120"x6"

Add "01" after part number for float less bracket

Includes (1) 8' button handle and 4' braces  
Includes (1) 10' button handle and 5' braces

## Dual Edge Channel Float

- Rounded front edge for floating
- Square 90 degree back edge for finishing
- Great tool for finishing floors requiring high "F" numbers

No.	Size
CC044SR	48" Dual Edge Channel Flt w/Knucklehead® II Bracket
CC045SR	60" Dual Edge Channel Flt w/Knucklehead® II Bracket
CC046SR	72" Dual Edge Channel Flt w/Knucklehead® II Bracket
CC048SR	96" Dual Edge Channel Flt w/Knucklehead® II Bracket Includes (1) 8' button handle and 4' braces
CC050SR	120" Dual Edge Channel Flt w/Knucklehead® II Bracket Includes (1) 10' button handle and 5' braces

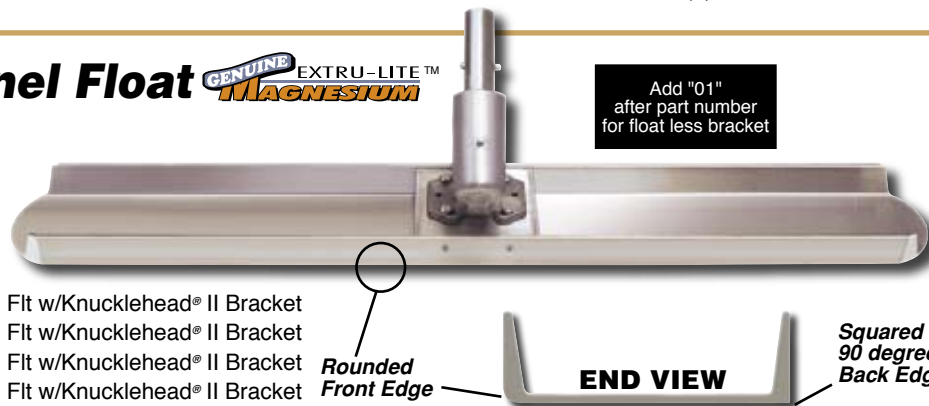

Add "01" after part number for float less bracket

Rounded Front Edge

END VIEW

Squared 90 degree Back Edge

Adjustable braces included with 8' and 10' floats.

## Cast Magnesium Bull Floats

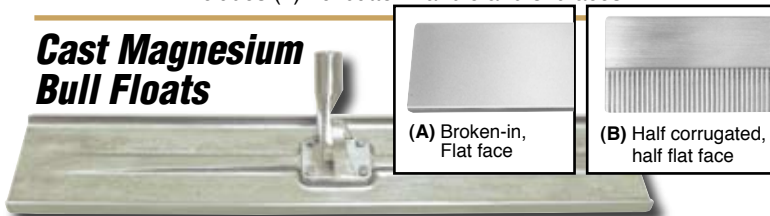

(A) Broken-in, Flat face

(B) Half corrugated, half flat face

(A) Cast magnesium bull float with **flat face** and raised edges. Complete with 4 hole bracket assembly. Use with threaded handles.

No.	Size
CC352	42"x8"
CC358	48"x8"

Add "01" after part number for float less bracket

(B) Cast magnesium bull float with **half corrugated**, half flat face. Corrugations on 3/8" centers, 1/8" penetration. Complete with (4) hole bracket assembly. Use with threaded handles.

No.	Size
CC338	38"x7-1/4"
CC340	40"x7-1/4"

## Laminated Canvas-Resin BULL FLOAT



4" wide channel keeps float flat

- Long wearing 3/8" thick canvas-resin float
- Rounded ends and broken in shape
- Heavy-duty (.125 gauge) 4" C-Channel for extra rigidity
- Fitted with our exclusive EZY-Tilt® II (CC294) handle bracket

No.	Size
CC785	48"x7"

Add "01" after part number for float less bracket

CAUTION: Metal extension handles should not be used near electrical wiring.

# Fresnos



Available in Carbon or Blue Steel



## All-Angle Steel Fresno Trowels

- Made of high quality tempered steel for a perfect finish
- 360 degree all-angle bracket lets you work at any angle
- Available in round or square end
- Use fresno adapters for handle attachment
- Attach bronze fresno groover attachment for grooving

Round End No.	Size	Square End No.
CC849	24"x5"	CC906
CC850	30"x5"	CC907
CC851	36"x5"	CC908
CC852	42"x5"	CC909
CC853	48"x5"	CC910

Add "B" after part number for blue steel fresnos

## Fresno Trowel with Adjustable Tooth Bracket

Available in Carbon or Blue Steel

Round End No.	Size	Square End No.
CC820	24"x5"	CC825
CC821	30"x5"	CC826
CC822	36"x5"	CC827
CC823	42"x5"	CC828
CC824	48"x5"	CC829

Add "B" after part number for blue steel fresnos



Add "BT" after part number for button float bracket (CC666)



- Made of high quality tempered steel for a perfect finish
- Unique design bracket has teeth to keep handle at set angle without slippage
- Use with threaded handles or add "BT" for use with snap handle

## Fresno Trowels with Swivel Bracket

Available in Carbon or Blue Steel



- Made of high quality tempered steel with square steel mounting
- 360 degree all-angle bracket lets you work at any angle
- Round end fresno eliminates marking or gouging slabs
- Bracket to be used with clevis handles. Fresno handle adapters and fresno groover attachments also available

Round End No.	Size	Square End No.
CC618	18"x5"	CC518
CC624	24"x5"	CC524
CC630	30"x5"	CC530
CC636	36"x5"	CC536
CC642	42"x5"	CC542
CC648	48"x5"	CC548

Add "B" after part number for blue steel fresnos

CC551...Replacement swivel bracket

## Fresno Trowels with EZY-Tilt® Bracket

(EZY-Tilt® Bracket (CC290) fits this fresno ONLY)

### 5 SIZES

- Quality tempered steel blade with square steel mounting
- EZY-Tilt® bracket eliminates bending and lifting...Controls blade pitch with turn of handle
- Bracket features quick and easy coupling for either 1-3/4" button handle or 1-3/8" button handle

No.	Size
CC830	24"x5"
CC831	30"x5"
CC832	36"x5"
CC833	42"x5"
CC834	48"x5"

Available in Round End Carbon or Blue Steel

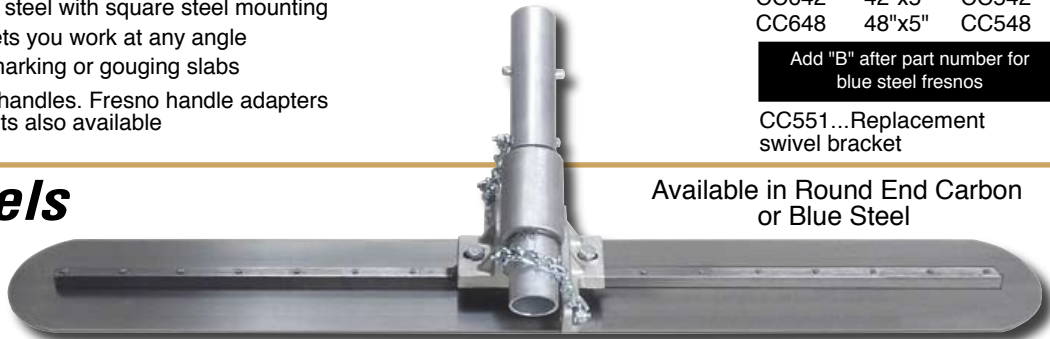

Add "B" after part number for blue steel fresnos

(Add "01" to stock number for Fresno w/o EZY-Tilt® bracket.)

CAUTION: Metal extension handles should not be used near electrical wiring.

## Bronze Fresno Trowel Groover Bits

Change your fresno into a long-handled groover by simply turning the two thumbscrews. Use more than one to make parallel grooves. 1/4" radius. Fits 5" wide fresnos.

No.	Bit Depth
CC622	1/4"
CC623	1/2"
CC625	3/4"
CC626	1"

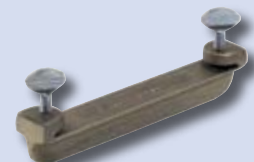



# Multi-Trac BULL FLOAT GROOVER

GENUINE EXTRU-LITE™  
MAGNESIUM

**Cuts Perfect Grooves Everytime!**

Ideal for: MADE IN U.S.A.

- Streets ● Highways ● Off Ramps
- Approach Ramps ● Safety Ramps ● Bridges

Produces a uniform sharp groove in various concrete applications where water drainage and traction are critical.

**Magnesium Floats include Knucklehead® II bracket.**

PART NO.	SIZE	SPACING	PART NO.	SIZE	SPACING
CC787	48" x 8" Float	1/2"	CC793	48" x 8" Float	2-1/4"
CC788	36" x 8" Float	1/2"	CC794	36" x 8" Float	2-1/4"
CC789	24" x 8" Float	1/2"	CC795	24" x 8" Float	2-1/4"
CC790	48" x 8" Float	3/4"	CC796	48" x 8" Float	1"
CC791	36" x 8" Float	3/4"	CC797	36" x 8" Float	1"
CC792	24" x 8" Float	3/4"	CC798	24" x 8" Float	1"



*Cuts clean, sharp grooves every time!*

**ALL FLOATS...groove depth and width (1/4"x1/4")**

**ADD (01) to Part No. for float less bracket**

Use with any Kraft Double Tilt Action float bracket



## Stainless Steel MULTI-TRAC FRESNO



**Cuts Perfect Grooves Everytime!**

- Cuts clean sharp safety grooves
- Grooves are 1/4" wide by 1/4" deep
- Fitted with a threaded tilting handle bracket

No.	Groove Spacing	No.	Groove Spacing	No.	Groove Spacing
<b>24"x5"</b>		<b>36"x5"</b>		<b>48"x5"</b>	
CC874	1-1/2"	CC877	1-1/2"	CC888	1-1/2"
CC875	3/4"	CC878	3/4"	CC889	3/4"
CC876	1"	CC880	1"	CC890	1"

## Round End Fresno w/ Edger

- Finish and edge in one pass
- Carbon steel blade with 1/2" radius
- Great tool for sidewalks and decorative concrete

No.	Size	No.	Size
CC618FE	18"x5" 1/2" R	CC636FE	36"x5" 1/2" R
CC624FE	24"x5" 1/2" R	CC642FE	42"x5" 1/2" R
CC630FE	30"x5" 1/2" R	CC648FE	48"x5" 1/2" R

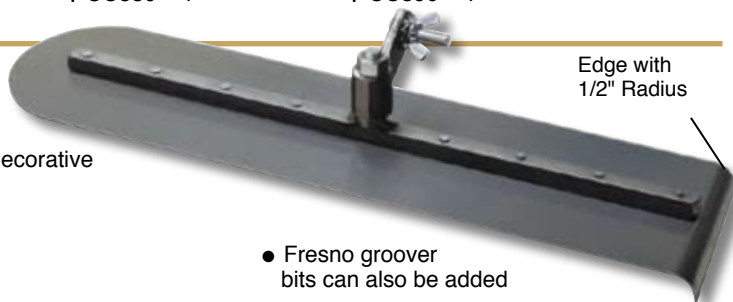

Edge with 1/2" Radius

- Fresno groover bits can also be added

### Fresno Bracket

360 degree all-angle bracket  
No.  
CC298 Bracket (complete)  
CC288 Top half (only)  
CC300 Bottom half (only)



Hardware not included

### EZY-Tilt® Fresno/Broom Adapter

Accepts 1-3/8" and 1-3/4" diam. button handles to fit fresnos, brooms, walking edgers and groovers.  
No. CC295



### Center Line Groover

Groover is adjustable on any 5" wide fresno. Leaves a clear, fine line in concrete. Slide groover to proper position and tighten. Fresno not included. Great for decorative concrete applications.

No. Size  
CC013\* 1/4"



### Fresno Trowel Adapter

Adapts 1 3/4" molded threaded handles to fit fresnos, brooms, walking edgers and groovers.  
No. CC662



**CAUTION:** Metal extension handles should not be used near electrical wiring.

\*See page 130

# Contractor's Choice Mag Float

**GENUINE**  
**MAGNESIUM**  
EXTRU-LITE™

Superb Floating Action

- ✓ Tough durable Extru-Lite Magnesium™ blade
- ✓ Float ends are beveled and the blade is "broken-in" with rounded corners
- ✓ Precise handle position gives perfect balance

Blade "broken-in" with beveled ends



Soft textured ProForm® Handle with special ribbing for that "Great Grip"  
ProForm® Float Handle  
(Patent '6,473,939 B1)  
(Patent '6,821,468 B2)



**Square Ends**

## Mag Float

### Mag Float with ProForm® Handle

No.	Size
CF012PF	12"x3-1/4"
CF014PF	14"x3-1/4"
CF016PF	16"x3-1/4"
CF018PF	18"x3-1/4"
CF020PF	20"x3-1/4"

### Mag Float with wood handle

No.	Size
<b>with standard wood handle</b>	
CF012	12"x3-1/4"
CF014	14"x3-1/4"
CF016	16"x3-1/4"
CF016NP	16"x3-1/4" (no paint)
CF018	18"x3-1/4"
CF020	20"x3-1/4"
CF024	24"x3-1/4"

### with high lift wood handle

CF012M	12"x3-1/4"
CF014M	14"x3-1/4"
CF016M	16"x3-1/4"

## Replacement ProForm® Handles



ProForm® Float Handle  
No. CF266

ProForm® Float Handle W/O Holes  
CF267

CF266CB - 10" Mag-150™ & Thin Line Float  
ProForm® Replacement Handle

ProForm® Float Handle  
(Patent '6,473,939 B1)  
(Patent '6,821,468 B2)

**Rounded Ends**

## Mag Float (Rounded Ends)

### with ProForm® handle

No.	Size
CF076PF	16"x3-1/4"

### with high lift wood handle

No.	Size
CF076	16"x3-1/4"

**Rounded Front & Square Back**

## Mag Float (Rounded Front & Square Back)

### with ProForm® handle

No.	Size
CF078PF	16"x3-1/4"

### with standard wood handle

No.	Size
CF078	16"x3-1/4"

## Replacement Wood Handles

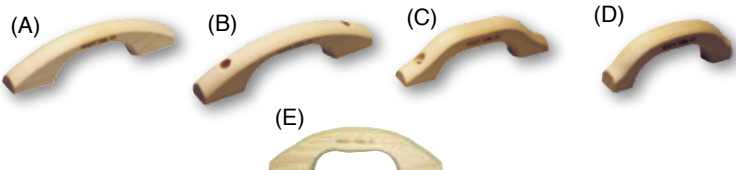

(A) 10" Wood Float Handle  
CF261

(B) 10" Wood Drilled Countersunk Handle  
CF262

(C) 10" Wood High Lift Float Handle  
CF050

(D) Fits only rubber floats...Page 95  
Your choice...wood or plastic handle  
7-1/4" Wood Float Handle  
CF263

7-1/4" Plastic Float Handle  
CF263P (Not Shown)

(E) CF265 - 10" Wood Replacement  
Handle with larger diameter

## Thin Line Pro Mag Float w/ Large Diameter Handle

Cast Magnesium



Blade "broken-in" with beveled ends

with ProForm® handle  
 No. Size  
 CF064PF 16"x3-1/8"  
 CF077PF 20"x3-1/8"

with standard wood handle  
 No. Size  
 CF064 16"x3-1/8"  
 CF077 20"x3-1/8"

### COMPARE BLADES

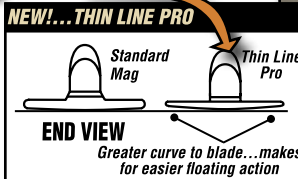

CF266CB - 10" Thin Line ProForm® Replacement Handle

CF265 - 10" Wood Replacement Handle

- Tough durable cast magnesium blade
- Precise handle position provides a perfect balance
- Thin edges and smooth rounded corners gives this float that perfect "broken-in" feel
- Float design allows for greater knuckle clearance

## MAG-150™

Cast Magnesium

Extra Wide Blade with NEW Wider Diameter Handle



Blade "broken-in" with beveled ends

- Great broken in feel with perfect radius
- NEW larger diameter wood handle for improved user control
- Also available with Proform® soft grip handle

No. Size  
 CF150 - Wood handle 16"x3-1/2"  
 CF150PF - Proform handle 16"x3-1/2"



CF265 - 10" Wood Replacement Handle

CF266CB - 10" Mag-150™ ProForm® Replacement Handle

## Wide Mag Float

GENUINE EXTRU-LITE™ MAGNESIUM



Blade "broken-in" with beveled ends

with ProForm® handle  
 No. Size  
 CF015PF 16"x3-1/2"

No. Size  
 with standard wood handle  
 CF015 16"x3-1/2"  
 with high lift wood handle  
 CF015M 16"x3-1/2"

- Tough durable 3-1/2" wide Extru-Lite Magnesium™ blade
- Precise handle position gives the float perfect balance and superb floating action
- Beveled edges and smooth rounded corners gives this float that perfect "broken-in" feel

## "The Original" Sand Cast Mag Float

40 year old



- Tough durable long wearing sand cast magnesium
- Made the same as it was forty years ago
- Precise handle position gives the float perfect balance and superb floating action
- Corners rounded and both ends beveled

No. Size  
 CF066 16"x3-1/4" (With high lift handle)

Blade "broken-in" with beveled ends

# Wood Hand Floats



## Beveled Redwood Float

Made of the best top quality clear heart redwood. The float face is beveled to make it possible to work in the tightest quarters.

No.	Size
CF256	15"x3-1/2"
CF257	18"x3-1/2"

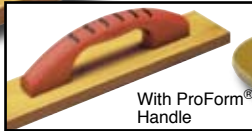

With ProForm® Handle

## Bodark Wood Float

Bodark floats outlast ordinary floats. Handle is bonded to the blade. Popular with many finishers.

Wood Handle	ProForm® Handle		
No.	Size	No.	Size
CF642	16"x2-1/4"	CF642PF	
CF643	16"x3"	CF643PF	
CF644	20"x3"	CF644PF	



## Teakwood Float

Very hard, long wearing 5/8" thick float. Comes with 10" float handle.

No.	Size
CF269	18"x3-1/4"

## Cast Magnesium Drain Float

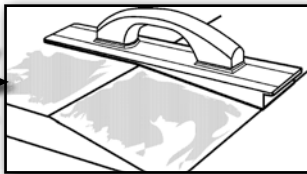

Float designed to provide an 8" or 12" bevel in front of overhead doors for water drainage. Blade measures 16"x3-1/4".

No.	Size
CF066H-8	8" bevel
CF066H-12	12" bevel

US Patent #  
6,183,237

Beveled to allow finisher to use around floor drains and other areas where water drainage or run off is essential. "Broken-in" blade is hand ground.

5/8" Wide lip  
1/2" Deep lip

No.	Size
CF066H-D <b>NEW</b>	16"x3-1/4" Long

## Redwood Float

Best top quality clear heart redwood floats with comfortable handles. Lightweight, a pleasure to work with. You'll have many uses for these two popular sizes.

No.	Size
CF251	12"x5"
CF252	15"x5"



## Laminated Canvas-Resin Float

Wears like magnesium for extremely long wear. Laminated canvas-resin is 3/8" thick with broken-in face. Ready to use.

### ROUND ENDS

Wood	ProForm®		
No.	Size	No.	Size
CF501	16"x3-1/2"	CF501PF	
CF502	18"x3-1/2"	CF502PF	
CF524	20"x3-1/2"	CF524PF	

### SQUARE ENDS

Wood	ProForm®		
No.	Size	No.	Size
CF503	12"x3-1/2"	CF503PF	
CF504	14"x3-1/2"	CF504PF	
CF505	16"x3-1/2"	CF505PF	
CF506	18"x3-1/2"	CF506PF	
CF507	20"x3-1/2"	CF507PF	



With ProForm® Handle



With ProForm® Handle

## Laminated Canvas-Resin Darby

Same as our other floats. Long wearing canvas-resin 3/8" thick; has rounded corners and broken in shape. Ready to use. Perfect tool for curb and gutter forming.

No.	Size
CF037	40"x3-1/2" Straight darby



## Float Hook

Float hook clips to belt. Holds hand floats and other tools.

No.	Item
CF011	Float hook



## Cast Magnesium Beveler Floats

US Patent #  
6,183,237

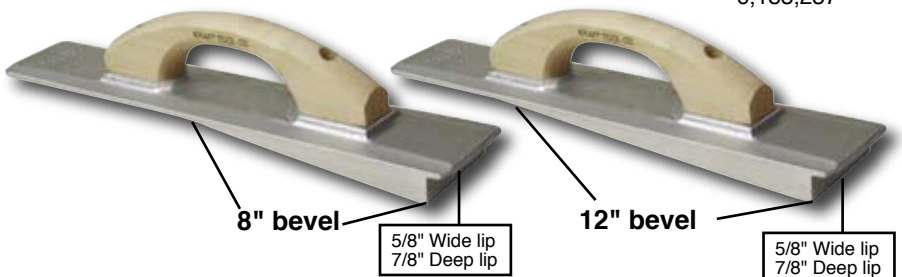

8" bevel

5/8" Wide lip  
7/8" Deep lip

12" bevel

5/8" Wide lip  
7/8" Deep lip

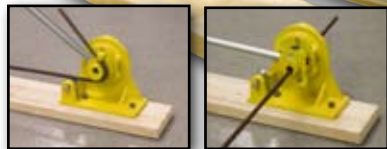
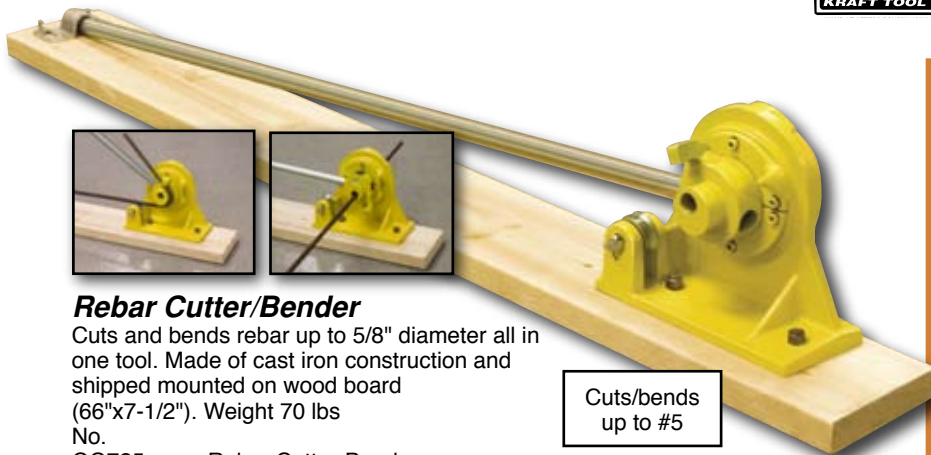

**Rebar Cutter/Bender**

Cuts and bends rebar up to 5/8" diameter all in one tool. Made of cast iron construction and shipped mounted on wood board (66"x7-1/2"). Weight 70 lbs

- No.  
 GG725 Rebar Cutter-Bender  
 GG726 Replacement Jaws (1 pr)  
 GG725-01 54" Metal replacement handle

Cuts/bends up to #5

**"Big John" & "Little John"**

**All Steel Heavy-Duty Pry Bars**

Ideal all purpose tool for prying forms and other construction jobs. Specially designed 3" wide blade angle and hardened steel claw make for easy prying.

- No.  
 "Big John" H.D. Pry Bar  
 GG630 56" Length  
 14 lbs.  
 "Little John" Pry Bar  
 GG631 46" Length  
 7 lbs.

**Two Sizes!**

**"Little John" Pry Bar**

**Strong Tubular Handles!**

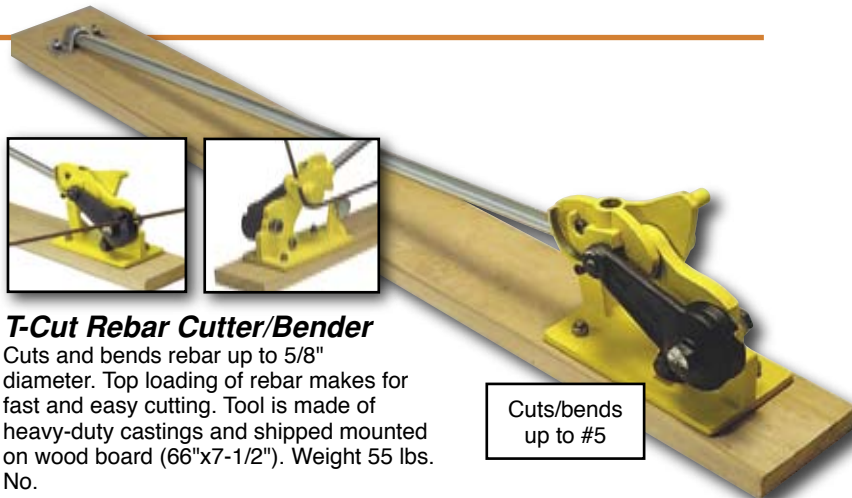

**T-Cut Rebar Cutter/Bender**

Cuts and bends rebar up to 5/8" diameter. Top loading of rebar makes for fast and easy cutting. Tool is made of heavy-duty castings and shipped mounted on wood board (66"x7-1/2"). Weight 55 lbs.

- No.  
 GG727 T-Cut Rebar Cutter/Bender  
 GG728-02 Replacement cutter blades, 2 slot, steel (1 pr)  
 GG727-01 48" Metal replacement handle

Cuts/bends up to #5

**Rocker Head Pry Bar**

Extra heavy-duty. Unique rocker head for more power without blocking. Unique push/pull action makes even the toughest job simple. Open claw design works in tight places. Double claw for hard to reach areas.

- No.  
 GG632 30"  
 GG634 48"

**Rebar Bender**

Strong, light, easy and simple to use. Completely portable. Can be used anywhere on the job. 36" length provides enough leverage to bend 5/8", reinforcing bar.

- No.  
 GG629

**Channellock® Ironworker's Pliers**

Wire cutting plier for tying concrete reinforcing bars. Curved end dipped handles. Bevel nose design plus long handles. Hand honed cutting edge. Dipped plastic grips.

- No. Length  
 GG517 9"



**Rebar Lifter/Hook**

Hook provides leverage to lift rebar and wire mesh. Fitted with heavy-duty 60" wood handle.

- No. GG635

**Wire Reel for Tie Wire**

Lightweight but strong. Will not chip, crack or break. Safety yellow plastic. Fits any standard belt.

- No. GG309



**Metal Wire Reel for Tie Wire**

Made of strong lightweight aluminum. Will not chip, crack or break. Easy turn handle. Fits any standard belt.

- No. GG311



**Tie Wire Twister**

Designed to twist wire bar ties with a minimum of effort. Lets you do the job right, quickly and safely. Fitted with wood handle.

- No. GG310

**Tie Wire Twister**

Two or three pulls of the handle turns the hook within its socket, twisting the wire. Designed for rough treatment. Rubber coated 12" ribbed handle for firm grip.\*

- No. GG325\*



\*See page 130

## Darbies



### Mini Bull Float & Darby

Unique T-slotted reinforcing rib (no threads to strip) adds strength and allows threaded bracket to be quickly set off center to work float around obstructions. Two wood float handles can easily slide for adjusting to hand and curb work. This float is also ideal for floating lightweight concrete on roof decks. Use with threaded handles.

No.	Size
CC816	36"x3-1/4"
CC816RE	36"x3-1/4" ROUND END
CC817	42"x3-1/4"
CC818	48"x3-1/4"
CC819	60"x3-1/4"

### Tapered Magnesium Darby



Now Available with ProForm® Handles

The most popular lightweight 30" darby for precision finish work. 3-1/2" wide at the heel, tapered to 2-1/4" at the toe.

Wood Handle		ProForm® Handle
No.	Size	No.
CF030	30"	CF030PF

### Extruded Magnesium Darby with Knob Handle



Now Available with ProForm® Handles

This lightweight magnesium darby has a float type handle and a round knob handle. Unique T-Channel design gives the finisher the option of sliding the handle position to their preference.

Wood Handles		ProForm® Handles
No.	Size	No.
CF032	30"x3-1/4"	CF032PF
CF033	36"x3-1/4"	CF033PF

### Extruded Magnesium Hand & Curb Darby



Now Available with ProForm® Handles

Especially designed for curb work, this lightweight tool comes with one or two float type handles. T-Channel design gives the finisher the option of adjusting handle position to their preference.

With 2 handles Wood Handle		ProForm® Handle
No.	Size	No.
CF041	36"x3-1/4"	CF041PF
CF042	42"x3-1/4"	CF042PF
CF043	48"x3-1/4"	CF043PF

With 1 handle Wood Handle		ProForm® Handle
No.	Size	No.
CF031	30"x3-1/4"	CF031PF
CF036	36"x3-1/4"	CF036PF

### Tapered...Laminated Canvas-Resin Darbies

Same as our other floats. 3/8" thick; has rounded corners and broken in shape.

Ready to use.

No.	Size
CF510	45" Tapered darby (3) hole handle
CF509	30" Tapered darby (1) hole handle

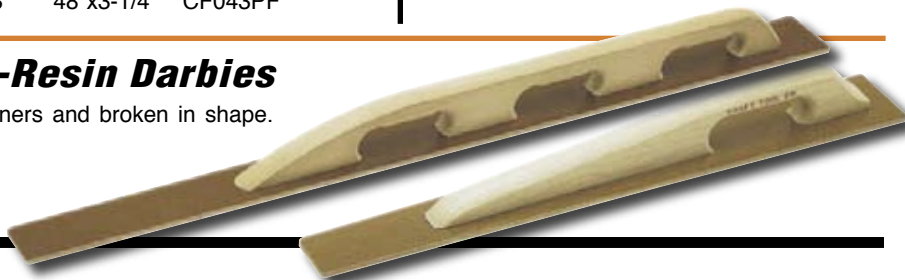



## Tapered Mahogany Darby

Darbies taper from about 3-1/2" at the heel to 2-1/2" at the front

Three sizes designed and made of clear seasoned wood. Finished smooth and comes with either a (1), (2), or (3) hole grip. Very popular with many concrete finishers.

**2 Sizes**  
28" & 36" (A)

**2 Sizes**  
45" & 48" (B)

**1 Size**  
36" (C)

<b>(A)</b>	No.	<b>2 Sizes</b>
	CF236	36" (1) hole grip
	CF258	28" (1) hole grip
	CF254	replacement handle 21" (1) hole

<b>(B)</b>	No.	<b>2 Sizes</b>
	CF259	45" (3) hole grip
	CF255	48" (2) hole grip (Not Tapered)
	CF253	replacement handle 32" (3) hole

<b>(C)</b>	No.	<b>1 Size</b>
	CF237	36" (2) hole grip
	CF237-01	replacement handle (2) hole

## Aussi Combo (Darby/Screed)



10' Must ship via truck

This innovative tool can be used as a float, screed, or check rod when you want just the right finish. Base of tool comes with a round edge for floating and a square edge for cutting and filling. Lightweight magnesium with handles that adjust for comfort.

**3 Sizes...with adjustable handles!**

No.	Size
CC421	4'x1-3/8"x2" (1) Handle
CC422	6'x1-3/8"x2" (1) Handle
CC423	10'x1-3/8"x2" (2) Handle

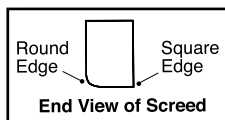

## Buckaroo™ Straightedge

w/ Level Vial Handle

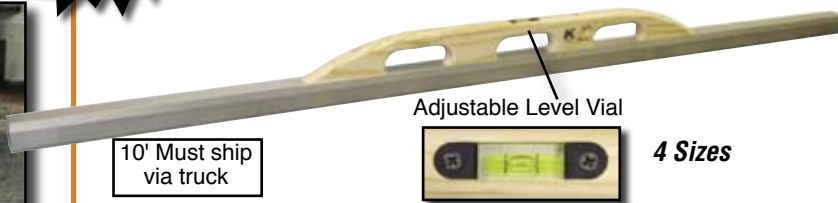

10' Must ship via truck

Adjustable Level Vial

4 Sizes

One man straightedge for floating or striking off concrete. Smooth tapered handle includes top reading adjustable level vial for easy positioning. Base of tool comes with round edge for floating and square edge for cutting. Made from magnesium, very lightweight. Ideal for concrete and landscape construction.

No.	Size	
CC421L	4'x1-3/8"x2"	<b>NEW</b>
CC422L	6'x1-3/8"x2"	<b>NEW</b>
CC428L	8'x1-3/8"x2"	<b>NEW</b>
CC423L	10'x1-3/8"x2"	<b>NEW</b>

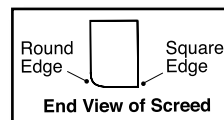

## Whiskey Stick

60" Magnesium blade levels and places concrete fast. Rounded edge for floating and square edge for cutting and filling. Handle tilts to the right floating angle. Fitted with heavy-duty braces and 72" snap button 1-3/8" extension handle.

No.	Size
CC425	60" Magnesium blade

Now Available in Square End or Round End



## Extruded Magnesium Walking Float

This lightweight magnesium float perfect for floating small areas of concrete. Fitted with our 360 degree all-angle bracket; which lets you work at any angle. Unique T-Channel design gives the finisher the option of adjusting handle bracket position to their preference. Bracket fits clevis handles and with adapters will accept button or threaded handles.

No.	Size
CC815	24"x3-1/4" Square Ends
CC814	24"x3-1/4" Round Ends

# Concrete Spreaders

## Right Angle Placer™

- Light and super smooth aluminum handle
- 60 degree blade keeps tool at just the right angle to spread and level concrete
- Heavy-duty aluminum braces for added strength
- Blade measures 19-1/2"x4"
- 1-3/8" diameter handle

No.	Size
CC964	19-1/2" w/o hook
CC965	19-1/2" w/ hook

Packed 5 per bundle

\* Spreaders assembled ship via oversized rate or truck

60 degree angle

## Western Concrete Aluminum Spreader

Available in 30" or 24" Blade

Designed to be used with 1-3/8" snap button handles, as well as wood handles

Handle not included (See below for handles)

### 30" Western Concrete Spreader (Alum.)

Strong, lightweight, long wearing tool spreads and grades concrete. Two metal braces for greater strength. **Handle not included.**

No.	Size
CC930	(w/o Hook) 30"x4-3/4" Head (only)
CC931	(w/ Hook) 30"x4-3/4" Head (only)

### 24" Concrete Spreader (Alum.)

No.	Size
CC923	(w/o Hook) 24"x4-3/4" Head
CC924	(w/ Hook) 24"x4-3/4" Head

### Handles

CC336	6' (1-3/8" Snap Button alum. handle)
CC922	54" Wood handle

## GOLD STANDARD™ Concrete PLACER

- Made of strong lightweight aluminum
- Blade measures 19-1/2" x 4"
- 60" aluminum handle with textured foam grip welded to blade
- Heavy-duty aluminum braces for added strength

\* Spreaders assembled ship via oversized rate or truck

No.	Size
CC944	19-1/2"x4" w/o hook*...assembled
CC945	19-1/2"x4" w/ hook*...assembled
CC944-30	30"x4" w/o hook*...assembled
CC944-30 Must ship via truck	

Packed (5) per bundle

\* Spreaders assembled ship via oversized rate or truck

54" wood jam handle

## Lightweight Concrete Spreader (Aluminum)

- Made of strong lightweight aluminum
- Blade measures 19-1/2" x 4"
- Two heavy-duty aluminum braces for added strength

No.	Size	Packed (5) per carton or (3) per bundle assembled
CC904	19-1/2"x4" w/o hook	
CC905	19-1/2"x4" w/ hook	
CC107	Replacement handle	
CC904A	Spreader Assembled*	
CC905A	Spreader Assembled*	

## Concrete Placer with Fiberglass® Handle

\* Spreaders assembled ship via oversized rate or truck

Packed (5) per bundle

- Made of strong lightweight aluminum
- Blade measures 19-1/2" x 4" w/ heavy-duty bracing
- Fitted with 54" reinforced Fiberglass® handle

No.	Size
CC904AF	19-1/2"x4" w/o hook*...assembled
CC905AF	19-1/2"x4" w/ hook*...assembled



# Concrete Spreaders

#14 Gauge Steel Blade

## **CALI KUMALONG®** Concrete SPREADER

Packed (3) per bundle

- Made of strong heavy-duty lightweight steel
- Blade measures 19-1/2" x 4"
- Comes with 60" heavy-duty pinned wood handle to prevent from spinning
- Double edged blade will double the blade life

\* Spreaders assembled ship via oversized rate or truck

No.	Size
CC917	19-1/2"x4"***assembled

## Concrete Rake Magnesium or Steel



This well-constructed rake is favored by many concrete tradesmen over straight spreaders for its ease in moving concrete. Comes with 54" wood jam handle.

No.	Size	Packed (5) per carton
CC010	22-1/2"x5" Steel	
CC113	19-1/2"x4" Magnesium	
CC114	24"x4" Magnesium	
CC107	Replacement handle	

## Concrete Displacer (Steel)

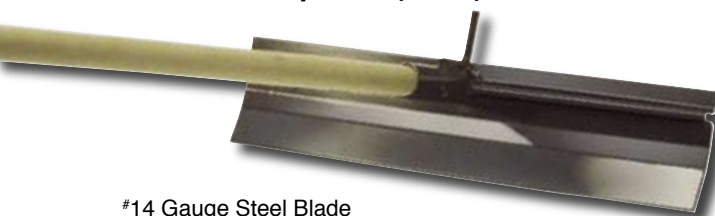

#14 Gauge Steel Blade

Smooths, spreads and grades concrete. Strong reinforced rib construction. 14 gauge steel; 19-1/2"x4"; weighs 3-1/2 lbs; comes with 54" wood jam handle.

No.	Size	Packed (5) per carton
CC019	19-1/2"x4" w/ hook	
CC009	19-1/2"x4" w/o hook	
CC107	Replacement Handle	



#14 Gauge Steel Blade

## Concrete Kumalong® (Steel)

Sturdy, lightweight tool spreads, grades concrete. Made of 14 gauge, cold rolled steel. Comes with 54" wood jam handle.

No.	Size	Packed (5) per carton
CC105	19"x4" w/ hook	
CC106	19"x4" w/o hook	
CC107	Replacement handle	

## HEAVY-DUTY Concrete SPREADER (Steel)

- Made of 12 gauge, cold rolled steel
- Blade measures 20"x5"

60" Heavy-duty shovel type handle

### With 60" Heavy-Duty Wood Handle

No.	Size	Packed (5) per carton or (3) per bundle assembled
CC901	20"x5" w/o hook	
CC902	20"x5" w/ hook	
CC901-02	Repl handle/ferrule no hook	
CC902-02	Repl handle/ferrule with hook	

CC901A	Spreader Assembled*
CC902A	Spreader Assembled*

### With 48" Wood handle

CC901-48	20"x5" w/o hook
CC902-48	20"x5" w/ hook
CC901-04	Repl handle/ferrule no hook
CC902-04	Repl handle/ferrule with hook

CC901A -48	Spreader Assembled*
CC902A -48	Spreader Assembled*



#12 Gauge Steel Blade

## Concrete Spreader (Steel)

- Made of 14 gauge, cold rolled steel
- Blade measures 19-1/2"x5"
- Two metal braces for added strength
- Comes with 54" heavy-duty wood handle

#14 Gauge Steel Blade

No.	Size	Packed (5) per carton or (3) per bundle assembled
CC903	19-1/2"x5" Head	
CC903A	Spreader Assembled	



Packed (5) per carton or (3) per bundle assembled

\* Spreaders assembled ship via oversized rate or truck



Packed 5  
Per Carton

## Floor/Form Scraper

### 6 Sizes!

Cleans and shaves all types of material from concrete and wood surfaces. Great for concrete form cleaning. Fitted with 54" metal handle.

No.	Size
GG013	7" Scraper
GG013-01	7" Repl blade
GG014	14" Scraper
GG014-01	14" Repl blade
GG018	18" Scraper
GG018-01	18" Repl blade
GG022	22" Scraper
GG022-01	22" Repl blade
GG023	36" Scraper
GG023-01	36" Repl blade
GG024	48" Scraper
GG024-01	48" Repl blade

## Heavy-Duty Floor Scrapers

### Floor Scraper

Ideal for after work clean up. Scraper blades are firm but flexible. Comes with heavy-duty 5' shovel type wood handle.

No.	Size
CC214	Floor scraper w/14" blade
CC218	Floor scraper w/18" blade
CC222	Floor scraper w/22" blade

CC207	14" Replacement blade
CC208	18" Replacement blade
CC209	22" Replacement blade
XHDW04	Wood Replacement Handle

Fitted with heavy-duty 5' shovel type wood handle



Heavy-duty all steel scraper with weighted head

### T-Handle Floor Scraper

- 54" long all steel floor scraper
- All steel "T" handle for extra leverage
- Shaves all kinds of floor coverings on any type of floor
- Fitted with 7" replaceable steel blade

No.	Size
GG393	Floor scraper w/7" blade
GG394	7" Replacement blade
GG395	10" Replacement blade

## Flat Wire Texture Broom

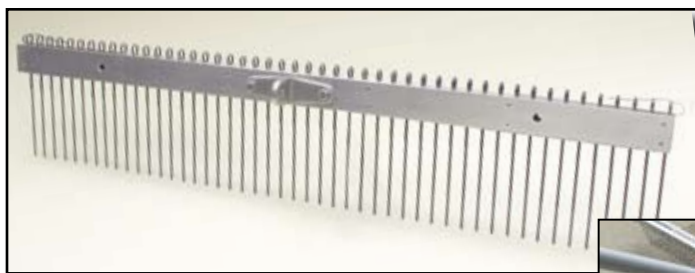

Broom produces a uniform rough groove surface on roads and bridges for maximum traction. Bracket accepts all clevis handles. Flat wires are 5" in length by .125 width, with 3/4" standard spacing on center; 1/2", 5/8" and 1" also available. Order adapters extra to use with bullfloat handles.

No.	Size
CC196-1/2	36" (1/2" spacing)
CC196-3/4	36" (3/4" spacing)
CC196-5/8	36" (5/8" spacing)
CC196-1	36" (1" spacing)
CC198-1/2	48" (1/2" spacing)
CC198-3/4	48" (3/4" spacing)
CC198-5/8	48" (5/8" spacing)
CC198-1	48" (1" spacing)
CC199-1/2	60" (1/2" spacing)
CC199-3/4	60" (3/4" spacing)
CC199-5/8	60" (5/8" spacing)
CC199-1	60" (1" spacing)
CC200	Replacement tines

#### When ordering:

Please specify 1/2", 3/4", 5/8 or 1" spacing on center (3/4" is the most popular size).

Kraft also offers wire texture brooms that vary according to State or Federal specifications in relation to tine spacing & length. Special lengths are also available for large paving machines.

## MAGNESIUM TRI LEVEL PLACER

GENUINE EXTRU-LITE™  
MAGNESIUM



Float  
Screed  
Level

Float Screed, and Level concrete with this versatile placer. Adjust height of handle to engage surface of tool or to engage point of triangle for checking flatness. Fitted with 60" wood handle.

No.	Size
CC932	24" Blade length
CC933	30" Blade length
CC934	36" Blade length
CC935	42" Blade length
CC933-02	5' Repl wood handle

**GENUINE** EXTRU-LITE™  
**MAGNESIUM**

## Magnesium Asphalt Lute

Now available with  
7' or 9' handles

Improved asphalt lute has blunt pointed teeth letting asphalt flow through. Use smooth side for finishing. Strong two-piece bracket holds blade in place. Comes with choice of 7' or 9' magnesium handle.

No.	Size	No.	Size
<b>Lute with 7' handle</b>		<b>Lute with 9' handle</b>	
GG824	24" Head	GG824-9	24" Head
GG830	30" Head	GG830-9	30" Head
GG836	36" Head	GG836-9	36" Head
GG842	42" Head	GG842-9	42" Head
GG824-02	7' Repl hdl	GG824-04	9' Repl hdl

## Magnesium Asphalt Rake

**GENUINE** EXTRU-LITE™  
**MAGNESIUM**

Lightweight magnesium head. Blunt teeth on one side and smooth edge on the other. Comes with 7' blue aluminum anodized handle. Prevents hands from turning black caused by oxidation. Fitted with braces for extra support.

No.	Size
GG624	24" Magnesium Rake
GG625	30" Magnesium Rake
GG626	36" Magnesium Rake
GG627	42" Magnesium Rake
GG626-03	7' Blue Aluminum Handle

## Patriot Rake

**3 Sizes!**

Special design for grading, sifting, and screening of stones and other debris. Fitted with 66" aluminum handle and braces for extra strength.

No.	Size
GG929	24" Patriot rake
GG929-01	w/o Handle
GG929-02	Braces (only)
GG929-03	66" Aluminum Handle (only)
GG930	30" Patriot rake
GG930-01	w/o Handle
GG932	36" Patriot rake
GG932-01	w/o Handle

7' Aluminum handle with braces

V-Shaped Crack Squeegee

## Asphalt Seal Coating Squeegee

Made of lightweight aluminum. Rubber blade clamped to head for easy change or reverse of blade. Blade angle designed for easy working angle and quick break-in period.

No.	Size
GG844	24" Asphalt seal coating squeegee
GG844-01	24" Rubber refill blade (Neoprene 60 G)
GG845	36" Asphalt seal coating squeegee
GG845-01	36" Rubber refill blade (Neoprene 60 G)
GG846	48" Asphalt seal coating squeegee
GG846-01	48" Rubber refill blade (Neoprene 60 G)

## V-Shaped Crack Squeegee

Rubber blade pushes and funnels material into cracks. Reversible replaceable blade. Includes 54" heavy-duty wood handle with tilting handle bracket.

No.	Size
GG813	Crack squeegee
GG813-01	Head (only)
GG813-02	Replacement blade (Neoprene 60 G)

## Landscape & Asphalt Rake

The 36" aluminum head is made for rugged use on asphalt. The 2-1/2" teeth have ball tips to insure longer life. Comes with 7' magnesium handle that is attached to head with cast magnesium bracket.

No.	Size
CC960	36"
GG824-02	7' Replacement handle

## Asphalt Crack Hoe

V-shaped 2"x4" head. Cleans cracks before sealing. Comes with 5' handle attached to head.

No.	Size
GG812	

**GENUINE**  
**MAGNESIUM**

EXTRU-LITE™

# SCREEDS

The #1 Selling Screed in America!



**Ask for KRAFT SCREEDS...Accept No Substitutes!**

- **KRAFT MAGNESIUM SCREEDS are 30% lighter than Aluminum Alloy screeds**
- **Working edge is 50% thicker than Aluminum Alloy screeds**
- **Magnesium will last 3 times longer than Aluminum Alloy... due to the release of alkaline in the concrete process**

Use only for hand screeding... not to be used with power screeds.

Kraft screeds are made of Genuine Extru-Lite Magnesium™ not Aluminum Alloy. These screeds are built for strength and rigidity but lightweight enough for those big jobs. Ends are capped to prevent concrete from building up inside. Extra end caps are available.

### Screed Handles

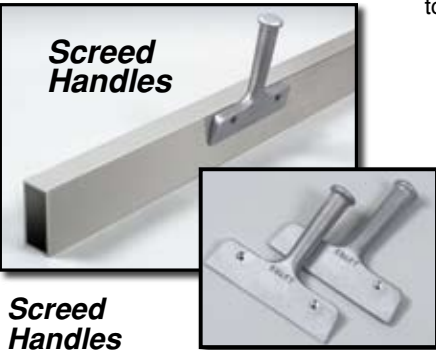

### Screed Handles

Lightweight aluminum handles adapt to any screed size. Drill holes and attach with hardware.  
No.  
CC503 (Pair)

1"x4"		Easy Grip 1-1/2"x3-1/2"		2"x4"		2"x5"	
No.	Size	No.	Size	No.	Size	No.	Size
CC506	6'	CC606	6'	CC406	6'	CC419	16'
CC508	8'	CC608	8'	CC408	8'	CC420	20'
CC510	10'	CC610	10'	CC410	10'	CC424	24'
CC512	12'	CC612	12'	CC412	12'		
CC514	14'	CC614	14'	CC414	14'		
CC516	16'	CC616	16'	CC416	16'		
		CC619	18' <b>NEW</b>	CC417	20'		
		CC620	20'				

**(2 per carton)**

10' or longer...must ship via truck

**GENUINE** EXTRU-LITE™  
**MAGNESIUM**

## Magnesium Keyhole Pavers Straightedge and Hand Screed

Special keyhole design for strength. Sturdy highway straightedge and checking tool. Complete with braces, 10' (CC291) button handle. Knucklehead® Bracket and roller bearing collar for easy adjustment.

No.	Size
CC721	10'
CC722	12'
CC723	16'
CC724	20'

### KEYHOLE HAND SCREED (ONLY)

Unique shape makes it easy to grip and the perfect tool for hand screeding.

No.	Size	No.	Size
CC726	10'	CC728	16'
CC727	12'	CC729	20'

Must ship via truck

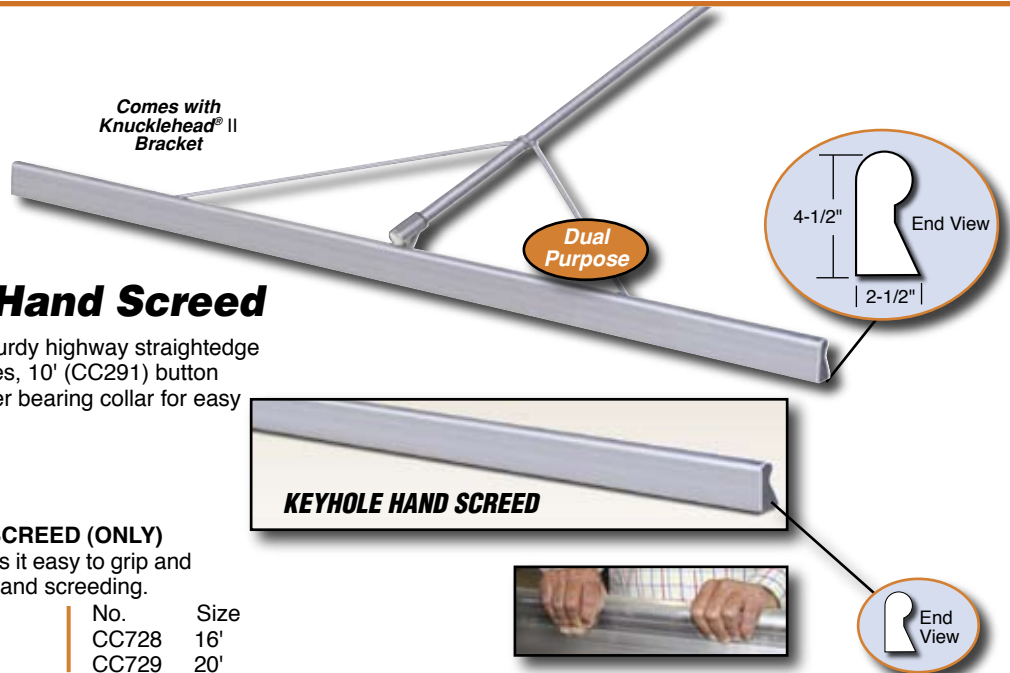

Comes with Knucklehead® II Bracket

Dual Purpose

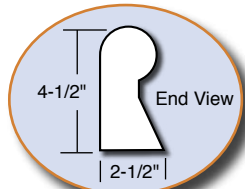

KEYHOLE HAND SCREED



# BuckEye™ Straightedge

w/ Level Vial Handle

Adjustable Level Vial



One man straightedge for striking off, leveling and bringing concrete to surface grade. Top reading spring loaded level vial for easy on the job adjustments. Made of lightweight high grade aluminum alloy. Wood handle tapered for smooth comfortable grip.



# Straightedges

10' & 12' must ship via truck

No.	Size	
CC891	4'x1-1/2"x1-1/2"	<b>NEW</b>
CC892	5'x1-1/2"x1-1/2"	<b>NEW</b>
CC893	6'x1-1/2"x1-1/2"	<b>NEW</b>
CC894	8'x1-1/2"x1-1/2"	<b>NEW</b>
CC895	10'x1-1/2"x1-1/2"	<b>NEW</b>
CC896	12'x1-1/2"x1-1/2"	<b>NEW</b>



## Redwood Striker™ Straightedge/Screed

**Lightweight**

10' must ship via truck

Made of the finest redwood, this tool is great for striking off concrete and leveling other material. 3 popular lengths with convenient hand hole spacing. 2 widths with rounded edges won't dig into material. 8' & 10' lengths can be ordered with adjustable level vial.

No.	Size	
CC439	6'x6"x1-1/4" (5/4w)	<b>NEW</b>
CC440	8'x6"x1-1/4" (5/4w)	<b>NEW</b>
CC441	10'x6"x1-1/4" (5/4w)	<b>NEW</b>
CC442	6'x6"x2" (8/4w)	<b>NEW</b>
CC443	8'x6"x2" (8/4w)	<b>NEW</b>
CC444	10'x6"x2" (8/4w)	<b>NEW</b>
CC443L	8'x6"x2" (8/4w) w/ level vial	<b>NEW</b>
CC444L	10'x6"x2" (8/4w) w/ level vial	<b>NEW</b>

## Magnesium Super Flat Pavers Straightedge

Durable, accurate straightedge and checking tool, lets user produce flat, even surface. Knucklehead® II Bracket adjusts blade to fill and level uneven areas. Comes complete with braces, 10' (CC291) button handle, Knucklehead® II Bracket and roller bearing collar for easy adjustments.

No.	Size
CC714	10'
CC716	12'
CC720	16'

Must ship via truck

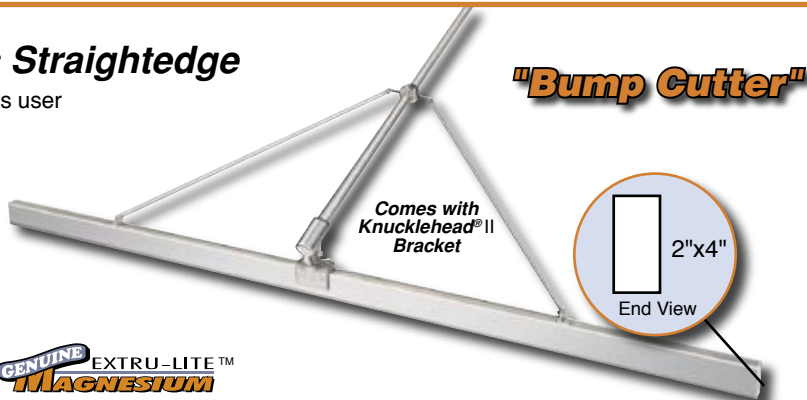

## Aluminum Pavers Straightedge

A lightweight durable, accurate straightedge and checking tool. Easy to handle, which makes inspection easy. Comes with 10' threaded (CC228) handle and braces.

No.	Size
CC710	10'
CC712	12'

Must ship via truck



## Magnesium Pavers Straightedge

An excellent checking tool. It is a lightweight, durable, accurate straightedge. Easy to handle, which makes inspection of slabs easy. Comes with 12' threaded (CC229) handle and braces.

No.	Size	Must ship via truck
CC561	10'	
CC562	12'	

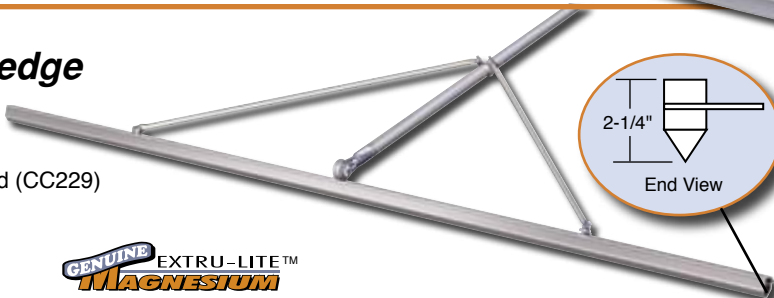

# ProForm® Troweler-Replacement Blades

Blades are made of heavy-duty steel to exacting specifications. Each blade is designed for longer life and greater performance.

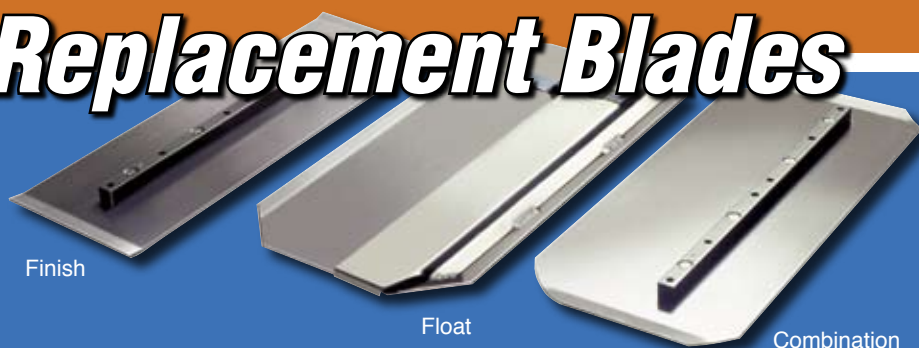

Model No.	MFG No.	Blade / Size	Kraft No.
-----------	---------	--------------	-----------

### Allen/Razorback

430	41696	Finish (6x10-1/2)	SK237
336	AEC-614F	Finish (6x14)	SK100
436	AEC-614F	Finish (6x14)	SK100
336	AEC-8140	Comb. (8x14)	SK101
436	AEC-8140	Comb. (8x14)	SK101
336	AEC-1014FO	Float (10x14)	SK102
436	AEC-1014FO	Float (10x14)	SK102
346	AEC-618F	Finish (6x18)	SK214
446	AEC-618F	Finish (6x18)	SK214
346	AEC-8180	Comb. (8x18)	SK215
446	AEC-8180	Comb. (8x18)	SK215
346	AEC-101AFO	Float (10x18)	SK105

### Bartell

B 424	20455	Finish (4-3/4x9)	SK238
B 430	20407	Finish (4-3/4x10)	SK239
Original B 430	10400	Finish (6x10-1/2)	SK237
B 336/B-436	TA414	Finish (6x14)	SK100
	TA414	Comb. (8x14)	SK101
	TA414F	Float (10x14)	SK102
B 346/B-446	TA410	Finish (6x18)	SK214
	TA410	Comb. (8x18)	SK215
	TA410F	Float (10x18)	SK105

### Edco



V NOTCH  
Combination

34" & 36"	F-1	Finish (6x14)	SK300
	C-1	Comb. (8x14)	SK301
	M-1	Float (10x14)	SK302
42"		Finish (6x16)	SK304
		Comb. (8x16)	SK305
44" & 46"		Float (10x16)	SK306
	F-3	Finish (6x18)	SK307
	C-3	Comb. (8x18)	SK308
	M-3	Float (10x18)	SK309

### Goldblatt

PT4-28	19177	Comb. (6x10)	SK177 <b>NEW</b>
PT4-36	19172	Finish (6x14)	SK172
	19179	Comb. (8x14)	SK179
	19102	Float (10x14)	SK102

### Marshalltown

36-3-1 & 2	M-6093	Finish (6x14)	SK100
36-4-1 & 2	M-6092	Comb. (8x14)	SK101
36-4-3 & E	A-4172	Float (10x14)	SK102
44-3-3 & E-4	M-6095	Finish (6x18)	SK214
	M-6094	Comb. (8x18)	SK215
	A-4171	Float (10x18)	SK105

Model No.	MFG No.	Blade / Size	Kraft No.
-----------	---------	--------------	-----------

### Master

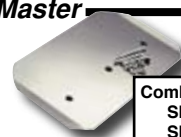

Combination  
SK151  
SK152  
SK154



Combination  
Channel Mount  
SK232  
SK233  
SK234  
SK235

F36B-3-4	3FT-36	★Finish (6x14)	SK151
	3FC-36	★Comb. (8x14)	SK152
F36B-3-4	Chnl. mount	Finish (6x14)	SK232
	Chnl. mount	Comb. (8x14)	SK233
B36-3-4		Finish (6x14)	SK100
		Comb. (8x14)	SK101
		Float (10x14)	SK102
F46B-3-4	3FC-46	★Comb. (8x18)	SK154
	Chnl. mount	Finish. (6x18)	SK234
		Comb. (8x18)	SK215
	3FF-46	Float (10x18)	SK105
RF3B3	RC46	Comb. (8x18)	SK235

★Includes: Nuts, bolts and washers

### MBW

36"	5347	Finish (6x14)	SK100
	5402	Comb. (8x14)	SK101
	5403	Float (10x14)	SK102
46"	5383	Finish (6x18)	SK214
	5412	Comb. (8x18)	SK215
	5413	Float (10x18)	SK105

### Stone

T-36	34578	Finish (6x14)	SK100
	34583	Comb. (8x14)	SK101
	34586	Float (10x14)	SK102
T-46	34580	Finish (6x18)	SK214
	34585	Comb. (8x18)	SK215
		Float (10x18)	SK105

### Grinding Stone Holder (only)

Please specify troweler and make.  
SK312 (Up to 36" machine size)  
SK318 (Over 36" machine size)

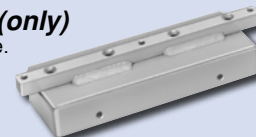

### Grinding Stone Holder (with stone)

SK313 (Up to 36" machine size)  
SK319 (Over 36" machine size)

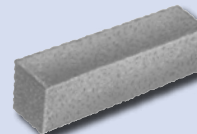

### Grinding Stone (only)

SK320 (6 Grit, 2"x2"x8")

**Model No. MFG No. Blade / Size Kraft No.**

**Stow**



All 34"	7394-401	Finish	(6x14)	<b>SK186</b>
3/4 bladed	11686-503	Comb.	(8x14)	<b>SK187</b>
All 36"	22027	Finish	(6x14)	<b>SK100</b>
3/4 bladed	22029	Comb.	(8x14)	<b>SK101</b>
	22028	Float	(10x14)	<b>SK102</b>
G-42-4	10937-501	Finish	(6x14)	<b>SK186</b>
All 46"	21637	Finish	(6x18)	<b>SK214</b>
	21988	Comb.	(8x18)	<b>SK215</b>
	21989	Float	(10x18)	<b>SK105</b>

**Superior**



GH-36	2836FL	Comb.	(8x14)	<b>SK220</b>
GH-44	2844FL	Comb.	(8x16)	<b>SK226</b>
		Float	(10-1/2x17-1/2)	<b>SK108</b>
	WF-816F	★FinishRC	(8x16)	<b>SK227</b>
GH-48	2848FL	Comb.	(8x18)	<b>SK228</b>

**Wacker**

CT36	73302	Finish	(6x14)	<b>SK100</b>
36" Diam.	74724	Float	(10x14)	<b>SK102</b>
	73301	Comb.	(8x14)	<b>SK101</b>
CT48	75313	Finish	(6x18)	<b>SK214</b>
48" Diam.	73877	Comb.	(8x18)	<b>SK215</b>
	75962	Float	(10x18)	<b>SK105</b>

**Model No. MFG No. Blade / Size Kraft No.**

**Wagman**

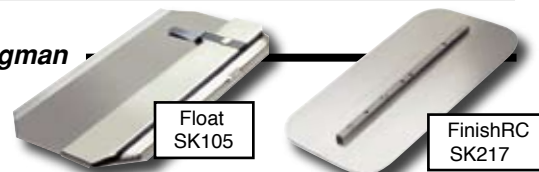

WB6105F	Finish	(6x10-1/2)	<b>SK237</b>
WB47590	Finish	(4-3/4x9)	<b>SK238</b>
WX592M6	Comb. <sup>Metric</sup>	(5x9-1/2)	<b>SK241</b>
WX614F	Finish	(6x14)	<b>SK100</b>
WX8140	Comb.	(8x14)	<b>SK101</b>
WX1014FO	Float	(10x14)	<b>SK102</b>
WX618F	Finish	(6x18)	<b>SK214</b>
WX8180	Comb.	(8x18)	<b>SK215</b>
WX1018FO	Float	(10x18)	<b>SK105</b>
WM61325CH	Finish	(6x14)	<b>SK232</b>
WM618CH	Finish	(6x18)	<b>SK234</b>
WM8140CH	Comb.	(8x14)	<b>SK233</b>
WM8180CH	Comb.	(8x18)	<b>SK235</b>
WX-623F	Finish	(6x23)	<b>SK216G</b>
WX-818F	FinishRC	(8x18)	<b>SK217</b>
WX8230	Comb.	(8x23)	<b>SK218G</b>
WF816F	FinishRC	(8x16)	<b>SK227</b>

**Whiteman / MultiQuip**

C Series24	C244	Comb. <sup>Metric</sup>	(5x9-1/2)	<b>SK241</b>
J4 & E 34"	900	Finish	(6x14)	<b>SK100</b>
	840	Comb.	(8x14)	<b>SK101</b>
	900F	Float	(10x14)	<b>SK102</b>
J4 & E 34" & 36"	954	Finish	(6x14)	<b>SK100</b>
	844	Comb.	(8x14)	<b>SK101</b>
	954F	Float	(10x14)	<b>SK102</b>
B3-E 44" & 46"	400	Finish	(6x18)	<b>SK214</b>
	375	Comb.	(8x18)	<b>SK215</b>
	400F	Float	(10x18)	<b>SK105</b>
B4-E 44" & 46"	444	Finish	(6x18)	<b>SK214</b>
	467	Comb.	(8x18)	<b>SK215</b>
	444F	Float	(10x18)	<b>SK105</b>
CA-AG	444	Finish	(6x18)	<b>SK214</b>
	464	Comb.	(8x18)	<b>SK215</b>
	444F	Float	(10x18)	<b>SK105</b>
B-3TW & B-4TW	444	Finish	(6x18)	<b>SK214</b>
	464	Comb.	(8x18)	<b>SK215</b>
		FinishRC	(8x18)	<b>SK217</b>
STH-60	F11990	Comb.	(6x23)	<b>SK216G</b>
STH-60	C11997	Comb.	(8x23)	<b>SK218G</b>

**ProForm® Long Life Replacement Blades**

✓ *Designed with a hard thick steel to cut down on blade changes on the job*

✓ *Each blade is designed for longer life and greater performance*

✓ *Long Life blades are ideal for the tough demands of riding power trowelers*



**ProForm®**  
**ULTRA BLUE**  
15% - 25%  
**LONGER LIFE**

Blade	Size	Part No.
Finish	6x14	SK100B
Comb.	8x14	SK101B
Finish	6x18	SK214B
Comb.	8x18	SK215B
Comb.	8x16	SK226B
Comb.	8x18	SK228B

Fits Allen, Bartell, Stone, Stow, Whiteman, Wacker & other popular styles trowels

Fits Superior Trowel

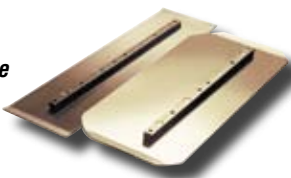

**ProForm®**  
**HEAVY-DUTY GOLD**  
Thick / Rugged  
25% - 50%  
**LONGER LIFE**

Blade	Size	Part No.
Finish	6x14	SK100G
Comb.	8x14	SK101G
Finish	6x18	SK214G
Comb.	8x18	SK215G
Comb.	8x16	SK226G
Comb.	8x18	SK228G

Fits Allen, Bartell, Stone, Stow, Whiteman, Wacker & other popular styles trowels

Fits Superior Trowel

"The best way to achieve flatter floors"

# ProForm® Float Pans

## Z-Clip Style

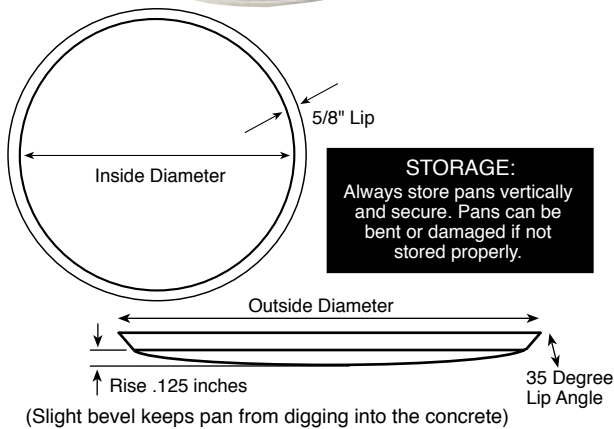

### STORAGE:

Always store pans vertically and secure. Pans can be bent or damaged if not stored properly.

## Safety Rod Style



Now... achieve flatter floors with less time on the job!

Made to fit... Non-Overlapping,  
"Walk behind" and "Ride-on" power trowelers.

**Pan fits right over power troweler blades!**

Please specify troweler "make and size".

No.	Pan Diameter (12 Gauge pan) Steel
SK400	35-3/4" (34-3/4" Inside Diam.) 4 Blade
SK401	36-1/2" (35-1/2" Inside Diam.) 4 Blade
SK402	38-1/4" (37-1/4" Inside Diam.) 4 Blade
SK403	45-3/4" (44-3/4" Inside Diam.) 4 Blade
‡ SK407	45-3/4" (44-3/4" Inside Diam.) 5 Blade
SK404	47-3/4" (46-3/4" Inside Diam.) 4 Blade

Heavy-duty	Pan Diameter (10 Gauge pan) Steel
SK410	45-3/4" (44-3/4" Inside Diam.) 4 Blade
SK411 <b>NEW</b>	45-3/4" (44-3/4" Inside Diam.) 5 Blade
SK406	47-3/4" (46-3/4" Inside Diam.) 4 Blade
SK409	47-3/4" (46-3/4" Inside Diam.) 5 Blade

‡ Fits Whiteman B-Series and BAN Series "Ride-on" trowelers

- Made to fit Non-Overlapping
- "Walk behind" or Ride-on"
- Beveled slightly to keep pan from digging into concrete
- Finish area slightly smaller than the Float Pan due to the bevel
- Blade slots on float pan fit to blades on troweler
- Blade slots can be used on trowelers that run either direction

**NEW**

Add "F" after part number for flat z-clip or safety rod style float pan

Please specify troweler "make and size".

No.	Pan Diameter (12 Gauge pan) Steel
SK400SR	35-3/4" (34-3/4" Inside Diam.) 4 Blade
SK401SR	36-1/2" (35-1/2" Inside Diam.) 4 Blade
SK402SR	38-1/4" (37-1/4" Inside Diam.) 4 Blade
SK403SR	45-3/4" (44-3/4" Inside Diam.) 4 Blade
‡ SK407SR	45-3/4" (44-3/4" Inside Diam.) 5 Blad
SK404SR	47-3/4" (46-3/4" Inside Diam.) 4 Blade

Heavy-duty	Pan Diameter (10 Gauge pan) Steel
SK410SR	45-3/4" (44-3/4" Inside Diam.) 4 Blade
SK411SR <b>NEW</b>	45-3/4" (44-3/4" Inside Diam.) 5 Blade
SK406SR	47-3/4" (46-3/4" Inside Diam.) 4 Blade
SK409SR	47-3/4" (46-3/4" Inside Diam.) 5 Blade

Heavy-duty	Pan Diameter (10 Gauge pan) Steel
SK408SR	60" (58-1/4" Inside Diam.) 6 Blade (90° lip)

‡ Fits Whiteman B-Series and BAN Series "Ride-on" trowelers SR With safety catch rod



# Super Tough Concrete Chutes



**Straight**

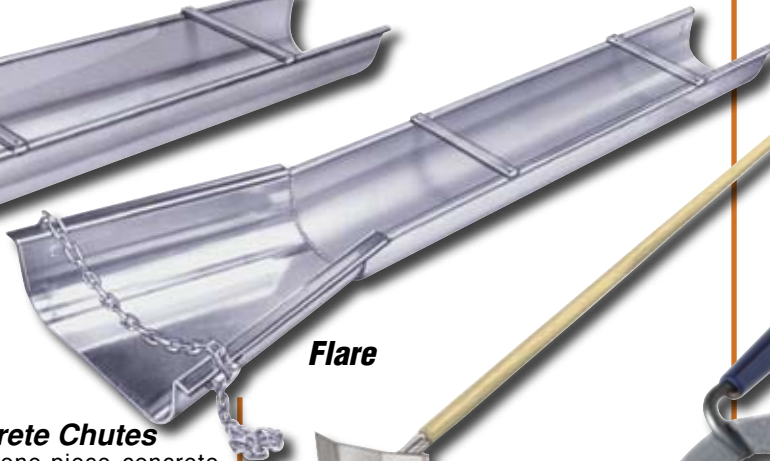

**Flare**

### Aluminum Concrete Chutes

Extruded aluminum one-piece concrete chutes. Lightweight and welded for extra strength. Welded flat bar braces across the top of each chute. Comes with chain for attaching to truck. Available with or without flare.

(Add "F" to the number for flare).

No.	Size	Weight
CC988	8'	42 lbs.
CC992	12'	75 lbs.
CC996	16'	98 lbs.
CC999	20'	120 lbs.

Must ship via truck.



**Concrete Chute Tool**

Sturdy, lightweight and made of 1/8" aircraft aluminum. Blade size is 10"x7-1/2" and the radius will fit most chutes. Comes with 54" wood handle.

No. CC987

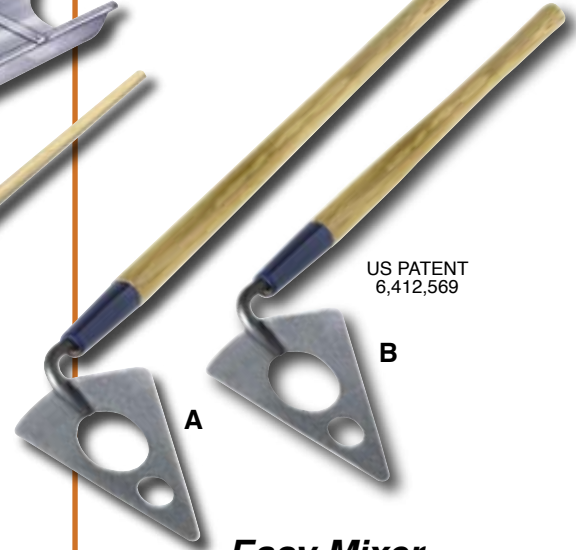

US PATENT 6,412,569

**Easy Mixer Concrete Hoe**

Great tool for mixing concrete fast in wheelbarrows, backhoe buckets and other mixing containers. Patented forged head easily mixes 60 to 90 lb. bags of concrete in 30-45 seconds. Special design creates minimum splash with 50% less drag. Great in corners. Open bag with point of hoe. 7-1/2"x6" blade.

- No. (A) CC211 Easy Mixer Concrete Hoe w/ 60" handle  
 (B) CC212 Easy Mixer Concrete Hoe w/ 21" handle

### Tapered Hand Edger

Choice of Handle



No.	Wood	ProForm®	Size	Radius
CF151	CF151PF	Tapered 8" to 3"x4"	3/8"	
CF156	CF156PF	Tapered 8" to 3"x4"	1/2"	

Made of heavy gauge stainless steel to work in all angle corners



### Stainless Steel Wall Edger

Wall edger fits between wall forms and smooths the surface. Turned up end. Made of stainless steel and fitted with ProForm® handle. Blade measures, 8"x7-1/2".

No. CF661PF



### Mini Mag Float

Extra lightweight magnesium wall float. Great tool for floating in small areas or top of wall between forms. Fitted with ProForm® handle. Blade measures, 7-1/2"x3-1/2".

No. CF663PF



Order bits separately.

### Barrier Trowel

Great for making safety grooves. Use with fresno groover attachments to adjust for bit size, depth and spacing. Carbon steel blade with rounded corners. Comes with 5' wood handle.

No.	Size
CC628	5"x13-1/2"
<b>Bronze Groover Bits</b>	
CC622	1/4"
CC623	1/2"
CC625	3/4"
CC626	1"

Order bits separately.

### Utility Stamps

Stamp concrete with locations of water and sewer lines. Made of long wearing cast aluminum 3" letters.

No.	Description
CF405	Water utility stamp
CF403	Sewer utility stamp





# Concrete Finish Brooms



Poly Fiber Bristles

## Concrete Finishing Broom (Aluminum)

Brush down new concrete after floating with these lightweight aluminum brooms. Three style bristles to choose from: medium-general purpose, extra soft, or natural horsehair and poly blend. All bristles are epoxy glued for straightness and strength. Use CC662 adapter to use with threaded handles.

No.	Size	
CC175	24"	Medium-General Purpose (Black Poly)
CC177	36"	Medium-General Purpose (Black Poly)
CC178	48"	Medium-General Purpose (Black Poly)
CC189	60"	Medium-General Purpose (Black Poly)
CC203	72"	Medium-General Purpose (Black Poly)

CC179	36"	Extra Soft (White Poly)
CC180	36"	Natural Horsehair & Poly Blend
CC176	48"	Natural Horsehair & Poly Blend



## Weigh-Lite® Concrete Finishing Broom

Made for brushing down newly laid concrete surface. No waiting for surface to dry. Soft, plastic fibered solid stock brush. Bracket included. Order CC662 adapter to use with threaded handles.

No.	Size	
CC154	24"	(CC155)...24" Replacement strip
CC156	36"	(CC157)...36" Replacement strip
CC158	48"	(CC159)...48" Replacement strip
CC248	48"	.022 Bristle, medium coarse (white poly)
CC249	48"	Replacement strip
CC250	54"	.022 Bristle medium coarse (white poly)
CC251	54"	Replacement strip

CC160  
Bracket  
(only)

## Concrete Finishing Broom (Wood)



Soft, plastic bristle, designed to give a fine finish on newly poured concrete. Long wearing bristles are set solidly in wood. All brooms come with 5' wood handle.

### Plastic Bristles

No.	Size	Bristles	No.	Size	Bristles
CC164	18"	2-3/8"	CC166	36"	3-1/4"
CC165	24"	2-3/8"	CC188	48"	3-1/4"

Add "01" after part number for broom less handle

### Horsehair Bristles

CC193	24"	2-1/2" (Horsehair)	Replacement Handle...5' metal thread broom handle (No. CC163)
CC194	36"	2-1/2" (Horsehair)	

## "The Performer" Concrete Finishing Broom (Wood)

Concrete finishing broom has three rows of black nylon bristles. Fits any standard threaded handle. Adapter included. Accepts standard broom threaded handles.

No.	Size	
CC254	24"	Replacement Handle Adapter No. CC259
CC255	30"	
CC256	36"	

Nylon Bristles

## Concrete Floor Broom (Wood)

All-purpose floor broom for concrete and wood floors. Wood block, 3" black tampico fiber, 60" threaded wood handle. Accepts broom threaded extension handles.

No.	Size
CC183	18"
CC184	24"
CC185	30"
CC186	36"

Add "01" after part number for broom less handle



Poly Fiber Bristles

## Concrete Finishing Broom (Wood)

Brush down new concrete after floating, with these poly fibered brooms. Three styles to choose from: medium-general purpose, medium coarse poly, and extra coarse poly for rough surfaces. All bristles are epoxy glued for straightness and strength. All brooms are made from solid hardwood lacquered blocks for just the right feel and finish. Use CC662 adapter to use with threaded handles.

No.	Size	
CC170	24"	Medium-General Purpose (Black Poly)
CC172	36"	Medium-General Purpose (Black Poly)
CC173	48"	Medium-General Purpose (Black Poly)

CC171	36"	Medium Coarse (White Poly)
CC174	36"	Extra Coarse (Black Poly)



Black Tampico Fiber Bristles

## All-Purpose Horsehair Floor & Finish Broom

All-purpose floor broom for concrete and wood floors. Wood block, 2-7/8" pure 100% black horsehair, 60" threaded wood handle. Accepts broom threaded extension handles.

No.	Size
CC187	24" (Horsehair)
CC192	36" (Horsehair)

Add "01" after part number for broom less handle



Horsehair Bristles

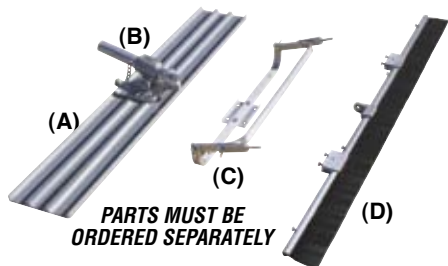

PARTS MUST BE ORDERED SEPARATELY

# Float & Broom

Now... float and broom in one pass!

- ✓ Helps eliminate reaching and lifting
- ✓ Perfect tool for those wide slabs

Great tool to finish wide slabs without reaching or lifting. Adjustable broom adapter bar allows user to determine the working angle of the broom. Broom should extend past end of float for best finishing results.

- (A)** CC802-01 48"x8" Heavy-duty magnesium float
- (B)** CC294 EZY-Tilt® 4-hole bracket...use 1-3/8" or 1-3/4" Snap Button Bull Float handles
- (C)** CC181 Broom Adapter Bar...Fits Bull Floats, Big "D" Floats & Fresnos with tilting brackets or adapts to use with texture brooms
- (D)** CC182 54" Weighlight broom w/bracket
- CC190 54" Replacement broom strip for (CC-182); Medium Bristles
- CC191 Brackets for adapter bar...Replacement brackets that adapt broom to adapter bar (2 required)

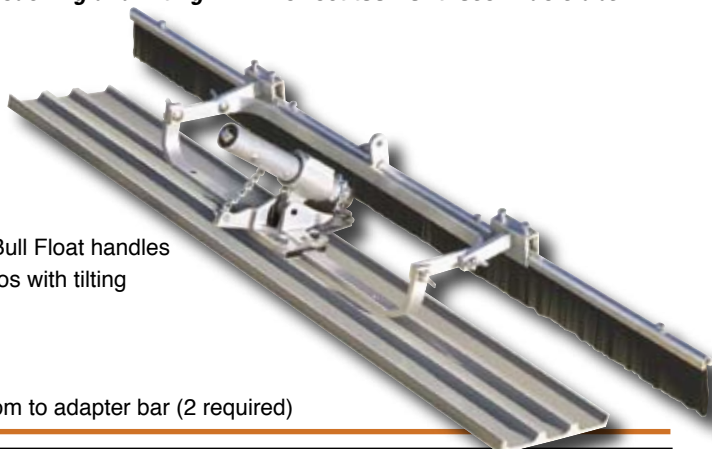

## Broom Cover/Protector

Broom not included

Designed to fit aluminum finish brooms up to 48". Open ends allow broom to dry and keep original shape. Snap button closures secures broom in place. 48" Long.

- |       |                       |
|-------|-----------------------|
| No.   | Size                  |
| CC258 | Broom Cover/Protector |

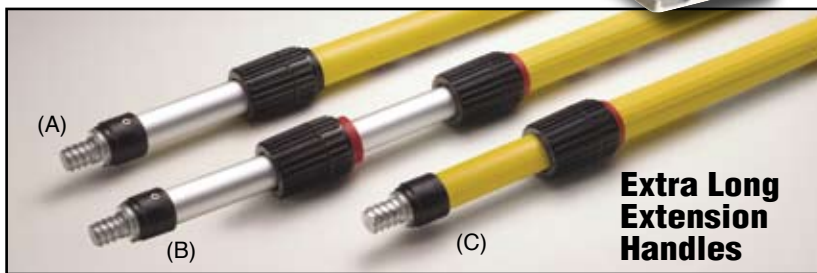

## Extra Long Extension Handles

Lightweight telescoping Fiberglass® handles fit all brooms that take a broom thread. Swivel twist lock loosens and tightens handles when extended to desired lengths.

- |       |  |
|-------|--|
| No.   | Size   |
| CC446 | (A) Fiberglass® with aluminum extensions 6'3" to 12' |
| CC429 | (B) Fiberglass® with aluminum extensions 6'6" to 18' |
| CC448 | (C) All Fiberglass® 6'3" to 12'                      |



Adapter



Base

## All-Angle Broom Adapter

Cut out section of adapter fits over broom bracket. Adjustable angle. Accepts broom thread handle.

- |       |                    |
|-------|--------------------|
| No.   | Size               |
| CC493 | Broom Adapter      |
| CC494 | Broom Bracket Base |



## Extension Handle Broom Adapter

Attach paint rollers, brooms, etc., to molded thread extension handles.

No. CC297



## Twist-Tilt Broom/Fresno Bracket

Light, sturdy bracket used to adjust angles of broom heads. Turn handle for quick angle adjustment. Tighten to lock into place.

No. CC282

## Heavy-Duty Broom

Designed for heavy sweeping. Heavy-duty crimped orange bristles. Bristles hold up under the toughest of conditions. Comes with 54" tapered end (BL432) wood handle.

- |       |           |
|-------|-----------|
| No.   | Size      |
| CC195 | 18" Broom |
| CC197 | 24" Broom |



## Soft Horsehair Brush

Designed for soft hand brushing of newly laid concrete surface. Fitted with comfortable wood float handle.

- |       |           |
|-------|-----------|
| No.   | Size      |
| CC269 | 12" Brush |



## Curb Brush (Wood)

Curb brush for hand brushing newly laid finished concrete surfaces. 12" long with soft plastic fiber bristles. Perfect for those small jobs.

- |       |      |
|-------|------|
| No.   | Size |
| CC169 | 12"  |

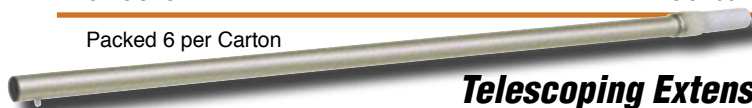

Packed 6 per Carton

## Telescoping Extension Handle

3 Sizes!

Aluminum telescoping extension handle. 1-3/8" button style attachment. Use with brackets and adapters to fit 1-3/8" diameter. Ideal for extra long reach with lighter tools. Twist-lock holds handle at desired length.

- |          |                            |
|----------|----------------------------|
| No.      | Size                       |
| CC430    | 8'-16' Telescoping handle  |
| CC436    | 12'-24' Telescoping handle |
| CC438    | 16'-32' Telescoping handle |
| CC430-01 | Replacement lock assembly  |



# Professional Bronze Groovers

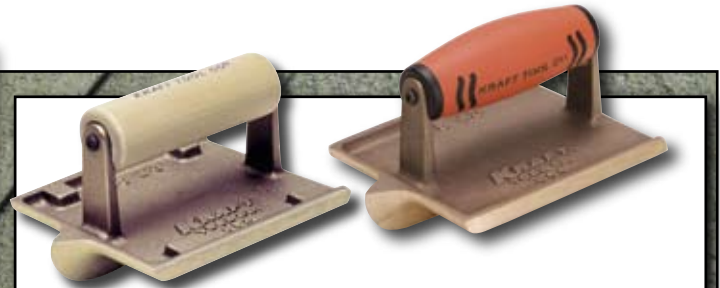

Available with Wood or ProForm® Handle

**Kraft 100% Bronze...  
The Best!**

**MADE IN USA**

*Cuts smooth  
clean grooves*



*Unique long wearing  
one-piece casting*

*Hand polished for the  
professional concrete finishers*

**Quick  
Change**



Converts any hand tool... into  
a walking tool in seconds! See  
page 38

**Choice of Handle**



Wood



ProForm®

**CF314**

**CF314PF**

**DEEP BIT**  
6"x4-1/2"

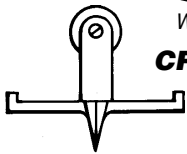

1" Deep Bit 1/2" Wide Bit 1/4" R

**Choice of Handle**



Wood



ProForm®

**CF317**

**CF317PF**

**EXTRA DEEP BIT**  
7-1/2"x4-1/2"

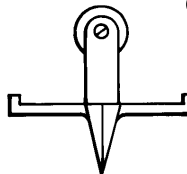

1-1/2" Deep Bit 1/2" Wide Bit 1/4" R

**Choice of Handle**



Wood



ProForm®

**CF260**

**CF260PF**

**MEDIUM BIT**  
5-1/2"x3"

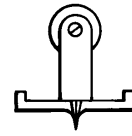

3/8" Deep Bit 5/16" Wide Bit 1/4" R

Wood

ProForm®

**CF305**

**CF305PF**

**NARROW BIT**  
6"x4-1/2"

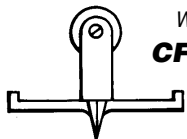

3/4" Deep Bit 3/8" Wide Bit 1/4" R

Wood

ProForm®

**CF315**

**CF315PF**

**CANADIAN DEEP BIT**  
6"x4-1/2"

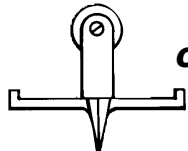

1-1/2" Deep Bit 1/2" Wide Bit 1/4" R

Wood

ProForm®

**CF301**

**CF301PF**

**SMALL BIT**  
6"x2"

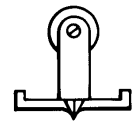

3/16" Deep Bit 3/16" Wide Bit 1/4" R

Wood

ProForm®

**CF304**

**CF304PF**

**BIG BIT**  
6"x4-1/2"

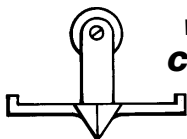

3/4" Deep Bit 7/8" Wide Bit 3/8" R

Wood

ProForm®

**CF408**

**CF408PF**

**BIG TEX BIT**  
6"x4-1/2"

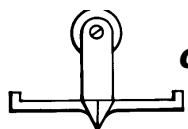

5/8" Deep Bit 5/8" Wide Bit 1/4" R

Wood

ProForm®

**CF316**

**CF316PF**

**DENVER JUMBO BIT**  
6"x4-1/2"

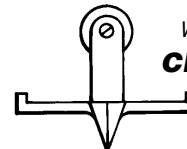

1-1/4" Deep Bit 1" Wide Bit 1/2" R

Wood

ProForm®

**CF303**

**CF303PF**

**LARGE BIT**  
6"x4-1/2"

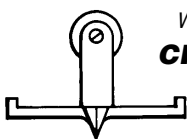

1/2" Deep Bit 3/8" Wide Bit 1/4" R

Wood

ProForm®

**CF380**

**CF380PF**

**COLORADO BIT**  
6-1/2"x3"

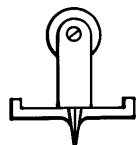

3/4" Deep Bit 3/8" Wide Bit 1/8" R

Wood

ProForm®

**CF374**

**CF374PF**

**DEEP BIT**  
8"x4-1/2"

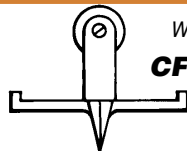

1" Deep Bit 1/2" Wide Bit 1/4" R

# Professional **Bronze Edgers**

MADE IN USA

Unique long wearing one-piece casting  
Hand polished for the professional concrete finisher

## MATCHED SET Bronze Groover and Edger

Groover bit (depth and radius) matches edger lip. Perfect for matching edge and groove finishes on sidewalks and driveways.

Choice of Handles...

### Choice of Handle



No.	Wood	ProForm®	Size
CF318	CF318PF		Edger, 6"x3", lip 3/4", 3/8" radius,
CF319	CF319PF		Groover, 6"x6", 5/8" wide bit, 3/4" deep, 3/8" radius
CF324	CF324PF		Edger/Groover (Set)



## Edgers

- Special turned up ends to eliminate gouging of concrete

### Choice of Handle



No.	Wood	ProForm®	Size	Radius	Lip
CF311	CF311PF		6"x2-3/4"	1/4"	5/8"
CF313	CF313PF		6"x4"	1/4"	5/8"



## Jumbo Bronze Edger

### Choice of Handle



No.	Wood	ProForm®	Size	Radius	Lip
CF312	CF312PF		9"x4"	1/4"	3/4"



# Walking Bronze Groovers & Edgers

MADE IN USA

## Single End Bit Groover

- Belt polished surface for cutting clean smooth sharp grooves
- Long wearing one-piece bronze with turned up end
- Easy to clean and comfortable to use
- Comes with 5' wood flip-flop handle

### 6"x4-1/2"

No.	Bit Depth	Width	Radius
CC303	1/2"	3/8"	1/4"
CC308	5/8"	5/8"	1/4"
CC304	3/4"	7/8"	3/8"
CC305	3/4"	3/8"	1/4"
CC314	1"	1/2"	1/4"
CC316	1-1/4"	1"	1/2"

### 7-1/2"x4-1/2"

CC317	1-1/2"	1/2"	1/4"
-------	--------	------	------

### 8"x4-1/2"

CC374	1"	1/2"	1/4"
-------	----	------	------

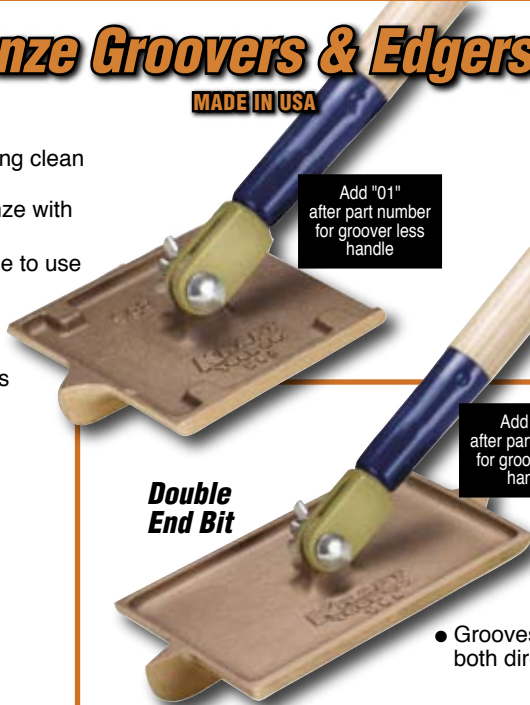

No.	Size	Bit Width	Depth	Radius
CC275	8"x4-1/2"	1/2"	1"	1/4"

## Single End Bit Groover 8"x8"

- Belt polished surface for cutting clean smooth sharp grooves
- Long wearing one-piece bronze with turned up end
- Easy to clean and comfortable to use
- Comes with 5' wood flip-flop handle

### 8"x8"

No.	Bit Depth	Width	Radius
CC276	3/4"	3/8"	1/4"
CC277	3/4"	1/4"	1/8"
CC278	1"	3/8"	1/4"
CC279	1-1/2"	5/8"	1/4"



## Bronze Edgers

- Belt polished surface for cutting clean smooth edges
- Long wearing one-piece bronze with turned up ends
- Easy to clean and comfortable to use
- Comes with 5' wood flip-flop handle

No.	Size	Radius	Lip
CC302	9"x4"	1/4"	3/4"
CC313	6"x4"	1/4"	5/8"

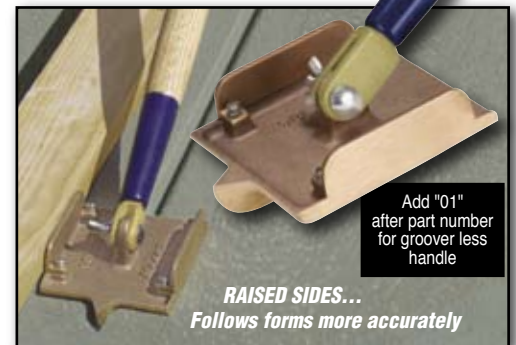

## "Side Railer" Bronze Groover

- Unique design with raised sides, allows this popular bronze groover to more accurately follow forms and straightedges when grooving
- Comes with 5' wood handle

No	Size	Bit Width	Depth	Radius
CC314SR	6"x4-1/2"	1/2"	1"	1/4"
CC304SR	6"x4-1/2"	7/8"	3/4"	1/4"



## Bronze Groover



**w/ 360 Degree Swivel Bracket**

Includes 54" heavy-duty wood handle

Add "01" after part number for groover less handle

6"x4-1/2"

No.	Bit Depth	Width	Radius
CC303CA	1/2"	3/8"	1/4"
CC304CA	3/4"	7/8"	3/8"
CC305CA	3/4"	3/8"	1/4"
CC314CA	1"	1/2"	1/4"

- Belt polished surface for cutting clean smooth sharp grooves
- Fitted with 360 degree swivel handle bracket
- Easy to clean and comfortable to use

## Bronze Concrete Name Stamp



The perfect way to mark concrete for permanent identification. Made from high grade bronze. Stamp is 5"x9" oval with flat ends. 16 spaces on three lines. Replacement year stamp is 5/8" high. Stamp can be furnished without date on request. Allow approximately 3-4 weeks for shipment.

**PUT YOUR NAME HERE**



No.

CF400	Stamp with 2008 insert
CF400-01	Stamp without date
CF401-08	2008 date (insert only)
CF401-09	2009 date (insert only)

See Page 125 for Order Blank

## Bronze Rocker Groovers

- Curved blade and tilt handle give plenty of knuckle room

No.	Size	Bit	Radius
CF306	5"x1-3/4"	1/4"x1/4"	1/8"
CF307	5"x1-3/4"	3/8"x3/8"	1/4"
CF308	5"x1-3/4"	1/2"x1/2"	1/4"
CF310	5"x4"	3/8"x3/8"	1/4"



## Bronze Chamfer Tube Edgers



- Belt polished surface for cutting clean smooth edges
- Used for creating chamfered edges on round support piers.

- Made of long wearing one-piece bronze with 1" lip / 1/2" radius and turned up ends.
- Slope on the pier edge can be varied depending upon wetness of the concrete and angle and pressure of the Chamfer Tube Edger.



**Choice of Handle**

No.	Wood	ProForm®	Size
CF382	CF382PF		(12" diam.)
CF383	CF383PF		(16" diam.)
CF384	CF384PF		(18" diam.)
CF385	CF385PF		(24" diam.)
CF386	CF386PF		(30" diam.)
CF387	CF387PF		(36" diam.)
CF388	CF388PF		(48" diam.)

## Quick Change

**Converter Bracket for Hand Held Tools**



**Converts any hand tool... into a walking tool in seconds!**

- Thumb screws hold bracket securely in place
- Fits all bronze, stainless steel and blue steel hand tools

No. CC495 Aluminum Quick Change Converter Bracket

## Iron Groovers

### Dallas Bit Groover

Dallas Bit groover made of long wearing malleable iron. Makes grooves 5/8" wide and 5/8" deep (approx 1/8" radius).

No. Size  
CF299 6"x4-1/2"



### Ultra Hard Groover

This west coast favorite is made of a special formula chrome-nickel-iron metal that is long lasting. Has 6" wood handle with steel clevis. Tightens to various angles.

No. Size Bit  
CF404 3-1/2"x4" 1/4" wide 3/8" deep

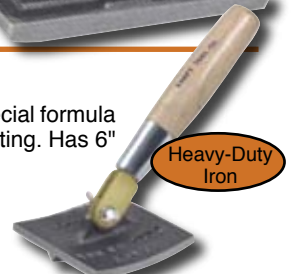



**HEAVY-DUTY**

**Rubber Floor Squeegee**

Rugged heavy-duty floor squeegee with all steel construction. Pure gum rubber blade is replaceable and reversible for longer wear. Comes complete with 60" replaceable wood handle.

No.	Size
GG285	24" Floor Squeegee
GG286	36" Floor Squeegee
GG287	24" Rubber refill
GG288	36" Rubber refill

Replaceable rubber blade mounted to aluminum frame. Fitted with 54" (BL432) tapered wood handle.

**Economy Straight Blade Squeegee**

No.	Size
GG224	24" Straight blade squeegee
GG230	30" Straight blade squeegee
GG236	36" Straight blade squeegee

**Economy Curved Blade Squeegee**

No.	Size
GG224C	24" Curved blade squeegee
GG230C	30" Curved blade squeegee
GG236C	36" Curved blade squeegee

GG224-03	24" Rubber replacement blade
GG230-03	30" Rubber replacement blade
GG236-03	36" Rubber replacement blade

**Economy Squeezes**



ADD (01) to Part No. for Squeegee less handle

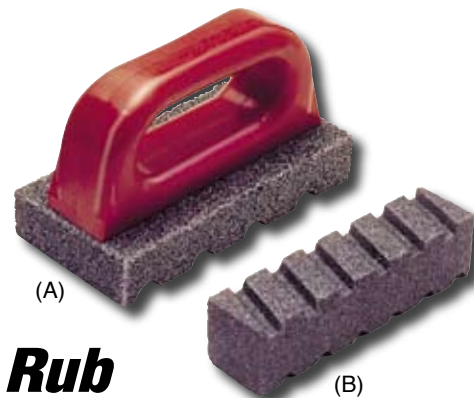

**Rub Bricks**

**(A) Fluted**

Fluted silicon carbide rub bricks with a contoured handle to minimize fatigue. Preferred by finishers for fast and easy concrete smoothing and dressing down.

No.	Size	Grit
CF268	8"x3-1/2"x1-1/2"	20
CF283	6"x3"x1"	20
CF282	6"x3"x1"	60

**(B) Fluted less Handle**

Made of silicon carbide, fluted on two sides.

No.	Size	Grit
CF462	6"x2"x2"	20
CF482	8"x2"x2"	20

Replacement handle for all Rub Bricks CF283-01



**Gauge Rake**

Made of lightweight aluminum. Adjusts up to 2" for uniform coating of surface. Comes with 54" tapered wood handle (BL432).

CC975	24" Rake w/ wood handle
CC975-01	24" Rake w/o handle
CC976	36" Rake w/ wood handle
CC976-01	36" Rake w/o handle

**Gunite Shoes**



Adjustable lightweight aluminum shoes. One size fits all. Fitted with (12) 1" steel spikes. Adjustable sole plate and heel support. Two nylon adjustable straps securely hold gunite shoe to work boot.

No.	CC970 (pair)
-----	--------------

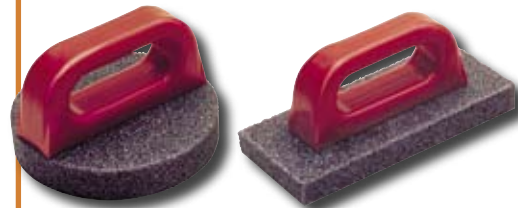

**Round Rub Brick**

Round rub brick with handle. Lightweight. Makes grinding easy. Use one in each hand. Stone is 1" thick and 6" diameter.

No.	CF270	Size	6"x1"	Grit	20
-----	-------	------	-------	------	----

**Broken-in Rub Brick**

Already broken in and ready for smoothing and dressing down concrete. A good value for the price.

No.	CF281	Size	8"x3-1/2"x3/4"	Grit	20
-----	-------	------	----------------	------	----



**Gunite Trowels**

Same as regular concrete trowels, only rivets have not been ground off, making the trowel stronger for use on gunite.

Straight wood hdl	ProForm® hdl
No.	No.
CF208	CF208PF
CF209	CF209PF



**Gunite Shoes**

Imported

Used for Epoxy and Gunite installation. One size fits all. Fitted with (13) 1" steel spikes. Two nylon adjustable straps securely hold gunite shoe to work boot.

No.	HC178* (pair)
-----	---------------

Radius bender is used for rounding and finishing corners of pools and other shot crete or gunite corners that need free hand finishing. Blue steel 24" x 2-1/2".

No.	CC980
-----	-------

**Radius Bender**



**Curved Shot Crete Fresno**



This fresno is specially curved for shot crete work. The rivets are left unground for extra strength. High quality round end carbon blade with steel mounting. Single action bracket.

No.	CC914	Size	24"x5"
	CC915	Size	30"x5"

**NOW!...Cut perfect Control Joints and Corners before removing the forms.**

**Ideal for:**

- Parking Curbs
- Step Faces
- Step Corners
- Control Joints
- Curb and Gutter
- Stadium Risers
- Exposed Aggregate

For more information, call for a FREE Brochure!

# Concrete Step-Saver® Tools

- EASY TO USE!
- SAVES TIME!
- INCREASES QUALITY!



These tools belong in every concrete finisher's tool bag

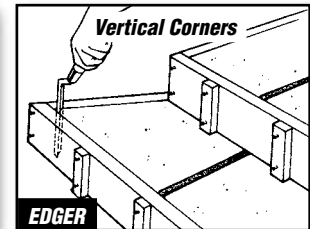
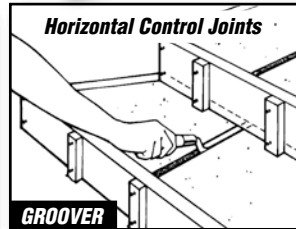
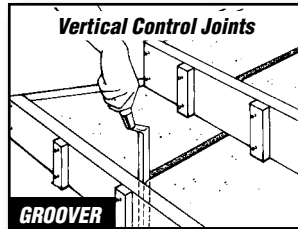

## Step-Saver® Groovers

- Used to groove vertical and horizontal control joints into the face of slabs, curbs, and steps
- Easy to use, just
- Work it between the form and concrete for a perfect joint
- A must for finishers

No.	Size
CF007	12"L x 3/8"W x 3/4"D
CF008	12"L x 1/2"W x 1"D
CF009	12"L x 7/8"W x 3/4"D
CF010	6"L x 1/2"W x 1"D

U.S. Patent #D-333,600

**Groovers**



## Step-Saver® Edgers

- Make finishing step corners a breeze
- Insert and work between forms and concrete at step corners
- Once risers are stripped perfect rounded corners remain
- A must have for every concrete finisher

No.	Size
CF001	10"L x 3/8"R
CF002	10"L x 1/2"R
CF003	10"L x 3/4"R

U.S. Patent #5,098,278

**Edgers**



Available in hand and walking styles. Extra weight of tools allows sharp clean grooves. Target sites on walking groovers for straight lines.

# All Steel Groovers

### All Steel Hand Groovers

No.	Size	Radius	Depth
CF483	6"x6"	1/2"	1"
CF484	6"x6"	3/4"	1"



### All Steel Walking Groovers

Groover made with sight guide and two studs. Order bull float brackets or handle adapters separately.

No.	Size	Radius	Depth
CC700	12"x14"	1/2"	1"
CC701	12"x14"	3/4"	1"
CC702A	8"x10"	1/2"	1"
CC703A	8"x10"	3/4"	1"

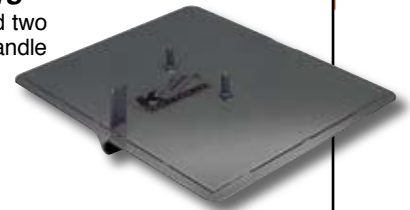

### All Steel Walking Angle Groovers

Cuts groove diagonally away from corners and enclosed areas.

No.	Size	Radius	Depth
CC704	8"x10"	3/4"	1"
CC705	8"x10"	1/2"	1"
CC706	8"x10"	3/4"	7/8"



Groover made with sight guide and prong style mounting bracket. Use with fresno adapters.

No.	Size	Radius	Depth
CC702	8"x10"	1/2"	1"
CC703	8"x10"	3/4"	1"

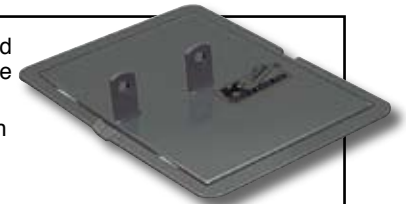

### Handle Adapters

Handle adapter for all-steel groovers and other tools that have 2 studs. Two styles, swivel action and straight.



No.	Description
CC659	Single Action Adapter
CC660	Swivel Action Adapter



# Walking Airplane Groovers

Groover is made of high quality cast aluminum. Groover measures (24"x8"), (12"x8") or (8"x8") with broken-in face. Bit size matches hand groovers (CF304 & CF314) in depth and radius. Adjustable EZY-Tilt® II bracket allows finisher to use tool at just the right angle.

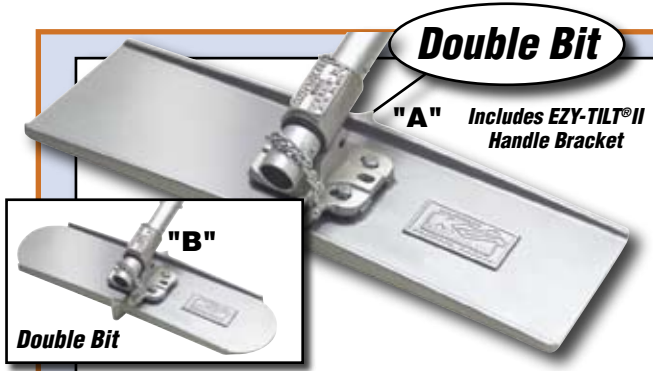

**Double Bit**

"A" Includes EZY-TILT® II Handle Bracket

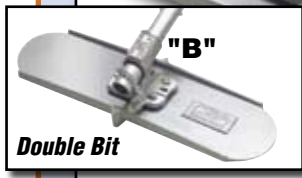

"B"

Double Bit

**A - 24"x8" Groover    B - 24"x8" Round End Groover**

No.	Bit	No.	Bit
<b>Big Bit</b>		<b>Big Bit</b>	
CC304A	3/4"	CC304ARE	3/4"
<b>Deep Bit</b>		<b>Deep Bit</b>	
CC314A	1"	CC314ARE	1"

Add "01" after part number for groover less bracket



**Single Bit**  
Square Back

**24"x8" Groover**

No.	Bit
<b>Big Bit</b>	
CC304AS	3/4"
<b>Deep Bit</b>	
CC314AS	1"

Includes EZY-TILT® II Handle Bracket

Add "01" after part number for groover less bracket

CC304A/B & CC314A/B Airplane Groovers — match — CF304 & CF314 Bronze Hand Groovers Page 34

## 12" & 8" Walking Airplane Groovers



**Double Bit**

12"x8" Groover				8"x8" Groover			
No.	Bit	No.	Bit	No.	Bit	No.	Bit
<b>Big Bit</b>		<b>Deep Bit</b>		<b>Big Bit</b>		<b>Deep Bit</b>	
CC304B	3/4"	CC314B	1"	CC304C	3/4"	CC314C	1"

Includes EZY-TILT® II Handle Bracket

## Magnesium Jumbo Pavers Groovers

This popular groover is available with either a 1" or 1-1/2" bronze bit. It comes with 4-hole adjustable bracket for use with 1-1/4" or 1-3/4" threaded handle. Bits are replaceable.

No.	Size	Bit
CC858	8"x8"	1"
CC859	8"x8"	1-1/2"
CC861	8"x10"	1"
CC863	8"x10"	1-1/2"
CC865	8"x24"	1"
CC867	8"x24"	1-1/2"

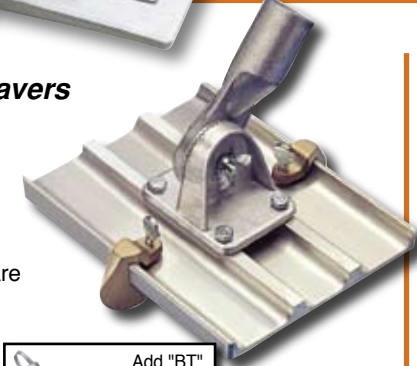

Add "BT" after part number for button float bracket (CC696) **NEW**

## West Coast Style Airplane Groover

Made of high quality cast aluminum. Groover cuts clean sharp grooves. Measure 24"x8" with broken-in face. Fits all bull float handle adapters and clevis handles.

DOUBLE END GROOVER BIT			SINGLE END GROOVER BIT		
No.	Bit	Radius	No.	Bit	Radius
CC320	3/4"	3/8"	CC321	3/4"	3/8"
CC322	1"	1/4"	CC323	1"	1/4"
CC324	1-1/2"	1/4"	CC325	1-1/2"	1/4"



Square End

DOUBLE END GROOVER BIT		
No.	Bit	Radius
CC322RE	1"	1/4"



Round End

## 8x8 Stainless Steel Walking Groover

Made of heavy gauge stainless steel. Closed end bit.

No.	Size	Bit	Radius
CC021	8"x8"	3/4"	1/2"
CC022	8"x8"	7/8"	1/2"

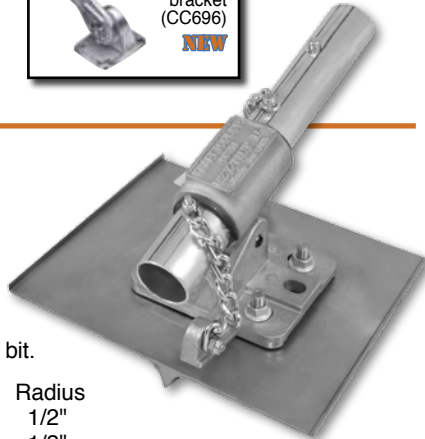

## Bronze Bull Float Groover Bits

Attaches with two thumbscrews. Use bull float as groover. Mount as many groovers as needed. Works on 8" wide magnesium bull floats and jumbo paver groover.

No.	Bit Depth	Radius	Width
CC940	3/4"	1/4"	1/2"
CC941	1"	1/4"	1/2"
CC942	1-1/2"	1/4"	1/2"
CC943	2"	1/4"	1/2"





### All Angle Walking Groovers

- Made of heavy gauge stainless steel
- Reinforced with an electrically welded back plate to which the all-angle attachment is fastened
- No rivet break up, completely smooth face
- Comes with 5' wood handle

No.	Size	Bit	Radius	Width
CC347	8"x6"	1"	1/4"	1/2"
CC373	10"x3-1/2"	1/2"	3/8"	3/4"



Add "01"  
after part number  
for groover less handle

### Walking Groovers with Handle Socket Bracket

- Same as walking groover except with adjustable threaded handle socket

- Accepts threaded bull float extension handles

No.	Size	Bit	Radius	Width
CC355	10"x3-1/2"	1/2"	3/8"	3/4"
CC356	8"x6"	3/4"	1/4"	1/2"
CC357	8"x5"	1"	3/8"	3/4"



Aluminum bits  
are replaceable

### Power Groovers

- Cuts sharp, clean grooves
- Comes with replaceable aluminum bits
- Broken in front and back
- Bits are curved in front and back

No.	Size	Bit	Radius	Width
CC380	9"x12"	3/4"	1/4"	5/8"
CC381	9"x12"	1"	1/4"	5/8"
CC382	9"x12"	1-1/2"	1/4"	5/8"

CC383 Set of (3) different size replacement bits



### Single Action Two-Way Walking Edgers



Add "01"  
after part number  
for edger less handle

Made of heavy gauge stainless steel, this tool is reinforced with electrically welded back plate to which the handle attachment is fastened. Handle can be tightened so it can be flipped from one side to the other. Comes with 5' wood handle.

No.	Size	Radius	Lip
CC244	8"x4"	1/2"	5/8"
CC241	10"x6"	3/8"	1/2"
CC242	10"x6"	1/2"	5/8"
CC243	10"x10"	1/2"	5/8"
CC245	10"x10"	1/8"	1/2"

### Stainless Steel Hand Groover

- Special polished stainless steel for extra smooth working surface
- Turned up ends to prevent gouging.



#### Choice of Handle

No.	Wood	ProForm®	Size	Radius	Width
CF599	CF599PF	6"x6"	1/2"	1/2"	

### Stainless Steel Walking Groover

- 360 Degree swivel bracket
- 54" wood handle
- Turned up ends

CC599	6"x6"	1/2"	1/2"
-------	-------	------	------

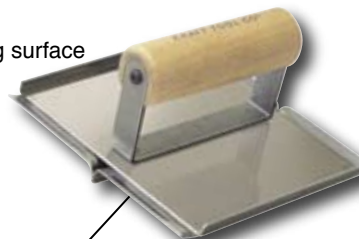

Turned up ends to  
prevent gouging!

### Wood Handles

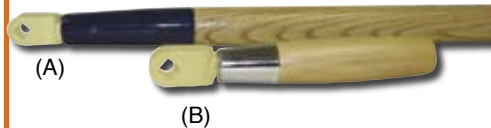

(A)

(B)

#### (A) for L.H. Bronze & SS Tools

No.	Handle
CC386	5' Wood handle with steel clevis
CC266	6' Wood handle with steel clevis

#### (B) Short Clevis Wood Handle

This clevis handle attaches to long handled tools so they can be used as hand tools.

No.	Handle
CC299	6" Wood handle with steel clevis

### All Angle Walking Edgers

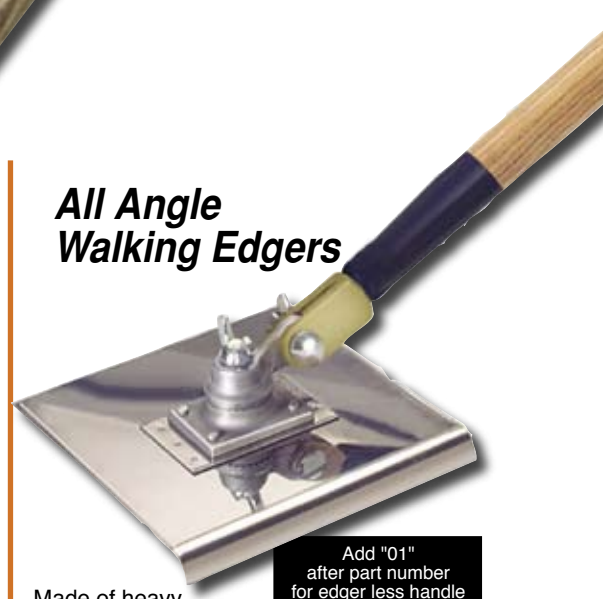

Add "01"  
after part number  
for edger less handle

Made of heavy gauge stainless steel, this tool is reinforced with an electrically welded back plate to which the all angle attachment is fastened. No rivets breakup, completely smooth face. Comes with 5' wood handle.

No.	Size	Radius
CC168	8"x4"	1/4" with 3/8" lip
CC167	8"x4"	3/8" with 1/2" lip
CC120	8"x4"	1/2" with 5/8" lip
CC121	8"x4"	3/4" with 7/8" lip

CC101	8"x6"	1/4" with 3/8" lip
CC102	8"x6"	3/8" with 1/2" lip
CC103	8"x6"	1/2" with 5/8" lip
CC104	8"x6"	3/4" with 7/8" lip

CC123	8"x8"	1/4" with 3/8" lip
CC124	8"x8"	3/8" with 1/2" lip
CC108	8"x8"	1/2" with 5/8" lip
CC109	8"x8"	3/4" with 7/8" lip

CC125	10"x6"	1/2" with 5/8" lip
CC126	10"x6"	3/4" with 7/8" lip
CC127	10"x10"	3/8" with 1/2" lip
CC128	10"x10"	1/2" with 5/8" lip
CC129	10"x10"	3/4" with 7/8" lip

CC122	6"x2-3/4"	3/8" with 1/2" lip
CC371	10"x3"	3/8" with 3/4" lip
CC370	10"x6"	3/8" with 1/2" lip
CC365	10"x6"	3/8" with 3/4" lip
CC366	10"x10"	1/8" with 3/4" lip

### Walking Edgers with Handle Socket Bracket

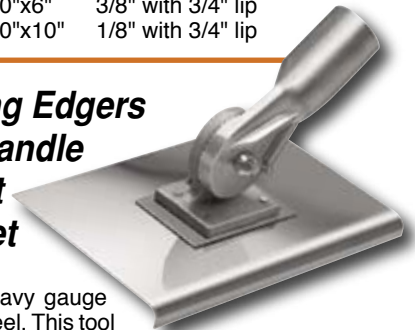

Made of heavy gauge stainless steel. This tool is reinforced with electrically welded back plate to which the handle attachment is fastened. Handle socket can be tightened so you can flip it from one side to the other. Handle socket accepts threaded bull float extension handles.

No.	Size	Radius	Lip
CC350	10"x6"	3/8"	1/2"
CC351	8"x5"	3/8"	1/2"

## Hand Seamer/Groovers

### Stainless Steel

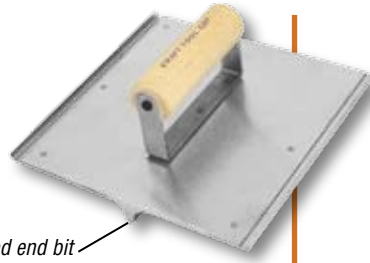

closed end bit

#### Hand Seamer

Seamer makes smooth control joints. No rivets. **Special hand polished stainless steel** for extra smooth working surface.

#### Choice of Handle



No.	Wood	ProForm®	Size	Radius	Groove
CF019	CF019PF		8"x5"	3/8"	5/8"
CF023	CF023PF		8"x5"	1/2"	3/4"
CF027	CF027PF		8"x5"	3/4"	7/8"
CF025	CF025PF		8"x8"	3/8"	1/2"
CF040	CF040PF		8"x8"	3/8"	5/8"
CF026	CF026PF		8"x8"	1/2"	3/4"
CF021	CF021PF		8"x8"	3/4"	7/8"
CF029	CF029PF		10"x10"	3/4"	7/8"

## Walking Seamer/Groover

### Stainless Steel

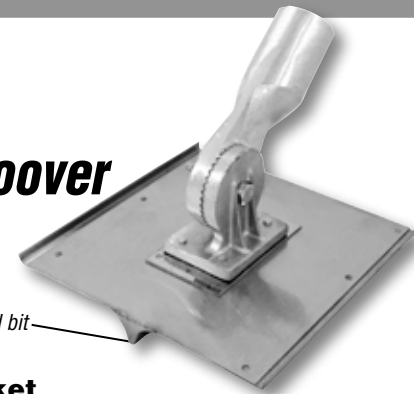

closed end bit

#### Walking Seamer w/ Handle Socket Bracket

Seamer makes smooth control joints. No rivets. **Special hand polished stainless steel** for extra smooth working surface.

No.	Size	Radius	Groove
CC025	8"x8"	3/8"	1/2"
CC040	8"x8"	3/8"	5/8"
CC026	8"x8"	1/2"	3/4"
CC027	8"x8"	3/4"	7/8"
CC024	9"x7"	3/4"	7/8"
CC028	10"x10"	1/4"	1/2"
CC030	10"x10"	1/2"	3/4"
CC029	10"x10"	3/4"	7/8"

## Hand Edger

**Special hand polished stainless steel** for extra smooth working surface.



#### Choice of Handle



No.	Wood	ProForm®	Size	Radius	Lip
CF039	CF039PF		8"x8"	1/4"	1/2"
CF035	CF035PF		8"x8"	1/2"	3/4"
CF038	CF038PF		8"x8"	3/4"	7/8"

## Walking Seamer/Edger

#### Walking Edger w/ Handle socket Bracket

**Special hand polished stainless steel**

for extra smooth working surface.

No.	Size	Radius	Lip
CC031	8"x8"	1/4"	1/2"
CC039	8"x8"	3/8"	1/2"
CC023	8"x8"	3/8"	5/8"
CC035	8"x8"	1/2"	3/4"
CC038	8"x8"	3/4"	7/8"
CC032	9"x7"	3/8"	1/2"
CC033	9"x7"	1/2"	3/4"
CC036	9"x7"	3/4"	7/8"
CC037	10"x10"	1/2"	3/4"



## 12"x5" Edgers with Adjustable Groover

#### Stainless Steel

Includes 54" (CC386) hardwood handle.

Fitted with 360 degree all-angle bracket



No.	Radius	Bit	No.	Radius	Bit
CC600	3/8"	3/4"	CC607	3/8"	1/2"
CC601	3/8"	1"	CC609	3/8"	1/4"
CC602	1/2"	3/4"	CC611	1/2"	1/2"
CC603	1/2"	1"	CC613	1/2"	1/4"
CC604	3/4"	3/4"	CC615	3/4"	1/2"
CC605	3/4"	1"	CC617	3/4"	1/4"

Heavy gauge stainless steel. Groover is adjustable and locks in place. Accepts one or more fresno groover bits for making parallel grooves. Extra groover bits on page 16.

#### Stainless Steel



Fitted with comfortable hardwood handle.

No.	Radius	Bit	No.	Radius	Bit
CF600	3/8"	3/4"	CF607	3/8"	1/2"
CF601	3/8"	1"	CF609	3/8"	1/4"
CF602	1/2"	3/4"	CF611	1/2"	1/2"
CF603	1/2"	1"	CF613	1/2"	1/4"
CF604	3/4"	3/4"	CF615	3/4"	1/2"
CF605	3/4"	1"	CF617	3/4"	1/4"

## Western Groover

- Popular on commercial jobs
- Cuts grooves 3/16"x3/16"
- Blade 2" wide, 3" long

No. CF402

Stainless Steel

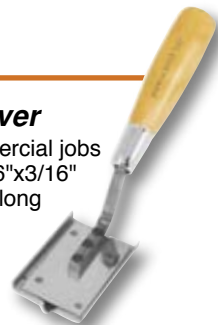

## Single Edger w/ Groover



- Makes smooth clean joints while edging
- Made of heavy gauge stainless steel
- Closed end bit

No.	Size	Bit	Radius
CC663	8"x6" w/ 2" Shiner	3/4"	1/2"
CC664	8"x6" w/ 2" Shiner	7/8"	3/4"



Sidewalk & Highway Edgers



ProForm® Handle

STAINLESS STEEL

6" Long Sidewalk Edgers

No.	Width	Radius	Lip
CF161PF	1-1/2"	1/4"	3/8"
CF160PF	2"	3/8"	1/2"
CF162PF	2-1/2"	1/4"	3/8"
CF170PF	3"	1/8"	1/4"
CF163PF	3"	1/4"	3/8"
CF092PF	3"	3/8"	1/2"
CF164PF	3-1/2"	3/8"	1/2"
CF171PF	4"	1/8"	1/4"
CF172PF	4"	1/4"	3/8"
CF173PF	4"	3/8"	1/2"
CF165PF	4"	1/2"	5/8"
CF907PF	4"	5/8"	3/4"
CF174PF	4"	3/4"	1"
CF136PF	6"	1/8"	1/4"
CF137PF	6"	1/4"	3/8"
CF138PF	6"	3/8"	1/2"
CF175PF	6"	1/2"	5/8"
CF139PF	6"	3/4"	1"
CF912PF	6"	5/8"	3/4"
CF908PF	6"	1"	1-1/4"

8" Long Sidewalk Edgers

CF169PF	4"	1/8"	1/4"
CF168PF	4"	1/4"	3/8"
CF167PF	4"	3/8"	1/2"
CF166PF	4"	1/2"	5/8"
CF185PF	4"	3/4"	1"
CF127PF	5"	1/4"	3/8"
CF128PF	5"	3/8"	1/2"
CF129PF	5"	1/2"	5/8"
CF130PF	5"	3/4"	1"
CF100PF	6"	1/8"	1/4"
CF101PF	6"	1/4"	3/8"
CF102PF	6"	3/8"	1/2"
CF103PF	6"	1/2"	5/8"
CF104PF	6"	3/4"	1"
CF105PF	8"	1/8"	1/4"
CF106PF	8"	1/4"	3/8"
CF107PF	8"	3/8"	1/2"
CF108PF	8"	1/2"	5/8"
CF109PF	8"	3/4"	1"

9" Long Sidewalk Edgers

CF155PF	2-1/2"	1/2"	5/8"
CF176PF	3"	1/2"	5/8"
CF188PF	4"	1/2"	5/8"
CF189PF	4"	3/4"	1"
CF190PF	5"	3/8"	1/2"
CF191PF	5"	1/2"	5/8"
CF241PF	6"	1-1/2"	2"

10" Long Sidewalk Edgers

CF158PF	3-1/2"	1/4"	3/8"
CF159PF	4"	3/8"	1/2"
CF154PF	4"	1"	1-1/4"
CF140PF	4"	1-1/2"	2"
CF909PF	6"	1/4"	3/8"
CF320PF	6"	3/8"	1/2"
CF321PF	6"	1/2"	5/8"
CF906PF	6"	5/8"	3/4"
CF322PF	6"	3/4"	1"
CF323PF	6"	1"	1-1/4"
CF240PF	6"	1-1/2"	2"
CF143PF	5-3/4"	2"	2-5/8"
CF144PF	6-1/4"	3"	3-1/4"



Wood Handle

STAINLESS STEEL

6" Long Sidewalk Edgers

No.	Width	Radius	Lip
CF161	1-1/2"	1/4"	3/8"
CF160	2"	3/8"	1/2"
CF162	2-1/2"	1/4"	3/8"
CF170	3"	1/8"	1/4"
CF163	3"	1/4"	3/8"
CF092	3"	3/8"	1/2"
CF164	3-1/2"	3/8"	1/2"
CF171	4"	1/8"	1/4"
CF172	4"	1/4"	3/8"
CF173	4"	3/8"	1/2"
CF165	4"	1/2"	5/8"
CF907	4"	5/8"	3/4"
CF174	4"	3/4"	1"
CF136	6"	1/8"	1/4"
CF137	6"	1/4"	3/8"
CF138	6"	3/8"	1/2"
CF175	6"	1/2"	5/8"
CF139	6"	3/4"	1"
CF912	6"	5/8"	3/4"
CF908	6"	1"	1-1/4"

8" Long Sidewalk Edgers

CF169	4"	1/8"	1/4"
CF168	4"	1/4"	3/8"
CF167	4"	3/8"	1/2"
CF166	4"	1/2"	5/8"
CF185	4"	3/4"	1"
CF127	5"	1/4"	3/8"
CF128	5"	3/8"	1/2"
CF129	5"	1/2"	5/8"
CF130	5"	3/4"	1"
CF100	6"	1/8"	1/4"
CF101	6"	1/4"	3/8"
CF102	6"	3/8"	1/2"
CF103	6"	1/2"	5/8"
CF104	6"	3/4"	1"
CF105	8"	1/8"	1/4"
CF106	8"	1/4"	3/8"
CF107	8"	3/8"	1/2"
CF108	8"	1/2"	5/8"
CF109	8"	3/4"	1"

9" Long Sidewalk Edgers

CF155	2-1/2"	1/2"	5/8"
CF176	3"	1/2"	5/8"
CF188	4"	1/2"	5/8"
CF189	4"	3/4"	1"
CF190	5"	3/8"	1/2"
CF191	5"	1/2"	5/8"
CF241	6"	1-1/2"	2"

10" Long Sidewalk Edgers

CF158	3-1/2"	1/4"	3/8"
CF159	4"	3/8"	1/2"
CF154	4"	1"	1-1/4"
CF140	4"	1-1/2"	2"
CF909	6"	1/4"	3/8"
CF320	6"	3/8"	1/2"
CF321	6"	1/2"	5/8"
CF906	6"	5/8"	3/4"
CF322	6"	3/4"	1"
CF323	6"	1"	1-1/4"
CF240	6"	1-1/2"	2"
CF143	5-3/4"	2"	2-5/8"
CF144	6-1/4"	3"	3-1/4"



Plastic Handle

STAINLESS STEEL

6" Long Sidewalk Edgers

No.	Width	Radius	Lip
CF161P	1-1/2"	1/4"	3/8"
CF160P	2"	3/8"	1/2"
CF162P	2-1/2"	1/4"	3/8"
CF170P	3"	1/8"	1/4"
CF163P	3"	1/4"	3/8"
CF092P	3"	3/8"	1/2"
CF164P	3-1/2"	3/8"	1/2"
CF171P	4"	1/8"	1/4"
CF172P	4"	1/4"	3/8"
CF173P	4"	3/8"	1/2"
CF165P	4"	1/2"	5/8"
CF907P	4"	5/8"	3/4"
CF174P	4"	3/4"	1"
CF136P	6"	1/8"	1/4"
CF137P	6"	1/4"	3/8"
CF138P	6"	3/8"	1/2"
CF175P	6"	1/2"	5/8"
CF139P	6"	3/4"	1"
CF912P	6"	5/8"	3/4"
CF908P	6"	1"	1-1/4"

8" Long Sidewalk Edgers

CF169P	4"	1/8"	1/4"
CF168P	4"	1/4"	3/8"
CF167P	4"	3/8"	1/2"
CF166P	4"	1/2"	5/8"
CF185P	4"	3/4"	1"
CF127P	5"	1/4"	3/8"
CF128P	5"	3/8"	1/2"
CF129P	5"	1/2"	5/8"
CF130P	5"	3/4"	1"
CF100P	6"	1/8"	1/4"
CF101P	6"	1/4"	3/8"
CF102P	6"	3/8"	1/2"
CF103P	6"	1/2"	5/8"
CF104P	6"	3/4"	1"
CF105P	8"	1/8"	1/4"
CF106P	8"	1/4"	3/8"
CF107P	8"	3/8"	1/2"
CF108P	8"	1/2"	5/8"
CF109P	8"	3/4"	1"

9" Long Sidewalk Edgers

CF155P	2-1/2"	1/2"	5/8"
CF176P	3"	1/2"	5/8"
CF188P	4"	1/2"	5/8"
CF189P	4"	3/4"	1"
CF190P	5"	3/8"	1/2"
CF191P	5"	1/2"	5/8"
CF241P	6"	1-1/2"	2"

10" Long Sidewalk Edgers

CF158P	3-1/2"	1/4"	3/8"
CF159P	4"	3/8"	1/2"
CF154P	4"	1"	1-1/4"
CF140P	4"	1-1/2"	2"
CF909P	6"	1/4"	3/8"
CF320P	6"	3/8"	1/2"
CF321P	6"	1/2"	5/8"
CF906P	6"	5/8"	3/4"
CF322P	6"	3/4"	1"
CF323P	6"	1"	1-1/4"
CF240P	6"	1-1/2"	2"
CF143P	5-3/4"	2"	2-5/8"
CF144P	6-1/4"	3"	3-1/4"

Available in Three Handle Styles

Stainless Steel

Stainless Steel



**Universal Groover**

- Popular among concrete finishers
- Rivet-free
- 6"x3" blade cuts 1/2"x1/2" groove

**Choice of Handle**



No.	Wood	ProForm®	Size	Bit
CF118	CF118PF	6"x3"	1/2" wide/deep	
<b>JUMBO GROOVER</b>				
CF119	CF119PF	6"x4-3/4"	Bit 3/8" wide, 1/2" deep	

**Curved End Edgers**

- Edgers have turned up ends to prevent gouging of concrete
- Edger radius 1/4"
- Your choice of wood, plastic or ProForm® handle

**3 Handle Choices!**

No.	Size/Handle	Stainless Steel
CF141	6"x3" Wood	
CF141P	6"x3" Plastic	
CF141PF	6"x3" ProForm®	
CF142	6"x2-1/2" Wood	
CF142P	6"x2-1/2" Plastic	
CF142PF	6"x2-1/2" ProForm®	



**Choice of Handle**



**Universal Walking Groover**

- Rivet-free
- 6"x3" blade cuts 1/2"x1/2" groove

No.	Size	Bit
CC089	6"x3"	1/2" wide/deep w/ 5' wood handle

Add "01" to Part No. for groover less handle.

**Stainless Steel Safety Step Edger**

- Popular on commercial jobs
- Cuts four grooves while edging the step
- Grooves 3/4" on center

**Choice of Handle**



Size 6"x4-1/2"

No.	Wood	ProForm®	Bit	Radius
CF112	CF112PF	1/4" deep	1/2"	



Stainless Steel



**Stainless Steel Driveway Safety Groover**

- Heavy-duty stainless steel
- Guide lip on each side
- Grooves 3/4" on center

**Choice of Handle**

No.	Wood	ProForm®	Size	Bit
CF131	CF131PF	6"x6"	1/4" deep	

**Deep Bit Hand Groover** Stainless Steel

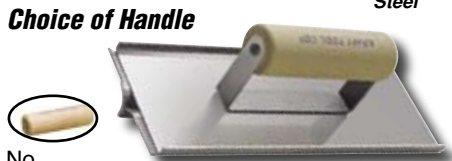

No.	Wood	Size	Bit	Radius
CF110	10"x3-1/2"	1/2" deep	3/8"	
CF117	6"x6"	2" deep	1/4"	
CF116	6"x6"	1-1/2" deep	1/4"	
CF115	6"x6"	1" deep	1/4"	



No.	ProForm®	Size	Bit	Radius
CF110PF	10"x3-1/2"	1/2" deep	3/8"	
CF117PF	6"x6"	2" deep	1/4"	
CF116PF	6"x6"	1-1/2" deep	1/4"	
CF115PF	6x6"	1" deep	1/4"	

**Texas Curb Ramp Groover**

- Stainless steel
- Cuts safety grooves in non-skid areas
- 2" wide groove spacing, 1/4" deep and 3/4" wide bit

**Choice of Handle**



No.	Wood	ProForm®	Size
CF094	CF094PF	7-5/8"x6"	(3 grooves)
CF095	CF095PF	10-3/8"x8"	(4 grooves)
<b>WALKING GROOVER w/ threaded hdl brkt</b>			
CC094		7-5/8"x6"	(3 grooves)
CC095		10-3/8"x8"	(4 grooves)



**Stainless Steel Hand Edger-Groover**

- Handy tool for most commercial jobs
- Forms top of curb and cuts grooves in one pass

**Choice of Handle**

No.	Wood	ProForm®	Size	Radius	Groove
CF034	CF034PF	6"x8"	3/8"	1/4"	
CF149	CF149PF	6"x8"	3/4"	1/4"	
CF044	CF044PF	6"x10"	3/4"	1/4"	
CF045	CF045PF	6"x12"	3/4"	1/4"	
CF046	CF046PF	6"x8"	1/2"	1/4"	

**WALKING EDGER-GROOVER**

CC034	6"x8"	3/8"	1/4"
CC149	6"x8"	3/4"	1/4"

Comes with all-angle bracket and 5' wood handle.

**Curb Ramp Groover**

**Choice of Handle**

- 2" on center, 1-1/4" wide groove spacing, bit 1/4" deep, 3/4" wide

Wood	ProForm®	Size
CF525	CF525PF	6"x5" (3 grooves)

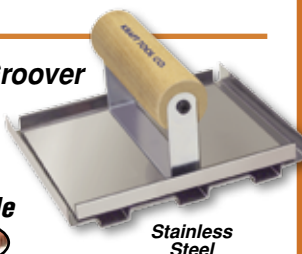

**Stainless Steel Wheelchair Hand Groover**

- Cuts safety grooves for wheelchair ramps and non-skid areas
- Popular for most commercial and government jobs
- Grooves on 2-1/4" centers

**Choice of Handle**

No.	Wood	ProForm®	Size	Bit
CF093	CF093PF	8"x10-1/2"	1/4" deep	
<b>WALKING GROOVER</b>				
CC093	8"x10-1/2"	1/4" wide, 1/4" deep		

• Comes with threaded handle bracket



**Curb Ramp Groover**

- 2" on center, bit 1/4" deep, 1/4" wide

No.	Wood	ProForm®	Size
CF918	CF918PF	7-1/2"x6"	(4 grooves)
CF919	CF919PF	10"x6"	(5 grooves)
<b>WALKING GROOVER w/ threaded hdl brkt</b>			
CC918		7-1/2"x6"	(4 grooves)
CC919		10"x6"	(5 grooves)

# Flexible Blue Steel Edgers

3 Handle Choices...



Available with our NEW... Soft Grip ProForm® Handle



Wood Handle



Plastic Handle

- ✓ Tempered crucible spring steel
- ✓ Flexible lightweight blade
- ✓ "Gives" for just the right feel when working
- ✓ 3 solid rivets

## Blue Steel Edgers

### With ProForm® Handle

No.	Size	Radius
CF566PF	6"x3"	1/8"
CF568PF	6"x3"	1/4"
CF569PF	6"x3"	3/8"
CF570PF	6"x3"	1/2"
CF565PF	6"x3"	3/4"
CF567PF	6"x4"	1/8"
CF572PF	6"x4"	1/4"
CF573PF	6"x4"	3/8"
CF574PF	6"x4"	1/2"
CF562PF	6"x4"	5/8"
CF571PF	6"x4"	3/4"
CF675PF	6"x4"	1"
CF579PF	6"x6"	1/8"
CF575PF	6"x6"	1/4"
CF576PF	6"x6"	3/8"
CF577PF	6"x6"	1/2"
CF563PF	6"x6"	5/8"
CF578PF	6"x6"	3/4"
CF564PF	6"x6"	1"
CF670PF	6"x5-1/2"	1/8"
CF671PF	6"x5-1/2"	1/4"
CF672PF	6"x5-1/2"	3/8"
CF673PF	6"x5-1/2"	1/2"
CF674PF	6"x5-1/2"	3/4"
CF595PF	9"x6"	1/4"
CF596PF	9"x6"	3/8"
CF597PF	9"x6"	1/2"
CF598PF	9"x6"	3/4"

## Blue Steel Edgers

### With Wood Handle

No.	Size	Radius
CF566	6"x3"	1/8"
CF568	6"x3"	1/4"
CF569	6"x3"	3/8"
CF570	6"x3"	1/2"
CF565	6"x3"	3/4"
CF567	6"x4"	1/8"
CF572	6"x4"	1/4"
CF573	6"x4"	3/8"
CF574	6"x4"	1/2"
CF562	6"x4"	5/8"
CF571	6"x4"	3/4"
CF675	6"x4"	1"
CF579	6"x6"	1/8"
CF575	6"x6"	1/4"
CF576	6"x6"	3/8"
CF577	6"x6"	1/2"
CF563	6"x6"	5/8"
CF578	6"x6"	3/4"
CF564	6"x6"	1"
CF670	6"x5-1/2"	1/8"
CF671	6"x5-1/2"	1/4"
CF672	6"x5-1/2"	3/8"
CF673	6"x5-1/2"	1/2"
CF674	6"x5-1/2"	3/4"
CF595	9"x6"	1/4"
CF596	9"x6"	3/8"
CF597	9"x6"	1/2"
CF598	9"x6"	3/4"

## Blue Steel Edgers

### With Plastic Handle

No.	Size	Radius
CF566P	6"x3"	1/8"
CF568P	6"x3"	1/4"
CF569P	6"x3"	3/8"
CF570P	6"x3"	1/2"
CF565P	6"x3"	3/4"
CF567P	6"x4"	1/8"
CF572P	6"x4"	1/4"
CF573P	6"x4"	3/8"
CF574P	6"x4"	1/2"
CF562P	6"x4"	5/8"
CF571P	6"x4"	3/4"
CF675P	6"x4"	1"
CF579P	6"x6"	1/8"
CF575P	6"x6"	1/4"
CF576P	6"x6"	3/8"
CF577P	6"x6"	1/2"
CF563P	6"x6"	5/8"
CF578P	6"x6"	3/4"
CF564P	6"x6"	1"
CF670P	6"x5-1/2"	1/8"
CF671P	6"x5-1/2"	1/4"
CF672P	6"x5-1/2"	3/8"
CF673P	6"x5-1/2"	1/2"
CF674P	6"x5-1/2"	3/4"
CF595P	9"x6"	1/4"
CF596P	9"x6"	3/8"
CF597P	9"x6"	1/2"
CF598P	9"x6"	3/4"

with 54" hardwood handle

Special angle bracket for increased tilt action

## Two-Way Blue Steel Walking Edgers

The edger blade "gives" a little for just the right feel when working.

No.	Size	Radius	No.	Size	Radius
CC390	9"x4"	1/4"	CC397	9"x10"	1/4"
CC391	9"x4"	3/8"	CC398	9"x10"	3/8"
CC392	9"x4"	1/2"	CC399	9"x10"	1/2"
CC393	9"x6"	1/4"	CC400	9"x10"	3/4"
CC394	9"x6"	3/8"	CC401	9"x14"	1/4"
CC395	9"x6"	1/2"	CC402	9"x14"	3/8"
CC396	9"x6"	3/4"	CC403	9"x14"	1/2"
CC384	9"x8"	1/4"	CC404	9"x14"	3/4"
CC385	9"x8"	3/8"			
CC387	9"x8"	1/2"			
CC388	9"x8"	3/4"			

CC656 54" Hardwood replacement handle

Add "01" to Part No. for edger less handle.

## Blue Steel Chamfer Tool

- Professional quality tool
- Formed to fit exact contour

### Choice of Handle

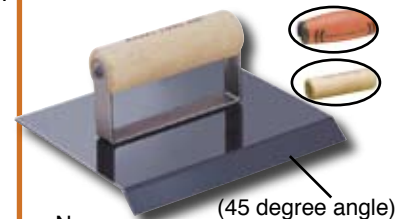

(45 degree angle)

No.	Wood	ProForm®	Size	Lip
CF523	CF523PF		6"x8"	3/4"
CF594	CF594PF		9"x6"	3/4"

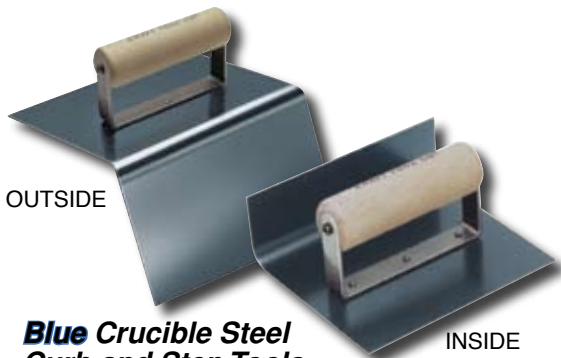

OUTSIDE

INSIDE

### Blue Crucible Steel Curb and Step Tools

- Made of blue crucible spring steel
- Provides just the right feel and flex for a professional finish.

#### Curb Tools - Outside

##### Choice of Handle



No.	Wood	ProForm®	Size	Lip	Radius	Batter
CF580	CF580PF		9"x5"	5"	1/2"	1-1/2" at 6"
CF581	CF581PF		9"x5"	5"	3/4"	1-1/2" at 6"

#### Step Tools - Inside

Wood	ProForm®	Size	Lip	Radius	Batter
CF515	CF515PF	6"x4"	3"	1"	
CF516	CF516PF	6"x6"	3"	1"	

### Blue Crucible Steel Junior Step Tools

- Made of blue crucible spring steel
- Provides just the right feel and flex for a professional finish

##### Choice of Handle



OUTSIDE					
No.	Wood	ProForm®	Size	Lip	Radius
CF517	CF517PF		6" x5"	2"	1/2"

INSIDE					
No.	Wood	ProForm®	Size	Lip	Radius
CF518	CF518PF		6" x5"	2"	1/2"

##### (INSIDE & OUTSIDE) PAIR

No.					
Wood	ProForm®	Size	Lip	Radius	Batter
CF519	CF519PF	6" x5"	2"	1/2"	

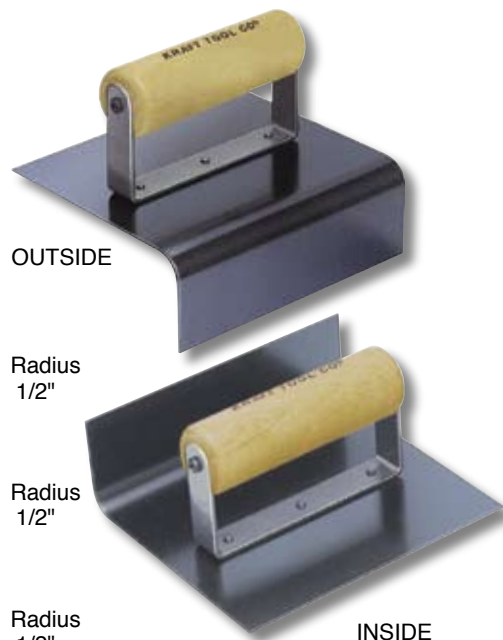

OUTSIDE

INSIDE

### Blue Crucible Steel Step Tools

- Tempered crucible spring steel
- Blade is very flexible and lightweight
- Available with or without batter

##### Choice of Handle

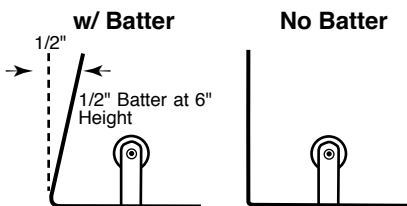

#### INSIDE STEP TOOL

No.	Wood	ProForm®	Size	Lip	Radius	Batter
CF584	CF584PF		7"x6"	6"	1/4"	1/2" at 6"
CF760	CF760PF		7"x6"	6"	1/4"	No Batter
CF585	CF585PF		7"x6"	6"	3/8"	1/2" at 6"
CF761	CF761PF		7"x6"	6"	3/8"	No Batter
CF586	CF586PF		7"x6"	6"	1/2"	1/2" at 6"
CF762	CF762PF		7"x6"	6"	1/2"	No Batter
CF587	CF587PF		7"x6"	6"	3/4"	1/2" at 6"
CF763	CF763PF		7"x6"	6"	3/4"	No Batter
CF588	CF588PF		7"x6"	6"	1"	1/2" at 6"
CF764	CF764PF		7"x6"	6"	1"	No Batter

#### OUTSIDE STEP TOOL

No.	Wood	ProForm®	Size	Lip	Radius	Batter
CF589	CF589PF		6"x6"	3-1/2"	1/4"	1/2" at 6"
CF767	CF767PF		6"x6"	3-1/2"	1/4"	No Batter
CF590	CF590PF		6"x6"	3-1/2"	3/8"	1/2" at 6"
CF768	CF768PF		6"x6"	3-1/2"	3/8"	No Batter
CF591	CF591PF		6"x6"	3-1/2"	1/2"	1/2" at 6"
CF769	CF769PF		6"x6"	3-1/2"	1/2"	No Batter
CF592	CF592PF		6"x6"	3-1/2"	3/4"	1/2" at 6"
CF770	CF770PF		6"x6"	3-1/2"	3/4"	No Batter
CF593	CF593PF		6"x6"	3-1/2"	1"	1/2" at 6"
CF771	CF771PF		6"x6"	3-1/2"	1"	No Batter

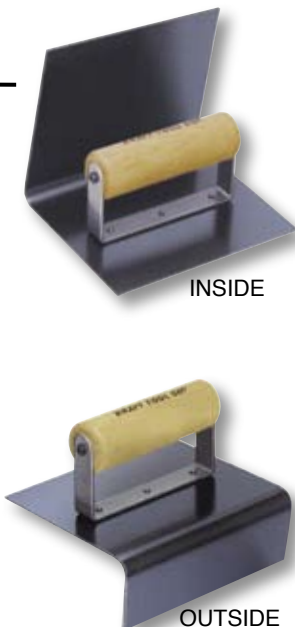

INSIDE

OUTSIDE

### Two-Way Blue Steel Walking Step Tools



INSIDE STEP TOOL

OUTSIDE STEP TOOL

- Tempered crucible spring steel
- Blade is very flexible and lightweight
- Comes with heavy-duty (CC656) 54" clevis handle

INSIDE STEP TOOL			
No.	Size	Lip	Radius
CC586	7"x6"	3"	1/2"
OUTSIDE STEP TOOL			
No.	Size	Lip	Radius
CC590	6"x6"	3-1/2"	3/8"
CC591	6"x6"	3-1/2"	1/2"

Add "01" to Part No. for edger less handle



# Chamfer Tools *Stainless Steel*

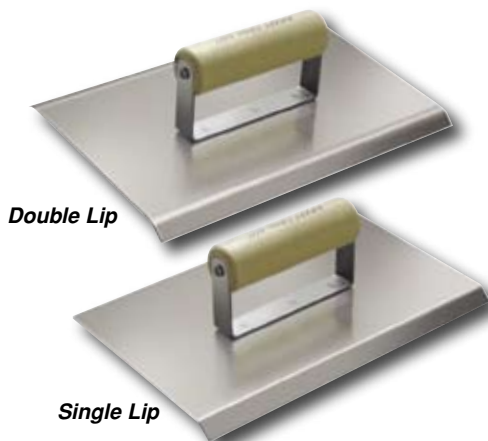

Double Lip

Single Lip

## Double Lip Chamfer Tool

- Professional quality tool
- **Double** chamfer sides for forming and finishing edges of walls
- Overall width 7-3/4"

### Choice of Handle



No.	Wood	ProForm®	Size	Lip
CF522	CF522PF		9"x7-3/4"	1/2"

## Single Lip Chamfer Tool

No.	Wood	ProForm®	Size	Lip
CF132	CF132PF		10"x6"	1/2"
CF134	CF134PF		10"x6"	3/4"



Narrow Edger

Chamfer Edger

## Stainless Steel Narrow Edger

- Made of stainless steel
- Perfect for those narrow or hard to get at finishing jobs

### Choice of Handle



No.	Wood	ProForm®	Size	Radius
CF111	CF111PF		6"x1"	1/4"
CF113	CF113PF		6"x1"	3/8"
CF114	CF114PF		6"x1"	1/2"
CF120	CF120PF		6"x1"	3/4"

## Stainless Steel Chamfer Edger

No.	Wood	ProForm®	Size	Lip
CF199	CF199PF		6"x1"	3/4"



## Walking Chamfer Tool

- Made of the finest stainless steel
- Made especially for the tilt up and concrete slab work
- Comes with 5' wood handle

No.	Size	Lip
CC342	9"x6"	1/2"
CC345	9"x6"	3/4"
CC349	9"x6"	1"

## Carpet Edger



Lip angle 45 degrees

- Made of high quality rivet free stainless steel
- Designed to fit exact contour

### Choice of Handle



No.	Wood	ProForm®	Size	Lip
CF089	CF089PF		6"x3"	3/16"
CF090	CF090PF		6"x4"	3/16"
CF091	CF091PF		6"x6"	3/16"

## Wall Capping Tool



- Made of heavy gauge stainless steel
- Ideal for rounding concrete on top of walls

### Choice of Handle



No.	Wood	ProForm®	Size
CF520	CF520PF		6-9/16"x9" (6" wall)
CF521	CF521PF		8-7/8"x9" (8" wall)

## Stainless Steel Edger with Float Handle



- Made of high quality rivet free stainless steel
- Designed to fit exact contour

No.	Wood	ProForm®	Size	Radius
CF900	CF900PF		10"x6"	1/4"
CF901	CF901PF		10"x6"	3/8"
CF902	CF902PF		10"x6"	1/2"
CF903	CF903PF		10"x6"	5/8"
CF904	CF904PF		10"x6"	3/4"
CF905	CF905PF		10"x6"	1"

## Adjustable Winged Groover

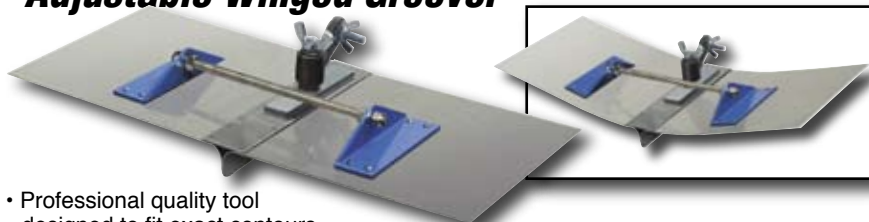

- Professional quality tool designed to fit exact contours
- Wings adjust up to fit contour of job
- Use with clevis handle or adapter for bull float handles (Handles ordered separately)
- Made of high quality stainless steel

No.	Size	Bit Depth	Bit Width	Bit Radius
CC734	20"x9"	1-1/4"	1"	1/2"

Order handles and adapters separately.



### Curb & Gutter Tools

- Stainless steel and rivet free
- Formed to fit the exact contour

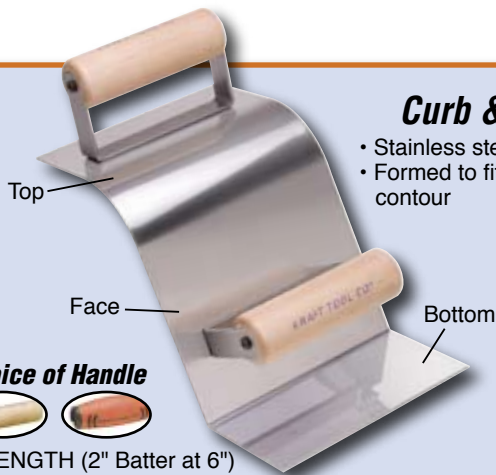

#### Choice of Handle



6" LENGTH (2" Batter at 6")

No.

**Wood**

Size

CF513 4" Top, 6" Face, 3" Bottom  
2" Radius curb, 90 Degree gutter

**ProForm®**

CF513PF 4" Top, 6" Face, 3" Bottom  
2" Radius curb, 90 Degree gutter

#### Choice of Handle



6" LENGTH (2" Batter at 6")

No.

**Wood**

Size

CF514 4" Top, 6" Face  
2" Radius curb

**ProForm®**

CF514PF 4" Top, 6" Face  
2" Radius curb

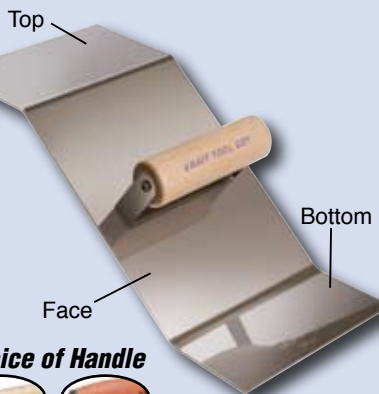

#### Choice of Handle



6" LENGTH (8" Batter at 6-1/2")

No.

**Wood**

**ProForm®**

CF651 4" Top, 8" Face, 2-3/4" Bottom  
3/4" Radius curb & gutter

#### Choice of Handle



6" LENGTH (1-1/2" Batter at 6")

No.

**Wood**

**ProForm®**

Size

CF650 4-1/4" Top, 6" Face, 4" Bottom,  
1-1/2" Radius curb & gutter



### Curb & Gutter Walking Tool

6" LENGTH (1-1/2" Batter at 6")

No.

Size

CC961 4-1/4" Top, 6" Face,  
4" Bottom,  
1-1/2" Radius curb & gutter  
w/ 5' wood handle

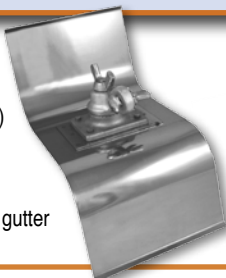

### Curb & Gutter Walking Tool

6" LENGTH (2" Batter at 6")

No.

Size

CC962 6" Top, 6" Face,  
6" Bottom, 2" Radius curb,  
3" Radius gutter  
w/ 5' wood handle

#### Choice of Handle



### Curb Tool (Stainless Steel)

No.

**Wood**

**ProForm®**

Radius

CF193 CF193PF 2"  
CF195 CF195PF 3"  
CF197 CF197PF 1-1/2"

### Gutter Tool (Stainless Steel)

CF198 CF198PF 1-1/2"  
CF196 CF196PF 2"  
CF194 CF194PF 3"

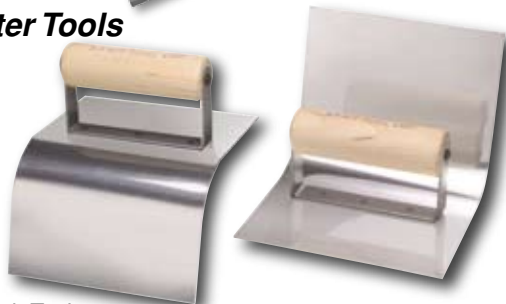

Curb Tool  
Length 6" Width 5"

Gutter Tool  
Length 6" Width 4-1/2"

### Curb & Gutter Tools

Stainless steel and rivet free.  
Formed to fit the exact contour.

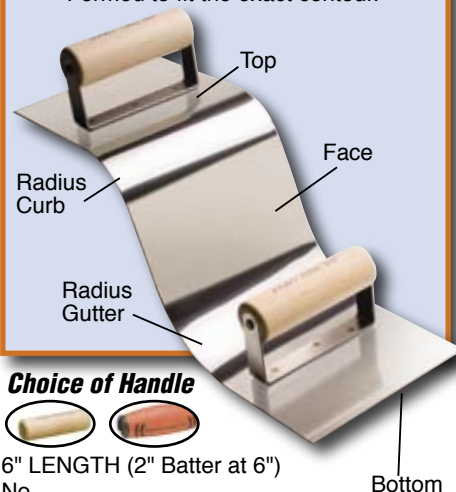

#### Choice of Handle



6" LENGTH (2" Batter at 6")

No.

**Wood**

Size

CF511 6" Top, 6" Face, 6" Bottom  
2" Radius curb, 3" Radius gutter  
CF512 6" Top, 6" Face, 6" Bottom  
3" Radius curb, 2" Radius gutter

**ProForm®**

CF511PF 6" Top, 6" Face, 6" Bottom  
2" Radius curb, 3" Radius gutter  
CF512PF 6" Top, 6" Face, 6" Bottom  
3" Radius curb, 2" Radius gutter

### Stainless Steel



#### Choice of Handle



6" LENGTH

No.

**Wood**

Size (Width)

Radius

CF097 5" Top, 4" Bottom 3/4", 1" drop  
CF098 5" Top, 4" Bottom 1/2", 1" drop  
CF099 5" Top, 4" Bottom 1", 1" drop

**ProForm®**

CF097PF 5" Top, 4" Bottom 3/4", 1" drop  
CF098PF 5" Top, 4" Bottom 1/2", 1" drop  
CF099PF 5" Top, 4" Bottom 1", 1" drop

### Hand Driveway Approach Tool

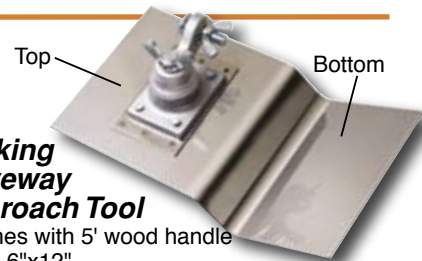

### Walking Driveway Approach Tool

- Comes with 5' wood handle
- Size 6"x12"

6" LENGTH

No.

Size (Width)

Radius

CC360 6" Top, 4" Bottom 1/2" with 1" drop  
CC361 6" Top, 6" Bottom 1/2" with 1" drop  
CC362 6" Top, 4" Bottom 3/4" with 1" drop  
CC363 6" Top, 6" Bottom 3/4" with 1" drop



**Step Tools (Stainless Steel)**

**Choice of Handle**



Matched pair of inside and outside step tools. 8"x4"x1/2" radius, 4" lip.

No.	Wood	ProForm®		Batter
CF177	CF177PF		Inside tool	1/2" (at 6")
CF178	CF178PF		Outside tool	1/2" (at 6")
CF179	CF179PF		Matched pair	1/2" (at 6")
CF180	CF180PF		Inside tool	No batter
CF181	CF181PF		Outside tool	No batter
CF182	CF182PF		Matched pair	No batter



**Sidewalk & Curb Tools (Stainless Steel)**

**Choice of Handle**



**OUTSIDE NOSE TOOL With 1-1/2" lip**

No.	Wood	ProForm®	Length	Width	Radius
CF146	CF146PF		6"	4"	1/2"
CF147	CF147PF		6"	4"	3/4"
CF148	CF148PF		6"	4"	1"
CF243	CF243PF		6"	4"	1-1/2" with 2" lip
CF242	CF242PF		6"	6"	1-1/2" with 2" lip

**INSIDE COVE TOOL With 1-1/2" lip**

CF157	CF157PF		6"	4"	1/2"
CF152	CF152PF		6"	4"	3/4"
CF153	CF153PF		6"	4"	1"



**SAFETY RAMP GROOVERS**

**Safety Ramp Groovers**

Ideal for cutting grooves in sidewalk safety ramps where water drainage and traction are critical. Use as a set of 3 (Left, Straight, and Right). Order by each part number for a complete set.

**Hand Groovers**

Left (45°) No.	Straight	Right (45°)	Groove Spacing
CF080	CF081	CF082	1-1/2"
CF083	CF084	CF085	3/4"
CF086	CF087	CF088	1"

**Walking Style (Swivel) Groovers**

CC080	CC081	CC082	1-1/2"
CC083	CC084	CC085	3/4"
CC086	CC087	CC088	1"

Left and Right Groovers dimensions: 13-1/2"x 5-1/2"

Straight Groover dimensions: 13"x 5-1/2"  
Groove depth and width 1/4"x1/4".

**Available in Hand or Walking Style Groovers**

Walking Style Groover handles use (CC386) clevis handle, page 40; or use adapters (Order separately) on page 11 for bull float handles.

**Step & Corner Tools**



**Choice of Handle**



**OUTSIDE NOSE TOOL**

No.	Wood	ProForm®	Length	Width	Radius
CF123	CF123PF		6"	2-1/2"	1/2"
CF125	CF125PF		6"	2-1/2"	1/4"
CF121	CF121PF		6"	2-1/2"	Square

**INSIDE COVE TOOL**

CF124	CF124PF		6"	2-1/2"	1/2"
CF126	CF126PF		6"	2-1/2"	1/4"
CF122	CF122PF		6"	2-1/2"	Square

**Two Radius Edger**



Stainless Steel 6"x6" edger with two radiuses (1-1/2" and 3/8" Radius). Fitted with our new ProForm® handle.  
No. CF606PF

# Decorative Concrete



### Deco Walking Groover

Made of quality stainless steel. Fitted with 360 degree all angle bracket. Rivet free. Comes with 5' wood handle

No. Size  
CC375 6"x12" 1-1/2" Radius with 1-3/4" Deep bit

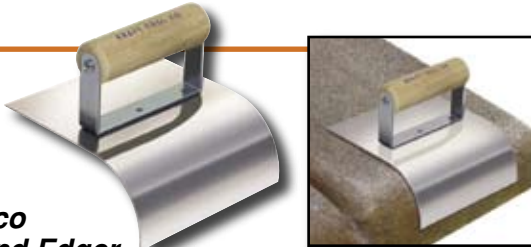

### Deco Hand Edger

Made of quality stainless steel. Fitted with smooth comfortable wood handle. Rivet free.

No. Size  
CF659 6"x6" 2" Radius with 2-1/2" Lip

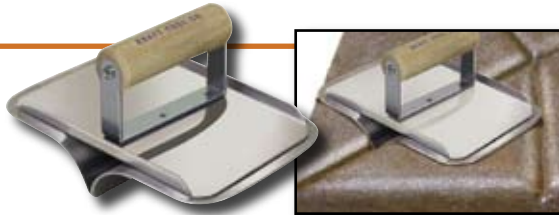

### Deco Hand Groover

Made of quality stainless steel. Fitted with smooth comfortable wood handle. Rivet free.

No. Size  
CF660 6"x6" 1-1/2" Radius with 1-3/4" Deep bit

### Salt Roller

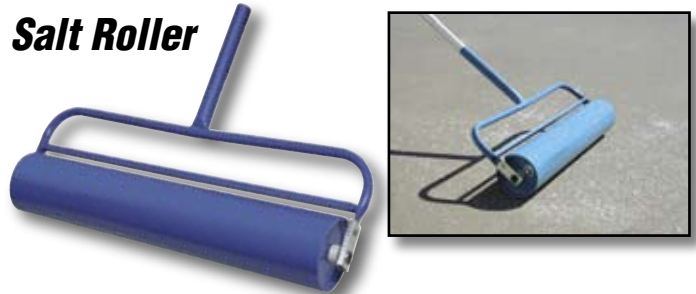

30" Long Decorative Salt Roller. Make small decorative impressions in new concrete using rock salt. Use with 1-3/8" diameter Snap Button handles.

No.  
CC957

### Plastic Step Tools

Special design for pools will not darken white coat. Heavy nose tool plexiglass.

#### NOSE TOOL

No.	Size	Lip	Radius
PL652	6"x5"	2-1/2"	3/4"
PL653	6"x5"	2-1/2"	1/2"
PL654	6"x5"	2-1/2"	1-1/2"

#### COVE INSIDE TOOL

PL655	6"x5"	5"	3/4"
PL656	6"x5"	5"	1/2"
PL657	6"x5"	5"	1-1/2"



Nose Tool

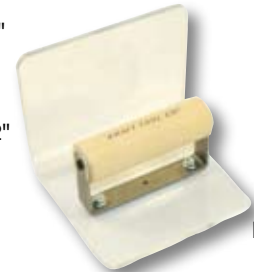

Cove Inside Tool

## Decorative Concrete Border Tools

Decorative Concrete Border Tools are made of high quality stainless steel and rivet free. Fitted with smooth comfortable wood handle.

### Single Edger with Double Groover

No.  
CF652 9" spacing w/3" shiner 3/4" R, 5/8" bit

CF653 9" spacing w/3" shiner 1/2" R, 5/8" bits

### Double edger with Groover

No.  
CF654 9" spacing 1/2" R, 5/8" bit

### Double Edger

No.  
CF655 9"x6" 1/2" R  
CF657 9"x6" 3/4" R

### Single edger with Groover

No.  
CF656 9" spacing w/3" shiner 1/2" R, 5/8" bit

Single Edger with Double Groover

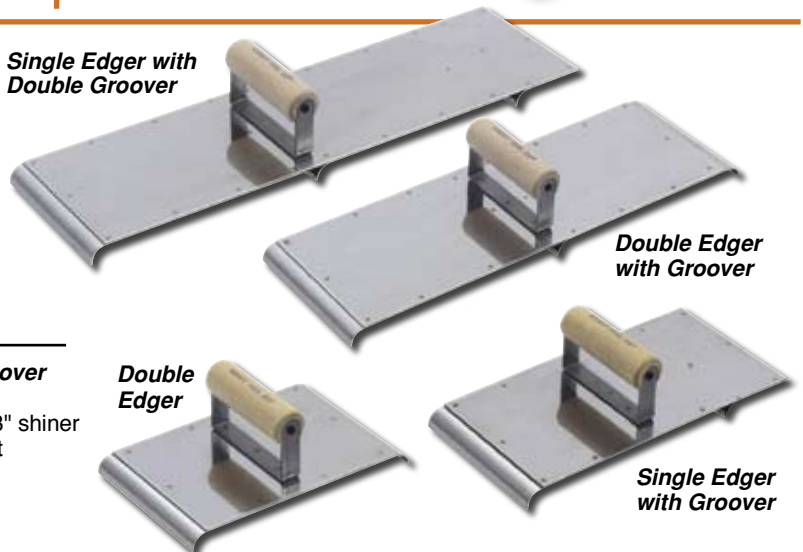

Double Edger with Groover

Double Edger

Single Edger with Groover

### Concrete Sliders (Knee Boards)



Made of lightweight, tough heavy-duty polystyrene plastic. Easy to use, easy to clean. One size fits all. Knee pads are replaceable.

No. Size  
CC153 (Pair) 30"x10"  
WL080 Replacement pads (Pair)

### Denver Sliders



Made with top quality #16 gauge stainless steel for extra smooth sliding surface. Round edges and corners with special nesting design. Built-in toe brackets for easy back and forth motion. Weight 11 lbs.

No. Size  
CC152 (Pair) 28"x8-1/2"

### Foam Rubber Knee Pads



Professional foam rubber hard shell knee pads. Contoured cap provides extra support and comfort for heavy use. Velcro® closures are easy to use and adjust.

No.  
WL135 (Pair)

### Non-Skid Knee Pads

Same as above. Rubber cap prevents sliding and marring of surfaces.

No.  
WL136 (Pair)

### Deluxe Heavy-Duty Stainless Steel Knee Boards



HD  
#16 gauge

Made with #16 gauge polished stainless steel to reduce corrosive problems. Reinforced and contoured on the bottom to prevent digging into the concrete. Adjustable knee pads are replaceable and allow a "comfort fit".

No. Size  
CC150 (Pair) 31"x8"  
CC151 (Pair) 28"x8"  
WL080 Replacement pads (Pair)  
WL082 Replacement straps (Pair)

### Leather Knee Pads



Tough leather makes for long wear. Lined with felt and shaped to fit your knee. Rivet construction holds soft felt in place. One adjustable strap holds pad securely.

No.  
WL087 (Pair) 1/2" thick felt  
WL088 (Pair) 1" thick double felt

### Rubber Cushion Knee Pads



A rubber cushion knee pad on the inside with a solid rubber surface for rugged long wear. Adjustable web straps are embedded within the pad. (JUDSEN KNEE PADS)  
No. WL070 (Pair)

### Lightweight Stainless Steel Knee Boards



#18 gauge

Knee boards are made of #18 gauge stainless steel. They are durable and easy to use. Knee pads are replaceable.

No. Size  
CC162 (Pair) 28"x8"  
WL080 Replacement pads (Pair)  
WL082 Replacement straps (Pair)



### Flat Leather Knee Pads

Hard wearing leather, but pliable and comfortable. Lined with soft felt that bends with the knee. One adjustable strap holds pad in place while you work.

No.  
WL071 (Pair)



### Polyurethane Knee Pads

- Made of durable lightweight polyurethane
- Used for all types of construction projects
- Two web straps hold pads to knees
- Pads are molded in one piece

No.  
WL080 (Pair)

# EZ-Kneeler™ Kneeboard

## Comfortable Multi-purpose Kneeboard

2" thick rubber cushion

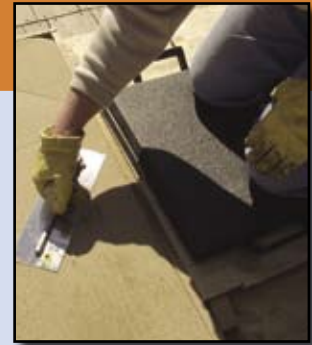
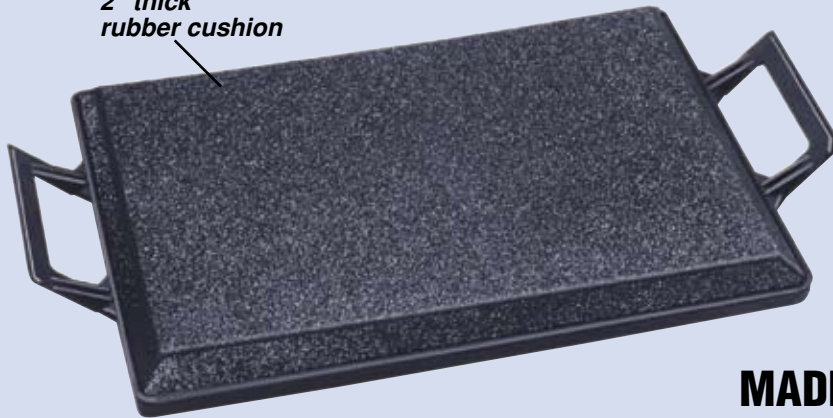

**MADE IN U.S.A.**

Provides the knees comfortable support and protection...

**NO MORE SORE KNEES!** A thermoplastic 2" thick rubber cushion (working surface 19-1/4"x13-1/2") securely fastened to 14"x24" polypropylene tray for maximum comfort and long life. It is a favorite of concrete finishers and tile installers.

No. WL069 (10) Per carton

**Washable & chemical resistant**  
**Weights only 2 lbs.**



### Knee Pad Super Soft / Front Closure

- Protect knees with soft neoprene pad
- Unique, easy to use front Velcro® strap
- Wide binding straps won't gouge
- Coated with non-marring polyurethane for added protection and durability

No. WL139\* (Pair)



### Hinge Style Knee Pads

- Hinge style
- Extra cushion black with hard shell cap
- Wide nylon Velcro® straps for extra comfort

No. WL137 (Pair)



### Polyurethane Knee Pads

These knee pads are very durable. One strap holds the pad in place. Pads are molded in one piece. They are very popular with the concrete finishers.

No. WL083 (Pair)



### Ultra Rubber Knee Pads

- Durable rubber with comfortable foam pad insert
- Adjustable replaceable straps
- Accordion style cap

No. WL084\* (Pair)

WL084-01  
Replacement Straps



### Nomar™ Gel Knee Pads

- Soft rubber resists marring & skidding
- Elastic & webbing straps
- Gel center & thick foam for maximum comfort

No. WL085\* (Pair)



### Ultra Rubber Gel Knee Pads

- Elastic & webbing straps (Replaceable)
- Accordion style cap
- Thick foam padding
- Air injected gel

No. WL086\* (Pair)

WL086-01  
Replacement Straps

\*See page 130



# Concrete Roller Tamp



Special roller tamp screen

Creates a non-skid surface when rolled over final finish  
5" Roller Diameter



Extension Handles See Page 12-13

✓ 3 Sizes to Choose From

- ✓ Depresses the aggregate and brings the fat to the surface in a uniform manner
- ✓ Levels the slab in half the time and does a better job than other conventional tampers
- ✓ Prepares the surface for a much smoother finish

**Uses threaded end handles**

No.	Size
CC948	18"
CC952	36"
CC958	48"

**Uses 1-3/8" Button handles**

No.	Size
CC948A	18"
CC952A	36"
CC958A	48"

**Uses 1-3/4" Button handles**

No.	Size
CC948B	18"
CC952B	36"
CC958B	48"

**Replacement Rollers**

No.	Size
CC949	18" (1) Roller W/Shaft
CC954	36" (1) Roller W/Shaft
CC959	48" (1) Roller W/Shaft

## Concrete Tampers

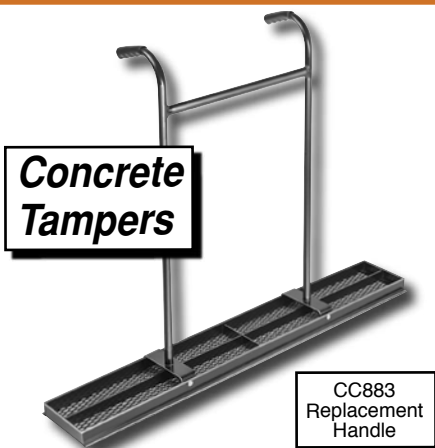

CC883 Replacement Handle

These concrete tampers are rugged and durable, built to handle any job. Tamping with this tool pushes large aggregate to the bottom to add strength; and fat to the top for easy finishing.



**Round Hole (Style)**

No.	Size
CC887	36"x8" Unassembled
CC887ASM	36"x8" Assembled
CC885	48"x8" Unassembled
CC885ASM	48"x8" Assembled



**Big Diamond (Style)**

Many concrete finishers prefer this style because it diverts the concrete splash away from the legs of the finisher.

No.	Size
CC879	36"x8" Unassembled
CC879ASM	36"x8" Assembled
CC881	48"x8" Unassembled
CC881ASM	48"x8" Assembled

## Heavy-Duty Tampers

Ideal for tamping texture mats and achieving the right amount of pressure on each mat. Rubber covered base prevents tearing or marring of texture mats. Cast iron tamper fitted with 48" hardwood handle.

**(A) Cast Iron/Poly coated base**

No.	Size / Weight
CC928	11"x11" Heavy-duty / 22 lbs.
CC928-01	H.D. Repl handle

**(B) Cast Iron base**

No.	Size / Weight
CC929	10"x10" Heavy-duty / 21 lbs.
CC928-01	H.D. Repl handle

**(C) Dirt Tamper**

Excellent way to tamp dirt surfaces. Cast iron tamper fitted with a 44" hardwood handle.

No.	Size / Weight
CC925	8"x8" 11 lbs.
CC926	10"x10" 14 lbs.
CC927	Repl handle

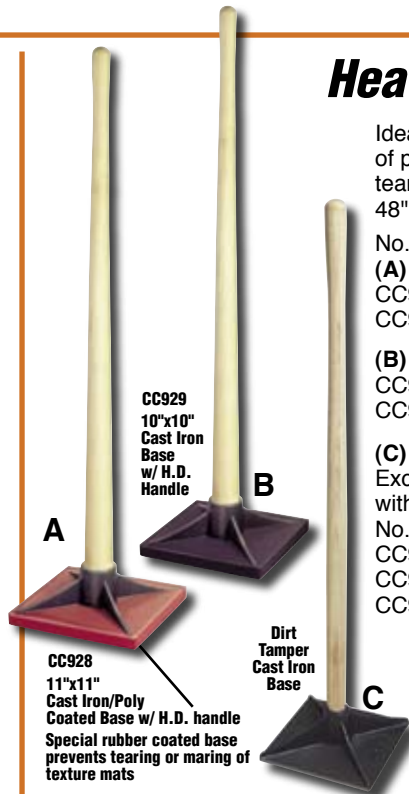

CC929 10"x10" Cast Iron Base w/ H.D. Handle

CC928 11"x11" Cast Iron/Poly Coated Base w/ H.D. handle  
Special rubber coated base prevents tearing or marring of texture mats

Dirt Tamper Cast Iron Base

## Safety Roller

Safety Roller gives a rough skid resistant finish to concrete ramps. Perfect for wheelchair, loading and walkways where a non-skid surface is a must. Roller is 5" in diameter and 24" wide. Roller is made of a tough expanded steel mesh. Handle bracket accepts threaded bull float extension handles.

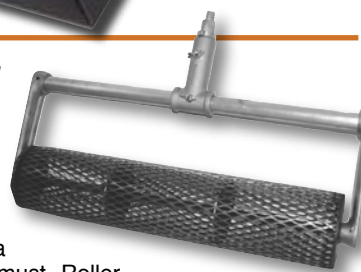

No. CC956

Gives a rough skid resistant finish to concrete!

## 8" Roller Tamp

Prepares the slab the same way as other roller tamps.

Works great in small areas, steps, or close to buildings and walls.

Special handle angle keeps the finisher from scraping against buildings, forms or walls. Use with CC336 handle or can be used with CC675 adapter for 1-3/4" diam. handle.

No. CC946 8"x5" diameter Roller w/1-3/8" button handle adapter



# A.D.A. Texture Mats

Check with LOCAL, STATE or FEDERAL Guidelines for correct specifications.

CC144-300 Pictured

## A.D.A. Texture Mat

This safety orange texture mat meets all of the new American Disability Act specifications for handicap curbing and walks. Mat forms handicap truncated domes. Domes are 2.35" center to center and diagonal on mat. Mat is 2'x3' and can be easily vented to allow air to escape. Mats must be used with release agent. Weight: 22 lbs.

No.

CC144-400 (Color Orange)  
Domes 2.35 (center to center) on diagonal pattern.

CC144-300 (Color Yellow)  
Specifications 2.35 diagonally. Domes 1.63 (center to center) horizontal and vertical pattern

**Single Dome Hand Tool**  
Touch up tool for truncated domes on CC144 (New Style)  
No. CC144A



## A.D.A. Texture Mat (Pre 2003 Specifications)

Truncated domes 2.30" center to center and placed diagonally on mat. Mats must be used with release agent. Mat is 2'x4' and can be vented to allow air to escape. Safety orange... use with release agent. Weight: 27 lbs. No. CC148



## Concrete Sealer

Solvent base sealer to protect and enhance concrete surfaces. Apply with sprayer. Ship via truck only. - 5 Gallon  
No. **RR176** High Gloss  
No. **RR178** Satin Finish



## Liquid Release

Easy to apply with sprayer. Forms lubricating barrier between concrete and mats. Use on colored or uncolored concrete. Alternative to powdered release agents.  
No. **RR175** 5 Gallon



## Back Pack Sprayer

4 Gallon Capacity



- Chemical resistant
- Heavy-duty
- Poly tank with Viton® seals
- Control valve
- Padded harness
- Kem-oil 250 non-kinking hose

No. **RR168**

## Curing Compound Sprayer

No. **RR164**

- Chemical resistant
- Epoxy coated galvanized steel
- Teflon® coated with Viton® seals
- Heavy-duty control valve
- Kem-oil 250 non-kinking hose



3.5 Gallon Capacity

# Color Release Agents

for Kraft Texture Mats

Dry powder release agent is recommended for use with texture mats. The release agents keep material from sticking to mat. The rate of coverage will vary depending upon the depth of the texture mat impressions desired and the degree to which the concrete has set. 3.5 lbs. per 100 sq. ft. or more may be required.

Covers approximately 800 -1,000 Sq. Ft. Available in (5) gallon containers. (shipping weight 35 lbs.)

## Color Release & Hardener

Release No.	Hardener No.	Description	
RA100	CH100	Dark Grey	
RA200	CH200	Medium Grey	
RA300	CH300	Nutmeg Tan	
RA310	CH310	Cream Beige	
RA320	CH320	Golden Sandstone	
RA325	CH325	Sandstone	
RA350	CH350	Desert Tan	
RA375	CH375	Buff Tan	
RA400	CH400	Chestnut Brn	
RA425	CH425	Autumn Brn	
RA500	CH500	Tile Red	
RA525	CH525	Dusty Rose	
RA550	CH550	Brick Red	
RA575	CH575	Victorian	
RA600	CH600	Light Grey	
RA625	CH625	Dover Blue	
RA700	CH700	Terra-Cotta	
RA735	CH735	Cappuccino <b>NEW</b>	
RA810	CH810	Walnut	
RA825	CH825	Slate Green	
RA900	CH900	Jet Black	
RA1080	CH1080	Adobe Buff	
RA1090	CH1090	Sun Buff	
RA3000	CH3000	Safety Yellow	

Color Hardener is used for coloring flatwork and is often used with antique release agents in the texturing of concrete. Wood float color hardener into the material before troweling. 60 lb. pail covers approximately 100 square feet.

**CAUTION:** Always use safety goggles and dust mask, when using color release agents and color hardener.



Note: Colors shown above approximate the appearance of Color Hardener and Antique Release Agent. Variations are to be expected due to jobsite conditions and finishing techniques. Prices vary with product and color. Contact your distributor for more information. Additional color charts available upon request.



# Kraft Texture Mats for Decorative Concrete



Our mats create a three dimensional impression on the concrete with all details of the shape, texture and feel of natural stone or brick. An excellent alternative to brick or tile for patios, driveways, walkways, poolside decking and for many other applications. 3/4" thick polyurethane.

**Texture Mats  
SPECIAL How-To  
Instructional VHS  
CC119  
Instructional DVD  
CC119DVD NEW**

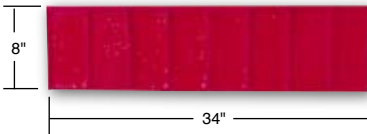

**Border Tool-Used Brick  
CC134** Weight: 8 lbs.  
**CC568**  
3/8" Sanded face roller

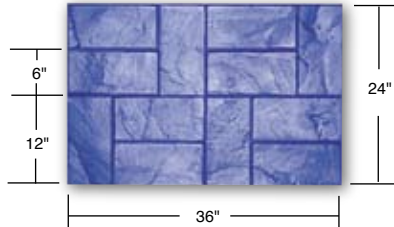

**New England Basket Weave  
CC139** Weight: 21 lbs.  
**CC569** 1/2" Wedge roller

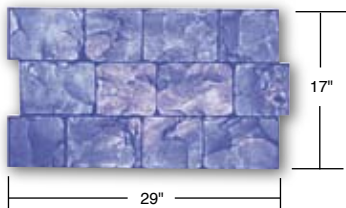

**London Cobble  
CC142** Weight: 14 lbs.  
**CC565** 1/4" Round face roller

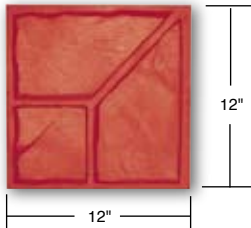

**Cut Stone Corner  
CC202** Weight: 2.5 lbs.  
**CC570** 1/2" Flat face roller

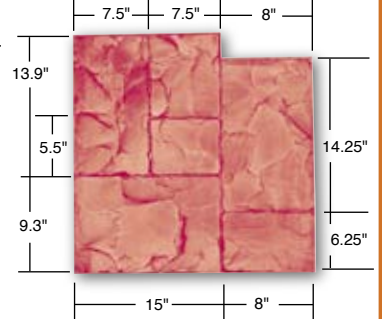

**Ashlar Cut Slate  
CC140** Weight: 14 lbs.  
**CC565** 1/4" Round face roller

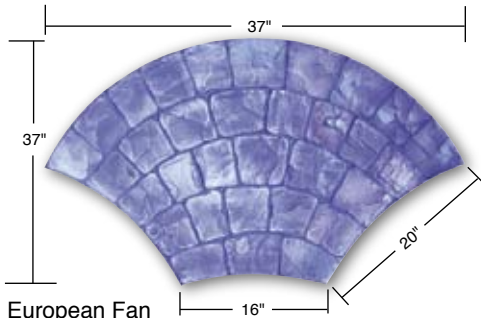

**European Fan  
CC141** Weight: 21 lbs.  
**CC566** 3/16" Flat face roller

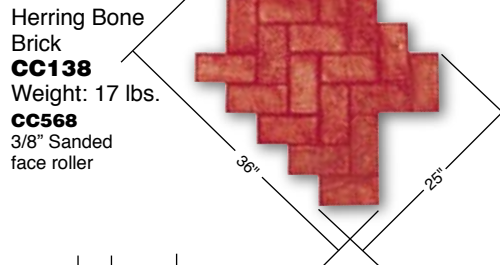

**Herring Bone  
Brick  
CC138**  
Weight: 17 lbs.  
**CC568**  
3/8" Sanded  
face roller

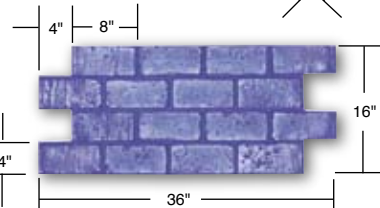

**Running Bond-Used Brick  
CC147** Weight: 15 lbs.  
**CC568** 3/8" Sanded face roller

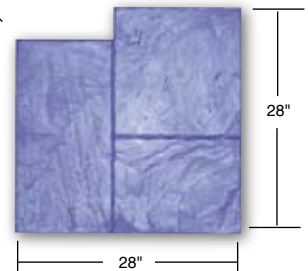

**Large Ashlar Cut Slate  
CC137** Weight: 20 lbs.  
**CC569** 1/2" Wedge roller

**Joint Touch-Up Rollers not included with mats.  
See page 56 for Joint Touch-Up Roller listing.**

### Floppy Texture Mats

All of the above texture mats are available in *Floppy Texture Mats*. Half the weight and half the thickness of regular texture mats. Very flexible, great for touch-ups, detail work and hard to reach areas such as walls and stairs.

**ADD "F" to Texture Mat (Part Numbers)**

**Kraft Texture Skins**  
Kraft Texture Skins are used by overlapping and gives the concrete a stone or slate texture. Skins can also be used for touch ups etc. in conjunction with other texture mats.  
No.  
CC001 Stone Texture 24"x36" Approx.  
CC002 Slate Texture 24"x36" Approx.

**Kraft Rough Stone Texture Skin**  
Texture Skins are used by overlapping and gives the concrete a rough stone texture. Skins can also be used for touch ups etc. Back side of texture skin fitted with two handles. Feathered edges.  
No.  
CC007 Texture Skin 36"x36" Approx.  
CC008 Texture Skin 56"x56" Approx.

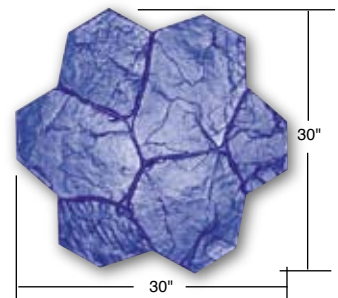

**Random Stone  
CC143** Weight: 17 lbs.  
**CC566** 3/16" Flat face roller



## Aluminum Chisels



### Aluminum Chisels

Use these aluminum chisels to dress and finish imprinted textured concrete.

No.	Size	No.	Size
CC115	1-1/2"	CC117	8"
CC110	3"	CC118	12"
CC116	4"	CC111	18"

## Hand Groover



Made of high grade aluminum. Hand groover is designed to cut straight control joints 1-3/4" deep. Use in conjunction with walking groovers. Fitted with comfortable wood float handle. Groover length 12", width 2".

No.	Size	Bit Width	Bit Depth
CC012	12"	1/4"	1-3/4"

## Joint Touch-Up Rollers

Available in 6 sizes!



Joint roller used for touching up joints when using texture mats. Match texture and width of existing joints. Keep it handy in your tool bag.

No.	Size	
CC565*	1/4"	Round face
CC567*	3/8"	Flat face
CC568*	3/8"	Sanded face
CC566*	3/16"	Flat face touch-up
CC569*	1/2"	Wedge touch-up
CC570*	1/2"	Flat face touch-up
CC571*	1/2"	Sanded face

## Tough Rugged ... Construction Boots

"OVER THE SOCK" BLACK BOOT



Excellent in wet/muddy conditions

"OVER THE SHOE" YELLOW BOOT



Rugged, heavy-duty vinyl boots made of the finest materials and for the toughest construction work. Excellent in wet, muddy conditions. Ideal for Construction/Contracting-General industrial/safety-General outdoor. (boot height 16")

"OVER THE SOCK"		"OVER THE SHOE"	
No.	Size	No.	Size
GG908	8	GG918	8
GG909	9	GG919	9
GG910	10	GG920	10
GG911	11	GG921	11
GG912	12	GG922	12
GG913	13	GG923	13
		GG924	14
		GG925	15

## Straight Arrow Groover For Control Joints

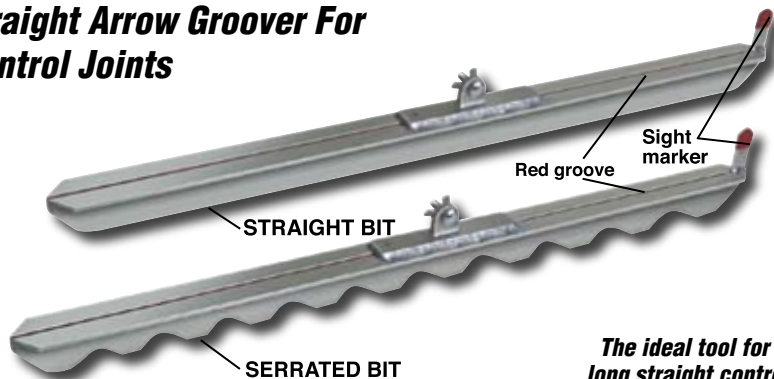

The ideal tool for cutting long straight control joints!

Available in 3 sizes!  
36", 48" or 60" length

Walking groover is made of high grade aluminum. Walking groover is designed to cut long straight 1-3/4" deep control joints. Special **red groove** cut in the top of groover along with **sight marker**, helps in cutting perfectly long straight control joints. Serrated bit groover helps in moving aggregate in the groove more easily. Use with clevis (CC386) wood handle or adapter for bull float handles. Order handles separately.

No.	Size	Bit Width	Depth
<b>STRAIGHT BIT</b>			
CC003	36" Groover	1/4"	1-3/4"
CC004	48" Groover	1/4"	1-3/4"
CC005	60" Groover	1/4"	1-3/4"
<b>SERRATED BIT</b>			
CC003S	36" Groover	1/4"	1-3/4"
CC004S	48" Groover	1/4"	1-3/4"
CC005S	60" Groover	1/4"	1-3/4"

## Double End Deco "V" Jointer



Double End Deco "V" Jointer is made of high quality aluminum. Use in conjunction with texture mats for touch up or cutting of small grooves. Groover designed to cut 5/8" or 3/4" joints. A must tool for every finisher.

No.	Size
CC112	12" "V" Jointer (5/8"x3/4")

# HI-CRAFT

Value Priced Trade Tools

### Concrete Trowel

Carbon steel blade with aluminum mounting. Fitted with camelback wood handle.

No.	Size
HC145	11"x4-1/2"
HC146	14"x4"
HC144	16"x4"
HC142	18"x4"

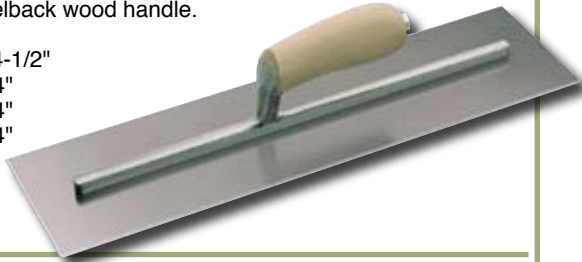

Order in cartons of (6) each.

### Cali Mahogany Wood Float

Made of Asian Mahogany. Float is 3-1/2" wide and 1/2" thick. Fitted with a smooth wood handle.

No.	Size
HC160	12"x3-1/2"
HC161	14"x3-1/2"
HC162	16"x3-1/2"
HC164	18"x3-1/2"
HC165	20"x3-1/2"



### GENUINE EXTRU-LITE™ MAGNESIUM Econo Mag Float

Lightweight

- Tough durable Extru-Lite Magnesium™ blade
- Precise handle position gives the float perfect balance and superb floating action
- Thin edges and smooth rounded corners gives this float that perfect "broken-in" feel

with soft grip handle

No.	Size
HC065PF	16"x3-1/8" <b>NEW</b>



Order in cartons of (6) each.

with standard wood handle  
HC065 16"x3-1/8" **NEW**



### Fresno Trowels with Swivel Bracket

360 degree all-angle bracket lets you work at any angle. Round end fresno eliminates marking or gouging slabs. Handle bracket with specific adapters will accept button or threaded extension handles and also clevis wood handles.

No.	Size
HC190*	36"x5"

### Universal Groover

Order in cartons of (6) each.

Popular among concrete finishers from coast to coast. This groover lasts longer because it is rivet-free. Has 6"x3" blade and cuts a clean 1/2"x1/2" groove.

No.	Size	Bit
HC148*	6"x3"	1/2" wide, 1/2" deep



### Aluminum Concrete Edger

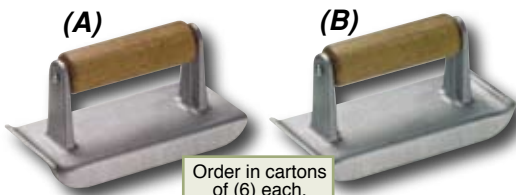

Order in cartons of (6) each.

**(A) Front end turned up and back end straight.**

Fitted with wood handle.

No.	A-1 Size	Lip Depth	Radius
HC155	5-7/8"x2-7/8"	3/4"	3/8"

**(B) Both ends turned up.** Fitted with wood handle.

No.	A-3 Size	Lip Depth	Radius
HC154	5-7/8"x2-5/8"	1/2"	3/8"

### Aluminum Concrete Groover

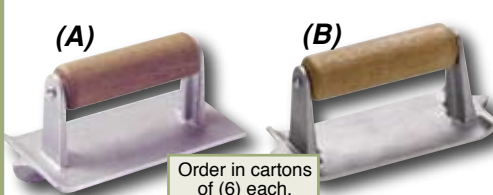

Order in cartons of (6) each.

**(A) Front end turned up and back end straight.**

Fitted with wood handle.

No.	A-6 Size	Bit width	Depth	Radius
HC152	6"x2-3/4"	3/8"	3/8"	7/32"

**(B) Both ends turned up.** Fitted with wood handle.

No.	A-5 Size	Bit width	Depth	Radius
HC153	5-3/4"x2-1/2"	1/2"	1/2"	13/64"

### Concrete Edger

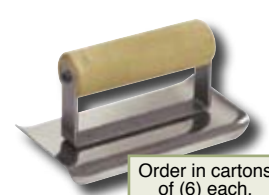

Order in cartons of (6) each.

Edger is 6"x3" and has 1/4" radius. Ends are turned up so it won't gouge concrete. Fitted with wood handle.

No.
HC147



**NEW**

**Texture Gun & Hopper**

The new Hi-Craft™ texture gun & hopper is lightweight, easy to use and is molded from high impact plastic. Sprays variety of drywall textures including stucco, & decking material. Gun comes complete with 2 air nozzles, adjustable orifice plate for texture adjustment, locking trigger system for less fatigue and large 2 gallon hopper. Hopper has built in angle for maximum fill and operates on 6.25 C.F.M free air at 25 P.S.I.

No. HC501 **NEW**

**Metal Pole Sander**

Lightweight aluminum pole sander w/ 48" wood handle. Female end used with acme threaded handle.

No.	Size
HC517*	Hi-Craft™ Pole Sander w/ 48" wood handle <b>NEW</b>
HC517-01*	Hi-Craft™ Pole Sander (head only) <b>NEW</b>
HC517-02	Hi-Craft™ 48" wood handle only <b>NEW</b>

Order in cartons of (6) each.



**NEW**



**NEW**

**5 in 1 Combination Tool**

5 tools in 1; scraper, seam opener, spreader, putty remover and a cutout that removes paint from rollers.

No. HC524\* **NEW**

Order in cartons of (5) each.

**NEW**



**Hammer End Putty & Joint Knives**

New joint knives designed for many applications, including drywall and putty. Carbon blades ground for flexibility with nylon handle.

No.	Flex
HC527*	1-1/2" <b>NEW</b>
HC528*	2" <b>NEW</b>
HC529*	4" <b>NEW</b>
HC530*	5" <b>NEW</b>
HC533*	6" <b>NEW</b>

Order in cartons of (5) each.

**Linoleum Knife**

Lets you easily make even, accurate cuts in hard core vinyl or softer materials. Extra heavy sharp point. Made of carbon steel.

No. HC300\* **NEW**

Order in cartons of (5) each.



**NEW**

**Stainless Steel Threaded Handle Scrapers**

Stainless steel bent scrapers with single bevel. Molded, threaded end can be used with standard threaded handle. Soft handle for comfortable grip and less fatigue.

No.	Size
HC534* <b>NEW</b>	4"
HC537* <b>NEW</b>	7"

Order in cartons of (5) each.



**NEW**

**Hand Sander**

Hard plastic fitted with soft comfortable textured handle for improved grip. Paded sanding face provides a more uniform surface for sanding. Use with pre-cut drywall sandpaper or 1/2 of 8"x11" sheet.

No. HC341 Size Hand sander

Order in cartons of (6) each.

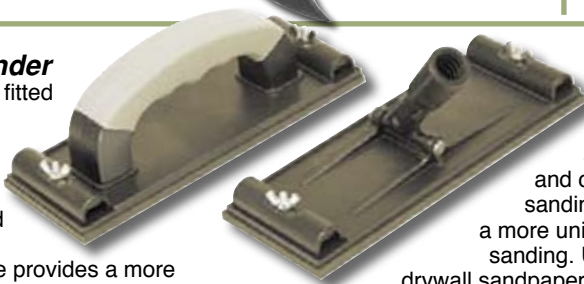

**Pole Sander**

Made of hard plastic. Makes for easier sanding of walls and ceilings. Paded sanding face provides a more uniform surface for sanding. Use with pre-cut drywall sandpaper or 1/2 of 8"x11" sheet. Swivel handle bracket accepts standard broom threaded handle. Handle not included.

No. HC217 Size Pole sander

**Caulking Trowels**

Trowels are made of carbon steel and ground for flexibility. Fitted with wood handle.

No.	Blade Size
HC762*	7"x1/4"
HC763*	7"x3/8"
HC764*	7"x1/2"
HC765*	7"x5/8" <b>NEW</b>
HC766*	7"x3/4"
HC768*	7"x1"

Order in cartons of (6) each.



**Brick Trowel**

Brick trowel is made of tempered steel, taper ground. Fitted with wood handle. 10" blade.

No. HC 149\*

Order in cartons of (6) each.



Order in cartons of (6) each.



**Pointing & Margin Trowel**

Blade is made of tempered steel, taper ground and fitted with wood handle.

No.	Blade size
HC150*	Pointing 5"
HC422*	Pointing 5-1/2" <b>NEW</b>
HC423*	Pointing 7" <b>NEW</b>
HC151*	Margin 5"x2"
HC433*	Margin 8"x2"



*Sand's Levels Tell The Truth®*



## Professional Levels



General Purpose / Concrete

**Available  
in 8 sizes**

Double bent vials for accuracy

Contractor red edge

### Professional Cast Aluminum Levels

Product No.	UPC No. 30553	Length	Vials
SL 1212	10112-1	12"	4
SL 1818	10113-8	18"	6
SL 2424	10114-5	24"	6
SL 2828	10115-2	28"	6
SL 3030	10116-9	30"	6
SL 4848	10111-4	48"	6
SL 18YA18	10214-2	18"	5 ◇
SL 24YA24	10215-9	24"	5 ◇

- Durable cast aluminum construction
- Precision milled frame for accurate work surface
- Solid Set Cat's eye yellow double bent vials for accuracy
- Will not warp... Will not rust
- Protective glass lenses

◇ 45 Degree vial



Top reading vial

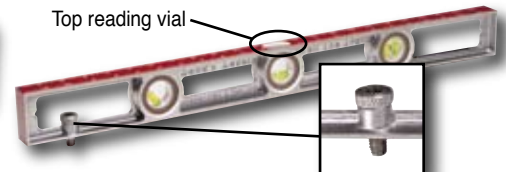

Threaded cap screw  
to adjust pitch

### Professional Cast Aluminum Plumbers Level

Product No.	UPC No. 30553	Length	Vials
SL 2424P	10211-1	24"	4

- Durable cast aluminum construction
- Precision milled frame for accurate work surface
- Will not warp... Will not rust
- Solid Set top reading vial, 45 degree vial, and twin plumb vials
- Protective glass lenses • Graduated 1/10" ruler on working surface



Full length magnetic strip  
available on the Magnetic  
Aluminum Extruded Levels

### Professional Top Reading Magnetic Aluminum Extruded Levels

Top reading level with Roto Vial® feature...  
Roto Vial® feature insures permanent built-in accuracy

Product No.	UPC No. 30553	Length	Vials
SL PML18	13001-5	18"	3
SL PML24	13002-2	24"	3
SL PML36	13003-9	36"	3
SL PML48	13004-6	48"	3
SL PML72	13005-3	72"	5
SL PML96	13007-7	96"	5

- Heavy duty extruded aluminum I-beam frame
- Replaceable Solid Set acrylic Roto Vial® feature for accuracy
- Top reading window for the level vial, and two plumb vials
- Shock absorbent end caps
- Replaceable protective plastic lenses & vials

# Professional Levels

I-Beam Construction...  
Strong and lightweight

Machined edge



Available  
in 10 sizes  
(6 & 10 vials)

## Professional Aluminum Extruded Levels

## HEAVY-DUTY Level

Product No.	UPC No. 30553	Length	Vials
SL HD18	12001-6	18"	6
SL HD24	12002-3	24"	6
SL HD28	12003-0	28"	6
SL HD30	12004-7	30"	6
SL HD36	12005-4	36"	6
SL HD42	12006-1	42"	6
SL HD48	12007-8	48"	6
SL HD72	12008-5	72"	10 ✕
SL HD78	12009-2	78"	10 ✕
SL HD96	12010-8	96"	10 ✕

- Heavy duty extruded aluminum I-beam frame
- Strong, lightweight frame with shock absorbent end caps
- Adjustable Cat's eye yellow double bent vials for accuracy
- Precision milled frame for accurate work surface
- "Contractor Red" with machined edges
- Replaceable protective plastic lenses & vials

✕ No End Caps



See Page 64 for  
Level Cases



## Professional Aluminum Box Levels

Product No.	UPC No. 30553	Length	Vials
SL BX24*	12201-0	24"	3
SL BX48*	12202-7	48"	3
SL BX72*	12203-4	72"	3

- Tough heavy-duty extruded aluminum frame
- Top reading window for level vial, one horizontal and two plumb vials
- Cat's eye yellow vials are accurate and consistent
- Powder coated long lasting finish
- Frame will not warp or twist
- Shock absorbent end caps • Protective plastic lenses

Shock absorbent  
end caps



## Professional Aluminum Box Levels with Hand Holes

Product No.	UPC No. 30553	Length	Vials
SL BX24HH*	12204-1	24"	3
SL BX48HH*	12205-8	48"	3
SL BX72HH*	12206-5	72"	3

- Tough heavy-duty extruded aluminum frame
- Top reading window for level vial, one horizontal and two plumb vials
- Cat's eye yellow vials are accurate and consistent
- Powder coated long lasting finish
- Soft cushioned, comfortable hand holes
- Shock absorbent end caps • Protective plastic lenses

# Professional Levels



## Professional Magnesium Extruded Levels

Product No.	UPC No. 30553	Length	Vials
SL 024	15011-2	24"	6
SL 028	15012-9	28"	6
SL 048	15016-7	48"	6
SL 060	15017-4	60"	8
SL 072	15018-1	72"	10
SL 096	15021-1	96"	10

- High quality Extru-Lite™ magnesium I-beam frame
- Frame is strong and lightweight
- 30% lighter than aluminum
- Adjustable cat's eye yellow double bent vials for accuracy
- Shock absorbent end caps
- Replaceable protective plastic lenses & vials
- General purpose



## Professional Brass Bound Mahogany Levels

Product No.	UPC No. 30553	Length	Vials
SL 12AB18	11113-7	18"	6 ✓
SL 12AB24	11114-4	24"	6 ✓
SL 12AB28	11115-1	28"	6
SL 12AB36	11117-5	36"	6
SL 12AB42	11119-9	42"	6
SL 12AB48	11121-2	48"	6

✓ 18" & 24" level comes with hand grooves

- Made from the finest selection of mahogany wood
- Angle type brass binding on all edges
- Two large hand holes and one hang hole for hanging
- Shock absorbent end caps
- Protective glass lenses
- General purpose level for mason or other tradesmen



Angle bound brass binding embedded in wood for extra strength

All Sands vials easy to read and solid set for accuracy



Solid Set cat's eye yellow double bent vials for accuracy



## Professional Mahogany I-Beam Levels

Product No.	UPC No. 30553	Length	Vials
SL MA24◇	14001-4	24"	6 ✓
SL MA36	14002-1	36"	6
SL MA42	14003-8	42"	6
SL MA48	14004-5	48"	6
SL MA72	14005-2	72"	8

✓ 24" level comes with hand grooves

- Heavy duty aluminum I-beam frame
- Made from the finest selection of mahogany wood
- Six Solid Set cat's eye yellow double bent vials for accuracy
- Two large hand holes and one hang hole for hanging
- Shock absorbent end caps
- Protective glass lenses



Heavy-duty aluminum I-beam frame for extra strength

All Sands vials easy to read and solid set for accuracy

# Professional Levels

Adjustable top vial for accuracy



## Professional Top Reading Mahogany I-Beam Levels

Product No.	UPC No. 30553	Length	Vials
SLTMI-24	11620-0	24"	5
SLTMI-48	11621-7	48"	5

- Heavy duty aluminum I-beam frame
- Made from the finest selection of mahogany wood
- Shock absorbent end caps
- Protective glass lenses
- Large clear vials



Wrap around stainless steel end caps & screws

## Professional Walnut/Maple Laminated Levels

Product No.	UPC No. 30553	Length	Vials
SL WML24	11421-3	24"	6
SL WML36	11422-0	36"	6
SL WML42	11423-7	42"	6
SL WML48	11420-6	48"	6

- Premium grade walnut/maple
- Flat stainless steel binding and wrap around end caps
- Wood is double sealed with smooth lacquer finish
- Six Solid Set cat's eye yellow double bent vials for accuracy
- Two large hand holes and one hang hole for hanging
- **Double strength...** glass lenses

All Sands vials easy to read and solid set for accuracy



Premium grade walnut/maple with flat stainless steel binding



## Professional Mahogany Flat Brass Levels

Product No.	UPC No. 30553	Length	Vials
SL 22BY24	11220-2	24"	6
SL 22BY36	11221-9	36"	6
SL 22BY42	11222-6	42"	6
SL 22BY48	11223-3	48"	6

- Made from the finest selection of mahogany wood
- Solid flat brass trim with screws
- Six Solid Set cat's eye yellow double bent vials for accuracy
- Two large hand holes
- Shock absorbent end caps
- Protective glass lenses

All Sands vials easy to read and solid set for accuracy



Flat brass edges



## Professional Door Jamb Level

Product No.	UPC No. 30553	Length	Vials
SL MA78R	14009-0	6' (5-3/4")	8

- Mahogany I-beam
- Eight Solid Set Cat's eye yellow vials for accuracy
- Large hand holes and shock absorbent end caps
- Solid aluminum rollers
- Handy as a straight edge level and for setting door jams



Adjustable rollers for checking plumb of door



Heavy-duty aluminum I-beam frame for extra strength

# Professional Levels



No rust stainless steel binding

All Sands vials easy to read and solid set for accuracy



Solid Set cat's eye yellow double bent vials for accuracy

## Professional Stainless Steel Mahogany Bound Levels

Product No.	UPC No. 30553	Length	Vials
SL44SB-24	11520-3	24"	6
SL44SB-36	11521-0	36"	6
SL44SB-42	11522-7	42"	6
SL44SB-48	11523-4	48"	6

- Made from the finest selection of mahogany wood
- Angle type stainless steel binding on all edges
- Two large hand holes and one hang hole for hanging
- Shock absorbent end caps
- Protective glass lenses



Two top reading vials

Designed to be used in asphalt construction

## Professional Asphalt Mahogany I-Beam Level

Product No.	UPC No. 30553	Length	Vials
SL AL48	11320-9	48"	2

- Heavy duty aluminum I-beam frame
- Made from the finest selection of mahogany wood
- Two top reading Solid Set Cat's eye yellow vials for accuracy
- Two large hand holes and one hang hole for hanging
- Protective glass lenses



Heavy-duty aluminum I-beam frame for extra strength

## Professional Level Cases

Product No.	UPC No. 30553	Length
SL PLC24	90101-1	24"
SL PLC36	90106-6	36"
SL PLC42	90107-3	42"
SL PLC48	90102-8	48"
SL PLC72	90103-5	72" <b>NEW</b>
SL PLC96	90104-2	96"



Easy hang hook



Available in 6 sizes



- Durable high impact styrene
- Opening measures 1-1/4" x 2-1/2"
- Easy open/close end with peg hook for hanging
- Available in six sizes
- Fits most levels
- Will protect and prolong the life of the level



# Contractor Levels

Easy to read English/Metric rule



## Contractor Extruded Aluminum Levels

Product No.	UPC No. 30553	Length	Vials
SL SC2212	17010-3	12"	2
SL SC2418	17012-7	18"	4
SL SC3624	17016-5	24"	6
SL SC3628	17018-9	28"	6
SL SC3636	17019-6	36"	6
SL SC3648	17021-9	48"	6
SL SC4872	17022-6	72"	8

- Aluminum I-beam frame
- Frame is strong and lightweight
- Cat's eye yellow double bent vials for accuracy
- Two large hand holes and one hang hole for hanging
- Easy to read English/metric rule on one edge
- Shock absorbent end caps
- Replaceable protective plastic lenses & vials



Strong magnetic strip

Easy to read English/Metric rule

## Contractor Magnetic Extruded Aluminum Levels

Roto Via® feature insures permanent built-in accuracy

Product No.	UPC No. 30553	Length	Vials
SL QML24	14101-1	24"	3
SL QML48	14102-8	48"	3
SL QML72	14103-5	72"	4

- Strong extruded aluminum I-beam frame
- Easy to read English/metric rule on one edge
- Replaceable Solid Set acrylic Roto Via® feature for accuracy
- Shock absorbing protective end caps
- Full length magnetic strip to hold against metallic surface
- Replaceable protective plastic lenses & vials



SL 67824 24" (1) level vial and (1) plumb vial



SL 1024 24" (1) level vial with top reading and (1) plumb vial



SL 11824 24" (2) level vials and (2) plumb vials



SL 2018 18" Same vials as above (No hand holes or grooves)  
 SL 2024 24" (1) level vial, (1) plumb vial and (1) 45 Degree vial  
 SL 2048 48" (1) level vial, (1) plumb vial and (1) 45 Degree vial

SL 11824A 24" (2) level vials, (1) plumb vial and (1) 45 Degree vial

## Contractor Mahogany Carpenter Levels

Product No.	UPC No. 30553	Length	Vials
SL 11824	19010-1	24"	4
◇SL 11824A	19011-8	24"	4◇
SL 67824	19012-5	24"	2
SL 1024	19015-6	24"	2
◇ SL 2018 w/ end caps	19209-9	18"	3 ◇
◇ SL 2024 w/ end caps	19210-5	24"	3 ◇
◇ SL 2048 w/ end caps	19211-2	48"	3 ◇

## General Purpose Wood Levels

- Made from the finest selection of mahogany wood
- Wood is double sealed with smooth lacquer finish
- Solid Set cat's eye yellow bent vials for accuracy
- Heavy protective glass lenses
- Available with top reading or 45 degree vials
- ◇ 45 Degree Vial ◇



**Solid set vials**

# Utility Level



## Utility Aluminum Extruded Levels

Product No.	UPC No. 30553	Length	Vials
SL PL218	18010-2	18"	2
SL PL318	18015-7	18"	3
SL PL224	18011-9	24"	2
SL PL324	18012-6	24"	3
SL PL336	18013-3	36"	3
SL PL348	18014-0	48"	3

- Lightweight extruded aluminum I-beam frame
- Engineered to meet the demands of the home handyman
- Two large hand holes
- "V" groove on bottom of frame for use on round pipe, conduit or flat surfaces
- Replaceable vials (no lenses)

**See Page 64 for Level Cases**

Special "V" Groove on bottom of frame...makes level more stable on round surfaces

# Speciality Levels

All Torpedo Levels come with (1) level vial, (1) plumb vial and (1) 45 Degree vial

## Professional

### 9" Aluminum Torpedo Level-3 Vial

Product No. SL SC50      UPC No. 30553 16017-3



## Professional

### 9" Aluminum Torpedo Level/Magnetic-3 Vial

Product No. SL SC50M      UPC No. 30553 16018-0



## Contractor

### 9" Plastic/Alum Torpedo Level/Magnetic-3 Vial

Product No. SL PT10M\*      UPC No. 30553 16023-4



## Utility

### 9" Plastic Torpedo Level/Magnetic-3 Vial

Product No. SL PT9M\*      UPC No. 30553 16020-3



## Utility Post Level

- High impact plastic body
- 90 degree bend
- Hooks quickly to any post

Product No.	UPC No. 30553	Description
SL 470*	03055-1	Magnetic Post Level - 3 vial

# Levels

## Line • Pocket • Surface • Cross Check

Product No.	UPC No. 30553	Description
SL SC55	16016-3	3" Aluminum Line Level
SL PLL3	16021-0	3" Plastic Line Level
SL 400*	16012-8	Bulls Eye Surface Level
SL 556	16013-5	5" Aluminum Pocket Level with Clip
SL 480*	80107-6	Cross Check Level-2 Vials

Aluminum Line Level

Aluminum Pocket Level

Plastic Line Level

Cross Check Level

Bulls Eye Level

# Carpenter Squares

## KEY TO FEATURES

- A. Rafter Framing Rule
- B. Octagon Scale
- C. Brace Measure
- D. 1/100 Scale
- E. Essex Board Measure
- F. Reverse Reading Rule
- G. Metric Equivalents
- H. Wood Screw Drill Size
- J. Protractor
- K. Useful Information
- L. Nail Information
- M. Decimal Equivalents
- N. Screw Thread Gauge
- O. Board Foot Table

### Etched Numbers

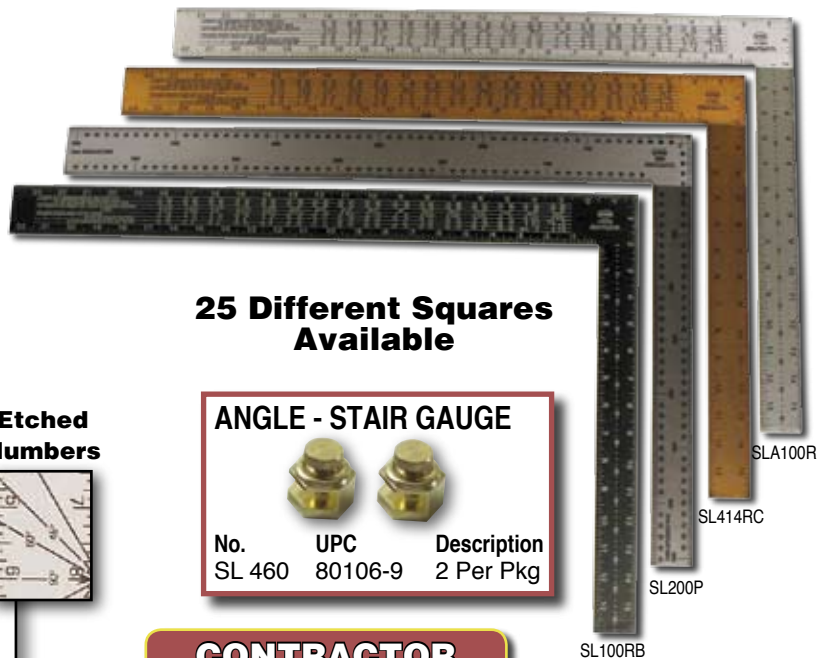

SLA100R  
SL414RC  
SL200P  
SL100RB

## 25 Different Squares Available

### ANGLE - STAIR GAUGE



No.	UPC	Description
SL 460	80106-9	2 Per Pkg

### PROFESSIONAL

**Features: A, B, C, D, E** *Multiple Features*  
**Graduations: 1/16", 1/8", 1/10", 1/12"**  
**Size: 16" x 24"**

No.	UPC	Description
SL 100RC	40100-9	Rafter Square - Steel - <b>Copper</b>
SL 100RB	40101-6	Rafter Square - Steel - <b>Blue</b>
SL 100RP	40102-3	Rafter Square - Steel - <b>Polished</b>
SL A100R	40103-4	Rafter Square - <b>Aluminum</b>

**Features: A, E** *Multiple Features*  
**Graduations: 1/8", 1/4"**  
**Size: 16" x 24"**

No.	UPC	Description
SL 414RC	40104-7	Rafter Square - Steel - <b>Copper</b>
SL 414RB	40105-4	Rafter Square - Steel - <b>Blue</b>
SL 414RP	40106-1	Rafter Square - Steel - <b>Polished</b>
SL A414R	40107-8	Rafter Square - <b>Aluminum</b>

**Features: Rafter / Metric**  
**Graduations: Centimeters**  
**Size: 16" x 24"**

No.	UPC	Description
SL 200C	40126-9	Rafter Square Metric - Steel - <b>Copper</b>
SL 200P	40113-9	Rafter Square Metric - Steel - <b>Polished</b>

**Features: Rafter / Metric**  
**Graduations: Centimeters**  
**Size: 8" x 12"**

No.	UPC	Description
SL 800C	40127-6	Rafter Square Metric - Steel - <b>Copper</b>

**Features: A Rafter**  
**Graduations: 1/16", 1/8", Centimeters**  
**Size: 16" x 24"**

E/M = English/Metric

No.	UPC	Description
SL 300P	40114-6	E/M Rafter Square - Steel - <b>Polished</b>

**Features: A Rafter**  
**Graduations: 1/8"**  
**Size: 16" x 24"**

No.	UPC	Description
SL SC2C	40118-4	Rafter Square - Steel - <b>Copper</b>
SL SC2B	40119-1	Rafter Square - Steel - <b>Blue</b>

### CONTRACTOR

**Features: H, K, L, O** *Multiple Features*  
**Graduations: 1/8", 1/4"**  
**Size: 8" x 12"**

No.	UPC	Description
SL 8C	40110-8	Square - Steel - <b>Copper</b>
SL 8B	40111-5	Square - Steel - <b>Blue</b>
SL 8P	40112-2	Square - Steel - <b>Polished</b>

### CONTRACTOR

**Features: Standard**  
**Graduations: 1/8", 1/4"**  
**Size: 16" x 24"**

No.	UPC	Description
SL SC1C	40116-0	Standard Square - Steel - <b>Copper</b>
SL SC1P	40117-7	Standard Square - <b>Polished</b>
SL SC1A	40115-3	Standard Square - <b>Aluminum</b>

### UTILITY

**Features: H, J, K, L, M, N, O** *Multiple Features*  
**Graduations: 1/8"**  
**Size: 16" x 24"**

No.	UPC	Description
SL SC4P	40120-7	Home Owner Square - Steel - <b>Polished</b>
SL SC4A	40121-4	Home Owner Square - <b>Aluminum</b>

### UTILITY

**Features: Printed**  
**Graduations: 1/16", 1/8"**  
**Size: 8" x 12"**

No.	UPC	Description
SL SC7B	40125-2	Printed Square - Steel - <b>Blue</b>

**Tables: A, B, C, E** *Multiple Features*  
**Graduations: 1/6", 1/8"**  
**Size: 16" x 24"**

No.	UPC	Description
SL SC6B	40124-5	Home Owner Square Printed - <b>Blue</b>
SL SC6A	40122-1	Home Owner Square Printed - <b>Aluminum</b>



**Meter Stick - 39.37" Length** • Bright anodized extruded aluminum • Easy to read black graduations

39.37" = 1 Meter

**Convenient metric conversion tables printed on back**

Product No.	UPC No. 30553	Description
SL M39	50100-6	METER STICK - 39.37"



**Rules or Yard Sticks** • Bright anodized extruded aluminum • Easy to read black graduations

Product No.	UPC No. 30553	Description
SL M39	50100-6	METER STICK - 39.37"
SL AR12	50101-3	RULE - 12"x1-1/8"
SL AR18	50102-0	RULE - 18"x1-1/8"
SL AR24	50103-7	RULE - 24"x1-1/8"
SL AYS36	50104-4	YARD STICK - 36"x1-1/8" 1 SIDE
SL AYS362	50105-1	YARD STICK - 36"x1-1/8" 2 SIDE



**Straight Edges** • Bright anodized extruded aluminum • Easy to read black graduations

Product No.	UPC No. 30553	Description
SL ASE18	50106-8	STRAIGHT EDGE - 18"x2"
SL ASE24	50107-5	STRAIGHT EDGE - 24"x2"
SL ASE36	50108-2	STRAIGHT EDGE - 36"x2"
SL ASE48	50109-9	STRAIGHT EDGE - 48"x2"
SL ASE60	50110-5	STRAIGHT EDGE - 60"x2"
SL ASE72	50111-2	STRAIGHT EDGE - 72"x2"
SL ASE96	50112-9	STRAIGHT EDGE - 96"x2"

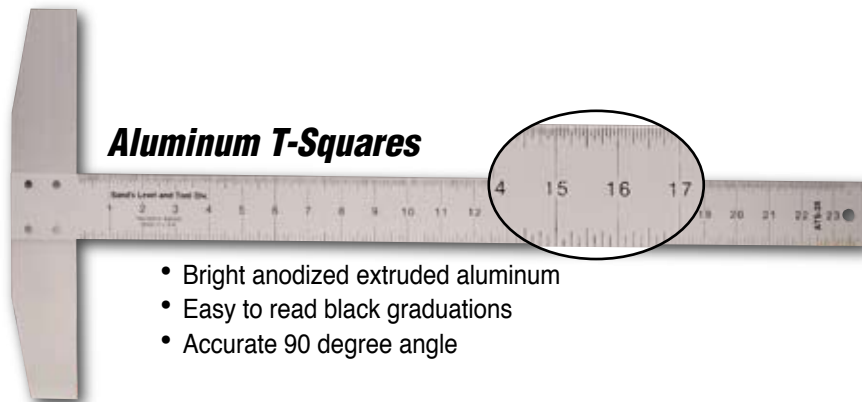

**Aluminum T-Squares**

- Bright anodized extruded aluminum
- Easy to read black graduations
- Accurate 90 degree angle

Product No.	UPC No. 30553	Size
SL ATS18	50113-6	18"x2"
SL ATS24	50114-3	24"x2"
SL ATS30	50115-0	30"x2"
SL ATS36	50116-7	36"x2"
SL ATS48	50118-1	48"x2"



ASE-24

Sand's Level and Tool Div.  
Neodesha, Kansas  
Made in U.S.A.

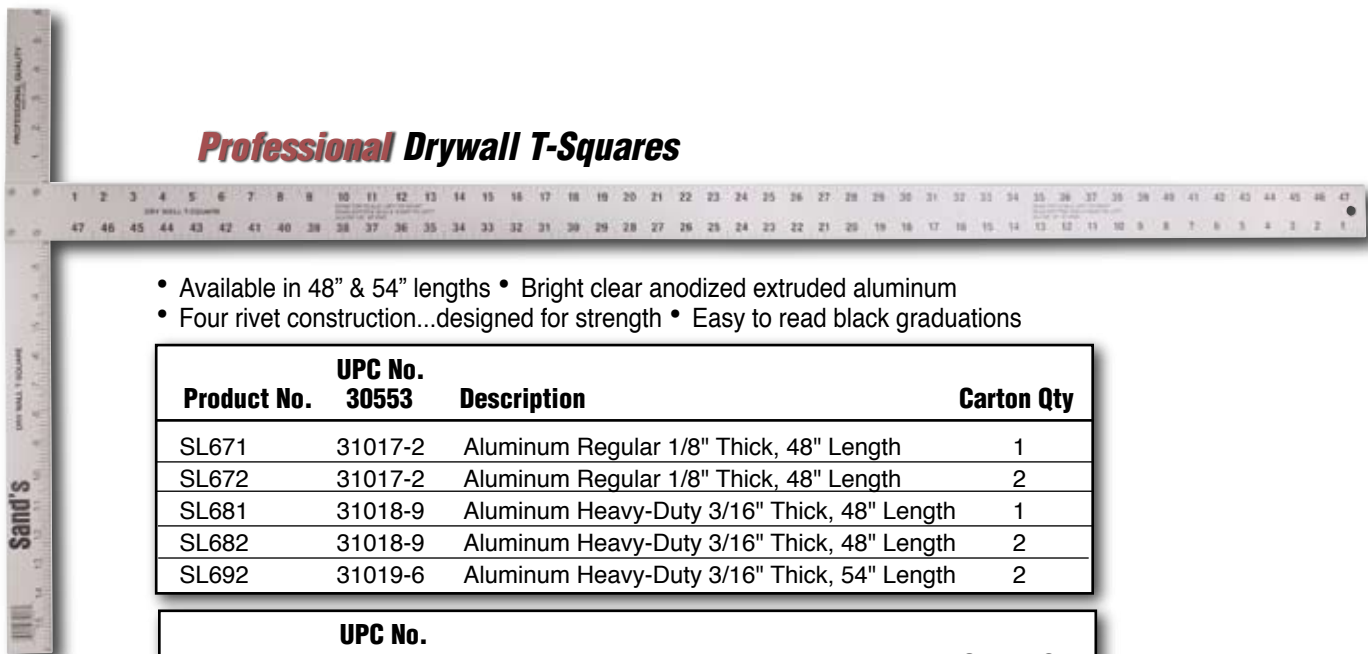

### Professional Drywall T-Squares

- Available in 48" & 54" lengths • Bright clear anodized extruded aluminum
- Four rivet construction...designed for strength • Easy to read black graduations

Product No.	UPC No. 30553	Description	Carton Qty
SL671	31017-2	Aluminum Regular 1/8" Thick, 48" Length	1
SL672	31017-2	Aluminum Regular 1/8" Thick, 48" Length	2
SL681	31018-9	Aluminum Heavy-Duty 3/16" Thick, 48" Length	1
SL682	31018-9	Aluminum Heavy-Duty 3/16" Thick, 48" Length	2
SL692	31019-6	Aluminum Heavy-Duty 3/16" Thick, 54" Length	2

Product No.	UPC No. 30553	Description	Carton Qty
SL686 <b>NEW</b>	31018-9	Aluminum Heavy-Duty 3/16" Thick, 48" Length	6



Brass



Steel

### Professional Plumb Bobs

- Available in 3 sizes....Brass or Steel

- Replaceable steel tip
- Removeable cap for easy string installation
- Bright machined finish
- Ideal for finding vertical points
- Bright plated finish
- Machined hexagonal steel
- Removeable cap for easy string installation
- Ideal for finding vertical points

Product No.	UPC No. 30553	Description
SL 40*	30018-0	Brass Engineer Plumb Bob - 24 oz
SL 41*	30019-7	Brass Engineer Plumb Bob - 16 oz
SL 43*	30021-0	Brass Engineer Plumb Bob - 8 oz
SL 51*	30015-9	Hex Steel Plumb Bob - 12 oz
SL 52*	30014-2	Hex Steel Plumb Bob - 8 oz
SL 51C*	30011-1	Hex Steel Plumb Bob - 12 oz carded
SL 52C*	30012-8	Hex Steel Plumb Bob - 8 oz carded

### Combination Squares

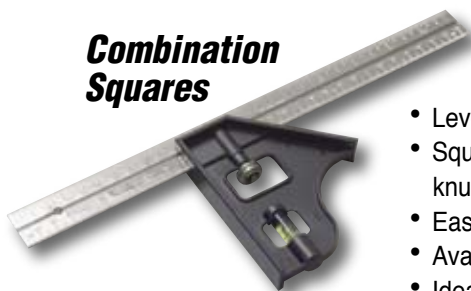

- Level vial in the head of the square
- Square has steel scribe and solid brass knurled thumb screw for adjustment
- Easy to read permanently etched graduations
- Available with plastic or zinc head
- Ideal for level, plumb & miter work

Product No.	UPC No. 30553	Description
SL CS0	45103-5	12" Plastic Head
SL CS1	45101-1	12" Zinc Head
SL CS3	45104-2	6" Zinc Head

\*See page 130

### Contractor Aluminum Hawks



#### 6 SIZES

- High strength lightweight aluminum
- Blade thickness .060
- Comes with wood handle and callous preventer

Product No.	UPC No. 30553	Description
SL 518	70100-0	Plastering Hawk 8"x8"
SL 517	70104-8	Plastering Hawk 9"x9"
SL 522	70106-9	Plastering Hawk 10"x10"
SL 519	70101-7	Plastering Hawk 12"x12"
SL 520	70102-4	Plastering Hawk 13"x13"
SL 521	70103-1	Plastering Hawk 13-1/2"x13-1/2"

### Contractor Wood Line Blocks



- Size: 4"x1-1/8"
- Made of hard wood
- Grips the wall tightly

Product No.	UPC No. 30553	Description
SL LB2	75119-7	Mason Line Blocks - 2 per card

Available in bulk

### Contractor Wood Floats

Product No.	UPC No. 30553	Description
SL 529	23018-0	Clear Red Wood Float 12"x5"
SL 528	23020-3	Clear Red Wood Float Beveled 15"x3-1/2"



SL 529

SL 528

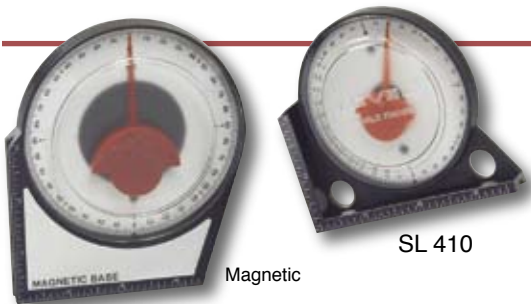

SL 420

Magnetic

SL 410



SL 450

### Dial levels • Carpenter Pencils

Product No.	UPC No. 30553	Description
SL 410*	80101-4	Degree Meter/Angle Finder
SL 420*	80102-4	Degree Meter/Angle Finder w/ Magnetic Base
SL 450	80105-2	Carpenter Pencil (2) Per Card

- Easy to read degree graduations for setting angles
- Available magnetic and non magnetic



**Rapid Square®**

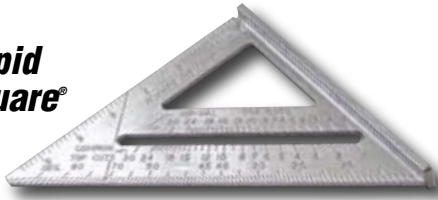

- Lightweight but durable
- Easy to read permanent graduations
- 5 tools in 1  
(try square, miter square, protractor, inscriber & saw guide)

Product No.	UPC No.	Description
SL RS45	45100-4	Rapid Square® - 7" with Manual
SL RS45B	45015-9	Rapid Square® - 7" (Bulk pk 30) w/o Manual

**Sliding T-Bevel**



- Chrome plated steel  
8" blade
- Solid plastic handle with hand groove and thumb locking screw for securing blade
- Used for testing bevels, duplicating angles and rafter cuts

Product No.	UPC No.	Description
SL 430*	80103-8	Try & Mitre
SL 440*	80104-5	T-Bevel - Plastic Handle



**Try & Mitre**

**Angle - Stair Gauge**



- Solid brass
- Attach to metal carpenter square for accurate, repeat angle cuts on rafters, stairs, etc.

Product No.	UPC No.	Description
SL 460	80106-9	Angle-Stair Gauge - 2 Per Pkg

**Cast Aluminum Level Pack w/ Torpedo Level & Case**



Product No.	UPC No.	Description
SL4848CAT	10220-3	48" Cast Aluminum Level w/ Case & Torpedo Level

**Mahogany Wood Level w/ Case**



Product No.	UPC No.	Description
SL12AB24C	10103-9	24" Brass Bound Level w/ Case
SL12AB48C	91101-0	48" Brass Bound Level w/ Case

*Sand's Levels Tell The Truth®*

\*See page 130

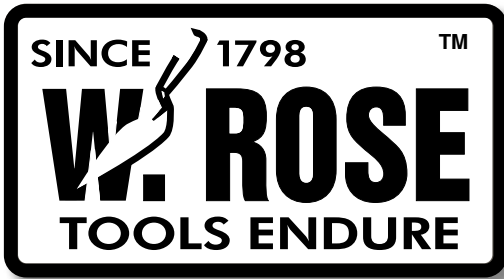

*The World's Finest  
BrickLayers Tools  
—Since 1798—*



**Professional Quality unsurpassed by any other manufacturer!**

**Strongest  
Blade**

*Blade and tang  
forged in one piece  
with a special heat  
tempered process  
for a strong and  
durable blade*



**Great  
Flexibility**

*Special taper  
grind and superior  
flexibility in every  
blade*



**Variety of  
Handle Styles**

*Comfortable contoured  
handle. Available in  
ProForm®, Wood,  
Leather, and Plastic.  
Well balanced for less  
fatigue*



**ProForm® Grip**

**NEW!... Tough durable soft grip handle.**

*Soft textured handle provides the mason a comfortable firm grip.  
Handle and blade well balanced for less wrist and arm fatigue.*

ProForm® W. Rose™  
Trowel Handle  
(US PATENT  
#D508638)

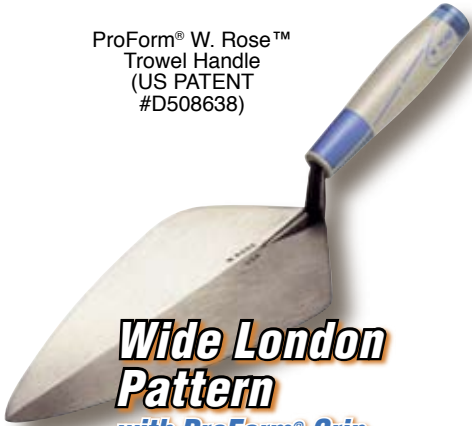

**Wide London  
Pattern  
with ProForm® Grip**

**Wide London Pattern**

Part NO.#	Blade	Heel Width
RO112-9SH	9"	5-1/4"
RO112-9-1/2SH	9-1/2"	5-3/8"
RO112-10SH	10"	5-1/2"
RO112-10-1/2SH	10-1/2"	5-1/2"
RO112-11SH	11"	5-5/8"
RO112-11-1/2SH	11-1/2"	5-3/4"
RO112-12SH	12"	5-13/16"

Wide London  
Blade Pattern

**Narrow London  
Pattern  
with ProForm® Grip**

**Narrow London Pattern**

Part NO.#	Blade	Heel Width
RO116-9SH	9"	4-3/16"
RO116-9-1/2SH	9-1/2"	4-1/4"
RO116-10SH	10"	4-1/2"
RO116-10-1/2SH	10-1/2"	4-5/8"
RO116-11SH	11"	4-3/4"
RO116-11-1/2SH	11-1/2"	4-7/8"
RO116-12SH	12"	5"
RO116-12-1/2SH	12-1/2"	5-1/4"
RO116-13SH	13"	5-3/8"

Narrow London  
Blade Pattern

**Philadelphia  
Pattern  
with ProForm® Grip**

**Philadelphia Pattern**

Part NO.#	Blade	Heel Width
RO110-9SH	9"	5-1/8"
RO110-9-1/2SH	9-1/2"	5-3/16"
RO110-10SH	10"	5-1/4"
RO110-10-1/2SH	10-1/2"	5-3/8"
RO110-11SH	11"	5-7/16"
RO110-11-1/2SH	11-1/2"	5-1/2"
RO110-12SH	12"	5-9/16"

Philadelphia  
Blade Pattern

**Same W. Rose™ Trowel with New Soft Grip Handle!**



# Narrow London Pattern

W. Rose™ Brick Trowels have been made of one piece forged steel for over 200 years

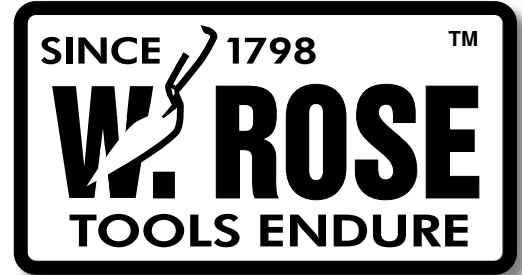
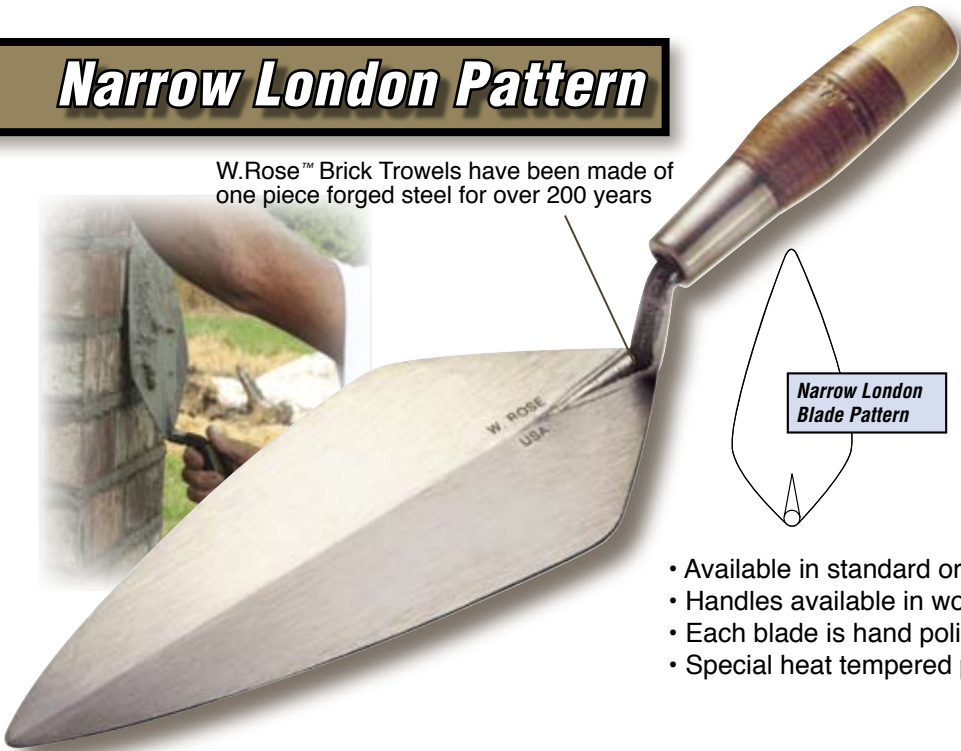

W. Rose™ trowels are also available with limber blades, please specify type and size.

- Available in standard or low lift shank
- Handles available in wood, leather or plastic
- Each blade is hand polished for comfort and flexibility
- Special heat tempered process gives extra strength to blade

STANDARD SHANK					STANDARD SHANK		LOW LIFT SHANK	
6" Wood Handle	Leather Handle	Plastic Handle	Blade Length	Heel Width	5" Wood Handle	5" Wood Handle	Blade Length	Heel Width
RO116-9	RO316-9	RO1416-9	9"	4-3/16"	RO416-9	RO486-9	9"	4-3/16"
RO116-9-1/2	RO316-9-1/2	RO1416-9-1/2	9-1/2"	4-1/4"	RO416-9-1/2	RO486-9-1/2	9-1/2"	4-1/4"
RO116-10	RO316-10	RO1416-10	10"	4-1/2"	RO416-10	RO486-10	10"	4-1/2"
RO116-10-1/2	RO316-10-1/2	RO1416-10-1/2	10-1/2"	4-5/8"	RO416-10-1/2	RO486-10-1/2	10-1/2"	4-5/8"
RO116-11	RO316-11	RO1416-11	11"	4-3/4"	RO416-11	RO486-11	11"	4-3/4"
RO116-11-1/2	RO316-11-1/2	RO1416-11-1/2	11-1/2"	4-7/8"	RO416-11-1/2	RO486-11-1/2	11-1/2"	4-7/8"
RO116-12	RO316-12	RO1416-12	12"	5"	RO412-12	RO486-12	12"	5"
RO116-12-1/2	RO316-12-1/2	RO1416-12-1/2	12-1/2"	5-1/4"	RO416-12-1/2	RO486-12-1/2	12-1/2"	5-1/4"
RO116-13	RO316-13	RO1416-13	13"	5-3/8"	RO416-13	RO486-13	13"	5-3/8"

LOW LIFT SHANK					LOW LIFT SHANK		LOW LIFT SHANK		
6" Wood Handle	Leather Handle	Plastic Handle	Blade Length	Heel Width	6" Wood Handle	Leather Handle	Plastic Handle	Blade Length	Heel Width
RO186-9	RO386-9	RO1486-9	9"	4-3/16"	RO186-9	RO386-9	RO1486-9	9"	4-3/16"
RO186-9-1/2	RO386-9-1/2	RO1486-9-1/2	9-1/2"	4-1/4"	RO186-9-1/2	RO386-9-1/2	RO1486-9-1/2	9-1/2"	4-1/4"
RO186-10	RO386-10	RO1486-10	10"	4-1/2"	RO186-10	RO386-10	RO1486-10	10"	4-1/2"
RO186-10-1/2	RO386-10-1/2	RO1486-10-1/2	10-1/2"	4-5/8"	RO186-10-1/2	RO386-10-1/2	RO1486-10-1/2	10-1/2"	4-5/8"
RO186-11	RO386-11	RO1486-11	11"	4-3/4"	RO186-11	RO386-11	RO1486-11	11"	4-3/4"
RO186-11-1/2	RO386-11-1/2	RO1486-11-1/2	11-1/2"	4-7/8"	RO186-11-1/2	RO386-11-1/2	RO1486-11-1/2	11-1/2"	4-7/8"
RO186-12	RO386-12	RO1486-12	12"	5"	RO186-12	RO386-12	RO1486-12	12"	5"
RO186-12-1/2	RO386-12-1/2	RO1486-12-1/2	12-1/2"	5-1/4"	RO186-12-1/2	RO386-12-1/2	RO1486-12-1/2	12-1/2"	5-1/4"
RO186-13	RO386-13	RO1486-13	13"	5-3/8"	RO186-13	RO386-13	RO1486-13	13"	5-3/8"

- Low lift shank trowels have a lower handle angle for a comfortable feel.

Choice of Wood  
Leather or  
Plastic Handle.



## The World's Finest Since 1798

W. Rose™ is a wholly owned subsidiary of Kraft Tool Co.®

# Philadelphia Pattern

Blade and tang forged in one piece with a special heat tempered process for a strong and durable blade

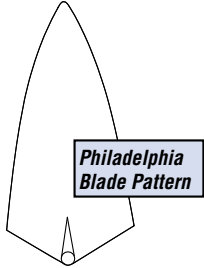

Philadelphia Blade Pattern



Choice of Wood  
Leather or  
Plastic Handle.



W. Rose™  
Book of Tools  
from 1929



STANDARD SHANK		STANDARD SHANK		STANDARD SHANK		Blade Length	Heel Width
Wood Handle	Leather Handle	Wood Handle	Leather Handle	Wood Handle	Leather Handle		
RO110-9	RO310-9	RO1410-9	9"	5-1/8"			
RO110-9-1/2	RO310-9-1/2	RO1410-9-1/2	9-1/2"	5-3/16"			
RO110-10	RO310-10	RO1410-10	10"	5-1/4"			
RO110-10-1/2	RO310-10-1/2	RO1410-10-1/2	10-1/2"	5-3/8"			
RO110-11	RO310-11	RO1410-11	11"	5-7/16"			
RO110-11-1/2	RO310-11-1/2	RO1410-11-1/2	11-1/2"	5-1/2"			
RO110-12	RO310-12	RO1410-12	12"	5-9/16"			

Choice of Wood Leather  
or Plastic Handle.

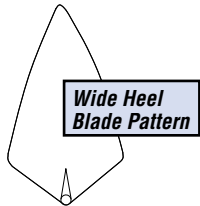

Wide Heel Blade Pattern

## WIDE HEEL PATTERN

Wood Handle (standard shank)	Leather Handle (standard shank)	Plastic Handle (standard shank)	Blade	Heel Width
RO221-10	RO321-10	RO1421-10	10"	6"
RO221-10-1/2	RO321-10-1/2	RO1421-10-1/2	10-1/2"	6"
RO221-11	RO321-11	RO1421-11	11"	6"
RO221-11-1/2	RO321-11-1/2	RO1421-11-1/2	11-1/2"	6"
RO221-12	RO321-12	RO1421-12	12"	6-1/8"

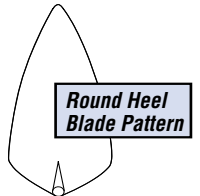

Round Heel Blade Pattern

## NARROW ROUND HEEL PATTERN

WOOD HANDLE (STANDARD SHANK)	LEATHER HANDLE (STANDARD SHANK)	PLASTIC HANDLE (STANDARD SHANK)	BLADE	HEEL WIDTH
RO113-10	RO313-10	RO1413-10	10	5"
RO113-10-1/2	RO313-10-1/2	RO1413-10-1/2	10-1/2"	5-1/16"
RO113-11	RO313-11	RO1413-11	11"	5-1/8"
RO113-11-1/2	RO313-11-1/2	RO1413-11-1/2	11-1/2"	5-1/4"
RO113-12	RO313-12	RO1413-12	12"	5-5/16"



W. Rose™ blades are unmatched in the industry for strength and flexibility

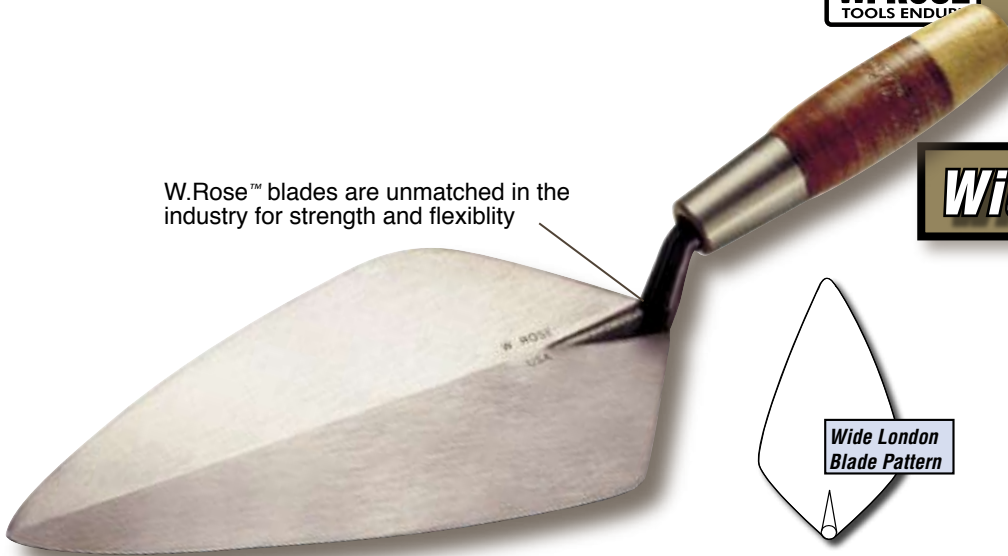

## Wide London Pattern

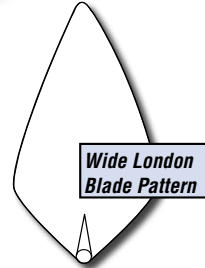
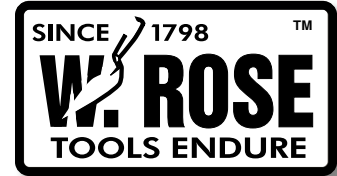

### STANDARD SHANK



Model	Blade	Heel Width
RO112-9	9"	5-1/4"
RO112-9-1/2	9-1/2"	5-3/8"
RO112-10	10"	5-1/2"
RO112-10-1/2	10-1/2"	5-1/2"
RO112-11	11"	5-5/8"
RO112-11-1/2	11-1/2"	5-3/4"
RO112-12	12"	5-13/16"

### STANDARD SHANK



Model	Blade	Heel Width
RO312-9	9"	5-1/4"
RO312-9-1/2	9-1/2"	5-3/8"
RO312-10	10"	5-1/2"
RO312-10-1/2	10-1/2"	5-1/2"
RO312-11	11"	5-5/8"
RO312-11-1/2	11-1/2"	5-3/4"
RO312-12	12"	5-13/16"

### STANDARD SHANK



Model	Blade	Heel Width
RO1412-9	9"	5-1/4"
RO1412-9-1/2	9-1/2"	5-3/8"
RO1412-10	10"	5-1/2"
RO1412-10-1/2	10-1/2"	5-1/2"
RO1412-11	11"	5-5/8"
RO1412-11-1/2	11-1/2"	5-3/4"
RO1412-12	12"	5-13/16"

### STANDARD SHANK



Model	Blade	Heel Width
RO412-9	9"	5-1/4"
RO412-9-1/2	9-1/2"	5-3/8"
RO412-10	10"	5-1/2"
RO412-10-1/2	10-1/2"	5-1/2"
RO412-11	11"	5-5/8"
RO412-11-1/2	11-1/2"	5-3/4"
RO412-12	12"	5-13/16"

### LOW LIFT SHANK



Model	Blade	Heel Width
RO482-9	9"	5-1/4"
RO482-9-1/2	9-1/2"	5-3/8"
RO482-10	10"	5-1/2"
RO482-10-1/2	10-1/2"	5-1/2"
RO482-11	11"	5-5/8"
RO482-11-1/2	11-1/2"	5-3/4"
RO482-12	12"	5-13/16"

### LOW LIFT SHANK



Model	Blade	Heel Width
RO182-9	9"	5-1/4"
RO182-9-1/2	9-1/2"	5-3/8"
RO182-10	10"	5-1/2"
RO182-10-1/2	10-1/2"	5-1/2"
RO182-11	11"	5-5/8"
RO182-11-1/2	11-1/2"	5-3/4"
RO182-12	12"	5-13/16"

### LOW LIFT SHANK



Model	Blade	Heel Width
RO382-9	9"	5-1/4"
RO382-9-1/2	9-1/2"	5-3/8"
RO382-10	10"	5-1/2"
RO382-10-1/2	10-1/2"	5-1/2"
RO382-11	11"	5-5/8"
RO382-11-1/2	11-1/2"	5-3/4"
RO382-12	12"	5-13/16"

### LOW LIFT SHANK



Model	Blade	Heel Width
RO1482-9	9"	5-1/4"
RO1482-9-1/2	9-1/2"	5-3/8"
RO1482-10	10"	5-1/2"
RO1482-10-1/2	10-1/2"	5-1/2"
RO1482-11	11"	5-5/8"
RO1482-11-1/2	11-1/2"	5-3/4"
RO1482-12	12"	5-13/16"

• Low lift shank trowels have a lower handle angle for a comfortable feel.



Choice of Wood  
Leather or  
Plastic Handle.

## Replacement Handles



**ProForm® Handle - RO1000**  
ProForm® unique soft textured contoured handle. Tough rugged and well balance.



**6" Wood Handle - RO100**  
Smooth comfortable 6" wood handle with steel ferrule.



**5" Wood Handle - RO400**  
Smooth comfortable 5" wood handle with steel ferrule.



**Leather Handle - RO300**  
5-1/2" seasoned wood handle wrapped with genuine leather to provide a smooth comfortable grip. Fitted with steel ferrule.



**Plastic Handle - RO1400**  
Clear/amber 5-1/4" plastic handle. Tough and rugged handle will not mushroom from tamping bricks or concrete blocks.

All handles Sold in cartons of (6)

# Specialty Patterns

**Pointing Trowel**



Sold in cartons of (6)

**Pointing Trowel (standard shank)**

Part NO#	Blade	Heel Width
<b>5" Wood Handle</b>		
RO50W	7"	3-1/4"
<b>5-1/2" Leather Handle</b>		
RO50L	7"	3-1/4"

**Buttering Trowel**



Sold in cartons of (6)

**Buttering Trowel (standard shank)**

Part NO#	Blade	Heel Width
<b>5" Wood Handle (standard shank)</b>		
RO74	7-1/2"	3-1/2"

**Sewer Trowel**



Sold in cartons of (6)

**Sewer Trowel (standard shank)**

Part NO#	Blade	Heel Width
<b>5" Wood Handle</b>		
RO427	9-1/2"	6"

**Tile Trowels**



RO75

RO55

Sold in cartons of (6)

**Tile Trowel (standard shank)**

Part NO#	Blade	Heel Width
<b>5" Wood Handle</b>		
RO75	7"	3-3/16"
RO55	7-1/2"	4-7/16"



**Pumpkin Trowel**



Sold in cartons of (6)



**Pumpkin Trowel (standard shank)**

Part NO#	Blade	Heel Width
<b>6" Wood Handle</b>		
RO414-9	9"	4-3/4"

**Mud Trowel**



Sold in cartons of (6)



**Mud Trowel (standard shank)**

Part NO#	Blade	Heel Width
<b>6" Wood Handle</b>		
RO6302	7-1/2"	5-3/8"

**Bucket Trowel**



Sold in cartons of (6)



**Bucket Trowel (standard shank)**

Part NO#	Blade	Heel Width
<b>6" Wood Handle</b>		
RO6301	8"	5-3/8"

## W. ROSE® Ceremonial Trowels

Ideal for retirements, award presentations and other special occasions



### Chrome and Gold Plated Trowels

No.  
RO316-10C Chrome  
RO316-10G Gold

## PROFESSIONAL QUALITY

Corner Blocks Sold in cartons of (12)



### Corner Blocks

Part NO#  
RO2514 Plastic Corner Blocks (Pair)

Line Pins Sold in cartons of (12)



Precision forged heavy-duty steel line pins. Hand polished.

### Line Pins

Part NO#  
RO2122 Steel Line Pins (Each)

SINCE 1798  
**W. ROSE**  
TOOLS ENDURE



#216 lb. test

### SUPER TOUGH

### Bonded Braided Nylon Line

Part NO# Size  
RO685 685' Yellow with black marker strand

All W.Rose™ Jointers & Slickers go through a special heat tempered process for hardness and long wear, then are hand polished for a smooth perfect joint.

**Grapevine Jointer** 

- Heat tempered & hand polished

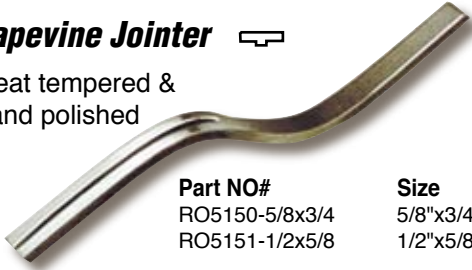

Sold in cartons of (12)

Part NO#	Size
RO5150-5/8x3/4	5/8"x3/4"
RO5151-1/2x5/8	1/2"x5/8"

**Bullhorn Jointer** 

- Heat tempered & hand polished

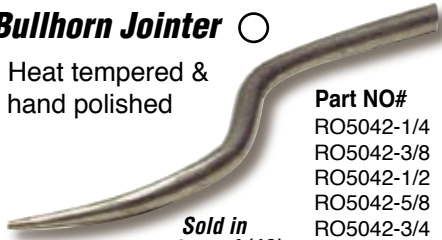

Sold in cartons of (12)

Part NO#	Size
RO5042-1/4	1/4" (large end)
RO5042-3/8	3/8" (large end)
RO5042-1/2	1/2" (large end)
RO5042-5/8	5/8" (large end)
RO5042-3/4	3/4" (large end)
RO5042-7/8	7/8" (large end)

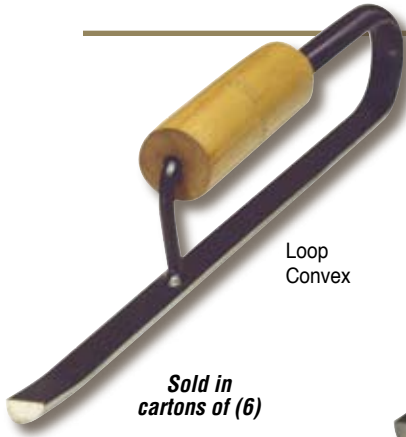

Loop Convex

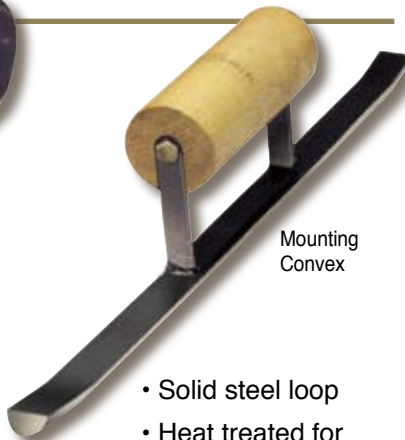

Mounting Convex

Sold in cartons of (6)

**Sled Runners** 

Part NO#	Size
RO5140-3/8	Loop Convex 3/8"
RO5140-1/2	Loop Convex 1/2"
RO5140-5/8	Loop Convex 5/8"
RO5140-3/4	Loop Convex 3/4"

RO5141-1/2	Mounting Convex 1/2"
RO5141-5/8	Mounting Convex 5/8"
RO5141-3/4	Mounting Convex 3/4"



- Solid steel loop
- Heat treated for long wear

Available in 2 sizes



**Carbide Tipped Tile Hammer**

Part NO#	Size
RO3122-5/8C	8 oz. head, 5/8" face Carbide tipped
RO3122-3/4	12 oz. head, 3/4" face w/o carbide
RO3122-5/8	8 oz. head, 5/8" face w/o carbide

**Convex Jointer** 

Sold in cartons of (12)



Part NO#	Size
RO5121-3/8x1/2	3/8"x1/2"
RO5121-1/2x5/8	1/2"x5/8"
RO5121-5/8x3/4	5/8"x3/4"
RO5121-3/4x7/8	3/4"x7/8"
RO5121-7/8x1	7/8"x1"
RO5121-1x1-1/8	1"x1-1/8"
RO5121-1-1/8x1-1/4	1-1/8"x1-1/4"

**Concave Jointer** 

Sold in cartons of (12)



Part NO#	Size
RO5321-3/8x1/2	3/8"x1/2"
RO5321-1/2x5/8	1/2"x5/8"
RO5321-5/8x3/4	5/8"x3/4"
RO5321-3/4x7/8	3/4"x7/8"
RO5321-7/8x1	7/8"x1"
RO5321-1x1-1/8	1"x1-1/8"

Sold in cartons of (12)

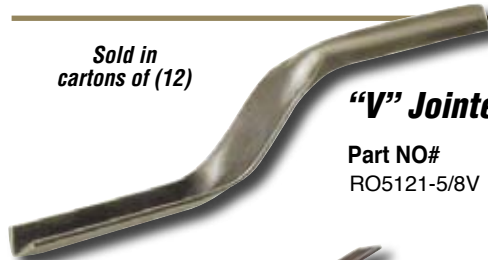

**"V" Jointer** 

Part NO#	Size
RO5121-5/8V	5/8"x5/8"

Sold in cartons of (12)

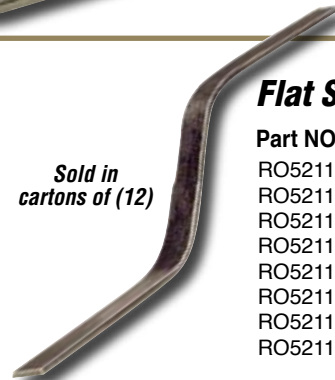

**Flat Slicker** 

Part NO#	Size
RO5211-1/4x3/8	1/4"x3/8"
RO5211-3/8x1/2	3/8"x1/2"
RO5211-1/2x5/8	1/2"x5/8"
RO5211-5/8x3/4	5/8"x3/4"
RO5211-3/4x7/8	3/4"x7/8"
RO5211-7/8x1	7/8"x1"
RO5211-1x1-1/8	1"x1-1/8"
RO5211-1-1/8x1-1/4	1-1/8"x1-1/4"



**Brick Hammer**

Part NO#	Size
RO3131-24	24 oz. head

CAUTION: Be safe always wear safety goggles

## Professional Quality Brick Trowels

- One piece forging made from the highest grade trowel steel
- Taper ground for flexibility
- Precision balanced
- Fitted with hardwood handle

### Replacement Handle

No.	Size
BL101	6" Hardwood

### Narrow London

No.	Blade Size
BL703	10"x4-3/4"
BL704	10-1/2"x4-3/4"
BL705	11"x5"
BL706	11-1/2"x5"
BL707	12"x5"
BL709	13"x5"

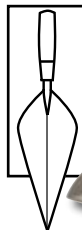

### Rubber Tip for Brick Trowel Handle

No.
BL104



### Philadelphia

No.	Blade Size
BL750	10"x5-3/8"
BL752	11"x5-1/2"
BL754	12"x5-5/8"

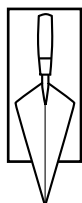

### Wide London

No.	Blade Size
BL723	10"x5-1/2"
BL729	11"x5-1/2"
BL772	12"x5-1/2"

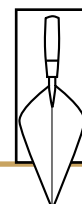

### Bucket Trowel

End of blade is cut off diagonally for use in bucket or mortar box.

No.	Size
BL700	6"



### Fortex® Pail

These popular fortex black rubber pails won't rust, dent, leak or chip. They aren't affected by heat or cold, acids, alkalis and most other chemicals.

No.	Size
GG459	8 qt. Lightweight utility
GG460	10 qt. Standard
GG462	12 qt. Heavy-duty w/lip
GG463	12 qt. Heavy-duty
GG464	18 qt. Utility w/lip



### Variable Convex Jointer



**EXTRA HARD**

Extra hard tempered steel jointer for tile, brick and mortar joints. Produces smooth half round sunken joints. Jointer tapers from 5/8" to 7/8" on curvature. Legs measure 3-1/2" and 4-1/4" long. Easy to handle tool adjusts to various joint widths.

No.	Size
BL660	Variable Convex Jointer <b>NEW</b>

### Skate Wheel Joint Raker

Masons love this big wheeled joint raker. Wheels are 1-3/4" in diameter, mounted 1-3/4" apart. Overall width is 3". Has 8-1/2" aluminum handle that is squared off at the end so you can rod joints. Hardened nail is adjusted for depth.

No.
BL210



### Aluminum Solid Wheel Joint Raker

Has solid steel wheels which bridge the joint and has an adjustable nail for raking joints. The aluminum handle can be used for tooling joints.

No. BL209



### Duck Bill Trowel

No.	Blade Size
GG444	10"Lx2" wide heel w/ Wood Handle
GG444L	10"Lx2" wide heel w/ Leather Handle
GG444PF	10"Lx2" wide heel w/ ProForm® Handle



## Specialty Trowels

- One piece forged
- Tempered, ground and polished for perfect balance

### Buttering Trowel



No.	Blade Size
GG441	7"Lx4-3/8" wide heel w/ Wood Handle
GG441L	7"Lx4-3/8" wide heel w/ Leather Handle
GG441PF	7"Lx4-3/8" wide heel w/ ProForm® Handle



### Gauging Trowel



No.	Blade Size
GG443	7"Lx3-1/4" wide heel w/ Wood Handle
GG443L	7"Lx3-1/4" wide heel w/ Leather Handle
GG443PF	7"Lx3-1/4" wide heel w/ ProForm® Handle



### Cross-Joint Trowel



No.	Blade Size
GG445	5"Lx1-3/4" wide heel w/ Wood Handle
GG445L	5"Lx1-3/4" wide heel w/ Leather Handle
GG445PF	5"Lx1-3/4" wide heel w/ ProForm® Handle



### Margin Trowels



- One piece forged
- Tempered, ground, and polished for perfect balance

#### WOOD HANDLE

No.	Blade Size
GG431	5"x1-1/2"
GG432	5"x2"
GG434	6"x2"
GG433	8"x2"

#### LEATHER HANDLE

No.	Blade Size
GG431L	5"x1-1/2" <b>NEW</b>
GG432L	5"x2" <b>NEW</b>
GG434L	6"x2" <b>NEW</b>
GG433L	8"x2" <b>NEW</b>

#### PROFORM® HANDLE

No.	Blade Size
GG431PF	5"x1-1/2" <b>NEW</b>
GG432PF	5"x2" <b>NEW</b>
GG434PF	6"x2" <b>NEW</b>
GG433PF	8"x2" <b>NEW</b>

### Pointing Trowels



- One piece forged
- Tempered, ground, and polished for perfect balance

#### WOOD HANDLE

No.	Blade Size
GG421	4-1/2"x2-1/4"
GG422	5-1/2"x2-1/2"
GG423	7"x3"
GG424	5"x2-1/2"

#### LEATHER HANDLE

No.	Blade Size
GG421L	4-1/2"x2-1/4" <b>NEW</b>
GG422L	5-1/2"x2-1/2" <b>NEW</b>
GG423L	7"x3" <b>NEW</b>
GG424L	5"x2-1/2" <b>NEW</b>

#### PROFORM® HANDLE

No.	Blade Size
GG421PF	4-1/2"x2-1/4" <b>NEW</b>
GG422PF	5-1/2"x2-1/2" <b>NEW</b>
GG423PF	7"x3" <b>NEW</b>
GG424PF	5"x2-1/2" <b>NEW</b>

### Caulking Trowels



- One piece forged
- Tempered, ground, and polished for perfect balance
- Ideal for tuckpointing

#### WOOD HANDLE

No.	Blade Size
BL761	7"x3/16"
BL762	7"x1/4"
BL763	7"x3/8"
BL764	7"x1/2"
BL765	7"x5/8"
BL766	7"x3/4"
BL767	7"x7/8"
BL768	7"x1"

#### LEATHER HANDLE

No.	Blade Size
BL761L	7"x3/16" <b>NEW</b>
BL762L	7"x1/4" <b>NEW</b>
BL763L	7"x3/8" <b>NEW</b>
BL764L	7"x1/2" <b>NEW</b>
BL765L	7"x5/8" <b>NEW</b>
BL766L	7"x3/4" <b>NEW</b>
BL767L	7"x7/8" <b>NEW</b>
BL768L	7"x1" <b>NEW</b>

#### PROFORM® HANDLE

No.	Blade Size
BL761PF	7"x3/16" <b>NEW</b>
BL762PF	7"x1/4" <b>NEW</b>
BL763PF	7"x3/8" <b>NEW</b>
BL764PF	7"x1/2" <b>NEW</b>
BL765PF	7"x5/8" <b>NEW</b>
BL766PF	7"x3/4" <b>NEW</b>
BL767PF	7"x7/8" <b>NEW</b>
BL768PF	7"x1" <b>NEW</b>

### Deluxe Canvas Tool Bags with leather bottom

Our finest quality heavy-duty canvas and leather reinforced bags for masons, mechanics, and linemen. Made with 12 gauge steel hinged frame and heavy #10 canvas, this bag is made for heavy work and long-lasting wear. Leather reinforcing on the bottom and 3" up on the sides. Inside 9"x11" pocket. Waterproof bottom board.

No.	Size
WL180	14"x18"
WL200	14"x20"
WL220	14"x22"



### Standard Canvas Tool Bags

An expertly made bag, deep and roomy, built around a 12 gauge steel hinged frame. Leather handles, buckles and canvas are riveted into the frame. Lock-stitched sewing assures long life. A masonite bottom board provides waterproofing. 9"x11" inside pocket.

No.	Size
WL018	14"x18"
WL020	14"x20"
WL024	14"x24"



### Economy Tool Bag

Economical 20" wide canvas tool bag. A lightweight but sturdy all-purpose bag. Two steel dowels are sewn into casings and a masonite bottom board holds the bag in shape.

No.	Size
WL050	13"x20"x12"



# Jointers

## "The Original" -Hubbard Jointers-



Made in U.S.A.

Hubbard jointer was designed by a bricklayer in the business for 60 years. More knuckle clearance, replaceable blades, long lasting. Jointer comes assembled with one 1/2" blade, one 5/8" blade, one 3/4" blade, and one 7/8" blade is included in set. Keep the handle - replace the blades. Overall length 8-1/2".

No.	Size
BL280	Jointer...with 1/2", 5/8", 3/4", 7/8" blades
BL281	1/2" Replaceable blade
BL282	5/8" Replaceable blade
BL283	3/4" Replaceable blade
BL284	7/8" Replaceable blade



### Brick Jointers

Made of high carbon steel

Each end makes a different size joint. Overall length 10-1/2".

No.	Size
BL260	3/8"x1/2"
BL261	1/2"x5/8"
BL262	5/8"x3/4"
BL264	3/4"x7/8"
BL265	7/8"x1"

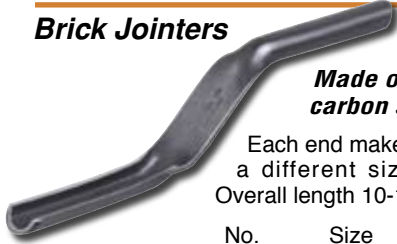

### Diamond "V" Head Jointers

Really nice for striking head joints. Forged from carbon steel. Overall length 9".

No.	Size
BL290	1/2"
BL291	5/8"

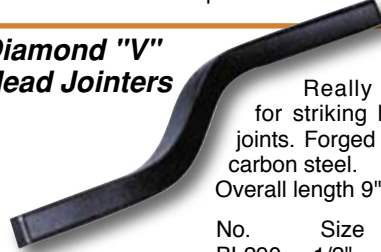

### Heavyweight Convex Jointers

Large at one end, tapered at the other to produce half round sunken joints.

No.	Size
BL270	9-1/2"x1/2"
BL271	9-1/2"x5/8"
BL272	9-1/2"x3/4"



### Plexiglass Jointers

Use this plexiglass jointer for white mortar. Will not discolor or leave black marks. Overall length 11-1/4".

No.	Size
BL273	1/4"
BL274	3/8"
BL276	1/2"
BL277	5/8"
BL278	3/4"

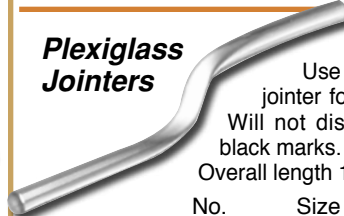

### Double End Grapevine Jointers

Forged from high quality tool steel. Overall length 8".

No.	Width	Center Groove
BL402	1/2"	1/8"
BL403	5/8"	1/8"



### Brick & Stone Marker

A cutting tool for producing imitation brick and stone. Lightweight aluminum tool for cutting out mortar joints also. Heat treated blade is 1/2" wide. Overall length 10".

No.	
BL207	Cutter with blade
BL208	Extra blade



### Double Blade Slicker

Forged from the highest grade carbon steel. Each end makes a different size joint. Overall length 11-1/4".

No.	Size
BL201	1/4"x3/8"
BL202	1/2"x5/8"



### Kraft (Ultra Hard) S Jointers

The patented "S" curve allows you to approach or maintain different pitch angles while jointing the mortar. Long wearing. Overall length 9-1/4".

No.	Size
BL160	3/8"x1/2"
BL161	1/2"x5/8"
BL162	5/8"x3/4"
BL164	7/8"x3/4"
BL165	7/8"x1"

U.S. Patent #4,879,780



### Combination Raker-Jointer

Raker-jointer is used on rough materials such as adobe brick, split stone, and split block. It has a 3/4" jointer on one end, and a 5/16" raker blade at the other end. Overall length 10".

No.	
BL205	

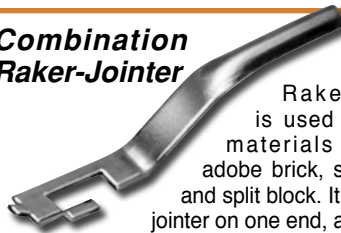

### Stone & Brick Bearer (Grapevine)

Produces 5/16" raised joints for that popular Southern look. Double end. Overall length 11-1/2".

No.	Size
BL405	5/16"

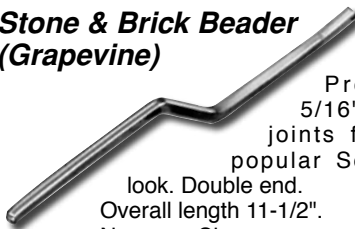

### Lightweight Concave Stone Beaders

Produces raised half round beaded joints. Each beader provides 2 size beads. Overall length 10-1/2".

No.	Size
BL140	3/8"x1/2"
BL141	5/8"x3/4"

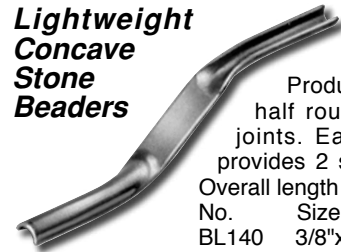

### Low Cost Joint Raker

Lets you work where you can't with a wheeled jointer. The 5/16" joint raker is offset to throw out mortar as you rake. A 5/16" and 3/8" tab at the ends help you rake the corners. Overall length 8".

No.	
BL103	



### Grapevine Jointer

Forged carefully from high carbon steel, this jointer is especially convenient when the job calls for this special joint. 6"x1/2" blade.

No.	Size
BL401	Bit 1/8" wide on center of blade w/ wood handle
BL401L	Bit 1/8" wide on center of blade w/ leather handle
BL401PF	Bit 1/8" wide on center of blade w/ PF handle



### "Half Round Convex" Sled Runners



With Wood Handle

With ProForm® Handle

- The best tool you can get for making round sunken or rodded masonry joints
- High quality steel blade
- 14" blade turned up on one end only and 20" blade turned up on both ends

Wood Handle		ProForm® Handle	
No.	Size	No.	Size
BL215	14"x1/2"	BL215PF	
BL216	14"x5/8"	BL216PF	
BL217	14"x3/4"	BL217PF	
BL229	20"x1/2"	BL229PF	
BL226	20"x5/8"	BL226PF	
BL227	20"x3/4"	BL227PF	

### "V" Sled Runners



With Wood Handle

With ProForm® Handle

- High quality steel blade
- Very handy in block construction
- Makes perfect horizontal "V" joints.

Wood Handle		ProForm® Handle	
No.	Size	No.	Size
BL214	14"x3/4"	BL214PF	
BL220	20"x3/4"	BL220PF	

## Hubbard Sled Runners

### "The Original"

- The ideal tool for making half-round sunken joints
- Hubbard sled runner operates on the same principle as the jointer
- Cast aluminum blade holder with wood handle
- Replaceable blade is made of 3/4" diameter case hardened steel
- Turning the blade during use, helps distribute wear.



Available in 2 Lengths

**Made in U.S.A.**

No.	Size
BL286	14" Sled Runner w/ (3/4" blade)
BL285	5/8" Replacement blade
BL287	3/4" Replacement blade
BL288	7/8" Replacement blade
BL470	16" Sled Runner w/ (3/4" blade)
BL471	5/8" Replacement blade
BL472	3/4" Replacement blade
BL473	7/8" Replacement blade

## Sled Runners

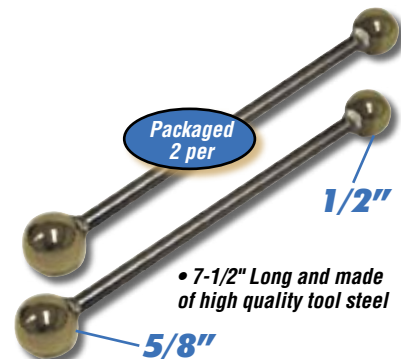

• 7-1/2" Long and made of high quality tool steel

5/8"

Faster jointing • Even wear • Longer life



Made in U.S.A.

### BL390

- Round head - joints in all directions
- Eliminates changing hand or positions
- Keeps knuckles away from wall
- When using fast setting mortar, the Masonry Barbell Jointer™ allows you to put more pressure with less effort

## E-Jointers

**NEW!!** E-Jointers are lightweight made of 1/2" round steel and perfectly balanced. They are easy to use and carry. Designed to fit easily in your pocket leaving the mortar on the outside. They come in 1/2" and 5/8" thickness.

**Fluted Block Mortar Scratcher BL240**  
They are the same shape as the space between the flutes of block. Use the back to pack in the mortar before scratching it out with one upward sweep.

**Stone Mortar Scratcher BL241**  
Flared and flattened on the end to scratch mortar away from the edge of the stone.

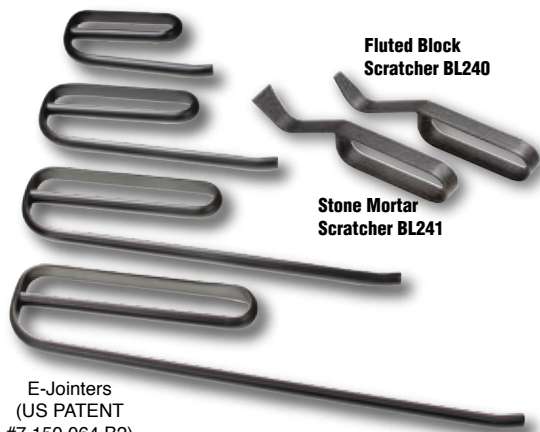

Fluted Block Scratcher BL240

Stone Mortar Scratcher BL241

E-Jointers (US PATENT #7,150,064 B2)



No.	Size
BL236 -1/2	E Jointer 6"x1/2"
BL236 -5/8	E Jointer 6"x5/8"
BL237-1/2	E Jointer 9"x1/2"
BL237-5/8	E Jointer 9"x5/8"
BL238-1/2	E Jointer 12"x1/2"
BL238-5/8	E Jointer 12"x5/8"
BL239-1/2	E Jointer 15"x1/2"
BL239-5/8	E Jointer 15"x5/8"

BL240	Fluted block mortar scratcher
BL241	Stone mortar scratcher

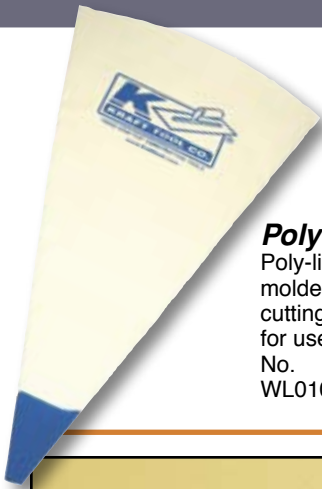

### Poly-Lined Grout Bag

Poly-lined grout bag has a soft 3/8" tip molded in. Size of tip can be increased by cutting small amount off with scissors. Ideal for use in grouting masonry or tile joints.

No.	Size
WL010	13"x23"



### Cone-Shaped Heavy-Duty Vinyl Bag

Cone-shaped heavy-duty vinyl bag comes complete with removable tip.

No.	Size
WL013	10-1/2"x24" Large
WL015	3/8" Replacement tip

WL014	15"x28" Giant
WL019	7/16" Replacement tip



**Curved Handle Wire Brush**

**Wire Duster Brush**

### Curved Handle Wire Brush

Round tempered wire. Removes rust, metal burrs, paint and varnish. Great for cleaning tools. 19" overall length. 3 rows of bristles with 2-5/8" trim.

No.	Size
BL467	19" Curved handle wire brush

### Wire Duster Brush

Rounded tempered steel wire. Great for dusting and removing metal chips. 9-1/2" overall length. 2-5/8" trim.

No.	Size
BL468	9-1/2" Wire duster brush

### Finger Tape

Protect fingers from abrasions and cuts by wrapping individual fingers with cloth finger tape. 180' per roll.

No.	Size
BL400	3/4"x180'



### Neoprene Gloves

These heavy-duty black rubber gloves give excellent protection against solvents, acids and other alkaline solutions. Gloves are 16" in length.

No.	Size
GG425-10	10
GG425-10-1/2	10-1/2
GG425-11	11



### Heavy-Duty Acid Brush w/ Scraper

Fine tampico fibered brush with 3" long fibers cemented into hardwood block. Great holding capacity with leather binding. Steel scraper blade attached to brush, great for scraping away mortar and other tough material. Comes with 14" tapered handle (BL431).

No.	BL429
	<b>NEW</b>

### HKP® Centercut Bolt Cutters

Centercut



Contractor-quality centercut boltcutter for cutting concrete reinforcing rods, soft and medium hard bolts, rods forged jaws. One-half the weight of traditional boltcutters. One-piece handles attach directly to the jaws. (50) pounds of hand pressure at handle turns into 4,000 pounds of pressure at jaw.

No.	Weight	Length
GG114	3 lbs.	14"
Capacities: soft, med., hard metals: 1/4" (7mm)		
GG115	6 lbs.	24"
Capacities: soft, med., hard metals: 3/8" (10mm.)		



### HKP® Heavy-Duty Bolt Cutters

For general heavy-duty cutting of all soft or hard metals, including concrete reinforcing rods, hard wire rope, chrome ball wire, cold drawn alloy steel, stainless steel, tempered spring wire up to Brinell 400, Rockwell C42 hardness.

No.	Weight	Length
GG124	6 lbs.	24"
Capacities: soft metal 7/16"; hard 5/16"		
GG136	14 lbs.	36"
Capacities: soft metal 9/16"; hard 7/16"		
GG142	18 lbs.	42"
Capacities: soft metal 11/16"; hard 1/2"		

(Add "01" to part number for replacement jaws)



**Heavy-Duty Acid Brush**

Masons like it because of the leather binding and holding capacity. Fine tampico fibered brush with 3" long fibers cemented into hardwood block. Uses tapered wood hdl.

No. Size  
BL430 (Brush only) 8-1/2"x2"

**Standard Acid Brush**

Use to wash down new and old masonry surfaces with muriatic acid. White tampico fibers are 6" wide, 1-3/4" thick and 3-1/2" long. 14 rows wide, 5 rows thick.

No. Size  
BL422 (Brush only)

**WOOD HANDLES**

BL431 (14" Tapered handle)  
BL432 (54" Tapered handle)  
CC163 (60" Threaded handle)

**Heavy-Duty Acid Brush**

Use this long wearing acid brush with any length handle. The smooth finished hardwood block has 18x7 rows of stiff white tampico fibers bristles 1-1/4" long. Use with tapered wood handle only.

No. Size  
BL525 8-1/4"x3"

**Acid/Cleaning Brush**

Ideal brush for cleaning equipment and other surfaces. 2-1/2" long plastic bristles are acid resistant. Use with thread wood handle only. 10" plastic block.

No. Size  
BL433

**Deck Brush**

Stiff blue filament is resistant to chemicals and holds solutions. Not affected by solvents or acids. Smooth 10"x3" hardwood block with 2" long fibers. Accepts threaded or tapered handles.

No. Size  
BL529

**Heavy-Duty Acid Brush — large**

Perfect for scrubbing rough or acid cleaning. Accepts threaded or tapered handles. Smooth 10"x3" hardwood block with 2" white tampico fibers.

No. Size  
BL528

**10" Truck Brush**

Black and white flagged soft polystyrene bristles. Soft scrubbing action on vehicles and trucks. Use with threaded handle.

No. Size  
BL435 10" truck brush



**Masonry Brushes**



**Jumbo Utility Brush**

This red handle utility brush is a must for any professional. Long wearing, white tampico fibers can be used on masonry, brick, tile and stone. A truly versatile brush.

No. Size  
BL526 6-1/2"x2"x4"



Palmyra Bristles

Plastic Bristles

White Tampico Bristles

**Long Arm Acid Brush**

20" handle to keep your hands out of acid. 2" fiber gives just the right spring to the bristles. Brush face is 5"x6". Handle is smooth, tumbled block that is easy to grasp.

No. Fiber  
BL521 Palmyra  
BL522 White Tampico  
BL523 Plastic

Plastic Bristles

Tampico Bristles

**Plastic Acid Brush**

Designed especially for use with acid and heavy scrubbing. Handle is 5" long.

No. Size  
BL119 8-1/2"

**Tampico Acid Brush**

Same as plastic acid brush, but with tampico fibers.

No. Size  
BL120 8-1/2"

**Bricklayer's Brush**

Keeps you neat and clean. Made of medium soft hair.

No. Size  
BL428 13" Medium soft hair  
BL427 13" Soft horsehair

**Wire Brush & Scraper**

Made of 1-5/8" round wire especially for removing paint. 4x11 rows.

No. Size  
BL466

## Mason's Line



### Premium Braided Mason's Nylon Line

Braided nylon line on a tube. The 170 lb. test has built in elasticity and eliminates sagging.

No.	Size & Color
BC334T	250' Tube / Fluorescent Orange ●
BC335T	250' Tube / Fluorescent Yellow ●
BC336T	250' Tube / White
BC337T	250' Tube / Green ●
BC338T	250' Tube / Yellow ●
BC333T	250' Tube / Fluorescent Pink ●
BC346	500' Tube / Fluorescent Orange ●
BC339	500' Tube / Fluorescent Yellow ●
BC340	500' Tube / White
BC341	500' Tube / Green ●
BC342	500' Tube / Yellow ●
BC355	500' Tube / Fluorescent Pink ●
BC360	1000' Tube / Fluorescent Orange ●
BC359	1000' Tube / Fluorescent Yellow ●
BC343	1000' Tube / White
BC344	1000' Tube / Green ●
BC345	1000' Tube / Yellow ●
BC361	1000' Tube / Fluorescent Pink ●



#### Braided Mason's Nylon Line

Braided nylon line on a plastic winder with metal line cutter. The 170 lb. test has built in elasticity and eliminates sagging.

No.	Size & Color
BC336	250' Winder / White ●
BC337	250' Winder / Green ●
BC338	250' Winder / Yellow ●

## 500' Braided Nylon line

on a speedy  
FREE SPINNING  
**EZ WINDER**

#### Ideal for:

Concrete, Masonry, General Construction, Surveying, Fence building, or Landscaping

#### 500' Winders

No.	Color
BC342W	Yellow
BC346W	Fluorescent Orange
BC352W	White & Black

Packed 24  
Per Display

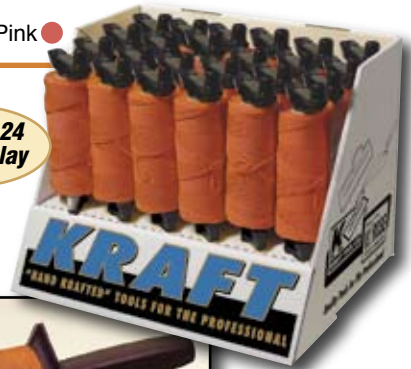

**EZ Winder makes unwinding  
and winding a snap**

#### Display w/24 Winders

No.	Color
BC342D	Yellow ●
BC346D	Fluorescent Orange ●
BC352D	White & Black ○



#### Twisted Mason's Nylon Line

This low-cost, twisted nylon line tests over 120 lbs. Not affected by mortar, oil or mildew.

No.	Size & Color
BC347	350' Tube / White
BC348	350' Tube / Green ●
BC349	350' Tube / Yellow ●
BC356	350' Tube / Fluorescent Yellow ●
BC357	350' Tube / Fluorescent Orange ●
BC358	350' Tube / Fluorescent Pink ●

# Neptune

## NYLON BONDED-BRAIDED MASON'S LINE

***TOUGHEST*** in the business, withstands the punishing rigors of the Construction & Industrial Trades.



- Strong, all purpose, abrasive resistant braided cord
- General utility cord for fishing, outdoors and construction applications
- Hard braided & specially bonded to resist tangling
- Reliable waterproof hand line
- Available in 1/2 lb & 1 lb tubes (green)



● 1/2# Tube			(Approx.)	● 1# Tube			(Approx.)
No.	# Test	Yards		No.	# Test	Yards	
SS101132	132	160		SS102132	132	320	
SS101176	176	110		SS102176	176	220	
SS101240	240	85		SS102240	240	170	
SS101265	265	72		SS102265	265	144	
SS101315	315	60		SS102315	315	120	
SS101350	350	48		SS102350	350	96	



### Bonded Braided Nylon Line

This bright, florescent ultra strong bonded line is longer wearing. The extra elasticity helps eliminate sagging. The nylon has a black flecked braid.

No.	Size & Color
BC353	500' Tube...Orange & Black ●
BC354	500' Tube...Green & Black ●



### Bonded Braided Nylon Line

This ultra strong bonded line is longer wearing. The extra elasticity helps eliminate sagging. The white nylon has a black flecked braid.

No.	Size & Color
BC350	1000' Tube / White & Black ○
BC352	500' Tube / White & Black ○
BC351	250' Winder / White & Black ○



### Nylon Solid Braid Rope

1/4" diam. excellent multi-purpose starter cord, tie down rope. solid braid for extra strength.

No.	Size
GG250-8	250'x1/4" diam.



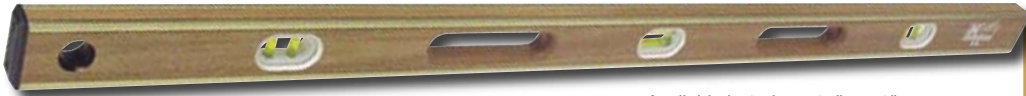

### Brass Bound Mahogany Levels

Made of the best grade mahogany. High quality brass binding and accurate vials make this level the choice of many craftsmen.

No.	Size
BL244	24" w/hand holes
BL248	48" w/hand holes

Available in 2 sizes, 24" or 48"

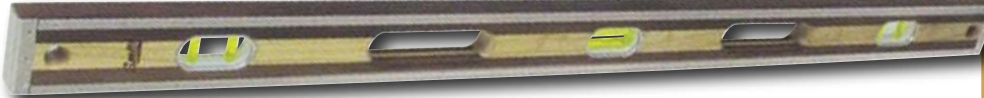

### Smith Levels

These handmade stainless steel bound walnut and maple laminated levels are used by the most discriminating craftsmen. Featuring metallic sealed yellow vials, handset in an unshrinkable compound. The exterior is sealed using raw linseed oil. Will not warp or delaminate.

No.	Size
Smith-48	48" w/hand holes
Smith-42	42" w/hand holes
Smith-36	36" w/hand holes
Smith-30	30" w/hand holes
Smith-24	24" w/hand holes
Smith-18	18" w/hand grooves

Available in 6 sizes

### Smith Recondition Kit

Includes (6) replacement lenses, (6) lense ring holders and linseed oil.

No.	Size
Smith-00	



### Magnetic Torpedo Level

This magnetic level is made of lightweight aluminum. Ideal for those small places and perfect to carry in the pocket.

No.	Size
GG450	9"

### 3" Line Level

Made of hexagon aluminum tubing, furnished with two strong line clips. This level can be used on line or as a surface level.

No. GG513



### QUIK READ Power Tape

- 25'x1" Tape measure
- Easy to read vertical tape
- Numbers both in fractions and decimals
- Handy belt clip.
- Top quality durable plastic case
- Heavy-duty spring

No.	Size
GG295*	25'x1"

### 25' Carpenter's Tape Measure



- 25'x1" Tape measure
- Rubber grip
- Active bumper
- Heavy-duty spring

No.	Size
GG284*	25'x1"



### 200' Tape Measure

- 200'x1/2" Tape measure
- Numbers in feet, 10th's and 100's
- Nylon coated steel tape
- Handy easy reel handle
- Top quality durable plastic case

No.	Size
GG297*	200'x1/2"

### Walking Tape

Measure horizontal and vertical surfaces quick and easy. Heavy-duty wheel. Convenient support keeps tool upright when not in use. Telescoping handle adjusts easily to correct working height. Measure up to 10,000' (2 miles) w/o resetting.

No.	Size
GG283*	Feet/Inches
GG283M*	Metric <b>NEW</b>

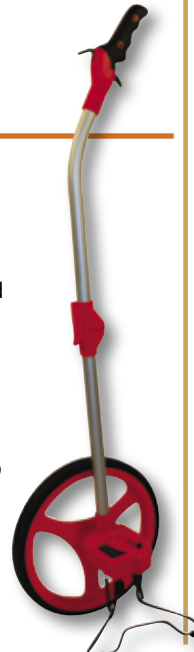

### Lufkin Power Tapes

Easy to read black markings on yellow steel tape. Top quality durable plastic case with handy belt clip. Choose the one you need.

No.	Size
GG291*	16'x3/4"
GG292*	25'x1"
GG294*	25'x1" (Tenths)

### Chalk Box & Chalk



#### Chalk box

Use either as a chalk line or plumb line. Comes with 100' line. Packaged (6) per. No. GG301

#### Chalk

High quality chalk for use in any chalk box.

No.	Color	Weight
GG304	Blue	8 oz.
GG305	Glo-orange	8 oz.
GG306	Red	8 oz.
GG307	Yellow	8 oz.
GG308	Blue	4 oz.
GG314	Blue	5 lbs.
GG315	Glo-orange	5 lbs.
GG316	Red	5 lbs.
GG317	Yellow	5 lbs.

# Brick Rules & Tapes



### Modular Rule

Lists modular spacings on one side; feet, inches, eighths and sixteenths on the other side. Choice of thick hardwood or fiberglass. Ruler features six scales. First section is short for butting rule on first 16" module. Legs have square ends.

- |         |               |
|---------|---------------|
| No.     | Size          |
| BL512   | 6' Wood       |
| BL646F* | 6' Fiberglass |



### Spacing Rule

Lists ten course spacing on one side; has inches, eighths and sixteenths on other side. Choice of thick hardwood or fiberglass. Joints lubricated for smooth opening and closing.

- |         |               |
|---------|---------------|
| No.     | Size          |
| BL167   | 6' Wood       |
| BL636F* | 6' Fiberglass |



### Mason's Tapes

16" Spacing Tape has space markings; and feet, inches on one edge of blade. Modular tape has modular markings for all common bricks; and feet, inches on one edge of blade.

- |       |                    |
|-------|--------------------|
| No.   | Size               |
| BL518 | 16" x 3/4" Spacing |
| BL519 | 16" x 3/4" Modular |



### Brick Mason's Rule for King Size Brick

This mason's spacing rule is for oversized brick. These brick have 2-3/4" hgt and spacings at 2-7/8" and go to 3-1/2" in 1/16" increments. This brick spacing rule will be identified with black letter "A" through "K".

- |         |               |
|---------|---------------|
| No.     | Size          |
| BL169   | 6' Wood       |
| BL656F* | 6' Fiberglass |



### Ammo Chalk Line Box

Heavy-duty 150' chalk line. Holds 1-1/2 lbs of chalk. Moisture resistant easy refill lid. Great for paving contractors, highway depts and landscape contractors.

- |       |                     |
|-------|---------------------|
| No.   | Size                |
| GG302 | Ammo chalk line box |



### Extension Folding Rule

Graduated brass slide on first section extends 6". Brass plated, riveted lock joints eliminate end play. Also has brass end caps and end strike plates. Markings are embedded in wood on both sides, and on both edges to 16ths with red stud markings on 16" centers.

- |       |      |
|-------|------|
| No.   | Size |
| GG318 | 6'   |



### Engineer Folding Rule

#1066D & #1066DM Lufkin

Red end folding rule is the finest engineer rule made. Graduations: inside markings in feet, 10ths and 100ths of feet. Foot numbers in red, repeated each inch and 10th of a foot.

- |           |                                      |
|-----------|--------------------------------------|
| No.       | Size                                 |
| GG320     | 6' (Feet, 10ths & 100ths)1066D       |
| GG322     | 6' (10ths & Metric)1066DM            |
| GG1066DF* | 6' (Feet, 10ths & 100ths) Fiberglass |



### 4 Tapes in 1 RULE OF THUMB™

### Professional Mason's Layout and Coursing Rule

25' Mason's Rule covers all brick sizes: Modular, Queen sized, King sized, Pavers and Brick-Block up to 4" high. Great layout tool. 16" Mark on tape serves as a counter to easily determine the number of blocks or studs to locate wall tie points.

- |        |                                  |
|--------|----------------------------------|
| No.    | Size                             |
| BL516* | 25' Tape (Package 6 per display) |

\*See page 130

# Masonry Hammers

## Kraft Brick Hammer

This heavy-duty brick hammer is available in three sizes. Forged from high quality tool steel. Comes with a smooth comfortable wood handle.

No.	Weight	Handle Length
BL155	24 oz.	11-1/4"
BL153	28 oz.	11-1/4"
BL152	32 oz.	11-1/4"

## Bricklayer's Brick Hammer

This heavy-duty brick hammer is available in two sizes. Forged from high quality tool steel. Comes with a smooth comfortable wood handle.

No.	Weight	Handle Length
BL255	18 oz.	11-1/4"
BL256	24 oz.	11-1/4"

**CAUTION:**  
Always wear safety goggles when using masonry hammers.

## Rocket Brick Hammer

Forged, polished head that is securely fastened to handle. The hammer the professional prefers. Has neoprene fiber grip.

No.	Weight
BL505	16 oz.
BL506	24 oz.

## Toothed Bush Hammer

Has milled teeth on 1-3/4" square face. Head is 6" long. Comes with a strong wood handle.

No.	Weight
BL344	3 lbs.
BL444	4 lbs.

## Deluxe Toothed Bush Hammer

8-1/2" long head with 1" square face. Teeth are precision cut to a sharp point for superior cutting action and wear. Comes with smooth wood handle.

No.	Weight
BL151	2 lbs.

## Wide Bit Brick Hammer

This hammer by Plumb® is designed for use on new oversize bricks. It ensures a clean break every time. Has Permabond® red handle to head construction.

No.	Weight
BL335*	16 oz.

## Mash Hammer

Forged steel head. Comes with 10-1/4" wood or fiberglass handle. Used by the pro bricklayer.

No.	Weight
BL453*	3 lbs. (Wood Handle)
BL453F*	3 lbs. (Fiberglass Handle) <b>NEW</b>

## Sledge Hammer w/ Fiberglass Handle

4 lb. sledge style head with 14" strong fiberglass handle. Ideal for working with forms, stakes and other general construction jobs.

No.	Weight
BL454F*	4 lbs. <b>NEW</b>

## One-Piece Estwing Mash Hammer

Made of steel with nylon-vinyl cushion grip. Polished face and bevel, painted finish.

No.	Weight
BL352	2 lbs.
BL353	3 lbs.
BL354	4 lbs.

## Scaling Brick Hammer

Scaling hammer is used for cleaning in preparation for refinishing old brick. Can also be used for chipping mortar in a variety of ways.

No.	Weight
GG334	16 oz.

## Cushion Grip Estwing Mason Hammer

Built to really take punishment. Rugged steel handle won't break, fly off, dent or get chewed up. Exceptionally well balanced.

No.	Weight
BL312	12 oz.
BL320	20 oz.
BL324	24 oz.

## Stone Mason's Hammer

A very powerful hammer made of forged and tempered steel. Comes with 16" wood handle.

No.	Weight
BL333	3 lbs.
BL334	4 lbs.
BL337	6 lbs.
BL332	16" Replacement handle

## Stone Mason's Hammer

A heavy-duty hammer made of forged and tempered steel. Comes with heavy-duty 36" long handle.

No.	Weight
BL336	16 lbs.
BL338	20 lbs.



**Concrete Chisels**

Forged from the finest tool steel, well tempered, properly balanced for a comfortable hold.

No.	Size
CC654	10"x1-7/8"
CC671	10"x2-1/2"
CC655	10"x2-7/8"



**English Pattern Plugging Chisel**

Plugging chisel has 10" grooved blade forged in England from the best steel available. Blade is 4-1/2" long; tapers from 1" down to 5". Overall length 10".

No.	BL377
-----	-------



**Plugging Chisel**

Forged from the finest tool steel, well tempered, properly balanced for a comfortable hold. Blade length 4-1/2". Overall length 10"

No.	Size
BL576	10"x4-1/2"x1-3/16"



**Cold Chisels**

Forged from the finest tool steel, well tempered, properly balanced for a comfortable hold.

No.	Size
GG362	7-3/8"x3/4"
GG363	12"x3/4"
GG364	8-1/8"x1"
GG365	12"x1"



**Stone Splitting Wedge**

Drill hole in stone and insert shims and wedge. Hammer the wedge to force stone apart. Measures 4-3/4"x1/2"

No.	BL389
-----	-------



**Carbide Tipped Hand Tracer**

Hand tracer makes straight lines on stone. Continued tracing will cause stone to split along this line. 1-1/4" bit width, 2" diameter and 8-3/4" overall length.

No.	Weight
BL388	3 lbs.



**Carbide Tipped Brick/Stone Hammer**

Special designed head with wood handle gives extra striking force with 7/8" wide durable carbide tip.

No.	Weight
BL150	2 lbs.

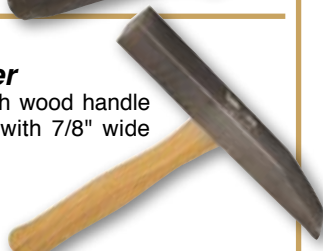

**Carbide Tipped Chipping Hammer**

Forged and tempered. Vertical cutting edge has carbide tip for perfect angle to remove stone.

No.	Weight
BL149	2 lbs.



**Rubber Grip English Chisel**

Rubber grip English chisel is easier to hold while using. Forged and heat treated for longer life. Overall length of 8-3/4", 5" handle, 4" wide cutting blade.

No.	BL426
-----	-------



**Bricklayer's Set**

Forged from the finest tool steel, well tempered, properly balanced for a comfortable hold.

No.	Size
BL232	8"x2-1/2"
BL233	8"x3"
BL234	8"x4"
BL235	8"x5"



**CAUTION:**  
Always wear safety goggles when using masonry chisels

**Plain Stone Mason's Chisels**

Forged from the finest tool steel, well tempered, properly balanced for a comfortable hold.

No.	Size	Available in 4 sizes
BL022	8"x5/8"x1-1/4"	
BL423	8"x3/4"x1-3/4"	
BL424	8"x3/4"x2-1/4"	
BL425	8"x7/8"x2-3/4"	



**Tooth Stone Mason's Chisels**

Forged from the finest tool steel, well tempered, properly balanced for a comfortable hold.

No.	Size	Available in 4 sizes
BL412	8"x5/8"x1-1/4"	
BL413	8"x3/4"x1-3/4"	
BL414	8"x3/4"x2-1/4"	
BL415	8"x7/8"x2-3/4"	



**Hand Stone Chipper**

Use to chip a straight edge on a smooth building stone.

No.	Diameter	Bit
BL385	7/8"	2"
BL386	1"	2-1/2"
BL387	1-1/8"	3"



**Hand Stone Tracer**

Marks a straight line on stone. Continued tracing will cause stone to split along this line. Great for shaping and cutting.

No.	Diameter	Bit
BL382	7/8"	2"
BL383	1"	2-1/2"
BL384	1-1/8"	3"



**Hand Stone Pitching Tools**

Used to pound stone on edge to put a facing on it. Made of finest quality forged tool steel.

No.	Diameter	Bit
BL378	7/8"	2"
BL379	1"	2-1/2"
BL381	1-1/8"	3"



**CAUTION:**  
Always wear safety goggles when using masonry chisels

# Mortar Boxes

## ProForm® Mortar Boxes



**STEEL MORTAR BOX**

**HEAVY-DUTY**  
**10 CU. FT.**  
**CAPACITY**

- #10 Gauge heavy-duty steel
- 6" forklift clearance
- Heavy-duty reinforced top lip
- Joints lapped with continuous welds for extra strength

Weight: 166 lbs

Dimensions:  
22" width, 57" Length, 24" Height

Inside Bottom Dimensions:  
22" width, 39" Length

No.	Size
BC210	10 Cu. Ft. Steel Mortar box



Outside Dimensions:  
22" width, 45" Length, 18" Deep

Inside Bottom Dimensions:  
22" width x 34" length

**HEAVY-DUTY**  
**10 CU. FT.**  
**CAPACITY**

## Mud Dobber MORTAR BOX

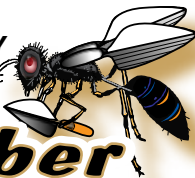

with heavy-duty casters

- Heavy-duty 10 gauge steel ● Weight: 260 lbs
- Easy turn heavy-duty 8" casters; two swivel with **NEW** locking feature and two straight
- Reinforced 1" steel handle
- Joints lapped with continuous welds for extra strength

No.	Size
BC211	10 Cu. Ft. Steel Mortar Box with <b>NEW</b> locking casters
BC211-01	10 Cu. Ft. Steel Mortar Box without casters <b>NEW</b>

## POLY MORTAR BOX



**HEAVY-DUTY**  
**9 CU. FT.**  
**CAPACITY**

Outside Dimensions:  
32" width, 60" Length, 12" Height

Inside Bottom Dimensions:  
23" x 34"

- Heavy-duty poly mortar box
- Heavy-duty reinforced top lip
- Easy to clean
- Weight: 26 lbs

No.	Size
BC218	9 Cu. Ft. Poly Mortar Box

## Steel Mortar Boxes



Steel mortar boxes made of heavy-duty 16 gauge steel. Smooth interior makes mixing easier. Leak proof. (Must ship by truck).

No.	Size	Wt.
BC206	50"x29"x12" (6 Cu. Ft.)	47 lbs.
BC209	60"x32"x12" (9 Cu. Ft.)	65 lbs.
BC215	78"x38"x12" (15 Cu. Ft.)	86 lbs.

## Polyethylene Mortar Boxes



Available in two popular sizes; 7-1/2 Cu. Ft. and 9 Cu. Ft. Lightweight, but tough. Not affected by heat or cold; easy to clean. Will not rust. (Must ship by truck).

No.	Size	Wt.
BL375	56"x33"x8" (7.5 Cu. Ft.)	20 lbs.
BL376	60"x36"x12" (9 Cu. Ft.)	25 lbs.

**Polyethylene Mortar Pan**

One-piece construction. Outwears metal. Not affected by plaster, mortar or water. Weighs less than 5 lbs. Easy to use, easy to clean. 30"x30" at the top, tapered to 16"x16" at bottom; 7" deep.

No. Size  
BC492 30"x30"



**All Steel Mortar Pan**

Rounded edges for easy handling. Curved corners and sloped sides makes this pan ideal for mixing materials. Smooth interior makes mixing easier. Leak proof. Easy to use, and to clean.

No. Size  
BC212 30"x30"x8"



**Mortar Boards & Pans**

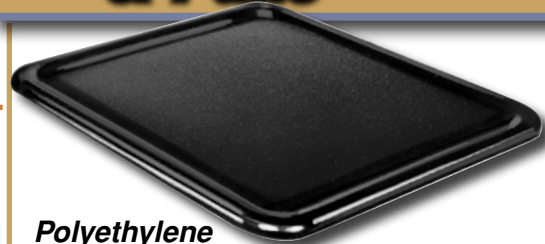

**Polyethylene Mortar Board**

Won't splinter. Won't absorb water. Dry mortar won't stick. Lightweight, easy to use, easy to clean.

No. Size  
BC480 30"x30"

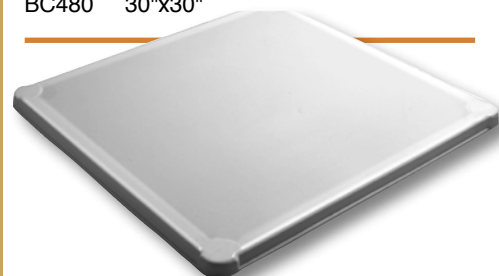

**Fiberglass® Mortar Board**

Won't splinter. Won't absorb water. Dry mortar won't stick. Lightweight, easy to use, easy to clean.

No. Size  
BC482 30"x30"x1-1/4"



**All Purpose Tub**

Great for mixing a variety of materials

No. Size  
BC217 26"x20"x6"



Mortar board not included

**Mortar Stand**

Folding stand is made of tubular steel and can be used on scaffold or ground. Lightweight and easy to handle. Stand is 30" tall and has (2) chains. Weight: 12 lbs.

No.  
BC291

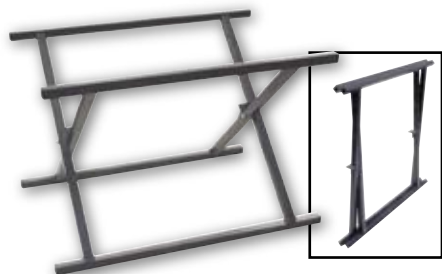

**Fold Up Mortar Stand**

New style square tube masonry stand. Tubes lock together for extra strength. No chains, easily fits on scaffold. Folds up and easily stacks and transports. Weight: 15 lbs.

No. Size  
BC293 21"x31"



**Easy Mixer Concrete Hoe**

US PATENT  
6,412,569

Great tool for mixing concrete fast in wheelbarrows, backhoe buckets and other mixing containers. Patented forged head easily mixes 60 to 90 lb. bags of concrete in minutes. Special design creates minimum splash with 50% less drag. Great in corners. Open bag with point of hoe. 7-1/2"x6" blade.

No.  
CC211 Easy Mixer Hoe w/ 60" hdl  
CC212 Easy Mixer Hoe w/ 21" hdl

**Heavy-Duty Mortar Hoe**

Mortar hoe has two holes for better mortar mixing. Comes with heavy-duty shovel type wood handle. Preferred by the pros.

No. Size  
BC228 6"x10" Blade w/66" hdl  
BC230 7"x5" Blade w/60" hdl

**Short Handle Mortar Hoe**

Mortar hoe has two holes for better mortar mixing. Short 21" heavy-duty shovel type wood handle, ideal for working in tight areas. A must tool for every mason.

No. Size  
BC229 6-1/2"x4-3/4"  
Blade



# Masonry Guides

The finest most versatile corner pole system available can be effectively used on all types of masonry brick veneer or solid load bearing wall and block work. The 9' pole and fittings are constructed entirely of high grade aluminum. The top and bottom fittings are completely adjustable and can be used at any height for quicker and more accurate set up.

One man can quickly and easily erect and align. Sturdy, rugged, practically indestructible, these corner poles will pay for themselves time and time again.

No. Description

### BC607 Outside Corner System

Complete with 9' guide pole (no pole markings) and fittings shown below:



BC617  
Outside corner base



BC614  
Top sliding attachment



BC615  
Outside corner top fitting

### BC608 Inside Corner System

Complete with 9' guide pole (no pole markings) and fittings shown below:



BC618  
Inside/intermediate base



BC614  
Top sliding attachment

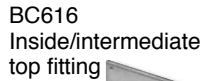

BC616  
Inside/intermediate top fitting



BC619  
Inside/intermediate line holder

### BC609 Guide Pole ONLY

9' pole (with no markings), weight 16 lbs.

CAN SHIP UPS

### BC610 Telescoping Pole Braces

Optional accessory used to form tripod support with guide pole for free-standing or multi-story applications. Adjusts from 7'6" to 13'8".



Pole shown w/  
outside fittings

Fittings may be ordered separately



## "BIG RED"

New improved non-slip lock down to unload quickly and easily. Can't damage bricks and is designed and built for long wear. Large wing nut makes for fast adjustment from 7 to 11 bricks. Made of malleable iron with smooth wood handle. A favorite with brick masons across the country.

No. BC281



This professional brick handler is built for long service. It is made of square tubing. Won't damage bricks. Handles 6 to 11 bricks.

No. BC384



A heavy-duty quick adjustable tong can carry from 6 to 10 bricks. Can't damage bricks and is designed and built for long wear.

No. BC380  
Size 16" Long

### Aluminum Mortar Hod

Aluminum mortar hod is lightweight. It makes carrying a load easier. Heliarc welded construction. Complete with 24" wood handle.

- |          |                                |
|----------|--------------------------------|
| No.      | Size                           |
| BC991    | 24"x16"x14" Head w/ 24" handle |
| BC991-01 | Head (only)                    |
| BC991-02 | 24" Handle                     |
| BC991-03 | 48" Handle                     |





**CAUTION:**  
Always wear safety goggles when using a Brick Splitter



### Hand Brick Splitter

Split brick fast. Compact, easy to adjust.. Easy to carry and ideal for scaffold use. Long wearing heat treated replaceable blade. Easy to use. Simply strike brick with hammer above the blade to split brick. Faster than a brick saw.

No. BC413



### Estwing 16"

### All Steel Framing Hammer

Drive nails straight and fast with this powerful hammer. Milled face, nylon vinyl grip.

No. Size  
GG417 22 oz. Steel hammer

### Brick Splitter

This Mini Brick Splitter carries easily as it weighs only 39 lbs. The opening is a full 5" high so it can take a regular brick standing up at an angle. The lever action increases your arm strength, so the cuts are made with a minimum effort. The blades are 4-1/2" wide, so it cuts most bricks now in use, and the cut will be accurate, as a 12" rule and square is built right into the Mini Splitter.

No.	Description
BC582	Mini Brick Splitter
BC582-01	Set of replacement blades

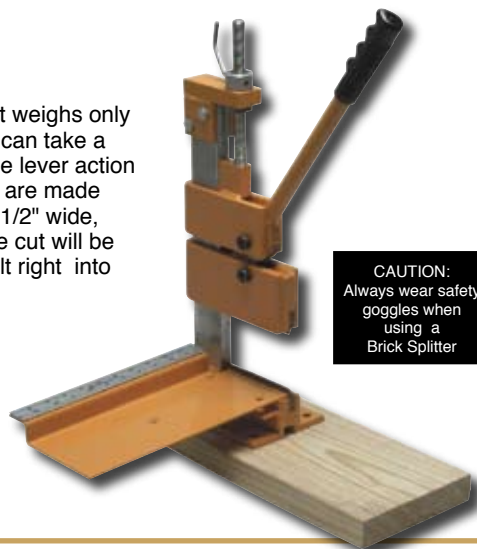

**CAUTION:**  
Always wear safety goggles when using a Brick Splitter

### Brick & Block Cart



Heavy-duty all terrain cart allows user to move straps of brick. Comes with 7-1/2" prongs and heavy-duty 3 piece hub with 2 ply tube type tires. Rubber sealed heavy-duty ball bearings. All steel wheels with grease fittings. Constructed for a lifetime of service. 800 lb. capacity. Must ship by truck (only).

Weight: 112 lbs.  
No. Size  
BC205 **Cart:** 29" wide, 54" high  
BC205-01 7-1/2" (Brick)  
BC205-02 **Short prongs** (pr)  
15" (Block)  
**Long prongs** (pr)

### Paver & Masonry Splitter



**CAUTION:**  
Always wear safety goggles when using a Brick Splitter

**Cut Masonry Fast and Clean!**

- Adjustable hand crank
  - 12 Ton hydraulic jack for splitting
  - Throat 7-1/2" high x 11-1/4" wide
  - Replaceable cutting blades
  - Weight 95 lbs.
- No. BC580

Quality  
Masonry Levels

See page 60

# Masonry Line Blocks



## Concrete Block Line Stretchers

Stretches line tight between blocks. Can also be used as a winder to store line when not in use. Sold only in pairs.

No.	Size
BL339	2" to 4"
BL343	4" to 6"
BL342	6" to 8"
BL340	8" to 10"
BL341	8" to 12"



## Adjustable Line Stretchers

These aluminum line stretchers work on various size blocks from 4" to 12". Change size by moving bolt and wing nut to correct hole. Sold only in pairs.

No.	Size
(A) BL147*	
(B) BL148	<b>NEW</b>



## 2 Popular Styles

## Aluminum Bricklayer's Corner Blocks

These aluminum corner blocks grip the wall tightly and will not break. Line wraps around stem, feeds through slot at the fork, then brick and groove on face of block. The line pull holds block at right angles to the brick. 2-3/4" stem lets you easily move the line up. Sold only in pairs.

No.	Size
BL253	

## Tenite Line Blocks

Blocks grip the wall tightly and will not split or break. Made of hard tenite (plastic). Sold only in pairs.

No.	Size
BL349	4-1/4" Bulk (pairs)
BL348	4-1/4" Carded (pairs)
<b>Wood Line Blocks</b>	
BL350	4" Bulk (pairs)



## Bricklayer's Line Pins



Made of tempered steel; stiff and long enough to hold the line. Packaged (4) per.

No.	Size
BL158	6"

## Snap-Over Line Twigs / Trigs



Manufactured from spring steel. They snap around the mason's line and eliminate sagging. Package of (14).

No.	Size
BL156	4" Long x 5/8" Wide

## Over Sized Line Blocks



Especially made for use on bull nosed block. Can also be used on other types of block and brick.

No.	Size
BL242	4-1/2"x1-3/4"

## Mason's Line Twigs/ Trigs & Blocks

- Two line maximum imprint
- Imprint area 3/8" high and 2" wide
- Choice of Black or Red Imprint Color
- See page 126



*Imprint Your Name Here!*



**Ask for Special Imprint Order Form on prices and quantities.**

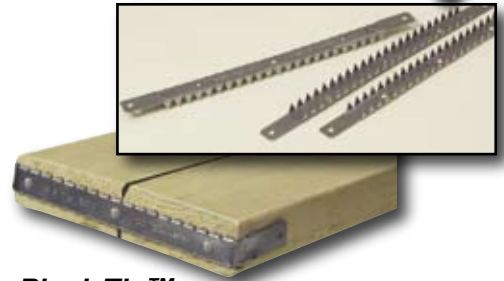

## Plank Tie™

Protect new and used planks. Nail Plank-Tie™ to each end of wood planks for longer plank life.

No.	Description
BL170	10" Plank-Tie™ (Box of 100)
BL171	12" Plank-Tie™ (Box of 100)

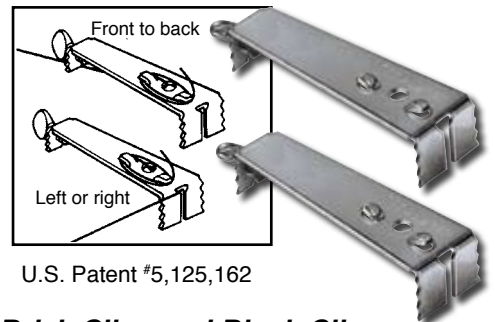

U.S. Patent #5,125,162

## Brick Clips and Block Clips

This new patented design on brick and block alignment clips are the quickest for setup and most portable line guides ever developed. The front of the clip has an irregular toothed surface and a thumb screw in the rear helps secure the clip.

No.	Description
BL250	4" Brick clips (Pair)
BL251	2" Block clips (Pair)

# Plaster Floats

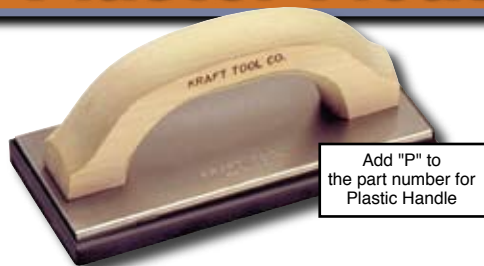

Add "P" to the part number for Plastic Handle

### Molded Rubber Floats

- Molded black sponge rubber
- Very dense texture
- Comes with comfortable wood handle

No.	Size
PL395	8"x4"x5/8"
PL398	10"x4"x5/8"

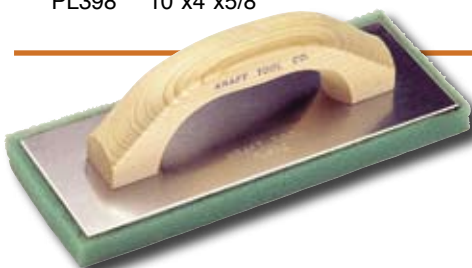

### Green Texture Floats

- Special green formula foam plastic
- Does an excellent job on any sand surface
- Comes with comfortable wood handle

No.	Size
PL602	10"x4"x3/4"
PL603	12"x5"x1"
PL601	12"x4"x3/4"

### Green replacement pads

PL702	10"x4"x3/4"
PL701	12"x5"x1"
PL703	12"x4"x3/4"
PL376	10"x16"x3/4" sheet



### "Sandsucker" Float

- Perfect for exterior sand finishing
- Pulls the sand right out of the mud
- Pad is made of thick textured red sponge rubber mounted on a metal reinforced flexible rubber back
- Comes with comfortable wood handle

No.	Size
PL350	10"x4"x3/4"

### Plasterer's Rubber Sponge

- Pure sponge rubber
- Oval shaped to fit hand
- One of the finest sponges made

No.	Size
PL069	7"x4"x1-7/8"



### Coarse Cell Rubber Floats

- Securely cemented to flat aluminum back
- Comes with comfortable wood handle

No.	Size
PL374	8"x4"x5/8"
PL382	10"x4"x3/4"



### Fine Cell Rubber Floats

- Pad securely cemented to flat aluminum back
- Comes with comfortable wood handle

No.	Size
PL371	8"x4"x5/8"
PL372	10"x4"x3/4"

### Replacement Float Handles

Your choice...wood or plastic handle.

CF263	7-1/4" Wood float handle
CF263P	7-1/4" Plastic float handle

### Float Pads

Replacement pads available for all "Floats"

### Contact Cement

PL379 Replacement pad adhesive (1 pint)



### Super Poly-Foam Floats

- White poly-foam that looks and wears like rubber

- Does not disintegrate like most foams
- Comes with comfortable wood handle

No.	Size
PL606	10"x4"x3/4"
PL605	12"x4"x3/4"
PL604	12"x5"x1"

### Poly-foam replacement pads

PL706	10"x4"x3/4"
PL705	12"x4"x3/4"
PL704	12"x5"x1"



### Red Rubber Floats

- Sponge rubber securely cemented to flat aluminum back
- Comes with comfortable wood float handle

No.	Size
PL373 Fine	8"x5"x1"
PL383 Coarse	8"x5"x1"



### Jumbo Red Rubber Float

- Popular on the West Coast and Arizona
- Sponge density is the most popular used

No.	Size
PL310	12"x5"x3/4"



### Lightweight Rubber float

- Sponge rubber of correct density, lightweight red float that covers more surfaces
- Comes with comfortable wood handle

No.	Size
PL384	12"x4"x1/2"

Weight 24 floats, 24 lbs.



### Exterior Finishing Trowel

- Used for applying exterior coatings
- Lightweight and durable plastic blade
- Comfortable molded plastic handle

No.	Size
PL801*	11"x5-1/2"

- Applies stucco and other materials fast
- Available in lightweight aluminum or magnesium

No.	Size
PL267	22"x8" Mag Go Devil
PL268	22"x10" Mag Go Devil
PL529	22"x8" Alum Go Devil
PL530	22"x10" Alum Go Devil

### Go Devils



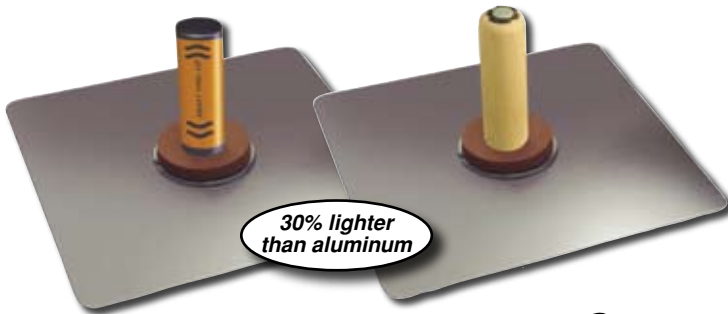

30% lighter than aluminum



# Plaster Hawks



## Magnesium Hawks



Corners are rounded for safety, comfort and long service. Has 4" flange reinforcing the center. Comes with a special 1/2" thick sponge rubber hand protector. Blade machined scored to control material.

### ProForm® handle

No.	Size
PL266PF	16"x16"
PL264PF	14"x14"
PL265PF	13-1/2"x13-1/2"
PL263PF	13"x13"
PL262PF	12"x12"
PL261PF	10"x10"
PL260PF	8"x8"

### Wood handle

No.	Size
PL266	16"x16"
PL264	14"x14"
PL265	13-1/2"x13-1/2"
PL263	13"x13"
PL262	12"x12"
PL261	10"x10"
PL260	8"x8"

PL250PF Replacement Handle  
 PL249 Extra 1/2" callous preventer (sponge rubber) will fit any hawk

## Aluminum Hawks

Heavy-duty aluminum hawk. Smooth straight edges with rounded corners. Detachable handle with threaded bolt and sponge rubber callous preventer. Blade machined scored to control material.

### ProForm® handle

No.	Size
PL528PF	14"x14"
PL513PF	13"x13"
PL524PF	13-1/2"x13-1/2"
PL512PF	12"x12"
PL510PF	10"x10"

### Wood handle

No.	Size
PL528	14"x14"
PL513	13"x13"
PL524	13-1/2"x13-1/2"
PL512	12"x12"
PL510	10"x10"

PL250PF Replacement Handle  
 PL249 Extra 1/2" callous preventer (sponge rubber) will fit any hawk

PL250 Extra hawk handle  
 PL249 Extra 1/2" callous preventer (sponge rubber) will fit any hawk

## Scratcher Trowel



Great for scratching plaster or stucco. Fitted with a smooth camel back wood handle.

1/2"x1/2" "V" notch.

### 2 Sizes

No.	Size
PL630	16"x5"
PL631	12"x5"

## Mitre Rod

Knife edge is ideal for cutting cornices on plaster walls. Durable steel construction. All rods are 4" wide.

No.	Size
PL106	6"
PL108	8"
PL110	10"
PL112	12"
PL116	14"
PL120	20"
PL124	24"

## Professional Quality

# Plaster Trowels

Trowels are made of heat treated golden stainless steel. This special alloy will not rust, pit, or stain. A great tool that's long wearing with just the right balance.

### Golden Stainless Steel



### Camel Back wood handle

No.	Size
PL452	10-1/2"x4-1/2"
PL454	11"x4-1/2"
PL455	11"x4-3/4"
PL453	11-1/2"x4-1/2"
PL457	11-1/2"x4-3/4"
PL459	12"x5"
PL460	13"x5"



### ProForm® handle

No.	Size
PL452PF	10-1/2"x4-1/2"
PL454PF	11"x4-1/2"
PL455PF	11"x4-3/4"
PL453PF	11-1/2"x4-1/2"
PL457PF	11-1/2"x4-3/4"
PL459PF	12"x5"
PL460PF	13"x5"



### Camel Back wood handle

No.	Size
PL525	10-1/2"x4-1/2"
PL551	11"x4-1/2"
PL556	11-1/2"x4-1/2"
PL547	11"x4-3/4"
PL548	11-1/2"x4-3/4"
PL568	12"x5"
PL570	13"x5"



### ProForm® handle

No.	Size
PL525PF	10-1/2"x4-1/2"
PL551PF	11"x4-1/2"
PL556PF	11-1/2"x4-1/2"
PL547PF	11"x4-3/4"
PL548PF	11-1/2"x4-3/4"
PL568PF	12"x5"
PL570PF	13"x5"

### Swedish Stainless Steel



## Flat Wire Texture Broom

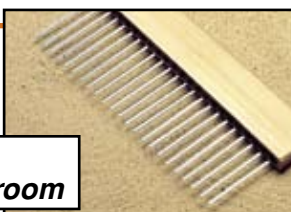

Produces a uniform groove surface. Blockhead is 11-1/8" long. Flatwire tines measure 3-5/8" in length on 1/2" spacing. Perfect for those small jobs.

No.	Size
CC201	12"

See pages 8-9 for additional stainless steel trowels



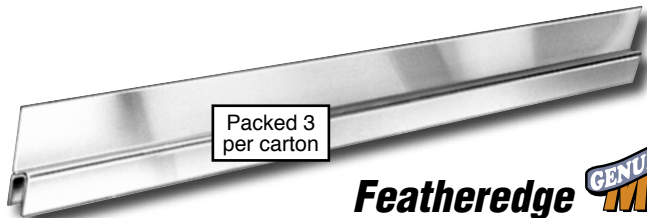

Packed 3 per carton

**Featheredge** GENUINE EXTRU-LITE™ **MAGNESIUM**

Makes it easy to scrape off mud while following a plastering machine. Perfectly balanced for fingertip control. Width is 4-1/2".

No.	Size
PC004	4'
PC005	5'
PC006	6'
PC007	7'
PC008	8'
PC010	10'
PC012	12'



**Wedge-Shape Darby**

Wedge shape magnesium darby is made of tempered magnesium alloy. It is the choice of the trade. Gives fine smooth finish to plaster.

No.	Size
PC036	36"
PC042	42"
PC048	48"

**Magnesium Slicker**

Ideal for straightening and slicking ceilings. No water needed. Designed with an angle at the top for strength, rigidity and ease of operation. Weighs only 22 oz.

No.	Size
PL695	42"

**Ornamental Tools**



The plasterer's delight! Forged and tempered.

No.		Size	Length
PL188*	Trowel & Square	3/8"	8-3/4"
PL189*	Trowel & Square	1/2"	9-1/2"
PL190*	Trowel & Square	5/8"	10-1/2"
PL191*	Trowel & Square	3/4"	10-1/2"
PL192*	Trowel & Square	1"	10-1/2"
PL193*	Leaf & Square	3/8"	8-1/2"
PL194*	Leaf & Square	1/2"	8-1/2"
PL195*	Leaf & Square	5/8"	9-1/4"
PL196*	Leaf & Square	3/4"	9-1/2"
PL197*	Leaf & Leaf	1/2"	8-1/2"

**Scratcher Darby**  
"V" Notch



Lightweight magnesium darby with double knob handle. Raised edge for strength. 1/2"x1/2" "V" notch.

No.	Size
PL694	42" magnesium scratcher darby

Packed 3 per carton

**Cut & Shape Tool**

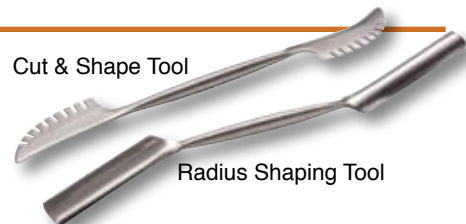

Radius Shaping Tool

Forged and tempered ornamental tools for long life. 9" length.

No. PL186\* Cut & Shape tool  
No. PL187\* Radius shaping tool

**42" Mag Darby**



Reinforced for strength and straightness.

Lightweight magnesium darby. Long wearing sharp serrations. Special end wedges provide strong support.

Blade Ends...Re-inforced for extra strength and straightness

No.	Size
PL413	42" Smooth edge mag darby
PL413S	42" Single serrated mag darby
PL413D	42" Double serrated mag darby

**Darby with 24" Rib Handle**

Lightweight magnesium darby is very strong. Fitted with 24" long wood handle. Has raised ridges on each side for extra strength. It is very popular and preferred by most plasterers.

No.	Size	
SMOOTH EDGE		
PL400-24	42"x3-1/2"	Packed 3 per carton
PL401-24	48"x3-1/2"	
DOUBLE SERRATED EDGE ▲▲▲▲▲▲		
PL402-24	42"x3-1/2"	▲▲▲▲▲▲
PL403-24	48"x3-1/2"	
SINGLE SERRATED EDGE ▲▲▲▲▲▲		
PL404-24	42"x3-1/2"	▲▲▲▲▲▲
PL405-24	48"x3-1/2"	

**Darby**

Lightweight magnesium darby is very strong. Has raised ridges on each side for extra strength. It is very popular and preferred by most plasterers.

No. Size

SMOOTH EDGE		Packed 3 per carton
PL400	42"x3-1/2"	
PL401	48"x3-1/2"	
DOUBLE SERRATED EDGE ▲▲▲▲▲▲		▲▲▲▲▲▲
PL402	42"x3-1/2"	
PL403	48"x3-1/2"	
SINGLE SERRATED EDGE ▲▲▲▲▲▲		▲▲▲▲▲▲
PL404	42"x3-1/2"	
PL405	48"x3-1/2"	

**Darby W/Double Knob Handle**

Lightweight magnesium darby is very strong. Has raised ridges on each side for extra strength.

No. Size

SMOOTH EDGE		Packed 3 per carton
PL410	42"x3-1/2"	
DOUBLE SERRATED EDGE ▲▲▲▲▲▲		▲▲▲▲▲▲
PL412	42"x3-1/2"	
SINGLE SERRATED EDGE ▲▲▲▲▲▲		▲▲▲▲▲▲
PL414	42"x3-1/2"	



\*See page 130

**NEW**

**Venetian Trowel**

Trapezoid shape stainless steel finish trowels. Designed for finishing and polishing decorative plaster and stucco. Machined edge with smooth bright finish.

**Wood handle**

No.	Size	
PL627	8"x3"	200x80 mm (small) <b>NEW</b>
PL628	9-1/2"x3-1/2"	240x100 mm (med) <b>NEW</b>

**ProForm® handle**

No.	Size	
PL627PF	8"x3"	200x80 mm (small) <b>NEW</b>
PL628PF	9-1/2"x3-1/2"	240x100 mm (med) <b>NEW</b>



Stainless Bound Nylon

**Stainless Bound Nylon Brush**

This 8-1/2" wide brush will pick up and apply any material easily and smoothly. Nylon filaments are flagged and tipped. They are set in epoxy for better holding capacity. Plasterers and painters love this brush.

No.	Size
PL105	8-1/2"x1-1/4"x4-1/8"



Stucco Dash

**Stucco Dash Brush**

Stucco dash brush has 8 rows x 4 rows on 5"x2-1/4" block.

No.	Size
PL114	Bassine 4" brown bristles
PL115	Plastic 5-1/2" yellow bristles



Regular Dutch

**Regular Dutch Brush**

Used by plasterers, painters, stucco workers and cement finishers. Made of Tynex nylon set in rubber.

No.	Size
PL101	7"x1-5/8" (4-1/8" Bristle length)

**Blister Brush**

Just the tool to easily apply water or pick water up off newly finished surfaces. Also handy for cement finishing. Has removeable hardwood handle with steel ferrule. Insert felt pads into a 1-1/4"x7-1/2" aluminum channel with sturdy 1/8" sidewalls. Comes with two 4"x8-7/8" felt pads.

No.	
PL224	Blister Brush
PL225	Extra pair felt pads



**Angle Plane**

Use this handy tool instead of your trowel blade to work down high spots, scrape walls and clean angles. It has 7 blue steel blades, 1-1/4" deep.

No.	Size
PL300	4"x10"



**Angle Float**

Very best angle floats are lightweight. This float has square side edges and tapered angles on both ends. Perfect for brown coating. 3/4" high side walls.

No.	Size
PL061	9"x4" magnesium
PL063	10"x5" magnesium
PL065	9"x4" stainless steel



**Magnetic Nail Hammer**

Grips nail tightly. Lets you into tight places. 12-1/2" handle. Weighs 25 oz.

No.	PL258
-----	-------

**Magnetic Nail Drivers**

Made of stainless steel. Grips nails tightly. Lets you reach really tight spots. Has 5/8" hexagonal shank, giving you a good grip.

No.	
PL252	5-1/2" long, 3/4" diam. nose
PL256	8" long, 9/16" diam. nose



**Plasterer's Scarifier**

Used to easily scratch undercoats so finish coat will bond and not separate.

Has light, flexible steel tines, all welded construction, steel handle.

No.	Size
PL206	6"
PL208	8"
PL212	12"
PL214	14"
PL216	16"



**Angle Trowel**

Made of flexible stainless steel. Has 90 degree angle. 4" wide blades are tapered back from 5" at center to 4-1/4" at outside edge.

No.	PL320
-----	-------



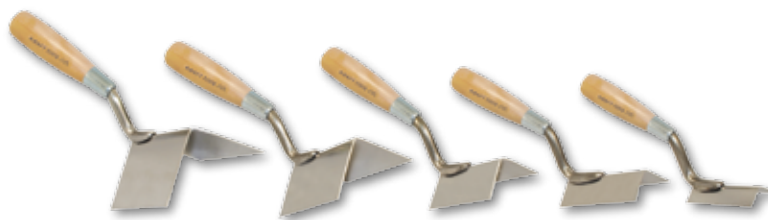

**Stainless Steel Outside Corner Trowels - 90°**

Great for detailing outside corners for EIFS, stucco and plaster. Leaves a clean, smooth corner. Trowels have 90 degree angle.

No.	Size
PL590	3-1/8"x1/2"
PL591	3-1/8"x3/4"
PL592	3-1/8"x1"
PL593	4"x1-1/2"
PL594	4"x2"



**Stainless Steel Inside Corner Trowels - 90°**

Great for detailing inside corners for EIFS, stucco and plaster. Leaves a clean, smooth corner. Trowels have 90 degree angle.

No.	Size
PL580	3-1/8"x1/2"
PL581	3-1/8"x3/4"
PL582	3-1/8"x1"
PL583	4"x1-1/2"
PL584	4"x2"



**Stainless Steel Rounded Detail Trowel**

100% stainless steel. Great for detailing plaster and EIFS.

No.	Size
PL585	6"

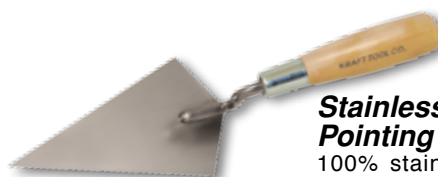

**Stainless Steel Pointing Detail Trowel**

100% stainless steel. Great for detailing plaster and EIFS.

No.	Size
PL586	6"



**Sheet Metal Cutting Shears**

A favorite with sheet metal, lath and tile professionals. Cuts sheet metal, tile, asphalt, wire, plastic, shingling, carpets. Forged snips are contoured for easier cutting, less fatigue. New style.

No.	Size
LA292*	12" Economy snips



**Offset/Bent Pattern Snips**

Drop forged. Offset blades keep hands clear of metal. Blades individually hand edged for maximum cutting. Rust resistant blades.

No.	Size
LA291*	14"



**End Cut Nippers**

Comfortably cut wire all day long with these steel lather's nippers. 8" and 9" nippers have plastic handle grips.

No.	Size
LA407	7"
LA408	8"
LA409	9"



**Wiss Snips Aviation Style**

Perfect for metal lath work. Double action. Plastic color coded grips for safety/comfort.

No.	Size
LA205	Left cutting (Red)
LA207	Right cutting (Green)
LA350	Straight & combination (Yellow)



**Lightweight Aluminum Snips**

Comfortable, lightweight tool cuts up to 22 gauge steel and stainless steel up to 26 gauge. Great for vinyl, aluminum siding, vinyl flooring, and roofing materials.

No.	Size
LA377*	12"



**Multi-Master Snips**

Extra long 3" blades for easier faster cutting. Compound action cutting system cuts twice as long as standard snips. Cuts up to #20 gauge steel.

No.
LA375

\*See page 130

**EIFS Sanding Rasps**



These giant sanding rasps have very coarse #12 grit sandpaper faces for use on EIFS wall finish systems. Sandpaper glued to face of aluminum back. Comes with wood float handle for comfortable grip.

- | No.   | Size                     |
|-------|--------------------------|
| PL514 | 8"x14" Rasp              |
| PL520 | 6"x14" Rasp              |
| PL515 | 4"x14" Rasp              |
| PL516 | 2"x14" Rasp              |
| PL517 | 8"x14" Replacement Sheet |
| PL521 | 6"x14" Replacement Sheet |
| PL518 | 4"x14" Replacement Sheet |
| PL519 | 2"x14" Replacement Sheet |

PL379 Contact Cement (one pint) for sandpaper replacement



**EIFS Corner Tools**

Stainless steel blade with rust-resistant tang and hardwood handle. Ideal tool for finishing corners, grooves, inset/offset trim lines, around doors and windows.

- | No.   | Size              |
|-------|-------------------|
| PL504 | 3"x1" Outside     |
| PL505 | 3"x1" Inside      |
| PL506 | 3"x1-1/2" Outside |
| PL507 | 3"x1-1/2" Inside  |
| PL508 | 3"x2" Outside     |
| PL509 | 3"x2" Inside      |

**Bucket Trowel**



Stainless steel tapered blade allows user to eliminate wasted material left in bucket. Comes with wood handle and special tang to hang on side of bucket.\*

- | No.    | Size         |
|--------|--------------|
| PL800* | 7"x4-1/2"x3" |

**EIFS NOTCH TROWELS  
12"x5"**



**Stainless Steel Notched Trowels**

Stainless steel notched trowels allow accurate application of EIFS materials. Comes with camel back wood handle



- | No.   | Size              |
|-------|-------------------|
| PL622 | 3/16"x1/4"x1-1/2" |



- |       |                  |
|-------|------------------|
| PL623 | 1/4"x1/4"x1-1/2" |
|-------|------------------|



- |       |                  |
|-------|------------------|
| PL624 | 3/8"x1/2"x1-1/2" |
|-------|------------------|



- |       |              |
|-------|--------------|
| PL625 | 1/2"x1/2"x2" |
|-------|--------------|



- |       |                   |
|-------|-------------------|
| PL626 | 3/16"x3/8"x1-7/8" |
|-------|-------------------|

**Please Note:**  
Drawings at left represent (only) shape of the notches.  
See measurements for exact sizes.



**Plastic Corner Tools**

Durable plastic tools for inside and outside corners. Choice of 1/2" or 3/4" radius. Great tool for pool, plaster or stucco jobs. No carbon marks to worry about. Size: 3"x1-3/4".

- | No.   | Size                       |
|-------|----------------------------|
| PL010 | 1/2" radius...inside tool  |
| PL012 | 1/2" radius...outside tool |
| PL014 | 3/4" radius...inside tool  |
| PL016 | 3/4" radius...outside tool |



**Bucket Scoop**

Galvanized steel scoop; great for loading trowels and transferring mortar, plaster or stucco material. Comes with wood handle and bucket hanger.

- |     |        |
|-----|--------|
| No. | PL804* |
|-----|--------|



**Bucket Brush**

Made of 4" long white tampico. Great for tool clean up and many other uses. Hang device allow brush to be stored on bucket away from material. 7" Plastic handle.

- | No.   | Size                  |
|-------|-----------------------|
| BL527 | 6-1/2"x1-3/4" (Block) |



**Lid Claw**

Remove lids from plastic buckets easily and quickly. Made of a strong durable plastic.

- | No.   | Size      |
|-------|-----------|
| DW110 | 8" Length |

## Texture Rollers

Now in just minutes you can create a unique finish on walls, ceilings and below chair rails. Simply roll this texture roller over fresh textured surfaces to provide a beautiful uniform pattern. Hides blemishes and defects in old walls. Fits standard 9" paint roller.

No.	Description
DW180	Crowsfoot
DW180R	Crowsfoot w/ roller frame
DW181	Basket Weave
DW181R	Basket Weave w/ roller frame
DW182	Monterrey
DW182R	Monterrey w/ roller frame
DW183	Poinsettia
DW183R	Poinsettia w/ roller frame
DW184	Tree Bark
DW184R	Tree Bark w/ roller frame
DW185	Vine
DW185R	Vine w/ roller frame
DW186	Palm Leaf
DW186R	Palm Leaf w/ roller frame

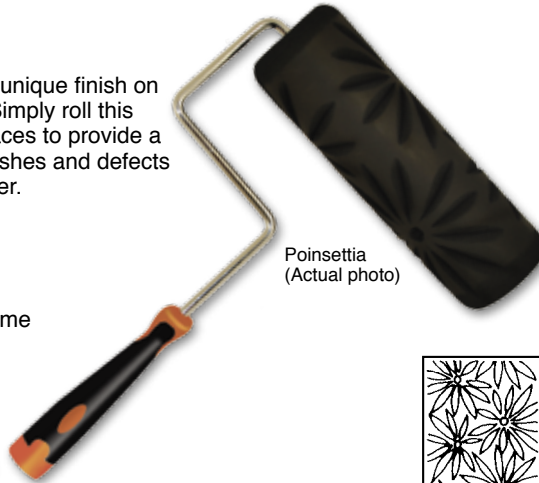

### Roller Frame Only

9" roller frame with soft style handle, threaded end for extension handle.

No.  
DW179\*

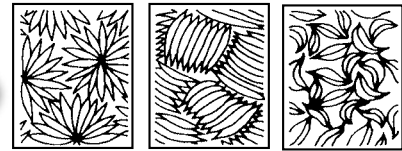

Crowsfoot Basket Weave Monterrey

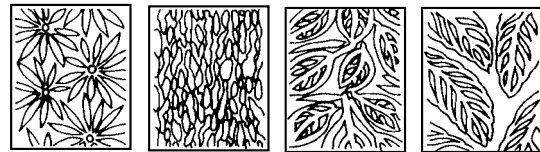

Poinsettia Tree Bark Vine Palm Leaf

- Comes with or without roller frame
- Outstanding decorations for new walls!
- Economically applied and simple to use!



### Knock Down Knife

Clear, durable, flexible Lexan knock down knife. Used for drywall, EIFS, and acoustical jobs. Threaded end plastic handle. Packaged 6 per carton.

No.	Size
DW193	18"x12"
DW194	24"x12"



### Patch Gun

Handy and efficient tool for acoustic repairs, remodeling and patching. Great for spot retouching. Adjust to type of texture.

No.  
DC195\*



### Spray Shield

High impact super-flexible plastic, lightweight easy to clean. Keeps paint off window frames and floors. Ideal to control spray for acoustical ceilings.

No.	Size
DC192	12"x36"

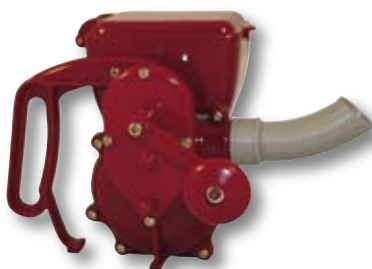

### Glitter Gun

Plastic glitter gun used to apply glitter to ceilings and walls. Easily operated by turning handle to apply a steady flow of glitter to surface.

No.  
DC615\*



### Glitter

Gives sparkling effect to ceiling. Covers about 500 sq. ft. per pound. Glitter is applied by blowing on with glitter gun to wet surface of texture. Fade and tarnish resistant. Not recommended for outside use. 1/16" cut silver and gold glitter.

No.

DC452	(A) 1 lb. Silver glitter
DC492	(B) 1 lb. Gold glitter
DC456	(C) 1 lb. Glaschip#20 size
DC462	(D) 1 lb. Multi glitter
DC472	(E) 1 lb. Iris glitter



### Corner Roller

Available in 2 sizes

Apply joint compound or drywall mud. Sturdy handle for easy reach. Comes with replaceable lambs wool cover.

No.	
DC265	6" w/ 19" handle corner roller
DC266	6" lambs wool cover replacement
DC267	4" w/ 14" handle corner roller
DC268	4" lambs wool cover replacement



# Gun & Hoppers

## PC501 Standard Texture Gun & Hopper



Ideal for spraying walls, ceilings, fireproofing and stucco

### PC501

- Texture guns made of cast aluminum for long wear
- Top hopper handle for control of hopper
- Hopper angle great for walls and ceilings
- Sprays a variety of textures

PC507 Repair Kit for Standard Gun

## PC301 Super-Pro® Texture Gun & Hopper



Sprays a variety of textures and materials

### PC301

- Large 2.5 gal hopper with built in control handle, 40 degree hopper angle for easy spraying
- Ezy pull full grip bronze trigger for less fatigue
- Special orifice adjusting nut makes orifice selection quick and easy
- Patented Super Pro® gun cylinder and shut off valve

PC307 Super-Pro® Gun Cylinder  
U.S. Patent #5,415,351

### Standard Compressor

PC500 Standard Texture Gun & Hopper with Standard Compressor (Complete Unit)



PC500

### EZ-Shooter Oil-less Compressor

PC635 Standard Texture Gun & Hopper, Hose, Oil-less Compressor with Carrier



PC635

### EZ-Shooter Oil-less Compressor w/ Cart

PC640 Standard Texture Gun & Hopper, Hose, Oil-less Compressor with Carrier & Cart (Complete Unit)



PC640

### Standard Compressor

PC300 Super-Pro® Texture Gun & Hopper with Standard Compressor (Complete Unit)



PC300

### EZ-Shooter Oil-less Compressor

PC625 Super-Pro® Texture Gun & Hopper, Hose, Oil-less Compressor with Carrier



PC625

### EZ-Shooter Oil-less Compressor w/ Cart

PC630 Super-Pro® Texture Gun & Hopper, Hose, Oil-less Compressor with Carrier & Cart (Complete Unit)



PC630

# Texture Compressors

Oil-less Compressor with Carrier



Professional Oil-less Texture Compressor

Oil-less Compressor with Carrier & Cart



- OIL-LESS air supply
- Motor and compressor are combined into one single design
- Telescoping handle for correct working height

- Heavy duty 200 psi hose resists kinking
- Delivers 7.0 C.F.M. free air at 25 PSI
- Sprays a variety of textures and materials



**NEW**

# Gun & Hoppers

## PC401 EZY Deck Pro Gun & Hopper

Sprays overlay and decking material

### PC401

- Built in downward hopper angle ideal for decks and floors w/ flexible neck
- Control hopper with built in finger tip handle
- Full grip trigger for ease and comfort
- Remove nozzle and tip for quick and easy cleaning

**NEW**  
Flexible neck for variable positions.



- PC407 Nozzle repair kit
- PC409 Flexible neck ONLY

### Standard Compressor

PC400 EZY Deck Pro Gun & Hopper with Standard Compressor (Complete Unit)



### EZ-Shooter Oil-less Compressor

PC615 EZY Deck Pro Gun & Hopper, Hose, Oil-less Compressor with Carrier



### EZ-Shooter Oil-less Compressor w/ Cart

PC620 EZY Deck Pro Gun & Hopper, Hose, Oil-less Compressor with Carrier & Cart (Complete Unit)



## PC201 ProForm® Texture Gun & Hopper

Sprays a variety of textures and materials

### PC201

- Built in hopper angle lets user direct spray at just the right angle for walls and ceilings
- Built in easy grip hopper handle
- Full grip trigger for ease and comfort
- Remove nozzle and tip for quick and easy cleaning



- PC407 Nozzle repair kit

### Standard Compressor

PC200 ProForm® Texture Gun & Hopper with Standard Compressor (Complete Unit)

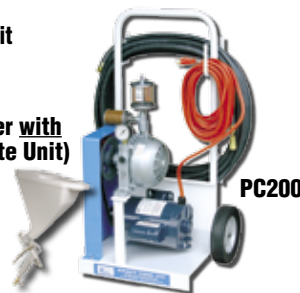

### EZ-Shooter Oil-less Compressor

PC605 ProForm® Texture Gun & Hopper, Hose, Oil-less Compressor with Carrier



### EZ-Shooter Oil-less Compressor w/ Cart

PC610 ProForm® Texture Gun & Hopper, Hose, Oil-less Compressor with Carrier & Cart (Complete Unit)



# Texture Compressors

## Standard Compressor

Ideal for Spraying  
Walls & Ceilings, Fire Proofing,  
Stucco, Decking, Waterproofing



- Unit is equipped with a 1 H.P. capacitor-start electric motor with manual re-set thermal overload protector
- Rotary vane compressor delivers 6.2 C.F.M. free air at 25 P.S.I.
- Two-wheel cart is 19" wide, 34" high and measures 15" front to back
- Heavy-Duty 200 P.S.I. hose, resists kinking
- The 8x1.75 wheel and tire have a load rating of 100 lbs. each. Shipping weight is 103 lbs

# Mud Pans



Special **NON-SLIP**  
textured surface

## EZ-GRIP MUD PAN

**STAINLESS STEEL**

EZ-Grip Mud Pans feature a non-slip textured surface which provides the professional finisher with a more secure grip with less hand fatigue.

Mud pans have tapered ends and sides. Sides are sheared to clean knife easily. Pan resists rust and easy to clean.

No.	Size
DW720	10-1/4"x3"
DW722	12-1/4"x3"
DW724	14-1/4"x3"

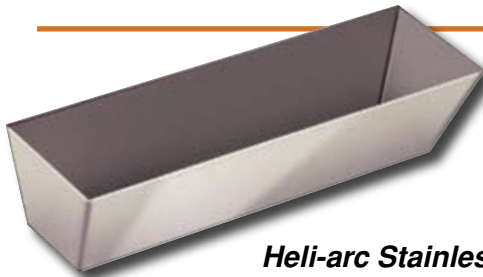

Mud Pan  
depth 3-1/4"

### Heli-arc Stainless Steel

These heli-arc welded mud pans have tapered ends and sides. Pan resists rust and easy to clean. Sides are sheared to clean knife easily.

No.	Size
DW710	10-1/4"x3"
DW712	12-1/4"x3"
DW714	14-1/4"x3"
DW718	18-1/4"x3"

### Drywall Mud Holder

Stainless steel mud holder is designed mainly for drywall work. Comfortable detachable handle fastens securely to blade. Comes with sponge rubber callous preventer.

No.	Size
DW-460	12"x6" w/1-1/2" lip

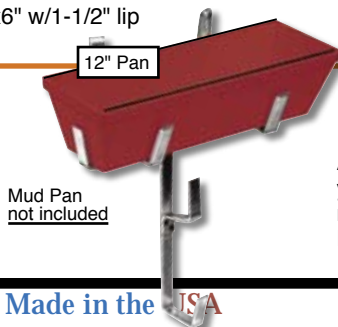

Mud Pan  
not included

### Mud Pan Holder

All aluminum, this lightweight mud pan holder hooks to your belt to hold your mud pan where you can get at it easily, leaving your hands free to work. Has a hook below the pan to hold a roll of tape.

No. DW207



Rounded Edge

### Round Bottom EZ-Grip Mud Pan

Smooth tapered ends with contoured corners. Sides sheared to clean knife easily. Natural contour for comfortable, non-slip grip.

No.	Size
DW723	10-1/4"x3"x3" deep <b>NEW</b>
DW725	12-1/4"x3"x3-1/4" deep <b>NEW</b>
DW726	14-1/4"x3"x3-1/4" deep <b>NEW</b>

### Plastic Mud Pans

These heavy-duty plastic mud pans have tapered ends and sides with one replaceable steel wiping blade. Resists chemicals and won't break if dropped.

No.	Size
DW210	10-1/4"x3"x3" deep
DW212	12-1/4"x3"x3-1/4" deep
DW214	14-1/4"x3"x3-1/4" deep



### Plastic Double Bladed Mud Pan

12" double bladed plastic is more pliable than our standard mud pan. Designed so you can wipe knife clean on both sides.

No.	Size
DW312	12-1/4"x3"x3-1/4" deep

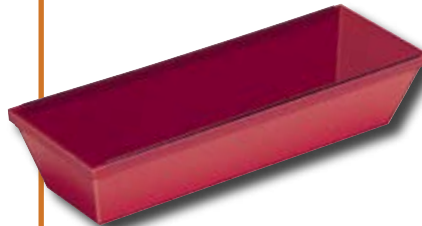

### Galvanized Mud Pans

Joint cement pan. Most popular low cost, heavy gauge galvanized pan on the market. Sides are sheared to clean knife easily. Tapered sides and ends.

No.	Size
DW410	10"
DW412	12"
DW414	14"
DW418	18"

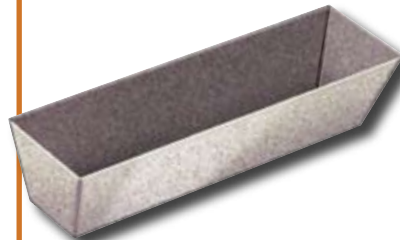



# Drywall Mud Mixers

## Egg Beater Mixer

### Egg Beater Mixer

7/16" steel hex shaft. 30" overall length. Plated solid steel. For use in a 1/2" drill or larger. Use to mix thin set, grout and concrete products. Easy to use, easy to clean.  
No. DC716\*

## Jiffler Mixers

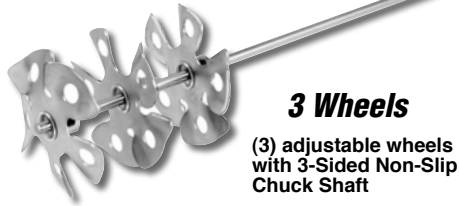

### 3 Wheels

(3) adjustable wheels with 3-Sided Non-Slip Chuck Shaft

### Jiffler Mixers - 3 Wheels

Has three 5" steel mixing wheels, 3/8"x24" shaft. Lets you easily mix 5 gallons of drywall mud in 1-1/2" minutes in 12" diameter container. For use in a 1/2" drill or larger. Easy to use, easy to clean.  
No. DC311

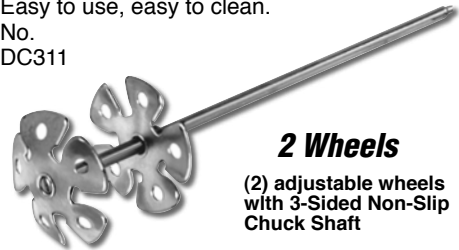

### 2 Wheels

(2) adjustable wheels with 3-Sided Non-Slip Chuck Shaft

**2-1/2" steel mixing wheels**, 1/4"x11" shaft. For use with 1/4" drill or larger with portable or stationary power of over 1800 r.p.m. in a 4 to 10 qt. container.  
No. DC342

**3-1/2" steel mixing wheels**, 3/8"x16" shaft. For use with 1/4" drill or larger with portable or stationary power of over 100 r.p.m.  
No. DC343

**5" steel mixing wheels**, 3/8"x24" shaft. Lets you easily mix 5 gallons of drywall mud in only two minutes. Use with 1/2" drill.  
No. DC310

**6-1/2" steel mixing wheels**, 1/2"x24" shaft. Lets you easily mix a two-sack batch in only one minute in a 12" to 15" container. Use with 1/2" drill.  
No. DC312

## Stainless Steel Jiffy Mud & Paint Mixers

Fits containers 3 gallons or larger. 21" long, 1/2" shaft, top diameter 4-1/2", bottom diameter 5", depth 5"  
No. DC409



Round Shaft

Round Shaft

For small containers, 2 gallons or less. 10-1/2" long, 1/4" shaft, top diameter 2-3/8", bottom diameter 2-5/8", head depth 2-1/2".  
No. DC408

## (A) Junior Mud Mixers

Mud mixer has a cast aluminum paddle 8-1/2"x5" deep. 7/16" steel shaft works in slow speed 1/2" drill. New rounded end design for better balance when mixing. Ideal for mixing drywall mud and texture materials.

No.	Size	New & Improved Tip
DC713	7/16" diam.x30" shaft	
DC714	7/16" diam.x36" shaft	

## (B) Fast-Mixers

Heavy-duty mixer is ideal for mixing drywall mud, acoustic or blending paint. Mixer has an aluminum paddle 8-1/2"x4" deep. 7/16" diam. steel shaft fits any 1/2" or larger slow-speed drill.

No.	Size
DC307	7/16" diam.x28" shaft
DC308	7/16" diam.x36" shaft

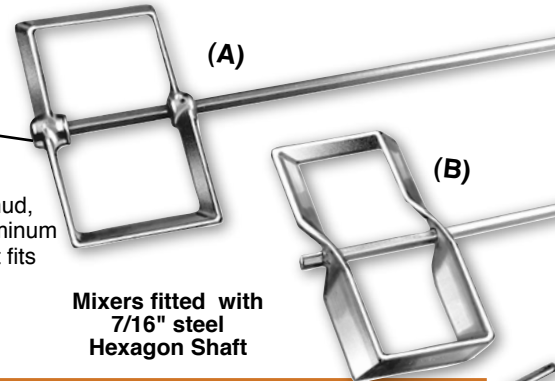

Mixers fitted with 7/16" steel Hexagon Shaft

## Spiffy Mixers

Double or triple 5" diam. fan blade mixer, zinc plated adjustable or welded blades. Non-slip 3/8" steel hexagon shaft for durability. Fits 1/2" slow speed drill.

No.	Size
DC302	2-wheel, 24" adj. shaft
DC303	3-wheel, 24" adj. shaft
DC304	2-wheel, 24" shaft welded
DC305	3-wheel, 24" shaft welded



## Unomixers

Ideal for fast mixing of all kinds of materials, from paint to cement. For use in a 1/2" drill chuck.

No.	Size
DC362*	2-1/2" diameter, 16" shaft
DC363*	3-1/4" diameter, 16" shaft
DC365*	4-3/4" diameter, 30" shaft
DC367*	5-1/2" diameter, 30" shaft



Round Shaft

## Deluxe Mud Mixer

Mixes all kinds of drywall mud and texture materials fast and completely. Works in 5 to 55 gallon drums. Mixer works in slow speed 1/2" or larger drill. Paddle head is 9-5/8" wide, and 6-1/4" deep.

No.	Size
DC715	1/2"x30"

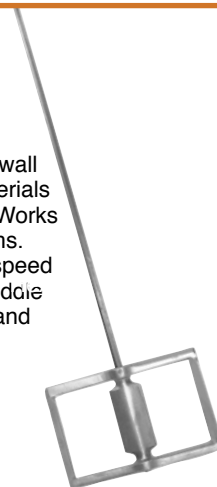

## Mud Mashers

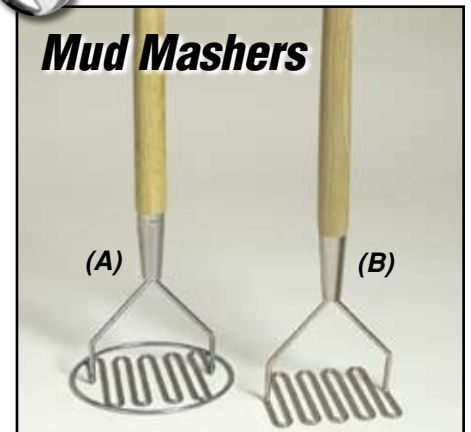

(A) Has 5" diameter round head; durable wood handle. Made of heavy steel wire.

No. DW101*	Masher W/24" wood handle
No. DW101L*	Masher W/30" wood handle

(B) Has 5" square head; durable wood handle. Made of heavy steel wire. Mixes small batches quickly and easily

No. DW103*	Masher W/24" wood handle
No. DW103L*	Masher W/30" wood handle

\*See page 130

# Taping Knives



Also available in "Stainless Steel"



Also available in "Stainless Steel"

## Wide Handle Taping Knives

Wide plastic handle taping knives. Fitted with lightweight flexible blue steel blade. Special lightweight blue handle shaped to fit the contours of the hand for maximum comfort. **(Add SS to the number for stainless steel)**

No.	Size
DW808	8"x3"
DW810	10"x3"
DW812	12"x3"

## Flexible Taping Knives

Flexible blue steel blade. Durable blue plastic handle carefully shaped for comfort. This knife has just the right balance for effortless taping and finishing. **(Add SS to the number for stainless steel)**

No.	Size
DW548	8"x3"
DW550	10"x3"
DW552	12"x3"



Also available in "Stainless Steel"

## Deluxe Taping Knives

Wide flexible spring steel blade in lightweight rust proof aluminum mounting. Special contoured wood handle tapered for a comfortable grip. **(Add SS to the number for stainless steel)**

No.	Size
DW908	8"x3"
DW910	10"x3"
DW912	12"x3"
DW914	14"x3"



Also available in "Stainless Steel"

## Silver Line Taping Knives

These drywall taping knives were designed and engineered with the drywaller in mind. Blade is made of flexible blue spring steel. Fitted with comfortable wood handle. **(Add SS to the number for stainless steel)**

No.	Size
DW608	8"x3"
DW610	10"x3"
DW612	12"x3"
DW614	14"x3"



Textured Soft Grip Handle

## ProForm® Taping Knives

Flexible blue steel blade with comfortable soft grip ProForm® handle with textured ribbing for a "Great Grip". **(Add SS to the number for stainless steel)**

No.	Size
DW476	6"x3"
DW478	8"x3"
DW480	10"x3"
DW482	12"x3"
DW484	14"x3"

Also available in "Stainless Steel"



## Long Handle Taping Knives

These taping knives have 16" long wood handles that makes these knives popular on the job. Blade is made of flexible blue spring steel.

No.	Size
DW624	14"x4"
DW628	18"x4"
DW630	20"x4"
DW634	24"x4"

## Professional Hammer-End Joint/Taping Knives

Rugged plastic handle, with brass hammer-end



### 5 Sizes

Ground and polished flexible blade for a professional finish. Comfortable handle with convenient metal hammer-end.

No.	Size
DW527*	1-1/2" wide blade
DW528*	2" wide blade
DW529*	4" wide blade
DW530*	5" wide blade
DW533*	6" wide blade

NEW  
NEW

## Long Handle Broad Knives



**(A)** Aluminum 6' button handle (CC336) attached to broad knife for extra long reach.

No.	Description
DW283	9" Broad Knife w/6' button handle

**(B)** Choice of 7" or 9" wide spring steel blade with rounded corners attached to an aluminum handle. Over all length 17-1/2". Reinforced where the blade attaches to handle. Easy to change replaceable blade.

No.	Size
DW281	7" Broad Knife
DW281-01	7" Replacement blade
DW282	9" Broad Knife
DW282-01	9" Replacement blade
DW277	7" Broad Knife w/ 28" Hdle

**NEW**



**Flexible Non Rust Stainless Steel Putty & Drywall Knives**

Flexible putty and drywall knives. One-piece stainless steel blade and handle. Blade ground for comfortable "broken-in" feel.

- No.            Size
- DW727\* 1-1/2" wide blade **NEW**
- DW728\* 2" wide blade **NEW**
- DW729\* 4" wide blade **NEW**
- DW730\* 5" wide blade **NEW**
- DW733\* 6" wide blade **NEW**



**NEW**



**Joint Knives w/ Rosewood Handle**

Flexible putty and drywall knives. Carbon steel with mirror polish blade. Rosewood handle fitted with metal hammer-end (for setting nails).

- No.            Size
- DW427\* 1-1/2" wide blade **NEW**
- DW428\* 2" wide blade **NEW**
- DW429\* 4" wide blade **NEW**
- DW430\* 5" wide blade **NEW**
- DW433\* 6" wide blade **NEW**



**NEW**



**Stainless Steel Wall Scraper w/ Rosewood Handle**

Tough, flexible scraper great for multiple applications in drywall, painting and other surface preparations. Stainless steel, broken-in blade with rosewood handle.

- No.            Size
- DW437\* 4" wide blade **NEW**



www.KraftTool.com

**Drywall Tapers**



**Kraft Drywall Taper**

This taper is made from aluminum. Won't rust and easy to clean up. Has large mud capacity and holds all 500' rolls of tape. Includes adjustable slide/blade to regulate mud and to cut tape quickly and accurately.

- No. DC401

Tape NOT included. For Left Hand Tapers, please specify "L" after the Part Number!

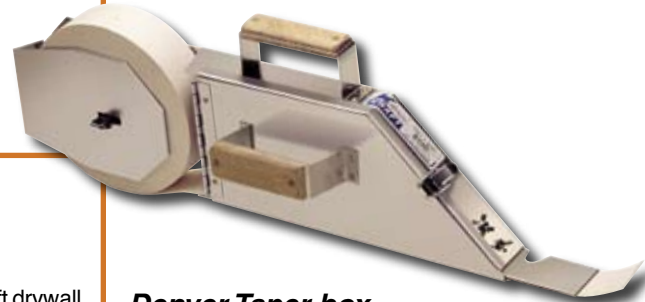

**Denver Taper box**

Works with 500' rolls of tape. Made of aluminum. Easy to use, easy to clean. Adjustable slide/blade to regulate mud and to cut tape quickly and accurately.

- No. DC403



**K.C. Taper**

K.C. taper is made exactly like the Kraft drywall taper, except that it has a 2" wide web handle for ease in holding taper while applying tape.

- No. DC402

# Rubber Wipe Down Knives

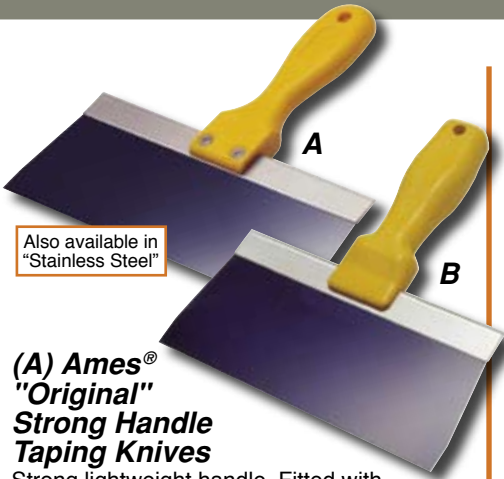

Also available in "Stainless Steel"

**(A) Ames® "Original" Strong Handle Taping Knives**

Strong lightweight handle. Fitted with a flexible lightweight blue steel blade and balanced for effortless taping and finishing. (Add SS to the number for stainless steel.)

No.	Size
DW008	8"x3"
DW010	10"x3"
DW012	12"x3"

**(B) Ames® Strong Handle**

High strength yellow plastic handle. Fitted with a flexible lightweight blue steel blade. Well balanced and easy to use. (Add SS to the number for stainless steel.)

No.	Size
DW648	8"x3"
DW650	10"x3"
DW652	12"x3"

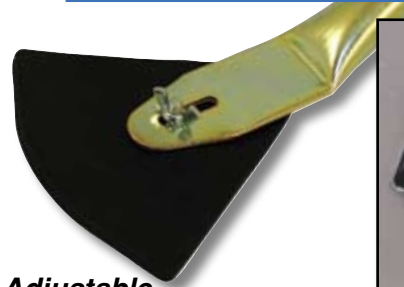

**Adjustable Wipe Down Knife**

Two knives in one. A flexible rubber taping and wipe down knife for inside 90 degree angles. Just loosen the wing nut and turn the pad around, for angles over 90 degrees.

No.	Size
DW453	

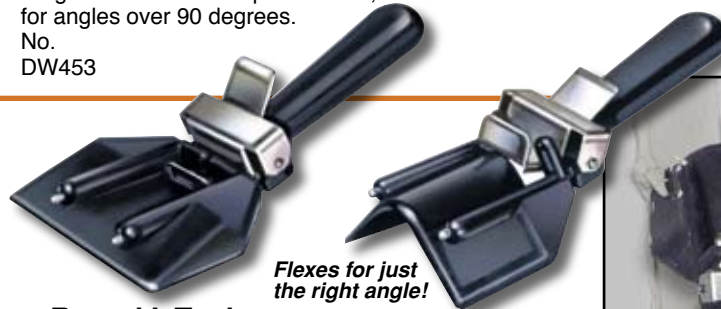
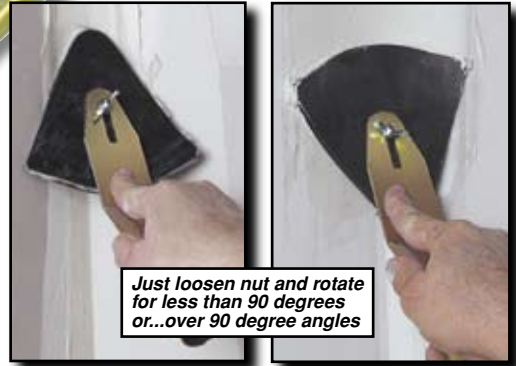

*Flexes for just the right angle!*

**Round It Tool**

With just a push of the thumb you can adjust the angles as you go for smooth professional outside angles and round corners.

No.	Size
DW454	6-1/2"x4-1/2" diam.



**Bullnose Corner Tools**

Bullnose corner tools are made of lightweight flexible stainless steel. Blade angles flex to 90 degrees when used. Blades are 5" long with 2-1/2" sidewalls. Fitted with smooth wood handle.

No.	Size
DW451	(Outside)
DW450	(Inside)



**Flexible Wipe Down Knife**

Flexible rubber knife for taping and cleaning excess mud from inside angles. Ideal for splay and angles that are wider than 90 degrees. Lightweight and easy to clean. Can be used by hand or with any 1" diameter pole.

No.	Size
DW438	

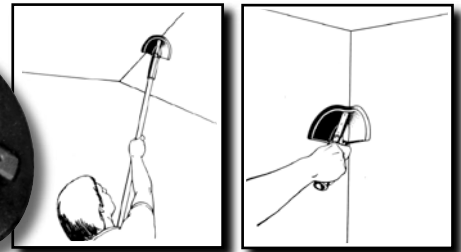

**Outside Corner Tool - Long Handle**



Stainless steel flexible 2"x3" blade. Will not rust or pit. Overall length 13". Great for finishing around windows and hard to reach areas.

No.	Size
DW519	2"x3"



**Outside Corner Tool**

Made of stainless steel. Will not rust or pit. 80 degree angle flexes to 90 degree when used. 5" long at center and tapers to 4-1/4" at outside edge.

No.	Size	Blade Depth
DW619	4"x5"	2-1/2"
DW621	4"x5"	4"



**Inside Corner Tool**

Corner tool blade is formed from flexible stainless steel. Its 103 degree angle flexes to 90 degree for perfect corners. This is a lightweight, perfectly balanced tool.

No.	Size
DW520	4"x5"



**Stud Crimper**

Compound leverage permits ease of punch through two layers of 22 gauge metal. Made of forged and hardened steel. Nickel plated to resist corrosion.  
No.  
DC273\*

**Stud Crimping Tool**

A specially designed tool for setting light gauge metal studs and track, furr downs, door and window headers. Use on .025 gauge or lighter galvanized metal. Secures metal to metal. Weighs only 14 oz; 10" long.

- No.  
GG163 Stud Crimping Tool  
GG163-01 1/4" Replacement Crimper  
GG163-02 1/4" Replacement Bushing



**Combination Tool**

Heavy-duty five tools in one: scraper, seam opener, spreader, putty remover, cutout removes paint from rollers. Wood handle with brass rivets.

- No. Size  
DW027 2-1/4"

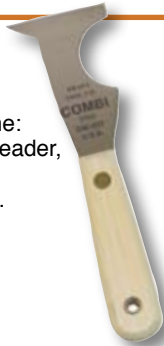

**1/8" Rivet Hole Punch**

Designed specially for accoustical grid systems. Cuts perfect 1/8" holes for painted or aluminum rivets. Reduces installation time up to 30%. High strength alloy weighs only 14 oz.; 10" long.

- No.  
GG159 Punch  
GG159-01 1/8" Replacement Punch  
GG159-02 1/8" Replacement Bushing

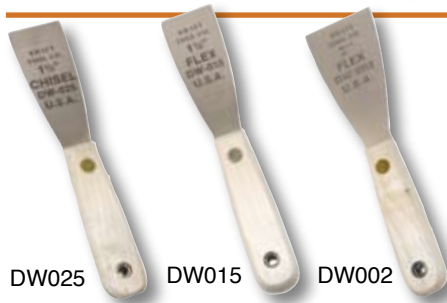

DW025 DW015 DW002

**Heavy "Chisel" Scraper**

Extra thick (.095) stainless steel, single bevel blade with brass riveted wood handle.

- No. Size  
DW025 1-1/2"

**Flexible Putty Knives**

Industrial, highest stainless steel flexible blades. Wood handles with brass rivets.

- No. Size  
DW015 1-1/2"  
DW002 2"

**Stiff Scrapers**

Wood handle, stainless steel 3" wide, stiff blade scraper of the best quality. Double bevel on standard and long handle models. Single bevel on bent model.

- No. Type  
DW033 Standard  
DW034 Long Hdl  
DW035 Bent



Standard

Long Handle

Bent

**Crows Foot Texture Brush**



Brush is made with white tampico fiber set in hardwood block 1-3/8"x6-3/8" Threaded handle hole in center. Single brush measures 8-1/2"wide, 13-1/2" long when flattened.

- No.  
DW118 Single brush  
DW118D Double brush

**Drywall Texture Brush**

Just the right brush for texturing. Use it in your hand or with a handle. Comes in two sizes and also available as a double brush unit. These brushes are made of horsehair and fiber bristles.

- No.  
DW116 2-1/2" long bristles, 6" diameter  
DW117 3-1/2" long bristles, 9" diameter



**Drywall Double Texture Brush**

Double brush unit comes in two sizes. Bristles are made of horsehair and fiber.

- No.  
DW116D (2) brushes 2-1/2" long bristles, 6" diameter  
DW117D (2) brushes 3-1/2" long bristles, 9" diameter



\*See page 130



**Drywall Patch**

The ideal way to repair holes or surface damage. Self-adhesive drywall patch is permanent and made from rustproof aluminum. Easy to cut to any size or shape. Apply over damaged area, cover with a finishing compound, sand and paint...its that simple.

- No.  
 DC418 4"x4"/50 Pack  
 DC419 6"x6"/50 Pack  
 DC420 8"x8"/25 Pack

**Drywall Pole Sander**

Kraft pole sander makes it easy to reach those hard to get at places high on walls and ceilings. Pole sander base is made of lightweight sturdy aluminum; with a bonded 9-3/8"x3-1/4" rubber pad and two positive lockclamps. Swivel head permits sanding anywhere. Comes with 48" wood handle.

- No.  
 DC317 Sander w/ wood handle  
 DC318 Replacement wood handle  
 DC317ASM Sander w/ wood handle assembled (pk 6 only)



**Extension Handle**

Made of lightweight aluminum. Extends from 4'8" to 8' for sanding ceilings and high walls.

- No.  
 DC319

**Handle Adapter**

Female fitting for pole sanders.  
 No. DC349



**Drywall Hand Sander**

This sander is very well balanced. Plastic handle has plenty of room for knuckle clearance. Base is made of lightweight aluminum. Screw type clamps hold diecut sandpaper tight against face. Sander face is 9-1/2"x3-1/4".

- No.  
 DW441



**Metal Corner Tape**

Rolled corner bead fits any corner. Work on outside or inside corners. Applies easily with joint cement.

- No.  
 DC701 100'x2-1/16" Rolls (Carton of 10)

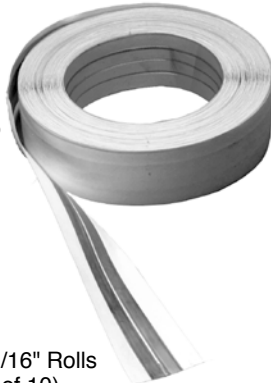

**Drywall Tape Holder**

An excellent tool for the drywall finisher. Made of steel for longer life. Holds all standard size drywall tape as well as our sure corner tape. Hangs from belt for easy access. Pull wire for easy refilling.

- No.  
 DW224



**Easy Change Blade Utility Knife**

Non-slip comfort handle. Storage for extra blades. Adjustable blade. See page 68 for replacement blade refills.

- No.  
 DW040\*



**Diecut Sandpaper**

Ideal for sanding down drywall joint mud or drywall board. Sheet size 11"x4-3/16".

No.	Grit	Pkg./Sheets
DC080	80 Grit	100
DC100	100 Grit	100
DC083	120 Grit	100
DC084	150 Grit	100
DC082	80 Grit	10
DC102	100 Grit	10
DC103	120 Grit	10
DC104	150 Grit	10

**Drywall Trowels**

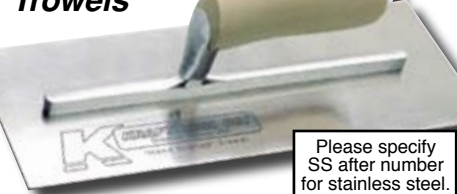

Please specify SS after number for stainless steel.

This trowel has a curved, high carbon or stainless steel blade for finishing drywall joints. It is a lightweight, flexible tool with perfect balance.

Straight wood hdl		ProForm® hdl
No.	Size	No.
DW521	12"x4-1/2"	DW521PF
DW541	14"x4-1/2"	DW541PF
DW516	16"x4-1/2"	DW516PF

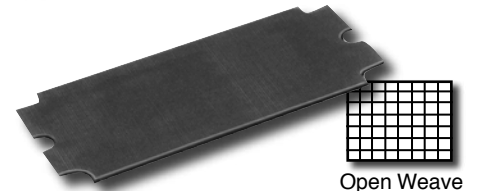

**Diecut Fabricut Sandpaper**

This open weave silicon carbide sanding cloth practically cleans itself. It lasts longer, cuts joint mud faster than regular sandpaper and won't easily clog.

No.	Grit	Pkg./Sheets.
DC120	120 Grit	50
DC220	220 Grit	50
DC122	120 Grit	10
DC222	220 Grit	10

**Wallscrapers**

This sturdy, 22" blue steel blade scrapes excess mud from walls and ceilings. Easy to change replacement blade and 48" replaceable wood handle.

- No.  
 DC386 Wallscrapers  
 DC388 22" Replacement blade  
 DC318 48" Replacement handle





**NEW**

### High Visibility Drywall T-Square

Bright yellow for easy job site visibility. Long wearing, black, easy to read markings. Reversed ruled to read from either edge. 2" wide blade.

No.            Thickness  
DW225      3/16" **NEW**



### Drywall T-Square

Our silver anodized 48" T-Square with black easy-to-read markings will outwear all others. Has stud locator markings, a notched head and is reverse ruled to read from either edge. Blade width 2".

No.            Thickness  
DW221      1/8"  
DW221M    1/8" (metric)  
DW222      3/16"



### Rockeater® — Drywall Saw

Make fast, clean cuts in drywall. 6" tempered blade. Chisel point for plunging and scoring. Comfortable ergonomic grip.

No.  
DW244\*



### Drywall Saw

This drywall saw blade is hardened and tempered for long wear. Large, specially designed teeth cut quickly through wallboard. 15" blade.

No.  
DW811\*    Saw w/ wood handle

### Drywall Hammer

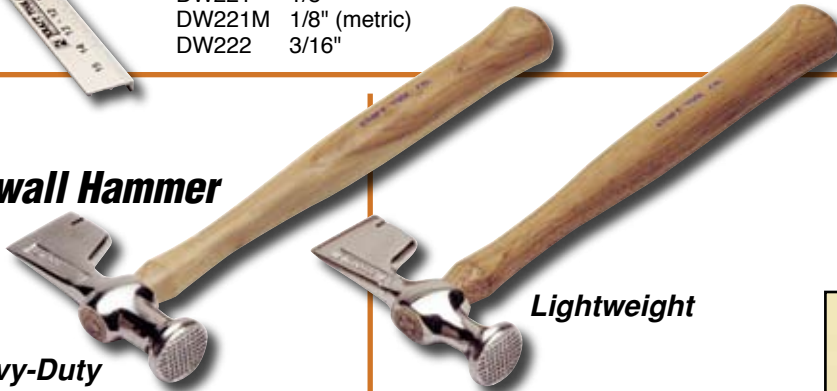

#### Heavy-Duty

Chrome checkered face makes nailing easy, prevents breaking the surface of wallboard. Checkered head is securely attached to a wood handle for a perfect balance.

No.  
DW254    18 oz. head / 14" handle  
DW264    18 oz. head / 16" handle

#### Lightweight

Beautifully balanced chrome head has a crowned face to make nailing easy. Lightweight durable checkered head is attached to a wood handle for a perfect balance.

No.  
DW354    13 oz. head / 14" handle  
DW364    13 oz. head / 16" handle



### Utility Drywall Saw

Rugged constructed with sharp point for easy penetration. Heat treated aggressive 6" blade is anchored into hardwood handle with steel ferrule to prevent splitting.

No.  
DW243\*



### Circle Cutter

8-1/2" long calibrated steel shaft enables sharp, clean cuts up to 16" in diameter. Hardened steel cutting blade and center point remain sharp. Chrome plated for long wear.\*

No.  
DW241\*

### Checkered Handle Utility Knife

Won't slip out of your hand. Blade can be adjusted. but does not retract. Storage for extra blades in handle. Includes 5 blades.

No.  
DW199

### 3-Way Utility Knife

Blade will not slip. Retractable blade can be adjusted to 3 positions. Light but rugged aluminum body. Comes with 3 blades.

No.  
DW042

### Utility Knife Replacement Blades

Packet of (100) heavy-duty blades. Fits Kraft, and most other utility knives.

No.  
DW077B    Box of (100)





## Drywall Panellift®

Panellift® is excellent for fast and easy installation of drywall. One person can easily load and operate. Takes only seconds to assemble or disassemble with no tools required. Load capacity 150 lbs. Maximum height 11'. Maximum height with 6' extension is 15'. Weight: 115 lbs.

No.  
DC164 Panellift  
DC166 18" extension  
DC167 6' extension with cable

Can ship  
UPS.

## Drywall Dolly



Must ship via truck

All steel structure of welded tubing. Corners are rounded. Bed is sloped to carry boards at proper angle. Comes with four heavy-duty casters; two locking swivel casters and two straight casters. 48" long by 24" wide and 48" tall. Goes through most doorways. Weight: 112 lbs.

No.  
DC323



### Drywall Roll Lifter

Rigid steel construction, ribbed back weighted nose and roller-wheel for moving ease. Permits one man to raise drywall up to 3". Weighs 2 lbs, 8 oz.

No.  
DC171



### Drywall Stirrup Footlift

Drywall stirrup footlift is made of cast aluminum, correctly balanced with lip always on floor. Just kick under board and lift. Stirrup allows moving of lifter without bending over.

No.  
DW273



### Clinch-on Tool

Clinch-On tool is operated by a spring loaded arm. A sharp blow from a rubber mallet drives the cornerbead on tight, centers it and clinches it in position without nails or screws.

No. Size  
DC806 1-1/8" Bead (less mallet)  
DC807 1-1/4" Bead (less mallet)  
DC808 Repair kit  
DC809\* Rubber Mallet (only)



### Drywall Lifter & Carrier

This is a combination tool. Carry a full sheet of board and then use it as a lifter. Step down on it and lift the board into place for nailing. Made of cast aluminum. Weighs only 2 lbs.

No.  
DC170



### Rasp

Rasp is the ideal tool to shave and form wood, vinyl, drywall and many other materials. Handy tool to carry in the pocket or pouch. Only 5-1/2" long.

No.  
DC135\* Rasp  
DC136\* Replacement blade

### Mini Lifter

Junior mini foot-lift is only 9" long. Very strong and lightweight.

No.  
DC175





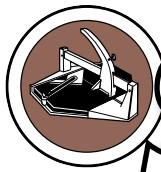

"The Original"

# SUPERIOR TILE CUTTER, INC.



Original tile cutter from 1930.

**Since 1930**.... the pioneer manufacturer of quality durable ceramic tile cutters, carbide tipped nippers, chisels, hammers, scribes and cutter wheels.



## Ceramic Tile Cutters



### SMALL 6"x11"

WT. 4.0 lbs

**ST001 (#00)**  
W/3 Wheel Turret

**ST002 (#00-400)**  
W/#400 Carbide Wheel  
ST054 Replacement pad set

MADE IN USA

Cuts 6" tiles straight and 4-1/2" tiles diagonally. Includes adjustable angle gauge.

- 4" working table on the right side of the breaker bar and 2" working table on the left side



### MEDIUM 12"x12"

WT. 8.0 lbs

**ST003 (#1A)**  
W/6 Wheel Turret

**ST004 (#1A-400)**  
W/#400 Carbide Wheel  
ST056 Replacement pad set

MADE IN USA

Cuts 6" tiles straight and 4-1/4" tiles diagonally. Includes adjustable angle gauge.

- 6" working table on each side of the breaker bar



### LARGE 15"x15"

WT. 9.0 lbs

MADE IN USA

**ST005 (#2A)**  
W/6 Wheel Turret

**ST006 (#2A-400)**  
W/#400 Carbide Wheel  
ST060 Replacement pad set

Cuts 10" tiles straight and 7" tiles diagonally. Includes adjustable angle gauge.

- 7-1/4" working table on each side of the breaker bar

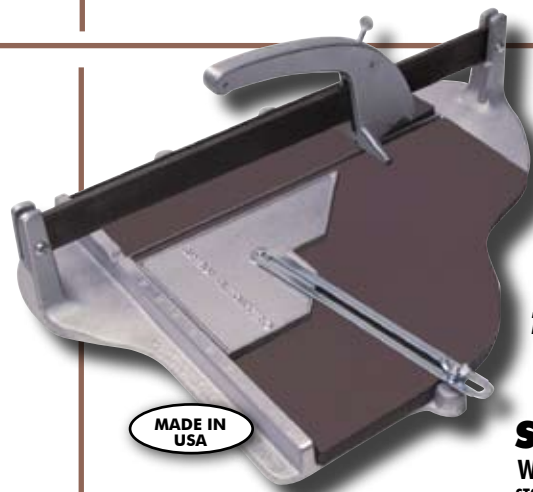

### JUMBO 16"x21-1/2"

WT. 13.0 lbs

MADE IN USA

**ST007 (#3)**  
W/#400 Carbide Wheel  
ST065 Replacement pad set

Cuts 16" tiles straight and 10" tiles diagonally. Includes adjustable angle gauge.

- 10" working table on the right side of the breaker bar and 4" working table on the left side
- Scores tile up to 1-1/2" in thickness



**The Choice of Professional Tile Setters Around The World**

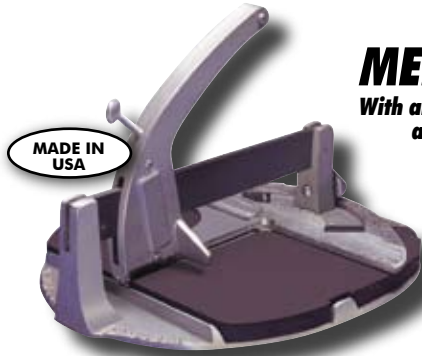

MADE IN USA

**MEDIUM**

With all angle protractor and adjustable square gauge

**12"x13"**

WT. 7.0 lbs

**ST010 (#1AA)**  
W/6 Wheel Turret

**ST011 (#1AA-400)**  
W/#400 Carbide Wheel

ST050 Replacement pad set

Cuts 7-1/2" tiles straight and 5" tiles diagonally. Includes all-angle protractor and adjustable square gauge.

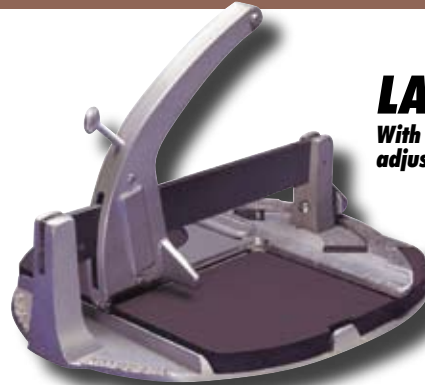

MADE IN USA

**LARGE**

With all angle protractor and adjustable square gauge

**12"x15"**

WT. 9.0 lbs

**ST012 (#2AA)**  
W/6 Wheel Turret

**ST013 (#2AA-400)**  
W/#400 Carbide Wheel

ST062 Replacement pad set

Cuts 9-1/2" tiles straight and 6" tiles diagonally. Includes all-angle protractor and adjustable square gauge.

Superior Tile Cutters are designed to score and evenly cut most types of bull nose, shoe-base, quarter rounds, wall tile, thin vit, quarry, porcelain and sheet ceramic tiles without moving the material. All Superior Tile Cutters feature the "A" type handle with automatic spring tension keeping the handle adjusted to the bar.



MADE IN USA

**JUMBO**

Straight cut with adjustable gauge bar

**12"x32"**

WT. 18.0 lbs

**ST008 (#4)**

W/#400 Carbide Wheel ST067 Replacement pad set

Cuts 24" ceramic and thin tiles straight. Includes adjustable gauge bar.

• 6" working table on each side of the breaker bar



MADE IN USA

**JUMBO**

Straight cut with all angle protractor

**12"x32"**

WT. 18.0 lbs

**ST009 (#4AA)**

W/#400 Carbide Wheel ST067 Replacement pad set

Cuts 24" ceramic and thin tiles straight. Includes all-angle protractor.

• 6" working table on each side of the breaker bar

**Carbide Scoring Wheels**



#400 Carbide Wheel #200 Carbide Wheel

**ST048 #400 1/2" Carbide Scoring Wheel**  
**ST051 #200 1/2" Carbide Scoring Wheel**

- Each are fitted with bushing, washer, screw and locknut
- Carbide wheels fit all Superior Tile Cutters and can be sharpened, thus increasing the life of the wheel

**Brass Turrets**



6 Wheel Turret 3 Wheel Turret

**ST049 (6) Wheel 1/2" Brass turrets (2 ea.)**  
**ST050 (3) Wheel 1/2" Brass turrets (2 ea.)**

- Low cost 1/2" replacement brass turrets, with carbon steel cutting wheels.
- Rotate turret to move new cutting wheel into position.

**REPLACEMENT PARTS**



"A" Type Handle

**ST070 "A" Type Handle Complete (Fits all tile cutters)**

- Insert and spring automatically keeps the handle adjusted to the bar
- Unique spring tension provides automatic adjustment for straight cuts.

**ST072 Tile Protectors (1 Pair)**





# The Best Carbide Tungsten Tile Nippers!



## SUPERIOR 8" CARBIDE TUNGSTEN TILE NIPPERS

MADE IN USA

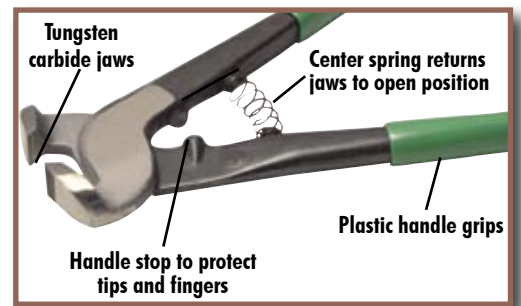

### ST021 #40 Carbide Nippers W/1/2" Offset Jaws

- Carbide tipped jaws
- 1/2" biting surface area
- Reopening spring action
- Handle stop for tip and finger protection
- **Both cutting edges straight**



Cuts all tile & porcelain



### ST023 #85C1 Carbide Nippers W/5/8" Centered Jaws

- Carbide tipped jaws
- 5/8" biting surface area
- Reopening spring action
- Handle stop for tip and finger protection
- Both jaws convex for more accurate
- **Cutting of glass, glass mosaic and porcelain tile**



Cuts glass, mosaic & porcelain tile

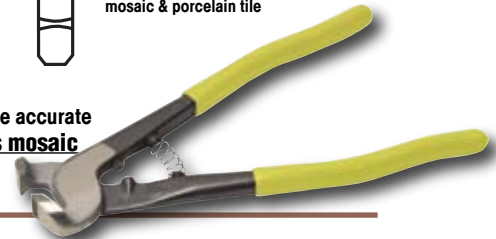

### ST020 #80 Carbide Nippers W/5/8" Offset Jaws

- Carbide tipped jaws
- 5/8" biting surface area
- Reopening spring action
- Handle stop for tip and finger protection
- **Both cutting edges straight**



Cuts all tile & porcelain



### ST024 #Quarry Carbide Nippers W/5/8" Offset Jaws

- Carbide tipped jaws
- 5/8" biting surface area
- Reopening spring action
- Handle stop for tip and finger protection
- **3/8" Opening for cutting thicker tile**



Cuts thicker man-made or quarry tiles including porcelain

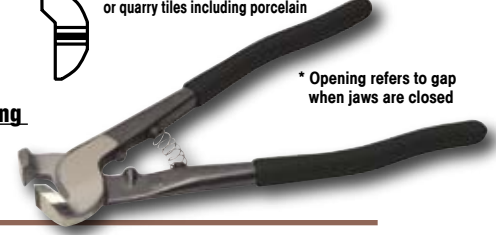

\* Opening refers to gap when jaws are closed

### ST022 #85C Carbide Nippers W/5/8" Centered Jaws

- Carbide tipped jaws
- 5/8" biting surface area
- Reopening spring action
- Handle stop for tip and finger protection
- **One jaw convex for easy bite action**



Cuts all tile & porcelain



### ST025 #Thin Tile Carbide Nippers W/5/8" Offset Jaws

- Carbide tipped jaws
- 5/8" biting surface area
- Reopening spring action
- Handle stop for tip and finger protection
- **1/8" Opening for cutting thin tile\***
- **Both cutting edges straight**



Cuts wall (thin) tile



\* Opening refers to gap when jaws are closed



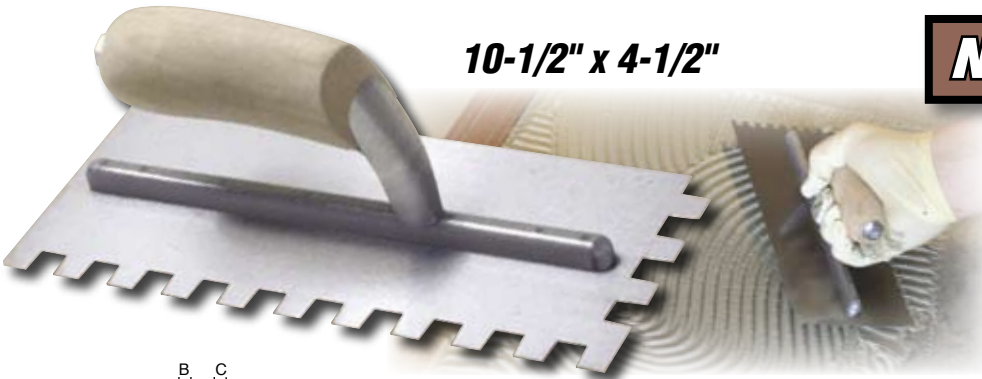

# NOTCH TROWELS

10-1/2" x 4-1/2"

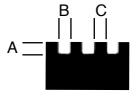

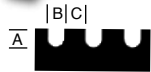
 Pattern is used for wall, carpet, and vinyl tile.  
**No. ST168** A=1/16", B=1/16", C=1/16"

 Pattern is used for wall, carpet, and vinyl tile.  
**No. ST383** A=1/8", B=1/8", C=3/32"

 Pattern is used for floor and wall tile installed with thin set mortar.  
**No. ST169** A=1/4", B=1/4", C=1/4"

 Pattern is used for small floor, wall, carpet tile.  
**No. ST384** A=3/16", B=1/8", C=1/8"

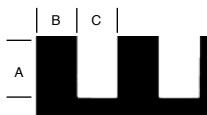
 Pattern is used for large floor, quarry tile.  
**No. ST166** A=3/8", B=1/4", C=1/4"

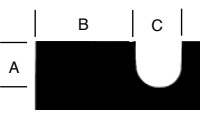
 Pattern is used for floor tile.  
**No. ST382** A=1/4", B=1/4", C=1/4"

 Pattern is used for large floor, quarry tile.  
**No. ST164** A=1/2", B=1/2", C=1/2"

 Pattern is used for floor and wall tile.  
**No. ST385** A=3/8", B=1/4", C=1/4"

 Pattern is used for wall, carpet, and vinyl tile.  
**No. ST386** A=1/32", B=1/32", C=1/8"

 Pattern is used for wall, carpet tile.  
**No. ST387** A=3/32", B=3/32", C=3/32"

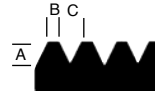
 Pattern is used for wall, cork tile and carpet tile.  
**No. ST380** A=1/8", B=1/16", C=1/8"

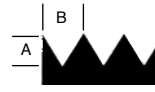
 Pattern is used for floor, wall, and metal tile.  
**No. ST167** A=3/16", B=1/4"

 Pattern is used for small floor, wall, mosaic and carpet tile.  
**No. ST165** A=3/16", B=5/32"

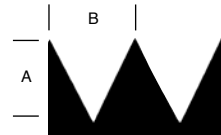
 Pattern is used for large floor, quarry tile.  
**No. ST381** A=1/2", B=1/2"

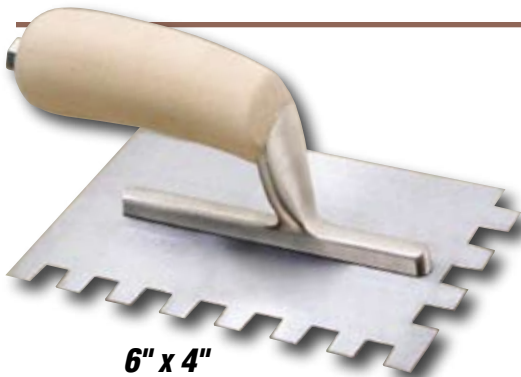

 Pattern is used for floor, wall, mosaic and carpet tile.  
**No. ST390** A=3/16", B=5/32"

 Pattern is used for floor, metal and wall tile.  
**No. ST392** A=3/16", B=1/4"

 Pattern is used for wall, carpet, vinyl and pool tile  
**No. ST393** A=1/16", B=1/16", C=1/16"

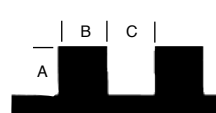
 Pattern is used for floor and wall ceramic tile installed with thin set mortar.  
**No. ST394** A=1/4", B=1/4", C=1/4"

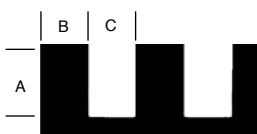
 Pattern is used for large floor, quarry tile and ceramic tile.  
**No. ST391** A=3/8", B=1/4", C=1/4"

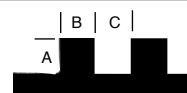
 Pattern is used for small ceramic, metal, wall and mosaic tile  
**No. ST395** A=3/16", B=3/16", C=3/16"

## Notch Trowels

Order in cartons of (6) each.

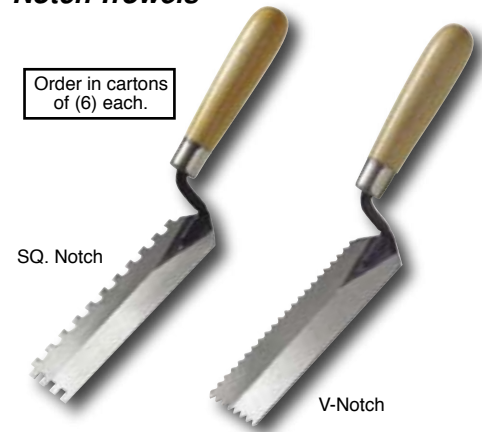

Easy to use notch trowels. Great for enclosed or small areas. Comes with comfortable wood handle.

No.	Size
ST350*	1/4"x1/4" SQ. Notch
ST351*	1/4"x3/16" V-Notch



# Mud Master Level

Get that perfect 1/4" slope for floor drains!

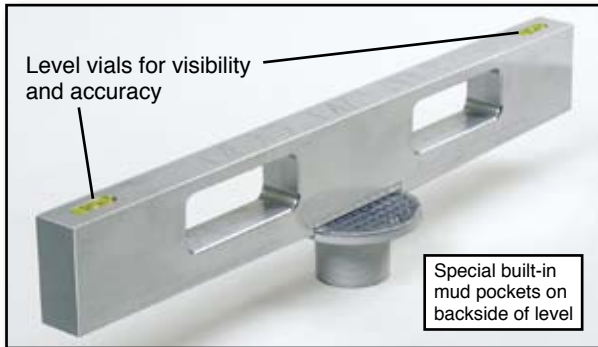

Get that perfect 1/4" slope for floor drains.

Designed by a tile setter to save labor and time in preparing mud floors for tiling.

Connect level to floor drain and rotate around drain. Special built in pockets collect excess mud from the floor. Second pass of level will give you a smooth, even sweep to the drain, no humps or dips.

2 level vials inserted on top of level for easy visibility and accuracy.

No.	Sizes	Actual Size
ST396	24" Level	23.5"
ST397	36" Level	35.5"
ST398	48" Level	47.5"

US Patent #6,732,441B2

# TILE BRIDGE

Revolutionary NEW Tile Support System!



Tile Bridge

**New Tile Support System** for setting tile and marble around fireplaces. Eliminates need for wood braces to hold tile in place.

**One step installation...saves time and money.**

- Made of high strength lightweight aluminum and galvanized steel
- Tile Bridge legs extends to 41"
- Easy to adjust telescoping legs with built-in screw locks
- Leg supports fitted with non-marring rubber caps

No. ST114 Tile Bridge

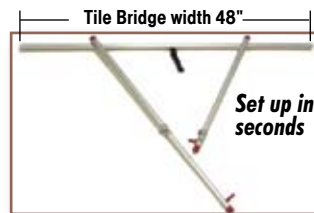

# SCREEDS



## ST294 Box (5) PC Magnesium Screed Kit

- 1" x 4" Magnesium screeds
- Sizes: 30", 2', 3', 4', 6'
- Magnesium screeds are 30% lighter than aluminum alloy screeds

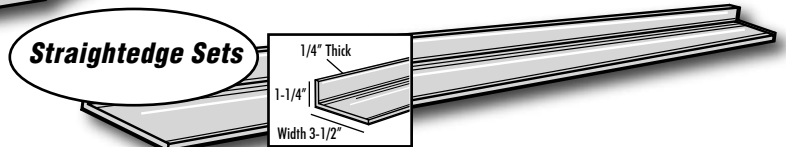

## ST295 (5) PC Aluminum Straightedge Set

- Straight edge set L shape
- Sizes: 1-1/2', 2', 3', 4-1/2' & 6'
- 3-1/2" Wide x 1-1/4" High

## ST296 (6) PC Aluminum Straightedge Set

- Straight edge set L shape
- Sizes: 1-1/2', 2', 2-1/2', 3', 4', 6'
- 3-1/2" Wide x 1-1/4" High

- CC506 (6') Magnesium Screed
- CC508 (8') Magnesium Screed
- CC510 (10') Magnesium Screed
- CC512 (12') Magnesium Screed

- 1" x 4" Magnesium screed
- Magnesium screeds are 30% lighter than aluminum alloy screeds



Pack 2 per carton.



## Tile Spacers

Constructed of tough durable plastic. Makes spacing tile a snap.

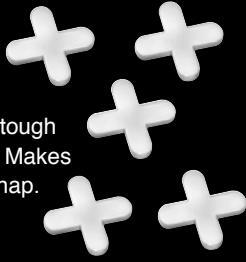

- No.  
 ST324 (1/16") Spacer.. 300 per pkg  
 ST325 (1/16") Spacer.. 3000 per pkg  
 ST326 (1/8") Spacer.. 200 per pkg  
 ST327 (1/8") Spacer.. 1600 per pkg  
 ST328 (3/16") Spacer.. 150 per pkg  
 ST329 (3/16") Spacer.. 850 per pkg  
 ST330 (1/4") Spacer.. 100 per pkg  
 ST331 (1/4") Spacer.. 550 per pkg

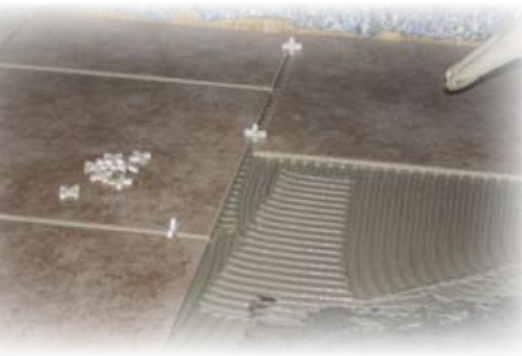

## Carbide Scoring and Cutting Tool

- All-purpose tool for scoring countertop laminates, roof, floor tiles, WonderBoard, Durock, etc.
- Unique design offers three tungsten carbide blades
- Rubber handle cover assures a firm grip
- Length 7-1/2"

No.  
TL137



## Tile Pliers/Nipper

Made of forged tool steel with 5/8" wide offset jaws. Carbide tipped edges assures easy and accurate cutting of tile every time. Rubber coated handles for comfortable grip. Cuts wall tile, thin vitreous, and quarry tile.

No.  
HC210\* 8" length.



See Pages 58-59 for more Hi-Craft™ products

## Grout Saw

- Long lasting carbide edged blade
- Durable constructed handle
- The preferred tool among tile professionals
- Use two blades on wide grout joints

No.  
ST147\*

ST148\* (2) Replacement blades



## Ultra Rubber Knee Pads

- Durable rubber with comfortable foam pad insert
- Adjustable replaceable straps
- Accordion style cap

No.  
WL084\* (Pair)



## Egg Beater Mixer W/30" Shaft

- 7/16" Steel hex shaft
- 30" Overall length
- Plated solid steel
- Use to mix thin set, grout & concrete products

No.  
DC716\*

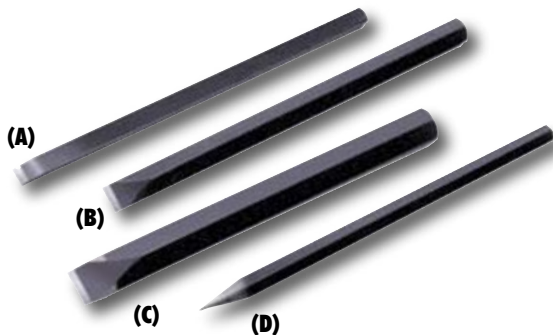

## CARBIDE TIPPED CHISELS & SCRIBE

- ST030 (A) Chisel with 1/4" wide tip  
 ST031 (B) Chisel with 3/8" wide tip  
 ST032 (C) Chisel with 1/2" wide tip  
 ST033 (D) Scribe with 1/4" shank

- Carbide tipped chisels and scribe are 6" in length
- Designed for removing chipped or broken tile
- Chisels are shaped to prevent damage to adjacent tiles
- Scribe has pencil point to ensure precision



## Grout Saw

Non-slip comfort handle. Fitted with two blades. Use one blade for thin grout joints and two blades for thicker grout joints.\*

No. HC174\*

See Pages 58-59 for more Hi-Craft™ products



## CARBIDE TIPPED TILE HAMMER

- ST045C Tile hammer...w/carbide tipped  
 ST045 Tile hammer... w/o carbide tipped

- 5/8" Polished hammer head face
- 8 oz. hammer head
- Fitted with a smooth solid wood handle

# Superior Tile Cutters® , Inc.



**Toe Grout Float**

Same construction as tile grouter's float but position of offset wood handle and its special narrow width makes it possible to work in tight corners. Fitted with wood float handle.

No. Size  
ST127 3"x12"



**Tile Grouter's Floats**

This float is very good for tile grouting but has been adapted for many uses. Pure gum rubber face is bonded to a molded rubber pad, then cemented to an aluminum backing. Fitted with wood float handle.

No. Size  
ST126 9"x4"  
ST132 12"x4"



**Super Grout Floats**

A medium weight, firm float for grouting glazed tile on walls or floors. Can also be used for grouting mosaics and plain or abrasive quarry tile. Fitted with wood float handle.

No. Size  
ST125 9-1/2"x4"



**Grout Floats**

The very best non-porous, hard synthetic rubber faced float for brown coat and grout tile. Fitted with wood float handle.

No. Size  
ST128 12"x5"  
ST360 12"x4"

**Float Pads**  
Replacement pads available for all "Floats"



**Sponges**

Medium fine pore

Polyester base sponges are durable and retain water like natural sponges. Package contains three different semi-oval sponges.

No. PL060



**Sponge Cellulose**

Durable cellulose keeps its shape. Great for cleaning as well as many construction jobs.

No. Size  
PL370 7"x4-1/2"x2"



**Turtle Back Sponge**

Durable cellulose sponge. Keeps its shape. Holds water exceptionally well, washes clean. Won't fall apart as quickly as most sponges.

No. Size  
PL600 7-1/2"x3-1/2"x2"  
PL600L\* 8"x3-1/2"x2"



**Sponge Rubber**

Pure sponge rubber. Rectangular shaped to fit your hand.

No. Size  
PL369 2"x3-1/2"x6-1/2"



**Grout Sponge**

Large water holding capacity. Soft to prevent digging or marring of grout.

No. Size  
ST135 7-1/2"x5-1/4"x2-1/4"



**Scouring Pad**

Available in non-abrasive and medium abrasive. Ideal for cleaning tile tools. Size 10"x4-3/8"x1".

No. ST133 (White) Non-abrasive  
ST134 (Blue) Medium abrasive



**Grout Scrubber Sponge**

Hydra sponge on one side to wipe off excess grout. Coarse plastic foam scrubber to remove grout haze

No. Size  
ST137 7-1/4"x5-1/8"x2-1/4"



**White Rubbing Stone**

Preferred by many tile men. Will not mark or stain. Top quality.

No. Size Grit  
ST281 8"x2"x1" 60  
ST282 8"x2"x1" 80



**Tile Setter's Rub Bricks**

Smooth out and dress down tile, marble, granite or concrete with these high quality 6"x2"x1" silicon carbide rub bricks.

No.	Grit	No.	Grit
ST370	46 grit	ST373	120 grit
ST371	60 grit	ST374	150 grit
ST372	80 grit		



**Grout Float**

Long wearing, lightweight float with non marring plastic handle. Dense 1/2" float face ideal for walls and floors.

No. Size  
ST362\* 10"x3-3/4"



## Carpet Power Stretcher

Comes complete with power head, 4 extension tubes in a tough, durable heavy-duty plastic case.



Stretcher  
adjusts from  
3' to 22'

Drive head has adjustable locking head for various lengths of stretching. Stretcher adjusts from 3' to 22'. Adjustment knob on head allows easy adjustment of power pins for various carpet thicknesses. The driving head has an adjustment for partial carpet stretches. Equipped with 4 standard size extension tubes, interchangeable with other popular models.

No.	Weight
FC502	58 lbs.

## Carpet Kit

Includes the following tools:

- (1) WL050 canvas tool bag
- (1) FC500 knee kicker
- (1) FC501 heat iron
- (1) FC510 stair tool
- (1) FC509 carpet clamp
- (1) FC504 carpet knife
- (1) roll FC530 heat seaming tape.

No.	Weight
FC540	



Great  
Starter Kit

## Adjustable Knee Kicker

Adjustable kicker has a steel telescoping mechanism, with 4 adjustments for length, from 19" closed to 24". Wide head grips carpets with (3) replaceable nap grippers, and 16 long adjustable hardened-steel pins. Nine depth position settings of head to conform to all carpet thicknesses. Foam-filled square bumper for comfort.

No.	Weight
FC500	3-1/2 lbs.



## Carpet Clamp

Makes pulling carpet effortless. Big grip permits two-handed use. Eliminates aching fingers and wrists by providing greater leverage. Use either on carpet or vinyl.

No.	Weight
FC509	2 lbs.



## Wide Stair Tool

Constructed of tough, durable, alloy steel to withstand hammering. The blade is ground to a perfect taper so as not to cut the carpet. Nickel plating will not rust.

No.	Size
FC510*	3-1/2"x8"



## Vinyl Roller

Constructed of solid steel. Rollers have smooth surfaces, and rounded corners to protect flooring materials from indentations. Each roller section "floats" independently and automatically compensates for subfloor irregularities. Handle yoke detaches for easy carrying and storage.

Diameter 5-1/4",  
width 16", Height 39".

No.	Weight
FC511	100 lbs.



## Electric Carpet Stapler

Powerful 11 amp. tool drives staples into hardwoods. Jamb-proof magazine holds 100 staples. Features a built-in trigger-lock for safety. The stapler height fits under step-raisers for easy stapling and features a special designed pointed tip.

No.	Stapler Gun
FC535	
FC536	Staples - 9/16" length divergent points with 3/16" crown. Packed 5,000 per box.



## Tile Hole Saw

Tungsten carbide-tipped hole saw cuts clean holes fast and easy. The tungsten carbide edges cut a 1-3/8" diameter hole.

Works well on both ceramic and quarry tile. Ideal for faucet and shower head pipes. Fits on electric drill.

No.	TL140
-----	-------



## Heat Iron

Low profile tool glides easily under carpets and permits the seams to be joined on the iron, while the adhesive is still hot. "U" shaped handle provides strength and is tapered to slide easily by the seam edges. Heat settings are adjustable from 250 degrees to 350 degrees, for fast seaming. Built-in heat shield protects sensitive pile fibers and synthetic backings.

No.	Weight
FC501	3-1/2 lbs.



## Heat Seaming Tape

A professional seam every time. Ideal for both commercial and residential use. This special heat seaming iron melts the glue providing a strong durable adhesion to the carpet.

No.	Length	Weight
FC530	66' Roll	2 lbs.





### Vinyl Tile Cutter

A proven tile cutter for the professional or do-it-yourselfer. So accurate and easy to operate, the user will save up to 30% on labor time. The 12-3/4" wide blade cuts 9"x9" tile diagonally or 12"x12" tile straight. Designed to cut all resilient floor tiles. Comes with tile guide for repeat cuts.

No. Weight  
FC512 17 lbs.



### Multi-Undercut Saw

Saw cuts along walls, door jambs, toe spaces and inside corners. Height adjusts from flush to 1" above the floor. Comes with 36 tooth carbide blade made specifically for Multi-Undercut Saw. Carrying case included. 110 volt. Weight 11 lbs.

No.  
FC527 Multi-Undercut Saw  
FC528 Replacement carbide blade  
(use only with FC527 Multi-Undercut Saw)



### Heavy-Duty Scraper

Large metal handle is weighted to produce inertia, for easier scraping. Heavy-duty blade carrier has (3) tightening screws. 15" hammer-end handle ideal for rubber mallet use. Includes (1) 5" blade

No.  
FC520 Heavy Duty Scraper  
FC521 (10) 5" Replacement blades



### Deluxe Carpet Trimmer

This carpet trimmer has a four-position adjustable throat to accommodate varying pile height and density. Easy-loading blade holders and stainless steel angled wall runners eliminate marking. Vinyl-coated ratchet-mounted handle pivots to permit trimming under toe spaces. Comes with 5 blades.

No. Weight  
FC524 Carpet Trimmer 1-1/2 lbs.  
FC525 (10) Repl. blades



### Deluxe Carpet Knife

Knife is made of cast aluminum, with a bright polished surface. Rear-loading blade storage for quick access to extra blades. Includes (5) blades.

No. Weight  
FC504 Carpet Knife 6 oz.  
FC505 (100) Repl. blades (slotted)



**NEW DESIGN!**

### Door Jamb Super Saw

Powerful 13 amp., 110V motor. Saw allows undercutting of doors, door jambs, inside corners or walls. Blade height adjustable from flush to maximum 1-1/4". Cuts doors 1-3/4" without removal. Complete with (1) combination and (1) masonry blade, detailed instructions and durable plastic carrying case. Weight 14 lbs.

No.  
FC537 Door Jamb Saw  
FC516 Masonry blade  
FC538 Carbide tip blade



### Cushion Back Cutter

Designed especially for trimming and cutting super dense 5/64" gauge foam or sponge-back carpets. Double 30 degree angle blades cut either side of the row close and clean to help produce better seams. Special designed front guide and beveled bottom makes it easier to stay in a row. Includes (5) blades.

No. Weight  
FC526 Cushion Back Cutter 8 oz.  
FC505 (100) Repl. blades (slotted)

### Big Floor Scraper

Features an 8" wide heavy-duty replacement blade, and a twist-lock adjustable telescoping handle. Handle length adjusts from 39" to 59". The perfect tool for floor preparation.

No. Weight  
FC506 Big Floor Scraper 4 lbs.  
FC507 (3) 8" Replacement blades

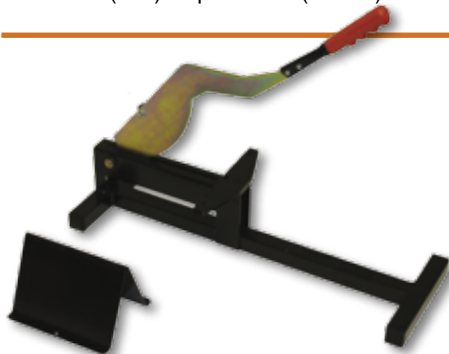
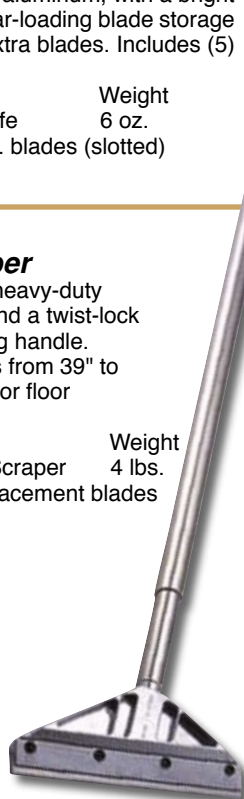

### Laminate Cutter

Long curved cutting blade breaks laminated planks with pressure at point of contact. Cuts square ends up to 8" wide and .40" thick. Eliminates dust and sawing. Plank support included.

No.  
FC519

## Canvas Tool Bags



### Deluxe Canvas Tool Bags with leather bottom

Our finest quality heavy-duty canvas and leather reinforced bags for masons, mechanics, and linemen. Made with 12 gauge steel hinged frame and heavy #10 canvas, this bag is made for heavy work and long-lasting wear. Leather reinforcing on the bottom and 3" up on the sides. Inside 9"x11" pocket. Waterproof bottom board.

No.	Size
WL180	14"x18"
WL200	14"x20"
WL220	14"x22"



### Standard Canvas Tool Bags

An expertly made bag, deep and roomy, built around a 12 gauge steel hinged frame. Leather handles, buckles and canvas are riveted into the frame. Lock-stitched sewing assures long life. A masonite bottom board provides waterproofing. 9"x11" inside pocket.

No.	Size
WL018	14"x18"
WL020	14"x20"
WL024	14"x24"



### Economy

### Economy Tool Bag

Economical 20" wide canvas tool bag. A lightweight but sturdy all-purpose bag. Two steel dowels are sewn into casings and a masonite bottom board holds the bag in shape.

No.	Size
WL050	13"x20"x12"



### Pro Canvas Bag

24" large capacity heavy-duty canvas bag. Soft durable canvas, leather handles and locked stitched sewing assures long life. Exterior pockets for extra storage.

No.	Size
WL025	14"x24"

### Drywall Tool Pouch

The top of the line tool pouch for the drywall hanger. A professional, handcrafted compact kit with gusseted sides that gives a permanent box shape. Two cutter knife sheaths, pencil pocket, extra tape holder, pocket for sharpening stone and tapered slot for saw. Reinforced bottom makes this bag a top seller.

No.	
WL078	Right side (shown in photo)
WL079	Left side



### Drywall Tool Pouch

The best heavy leather drywall tool pouch on the market. Steel hammer loop. Has six other tool loops and holders. Securely made with total rivet construction for heavy-duty use.

No.
WL077



### Flat Type Drywall Tool Pouch

A flat 8-compartment drywall tool pouch features 4 flared front pockets that hold pencils, knives, etc. A strong leather clip allows for any size tape to be carried. Also featured is a sharpening stone pocket and circle cutter pockets with a steel loop hammer holder.

No.
WL096



### Double Leather Work Belt

Double leather work belt. Belt adjusts from 30" to 54". Reinforced back with double roller buckles. Quality stitching with solid rivets.

No.
WL049

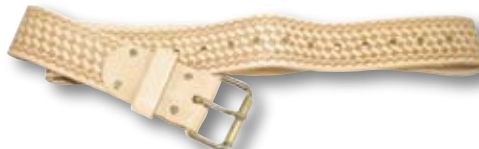

### Leather Work Belt

General purpose work belt for nail bags and tool pouches. Fits 29" to 46" waist.

No.	Size
WL099	2" Deluxe
WL098	1-3/4" Economy



### Web Pistol Belt

Strong polypropylene web belt adjusts from 32" to 46" with hook-in fastener.

No.
WL052

**8 Pocket W/Double Hammer Loop**

Large capacity pockets with extra rivets for long life. Double hammer loop for right or left use of pouch.  
No. WL518



**Deluxe 10 Pocket Tool Apron**

Double tool pouch with 2 hammer loops and 10 pockets. Soft leather with 2" leather belt that adjusts to 54".  
No. WL030



**Multi-Purpose 8 Pocket Pouch**

Pouch has 3 utility pockets on inside of main pouch for small tools. Great for all construction and repair jobs. Reinforced outer pouch and riveted for extra strength.  
No. WL514



**Double Pouch Style 11-Pocket Moccasin Leather Carpenters Apron**

Our top of the line leather apron made for the professional craftsman. Finest quality supple moccasin leather.  
• Large pockets nylon double stitched • Stress points rivet reinforced.  
• 2 large and 2 medium size nail pockets • Adjustable 2-1/4" polypropylene web belt  
• 6 small tool pockets • 25' tape pocket • 2 strap leather hammer loops  
• 1-1/2" combination square holder  
No. WL028



**5 Pocket Nail & Tool Bag**

Just the right size and style for many jobs. tough leather, flared pockets for easy access.  
No. WL512



**Promotional 10-Pocket Split Leather Carpenters Apron**

This outstanding value has top of the line features at a promotional price.  
• Strong suede split leather  
• 2 large and 2 medium size nail pockets • 6 small tool pockets • 25' tape pocket  
• 2 strap leather hammer loops • Adjustable 2" polypropylene web belt  
No. WL029



**1-Pocket Nail Bag**

Popular priced nail bag made of soft but heavy chrome split leather. Lockstitching and riveting make this bag extremely sturdy. Bag has a 10"x11" bellows flared pocket and wide tunnel belt loop.  
No. WL046

**2-Pocket Nail Bag**

Same as above, but with one 5"x8" flared top pocket.  
No. WL042

**Deluxe 9-Pocket Nail Bag**

This deluxe 9-pocket drywall nail bag is made of the finest moccasin leather. A favorite of the drywall installer.  
No. WL520



**Deluxe 5-Pocket Nail Bag**

Deluxe 5-pocket nail bag has 10" flared pocket, 4"x6" pouched pocket with 2 nail slots and hammer holder. All pockets are fully bound for long wear and lock stitched with strong nylon thread. Rivet reinforced. Strong but supple leather makes this bag one of our best.  
No. WL044 Left side hammer loop  
WL045 Right side hammer loop



**Steel Hammer Loop**

Steel loop hammer holder made for easy insertion. Top grain leather is riveted for long wear. Fits easily on belt.  
No. WL095

**Hammer & Hatchet Holder**

2"x2" steel loop. Loop swings freely to make carrying hammer easier. Heavy leather.  
No. WL403

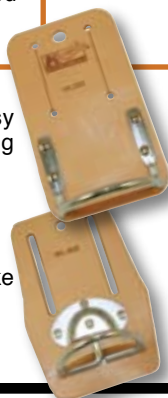

**Hammer Holder with Sheath**

Ideal for snips and knife with hammer loop.  
No. WL093



**3-Pocket Nail Bag**

This fine quality, genuine cowhide nail bag has all the superb features of the 2-pocket, but has a third pocket to hold even more tools and nails.  
No. WL516



# Apprentice Kits

## Concrete



**Concrete Apprentice Kit**  
**#CC900AK**

Qty	Part No.	Description
1	CF217PF	14"x4" Trowel w/ Proform® Hdle
1	CF285PF	16"x4" Rnd Frnt Sqr Bck Trowel w/ Proform® Hdle
1	CF016PF	16"x3-1/2" Mag Float w/ Proform® Hdle
1	CF256	15"x3-1/2" Beveled Redwood Float
1	CF164PF	6"x3-1/2" Edgr, 3/8"R, 1/2" Lip w/ Proform® Hdle
1	CF173PF	6"x4" Edgr, 3/8"R, 1/2" Lip w/ Proform® Hdle
1	CF138PF	6"x3-1/2" Edgr, 3/8"R, 1/2" Lip w/ Proform® Hdle
1	CF118PF	6"x3" Groover, 1/2" Bit w/ Proform® Hdle
1	BL526	Utility Brush
1	PL374	8"x4"x5/8" Coarse Rubber Float
1	GG432	5"x2" Margin Trowel
1	SL4848	48" Cast Aluminum Level
1	WL080	Poly Knee Pads
1	GG284	25"x1" Tape
1	WL050	20" Canvas Tool Bag

## Masonry



**Masonry Apprentice Kit**  
**#BC901AK**

Qty	Part No.	Description
1	RO116-10-1/2	10-1/2" Rose Trwl Narrow London
1	RO5121-3/8x1/2	3/8"x1/2" Rose Convex Jointer
1	RO5121-5/8x3/4	5/8"x3/4" Rose Convex Jointer
1	RO3131-24	Rose Brick Hammer 24oz
1	BL167	Wood Spacing Rule
1	BL210	Skate Joint Raker
1	BC334T	250' Tube Flo Orng Braided Line
1	BL350	Wooden Line Block Pair
1	BL234	4" Brick Set
1	GG432	5"x2" Margin Trowel
1	SL12AB48	48" Brass Bound Mahog Level
1	BL526	Utility Brush
1	WL050	20" Canvas Tool Bag

## Plaster



**Plaster Apprentice Kit**  
**#PL700AK**

Qty	Part No.	Description
1	PL263PF	13"x13" Magnesium Hawk w/ Proform® Hdle
1	PL453PF	11-1/2"x4-1/2" Gold S.S. Trowel w/ Proform® Hdle
1	PL101	7"x1-5/8" S.S. Bound Brush
1	PL208	8" Plasterer's Scarfier
1	PL194	Leaf & Square Ornamental Tool
1	BL526	Utility Brush
1	PL372	8"x4"x5/8" Coarse Rubber Float
1	GG284	25"x1" Tape
1	GG432	5"x2" Margin Trowel
1	SL2424	24" Cast Aluminum Level
1	WL050	20" Canvas Tool Bag

## Drywall



**Drywall Apprentice Kit**  
**#DC902AK**

Qty	Part No.	Description
1	DW533	6" Brass Hammer End Knife
1	DW810	10" Wide Hndle Taping Knife
1	DW722	12" EZ-Grip Mud Pan
1	DW441S	Hand Sander
1	DC317	Drywall Pole Sander
1	DW243	Utility Drywall Saw
1	DW811	15" Drywall Saw
1	DW520	Inside Corner Tool
1	DW254	18 oz Drywall Hammer
1	WL077	Drywall Tool Pouch
1	GG284	25"x1" Tape
1	SL671	48" T-Square
1	WL050	20" Tool Bag

## Tile



**Tile Apprentice Kit**  
**#ST100AK**

Qty	Part No.	Description
1	ST005	Large Tile Cutter 15"x15"
1	ST020	#80 Carbide Nipper 5/8" Offset
1	ST031	Carbide Chisel 3/8" Tip
1	ST126	Grout Float 9"x4"
1	ST135	Grout Sponge
1	ST137	Grout Scrubber Sponge
1	SLRV324	24" Aluminum Level - 3 vial
1	ST169	Notch Trowel 1/4"x1/4"x1/4" Square
1	ST371	Tile Setters Rub Brick 60 Grit
1	WL080	Poly Knee Pads
1	WL050	20" Canvas Tool Bag



Developed in cooperation with government trade schools, leading unions and trade associations, these kits put newcomers "in business" with all the professional starter tools they need.

# Concrete Name Stamp

**The perfect way to mark concrete for permanent identification. Made from high grade bronze. Stamp is 5"x9" oval with flat ends.**



Shipping Wt. 5 lbs.



Stamp has 16 letter and spaces on the top line for your company name, 16 letter and spaces across the middle for your address and 16 letter and spaces across the bottom for your location. Available characters are the letters A through Z; numbers 0 through 9; and specific symbols (comma, period, dash, apostrophe, hyphen, colon, semi-colon and the ampersand). Logos are not adaptable to this stamp.

Fill out form below exactly to your preference, leaving a space between words, left flush or center the characters. Please mark out the date area if you do not require the date insert

**QTY.**

- \_\_\_\_\_ Name Stamp  
W/2008 Date Insert (CF400)
- \_\_\_\_\_ Name Stamp  
W/O Date Insert (CF400-01)
- \_\_\_\_\_ 2008 Date Insert /only  
(CF401-08)
- \_\_\_\_\_ 2009 Date Insert /only  
(CF401-09)

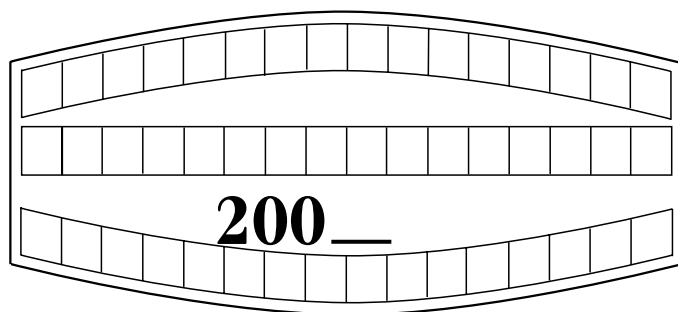

Allow approximately  
3-4 weeks for delivery

NAME \_\_\_\_\_

ADDRESS \_\_\_\_\_

CITY \_\_\_\_\_ STATE \_\_\_\_\_ ZIP \_\_\_\_\_

PHONE ( ) _____
FAX ( ) _____

**Registered Trademarks of Kraft Tool Co.®**

EZY-Tilt®, EZY-Tilt® II, Kraft Tool Co.®, Kumalong®, ProForm®, Super-Pro®, Bronco™, EZ-Kneeler™, Knucklehead®, Knucklehead® II, W.Rose™, Step-Saver®, Solid Set Vials®, Superior Tile Cutter® Inc., Sands Levels Tell the Truth®, Sands Level & Tool Co.®, Inc., Rapid Square®, Roto-Vial®, Gold Standard™, EZY Tote™, Orbiter™, Right Angle Placer™, Mag 150™, Hi-Craft™, Masonry Barbell Joiner®, EZ-Shooter™, Elite Series Five Star Trowel™, Buckeye Straightedge™, Buckaroo Straightedge™, Redwood Striker™

**Registered Patents of Kraft Tool Co.®**

ProForm® Trowel Handle, US Patent #6,247,204 B1  
 ProForm® Float Handle, US Patent #6,473,939 B1  
 US Patent #6,821,468 B2, W.Rose™ ProForm® Trowel Handle #D508638, Super-Pro® Gun Cylinder, US Patent #5,415,351  
 Knucklehead™ II, Bull Float Bracket, US Patent #4,335,485  
 Step-Saver® Groovers, US Patent #D-333,600, Step-Saver® Edgers US Patent #5,098,278, Beveler Floats US Patent #6,183,237

**Ask for Special Forms to order:**

Imprinted Line Blocks, Imprinted Line Twigs

## COMPANY SHIRTS & CAPS



**KTCSHIRT** Kraft Tool Co.® Shirts  
 Colors...Gray & Blue  
 Sizes...Large & Extra Large



**KTCSHIRTROSE** W. Rose™ Shirts  
 Colors...White & Black  
 Sizes...Large & Extra Large

**KTCCAP**  
 Kraft Tool Co.® Ball Cap  
 (specify blue or beige)





# MASON'S LINE BLOCKS

*Imprint Your Name Here!*

- Three line maximum imprint
  - Imprint area 3/4" high and 2-1/4" wide
- IMPRINTED COLOR: BLACK OR RED**

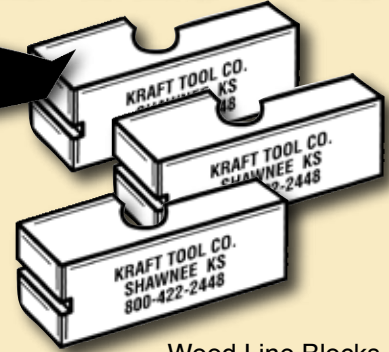

Wood Line Blocks  
1-1/4" x 1-1/4" x 3"

**PLEASE PRINT CLEARLY (No Logos)**

18 characters or spaces available per line

ACTUAL SIZE PRINT

IMPRINT COLOR:  BLACK  RED



# MASON'S LINE TWIGS

*Imprint Your Name Here!*

- Two line maximum imprint
  - Imprint area 3/8" high and 2" wide
- IMPRINTED COLOR: BLACK OR RED**



**Style A**

**PLEASE PRINT CLEARLY (No Logos)**

Choose a Style and Color

26 characters or spaces available per line

ACTUAL SIZE PRINT

Style A. (2nd line is optional)

**Style B**

22 characters or spaces available per line

--	--	--	--	--	--	--	--	--	--	--	--	--	--	--	--	--	--	--	--	--	--	--

ACTUAL SIZE PRINT

**Style C**

17 characters or spaces available per line

--	--	--	--	--	--	--	--	--	--	--	--	--	--	--	--	--

ACTUAL SIZE PRINT

IMPRINT COLOR:  BLACK  RED



<b>A</b>	<b>Brick Tools.....72-94</b>	Caulking Trowels . . . . .	59, 79	Shears & Snips . . . . .	99
A.D.A.Mat . . . . .	Brick & Stone Marker . . . . .	Chalk & Chalk Line Box . . . . .	86	Tile . . . . .	113-114
Acid Brushes . . . . .	Brick Cart . . . . .	Chamfer Tools . . . . .	38	Vinyl Tile . . . . .	121
Adapters . . . . .	Brick Splitter . . . . .	Channel Float . . . . .	15	Cutting Wheel Carbide . . . . .	114
Ammo Chalk Box . . . . .	Brick Tongs . . . . .	Chippers, Stone . . . . .	89		
Angle Plane . . . . .	Bricklayers Set . . . . .	<b>Chisels</b>		<b>D</b>	
Apprentice Kits . . . . .	Bronco Dbl Act Brkt . . . . .	Bricklayers . . . . .	89	<b>Darbies</b>	
Aprons . . . . .	Brooms . . . . .	Concrete . . . . .	89	Aussie Darby/Screed . . . . .	23
Asphalt Rake . . . . .	Broom Cover/Protector . . . . .	Stone . . . . .	89	Bull Float & Darby Mini . . . . .	22
Asphalt Squeegee . . . . .	<b>Brushes</b>	Tile . . . . .	118	Laminated . . . . .	22
Asphalt Crack Hoe . . . . .	Acid . . . . .	Chutes, Concrete . . . . .	33	Magnesium . . . . .	22-23
Asphalt Lute . . . . .	Blister . . . . .	Chute Tool . . . . .	33	Mahogany . . . . .	23
	Bucket . . . . .	Circle Cutter, Drywall . . . . .	111	Plaster-Serrated . . . . .	97
<b>B</b>	Concrete . . . . .	Clevis Handles . . . . .	42	Slicker . . . . .	97
Bags, Nail & Tool . . . . .	Curb . . . . .	Clinch On Tools . . . . .	112	Wedge Shape . . . . .	97
Bar, Rocker Head Pry . . . . .	Dutch . . . . .	Clips, Brick & Block . . . . .	94	Deco Tools . . . . .	51
Bar, Heavy Duty Pry . . . . .	Handles . . . . .	Color Hardener . . . . .	55	Dirt Tamper . . . . .	54
Belts . . . . .	Masonry . . . . .	Color Release . . . . .	55	Dolly, Drywall . . . . .	112
Bender, Radius . . . . .	Plaster/Nylon . . . . .	Compressors . . . . .	102-103	Driveway Approach Tools . . . . .	49
<b>Blades</b>	Stucco Dash . . . . .	Concrete Displ/Spreader . . . . .	24-25	Drywall Carriers & Lifters . . . . .	112
Troweler . . . . .	Texture, Drywall . . . . .	Concrete Placer . . . . .	24-26	Drywall Corner Tools . . . . .	108
Utility Knife . . . . .	Utility . . . . .	Concrete Finish Broom . . . . .	34-35	Drywall Mud Holders . . . . .	104
Floor Scraper . . . . .	Wire . . . . .	Concrete Text Broom . . . . .	26	Drywall Saw . . . . .	112
Blocks, Line Corner . . . . .	Buckaroo™ Straightedge . . . . .	<b>Concrete Tools . . . . . 4-57</b>		Drywall Tape Holder . . . . .	110
Bolt Cutters . . . . .	Bucket Scoop . . . . .	Converter Handle Bracket . . . . .	38	Drywall Taper . . . . .	107
Boots . . . . .	Buckets . . . . .	Corner Blocks . . . . .	76	Drywall Taping Knives . . . . .	106-108
<b>Brackets</b>	Buckeye™ Straightedge . . . . .	Corner Roller . . . . .	101	<b>Drywall Tools . . . . . 101-112</b>	
Bronco™ Tilt . . . . .	Bull Floats . . . . .	Cross Joint Trowel . . . . .	79	Drywall T-Square . . . . .	69, 111
Broom . . . . .	Bull Float/Broom Combo . . . . .	<b>Curb Tools . . . . . 49</b>		Duck Bill Trowel . . . . .	78
EZY-Tilt® . . . . .	Bull Float Converter Plate . . . . .	Curing Compound Sprayer . . . . .	55		
Float . . . . .	Bull Nose Tools, Drywall . . . . .	<b>Cutter</b>		<b>E</b>	
Fresno . . . . .	<b>C</b>	Brick Splitter . . . . .	93	E-Jointers . . . . .	81
Knucklehead® II . . . . .	Callous Preventer . . . . .	Carpet Knife . . . . .	121	<b>Edgers</b>	
Orbiter™ . . . . .	Canvas Tool Bags . . . . .	Carpet Trimmer . . . . .	121	All Angle . . . . .	42
Twist Tilt . . . . .	<b>Carpet . . . . . 120-121</b>	Cushion Back . . . . .	121	Blue Steel . . . . .	46-47
Trowel . . . . .		Scoring & Cutting Tool . . . . .	118	Bronze . . . . .	37



Carpet . . . . .	48
Chamfer . . . . .	38
Curved End . . . . .	45
Sidewalk . . . . .	44-47
Stainless Steel . . . . .	43-44
<b>Edgers, Concrete . . . . .</b>	<b>44</b>
Edger/Groover . . . . .	43
<b>EIFS Tools . . . . .</b>	<b>100</b>
EIFS Corner Tools . . . . .	100
EIFS Finishing Trowel . . . . .	100
EIFS Notched Trowels . . . . .	100
EIFS Sanding Rasps . . . . .	100
Elite Series™ Trowels . . . . .	4-5
Engineer Rules . . . . .	87
Extension Handles . . . . .	12-13, 35
EZY Deck Floor Sprayer . . . . .	103
EZ-Grip Mud Pan . . . . .	104
EZ Kneeler™ . . . . .	53
EZY-Tilt® Brkt. . . . .	11
EZ Winder . . . . .	84
<b>F</b>	
Featheredge Magnesium . . . . .	97
Finger Tape . . . . .	82
Flatwire Texture Broom . . . . .	26
<b>Floats</b>	
Angle . . . . .	98
Beveler . . . . .	20
Blue Steel . . . . .	15
Bodark . . . . .	20
Bull . . . . .	14
Channel . . . . .	15
Grout . . . . .	119
Hand . . . . .	18-20
Laminated . . . . .	15, 20
Magnesium . . . . .	18-20
Mahogany . . . . .	58
Molded Sponge Rubber . . . . .	95
Redwood . . . . .	20, 70
Rubber . . . . .	95
Teakwood . . . . .	20
Float Handles . . . . .	18-19
Float Hook . . . . .	20
Float Pans . . . . .	32
Floor Scrapers . . . . .	26
Foot Lifts, Drywall . . . . .	112
<b>Fresno Trowels . . . . .</b>	<b>16</b>
Adapters . . . . .	10, 17
Brackets . . . . .	10, 17
Groover Bits . . . . .	16-17
Shotcrete . . . . .	39
Weights . . . . .	11
Funny Trowel . . . . .	10
<b>G</b>	
Gauging Trowels . . . . .	78
<b>General Contractor . . . . .</b>	<b>122-123</b>
Glitter . . . . .	101
Glitter Gun . . . . .	101
Gloves, Neoprene . . . . .	82
Go Devils . . . . .	95
Grinding Stone Holder . . . . .	30
Grinding Stone . . . . .	30
<b>Groovers</b>	
Airplane . . . . .	41
All Angle . . . . .	42
All Steel . . . . .	40-41
Bits . . . . .	14, 16, 41
Bronze . . . . .	36-37
Center Line Groover . . . . .	51
Dallas Bit . . . . .	38
Deep Bit . . . . .	36, 37
Iron . . . . .	38
Long Handled . . . . .	37, 38, 42
Paver Groover . . . . .	41
Power . . . . .	42
Ramp . . . . .	45
Rocker . . . . .	38
Safety . . . . .	45, 50
Seamer . . . . .	43
Stainless Steel . . . . .	42, 43, 45
Straight Arrow . . . . .	57
Ultra Hard . . . . .	38
Universal . . . . .	45
Western . . . . .	43
Wheelchair . . . . .	45
Winged . . . . .	48
Grout Bags . . . . .	82
Grout Saw . . . . .	118
Gunite Shoes . . . . .	39
Guns, Texture . . . . .	102-103
Gutter Tools . . . . .	49

**H, I****Hammers**

Brick, Rock, Masonry . . . . .	77, 88
Bush . . . . .	88
Carbide Tipped . . . . .	77, 89
Drywall . . . . .	111
Framing . . . . .	93
Magnetic Nail . . . . .	98
Mash . . . . .	88
Masons . . . . .	77, 88
Scaling . . . . .	88
Sledge . . . . .	88
Stone . . . . .	88
Tile . . . . .	118
Tooth Bush . . . . .	88
Hammer Holder Loops . . . . .	123

**Handles**

Adapters . . . . .	12-13, 35
Button . . . . .	13
Clevis . . . . .	42
Extension . . . . .	12-13, 35
Float . . . . .	18-19
Kumalong® . . . . .	25
ProForm® . . . . .	7, 18
Screed Handles . . . . .	28
Spreader . . . . .	24-25
Telescoping . . . . .	35
Threaded . . . . .	12
Trowel, Brick . . . . .	75, 78
Trowel, Hand . . . . .	7
Hawks, Alum-Mag . . . . .	96

**Hi-Craft Tools . . . . . 58-59**

Hods . . . . .	92
Hoe, Concrete . . . . .	33, 91
Hoe, Mortar . . . . .	91
Hole Punch . . . . .	109
Hose, Texture . . . . .	102-103

**J****Jointers**

Barbell Jointer . . . . .	81
Brick . . . . .	77, 80
Bullhorn . . . . .	77, 80
Concave . . . . .	77, 80
Convex . . . . .	77, 80
“E” . . . . .	81
Grapevine . . . . .	77, 80

Hubbard . . . . .	80
Plexiglass . . . . .	80
“S” . . . . .	80
“V” . . . . .	80
Variable Convex . . . . .	78
Joint Rakers . . . . .	78

**K**

Keyhold Straightedge . . . . .	28
Knee Pads/Boards . . . . .	52-53

**Knives**

Broad . . . . .	106
Carpet . . . . .	121
Drywall . . . . .	106-108
Taping . . . . .	106-108
Vinyl . . . . .	59
Wipe Down . . . . .	106-108
Knock Down Knife . . . . .	101
Kumalong® . . . . .	25

**L**

Laminate Cutter . . . . .	121
Leaf & Square . . . . .	97
Liquid Release . . . . .	55

**Levels**

Line . . . . .	66, 86
Masons . . . . .	86
Mud Master Level . . . . .	117
Sands . . . . .	60-71
Torpedo . . . . .	66, 86
Wood . . . . .	86
Lid Claw . . . . .	100
Line Block . . . . .	70, 94
Line Block, Oversize . . . . .	94
Line, Masons Nylon . . . . .	76, 84-85
Line Pins & Twigs . . . . .	94
Linestretchers . . . . .	94
Lutes, Asphalt . . . . .	27

**M, N**

Mallot Rubber . . . . .	112
Margin Trowels . . . . .	59, 79
Masher, Square Mud . . . . .	105
Masher, Round Mud . . . . .	105
Masonry Barbell Jointer . . . . .	81
Masonry Guides . . . . .	92
Masonry Guide Braces . . . . .	92



**Masonry Tools . . . 78-94****W.Rose® Tools . . . 72-77**

Mats, Texture . . . . .	55-56
Measuring Tape . . . . .	86-87
Measuring Wheel . . . . .	86
Mitre Rods . . . . .	96

**Mixers**

Egg Beater . . . . .	105, 118
Fast . . . . .	105
Jiffler . . . . .	105
Spiffy . . . . .	105
Unomixer . . . . .	105
Mortar Stand Board . . . . .	91
Mortar Board, Fiberglass . . . . .	91
Mortar Boards, Poly . . . . .	91
Mortar Boxes, Poly . . . . .	90-91
Mortar Boxes, Steel . . . . .	90-91
Mortar Hod . . . . .	92
Mortar Pans, Poly . . . . .	91
Mortar Pan, Steel . . . . .	91
Mortar Scratchers . . . . .	80
Mud Mashers . . . . .	105
Mud Pans . . . . .	104
Nail Bags . . . . .	122-123
Nail Driver, Magnetic . . . . .	98
Neptune Nylon Line . . . . .	85

**Nippers**

Tile . . . . .	115
End Cut . . . . .	99

**Nylon Line . . . 76, 84-85****O, P****Ornamental Tools . . . 97**

Panellift® . . . . .	112
Panellift® Extensions . . . . .	112
Patch Gun . . . . .	101
Patch, Drywall . . . . .	110
Pavers Straight Edge . . . . .	28-29

**Pitching Tools . . . . 89**

Placers . . . . .	24-26
Plank-Tie™ . . . . .	94

**Plaster Tools . . . . 95-99**

Plastering Trowels . . . . .	9, 96
Pliers, Ironworkers . . . . .	21
Pointing Trowels . . . . .	59, 79

**Power Troweler Blades . . 30-31**

Pry Bar . . . . .	21
-------------------	----

**Q**

Quick Change Bracket . . . . .	38
--------------------------------	----

**R**

Radius Bender . . . . .	39
Rake, Asphalt & Concrete . . . . .	27
Rake, Gauge . . . . .	39
Rake, Magnesium . . . . .	27
Rasp, Drywall . . . . .	112
Rasps, EIFS . . . . .	100
Rebar Bender . . . . .	21
Rebar Cutter/Bender . . . . .	21
Rebar Lifter Hook . . . . .	21
Redwood Striker™ . . . . .	29
Reel, Tie Wire . . . . .	21
Roll Lifter . . . . .	112
Roller Frame . . . . .	101
Roller Tamp . . . . .	54

**W.Rose® Tools . . . 72-77**

Round-It-Tool . . . . .	108
Rubber Tip F/Brick Trowel . . . . .	78
Rub Bricks, Concrete . . . . .	39
Rub Bricks, Tile . . . . .	119

**Rules**

Engineer's . . . . .	87
Folding . . . . .	87
King Size . . . . .	87
Wood, Modular & Brick . . . . .	87
Fiberglass, Mod & Brick . . . . .	87

**S**

Safety Barrier Trowel . . . . .	33
Safety Ramp Groovers . . . . .	50
Safety Roller . . . . .	54
Salt Roller . . . . .	51

**Sands Levels . . . . 60-71****Levels**

Cross Check . . . . .	66
Dial . . . . .	70
General Purpose Wood . . . . .	65
Kits . . . . .	71
Line . . . . .	66
Pocket . . . . .	66

Post Level . . . . .	66
Aluminum Box . . . . .	61
Aluminum Extruded . . . . .	60-61, 65-66
Asphalt Mahogany . . . . .	64
Brass Bound Mahogany . . . . .	62-64
Cast Aluminum . . . . .	60
Cast Alum Plumbers . . . . .	60
Door Jamb . . . . .	63
Extruded Aluminum . . . . .	60-61, 65-66
Level Cases . . . . .	64
Magnesium Extruded . . . . .	62
Magnetic Alum Extruded . . . . .	60, 65
Mahogany Carpenter . . . . .	65
Mahogany Flat Brass . . . . .	63
Mahogany I-Beam . . . . .	62-63
Mahogany SS . . . . .	64
Surface . . . . .	66
Torpedo . . . . .	66
Walnut/Maple Lam . . . . .	63

**Tools**

Carpenter Pencils . . . . .	70
Carpenter Squares . . . . .	67
Combination Squares . . . . .	69
Hawks, Prof Aluminum . . . . .	70
Meter Sticks . . . . .	68
Plumb Bobs . . . . .	69
Rapid Squares® . . . . .	71
Rules . . . . .	68
Sliding T Bevel . . . . .	71
Stair Angle Gauges . . . . .	67
Straight Edges . . . . .	68
T-Squares, Aluminum . . . . .	68-69
T-Squares, Prof Drywall . . . . .	69
Try & Mitre . . . . .	71
Wood Floats . . . . .	70
Wood Line Blocks . . . . .	70

**Sanders**

Hand . . . . .	59, 110
Pole . . . . .	59, 110

**Sandpaper**

Diecut . . . . .	110
------------------	-----

**Saw**

Door Jamb Super . . . . .	121
Drywall . . . . .	111
Grout . . . . .	118
Multi-Undercut . . . . .	121

Tile Hole . . . . .	120
Scarifier, Plaster . . . . .	98
Scrapers, Hand . . . . .	109
Scrapers, Form/Floor . . . . .	26
Screeds, Magnesium . . . . .	28
Screed Handles . . . . .	28
Sealer . . . . .	55
Sharpener, Trowel . . . . .	7
Sledrunners . . . . .	77, 80-81
Slickers, Double Blade . . . . .	80
Sliders, Knee Boards . . . . .	52

**Smith Levels & Tools . . . 86**

Snips/Sheers . . . . .	99
Sponge Floats . . . . .	95
Sponges . . . . .	95
Spray Shield . . . . .	101
Sprayer, Backpack . . . . .	55
Spreaders . . . . .	24-26
Squeegees . . . . .	39

**Stamp Tools, Decorative**

Concrete Name . . . . .	38
Deco Groover . . . . .	51
Deco Edger . . . . .	51
Dome Tool . . . . .	55
Touch-Up Rollers . . . . .	57
Utility . . . . .	33

**Step Saver® Tools . . . 40****Step Tools . . . . . 47-51**

Stirrup, Drywall . . . . .	112
Stone Splitting Wedge . . . . .	89
Straightedge . . . . .	28-29
Stud Crimper . . . . .	109

**Superior Tile Cutter . . 113-119**

Brass Turrets . . . . .	114
Carbide Scoring Wheels . . . . .	114
Chisels, Carbide Tipped . . . . .	118
Cutters . . . . .	113-114
Grout Floats . . . . .	119
Grout Saw . . . . .	118
Hammer, Carbide Tipped . . . . .	118
Mixer . . . . .	118
Mud Master Level . . . . .	117
Nippers . . . . .	115
Rub Bricks . . . . .	119
Rubbing Stones . . . . .	119
Screeds . . . . .	117
Scoring & Cutting Tool . . . . .	118



Sponges . . . . . 119  
 Tile Bridge . . . . . 117  
 Tile Spacers . . . . . 118

**T**

T-Square . . . . . 68-69, 111  
 Tamper, Concrete . . . . . 54  
 Tamper, Dirt . . . . . 54  
 Tamper, Mat . . . . . 54  
 Tape Holder . . . . . 110  
 Tape, Metal Corner . . . . . 110  
 Tapering Knives . . . . . 106-108  
**Tapes, Measuring . . . 86-87**  
 Taping Tools, Corner . . . . . 108  
 Texture Floppy Mat . . . . . 56  
**Texture Mats . . . . . 56**  
 Texture Mat ADA . . . . . 55  
 Texture Mat Chisels . . . . . 57  
 Texture Mat Hand Tool . . . . . 55  
 Texture Mat Touch-Up Roller . . . . . 57  
 Texture Mat Release Agent . . . . . 55  
 Texture Roller . . . . . 57, 101  
 Texture Skins . . . . . 56

Texture Tine Broom . . . . . 26  
**Texturing Machines . . 102-103**  
 Tie Wire Twister . . . . . 21  
 Tile Cutters . . . . . 113-114  
 Tile Spacers . . . . . 118  
 Tines, Replacement . . . . . 26  
**Tool Display . . . . . Contact Customer Service**  
 Tool Pouch . . . . . 122-123  
 Tri Level Placer . . . . . 26

**Trowels**

Angle . . . . . 98  
 Barrier . . . . . 33  
 Bracket . . . . . 10  
 Buttering . . . . . 76, 78  
 Brick . . . . . 72-76, 78  
 Bucket, EIFS . . . . . 100  
 Bucket . . . . . 76, 78  
 Caulking . . . . . 59, 79  
 Ceremonial . . . . . 76  
 Chrome (No Burn) . . . . . 9  
 Concrete . . . . . 4-9  
 Cross Joint . . . . . 78

Drywall . . . . . 110  
 Duck Bill . . . . . 78  
 Elite Series™ . . . . . 4-5  
 Exterior Finish . . . . . 100  
 Finish . . . . . 6-7  
 Funny . . . . . 10  
 Gauging . . . . . 78  
 Golden SS . . . . . 5, 7-9, 96  
 Gunite . . . . . 39  
 Handles . . . . . 7, 75  
 Midget . . . . . 10  
 Mud . . . . . 76  
 Narrow London . . . . . 72-73, 78  
 Notched, EIFS . . . . . 100  
 Notched, Tile . . . . . 116  
 Philadelphia . . . . . 72, 74, 76  
 Pipe . . . . . 10  
 Plastering . . . . . 5, 9, 96  
 Plexi-Plastic . . . . . 10  
 Pointing . . . . . 58, 79  
 Pool . . . . . 5, 8-10  
 Pumpkin . . . . . 76  
 Scratcher . . . . . 96

Sewer . . . . . 76  
 Sharpener . . . . . 7  
 Silo . . . . . 7  
 Tile . . . . . 116  
 Venetian . . . . . 98  
 Wide London . . . . . 72, 75, 78

**U**

Utility Knife . . . . . 110-111  
 Utility Stamps . . . . . 33

**W**

**W. Rose™ Tools . . . . 72-77**

Wall Capping Tool . . . . . 48  
 Wall Edger . . . . . 33  
 Wall Mini Float . . . . . 33  
 Wall Scraper . . . . . 110  
 Whiskey Stick . . . . . 23  
 Wire Reel . . . . . 21  
 Wire Texture Broom . . . . . 26  
 Wooden Line Block . . . . . 70, 94



**KRAFT TOOL CO.®**

8325 Hedge Lane Terrace • Shawnee, Kansas 66227 USA  
 Phone (913) 422-4848 Fax (913) 422-1018

Visit us online: [www.krafttool.com](http://www.krafttool.com)

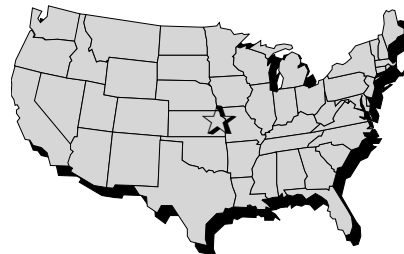

W. Rose™, Sands Level and Tool Co.®, Inc., and Superior Tile Cutter®, Inc., are wholly owned subsidiaries of Kraft Tool Co.®

\*PRODUCTS OF FOREIGN ORIGIN are noted with an (\*) in the product description. Kraft Tool Co.® will bring to you the best quality possible in order to offer a wide variety of professional hand tools.

# HISTORY OF OUR COMPANIES



Kraft Tool Co.® established in 1981, manufactures quality Trowel Trade Tools for concrete, masonry, drywall, plaster, and tile professionals. As a trusted name in the hand tool industry, Kraft Tool is proud of the "Hand Crafted" workmanship attributed to every product. Our goal is simple: Maintain quality, provide good service and offer new and innovative products.

*W. Rose™, Sands Level & Tool Co.®, Inc. and Superior Tile Cutter®, Inc. are wholly owned subsidiaries of Kraft Tool Co.®*

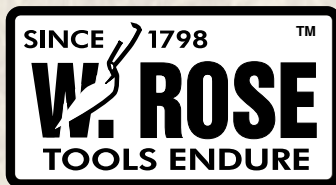

W. Rose™ was established in 1798, by William Rose in Blockley Township Pennsylvania. In 1807, Mr. Rose began his long career making cavalry sabers and officer swords for the US Army. In 1864 he began specializing in edged tools, knives and trowels. Kraft Tool Co.® acquired W. Rose™ Brick Trowel Company in 2001. Kraft remains dedicated to maintaining the legendary quality of W. Rose™ masonry products. Find W. Rose™ masonry tools and brick trowels on **pages 72-77** of this catalog.

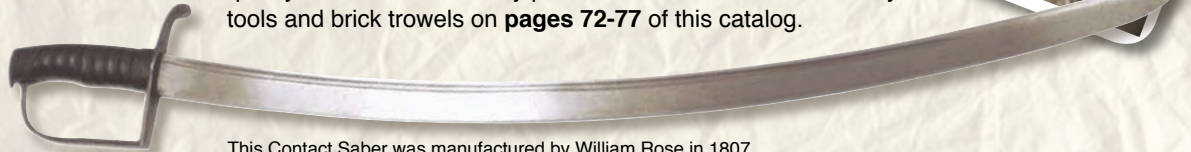

This Contact Saber was manufactured by William Rose in 1807.



Sands Level & Tool Co.®, Inc. was established in 1895 and is known as one of the largest level manufacturing businesses in the world. Julius Sand, the inventor of Sands Levels was a bricklayer and the inventor of the Sands type of "Solid Set" vials. He also originated the aluminum type level to offer a lightweight level for the tradesman. In 2005 Kraft Tool Co.® acquired Sands Level and Tool Co.™, Inc. "Sands Levels Tell The Truth"® Find Sands levels and tools on **pages 60-71** of this catalog.



This wood level was manufactured when Sands was J. Sands & Son's (Detroit, MI) in 1900.



Superior Tile Cutter®, Inc. was established in 1930. They are the pioneer manufacturer of professional quality, durable ceramic tile cutters, carbide tipped nippers, chisels, hammers, scribes and cutter wheels. Superior's 75 year history prides itself on manufacturing products that will last the professional tradesman a lifetime. In 2003 Kraft Tool Co.® acquired Superior Tile Cutter®, Inc. Superior Tile Cutter® remains the choice of Professional Tile Setters around the world. Find Superior Tile Cutter® tool on **pages 113-119** of this catalog.



Kraft Tool Co.® continues to expand our family of tools by offering "Value Priced Trade Tools" called Hi-Craft™. These are additions to our already expanded line of tools, offering homeowner tools at a value price. Find Hi-Craft tools on **pages 58-59 and 118** of this catalog.

**SANDS**  
THE FIRST NAME IN LEVELS  
MADE IN USA

## ***Kraft Signature Line of Companies***

**SANDS**<sup>®</sup>  
— SINCE 1895 —  
**THE FIRST NAME IN LEVELS**  
MADE IN USA

*Sand's Levels Tell The Truth*<sup>®</sup>



SINCE 1798<sup>™</sup>  
**W. ROSE**  
TOOLS ENDURE

*The World's Finest  
BrickLayers Tools  
Since 1798*



Since 1930  
**SUPERIOR**  
TILE CUTTER, INC.

*"The Original"*



**Kraft Tool Co.**<sup>®</sup>

(913) 422-4848 Fax: (913) 422-1018

[www.KraftTool.com](http://www.KraftTool.com)

W. Rose<sup>™</sup>, Sands Level & Tool Co.<sup>®</sup>, Inc. and Superior Tile Cutter<sup>®</sup>, Inc. are wholly owned subsidiaries of Kraft Tool Co.<sup>®</sup>