

FANIMATION : AIR APPARENT

Fanimation's focus is producing creative and functional fans that provide ultimate personal comfort using the latest technology for energy efficiency and seamless control. From our humble beginnings in 1984, inside Founder and CEO Tom Frampton's Pasadena, California garage, ingenuity and quality craftsmanship have been central in every product we manufacture. Our timeless and inspired fans are sought across the globe.

You will find Fanimation in some of the most luxurious locales—from tropical resorts to the heart of your home.

CHOOSING YOUR FAN

LOCATION IS EVERYTHING

- Where you will install your fan is the first step in selecting the right fan for your space.
- Dry, indoor location: Choose from any of our fans—dry, damp or wet rated.
 - Outdoor covered or high-humidity indoor location: Choose from our damp or wet rated fans.
 - Outdoor location with likely direct contact with water: Choose from our wet rated fans.

We've made it easy for you!
Look for these icons to identify location rating:



SIZE MATTERS

The size of your room will help determine the size of your fan, identified by blade sweep. The following are general guidelines.

- Optimal performance will come from mounting your fan in the center of the room.
- If you have a long or large room, consider the use of multiple fans
- Scale is a personal preference. Large diameter fans can go in both small rooms and larger rooms—it's all in the look you desire.

SMALL ROOM
52 in. or smaller

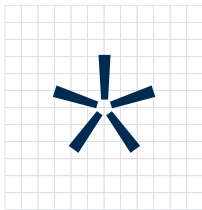

LARGE ROOM
52 in. or larger

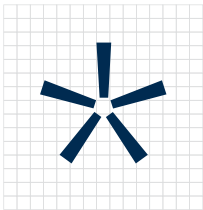

GREAT ROOM
60 in. or larger

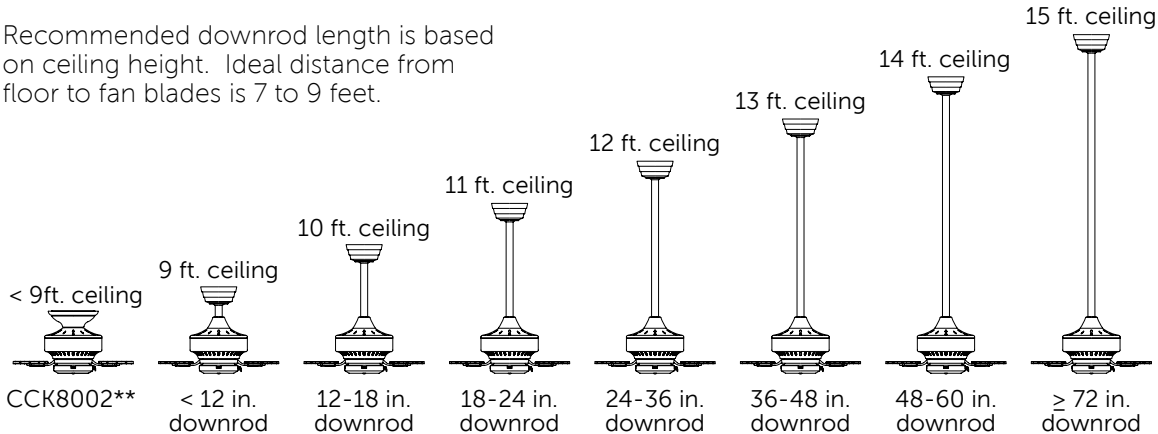
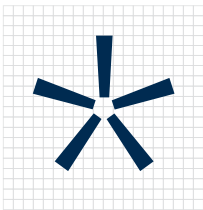



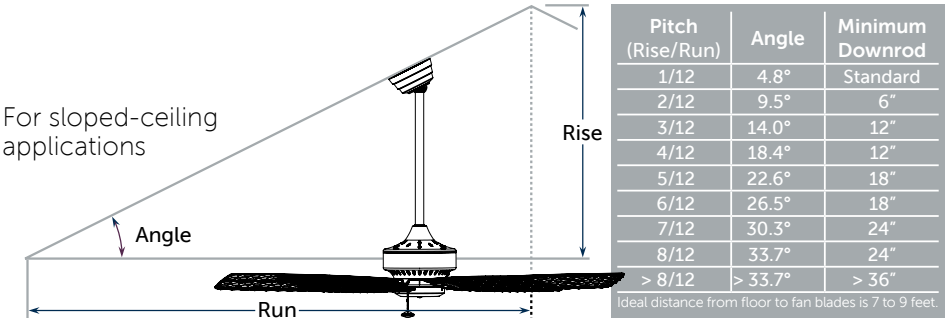

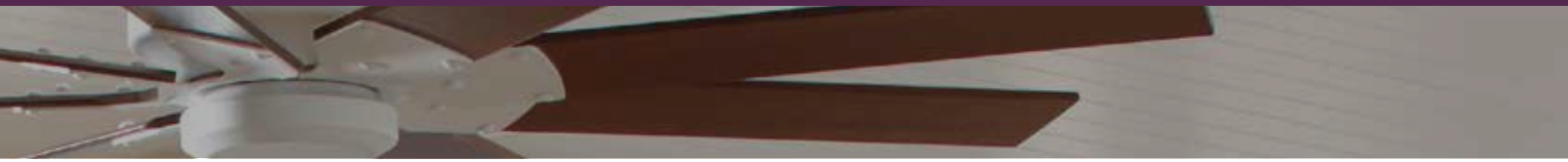





For lengths greater than 72 in., join two downrods with DR1-CP** coupler





IDENTIFYING FEATURES IMPORTANT TO YOU

We offer a diverse line of fans with equally diverse features. As you choose your fan, identify the features that matter to you—use Features Legend below to understand the Features icons.

fan control type				light kit included + lamping info	number of fan speeds + location of reversing switch	Bluetooth® control—if included or compatible	fan, blades and light sold separately	features energy-efficient DC motor	fan has earned the Energy Star
									
CONTROL wall	CONTROL remote	CONTROL pull chain	CONTROL rotary	WATTAGE bulb style	SPEED reverse location	FANSYNC™			

UNDERSTANDING AIRFLOW

We provide airflow information—at high speed—for each fan. Airflow is measured in CFM (cubic feet per minute), energy used is measured in watts and the energy efficiency of the fan is measured in CFM per watt.

ENERGY INFORMATION AT HIGH SPEED:

Airflow	Electricity Use	Airflow Efficiency
6942 Cubic Feet Per Minute	65 Watts (excluding lights)	107 Cubic Feet Per Minute Per Watt
The greater the number, the greater the air moved	Energy consumed	The greater the number, the more efficient the fan is

FANIMATION MOTORS—AC AND DC

All Fanimation motors are built using high quality materials and components, insuring years of reliable and dependable operation for every Fanimation fan.

- Our fans are equipped with either an AC motor or DC motor.
- AC motors use supplied power directly and regulate speeds by controlling frequency.
- DC motors convert supplied power and regulate speeds by controlling electrical current.
- Our AC motors come in 1-, 3- and 4-speed variants.
- Our DC motors come in 6- and 31-speed variants. DC motors are more efficient, generate more torque and are virtually silent.

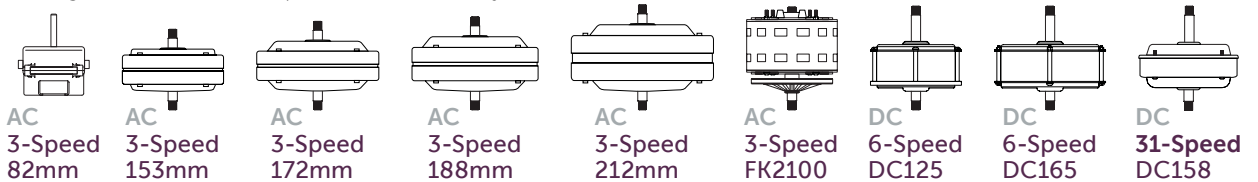

SEASONAL CEILING FAN USE

Ceiling fans save money year-round when turning in the proper direction.

WARM WEATHER
Airflow with counter-clockwise rotation, as you look up, provides a cooling breeze

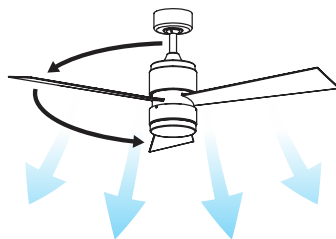

COOL WEATHER
Airflow with clockwise rotation, as you look up, forces warm air downward

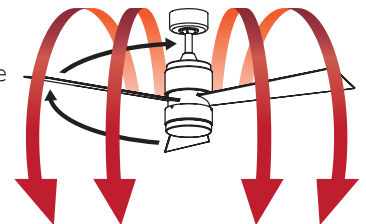

Need more assistance? Call 1-888-567-2055

INDOOR

AIRE DÉCOR
96



AIRE DELUXE 44
42



AIRE DELUXE 52
44



BECKWITH
18



BENITO
30



BOURBON
STREET
53



CAMHAVEN
32



CANCUN 42
40

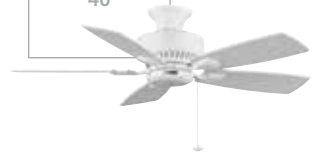

CELANO v2
24



EDGEWOOD
DECORATIVE
46



EDGEWOOD
DELUXE
48



EDGEWOOD
SUPREME
50



EMBRACE 44
12



EMBRACE 52
14



ENIGMA
60



INLET
16



KEISTONE
34



KELLAN
52



LEVON AC
26



LOUVRE
38



MAREA
20



PALMETTO
54



STAFFORD
28



VENTANA
36



ZONIX
22



INDOOR/OUTDOOR

AIRE DÉCOR
DAMP
96

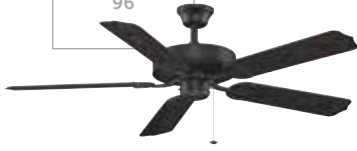

AMERICANA
120



ASCENSION
62



AVASTON
92



BELLERIA
112



BIG ISLAND
118



BREWMASTER
128



CANCUN WET
102

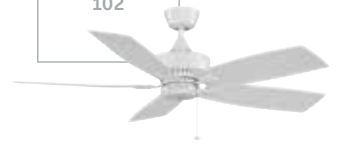

CARUSO
124



CRESTFORD
106



EDGEWOOD
DELUXE WET
100



EDGEWOOD
WET
98



EXTRAORDINAIRE
58



ISLANDER AC
114



ISLANDER DC
116



JENNIX
94



KAYA
104



LEVON
CUSTOM
84



LEVON DC
82

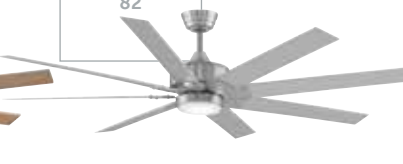

My FANIMATION
DISTINCTION AC
66



My FANIMATION
DISTINCTION DC
72



ODYN
80



PALISADE
122

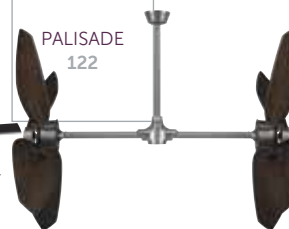

PUNKAH
126



SPITFIRE
86



SUBTLE
78



TORTO
88



TORTO LED
90



INDOOR/OUTDOOR

WINDPOINTE
108



WINDPOINTE
CUSTOM
110

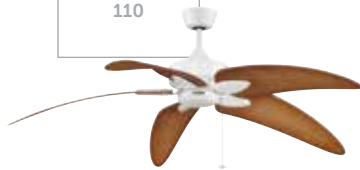

XENO
64



ZONIX LED
76



ZONIX WET
74



PORTABLES

ARDEN
136



MINI BREEZE
132



OLD HAVANA
138



URBANJET
134



ACCESSORIES

BLADES
149



CONTROLS
141



LIGHTING
139



DOWNRODS &
ACCESSORIES
147







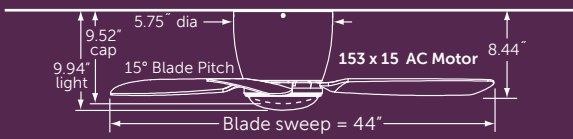

INDOOR



Net Hanging Weight: 18.9 lbs.

FAN: FPS7981BN (1)
 brushed nickel assembly with
 brushed nickel blades and
 matching light cover (included)





FAN: FPS7981DZ (1)
 dark bronze assembly with
 dark bronze blades and
 opal frosted glass



FAN: FPS7981GR (1)
 matte greige assembly with
 matte greige blades and
 matching light cover (included)



FAN: FPS7981MW (1)
 matte white assembly with
 matte white blades and
 opal frosted glass



SOLD SEPARATELY:



See page 141-146 for
optional controls

EMBRACE™ 44

FAN: FPS7981GR (1)
matte greige assembly
with matte greige blades
and opal frosted glass

brushed nickel	dark bronze	matte greige	matte white
brushed nickel	dark bronze	matte greige	matte white
FPS7981BN	FPS7981DZ	FPS7981GR	FPS7981MW



(1) 100W
halogen
minican



3-SPEED AC
reverse switch
on remote



CONTROL
remote



DRY
indoor only

INCLUDED:



blade set



light kit



light cover



TR20WH remote

ENERGY INFORMATION AT HIGH SPEED:

Airflow
3855
Cubic Feet
Per Minute

Electricity Use
45
Watts
(excluding lights)

Airflow Efficiency
87
Cubic Feet Per
Minute Per Watt

LIMITED LIFETIME MOTOR WARRANTY



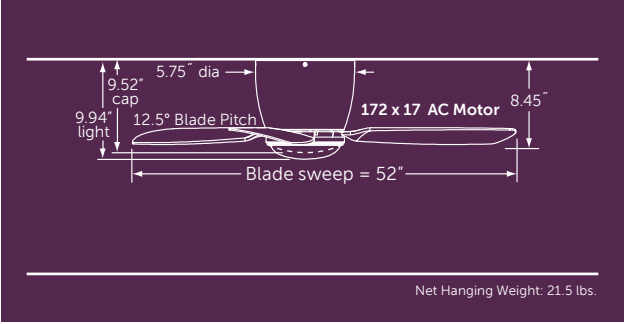

FAN: FPS7955BN (1)
brushed nickel assembly with
brushed nickel blades and
matching light cover (included)



FAN: FPS7955DZ (1)
dark bronze assembly with
dark bronze blades and
opal frosted glass



FAN: FPS7955GR (1)
matte greige assembly with
matte greige blades and
matching light cover (included)



FAN: FPS7955MW (1)
matte white assembly with
matte white blades and
opal frosted glass



SOLD SEPARATELY:



See page 141-146 for
optional controls

EMBRACE™ 52

FAN: FPS7955DZ (1)
dark bronze assembly with
dark bronze blades and
opal frosted glass

brushed nickel	dark bronze	matte greige	matte white
brushed nickel	dark bronze	matte greige	matte white
FPS7955BN	FPS7955DZ	FPS7955GR	FPS7955MW



(1) 100W
halogen
minican



3-SPEED AC
reverse switch
on remote



CONTROL
remote



DRY
indoor only

INCLUDED:



blade set



light kit



light cover



TR20WH remote

ENERGY INFORMATION AT HIGH SPEED:

Airflow
5509
Cubic Feet
Per Minute

Electricity Use
48
Watts
(excluding lights)

Airflow Efficiency
114
Cubic Feet Per
Minute Per Watt

LIMITED LIFETIME MOTOR WARRANTY



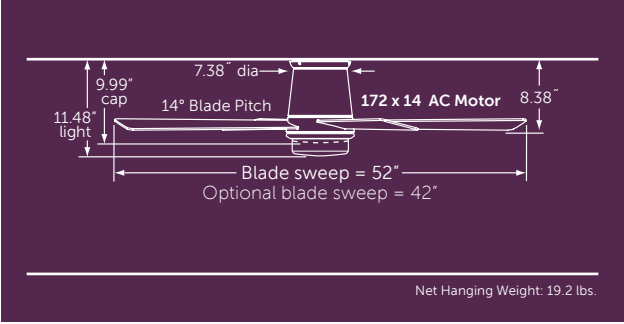

FAN: FPS7880SN (1)
satin nickel assembly with
cherry/walnut reversible
blades and opal frosted glass
● walnut side showing



FAN: FPS7880OB (1)
oil-rubbed bronze assembly
with cherry/walnut reversible
blades and opal frosted glass
● walnut side showing



FAN: FPS7880SN (1)
satin nickel assembly with opal
frosted glass
BLADE SET: BPW7823SN (1)
52" sweep all-weather composite
satin nickel (sold separately)



SOLD SEPARATELY:



See page 141-146 for
optional controls

CY—cherry
SN—satin nickel
WA—walnut

BPW7880** composite

SN—satin nickel

B7880SN wood

CY—cherry
SN—satin nickel
WA—walnut

BPW7823** composite

INLET™

FAN: FPS7880SN (1)
satin nickel assembly with
matching light cover (included)

BLADE SET: BPW7880CY (1)
42" sweep all-weather composite
cherry blades (sold separately)

oil-rubbed bronze	satin nickel
cherry walnut	cherry walnut
FPS7880OB	FPS7880SN



FANSYNC™
compatible



(1) 18W
GU24 CFL



3-SPEED AC
reverse switch
on remote



CONTROL
remote



DRY
indoor only

INCLUDED:

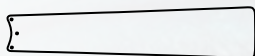

blade set



light kit

light cover



TR20WH remote

ENERGY INFORMATION
AT HIGH SPEED:

Airflow
5102
Cubic Feet
Per Minute

Electricity Use
59
Watts
(excluding lights)

Airflow Efficiency
86
Cubic Feet Per
Minute Per Watt

LIMITED LIFETIME MOTOR WARRANTY



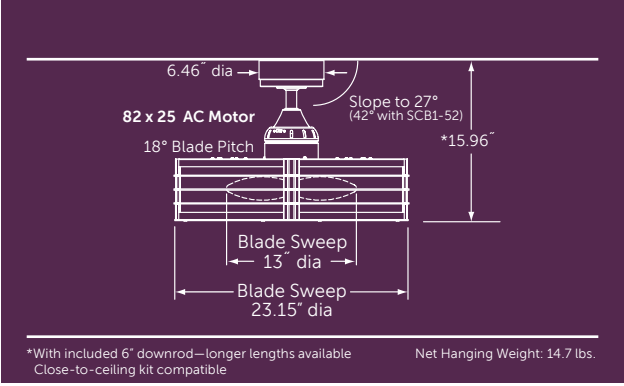

NOTE: THE LIGHT ON THE BECKWITH™ IS CONSIDERED AN ACCENT LIGHT AND IS NOT INTENDED TO BE USED AS A PRIMARY LIGHT SOURCE

FAN: FP7964BN (1)
brushed nickel assembly
with frosted white shade



FAN: FP7964OB (1)
oil-rubbed bronze assembly
with frosted white shade



SOLD SEPARATELY:



See page 141-146 for
optional controls

BECKWITH™



 **FAN: FP7964OB (1)**
oil-rubbed bronze assembly
with frosted white shade

brushed nickel	oil-rubbed bronze
aluminum	black
FP7964BN	FP7964OB

INCLUDED:



TR24WH remote

FANSYNC™
compatible

(4) 43W
halogen
candelabra

3-SPEED AC
reverse switch
on fan

CONTROL
remote

DRY
indoor only

ENERGY INFORMATION AT HIGH SPEED:

Airflow
1009
Cubic Feet
Per Minute

Electricity Use
63
Watts
(excluding lights)

Airflow Efficiency
16
Cubic Feet Per
Minute Per Watt

LIMITED LIFETIME MOTOR WARRANTY



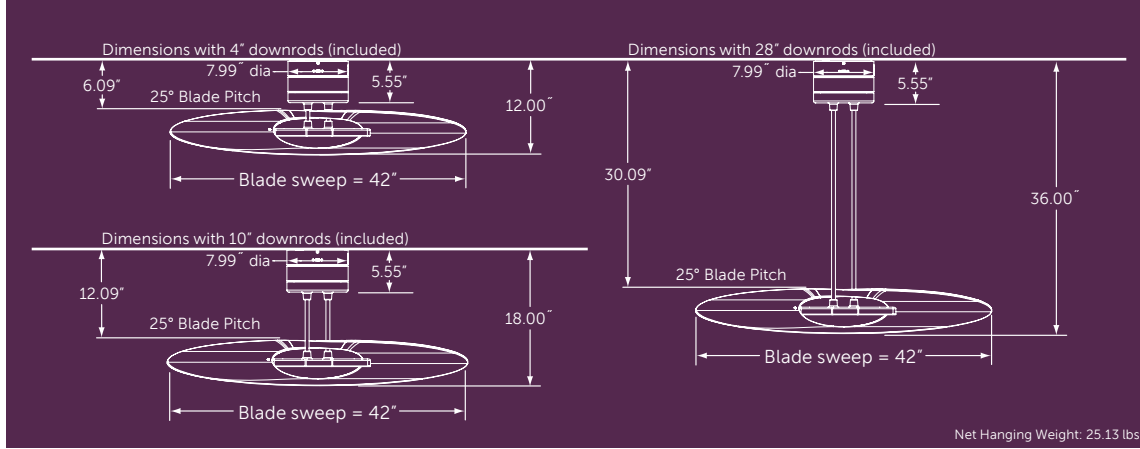

❖ **FAN: FP8026SN** (1)
satin nickel assembly with
white frosted blade
● 28" downrod configuration

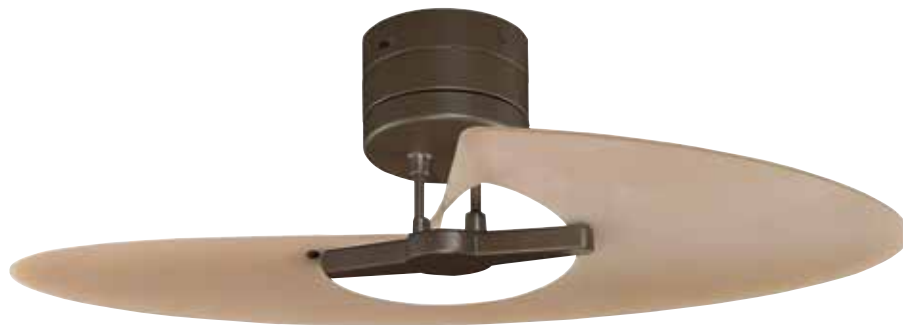

❖ **FAN: FP8026OB** (1)
oil-rubbed bronze assembly
with amber frosted blade
● 4" downrod configuration

SOLD SEPARATELY:



See page 141-146 for
optional controls

MAREA™

FAN: FP8026OB (1)
 oil-rubbed bronze assembly
 with amber frosted blade
 • 4" downrod configuration

oil-rubbed bronze	satin nickel
amber frosted	white frosted
FP8026OB	FP8026SN

INCLUDED:

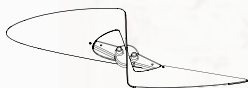

blade



TR33 remote

ENERGY INFORMATION AT HIGH SPEED:

FANSYNC™ compatible	3-SPEED AC reverse switch on fan	CONTROL remote	DRY indoor only
Airflow	Electricity Use	Airflow Efficiency	
3151	47	67	
Cubic Feet Per Minute	Watts (excluding lights)	Cubic Feet Per Minute Per Watt	

LIMITED LIFETIME MOTOR WARRANTY



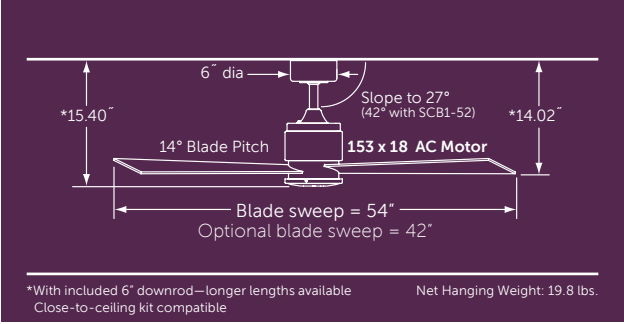

FAN: FP4620BL (1)
black assembly with
black wood blades



FAN: FP4620BN (1)
brushed nickel assembly with
reversible cherry/walnut wood blades
● cherry side showing

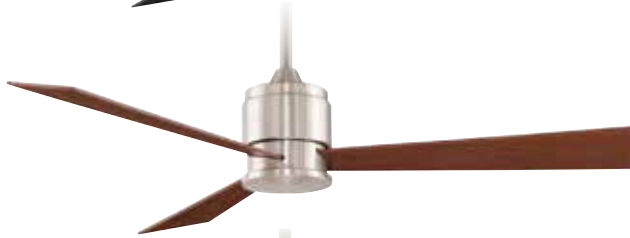

FAN: FP4620OB (1)
oil-rubbed bronze assembly with
reversible cherry/walnut wood blades
● cherry side showing



FAN: FP4620PN (1)
polished nickel assembly with
reversible cherry/walnut wood blades
● walnut side showing



FAN: FP4620SN (1)
satin nickel assembly with reversible
cherry/walnut wood blades
● cherry side showing



FAN: FP4630SN (1)
satin nickel assembly with
satin nickel wood blades



SOLD SEPARATELY:



See page 141-146 for
optional controls

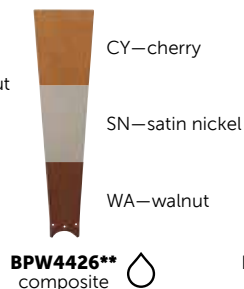

ZONIX™

 **FAN: FP4620BL (1)**
black assembly with
black wood blades

black	brushed nickel	oil-rubbed bronze	polished nickel	satin nickel	satin nickel
black	cherry walnut	cherry walnut	cherry walnut	cherry walnut	satin nickel
FP4620BL	FP4620BN	FP4620OB	FP4620PN	FP4620SN	FP4630SN

INCLUDED:







blade set



CW40 wall control

ENERGY INFORMATION
AT HIGH SPEED:

			
FANSYNC™ compatible	4-SPEED AC reverse switch on fan	CONTROL wall	DRY indoor only

Airflow
4436
Cubic Feet
Per Minute

Electricity Use
57
Watts
(excluding lights)

Airflow Efficiency
78
Cubic Feet Per
Minute Per Watt

LIMITED LIFETIME MOTOR WARRANTY



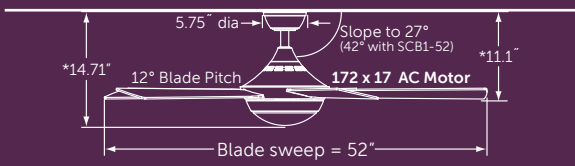

*With included 4.5" downrod—longer lengths available
Close-to-ceiling kit compatible

Net Hanging Weight: 18.74 lbs.



- FAN: FP8062BN** (1)
brushed nickel assembly with
frosted white glass and reversible
cherry/dark walnut blades
- cherry side showing



- FAN: FP8062DZ** (1)
dark bronze assembly with
frosted glass and reversible
cherry/dark walnut blades
- dark walnut side showing



- FAN: FP8062MW** (1)
matte white assembly
with frosted glass and
matte white blades



SOLD SEPARATELY:



See page 141-146 for
optional controls

CELANO v2™

FAN: FP8062BN (1)
brushed nickel assembly
with cherry/dark walnut
reversible blades.
• dark walnut side showing

brushed nickel	dark bronze	matte white
cherry dark walnut	cherry dark walnut	matte white
FP8062BN	FP8062DZ	FP8062MW

- FANSYNC™** included
- 18W LED**
- 3-SPEED AC** reverse switch on fan
- CONTROL** remote
- DRY** indoor only

INCLUDED:

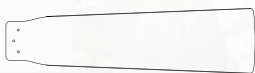

blade set



light kit



BTT9

ENERGY INFORMATION AT HIGH SPEED:

Airflow	Electricity Use	Airflow Efficiency
5596	60	93
Cubic Feet Per Minute	Watts (excluding lights)	Cubic Feet Per Minute Per Watt



LIMITED LIFETIME MOTOR WARRANTY



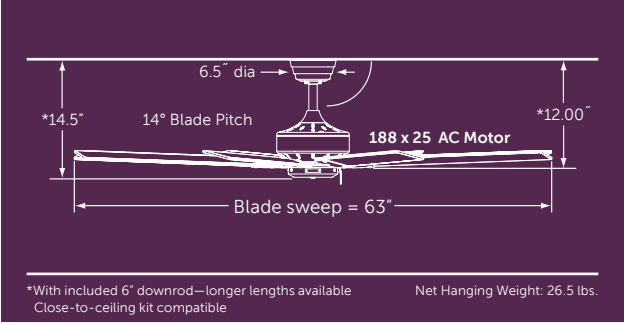

FAN: FP7910BL (1)
 black assembly with black blades



FAN: FP7910BN (1)
 brushed nickel assembly
 with reversible cherry/walnut
 wood blades
 ● walnut side showing



FAN: FP7910MW (1)
 matte white assembly with
 matte white blades



FAN: FP7910OB (1)
 oil-rubbed bronze assembly
 with walnut blades



SOLD SEPARATELY:



See page 141-146 for
 optional controls

LEVON™ AC



FAN: FP7910BN (1)
brushed nickel assembly
with reversible cherry/
walnut wood blades
● walnut side showing

brushed nickel	black	matte white	oil-rubbed bronze
cherry walnut	black	matte white	walnut
FP7910BN	FP7910BL	FP7910MW	FP7910OB



FANSYNC™
compatible



3-SPEED AC
reverse switch
on fan



CONTROL
pull chain



DRY
indoor only

INCLUDED:

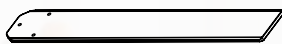

blade set

ENERGY INFORMATION AT HIGH SPEED:

Airflow

6942

Cubic Feet
Per Minute

Electricity Use

65

Watts
(excluding lights)

Airflow Efficiency

107

Cubic Feet Per
Minute Per Watt



LIMITED LIFETIME MOTOR WARRANTY



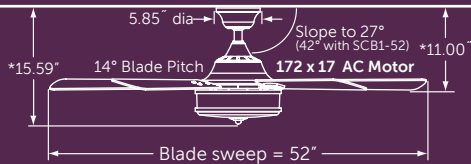

*With included 4.5" downrod—longer lengths available
Close-to-ceiling kit compatible

Net Hanging Weight: 23.2 lbs.

- FAN: PL8274BN (1)**
 brushed nickel assembly with
 frosted white glass and reversible
 cherry/dark walnut blades
 - dark walnut side showing



- FAN: PL8274DZ (1)**
 dark bronze assembly with
 frosted white glass and reversible
 cherry/dark walnut blades
 - cherry side showing



- FAN: PL8274BN (1)**
 brushed nickel assembly with
 frosted white glass and reversible
 cherry/dark walnut blades
 - cherry side showing



- FAN: PL8274DZ (1)**
 dark bronze assembly with
 frosted white glass and reversible
 cherry/dark walnut blades
 - dark walnut side showing



SOLD SEPARATELY:



See page 141-146 for
optional controls

STAFFORD™

FAN: PL8274DZ(1)
 dark bronze assembly with frosted white glass and reversible cherry/dark walnut blades
 • dark walnut side showing

brushed nickel	dark bronze
cherry dark walnut	cherry dark walnut
PL8274BN	PL8274DZ



FANSYNC™ compatible



(3) 40W incandescent candelabra



3-SPEED AC reverse switch on fan



CONTROL remote



DRY indoor only

INCLUDED:

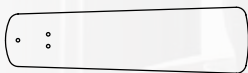

blade set



light kit



TR24WH remote

ENERGY INFORMATION AT HIGH SPEED:

Airflow
4911
 Cubic Feet Per Minute

Electricity Use
56
 Watts (excluding lights)

Airflow Efficiency
88
 Cubic Feet Per Minute Per Watt

LIMITED LIFETIME MOTOR WARRANTY



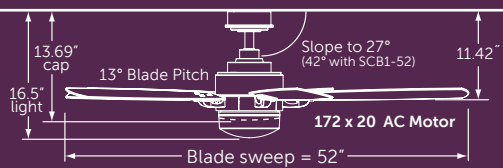

*With included 4.5" downrod—longer lengths available
Close-to-ceiling kit compatible

Net Hanging Weight: 19.6 lbs.

- 
FAN: FP8003BN (1)
 brushed nickel assembly with opal frosted glass and reversible cherry/walnut wood blades
 - cherry side showing



- 
FAN: FP8003MW (1)
 matte white assembly with opal frosted glass and matte white wood blades



- 
FAN: FP8003OB (1)
 oil-rubbed bronze assembly with and reversible mahogany/walnut wood blades and matching light cover (included)
 - mahogany side showing



- 
FAN: FP8003PN (1)
 polished nickel assembly with opal frosted glass and reversible cherry/walnut wood blades
 - cherry side showing



- 
FAN: FP8003SN (1)
 satin nickel assembly with opal frosted glass and reversible cherry/walnut wood blades
 - walnut side showing



SOLD SEPARATELY:



See page 141-146 for optional controls

BENITO™

FAN: FP8003BN (1)
brushed nickel assembly with
opal frosted glass and reversible
cherry/walnut wood blades
• walnut side showing

brushed nickel	matte white	oil-rubbed bronze	polished nickel	satin nickel
cherry walnut	matte white	ma-hogany walnut	cherry walnut	cherry walnut
FP8003BN	FP8003MW	FP8003OB	FP8003PN	FP8003SN

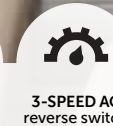

INCLUDED:



blade set



light kit
light cover



TR24WH remote

ENERGY INFORMATION AT HIGH SPEED:

Airflow
5052
Cubic Feet Per Minute

Electricity Use
63
Watts
(excluding lights)

Airflow Efficiency
80
Cubic Feet Per Minute Per Watt



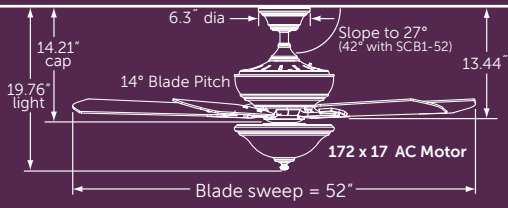

*With included 4.5" downrod—longer lengths available
Close-to-ceiling kit compatible

Net Hanging Weight: 24.47 lbs.

- FAN: FP8095BA (1)**
 bronze accent assembly with frosted white glass and reversible cherry/walnut wood blades
 - walnut side showing



- FAN: FP8095OB (1)**
 oil-rubbed bronze assembly (shown without light kit) with reversible cherry/walnut wood blades
 - cherry side showing



- FAN: FP8095PW (1)**
 pewter assembly with frosted white glass and reversible cherry/walnut wood blades
 - walnut side showing



- FAN: FP8095WH (1)**
 white assembly with white frosted glass and white wood blades



SOLD SEPARATELY:



See page 141-146 for optional controls

CAMHAVEN™

FAN: FP8095PW(1)
 pewter assembly with frosted white glass and reversible cherry/walnut wood blades
 • walnut side showing

bronze accent	oil-rubbed bronze	pewter	white
cherry walnut	cherry walnut	cherry walnut	white
FP8095BA	FP8095OB	FP8095PW	FP8095WH

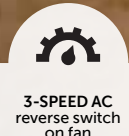

INCLUDED:



ENERGY INFORMATION AT HIGH SPEED:

Airflow
5813
 Cubic Feet Per Minute

Electricity Use
67
 Watts (excluding lights)

Airflow Efficiency
87
 Cubic Feet Per Minute Per Watt

LIMITED LIFETIME MOTOR WARRANTY



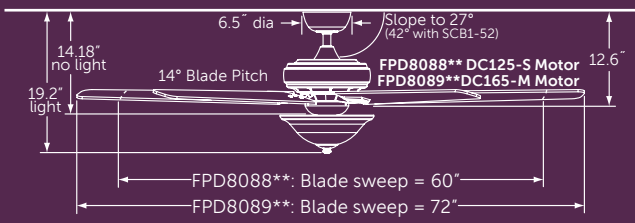

*With included 4.5" downrod—longer lengths available FPD8088**: Net Hanging Weight: 22.86 lbs.
 FPD8089**: Net Hanging Weight: 26.54 lbs.

- FAN: FPD8088BA (1)**
 60" bronze accent assembly with amber linen glass and reversible cherry/walnut wood blades
 ● cherry side showing



- FAN: FPD8088PW (1)**
 60" pewter assembly with reversible cherry/walnut wood blades. (shown without light kit)
 ● walnut side showing



- FAN: FPD8089BA (1)**
 72" bronze accent assembly with reversible cherry/walnut wood blades. (shown without light kit)
 ● walnut side showing



- FAN: FPD8089PW (1)**
 72" pewter assembly with white linen glass and reversible cherry/walnut wood blades
 ● cherry side showing



SOLD SEPARATELY:



See page 141-146 for optional controls

KEISTONE™

FAN: FPD808089PW (1)
 72" pewter assembly with white
 linen glass and reversible cherry/
 walnut wood blades
 • cherry side showing

bronze accent	pewter
cherry walnut FPD8088BA FPD8089BA	cherry walnut FPD8088PW FPD8089PW

INCLUDED:

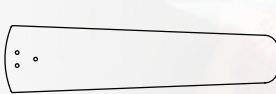

blade set



light kit



TR39 remote

ENERGY SAVINGS	(2) 75W halogen minican	6-SPEED DC reverse switch on remote	CONTROL remote	DRY indoor only

**ENERGY INFORMATION
 AT HIGH SPEED:**

FPD8088**	Airflow	Electricity Use	Airflow Efficiency
FPD8089**	6466	30.2	214
	8895	29.3	304
	Cubic Feet Per Minute	Watts (excluding lights)	Cubic Feet Per Minute Per Watt

LIMITED LIFETIME MOTOR WARRANTY



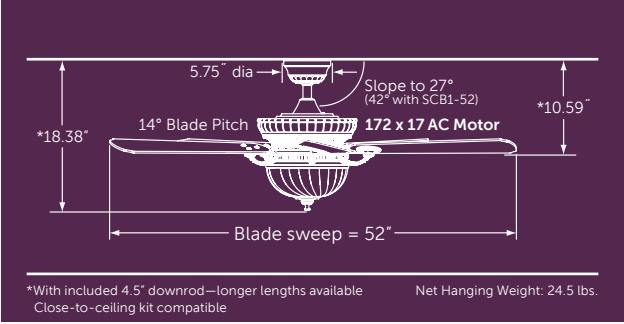

FAN: FP8032DZ (1)
 dark bronze assembly
 with frosted white glass
 and reversible cherry/dark
 walnut blades

- cherry side showing



FAN: FP8032DZ (1)
 dark bronze assembly
 with frosted white glass
 and reversible cherry/dark
 walnut blades

- dark walnut side showing

SOLD SEPARATELY:



See page 141-146 for
 optional controls

VENTANA™

FAN: FP8032DZ (1)
 dark bronze assembly
 with frosted white glass
 and reversible cherry/dark
 walnut blades
 • dark walnut side showing

dark
bronze
cherry dark
walnut
FP8032DZ



FANSYNC™
compatible



(2) 50W
halogen
minican



3-SPEED AC
reverse switch
on fan



CONTROL
remote



DRY
indoor only

INCLUDED:



blade set



light kit



TR24WH remote

ENERGY INFORMATION AT HIGH SPEED:

Airflow
5792
Cubic Feet
Per Minute

Electricity Use
83
Watts
(excluding lights)

Airflow Efficiency
70
Cubic Feet Per
Minute Per Watt

LIMITED LIFETIME MOTOR WARRANTY



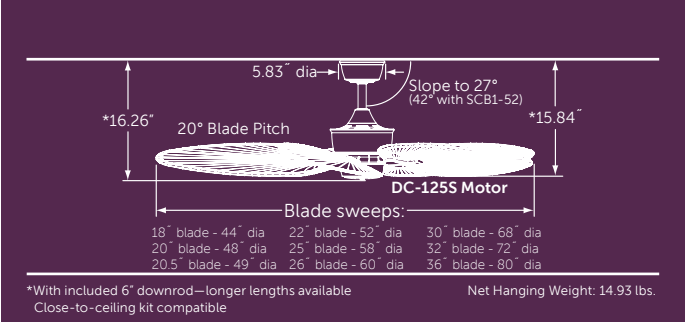

FAN: MAD3255BA (1)
bronze accent assembly
BLADES: ISP1 (1)
52" sweep natural palm
leaf wide oval



FAN: MAD3255PW (1)
pewter assembly
BLADES: ISD4A (1)
52" sweep antique narrow
oval woven bamboo

SOLD SEPARATELY:



blade options: p.149-150
control options: p.141-146
light options: p.139-140

LOUVRE™



FAN: MAD3255PW (1)
 pewter assembly
BLADE SET: B5133TKMH (1)
 52" sweep reversible teak/
 mahogany wood
 • teak side showing

bronze accent
MAD3255BA
 pewter
MAD3255PW

- ENERGY SAVINGS**
- MIX & MATCH**
 components sold separately
- 6-SPEED DC**
 reverse switch on remote
- CONTROL**
 remote
- DRY**
 indoor only

INCLUDED:



TR39 remote

ENERGY INFORMATION
AT HIGH SPEED:
 Airflow measured
 with B5330** blade

Airflow	Electricity Use	Airflow Efficiency
5412	30	183
Cubic Feet Per Minute	Watts (excluding lights)	Cubic Feet Per Minute Per Watt



LIMITED LIFETIME MOTOR WARRANTY



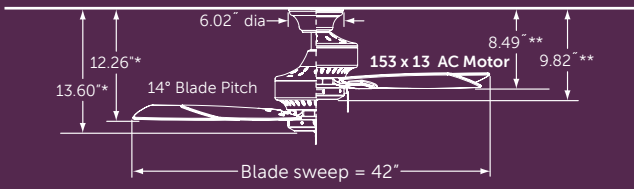

*With included 4.5" downrod—longer lengths available
 **With included flush mount kit

Net Hanging Weight: 15.37 lbs.



FAN: FP8042OB (1)
 oil-rubbed bronze assembly in flush-mount configuration with reversible cherry/walnut wood blades
 ● cherry side showing

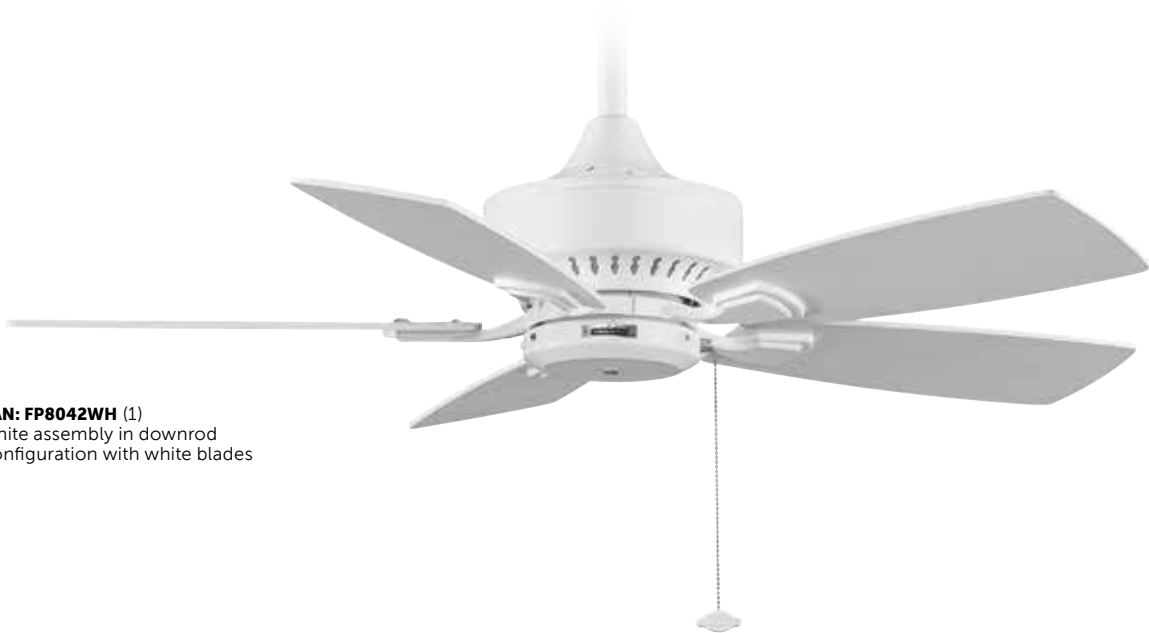

FAN: FP8042WH (1)
 white assembly in downrod configuration with white blades

SOLD SEPARATELY:



control options: p.141-146
 light options: p.139-140

CANCUN™ 42

FAN: FP8042OB (1)
oil-rubbed bronze assembly with reversible cherry/walnut wood blades
● walnut side showing

oil-rubbed bronze	white
cherry walnut	white
FP8042OB	FP8042WH

FANSYNC™
compatible

3-SPEED AC
reverse switch
on fan

CONTROL
pull chain

DRY
indoor only

INCLUDED:



blade set

ENERGY INFORMATION
AT HIGH SPEED:

Airflow
3943
Cubic Feet
Per Minute

Electricity Use
47
Watts
(excluding lights)

Airflow Efficiency
84
Cubic Feet Per
Minute Per Watt

LIMITED LIFETIME MOTOR WARRANTY



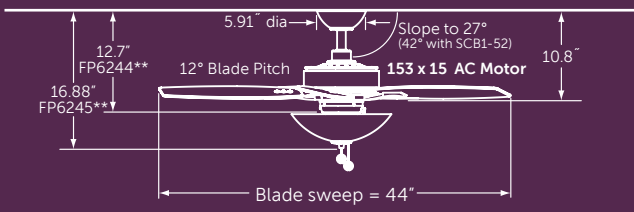

*With included 4.5" downrod—longer lengths available

FP6244** Net Hanging Weight: 14.66 lbs.
 FP6245** Net Hanging Weight: 16.64 lbs.



- FAN: FP6244BN (1)**
 brushed nickel assembly
 with reversible cherry/dark
 walnut wood blades
 - dark walnut side showing



- FAN: FP6244DZ (1)**
 dark bronze assembly with reversible
 cherry/dark walnut wood blades
 - cherry side showing



- FAN: FP6244MW (1)**
 matte white assembly with
 matte white wood blades



SOLD SEPARATELY:



control options: p.141-146
 light options: p.139-140

AIRE DELUXE™ 44



FAN: FP6245BN (1)
brushed nickel assembly
with white frosted glass
bowl and reversible cherry/
dark walnut blades

- dark walnut side showing



FAN: FP6245DZ (1)
dark bronze assembly with
white frosted glass bowl
and reversible cherry/dark
walnut blades

- cherry side showing



FAN: FP6245MW (1)
matte white assembly with
white frosted glass bowl and
matte white blades

brushed nickel	dark bronze	matte white
cherry dark walnut	cherry dark walnut	matte white
FP6244BN FP6245BN	FP6244DZ FP6245DZ	FP6244MW FP6245MW

INCLUDED:



blade set

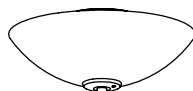

light kit—FP6245** only

FANSYNC™ compatible	(3) 13W GU24 CFL FP6245** only	3-SPEED AC reverse switch on fan	CONTROL pull chain	DRY indoor only

ENERGY INFORMATION AT HIGH SPEED:

Airflow	Electricity Use	Airflow Efficiency
FP6244** FP6245**	53 53 Watts (excluding lights)	74 75 Cubic Feet Per Minute Per Watt
3905 3937 Cubic Feet Per Minute		



LIMITED LIFETIME MOTOR WARRANTY



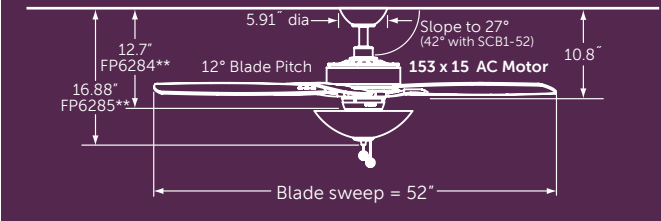

*With included 4.5" downrod—longer lengths available
 FP6284** Net Hanging Weight: 15.36 lbs.
 FP6285** Net Hanging Weight: 17.34 lbs.



FAN: FP6284BN (1)
 brushed nickel assembly
 with reversible cherry/dark
 walnut wood blades
 ● dark walnut side showing



FAN: FP6284DZ (1)
 dark bronze assembly with reversible
 cherry/dark walnut wood blades
 ● cherry side showing



FAN: FP6284MW (1)
 matte white assembly with
 matte white wood blades



SOLD SEPARATELY:

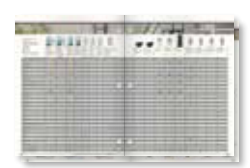

control options: p.141-146
 light options: p.139-140

AIRE DELUXE™ 52



FAN: FP6285BN (1)
brushed nickel assembly with white frosted glass bowl and reversible cherry/dark walnut blades

- dark cherry side showing



FAN: FP6285DZ (1)
dark bronze assembly with white frosted glass bowl and reversible cherry/dark walnut blades

- dark walnut side showing



FAN: FP6285MW (1)
matte white assembly with white frosted glass bowl and matte white blades



brushed nickel	dark bronze	matte white
cherry dark walnut	cherry dark walnut	matte white
FP6284BN FP6285BN	FP6284DZ FP6285DZ	FP6284MW FP6285MW

INCLUDED:



blade set

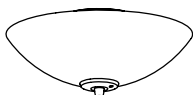

light kit—FP6285** only

FANSYNC™ compatible	(3) 13W GU24 CFL FP6285** only	3-SPEED AC reverse switch on fan	CONTROL pull chain	DRY indoor only

ENERGY INFORMATION AT HIGH SPEED:

Airflow	Electricity Use	Airflow Efficiency
FP6284** 5284	54	97
FP6285** 5279	54	97
Cubic Feet Per Minute	Watts (excluding lights)	Cubic Feet Per Minute Per Watt



LIMITED LIFETIME MOTOR WARRANTY



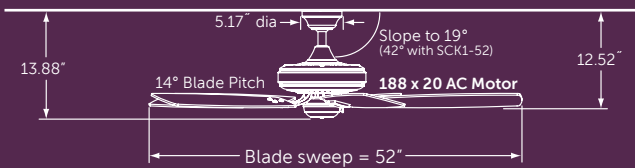

*With included 4.5" downrod—longer lengths available
Close-to-ceiling kit compatible

Net Hanging Weight: 21.19 lbs.



- FAN: TF610OB (1)**
oil-rubbed bronze assembly with reversible cherry/walnut wood blades
● walnut side showing



- FAN: TF610SN (1)**
satin nickel assembly with reversible walnut/light walnut wood blades
● walnut side showing

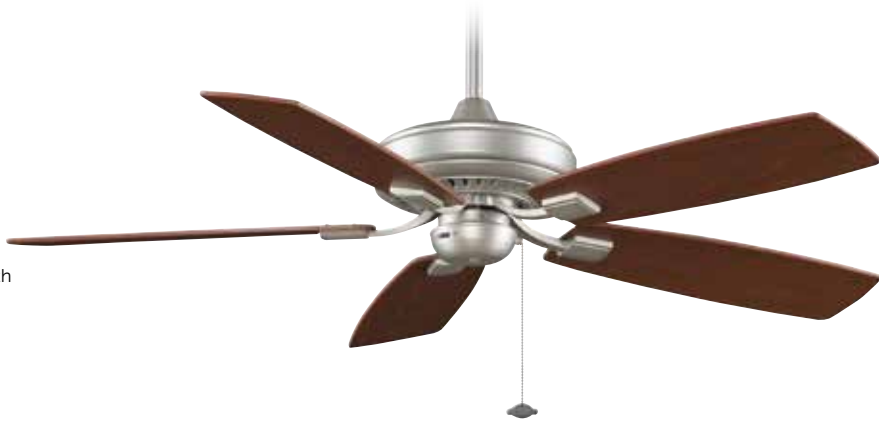

- FAN: TF610WH (1)**
white assembly with reversible white/white oak wood blades
● white side showing



SOLD SEPARATELY:



control options: p.141-146
light options: p.139-140



reversible 42" sweep
walnut/light walnut

BEW42WALW
wood

EDGEWOOD® DECORATIVE



FAN: TF610SN (1)
oil-rubbed bronze assembly with reversible cherry/walnut wood blades
• walnut side showing

oil-rubbed bronze	satin nickel	white
cherry walnut	walnut light walnut	white white oak
TF610OB	TF610SN	TF610WH

FANSYNC™
compatible

3-SPEED AC
reverse switch
on fan

CONTROL
pull chain

DRY
indoor only

INCLUDED:



blade set

ENERGY INFORMATION
AT HIGH SPEED:

Airflow
7057
Cubic Feet
Per Minute

Electricity Use
80
Watts
(excluding lights)

Airflow Efficiency
89
Cubic Feet Per
Minute Per Watt



LIMITED LIFETIME MOTOR WARRANTY



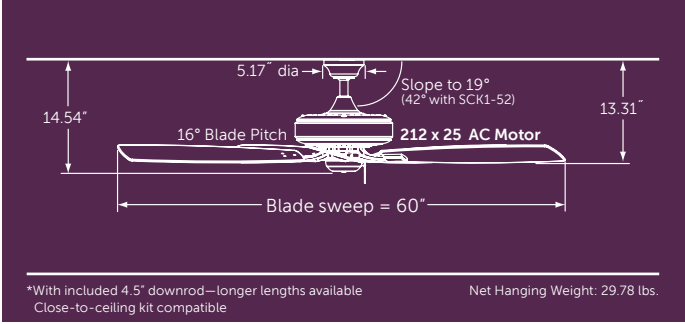

FAN: TF710OB (1)
oil-rubbed bronze
assembly with reversible
cherry/walnut wood blades
● walnut side showing



FAN: TF710SN (1)
satin nickel assembly with
reversible walnut/light
walnut wood blades
● light walnut side showing



FAN: TF710WH (1)
white assembly with
reversible white/white
oak wood blades
● white oak side showing



SOLD SEPARATELY:

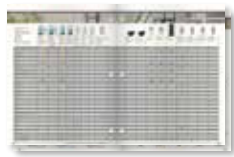

control options: p.141-146
light options: p.139-140



reversible 42" sweep
walnut/light walnut

BEW42WALW
wood

EDGEWOOD® DELUXE



FAN: TF710OB (1)
oil-rubbed bronze assembly
with reversible cherry/
walnut wood blades
• walnut side showing

oil-rubbed bronze	satin nickel	white
cherry walnut	light walnut walnut	white oak
TF710OB	TF710SN	TF710WH

INCLUDED:



blade set

ENERGY INFORMATION
AT HIGH SPEED:

FANSYNC™ compatible	3-SPEED AC reverse switch on fan	CONTROL pull chain	DRY indoor only

Airflow	Electricity Use	Airflow Efficiency
8963	84	106
Cubic Feet Per Minute	Watts (excluding lights)	Cubic Feet Per Minute Per Watt



LIMITED LIFETIME MOTOR WARRANTY



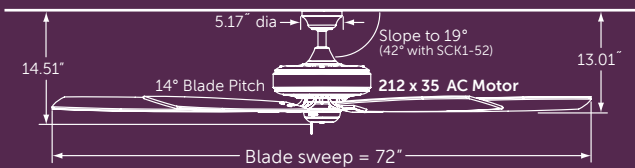

*With included 4.5" downrod—longer lengths available
Close-to-ceiling kit compatible

Net Hanging Weight: 37.92 lbs.



- FAN: TF721OB (1)**
- oil-rubbed bronze assembly with reversible cherry/walnut wood blades
- cherry side showing



- FAN: TF721WH (1)**
- white assembly with reversible white/white oak wood blades
- white side showing

SOLD SEPARATELY:



control options: p.141-146
light options: p.139-140

EDGEWOOD[®] SUPREME



FAN: TF721OB (1)
oil-rubbed bronze
assembly with
reversible cherry/
walnut wood blades
● walnut side showing

oil-rubbed bronze	white
cherry walnut	white oak
TF721OB	TF721WH

INCLUDED:



blade set

ENERGY INFORMATION AT HIGH SPEED:

FANSYNC™ compatible	3-SPEED AC reverse switch on fan	CONTROL pull chain	DRY indoor only
Airflow	Electricity Use	Airflow Efficiency	
9689	90	107	
Cubic Feet Per Minute	Watts (excluding lights)	Cubic Feet Per Minute Per Watt	



LIMITED LIFETIME MOTOR WARRANTY





For dimensions and configurations, please see our comprehensive Specification Book or model-specific specification sheet, available at fanimation.com

Not recommended for use in sound sensitive areas.

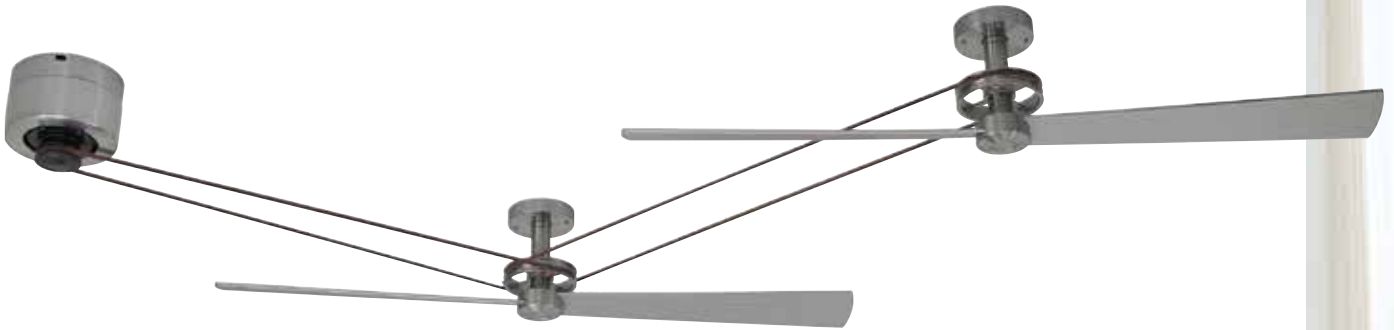

- ◆ **MOTOR: MA7966BN** (1)
brushed nickel
- HEAD: HA7966BN** (2)
brushed nickel assembly
- BLADE SET: B7966BN** (2)
brushed nickel

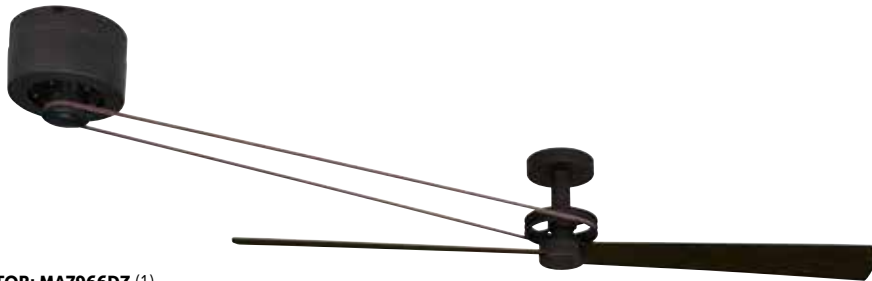

- ◆ **MOTOR: MA7966DZ** (1)
dark bronze
- HEAD: HA7966DZ** (1)
dark bronze assembly
- BLADE SET: B7966CYDWA** (1)
reversible cherry/dark walnut
- dark walnut side showing

SOLD SEPARATELY:



See page 141-146 for optional controls



BN—brushed nickel

CYDWA—cherry/dark walnut reversible

B7966**
wood



KELLAN™

- ◆ **MOTOR: MA7966BN** (1)
brushed nickel
- ◆ **HEAD: HA7966BN** (1)
brushed nickel assembly
- ◆ **BLADE SET: B7966BN** (1)
brushed nickel

brushed nickel
MA7966BN
HA7966BN

dark bronze
MA7966DZ
HA7966DZ

MIX & MATCH
components
sold separately

3-SPEED AC
reverse switch
on remote

CONTROL
remote

DRY
indoor only

INCLUDED:



TR33 control

ENERGY INFORMATION
AT HIGH SPEED:

Airflow
4659
Cubic Feet
Per Minute

Electricity Use
37
Watts
(excluding lights)

Airflow Efficiency
128
Cubic Feet Per
Minute Per Watt

LIMITED LIFETIME MOTOR WARRANTY



Due to their complex systems, multiple components and special installation requirements, we recommend contacting our Customer Service department for assistance with ordering—888.567.2055

For dimensions and configurations, please see our comprehensive Specification Book or model-specific specification sheet, available at www.fanimation.com

BOURBON STREET®

- ❖ **MOTOR: FP580BL** (1)
black (required but not shown)
- HEAD: FP510BL** (3)
black short assembly
- BLADES: FP1018** (3)
52" sweep reversible oak/walnut wood
- oak side showing

PALMETTO®

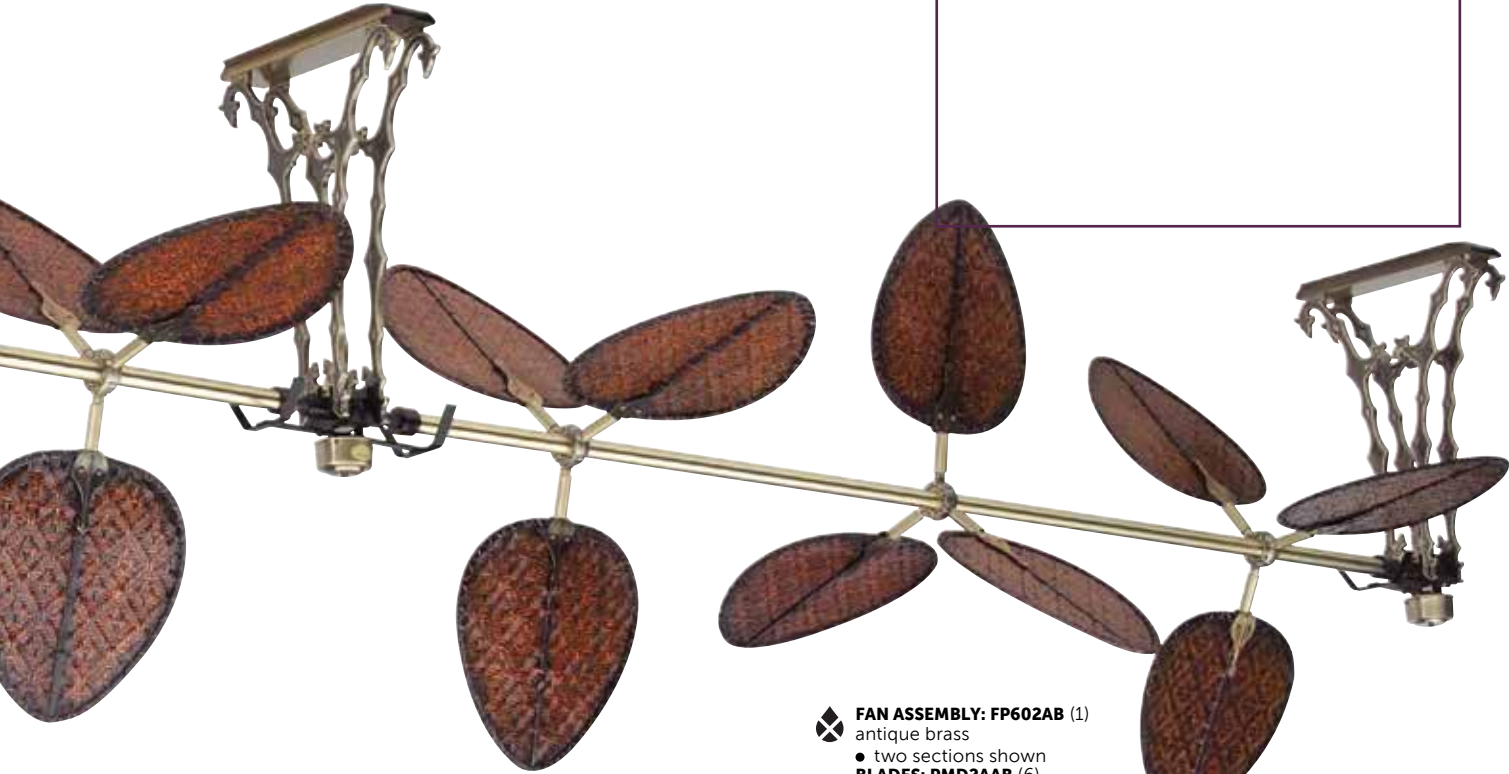

FAN ASSEMBLY: FP602AB (1)
antique brass
● two sections shown
BLADES: PMD2AAB (6)
antique brass assemblies
with antique woven
bamboo wide oval blades







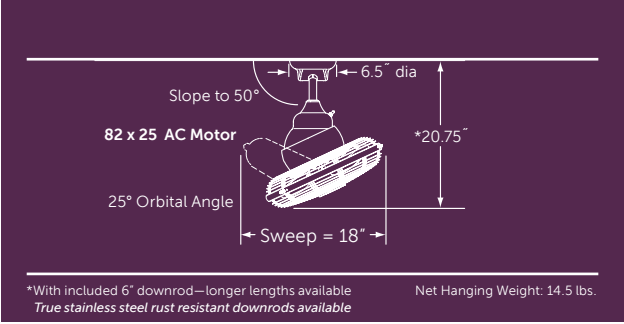

INDOOR/OUTDOOR



 **FAN: OF110BL (1)**
black assembly with black cage



 **FAN: OF110OB (1)**
oil-rubbed bronze assembly with black cage



 **FAN: OF110PW (1)**
pewter assembly with black cage



 **FAN: OF110SN (1)**
satin nickel assembly with black cage



SOLD SEPARATELY:



See page 141-146 for optional controls

EXTRAORDINAIRE™



 **FAN: OF110OB** (1)
oil-rubbed bronze
assembly with black cage

black	oil-rubbed bronze	pewter	satin nickel
black	black	black	black
OF110BL	OF110OB	OF110PW	OF110SN

INCLUDED:

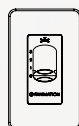

CW110WH wall control

ENERGY INFORMATION AT HIGH SPEED:

Airflow	Electricity Use	Airflow Efficiency
847	85	10
Cubic Feet Per Minute	Watts (excluding lights)	Cubic Feet Per Minute Per Watt



3-SPEED AC
no reverse



CONTROL
wall



DRY OR DAMP
model specific

LIMITED LIFETIME MOTOR WARRANTY



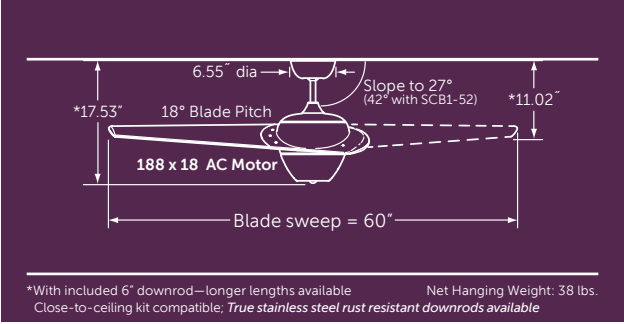

FAN: FP2120MG (1)
metro gray assembly
(shown with light cap-included)



FAN: FP2120MG (1)
metro gray assembly
(shown with light cap-included)



SOLD SEPARATELY:



See page 141-146 for
optional controls

ENIGMA™



FAN: FP2120MG (1)
metro gray assembly
(shown with light cap-included)

metro gray
metro gray
metro gray
FP2120MG

FANSYNC™
compatible

11W
E26 LED

3-SPEED AC
no reverse

CONTROL
remote

DAMP
indoor/outdoor

INCLUDED:



blade



light socket cover



TR24WH remote

ENERGY INFORMATION AT HIGH SPEED:

Airflow
5796
Cubic Feet Per Minute

Electricity Use
51
Watts
(excluding lights)

Airflow Efficiency
114
Cubic Feet Per Minute Per Watt

LIMITED LIFETIME MOTOR WARRANTY



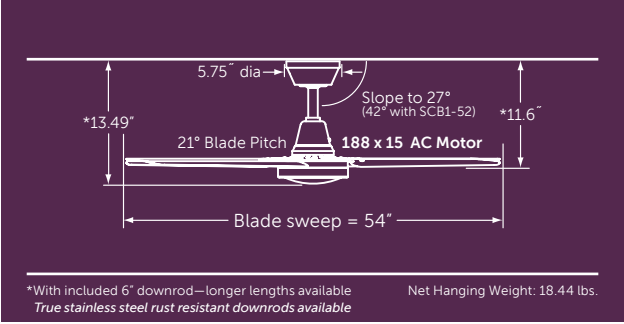

NOTE: DISTANCE FROM FLOOR TO BLADES MUST BE AT LEAST 10 FEET FOR THE ASCENSION™



FAN: FP6717BN (1)
brushed nickel assembly with
brushed nickel blades



FAN: FP6717MW (1)
matte white assembly with matte
white blades



SOLD SEPARATELY:



See page 141-146 for
optional controls

ASCENSION™



FAN: FP6717BN (1)
brushed nickel assembly with
brushed nickel blades



brushed
nickel
brushed
nickel
FP6717BN

matte
white
matte
white
FP6717MW

INCLUDED:

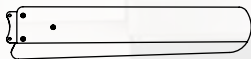

blade set



CW6717WH wall control

FANSYNC™
compatible

3-SPEED AC
reverse switch
on fan

CONTROL
wall

DAMP
indoor/outdoor

ENERGY INFORMATION AT HIGH SPEED:

Airflow
6659
Cubic Feet
Per Minute

Electricity Use
53
Watts
(excluding lights)

Airflow Efficiency
127
Cubic Feet Per
Minute Per Watt



LIMITED LIFETIME MOTOR WARRANTY



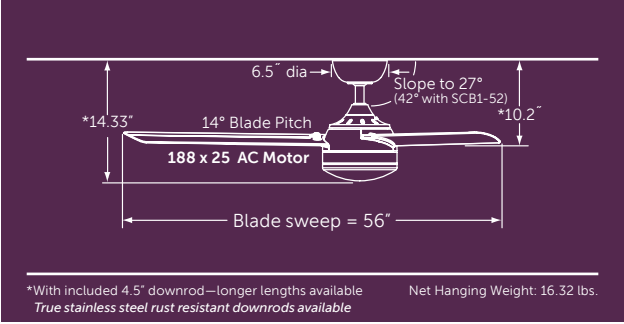

FAN: FP6728BN (1)
brushed nickel assembly with
opal frosted glass and brushed
nickel blades



FAN: FP6728DZ (1)
dark bronze assembly with opal
frosted glass and dark walnut
blades

SOLD SEPARATELY:



See page 141-146 for
optional controls

XENO™



FAN: FP6728BN (1)
brushed nickel assembly with
opal frosted glass and dark
walnut blades

brushed
nickel

FP6728BN

dark
bronze

dark
walnut

FP6728DZ

INCLUDED:

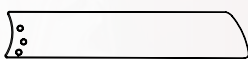

blade set



light kit



BTT9

ENERGY INFORMATION
AT HIGH SPEED:

Airflow
7236
Cubic Feet
Per Minute

Electricity Use
66
Watts
(excluding lights)

Airflow Efficiency
110
Cubic Feet Per
Minute Per Watt



FANSYNC™
included



18W
LED



3-SPEED AC
reverse switch
on fan



CONTROL
remote





DAMP
indoor/outdoor



LIMITED LIFETIME MOTOR WARRANTY

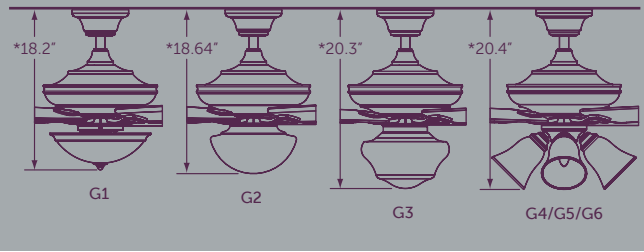
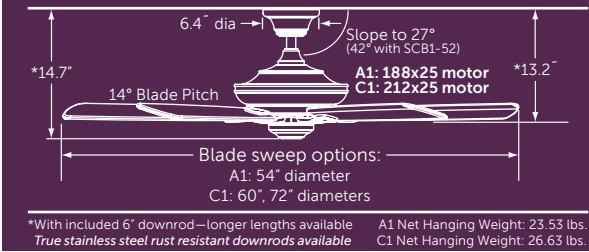





FAN: A1DZ (1)
 dark bronze assembly
BLADES: B754DWA (1)
 54" sweep dark walnut





FAN: C1BN (1)
 brushed nickel assembly
BLADES: B172DWA (1)
 72" sweep dark walnut
LIGHT FITTER: F2BN (1)
 brushed nickel globe fitter
GLASS: G3CL (1)
 clear schoolhouse glass globe
 • shown with optional vintage bulb





FAN: A1MW (1)
 matte white assembly
BLADES: B254MW (1)
 54" sweep matte white



FAN: C1DZ (1)
 dark bronze assembly
BLADES: B560DWA (1)
 60" sweep dark walnut
LIGHT FITTER: F3DZ (1)
 dark bronze LED bowl fitter
GLASS: G1MS (1)
 marble swirl glass bowl



FAN: C1MW (1)
 matte white assembly
BLADES: B460CY (1)
 60" sweep cherry
LIGHT FITTER: F4MW (1)
 matte white 4 light fitter
GLASS: G5OP (4)
 2 1/4" opal frosted



SOLD SEPARATELY:



See inside fold for blades, fitters, glass & controls

My FANIMATION

DISTINCTION™ DC

- 
FAN: D1BN (1)
 brushed nickel assembly
- BLADES: B172DWA** (1)
 72" sweep dark walnut
- LIGHT FITTER: F2BN** (1)
 brushed nickel globe fitter
- GLASS: G3CL** (1)
 clear schoolhouse glass globe
- shown with optional vintage bulb

brushed nickel
D1BN

dark bronze
D1DZ

matte white
D1MW



ENERGY SAVINGS



MIX & MATCH
components
sold separately



FAN SYNC™
included



31-SPEED DC
reverse switch
on remote



CONTROL
remote



DAMP
indoor/outdoor

INCLUDED: fanSync



TR205 control

ENERGY INFORMATION
AT HIGH SPEED:

Airflow
8800
Cubic Feet
Per Minute

Electricity Use
32
Watts
(excluding lights)

Airflow Efficiency
275
Cubic Feet Per
Minute Per Watt



LIMITED LIFETIME MOTOR WARRANTY



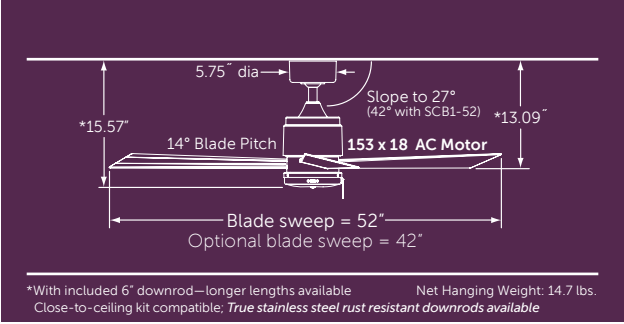

FAN: FP4640OB (1)
oil-rubbed bronze assembly with
cherry all weather composite blades

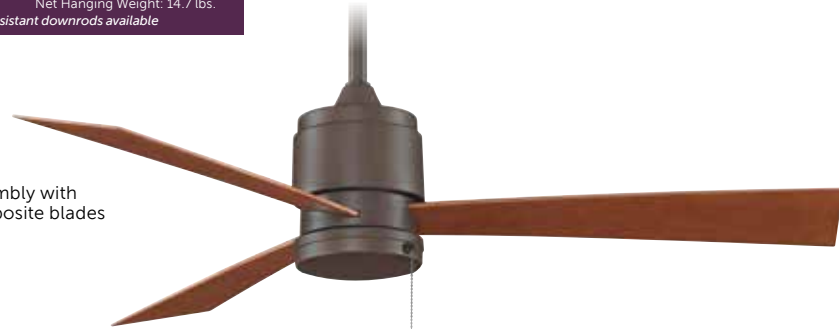

FAN: FP4640SN (1)
satin nickel assembly with satin
nickel all weather composite blades



FAN: FP4640WH (1)
white assembly with white all
weather composite blades



FAN: FP4640OB (1)
oil-rubbed bronze
assembly with cherry all
weather composite blades
LIGHT KIT: LK4640OB (1)
oil-rubbed bronze finish
18W LED light kit



SOLD SEPARATELY:



See page 141-146 for
additional control options



BPW4426**
composite



LK4640**
18W LED

use with
CW60WH



CW60WH
wall control

must be
paired
with WP60
for outdoor
application



WP60
waterproof box

My FANIMATION
 DISTINCTION™ AC

- FAN: A1MW** (1)
matte white assembly
- BLADES: B654MW** (1)
54" sweep matte white
- LIGHT FITTER: F2MW** (1)
matte white globe fitter
- GLASS: G2OP** (1)
opal frosted glass globe

brushed
nickel
A1BN
C1BN

dark
bronze
A1DZ
C1DZ

matte
white
A1MW
C1MW



FANSYNC™
included



3-SPEED AC
reverse switch
on fan



CONTROL
remote



DAMP
indoor/outdoor

INCLUDED: fanSync™



BTT9

ENERGY INFORMATION
AT HIGH SPEED:

	Airflow	Electricity Use	Airflow Efficiency
A1**	5849	77	76
C1**	8900	89	100
	Cubic Feet Per Minute	Watts (excluding lights)	Cubic Feet Per Minute Per Watt



LIMITED LIFETIME MOTOR WARRANTY



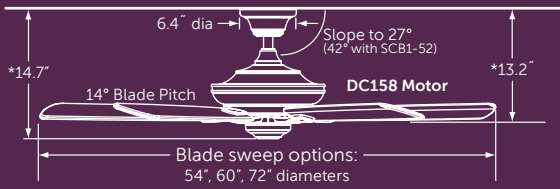

*With included 6" downrod—longer lengths available
 True stainless steel rust resistant downrods available
 Net Hanging Weight: 17.57 lbs.

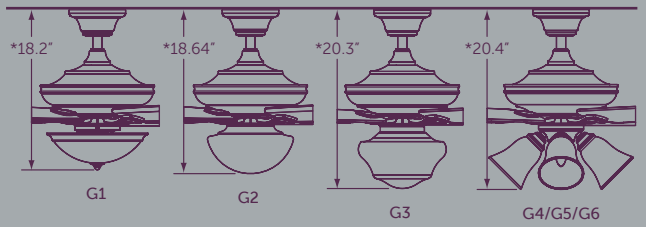

FAN: D1DZ (1)
 dark bronze assembly
BLADES: B360CY (1)
 60" sweep cherry



FAN: D1BN (1)
 brushed nickel assembly
BLADES: B260DWA (1)
 60" sweep dark walnut
LIGHT FITTER: F4BN (1)
 brushed nickel 4 light fitter
GLASS: G4OPS (4)
 2 3/4" opal frosted shiny



FAN: D1MW (1)
 matte white assembly
BLADES: B654MW (1)
 54" sweep matte white
LIGHT FITTER: F2MW (1)
 matte white globe fitter
GLASS: G2OP (1)
 opal frosted glass globe



FAN: D1DZ (1)
 dark bronze assembly
BLADES: B154CY (1)
 54" sweep cherry
LIGHT FITTER: F1DZ (1)
 dark bronze bowl fitter
GLASS: G1TST (1)
 tea stain glass bowl



FAN: D1BN (1)
 brushed nickel assembly
BLADES: B860MW (1)
 60" sweep matte white



SOLD SEPARATELY:



See inside fold for blades,
 fitters, glass & controls

my FANIMATION
DISTINCTION™

40+ YEARS OF DESIGNING AND
ENGINEERING CEILING FANS



Tom Frampton, Founder and CEO of Fanimation knows ceiling fans. While a junior in high school, Tom went to work for a fan design and manufacturing company, gaining experience in most departments and learning every facet of the business. Fast forward over forty years and enter the myFanimation™ collection. Distinction, the first introduction under the collection, is defined by its clean design and advanced technology. The myFanimation™ collection is a culmination of his life's commitment to transforming the ceiling fan as we know it.

Two hanger balls: _____

- Standard—slope to 19°
- Offset—slope to 32°

Tri-mount system: _____

- Downrod straight
- Downrod slope
- Motor-to-canopy snugger

Outer canopy trim _____
ring hides screws



DAMP
indoor/outdoor
(including blades
and accessories)

Fan Shield™: _____

- Rubber grommets attach to the hub*
- The isolation ring system prevents noise and vibration from traveling from the motor through the blade holders and blades
- System is fail-safe and serviceable

No unsightly center screw _____

*Utility patent pending



myFanimation fans include fanSync™ smart device controls

AC: 3-SPEED INFINITE LIGHT FAN DIRECTION FAN TIMER SAFE EXIT
AC control via fanSync app only AC control via fanSync app only

DC: 31-SPEED INFINITE LIGHT FAN DIRECTION FAN TIMER FRESH AIR
 HOME AWAY SAFE EXIT

Unique features			
	FAN TIMER	Sets timer for fan & light to turn off (max 6 hours)	
	HOME AWAY	Light turns on and off at set intervals to simulate someone being home.	
	FRESH AIR	Variable fan speeds simulate a natural breeze.	
	SAFE EXIT	Fan & light will turn off after one minute to allow for safe exit	

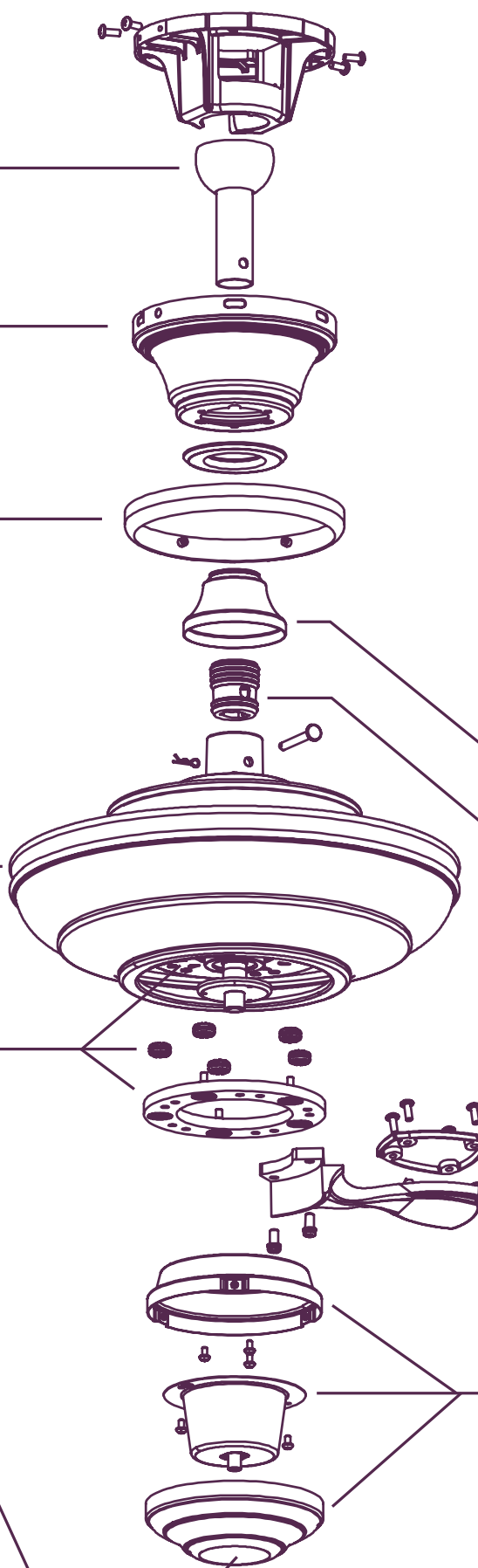

Decorative cover hides top support

Hang Right™:

- Rubber boot mounts in-between the down rod and top support*
- The downrod mounts perfectly straight and snug in the top support and does not offset or sit at angle from securing old style set screws
- No top support sets screws to loosen and vibrate
- The downrods mount faster onto the motor and without tools
- Less motor vibration travelling up the downrod and into the ceiling

Recessed screw holes in blade holder top piece hide screws from visibility

Switch cup cover hides screws

SIMPLE PART NUMBERING SYSTEM:

1. Motor: **A, C or D**

Example: **A1BN**

myFanimation motor finish code

2. Blades: **B**

Example: **B160WA**

myFanimation blade finish blade style sweep code

3. Fitter: **F**

Example: **F1DZ**

myFanimation fitter style finish code

4. Glass: **G**

Example: **G2CL**

myFanimation finish glass style code

1. Motors



A1 (188 x 25)

BN | DZ | MW

ENERGY INFORMATION

at High Speed*

Airflow	Electricity Use	Airflow Efficiency
5,849	77	76
Cubic Feet Per Minute	Watts (excluding lights)	Cubic Feet Per Minute Per Watt

*tested using B154 blade set

Order with 54" sweep blade sets only



C1 (212 x 25)

BN | DZ | MW

ENERGY INFORMATION

at High Speed*

Airflow	Electricity Use	Airflow Efficiency
8,900	89	100
Cubic Feet Per Minute	Watts (excluding lights)	Cubic Feet Per Minute Per Watt

*tested using B172 blade set

Order with 60" or 72" sweep blade sets only



D1 (DC158)

BN | DZ | MW

ENERGY INFORMATION

at High Speed*

Airflow	Electricity Use	Airflow Efficiency
8,800	32	275
Cubic Feet Per Minute	Watts (excluding lights)	Cubic Feet Per Minute Per Watt

*tested using B172 blade set

Order with 54", 60" or 72" sweep blade sets

Finish Codes

Motors:

BN	brushed nickel
DZ	dark bronze
MW	matte white

Blades:

CY	cherry
CYN	cherry with natural inlay
DC	dark cherry
DWA	dark walnut
MW	matte white
WA	walnut
WADWA	walnut with dark walnut inlay
WE	weathered wood

Light Kits:

BN	brushed nickel
DZ	dark bronze
MW	matte white

Glass:

CL	clear
FW	frosted white
MS	marble swirl
OP	opal frosted
OPS	opal frosted shiny
TST	tea stained





2. Blades









	B1			B2			B3			B4			B5		B6		B7		B8	
	54"	60"	72"	54"	60"	72"	54"	60"	72"	54"	60"	72"	54"	60"	54"	60"	54"	60"	54"	60"
CY	Ⓢ	Ⓢ	Ⓢ	Ⓢ	Ⓢ	Ⓢ	Ⓢ	Ⓢ	Ⓢ											
CYN										Ⓢ	Ⓢ	Ⓢ								
DC																			Ⓢ	Ⓢ
DWA	Ⓢ	Ⓢ	Ⓢ	Ⓢ	Ⓢ	Ⓢ	Ⓢ	Ⓢ	Ⓢ				Ⓢ	Ⓢ	Ⓢ	Ⓢ	Ⓢ	Ⓢ	Ⓢ	Ⓢ
MW	Ⓢ	Ⓢ	Ⓢ	Ⓢ	Ⓢ	Ⓢ	Ⓢ	Ⓢ	Ⓢ				Ⓢ	Ⓢ	Ⓢ	Ⓢ			Ⓢ	Ⓢ
WA	Ⓢ	Ⓢ	Ⓢ	Ⓢ	Ⓢ	Ⓢ	Ⓢ	Ⓢ	Ⓢ											
WADWA										Ⓢ	Ⓢ	Ⓢ								
WE	Ⓢ	Ⓢ	Ⓢ																	

my FANIMATION DISTINCTION™

3. Fitters

 <p>(3) 60W Candelabra</p>			 <p>23W CFL vintage bulb compatible</p>			 <p>16W LED</p>			 <p>(4) 40W Candelabra</p>		
F1			F2			F3			F4*		
BN	DZ	MW	BN	DZ	MW	BN	DZ	MW	BN	DZ	MW

4. Glass

																	
	G1			G2	G3		G1			G4	G5		G6				
CL					☒					☒			☒				
MS	☒						☒										
OP				☒	☒						☒		☒				
OPS					☒					☒							
TST	☒			☒			☒			☒	☒		☒				

*Additional glass available on page ____

5. Controls



For use with A1 and C1 motors		For use with D1 motor	
BTT9R —included	C25 —sold separately	TR205 —included	TW206 —sold separately
White hand-held remote control with wall mount	White wall control with wall plate	White hand-held remote control with wall mount	White wall control with wall plate

ZONIX™ WET



FAN: FP4640OB(1)
oil rubbed bronze assembly with cherry all weather composite blades

oil-rubbed bronze

satin nickel

white

cherry

satin nickel

white

FP4640OB

FP4640SN

FP4640WH

INCLUDED:



blade set

ENERGY INFORMATION AT HIGH SPEED:



FANSYNC™ compatible

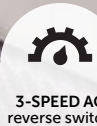

3-SPEED AC reverse switch on fan



CONTROL pull chain



WET indoor/outdoor

Airflow

5432

Cubic Feet Per Minute

Electricity Use

57

Watts (excluding lights)

Airflow Efficiency

96

Cubic Feet Per Minute Per Watt



LIMITED LIFETIME MOTOR WARRANTY



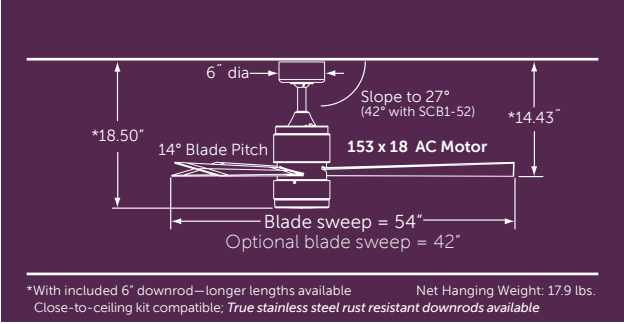

FAN: FP4650BN (1)
brushed nickel assembly with
brushed nickel blades and
opal frosted glass



FAN: FP4650DCP (1)
dark copper penny assembly with
dark walnut blades and
opal frosted glass



FAN: FP4650OB (1)
oil-rubbed bronze assembly
with walnut blades and
opal frosted glass



SOLD SEPARATELY:



See page 141-146 for
optional controls

SN—satin nickel

B4400SN
wood

CWR—cherry/walnut
reversible

SN—satin nickel

B4442**
wood

CY—cherry

WA—walnut

BPW4426**
composite

CY—cherry

SN—satin nickel

WA—walnut

BPW4442**
composite

ZONIX™ LED

FAN: FP4650BN(1)
brushed nickel assembly with
brushed nickel blades and
opal frosted glass

brushed
nickel

dark copper
penny

oil-rubbed
bronze

brushed
nickel

dark walnut

walnut

FP4650BN

FP4650DCP

FP4650OB

INCLUDED:

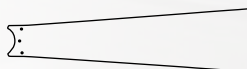

blade set



light kit



TR24WH remote

ENERGY INFORMATION AT HIGH SPEED:



FANSYNC™
compatible



16W
LED



3-SPEED AC
reverse switch
on fan



CONTROL
remote



DAMP
indoor/outdoor

Airflow
4436
Cubic Feet
Per Minute

Electricity Use
57
Watts
(excluding lights)

Airflow Efficiency
78
Cubic Feet Per
Minute Per Watt

LIMITED LIFETIME MOTOR WARRANTY



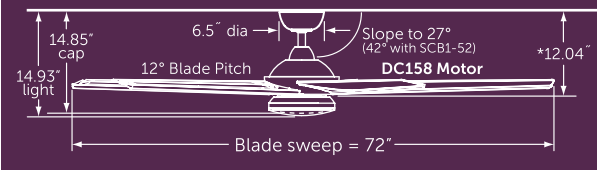

*With included 6" downrod—longer lengths available
 True stainless steel rust resistant downrods available
 Net Hanging Weight: 26.5 lbs.



FAN: FPD6236BN (1)
 brushed nickel assembly
 with bourbon blades and
 opal frosted glass



FAN: FPD6236DZ (1)
 dark bronze assembly
 with bourbon blades
 and matching dark
 bronze cap (included)

Special features

 FAN TIMER	Sets timer for fan & light to turn off (max 6 hours)	 HOME AWAY	Light turns on and off at set intervals to simulate someone being home.
 FRESH AIR	Variable fan speeds simulate a natural breeze.	 SAFE EXIT	Fan & light will turn off after one minute to allow for safe exit

SOLD SEPARATELY:



See page 141-146 for optional controls

SUBTLE™



FAN: FPD6236DZ (1)
dark bronze assembly with bourbon blades and opal frosted glass

brushed nickel

dark bronze

bourbon

bourbon

FPD6236BN

FPD6236DZ



ENERGY SAVINGS



FANSYNC™ included



18W LED



31-SPEED DC reverse switch on remote



CONTROL remote



DAMP indoor/outdoor

INCLUDED:



blade set



light kit



light cover



TR205 remote

ENERGY INFORMATION AT HIGH SPEED:

Airflow

6802

Cubic Feet Per Minute

Electricity Use

41

Watts (excluding lights)

Airflow Efficiency

168

Cubic Feet Per Minute Per Watt



LIMITED LIFETIME MOTOR WARRANTY



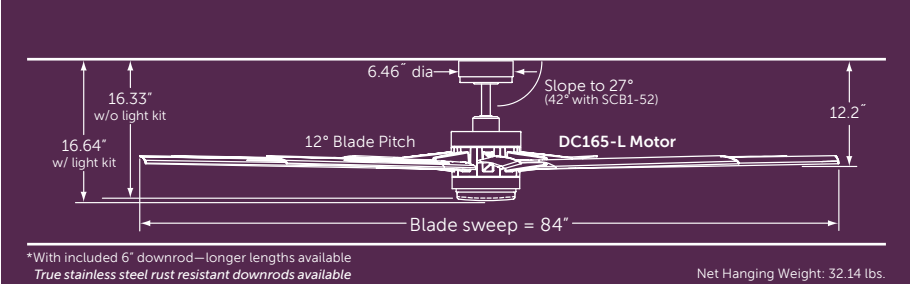

FAN: FP8149BNWBL (1)
brushed nickel assembly
with black blades and opal
frosted glass



FAN: FPD8149BNWBN (1)
brushed nickel assembly with
brushed nickel blades and matching
brushed nickel light cover (included)



FAN: FPD8149DZW (1)
dark bronze assembly with
dark walnut blades and opal
frosted glass



FAN: FPD8149GRW (1)
matte greige assembly with weathered
wood blades and matching matte
greige light cover (included)



FAN: FPD8149MWW (1)
matte white assembly with
matte white blades and opal
frosted glass

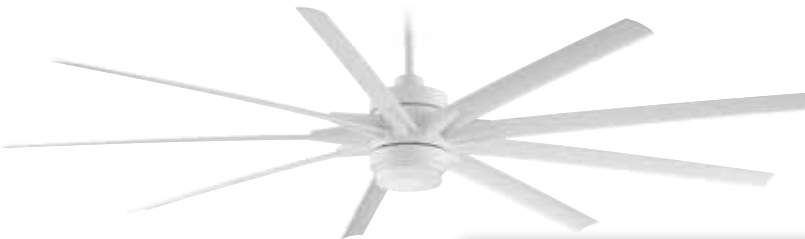

SOLD SEPARATELY:



See page 141-146 for
optional controls

ODYN™



FAN: FPD8149GRW (1)
matte greige assembly with weathered wood blades and opal frosted glass

brushed nickel	brushed nickel	dark bronze	matte greige	matte white
black	brushed nickel	dark walnut	weathered wood	matte white
FPD8149BNWBL	FPD8149BNWBN	FPD8149DZW	FPD8149GRW	FPD8149MWW

- ENERGY SAVINGS
- 18W LED
- 6-SPEED DC reverse switch on remote
- CONTROL remote
- WET indoor/outdoor

INCLUDED:

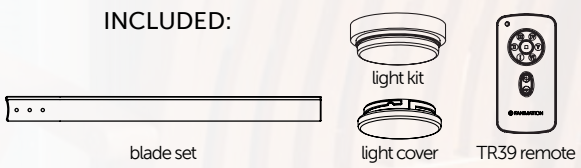

ENERGY INFORMATION AT HIGH SPEED:

Airflow	Electricity Use	Airflow Efficiency
11,190	32	348
Cubic Feet Per Minute	Watts (excluding lights)	Cubic Feet Per Minute Per Watt



LIMITED LIFETIME MOTOR WARRANTY



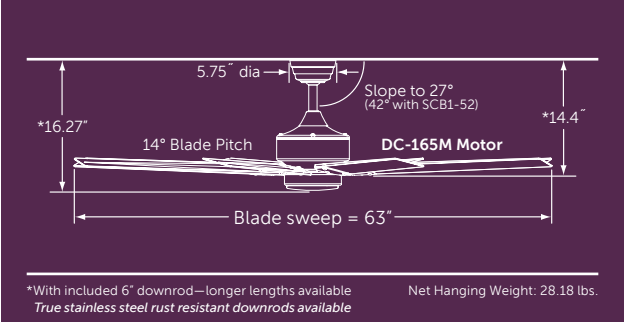

FAN: FPD7916BN (1)
brushed nickel assembly
with brushed nickel blades
and opal frosted glass



FAN: FPD7916DZ (1)
dark bronze assembly with
dark walnut blades and
opal frosted glass

SOLD SEPARATELY:



See page 141-146 for
optional controls

LEVON™ DC



FAN: FPD7916BN (1)
brushed nickel assembly
with brushed nickel blades
and opal frosted glass

brushed
nickel

dark
bronze

brushed
nickel

dark
walnut

FPD7916BN

FPD7916DZ

INCLUDED:

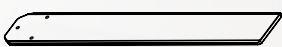

blade set



light kit



TR39 remote

ENERGY INFORMATION
AT HIGH SPEED:

Airflow
7817
Cubic Feet
Per Minute

Electricity Use
34
Watts
(excluding lights)

Airflow Efficiency
230
Cubic Feet Per
Minute Per Watt

ENERGY SAVINGS

18W
LED

6-SPEED DC
reverse switch
on remote

CONTROL
remote

DAMP
indoor/outdoor



LIMITED LIFETIME MOTOR WARRANTY



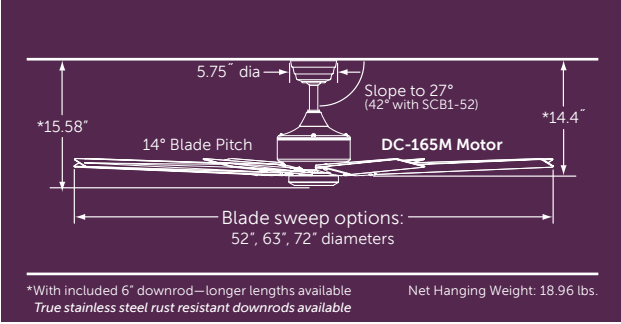

FAN: MAD7912BN (1)
brushed nickel assembly
BLADES: B7913BN (1)
72" sweep brushed nickel
buttonwood
LIGHT KIT: LK7912BN (1)
18W dimmable LED



FAN: MAD7912DZ (1)
dark bronze assembly
BLADES: B7913CYWA (1)
72" sweep cherry/walnut
reversible buttonwood
● cherry side showing



FAN: MAD7912MW (1)
matte white assembly
BLADES: B7912N (1)
63" sweep natural buttonwood



FAN: MAD7912DZ (1)
dark bronze assembly
BLADES: B7914CYWA (1)
52" sweep cherry/walnut
reversible buttonwood
● walnut side showing



SOLD SEPARATELY:



See page 141-146 for optional controls

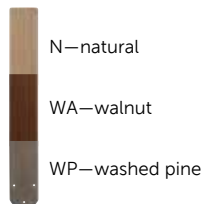

B7912**
buttonwood

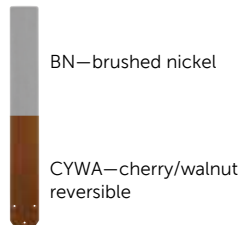

B7913**
buttonwood

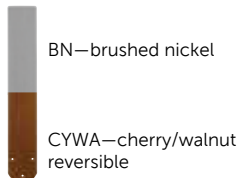

B7914**
buttonwood

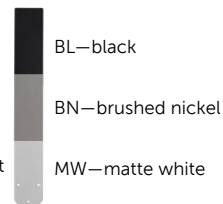

BPW7912**
composite







LK7912**
18W LED

LEVON™ CUSTOM



 **FAN: MAD7912MW** (1)
 matte white assembly
BLADES: B7913CYWA (1)
 72" sweep reversible cherry/walnut
 ● walnut side showing
LIGHT KIT: LK7912MW (1)
 18W dimmable LED

brushed nickel	dark bronze	matte white
MAD7912BN	MAD7912DZ	MAD7912MW

-  **ENERGY SAVINGS**
-  **MIX & MATCH**
components
sold separately
-  **6-SPEED DC**
reverse switch
on remote
-  **CONTROL**
remote
-  **DAMP**
indoor/outdoor

INCLUDED:



TR39 remote

ENERGY INFORMATION AT HIGH SPEED:

Airflow measured with
BPW9712** blades

Airflow
7695
 Cubic Feet
 Per Minute

Electricity Use
34
 Watts
 (excluding lights)

Airflow Efficiency
226
 Cubic Feet Per
 Minute Per Watt



LIMITED LIFETIME MOTOR WARRANTY



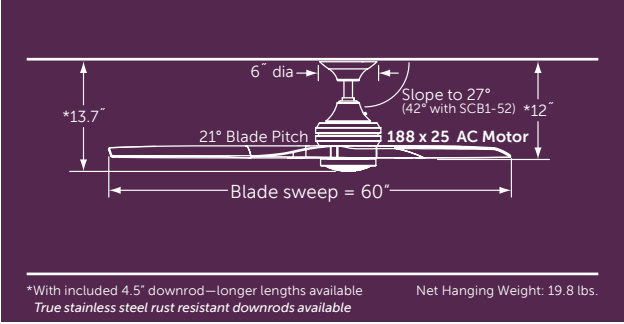

FAN: MA6721BN (1)
brushed nickel assembly
BLADES: B6720BN (1)
brushed nickel finish buttonwood



FAN: MA6721BS (1)
brushed satin assembly
BLADES: B6720WK (1)
whiskey wood finish buttonwood



FAN: MA6721DF (1)
driftwood assembly
BLADES: B6720DF (1)
driftwood finish buttonwood



FAN: MA6721DZ (1)
dark bronze assembly
BLADES: B6720N (1)
natural finish buttonwood



FAN: MA6721GR (1)
matte greige assembly
BLADES: B6720WE (1)
weathered wood finish buttonwood



SOLD SEPARATELY:



See page 141-146 for optional controls



B6720** button wood

- BN—brushed nickel
- DF—driftwood
- DWA—dark walnut
- N—natural
- WE—weathered wood
- WK—whiskey wood







LK6721** 18W LED

SPITFIRE™



FAN: MA6721DZ (1)
dark bronze assembly
BLADES: B6720N (1)
natural finish buttonwood
LIGHT KIT: LK6721DZ (1)
dark bronze with frosted fresnel glass

- 
MA6721BN
- 
MA6721BS
- 
MA6721DF
- 
MA6721DZ
- 
MA6721GR

- 
FANSYNC™
included
- 
MIX & MATCH
components
sold separately
- 
3-SPEED AC
reverse switch
on fan
- 
CONTROL
remote
- 
DAMP
indoor/outdoor

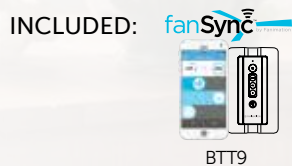

ENERGY INFORMATION AT HIGH SPEED:

Airflow	Electricity Use	Airflow Efficiency
6641	61	108
Cubic Feet Per Minute	Watts (excluding lights)	Cubic Feet Per Minute Per Watt



LIMITED LIFETIME MOTOR WARRANTY



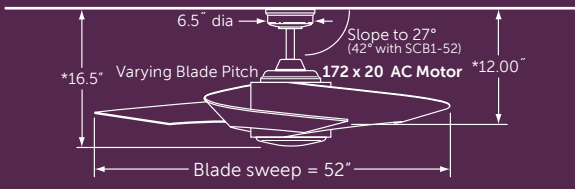

*With included 6" downrod—longer lengths available Net Hanging Weight: 27.4 lbs.
Close-to-ceiling kit compatible; True stainless steel rust resistant downrods available

NOTE: AIRFLOW MOVES OUTWARD AT AN ANGLE INSTEAD OF DIRECTLY DOWNWARD

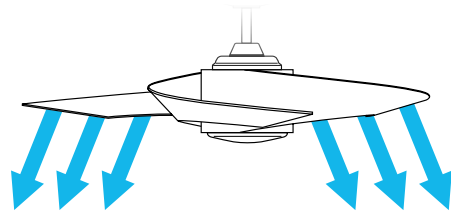

FAN: FP7900BL (1)
black assembly with
opal frosted glass



FAN: FP7900MG (1)
metro gray assembly
with opal frosted glass



FAN: FP7900MW (1)
matte white assembly
with opal frosted glass



FAN: FP7900OB (1)
oil-rubbed bronze assembly
with opal frosted glass



SOLD SEPARATELY:



See page 141-146 for
optional controls

TORTO™

FAN: FP7900BL (1)
black assembly with
opal frosted glass

black	metro gray	matte white	oil-rubbed bronze
black	metro gray	matte white	oil-rubbed bronze
FP7900BL	FP7900MG	FP7900MW	FP7900OB

FANSYNC™
compatible

(2) 60W
incandescent
candelabra

3-SPEED AC
reverse switch
on remote

CONTROL
remote

DAMP
indoor/outdoor

INCLUDED:



blade set



light kit



TR20WH remote

ENERGY INFORMATION AT HIGH SPEED:

Airflow
4425
Cubic Feet
Per Minute

Electricity Use
80
Watts
(excluding lights)

Airflow Efficiency
56
Cubic Feet Per
Minute Per Watt

LIMITED LIFETIME MOTOR WARRANTY



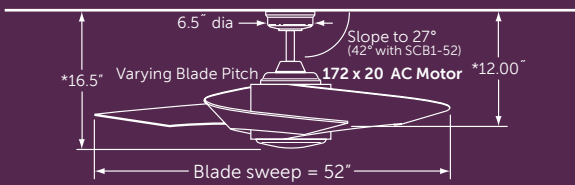

*With included 6" downrod—longer lengths available Net Hanging Weight: 27.4 lbs.
Close-to-ceiling kit compatible; *True stainless steel rust resistant downrods available*

NOTE: AIRFLOW MOVES OUTWARD AT AN ANGLE INSTEAD OF DIRECTLY DOWNWARD

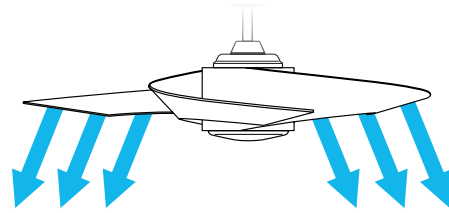

FAN: FP7902BN (1)
brushed nickel assembly with
18W LED opal frosted glass
and fanSync fan control

SOLD SEPARATELY:



See page 141-146 for
optional controls

TORTO™ LED

 **FAN: FP7902BN(1)**
brushed nickel assembly with
18W LED opal frosted glass
and fanSync fan control

brushed nickel
brushed nickel
FP7902BN



FANSYNC™
included



18W
LED



3-SPEED AC
reverse switch
on remote



CONTROL
remote



DAMP
indoor/outdoor

INCLUDED:



blade set



light kit



BTT9R

ENERGY INFORMATION AT HIGH SPEED:

Airflow
4425
Cubic Feet
Per Minute

Electricity Use
80
Watts
(excluding lights)

Airflow Efficiency
56
Cubic Feet Per
Minute Per Watt

LIMITED LIFETIME MOTOR WARRANTY



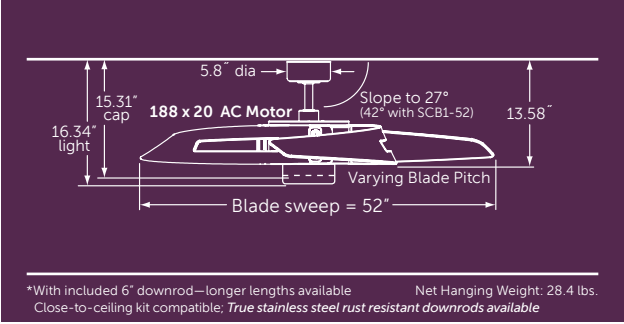

FAN: FP6210SN (1)
satin nickel assembly
with walnut blades
and opal frosted glass



FAN: FP6210OB (1)
oil-rubbed bronze assembly
with cherry blades and opal
frosted glass



FAN: FP6210OB (1)
satin nickel assembly with
walnut blades and matching
light cover (included)



SOLD SEPARATELY:







See page 141-146 for
optional controls

AVASTON™

FAN: FP6210OB (1)
oil-rubbed bronze assembly
with cherry blades and
matching light cover (included)

oil-rubbed bronze	satin nickel
cherry FP6210OB	walnut FP6210SN

-  **FANSYNC™**
compatible
-  **(2) 50W**
halogen
minican
-  **3-SPEED AC**
reverse switch
on fan
-  **CONTROL**
remote
-  **DAMP**
indoor/outdoor

INCLUDED:

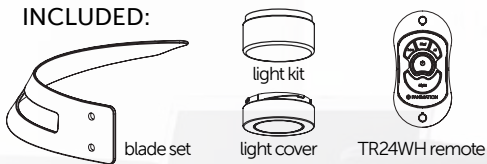

**ENERGY INFORMATION
AT HIGH SPEED:**

Airflow	Electricity Use	Airflow Efficiency
5309	73	72
Cubic Feet Per Minute	Watts (excluding lights)	Cubic Feet Per Minute Per Watt

LIMITED LIFETIME MOTOR WARRANTY



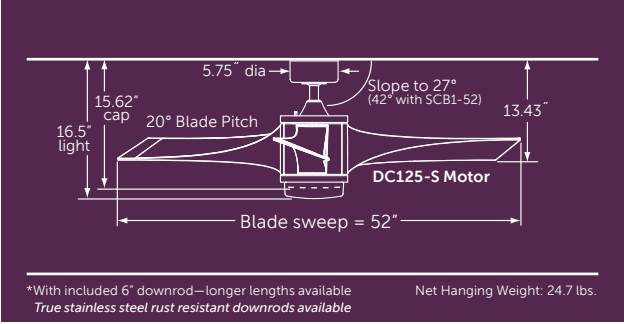

FAN: FPD7943MG (1)
metro gray assembly
with metro gray blades
and opal frosted glass



FAN: FPD7943OB (1)
oil-rubbed bronze assembly
with oil-rubbed bronze
blades and opal frosted glass



FAN: FPD7943MG (1)
metro gray assembly with
metro gray blades and
matching light cover (included)



SOLD SEPARATELY:



See page 141-146 for
optional controls

JENNIX™

FAN: FPD7943OB (1)
oil-rubbed bronze assembly with
oil-rubbed bronze blades and
matching light cover (included)

metro gray	oil-rubbed bronze
metro gray	oil-rubbed bronze
FPD7943MG	FPD7943OB

INCLUDED:

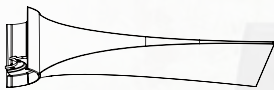

blade set



light kit



light cover



TR39 remote

**ENERGY INFORMATION
AT HIGH SPEED:**

 ENERGY SAVINGS	 (1) 100W halogen minican	 6-SPEED DC reverse switch on remote	 CONTROL remote	 DAMP indoor/outdoor
--	---	---	--	---

Airflow
5239
Cubic Feet
Per Minute

Electricity Use
30
Watts
(excluding lights)

Airflow Efficiency
178
Cubic Feet Per
Minute Per Watt

LIMITED LIFETIME MOTOR WARRANTY



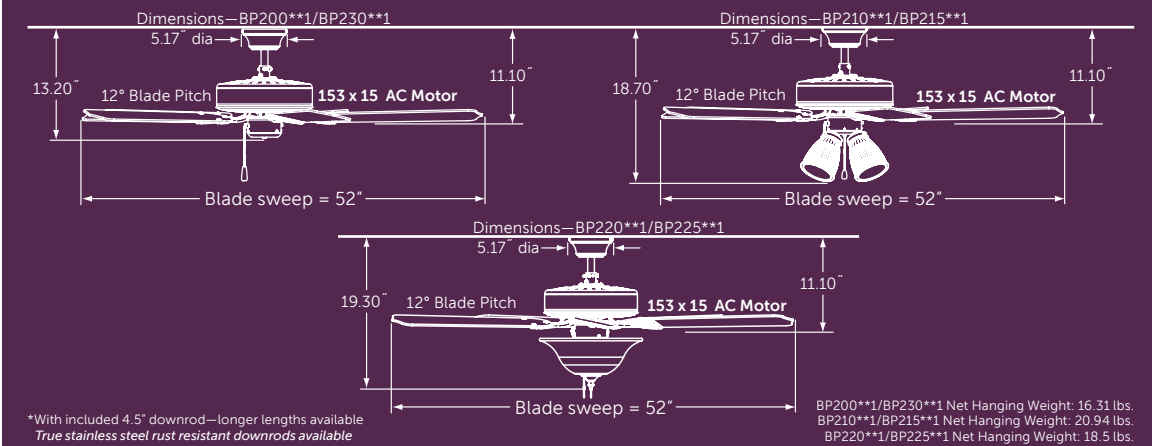

- FAN: BP200SN1 (1)**
satin nickel assembly in flush-mount configuration with reversible cherry/walnut wood blades
 - walnut side showing



- FAN: BP210MW1 (1)**
matte white assembly in downrod configuration with white frosted glass shades and matte white wood blades



- FAN: BP215OB1 (1)**
oil-rubbed bronze assembly in downrod configuration with white frosted glass shades (amber shades version available: BP210OB1) and reversible cherry/walnut wood blades
 - cherry side showing



- FAN: BP230BL1 (1)**
black assembly in downrod configuration with black blades



SOLD SEPARATELY:



control options: p.141-146
light options: p.139-140

AIRE DECOR®



FAN: BP220SN1 (1)
satin nickel assembly in
downrod configuration with
white frosted glass bowl and
reversible cherry/walnut blades
● walnut side showing



FAN: BP220MW1 (1)
matte white assembly in
downrod configuration with
white frosted glass bowl and
matte white wood blades



FAN: BP225OB1 (1)
oil-rubbed bronze assembly
in downrod configuration
with white frosted glass bowl
(amber glass version available:
BP220OB1) and cherry/walnut
reversible wood blades
● walnut side showing

black	matte white	oil-rubbed bronze	oil-rubbed bronze	satin nickel	satin nickel
black	matte white	cherry walnut	walnut	cherry walnut	cherry
BP230BL1	BP200MW1 BP210MW1 BP220MW1 BP230MW1	BP200OB1 BP210OB1 BP215OB1 BP220OB1 BP225OB1	BP230OB1	BP200SN1 BP210SN1 BP220SN1	BP230SN1

- FANSYNC™ compatible
- SEE INCLUDED incandescent candelabra
- 3-SPEED AC reverse switch on fan
- CONTROL pull chain
- DRY OR DAMP model specific

INCLUDED:



ENERGY INFORMATION AT HIGH SPEED:

Airflow	Electricity Use	Airflow Efficiency
5849	64	91
Cubic Feet Per Minute	Watts (excluding lights)	Cubic Feet Per Minute Per Watt

LIMITED LIFETIME MOTOR WARRANTY



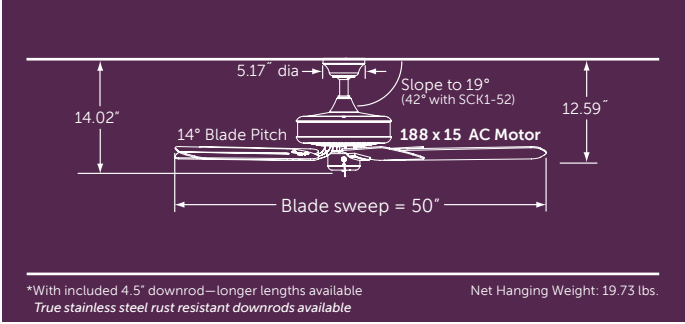

FAN: TF910AZ (1)
aged bronze assembly with
dark cherry all-weather
composite blades



FAN: TF910BL (1)
black assembly with
black all-weather
composite blades



FAN: TF910OB (1)
oil-rubbed bronze assembly
with dark cherry all-weather
composite blades



FAN: TF910WH (1)
white assembly with
white all-weather
composite blades



SOLD SEPARATELY:



control options: p.141-146
light options: p.139-140

EDGEWOOD® WET



FAN: TF910WH(1)
white assembly with all-weather composite white blades

aged bronze dark cherry TF910AZ	black black TF910BL	oil-rubbed bronze dark cherry TF910OB	white white TF910WH
--	----------------------------------	--	----------------------------------

INCLUDED:



blade set

ENERGY INFORMATION
AT HIGH SPEED:

FANSYNC™ compatible	3-SPEED AC reverse switch on fan	CONTROL pull chain	WET indoor/outdoor
Airflow 5461 Cubic Feet Per Minute	Electricity Use 54 Watts (excluding lights)	Airflow Efficiency 102 Cubic Feet Per Minute Per Watt	



LIMITED LIFETIME MOTOR WARRANTY



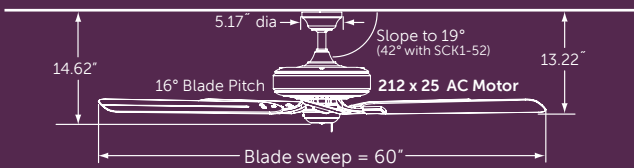

*With included 4.5" downrod—longer lengths available Net Hanging Weight: 32.1 lbs.
Close-to-ceiling kit compatible; True stainless steel rust resistant downrods available



FAN: TF971AZ (1)
aged bronze assembly with
dark cherry all-weather
composite blades



FAN: TF971OB (1)
oil-rubbed bronze assembly
with dark cherry all-weather
composite blades



FAN: TF971WH (1)
white assembly with
white all-weather
composite blades



SOLD SEPARATELY:



control options: p.141-146
light options: p.139-140



EDGEWOOD® DELUXE WET



FAN: TF971AZ (1)
aged bronze assembly with
all-weather composite
dark cherry blades

aged
bronze

TF971AZ

oil-rubbed
bronze

TF971OB

white

white

TF971WH

INCLUDED:

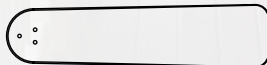

blade set

ENERGY INFORMATION
AT HIGH SPEED:

FANSYNC™
compatible

Airflow
8963
Cubic Feet
Per Minute

3-SPEED AC
reverse switch
on fan

Electricity Use
107
Watts
(excluding lights)

CONTROL
pull chain

WET
indoor/outdoor

Airflow Efficiency
84
Cubic Feet Per
Minute Per Watt



LIMITED LIFETIME MOTOR WARRANTY



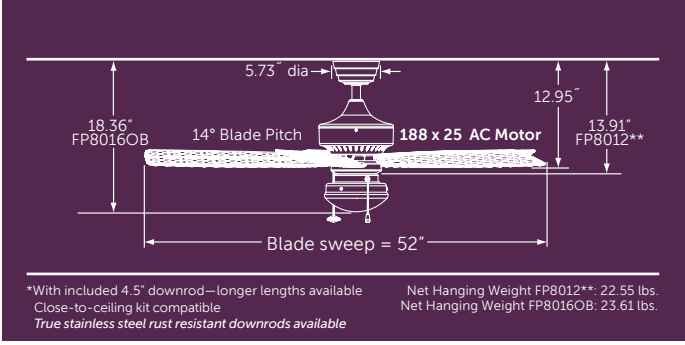

FAN: FP8012OB (1)
oil-rubbed bronze assembly with all-weather composite antique woven bamboo blades



FAN: FP8012WH (1)
white assembly with all-weather composite white woven bamboo blades

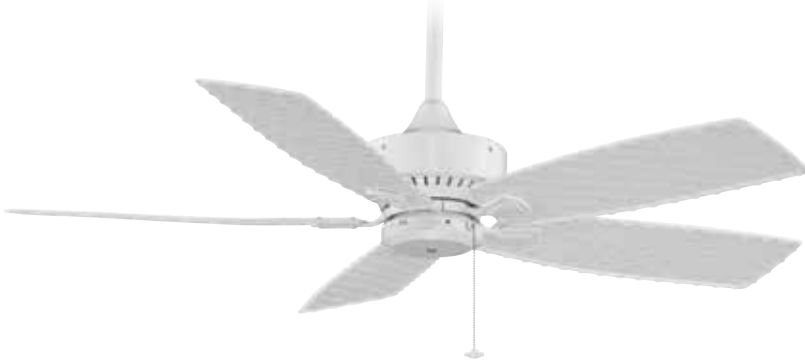

FAN: FP8016OB (1)
oil-rubbed bronze assembly with frosted white low profile light kit and all-weather composite antique woven bamboo blades



SOLD SEPARATELY:



control options: p.141-146
light options: p.139-140

CANCUN™ WET

FAN: FP8016OB (1)
oil-rubbed bronze assembly with frosted white low profile light kit and all-weather composite antique woven bamboo blades

oil-rubbed bronze
antique bamboo

**FP8012OB
FP8016OB**

white
white bamboo

FP8012WH

INCLUDED:



blade set



light kit—FP8016OB only



FANSYNC™ compatible



(2) 75W halogen minican
FP8016OB



3-SPEED AC reverse switch on fan



CONTROL pull chain



WET indoor/outdoor

ENERGY INFORMATION AT HIGH SPEED:

Airflow
5715
Cubic Feet Per Minute

Electricity Use
70
Watts (excluding lights)

Airflow Efficiency
82
Cubic Feet Per Minute Per Watt

FP8012** only



LIMITED LIFETIME MOTOR WARRANTY



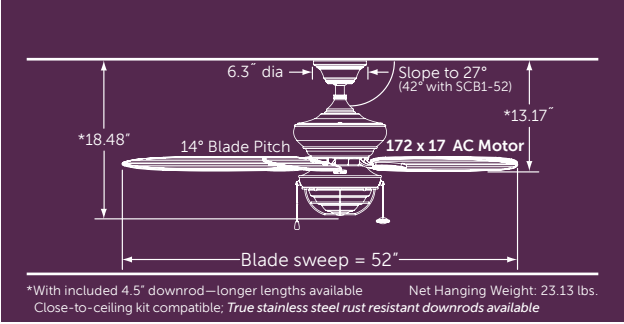

FAN: FP7963RS (1)
rust assembly with
cherry bronze blades
and opal frosted glass



SOLD SEPARATELY:



See page 141-146 for
optional controls

KAYA™

FAN: FP7963RS (1)
rust assembly with
cherry bronze blades
and opal frosted glass

rust
cherry
bronze
FP7963RS

FANSYNC™
compatible



(1) 26W
GU24 CFL

3-SPEED AC
reverse switch
on fan

CONTROL
pull chain

WET
indoor/outdoor

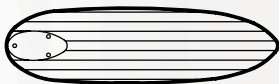
INCLUDED:



blade set



light kit

**ENERGY INFORMATION
AT HIGH SPEED:**

Airflow
4995
Cubic Feet
Per Minute

Electricity Use
65
Watts
(excluding lights)

Airflow Efficiency
77
Cubic Feet Per
Minute Per Watt

LIMITED LIFETIME MOTOR WARRANTY



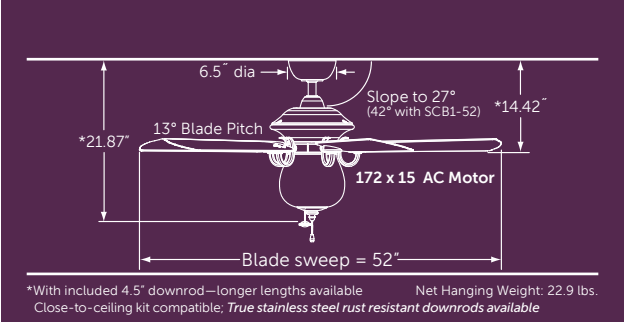

FAN: FP7954OB (1)
oil-rubbed bronze assembly with seeded glass light kit and reversible cherry/walnut composite blades

- cherry side showing



FAN: FP7954OB (1)
oil-rubbed bronze assembly with seeded glass light kit and reversible cherry/walnut composite blades

- walnut side showing

SOLD SEPARATELY:



See page 141-146 for optional controls

CRESTFORD™

FAN: FP7954OB (1)
oil-rubbed bronze assembly
with seeded glass light kit
and reversible cherry/walnut
composite blades
• cherry side showing

oil-rubbed
bronze
cherry/walnut
FP7954OB

FANSYNC™
compatible



(3) 40W
incandescent
candelabra

3-SPEED AC
reverse switch
on fan

CONTROL
pull chain

WET
indoor/outdoor

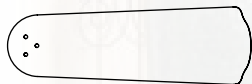
INCLUDED:



blade set



light kit

**ENERGY INFORMATION
AT HIGH SPEED:**

Airflow
5803
Cubic Feet
Per Minute

Electricity Use
59
Watts
(excluding lights)

Airflow Efficiency
99
Cubic Feet Per
Minute Per Watt

LIMITED LIFETIME MOTOR WARRANTY



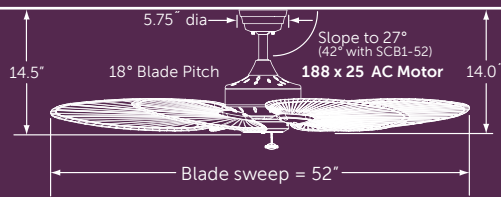

*With included 6" downrod—longer lengths available
 Close-to-ceiling kit compatible
 True stainless steel rust resistant downrods available

FP7500AB Net Hanging Weight: 23.84 lbs.
 FP7500MW Net Hanging Weight: 26.66 lbs.
 FP7500OBP4 Net Hanging Weight: 29.87 lbs.
 FP7500RS Net Hanging Weight: 25.41 lbs.

FAN: FP7500AB (1)
 52" sweep antique brass assembly
 with natural palm narrow oval blades



FAN: FP7500MW (1)
 52" sweep matte white assembly
 with natural palm narrow oval blades



FAN: FP7500OBP4 (1)
 52" sweep oil-rubbed bronze
 assembly with all weather composite
 red/brown narrow oval palm blades



FAN: FP7500RS (1)
 52" sweep rust assembly with antique
 woven bamboo narrow oval blades



SOLD SEPARATELY:



control options: p.141-146
 light options: p.139-140

WINDPOINTE®



FAN: FP7500AB (1)
52" sweep antique brass assembly with natural narrow oval palm blades

antique brass natural palm FP7500AB	matte white natural palm FP7500MW	oil-rubbed bronze red/brown palm FP7500BP4	rust antique bamboo FP7500RS
---	---	--	------------------------------------

FANSYNC™
compatible

3-SPEED AC
reverse switch
on fan

CONTROL
pull chain

DRY OR DAMP
model specific

INCLUDED:



blade set

ENERGY INFORMATION
AT HIGH SPEED:

	Airflow	Electricity Use	Airflow Efficiency
FP7500AB	2633	42	63
FP7500MW	2812	42	67
FP7500BP4	4054	50	81
FP7500RS	2551	42	60
	Cubic Feet Per Minute	Watts (excluding lights)	Cubic Feet Per Minute Per Watt

LIMITED LIFETIME MOTOR WARRANTY



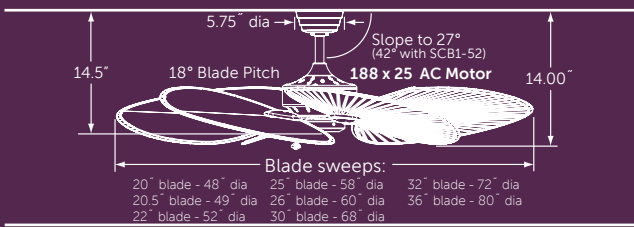

*With included 6" downrod—longer lengths available Net Hanging Weight: 24.87 lbs.
Close-to-ceiling kit compatible; True stainless steel rust resistant downrods available

FAN: MA7500AB (1)
antique brass assembly
BLADES: B5340WA (1)
52" sweep walnut carved wood



FAN: MA7500MW (1)
matte white assembly
BLADES: BPW6090DNA (1)
60" sweep all-weather composite dark natural accent narrow palm



FAN: MA7500OB (1)
oil-rubbed bronze assembly
BLADES: BPW20CY (1)
48" sweep all-weather composite cherry
LIGHT KIT: LKLP102OB (1)
opal frosted glass low profile
CLOSE TO CEILING KIT: CCK8002OB (1)
oil-rubbed bronze



FAN: MA7500PW (1)
pewter assembly
BLADES: ISD1A (1)
52" sweep antique wide oval woven bamboo

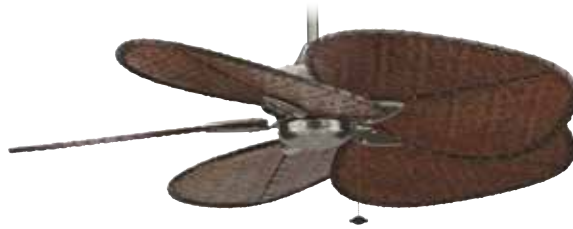

FAN: MA7500RS (1)
rust assembly
BLADES: B5280WA (1)
52" sweep walnut wide oval leaf carved wood



SOLD SEPARATELY:



blade options: p.149-150
control options: p.141-146
light options: p.139-140

WINDPOINTE® CUSTOM

FAN: MA7500MW (1)
matte white assembly
BLADES: BPW6090DNA (1)
60" sweep all-weather
composite dark natural
accent narrow palm

antique
brass

MA7500AB

matte
white

MA7500MW

oil-rubbed
bronze

MA7500OB

pewter

MA7500PW

rust

MA7500RS



FANSYNC™
compatible

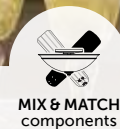

MIX & MATCH
components
sold separately

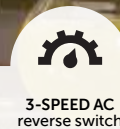

3-SPEED AC
reverse switch
on fan



CONTROL
pull chain



DRY OR DAMP
model specific

ENERGY INFORMATION AT HIGH SPEED:

Airflow measured with
B5280WA blades

Airflow

4649

Cubic Feet
Per Minute

Electricity Use

46

Watts
(excluding lights)

Airflow Efficiency

101

Cubic Feet Per
Minute Per Watt

LIMITED LIFETIME MOTOR WARRANTY



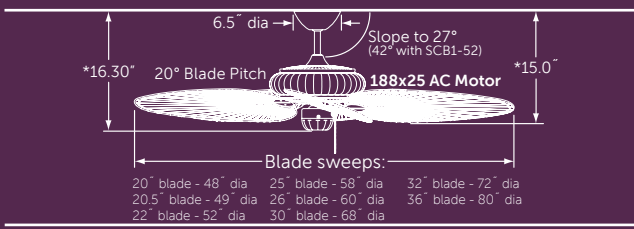

*With included 6" downrod—longer lengths available Net Hanging Weight: 25.0 lbs.
Close-to-ceiling kit compatible; True stainless steel rust resistant downrods available

FAN: FP4320AZ1 (1)
aged bronze assembly
BLADES: BPD4A (1)
52" sweep all-weather
composite antique woven
bamboo narrow oval



FAN: FP4320MW1 (1)
matte white assembly
BLADES: BPP4TN (1)
52" sweep natural palm
finish narrow oval all-
weather composite



FAN: FP4320TB1 (1)
textured black assembly
BLADES: BPP4BR (1)
52" sweep brown/red palm
narrow oval all-weather
composite



FAN: FP4320TS1 (1)
tortoise shell assembly
BLADES: B5340WA (1)
52" sweep walnut
carved wood



SOLD SEPARATELY:



blade options: p.149-150
control options: p.141-146
light options: p.139-140

BELLERIA®

FAN: FP4320AZ1 (1)
 aged bronze assembly
BLADES: BPW6090DNA (1)
 60" sweep all-weather composite
 dark natural accent narrow palm

aged bronze

FP4320AZ1

matte white

FP4320MW1

textured black

FP4320TB1

tortoise shell

FP4320TS1



FANSYNC™ compatible



MIX & MATCH components sold separately



3-SPEED AC reverse switch on fan



CONTROL pull chain



DRY or WET blade finish specific

ENERGY INFORMATION AT HIGH SPEED:

Airflow measured with BPW6090DNA blades

Airflow

5217

Cubic Feet Per Minute

Electricity Use

68

Watts (excluding lights)

Airflow Efficiency

77

Cubic Feet Per Minute Per Watt

LIMITED LIFETIME MOTOR WARRANTY



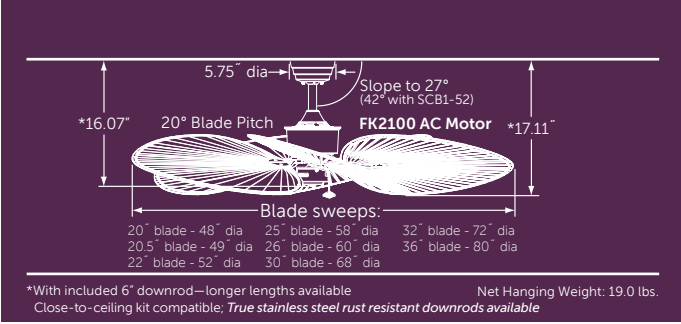

FAN: FP320AB1 (1)
antique brass assembly
BLADES: ISP1 (1)
52" sweep natural palm leaf wide oval

FAN: FP320OB1 (1)
oil-rubbed bronze assembly
BLADES: BPW20CY (1)
48" sweep all-weather composite cherry

FAN: FP320PW1 (1)
pewter assembly
BLADES: B5133TKMH (1)
52" sweep reversible teak/
mahogany wood blades
● teak side showing

FAN: FP320RS1 (1)
rust assembly
BLADES: ISD1A (1)
52" sweep antique wide oval
woven bamboo

FAN: FP320SN1 (1)
satin nickel assembly
BLADES: ISD1A (1)
52" sweep antique wide oval woven
bamboo



SOLD SEPARATELY:



blade options: p.149-150
control options: p.141-146
light options: p.139-140

ISLANDER® AC

 **FAN: FP320RS1** (1)
 rust assembly
BLADE SET: ISP1 (1)
 52" sweep natural palm
 leaf wide oval

antique brass

FP320AB1

oil-rubbed
bronze

FP320OB1

pewter

FP320PW1

rust

FP320RS1

satin
nickel

FP320SN1



FANSYNC™
compatible



MIX & MATCH
components
sold separately



3-SPEED AC
reverse switch
on fan



CONTROL
pull chain



DRY OR DAMP
model specific

ENERGY INFORMATION AT HIGH SPEED:

Airflow measured with
BPD4A blades

Airflow

4010

Cubic Feet
Per Minute

Electricity Use

85

Watts
(excluding lights)

Airflow Efficiency

47

Cubic Feet Per
Minute Per Watt

LIMITED LIFETIME MOTOR WARRANTY



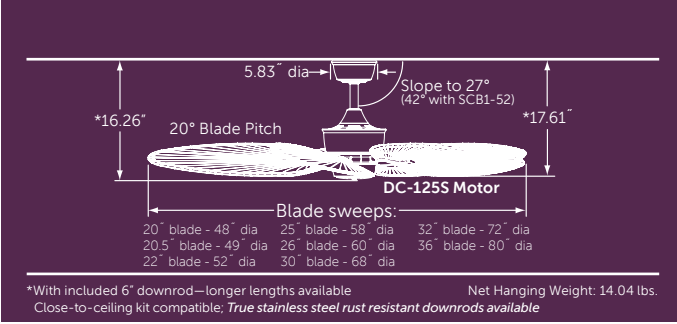

FAN: MAD3250AB (1)
antique brass assembly
BLADES: ISP1 (1)
52" sweep natural palm leaf wide oval
FITTER: F423AB (1)
antique brass bowl fitter
GLASS: G439 (1)
hand-painted parrot bowl



FAN: MAD3250BA (1)
bronze accent assembly
BLADES: ISP4 (1)
52" sweep natural palm leaf
narrow oval



FAN: MAD3250OB (1)
oil-rubbed bronze assembly
BLADES: BPW6090DNA (1)
60" sweep dark natural accent
narrow palm all-weather
composite



FAN: MAD3250PW (1)
pewter assembly
BLADES: ISD1A (1)
52" sweep antique woven bamboo
wide oval
FITTER: F423PW (1)
pewter bowl fitter
GLASS: G450 (1)
amber glass bowl

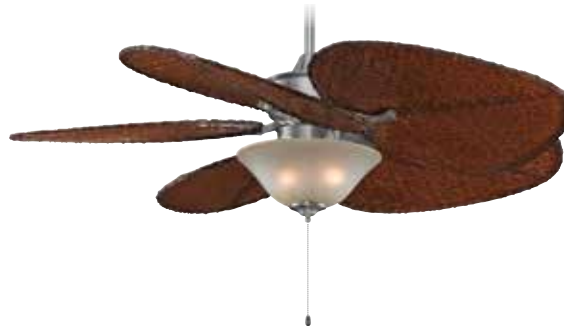

FAN: MAD3250RS (1)
rust assembly
BLADES: BPD4A (1)
52" sweep antique narrow oval
composite woven bamboo



SOLD SEPARATELY:



blade options: p.149-150
control options: p.141-146
light options: p.139-140

ISLANDER® DC



FAN: MAD3250OB (1)
oil-rubbed bronze assembly
BLADE SET: ISD4A (1)
antique narrow oval woven
bamboo

antique
brass

bronze
accent

oil-rubbed
bronze

pewter

rust

MAD3250AB MAD3250BA MAD3250OB MAD3250PW MAD3250RS



ENERGY SAVINGS



MIX & MATCH
components
sold separately



6-SPEED DC
reverse switch
on remote



CONTROL
remote



DRY OR DAMP
model specific

INCLUDED:



TR39 remote

ENERGY INFORMATION AT HIGH SPEED:

Airflow measured with
BPW6090DNA blades

Airflow

5020

Cubic Feet
Per Minute

Electricity Use

30

Watts
(excluding lights)

Airflow Efficiency

153

Cubic Feet Per
Minute Per Watt



LIMITED LIFETIME MOTOR WARRANTY



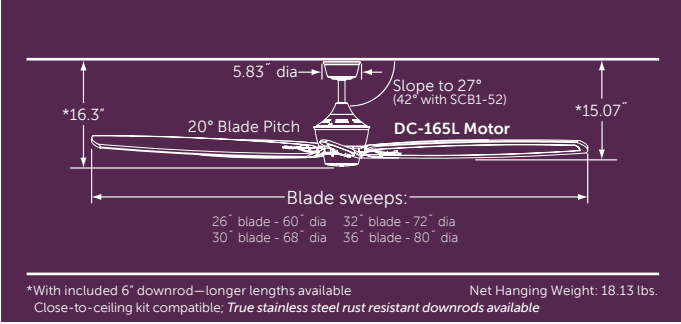

FAN: MAD3252AB (1)
antique brass assembly
BLADES: B6841DWA (1)
80" sweep dark walnut carved wood



FAN: MAD3252BN (1)
brushed nickel assembly
BLADES: B6801DWA (1)
80" sweep dark walnut carved wood



FAN: MAD3252OB (1)
oil-rubbed bronze assembly
BLADES: B6831WA (1)
80" sweep walnut carved wood

SOLD SEPARATELY:



additional blade options: p.149-150
control options: p.141-146
light options: p.139-140





 BPW6000** composite	 CY—cherry  MH—mahogany  MW—matte white  TK—teak	 WA—walnut B5300** wood	 CY—cherry DWA—dark walnut B6801** wood	 WA—walnut B6831** wood	 DWA—dark walnut B6841** wood
--	---	--	---	--	--

BIG ISLAND™



FAN: MAD3252OB (1)
oil-rubbed bronze assembly
BLADES: B6831WA (1)
80° sweep walnut carved wood

- antique
brass
MAD3252AB
- brushed
nickel
MAD3252BN
- oil-rubbed
bronze
MAD3252OB

- 
ENERGY SAVINGS
- 
MIX & MATCH
 components
 sold separately
- 
6-SPEED DC
 reverse switch
 on remote
- 
CONTROL
 remote
- 
DRY OR DAMP
 model specific

INCLUDED:



TR39 remote

ENERGY INFORMATION
AT HIGH SPEED:
 Airflow measured with
 BPW6000** blades

Airflow	Electricity Use	Airflow Efficiency
10082	32	318
Cubic Feet Per Minute	Watts (excluding lights)	Cubic Feet Per Minute Per Watt



LIMITED LIFETIME MOTOR WARRANTY



For dimensions and configurations, please see our comprehensive Specification Book or model-specific specification sheet, available at fanimation.com

- FAN: FP420AB** (1)
antique brass tall assembly
- BLADE SET: FP1018** (1)
50" sweep reversible oak/walnut wood blades
 - oak side showing



- FAN: FP410BL** (1)
black short assembly
- BLADE SET: BPP4TN** (1)
52" sweep natural finish narrow oval all-weather composite palm blades



SOLD SEPARATELY:



blade options: p.149-150
control options: p.141-146
light options: p.139-140

AMERICANA®

- ◆ **FAN: FP410AB** (1)
antique brass short assembly
- ◆ **BLADE SET: FP1018** (1)
50" sweep reversible oak/
walnut wood blades
 - oak side showing

antique
brass

FP410AB
FP420AB

black

FP410BL
FP420BL



MIX & MATCH
components
sold separately



3-SPEED AC
reverse switch
on fan



CONTROL
pull chain



DRY OR DAMP
model specific

LIMITED LIFETIME MOTOR WARRANTY



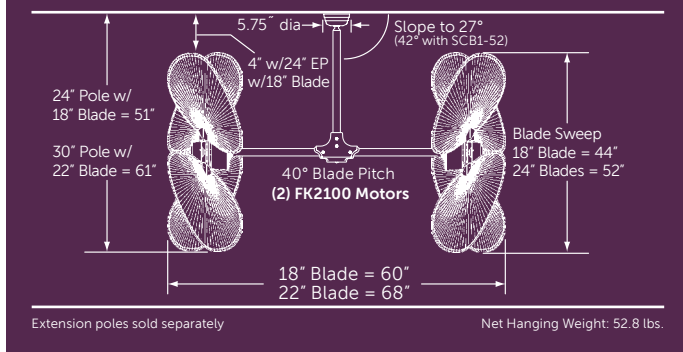

FAN: FP240OB (1)
oil-rubbed bronze assembly
EXTENSION POLE: EP30OB (1)
30" oil-rubbed bronze
BLADES: PAD1A (1)
52" sweep antique wide oval woven bamboo

FAN: FP240PW (1)
pewter assembly
EXTENSION POLE: EP30PW (1)
30" pewter
BLADES: PAD1C (1)
52" sweep clear wide oval woven bamboo
ACCESSORY: P48 (1)
monkey

FAN: FP240RS (1)
rust assembly
EXTENSION POLE: EP30RS (1)
30" rust
BLADES: PAD1A (1)
52" sweep antique wide oval woven bamboo
FILIGREE: FLRS (1)
rust

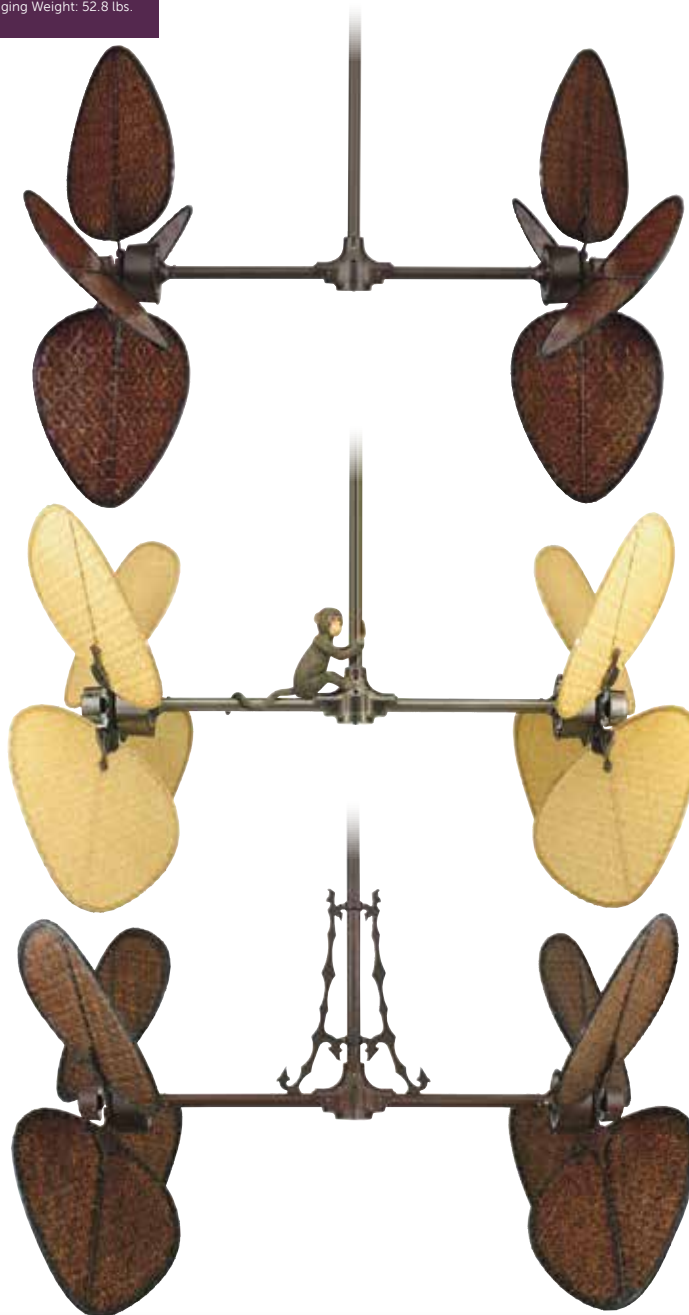

SOLD SEPARATELY:



additional blade options: p.149-150
control options: p.141-146
light options: p.139-140

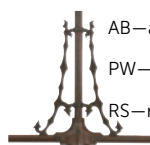

FL**
filigree

AB—antique brass
PW—pewter
RS—rust



P48
monkey



B5080CP
cairo purple



B5080SS
samble sand



B5213WA
walnut

PALISADE®

FAN: FP240OB (1)
oil-rubbed bronze assembly
EXTENSION POLE: EP48OB (1)
48" oil-rubbed bronze
BLADES: B5080CP (1)
52" sweep cairo purple wood

oil-rubbed
bronze
FP240OB

pewter
FP240PW

rust
FP240RS

MIX & MATCH
components
sold separately

3-SPEED AC
reverse switch
on fans

CONTROL
wall

DRY OR DAMP
model specific

INCLUDED:



CW3WH wall control

LIMITED LIFETIME MOTOR WARRANTY



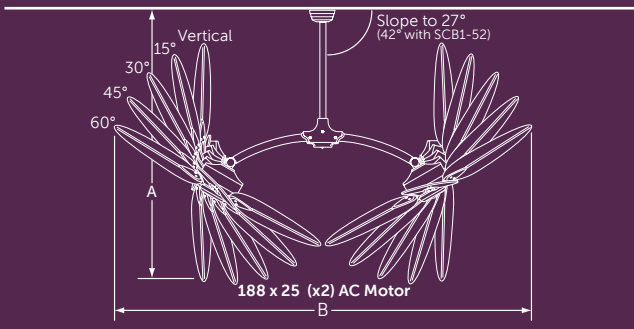

24" downrod included—longer lengths available
 True stainless steel rust resistant downrods available

Net Hanging Weight: 60 lbs.

Motor Tilt Angle	44" Sweep Blades		49" Sweep Blades		52" Sweep Blades	
	Dim. A w/24" DR	Dim. B w/24" DR	Dim. A w/24" DR	Dim. B w/24" DR	Dim. A w/24" DR	Dim. B w/24" DR
Vertical	54.5"	56.5"	56.5"	56.5"	58.5"	56.5"
15°	55.0"	63.5"	58.0"	64.5"	59.0"	65.5"
30°	54.5"	73.0"	56.0"	75.0"	58.0"	77.0"
45°	52.5"	80.5"	54.0"	83.0"	55.0"	86.0"
60°	49.0"	85.0"	50.0"	88.5"	*51.0"	*92.0"

FAN: FP7000OB (1)
 oil-rubbed bronze assembly
 (motor heads at 30°)
BLADES: CABPP4BR (1)
 52" sweep bronze/red all-weather
 composite oval palm



FAN: FP7000OB (1)
 oil-rubbed bronze assembly
 (motor heads vertical)
BLADES: CAISD2A (1)
 44" sweep antique wide
 oval woven bamboo



SOLD SEPARATELY:



additional blade options: p.149-150
 control options: p.141-146
 light options: p.139-140



B5213WA
 walnut

CARUSO™

❖ **FAN: FP7000OB** (1)
oil-rubbed bronze
assembly
BLADES: B5213WA (1)
52" sweep walnut
carved wood

oil-rubbed
bronze
FP7000OB

MIX & MATCH
components
sold separately

3-SPEED AC
reverse switch
on fans

CONTROL
wall

DRY OR DAMP
model specific

INCLUDED:



CW3WH-CA wall control

LIMITED LIFETIME MOTOR WARRANTY



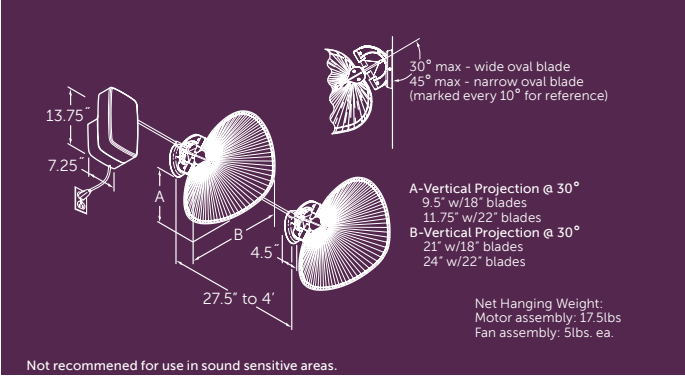

MOTOR: FP780AB (1)
antique brass assembly
FAN ASSEMBLIES: FP720AB (4)
antique brass
BLADES: PUP1 (4)
22" natural palm leaf wide oval



MOTOR: FP780PW (1)
pewter assembly
FAN ASSEMBLIES: FP720PW (6)
pewter
BLADES: PUD1A (6)
22" antique woven bamboo wide oval



MOTOR: FP780RS (1)
rust assembly
FAN ASSEMBLIES: FP720RS (4)
rust
BLADES: PUD1A (4)
22" antique woven bamboo wide oval



SOLD SEPARATELY:



See page 149-150 for blade options

PUNKAH®

 **MOTOR:** FP780PW (1)
pewter assembly
FAN ASSEMBLIES: FP720PW (5)
pewter
BLADES: PUP1 (5)
22" natural palm leaf wide oval

antique
brass
FP780AB
FP720AB

pewter
FP780PW
FP720PW

rust
FP780RS
FP720RS

POWER CORD
2' cord



MIX & MATCH
components
sold separately

1-SPEED AC
no reverse

DRY OR DAMP
model specific

LIMITED LIFETIME MOTOR WARRANTY

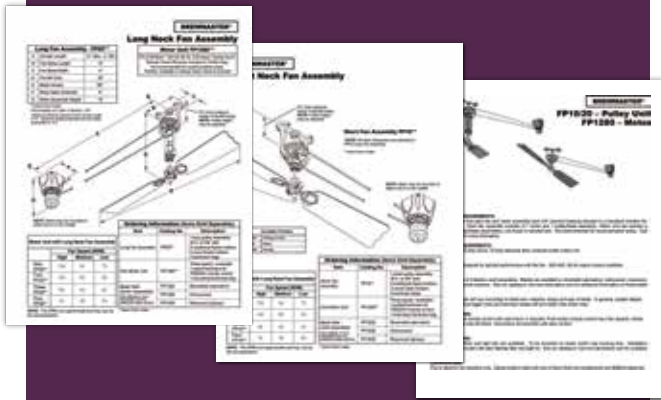



For dimensions and configurations, please see our comprehensive Specification Book or model-specific specification sheet, available at fanimation.com

Not recommended for use in sound sensitive areas.



The Brewmaster® carries on Fanimation's reputation for reproducing unusual, yet functional, belt-drive fans. These fans were originally produced in the late 1800s by Snediker & Carr®, the premier belt-drive fan manufacturer of their day. Fanimation has adapted this timeless masterpiece to install and operate with more ease and durability.

- Neoprene belting replaces the high-maintenance leather belts.
- Lead and copper babbitt sleeves have given way to sealed ball bearings.
- Hardwood laminate blades that resist warping and splitting replace the temperamental solid wood blades.

The Brewmaster® combines the latest technology with several blade options including the original oversized wood blade design. The Brewmaster® is powered by a gearless direct drive motor, and allows you to operate one or two fans.

- ❖ **MOTOR: FP1280AB** (1)
antique brass assembly
- HEAD: FP10AB** (2)
antique brass short neck assembly
- BLADE SET: BMP1** (2)
50" sweep natural finish wide oval palm

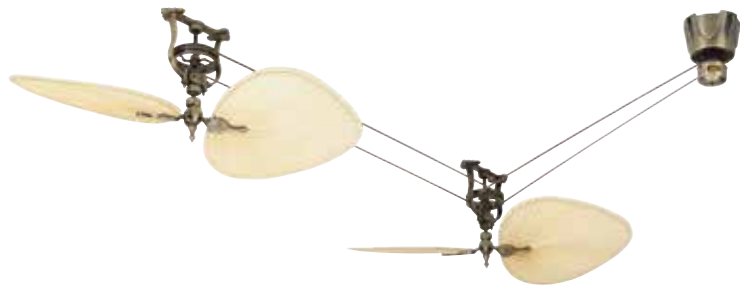

- 🔹 **MOTOR: FP1280BL** (1)
black assembly (required but not shown)
- HEAD: FP20BL** (1)
black long neck assembly
- BLADE SET: BMD4A** (1)
50" sweep narrow oval woven bamboo



- ❖ **MOTOR: FP1280PW** (1)
pewter assembly (required but not shown)
- HEAD: FP10PW** (1)
pewter short neck assembly
- BLADE SET: FP1030** (1)
26" sweep rosewood



SOLD SEPARATELY:



additional blade options: p.149-150
control options: p.141-146
light options: p.139-140



reversible oak/walnut

FP1022
wood ❖



cherry

FP1026
wood ❖



rosewood

FP1030
wood ❖

BREWMASTER™





-  **MOTOR: FP1280BL** (1)
black assembly (required but not shown)
- HEAD: FP20BL** (1)
black long neck assembly
- BLADE SET: FP1026** (1)
25" cherry

antique brass	black	pewter
FP1280AB FP10AB FP20AB	FP1280BL FP10BL FP20BL	FP1280PW FP10PW FP20PW

INCLUDED:



TR20WH control

- 
MIX & MATCH
components
sold separately
- 
3-SPEED AC
reverse switch
on remote
- 
CONTROL
remote
- 
DRY OR DAMP
model specific

FAN SPEED (RPM):	Fan Assemblies	High	Medium	Low
One		127	100	82
Two		106	60	46
Three		89	46	35
Four		76	38	28

LIMITED LIFETIME MOTOR WARRANTY







PORTABLES



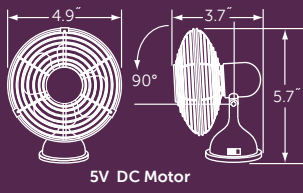

Net Weight: 1.1 lbs.

FAN: FP6252BN (1)
brushed nickel assembly with
brushed nickel fan blades and
brushed nickel cage



FAN: FP6252BN (1)
brushed nickel assembly with
brushed nickel fan blades and
brushed nickel cage



FAN: FP6252BN (1)
brushed nickel assembly with
brushed nickel fan blades and
brushed nickel cage



MINI BREEZE™



 **FAN: FP6252BN (1)**
brushed nickel assembly with
brushed nickel blades and
brushed nickel cage

brushed
nickel
brushed
nickel
FP6252BN

 **USB**

USB PLUG



1-SPEED
no reverse



DRY
indoor only

INCLUDED:

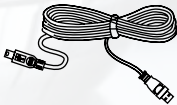

USB power cord

LIMITED LIFETIME MOTOR WARRANTY

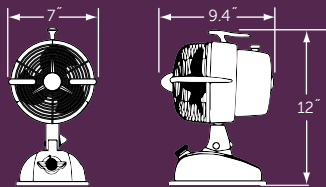

76 x 66 AC Motor

Net Weight: 5.1 lbs.

FAN: FP7958BB (1)
baby blue assembly with chrome accents and black blades



FAN: FP7958MB (1)
mysterious black assembly with chrome accents and black blades



FAN: FP7958MI (1)
milky ivory assembly with chrome accents and black blades



FAN: FP7958SR (1)
spicy red assembly with chrome accents and black blades



FAN: FP7958SS (1)
sonic silver assembly with chrome accents and black blades





URBANJET™



 **FAN: FP7958SS (1)**
sonic silver assembly with
chrome accents and black blades

baby blue FP7958BB	mysterious black FP7958MB	milky ivory FP7958MI	spicy red FP7958SR	sonic silver FP7958SS
-----------------------	------------------------------	-------------------------	-----------------------	--------------------------



3-SPEED
no reverse



POWER CORD
5.5' cord



CONTROL
rotary



DRY
indoor only

LIMITED LIFETIME MOTOR WARRANTY

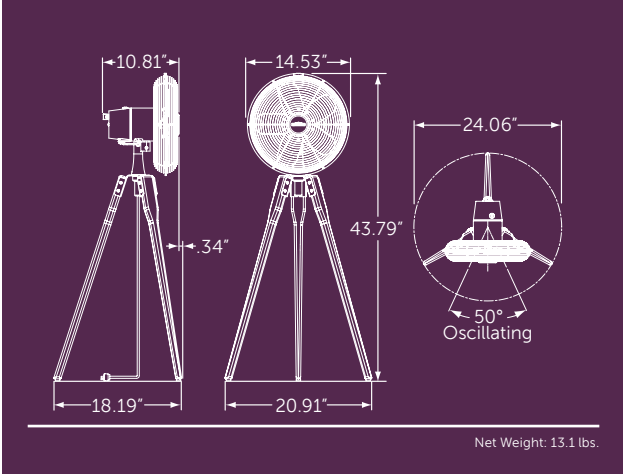

FAN: FP8014OB (1)
oil-rubbed bronze assembly with black blades and walnut legs



FAN: FP8014SN (1)
satin nickel assembly with black blades and walnut legs



ARDEN™



 **FAN: FP8014SN (1)**
satin nickel assembly with
black blades and walnut legs

oil-rubbed bronze	satin nickel
walnut	walnut
FP8014OB	FP8014SN



3-SPEED
no reverse



POWER CORD
8' cord



CONTROL
rotary



DRY
indoor only

LIMITED LIFETIME MOTOR WARRANTY

For dimensions and configurations, please see our comprehensive Specification Book or model-specific specification sheet, available at fanimation.com

FAN: FPH210AC (1)
antique copper with black motor assembly
CEILING MOUNT: FPH81BL1 (1)
black ceiling mount—1" dia. x 6" long downrod included



FAN: FPH210BL (1)
black assembly
BASE: FPH21BL (1)
black floor base
COLUMN: FPH70CP (1)
carved post column



FAN: FPH210RS (1)
rust assembly
WALL MOUNT: FPH61RS (1)
rust wall mount



SOLD SEPARATELY:



See page 141-146 for additional controls

COLUMNS



BL—black

CP—carved post

FPH70**

PEDESTAL MOUNT



FPH21BL
black

WALL MOUNT



FPH61**
black or rust

CEILING MOUNT



use with CW1WH

FPH811**
black or rust



CW1WH
wall control

OLD HAVANA™



 **MOTOR: FPH210RS** (1)
 rust assembly
BASE: FPH21BL (1)
 black pedestal base
COLUMN: FPH70CP (1)
 carved post

antique copper	black	rust
black	black	rust
FPH210AC	FPH210BL	FPH210RS

MIX & MATCH
 components
 sold separately

3-SPEED
 no reverse

POWER CORD
 8' cord

CONTROL
 rotary

DRY OR DAMP
 model specific

LIMITED LIFETIME MOTOR WARRANTY



LIGHT KITS

- Light kits are for use with most Fanimation fans
- Light bulb requirements vary and are listed for each light kit
- Pull-chain light kits come with chain and fob
- Light bulbs included
- **UL LISTED**



- ◊ **LK112A** antique bamboo with white frosted glass
- 6" (H) x 10" (W)
 - One 60W candelabra bulbs included



- ◊ **LK122A** antique bamboo with white frosted glass
- 8" (H) x 13" (W)
 - Three 40W candelabra bulbs included



- ◊ **LK250** white frosted 13" bowl light kit
- 8" (H) x 13" (W)
 - Three 50W halogen minican bulbs included



- ◊ **LK260** amber frosted 13" bowl light kit
- 8" (H) x 13" (W)
 - Three 50W halogen minican bulbs included



- ✦ **LK113WH** white fabric drum lamp shade
- 6.9" (H) x 14" (W)
 - Three 50W halogen minican bulbs included



- ◊ **LK114AOB** oil-rubbed bronze
- low-profile light kit
 - opal frosted glass
 - pull chain operation
 - 4.8" (H) x 14" (W)
 - One 100W halogen minican bulb included



- ✦ **LK124ABA** bronze accent
◊ **LK124ATS** tortoise shell
- low-profile light kit
 - opal frosted glass
 - pull chain operated
 - 4.8" (H) x 12" (W)
 - One 100W halogen minican bulb included



- ◊ **LK124WTS** tortoise shell
- low-profile light kit
 - opal frosted glass
 - pull chain operated
 - 4.8" (H) x 12" (W)
 - One 100W halogen minican bulb included



- ◊ **LKLP101OB** oil-rubbed bronze
◊ **LKLP101SN** satin nickel
- low-profile light kit
 - opal frosted glass
 - pull chain operation
 - 8.5" (H) x 5.2" (W)
 - One 100W halogen minican bulb included



- ◊ **LKLP102OB** oil-rubbed bronze
◊ **LKLP102SN** satin nickel
- low-profile light kit
 - opal frosted glass
 - pull chain operation
 - 8" (H) x 5.2" (W)
 - One 100W halogen minican bulb included



- ◊ **LKLP111AOB** oil-rubbed bronze
- low-profile light kit
 - amber linen glass
 - pull chain operation
 - 8.5" (H) x 5.2" (W)
 - One 100W halogen minican bulb included



- ◊ **LKLP111WWH** oil-rubbed bronze
- low-profile light kit
 - white linen glass
 - pull chain operation
 - 8.5" (H) x 5.2" (W)
 - One 100W halogen minican bulb included



- ◊ **LKLP112AOB** oil-rubbed bronze
- low-profile light kit
 - amber linen glass
 - pull chain operation
 - 8.5" (H) x 5.2" (W)
 - One 100W halogen minican bulb included



- ◊ **LKLP112WSN** satin nickel
- low-profile light kit
 - white linen glass
 - pull chain operation
 - 8.5" (H) x 5.2" (W)
 - One 100W halogen minican bulb included

FITTERS, SHADES & DECORATIVE GLASS

- Bowl fitters are for use with most Fanimation fans
- Fitter glass sold separately below
- Glass bowls—12.75" diameter x 4.75" height (G210 and G400 series) require fitters F423 and FW423
- Small glass and shades (G200 series) for use with myFanimation F4 fitter only—page 71
- Finishes and light bulb requirements vary and are listed for each
- Glass and shades should be ordered based on the fitter model selected
- Light bulbs included

UL LISTED



- ◆ F423AB antique brass
- ◇ F423BA bronze accent
- ◇ F423AZ aged bronze
- ◇ F423MW matte white
- ◇ F423OB oil-rubbed bronze
- ◆ F423PW pewter
- ◇ F423RS rust
- ◇ F423SN satin nickel
- ◇ F423TS tortoise shell
- ◇ F423VZ venetian bronze
- ◇ F423WH white

- ◆ FW423AZ aged bronze
- ◆ FW423OB oil-rubbed bronze
- ◆ FW423RS shown in rust
- ◆ FW423TS tortoise shell
- ◆ FW423WH white

- 6" (H) x 6" (W)
- Three 50W halogen minican bulbs included

- Uses glass bowls only, sold separately (page 127)
- 7 (H) x 13" (W)
- Three 60W candelabra bulbs included



G210
Tropical bowl



G439
Hand-painted parrot



G450
Amber



G451
Powdered amber



G456
White frost

ADDITIONAL myFANIMATION GLASS



G100C
Clear ribbed



G100F
White frosted ribbed



G235
Tropical etched glass



G239
Hand-painted parrot



G244
Aged bronze/amber shade



G250
Amber



G256
White frost

REMOTE CONTROLS

- Control specifications on page 145
- Control options are not available for Bourbon Street®, Palmetto® and Punkah®

UL LISTED

- Included
 - Optional
 - Optional—Install control in a dry location only
- WH—White LA—Light Almond



- | | | | | | | | |
|---|--|--|---|---|--|---|---|
| BTCR9 | BTCR9U | BTR9 | BTR9U | BTT9 | BTT9U | BTT9R | TR205 |
| • Bluetooth® connectivity
• Fan and downlight
• Receiver unit and hand-held transmitter | • Bluetooth® connectivity
• Fan and up/downlight
• Receiver unit and hand-held transmitter | • Bluetooth® connectivity
• Fan and downlight
• Receiver unit only | • Bluetooth® connectivity
• Fan and up/downlight
• Receiver unit only | • fanSync™ hand-held remote
• Non-reversing
• Fan and downlight | • fanSync™ hand-held remote
• Non-reversing
• Fan and up/downlight | • fanSync™ hand-held remote
• Reversing
• Fan and downlight | • Hand-held remote
• Fan and downlight
• Shutoff timer
• Home away
• Fresh air
• Safe exit |

Aire Décor®—BP200/210/215/220/225							
Aire Décor®—BP230							
Aire Deluxe							
Americana®							
Ascension™							
Avaston™							
Beckwith™							
Belleria®							
Benito™							
Brewmaster®							
Camhaven™							
Cancun™ (WET)—FP8012 & FP8016							
Cancun™—FP8042							
Caruso™							
Celano V2™							
Crestford™							
Edgewood®							
Embrace™							
Enigma®							
Extraordinaire®							
Inlet™							
Islander® AC							
Islander® DC							
Jennix™							
Keystone™							
Levon™							
Levon™ Custom							
Levon™ DC							
Louvre®							
Marea™							
myFanimation™ Distinction™—A1/C1							
myFanimation™ Distinction™—D1							
Odyn™							
Old Havana®							
Palisade®							
Spitfire™							
Subtle™							
Torto™							
Torto™ LED							
Ventana™							
Windpointe®							
Xeno™							
Zonix™—FP4620 & FP4630							
Zonix™ (WET)—FP4640							
Zonix™ (LED)—FP4650							

*Must use with SW24 **Must use with SW50** *** Must use with SW70

WALL CONTROLS

- Wall controls include matching face plate
- Control specifications on page 145
- Control options are not available for Bourbon Street®, Palmetto® and Punkah®

• UL LISTED

- Ⓢ Included
 - Ⓢ Optional
 - Ⓢ Optional—Install control in a dry location only
- WH—White LA—Light Almond



CW1WH & CW1LA

- Fan-only slide control

CW1SWWH & CW1SWLA

- Fan slide control with light toggle switch

CW2WH & CW2LA

- Fan and light slide control

CW3WH

- Fan-only slide control
- CW3*-CA for Caruso™

CW5WH & CW5LA

- Two-fan slide control

CW6WH

- Palisade® fan and light slide control

Aire Décor®—BP200/210/215/220/225	Ⓢ	Ⓢ	Ⓢ		Ⓢ	
Aire Décor®—BP230	Ⓢ	Ⓢ	Ⓢ		Ⓢ	
Aire Deluxe						
Americana®	Ⓢ	Ⓢ	Ⓢ		Ⓢ	
Ascension™						
Avaston™						
Beckwith™						
Belleria®	Ⓢ	Ⓢ	Ⓢ		Ⓢ	
Benito™						
Brewmaster®						
Camhaven™						
Cancun™ (WET)—FP8012 & FP8016	Ⓢ	Ⓢ	Ⓢ		Ⓢ	
Cancun™—FP8042	Ⓢ	Ⓢ	Ⓢ		Ⓢ	
Caruso™				Ⓢ		Ⓢ
Celano V2™						
Crestford™	Ⓢ	Ⓢ	Ⓢ		Ⓢ	
Edgewood®	Ⓢ	Ⓢ	Ⓢ		Ⓢ	
Embrace™						
Enigma®						
Extraordinaire®						
Inlet™						
Islander® AC	Ⓢ	Ⓢ	Ⓢ		Ⓢ	
Islander® DC						
Jennix™						
Keystone™						
Levon™	Ⓢ	Ⓢ	Ⓢ		Ⓢ	
Levon™ Custom						
Levon™ DC						
Louvre®						
myFanimation™ Distinction™—A1/C1						
myFanimation™ Distinction™—D1						
Marea™						
Odyn™						
Old Havana®						
Palisade®				Ⓢ		Ⓢ
Spitfire™						
Subtle™						
Torto™						
Torto™ LED						
Ventana™						
Windpointe®	Ⓢ	Ⓢ	Ⓢ		Ⓢ	
Xeno™						
Zonix™—FP4620 & FP4630		Ⓢ	Ⓢ		Ⓢ	
Zonix™ (WET)—FP4640	Ⓢ	Ⓢ	Ⓢ		Ⓢ	
Zonix™ (LED)—FP4650						

*Must use with SW50**



- C21**
- Fan and light control with reversing



- C25**
- Fan and light control
 - Non-reversing



- CWRL4WH & CWRL4LA**
- Fan and light control



- CW60WH**
- Fan and light control
 - Wet rated when used with WP60 (see accessories page)



- CW110WH**
- Fan-only slide control



- TW206**
- DC 31-speed wall control
 - Reverse and downlight



- TW40WH & TW40LA**
- DC 6-speed wall control
 - Reverse and downlight

			ⓘ ⓘ	ⓘ ⓘ		
	ⓘ ⓘ			ⓘ ⓘ		
	ⓘ ⓘ	ⓘ ⓘ				
		ⓘ ⓘ	ⓘ ⓘ	ⓘ ⓘ		
	ⓘ ⓘ	ⓘ ⓘ				
		ⓘ ⓘ	ⓘ ⓘ	ⓘ ⓘ		
	ⓘ ⓘ	ⓘ ⓘ	ⓘ ⓘ ⓘ	ⓘ ⓘ		
		ⓘ ⓘ	ⓘ ⓘ		ⓘ ⓘ	
	ⓘ ⓘ	ⓘ ⓘ	ⓘ ⓘ	ⓘ ⓘ		
		ⓘ ⓘ	ⓘ ⓘ	ⓘ ⓘ		ⓘ ⓘ
			ⓘ ⓘ	ⓘ ⓘ		ⓘ ⓘ
	ⓘ ⓘ					ⓘ ⓘ
		ⓘ ⓘ			ⓘ ⓘ	
						ⓘ ⓘ
	ⓘ ⓘ					ⓘ ⓘ
		ⓘ ⓘ				ⓘ ⓘ
					ⓘ ⓘ	
	ⓘ ⓘ					ⓘ ⓘ
			ⓘ ⓘ	ⓘ ⓘ		
	ⓘ ⓘ			ⓘ ⓘ		
			ⓘ ⓘ	ⓘ ⓘ		
		ⓘ ⓘ	ⓘ ⓘ	ⓘ ⓘ		
			ⓘ ⓘ	ⓘ ⓘ		
		ⓘ ⓘ	ⓘ ⓘ	ⓘ ⓘ		
			ⓘ ⓘ	ⓘ ⓘ		
						ⓘ ⓘ
	ⓘ ⓘ					ⓘ ⓘ
		ⓘ ⓘ				
			ⓘ ⓘ	ⓘ ⓘ		
			ⓘ ⓘ	ⓘ ⓘ		
			ⓘ ⓘ	ⓘ ⓘ		
			ⓘ ⓘ	ⓘ ⓘ		
			ⓘ ⓘ	ⓘ ⓘ		
		ⓘ ⓘ				

CONTROL SPECIFICATIONS



WH—White



LA—Light Almond



CW1WH & CW1LA

- Fan-only slide control
- 2-wire installation
- 3 fan speeds
- 1.25 amps max. fan load



CW1SWWH & CW1SWLA

- Fan slide control with light on/off toggle switch
- 3-wire installation
- 3 fan speeds
- 1.25 amps max. fan load



CW2WH & CW2LA

- Fan and light slide control
- 3-position light levels
- 3-wire installation
- 3 fan speeds
- 1.25 amps max. fan load



CW3WH

- Palisade® and Caruso™ fan-only slide control
- CW3**CA for Caruso™
- 2-wire installation
- 2 fan speeds
- 5 amps max. fan load



CW5WH & CW5LA

- Fan-only two fan slide control
- 2-wire installation
- 3 fan speeds
- 5 amps max. fan load



CW6WH

- Palisade® fan and light control
- 3-position light levels
- 3-wire installation
- 2 fan speeds



C21

- Reversible fan and light control
- 2-wire installation
- 3 fan speeds
- infinite light levels



C23

- Reversible fan and light control
- 2-wire installation
- 3 fan speeds
- infinite light levels for uplight and downlight



C25

- Non-reversing fan and light control
- battery operated
- 3 fan speeds
- infinite light levels



CW40

- Fan-only slide control
- 2-wire installation
- 4 fan speeds
- 1.25 amps max. fan load



CW110WH

- Extraordinaire® fan-only slide control
- 2-wire installation
- 3 fan speeds
- 1.25 amps max. fan load



CW60WH

- Fan and light control
- 3-wire installation
- 3-position light levels
- 3 fan speeds
- 1.25 amps max. fan load
- Wet rated when used with WP60—this page



TR20WH

- Reversible fan and light remote
- mounts over switch plate
- 3 fan speeds
- Downlight control



TR22WH

- Reversible fan and light remote
- mounts over switch plate
- 3 fan speeds
- Uplight and downlight control



TR24WH

- Non-reversing fan and light remote
- mounts over switch plate
- 3 fan speeds
- Downlight control



TR39

- DC reversible fan and light remote
- Learn-mode for easy set up and 65,000 code settings
- 6 fan speeds
- Downlight control



TR41

- DC reversible fan and light remote
- Learn-mode for easy set up and 65,000 code settings
- 6 fan speeds
- Uplight and downlight control



TW40WH & TW40LA

- DC reversible fan and light wall control
- Learn-mode for easy set up and 65,000 code settings
- Includes switch plate
- 6 fan speeds
- Downlight control



TR205

- DC reversible fan and light remote
- mounts over switch plate
- 31 fan speeds
- Downlight control
- 1, 3 and 6 hour timer
- Fresh Air function
- Safe Exit function
- Home Away function



TW206

- DC reversible fan and light control
- mounts over switch plate
- 31 fan speeds
- Downlight control
- 1, 3 and 6 hour timer
- Fresh Air function
- Safe Exit function
- Home Away function



TR33WH

- Marea™ fan remote
- mounts over switch plate
- 3 fan speeds



C4

- Non-reversing fan and light remote
- Learn-mode canopy receiver unit for easy set up and 65,000 code settings included
- 3 fan speeds
- 1.25 amps max. fan load
- Infinite light levels up to 250 watts



CRL4WH

- Non-reversing fan and light remote
- Learn-mode canopy receiver unit for easy set up and 65,000 code settings included
- 3 fan speeds
- 1.25 amps max. fan load
- Infinite light levels up to 190 watts
- Dimmer on/off switch for use with CFL bulbs (dimmer must be turned off)
- May be used with CWRL4**



CWRL4WH & CWRL4LA

- Non-reversing fan and light control
- 2-wire installation
- 3 fan speeds
- 1.0 amps max. fan load
- Learn-mode canopy receiver unit for easy set up and 65,000 code settings included
- Infinite light levels up to 190 watts
- Dimmer on/off switch for use with CFL bulbs (dimmer must be turned off)
- May be used with CRL4WH



CRL8TS

- Non-reversing touch-screen fan and light remote
- Learn-mode canopy receiver unit for easy set up and 65,000 code settings included
- 3 fan speeds
- Fan timer delay feature
- Delay light feature
- 1.0 amps max. fan load
- Infinite light levels up to 190 watts
- Dimmer on/off switch for use with CFL bulbs (dimmer must be turned off)



CH1WH & CH1LA

- Old Havana® fan remote
- mounts over switch plate
- 3 fan speeds



RC110WH

- Extraordinaire® non-reversing fan remote
- mounts over switch plate
- 3 fan speeds



WP60







- Outdoor control box
- Designed for use with CW60 wall control.
- Fits decora style controls
- Includes gasket.
- 5.3" (L) x 3.9" (W) x 4.8" (H)

CONTROL ACCESSORY



CONTROL YOUR CEILING FAN WITH YOUR SMART DEVICES!



 <p>BTCR9</p> <ul style="list-style-type: none"> • fanSync™ Bluetooth® receiver & companion remote control • 3 fan speeds • Downlight control • Timer, safe exit and favorites list via smart device • Wall mount for remote 	 <p>BTCR9U</p> <ul style="list-style-type: none"> • fanSync™ Bluetooth® receiver & companion remote control • 3 fan speeds • Up & downlight control • Timer, safe exit and favorites list via smart device • Wall mount for remote 	 <p>BTT9</p> <ul style="list-style-type: none"> • fanSync™ companion remote control • 3 fan speeds • Downlight control • Wall mount for remote 	 <p>BTT9R</p> <ul style="list-style-type: none"> • fanSync™ companion remote control • 3 fan speeds with reverse • Downlight control • Wall mount for remote 	 <p>BTT9U</p> <ul style="list-style-type: none"> • fanSync™ companion remote control • 3 fan speeds • Up & downlight control • Wall mount for remote 	 <p>BTR9</p> <ul style="list-style-type: none"> • fanSync™ Bluetooth® receiver • Controls fan and light via smart device • 3 fan speeds • Downlight control • Timer, safe exit and favorites list via smart device • Wall mount for remote 	 <p>BTR9U</p> <ul style="list-style-type: none"> • fanSync™ Bluetooth® receiver • Controls fan and light via smart device • 3 fan speeds • Up & downlight control • Timer, safe exit and favorites list via smart device • Wall mount for remote
---	---	--	--	--	--	---

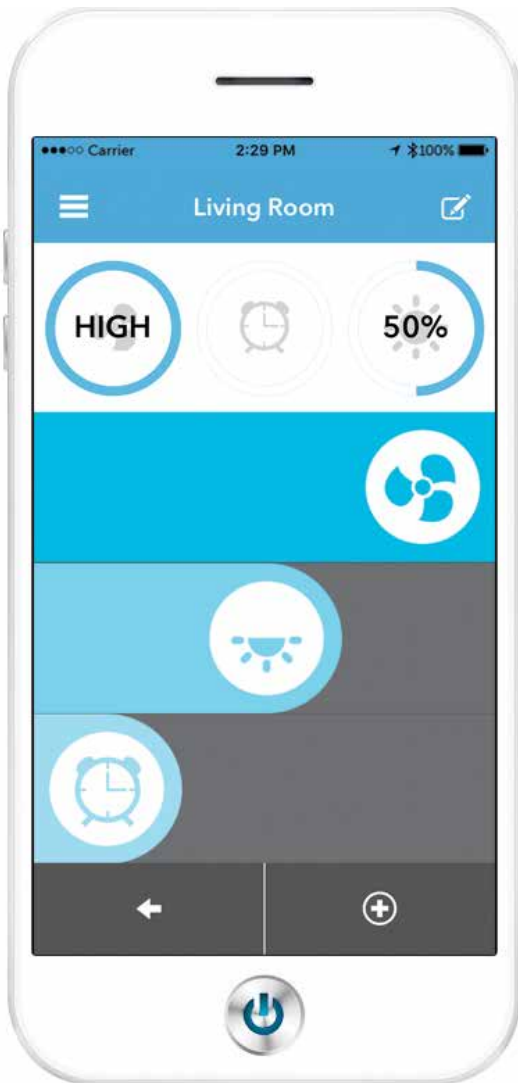

1 Visit www.fanimation.com/fansync to check your fan and device compatibility. fanSync is universal and works with most brands of **3-speed AC ceiling fans**.

2 Easily wire and install the fanSync receiver into your ceiling fan's hanger bracket/canopy.

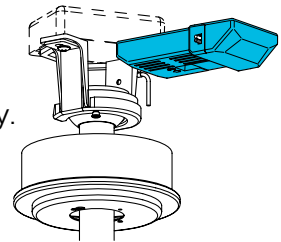





3 Download the fanSync app to your smart device from Google Play or the App Store.

4 Easily find and set up your fan(s) in the fanSync app.



5 Explore and enjoy the many features of the fanSync app!

	Fan Speed		Light Dimming
	Timer		Safe Exit
	Favorites List		

DOWNRODS & ACCESSORIES

DOWNRODS

- Order according to length
- Use finish code to complete the part number
- See page 3 for suggested lengths

STEEL	*DR1-6OB	6" downrod	DR1-36**	36" downrod
	DR1-12**	12" downrod	DR1-48**	48" downrod
	DR1-18**	18" downrod	DR1-60**	60" downrod
	DR1-24**	24" downrod	DR1-72**	72" downrod

STAINLESS STEEL	DR1-12***	12" wet downrod	DR1-48***	48" wet downrod
	DR1-18***	18" wet downrod	DR1-60***	60" wet downrod
	DR1-24***	24" wet downrod	DR1-72***	72" wet downrod
	DR1-36***	36" wet downrod		

antique brass AB	aged bronze AZ	bronze accent BA	black BL	brushed nickel BN
brushed satin brass BS	dark copper penny DCP	driftwood DF	dark bronze DZ	matte greige GR
metro gray MG	matte white MW	oil-rubbed bronze OB	polished nickel PN	pewter PW
rust RS	satin nickel SN	textured black TB	tortoise shell TS	white WH

TRUE STAINLESS STEEL DOWNROD.
Wet location rated. Resistant to rust and corrosion.

black wet BLW	brushed nickel wet BNW	dark bronze wet DZW	matte greige wet GRW	matte white wet MWW
oil-rubbed bronze wet OBW	satin nickel wet SNW	white wet WHW		

DOWNROD COUPLERS



- Joins two downrods together for extended lengths
- When ordering, use finish code for steel downrods shown above to complete the part number.

DR1-CP** 1" diameter downrod coupler

CLOSE-TO-CEILING KIT



- Replaces hanger bracket/downrod assembly to move your fan closer to the ceiling, creating more head room
- Intended for use with low ceilings.
- Please see individual fan pages for compatibility
- Tall dimensions: 5.13" (H) x 8" (DIA.)
- Short dimensions: 2.67" (H) x 8" (DIA.)

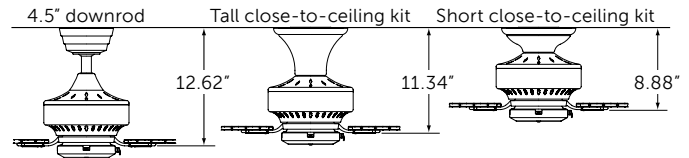

STANDARD

CCK8002AB	antique brass	CCK8002MW	matte white
CCK8002AZ	aged bronze	CCK8002OB	oil-rubbed bronze
CCK8002BA	bronze accent	CCK8002PN	polished nickel
CCK8002BL	black	CCK8002PW	pewter
CCK8002BN	brushed nickel	CCK8002RS	rust
CCK8002CH	chrome	CCK8002SN	satin nickel
CCK8002DCP	dark copper penny	CCK8002TS	tortoise shell
CCK8002DZ	dark bronze	CCK8002WH	white

WET RATED

CCK8002BLW	black wet	CCK8002MWW	matte white wet
CCK8002BNW	brushed nickel wet	CCK8002OBW	oil-rubbed bronze wet
CCK8002DZW	dark bronze wet	CCK8002SNW	satin nickel wet
CCK8002GRW	matte greige wet	CCK8002WHW	white wet

SLOPED CEILING BALL KIT



- Includes black hanger ball only
 - For use with Fanimation fans purchased after June 2004
 - See individual fan pages for compatibility with your fan
 - Hanger ball works with current Fanimation canopy and hanger bracket
 - Allows for ceiling slope up to 42°
 - For use with any length downrod
- SCB1-52 For use with 1" dia. downrods

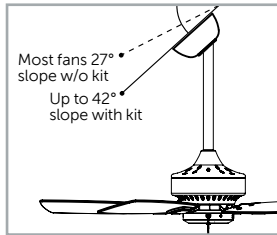

EXTENSION POLES

- For use with Palisade® only
- Order according to length
- Use finish code to complete the part number

EP24**	24" downrod
EP30**	30" downrod
EP36**	36" downrod
EP48**	48" downrod
EP60**	60" downrod
EP72**	72" downrod

EXTENSION POLE COUPLERS



- For use with Palisade® only
- Joins two extension poles together for extended lengths
- Use finish code to complete the part number.

EP24** Extension pole coupler

SLOPED CEILING KIT



- Includes hanger bracket, hanger ball, ceiling canopy, canopy screw cover and mounting hardware
- For use with Aire Décor®, Benito™ and Edgewood® series fans
- Allows for ceiling slope up to 42°
- For use with any length downrod

SCK1-52AZ	aged bronze	SCK1-52PN	polished nickel
SCK1-52BL	black	SCK1-52PW	pewter
SCK1-52BN	brushed nickel	SCK1-52SN	satin nickel
SCK1-52MW	matte white	SCK1-52TS	tortoise shell
SCK1-52OB	oil-rubbed bronze	SCK1-52WH	white

DOWNROD SLEEVE



- Tropical downrod sleeve
- 16" tall
- Requires minimum 24" downrod or extension pole

DRS24TR Downrod sleeve

BULB REFERENCE

- Fans that include a light kit list the light source under the light kit feature icon on the fan page
- Understanding lumens, correlated color temperature and color rendering index values will help you understand what light output to expect from each fan

LUMENS VERSUS WATTS

In years past, consumers used wattage to rate the brightness of a lamp. However, wattage is a measure of energy use and is not an accurate indicator of lamp brightness. Energy efficient light sources such as LEDs and Compact Fluorescent Lamps (CFL) have much lower wattages while still producing a great amount of light. While wattage measures energy use, lumens measure light output—luminous flux. When determining light output, it is best to compare lumens.

WHAT IS CORRELATED COLOR TEMPERATURE?

Color appearance, also known as Correlated Color Temperature (CCT), is a measure of how warm or cool a light source appears to the human eye. It is measured in degrees Kelvin. The majority of light sources have a Kelvin temperature within the range of 2700K to 6500K. For reference, noon-time daylight has a Kelvin temperature of 5000K. Incandescent light sources generally range from 2700-3500K. Compact Fluorescents and LEDs can range from 2700-6500K. The lower the Kelvin temperature, the warmer the light source appears and the higher the Kelvin temperature, the cooler the light source appears.

WARM WHITE	2700K
SOFT WHITE	3000K
NEUTRAL	3500K
COOL	4100K
SOFT DAYLIGHT	5000K
DAYLIGHT	6500K

WHAT IS THE COLOR RENDERING INDEX?

CRI is the ability of a light source to light up objects of different colors and properly display the colors without influence or making the color look adjusted. CRI is represented by a number on a scale from 0 to 100 with 100 being best. The lower the number, the more distorted a color will look under the light source.

EXAMPLES OF BULB BASES AND TYPES

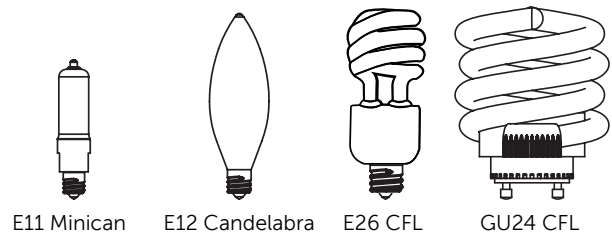

Bulb Base	Bulb Type	Watts	Lumens per Bulb	Correlated Color Temperature (CCT)	Color Rendering Index (CRI)
E11	Minican Halogen Frosted	50	500	2800	100
E11	Minican Halogen Frosted	75	1000	2800	100
E11	Minican Halogen Clear	100	1400	2800	100
E12	Candelabra Incandescent Frosted	40	340	2800	100
E12	Candelabra Incandescent Clear	40	358	2800	100
E12	Candelabra Halogen (B10)	43	750	2800	100
E12	Candelabra Incandescent Frosted	60	510	2800	100
E12	Candelabra Incandescent Clear	60	610	2800	100
E26	Compact Fluorescent (CFL)	13	959	2700	80
E26	Compact Fluorescent (CFL)	23	1600	2700	80
GU24	Compact Fluorescent (CFL)	13	900	2700	80
GU24	Compact Fluorescent (CFL)—Short Neck	18	1144	2700	80
GU24	Compact Fluorescent (CFL)	18	1250	2700	80
GU24	Compact Fluorescent (CFL)	26	1600	2700	80
Connector Pin	10W LED Module	10	659	2800	80
Connector Pin	16W LED Module	16	1352	3000	80
Connector Pin	18W LED Module	18	1300	3000	80

BLADES

- Blades listed come in sets of five (5) except those for Punkah®—one (1), Brewmaster®—two (2), Palisade®—eight (8), Palmetto—three (3) and Caruso™—ten (10).
- Blades should be ordered based on the fan model selected
- Blade sets vary based on catalog number and are specific to fan models
- Some blade catalog numbers require fan finish codes
- Due to the nature of the materials and the hand-crafted processes; stain, color, texture and shading will vary



Americana®	ISP1		ISP4	FP1018	B5280WA	B6080WA	B5340WA	
Belleria®	ISP1		ISP4		B5280WA	B6080WA	B5340WA	
Bourbon Street®	ISP1		ISP4	FP1018	B5280WA	B6080WA	B5340WA	
Brewmaster®	BMP1							
Caruso™			CAISP4					
Islander® (AC & DC)	ISP1		ISP4		B5280WA	B6080WA	B5340WA	
Louvre®	ISP1		ISP4		B5280WA	B6080WA	B5340WA	
Palisade®	PAP1							
Palmetto®		PMP2**						
Punkah®	PUP1							
Windpointe® Custom	ISP1		ISP4		B5280WA	B6080WA	B5340WA	



Americana®	ISD1A			ISD4A	BPD1A	BPD4A	BPD4MW	
Belleria®	ISD1A			ISD4A	BPD1A	BPD4A	BPD4MW	
Bourbon Street®	ISD1A			ISD4A	BPD1A	BPD4A	BPD4MW	
Brewmaster®				BMD4A				
Caruso™			CAISD2A	CAISD4A		CABPD4A		
Islander® (AC & DC)	ISD1A			ISD4A	BPD1A	BPD4A	BPD4MW	
Louvre®	ISD1A			ISD4A	BPD1A	BPD4A	BPD4MW	
Palisade®	PAD1A	PAD1C	PAD2A					
Palmetto®			PMD2A**					
Punkah®	PUD1A	PUD1C						
Windpointe® Custom	ISD1A			ISD4A	BPD1A	BPD4A	BPD4MW	

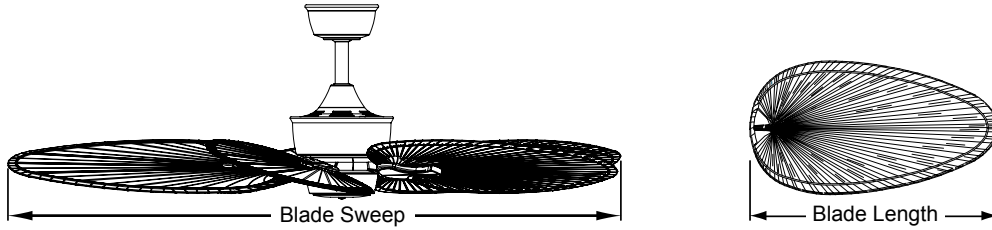

	B5350WA	B5300WA	B5330WA	B6130WA		B5133TKMH	B6133TKMH
	B5350WA	B5300WA	B5330WA	B6130WA		B5133TKMH	B6133TKMH
	B5350WA	B5300WA	B5330WA	B6130WA		B5133TKMH	B6133TKMH
					B5213WA		
	B5350WA	B5300WA	B5330WA	B6130WA		B5133TKMH	B6133TKMH
	B5350WA	B5300WA	B5330WA	B6130WA		B5133TKMH	B6133TKMH
					B5213WA		
	B5350WA	B5300WA	B5330WA	B6130WA		B5133TKMH	B6133TKMH



	BPP1TN	BPP4TN	BPP1BR	BPP4BR	BPW20CY	BPW24MW	BPW6090DNA	BPW6030MH	BPW6030TK
	BPP1TN	BPP4TN	BPP1BR	BPP4BR	BPW20CY	BPW24MW	BPW6090DNA	BPW6030MH	BPW6030TK
	BPP1TN	BPP4TN	BPP1BR	BPP4BR	BPW20CY	BPW24MW	BPW6090DNA	BPW6030MH	BPW6030TK
		CABPP4TN		CABPP4BR					
	BPP1TN	BPP4TN	BPP1BR	BPP4BR	BPW20CY	BPW24MW	BPW6090DNA	BPW6030MH	BPW6030TK
	BPP1TN	BPP4TN	BPP1BR	BPP4BR	BPW20CY	BPW24MW	BPW6090DNA	BPW6030MH	BPW6030TK
	BPP1TN	BPP4TN	BPP1BR	BPP4BR	BPW20CY	BPW24MW	BPW6090DNA	BPW6030MH	BPW6030TK

ANTIQUe FAN MUSEUM

presented by the Antique Fan Collectors Association



PASSION, HERITAGE & PRESERVATION

Led by our Founder and CEO, Tom Frampton, Fanimation is dedicated to preserving the history of fans and the fan industry. For years, Tom has been an avid antique fan collector and member of the Antique Fan Collectors Association (AFCA). The AFCA membership has operated a museum since 1997, displaying fans on loan by the membership; this museum was in Wichita, Kansas up until 2008, when the need to relocate the museum arose. Answering the call to preserve viewing of the one-of-a-kind collection, Fanimation made the offer to house the museum at its facility in Zionsville. The move and set-up took nearly a year and the museum saw its reopening July 23, 2009. Since that time, the museum has grown and continues to grow, housing over a thousand antique fans on two floors. Tom's own unique collection of fans is a part of the museum collection along with over 500 antique advertising style hand fans and other fan memorabilia.





LOCATION

10983 Bennett Parkway
Zionsville, IN 46077



HOURS

Monday thru Friday 10 am - 4 pm
Or call for an appointment, 317-733-4113



MUSEUM HIGHLIGHTS

- The AFCA museum contains more than 1,000 antique ceiling, desk and hand fans with over 140 manufacturers represented
- The oldest electric desk fan in the museum dates from the early 1890's
- The oldest non-electric fans (steam, belt & pulley or water powered) date from the early 1880's.
- It is the only antique fan museum open to the public in the world
- The AFCA has approximately 700 members worldwide
- The museum contains some of the earliest battery-powered fans, water-powered fans, wind-up fans, electric hand-held fans, ceiling fans, wall fans, desk fans, pedestal fans, rail-car fans and fans that don't even look like fans.
- The museum contains hundreds of hand-held fans that feature advertising from manufactures, retailers, politicians and movie stars.



INDEX

FANS	PAGE	FANS	PAGE	LIGHT KITS	PAGE
A1**	65, 66	FP7964**	17, 18	LK4640**	73
BP200**1	95, 96	FP8003**	29, 30	LK6721**	85, 86
BP210**1	95, 96	FP8012**	101, 102	LK7912**	83, 84
BP215OB1	95, 96	FP8014**	135, 136	LKLP101**	139
BP220**1	95, 96	FP8016OB	101, 102	LKLP102**	109, 139
BP225OB1	95, 96	FP8026**	19, 20	LKLP111AOB	139
BP230**1	95, 96	FP8032DZ	35, 36	LKLP111WWH	139
C1**	65, 66	FP8042**	39, 40	LKLP112AOB	139
D1**	67, 72	FP8062**	23, 24	LKLP112WSN	139
FP10**	127, 128	FP8095**	31, 32		
FP1280**	127, 128	FDP6236**	77, 78	FITTERS	PAGE
FP20**	127, 128	FDP7916**	81, 82	F1**	67, 71
FP2120MG	59, 60	FDP7943**	93, 94	F2**	65, 66, 67, 71, 72
FP240**	121, 122	FDP8088**	33, 34	F3**	65, 71
FP320**1	113, 114	FDP8089**	33, 34	F4**	65, 67, 71
FP410**	119, 120	FDP8149***	79, 80	F423**	115, 140
FP420**	119, 120	FPH210**	137, 138	FW423**	140
FP4320**1	111, 112	FPH21BL	137, 138	GLASS & SHADES	PAGE
FP4620**	21, 22	FPH61**	137	G1**	65, 67, 71
FP4630SN	21, 22	FPH70**	137, 138	G100*	140
FP4640**	73, 74	FPH81**1	137	G2**	66, 67, 71
FP4650**	75, 76	FPS7880**	16, 17	G210	140
FP510**	53, 54	FPS7955**	13, 14	G235	140
FP520**	53, 54	FPS7981**	11, 12	G239	140
FP540**	53, 54	HA7966**	51, 52	G244	140
FP580**	53, 54	MA6721**	85, 86	G250	140
FP601**	53, 54	MA7500**	109, 110	G256	140
FP602**	53, 54	MA7966**	51, 52	G3**	65, 71, 72
FP603**	53, 54	MAD3250**	115, 116	G4**	67, 71
FP604**	53, 54	MAD3252**	117, 118	G439	115, 140
FP605**	53, 54	MAD3255**	37, 38	G450	115, 140
FP6210**	91, 92	MAD7912**	83, 84	G451	140
FP6244**	41, 42	OF110**	57, 58	G456	140
FP6245**	41, 42	PL8274**	27, 28	G5**	65, 71
FP6252BN	131, 132	TF610**	45, 46	G6**	71
FP6284**	43, 44	TF710**	47, 48		
FP6285**	43, 44	TF721**	49, 50	BLADES	PAGE
FP6717**	61, 62	TF910**	97, 98	B154**	67, 70
FP6728**	63, 64	TF971**	99, 100	B160**	70
FP7000OB	123, 124	LIGHT KITS	PAGE	B172**	65, 70, 72
FP720**	125, 126	LK112A	139	B254**	65, 70
FP7500**	107, 108	LK113WH	139	B260**	67, 70
FP780**	125, 126	LK114AOB	139	B272**	70
FP7900**	87, 88	LK122A	139	B354**	70
FP7902BN	89, 90	LK124A**	139	B360**	67, 70
FP7910**	25, 26	LK124WTS	139	B372**	70
FP7954OB	105, 106	LK250	139	B4400SN	21, 75
FP7958**	133, 134	LK260	139	B4442SN	21, 75
FP7963RS	103, 104				